

Installation Instructions

Self Cleaning Free-Standing Electric Range

EER2000, EER3000 JBP24, JBP26, JBP30, JBP35, JBP48, JBP64, JBP65, JBP66, JBP67, JBP70, JBP78, JBP79, JBP85, JB940, JB960, JB965

“If you have questions, Call 800-GE-CARES or visit our website at: www.GEAppliances.com”

Skill Level: High **Average** Low

Completion Time: 1 to 3 Hours

Proper installation is the responsibility of the installer. Product failure due to improper installation is not covered under the GE Appliance Warranty. See the Owners Manual for warranty information.

CAUTION: Before you begin
Read these instructions carefully and completely.

- **IMPORTANT-** Save these instructions for local inspector's use.
- **IMPORTANT-** Observe all governing codes and ordinances.

- **NOTE TO INSTALLER-** Be sure to leave these instructions with the consumer.
- **OWNER-** Keep these instructions for future reference.
- **WARNING-** This appliance must be properly grounded.

Parts Included

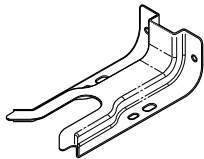

Anti-Tip Bracket and leg leveler

Materials Needed



Lag Bolts



Anchor Sleeves

(For Concrete Floors Only)



(UL Approved 40 AMP)

4- Wire Cord **OR** 3 -Wire Cord
4'long 4'long

Tools You Will Need

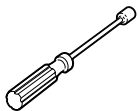

1/4"Nut driver



Adjustable wrench



Drill with 1/8" Bit



Pencil



Safety Glasses

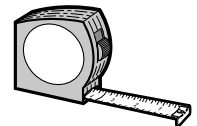

Tape Measure



Level



Phillips Screwdriver

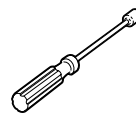

5/16" Hex Head Nut driver

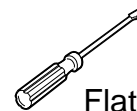

Flat-Bladed Screwdriver

Installation Instructions

IMPORTANT SAFETY INSTRUCTIONS

For Your Safety



WARNING: For personal safety remove house fuse or open circuit breaker before beginning installation. Failure to do so could result in serious injury or even death.

All rough-in and spacing dimensions must be met for safe use of your range. Electricity to the range can be disconnected at the outlet without moving the range if the outlet is in the preferred location (remove lower drawer).

To reduce the risk of burns or fire when reaching over hot surface elements, cabinet storage space above the cooktop should be avoided. If cabinet storage space is to be provided above the cooktop, the risk can be reduced by installing a range hood that sticks out at least 5" beyond the front of the cabinets. Cabinets installed above a cooktop must be no deeper than 13".

Be sure your appliance is properly installed and grounded by a qualified technician.

Make sure the cabinets and wall coverings around the range can withstand the temperatures (up to 200°F.) generated by the range.



WARNING: To reduce the risk of tipping, the appliance must be secured by properly installed anti-tip bracket packed with the appliance.



WARNING

- All ranges can tip
- Injury to persons could result
- Install anti-tip bracket packed with range
- See Installation Instructions

If you pull the range out and away from the wall for any reason, make sure the Anti-Tip bracket is engaged when the range is pushed back against the wall.

Installation Instructions



Pre- Installation Checklist



Preparing the Range



Remove packaging materials. Any packaging materials must be removed during installation. This will include adhesive tape, wire ties, cardboard and protective plastic. Failure to remove these materials could result in damage to the appliance once the appliance has been turned on and surfaces have heated.



Open oven door and remove literature pack, broiler pan and grid, and oven racks.

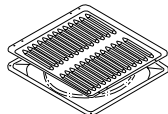

Broiler Pan and Grid

Oven Racks



Literature Pack



Remove Installation Instructions from literature pack and read it carefully before you begin. Be sure to place all literature, Use and Care, Installation Instruction, etc. in a safe place for future reference.

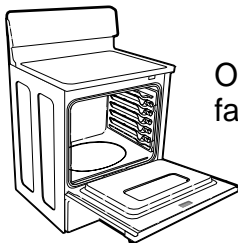

Open the oven door as far as it will go.



Push the hinge locks down toward the door frame, to the unlocked position. This may require a flat blade screwdriver.

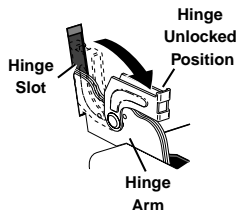

Close the oven door to the broil stop position.



Place hands on both sides of the door. As you close the door, lift up and away from the range.

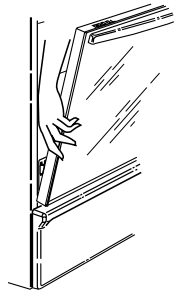

Lift door up until the hinges clear the slots.

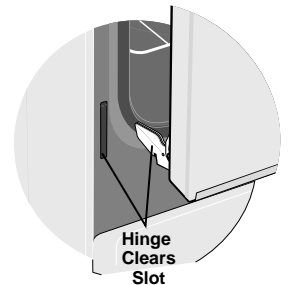

DO NOT LIFT THE DOOR BY THE HANDLE!

NOTE: The oven door is very heavy. Be sure you have a firm grip before lifting the oven door off the hinges. Use caution once the door is removed. Do not lay the door on its handle. This could cause dents or scratches.

Installation Instructions

A Installation Required Clearances

See **Illustrations below** for all rough-in and spacing dimensions.

The range may be placed with 0" clearance (flush) at the back wall and side walls of the cabinet.

MINIMUM DIMENSIONS BETWEEN COOKTOP, WALLS, AND ABOVE THE COOKTOP.

- * Make sure the wall covering, countertop and cabinets around the range can withstand the heat (up to 200°F.) generated by the range.
- ** Allow 30" Minimum clearance between surface units and bottom of unprotected wood or metal cabinet, and 15" Minimum between countertop and adjacent cabinet bottom.
- *** Recommended spacing to heat sensitive surfaces.

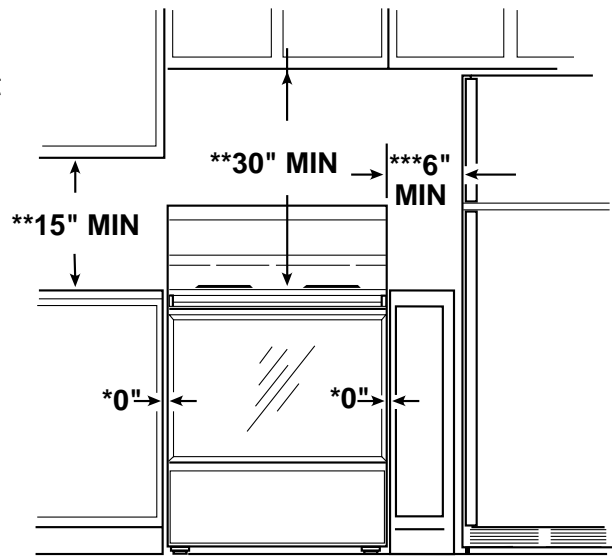

Acceptable electrical outlet area.
Orient the electrical receptacle so the length is parallel to the floor.

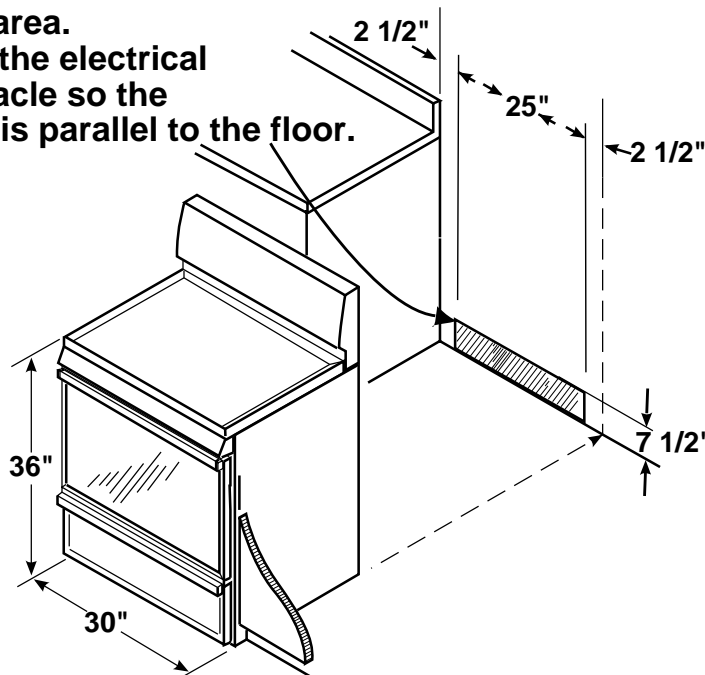

NOTE: Use a 4 foot power cord to prevent interference with the storage drawer. Power cords 4.5 or 6 foot long may have to be dressed to allow for proper drawer closing.

Installation Instructions

B Electrical Connections

Electrical Requirements

This appliance must be supplied with the proper voltage and frequency, and connected to an individual properly grounded branch circuit; protected by a circuit breaker or fuse having amperage as specified on the rating plate. The rating plate is located above the storage drawer on the oven frame.

We recommend you have the electrical wiring and hookup of your range connected by a qualified electrician. After installation, have the electrician show you where your main range disconnect is located.

Check with your local utilities for electrical codes which apply in your area. Failure to wire your oven according to governing codes could result in a hazardous condition. If there are no local codes, your range must be wired and fused to meet the requirements of the National Electrical Code, ANSI/NFPA No. 70-Latest Edition. You can get a copy by writing:

National Fire Protection Association
Battery March Park
Quincy, MA 02269

Effective January 1, 1996, the National Electrical Code requires that new, but not existing, construction utilize a 4 conductor connection to an electric range. When installing an electric range in new construction, follow the instructions in the section on **NEW CONSTRUCTION AND FOUR CONDUCTOR BRANCH CIRCUIT CONNECTION**.

You must use a three-wire, single-phase A.C. 208Y/120 Volt or 240/120 Volt, 60 hertz electrical system. If you connect to aluminum wiring, properly installed connectors approved for use with aluminum wiring must be used.

B1 Making the Electrical Connection

Remove the wire cover (on the back of the range) by removing 5 screws using a 1/4" nut driver. **Do not discard these screws.**

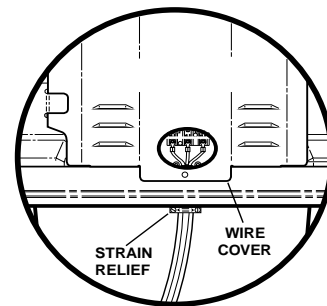

5 Screws to remove wire cover

When reinstalling the one-piece wire cover, make sure that wires do not become pinched between wire cover and mainback.

B2 All new constructions, mobile homes and installations where local codes do not allow grounding through neutral.

These will require a four-wire flexible cord kit. If the range is rated between 8,750 and 16,500 watts, the cord kit must be rated for 40 amps-125/250 volts. If the range is rated between 16,501 and 22,500 watts, the cord kit must be rated for 50 amps-125/250 volts. For existing construction, a three wire flexible cord kit may be used, and the same ratings apply as described above.

- When using a cord kit rated 40 Amps, remove the knockout in the connection plate. You must use a clamp or strain relief to hold the cord.
- Terminations must be either closed loop terminals or open end spade lugs.
- On some models, a filter capacitor may be connected between the black and white leads on the junction block.

Installation Instructions

B Electrical Connections cont.

NEW CONSTRUCTION AND FOUR WIRE CORD CONNECTION KIT

- B3** Complete 4 wire cord kit. Below are step by step instructions on how to install the kit.

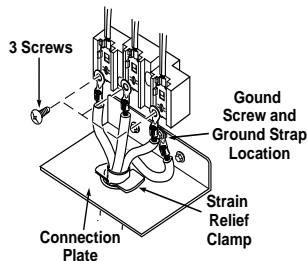

- B4** Remove the screws on the terminal block with a 1/4" nut driver or phillips screwdriver.

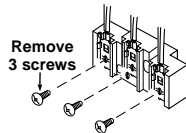

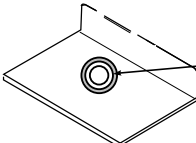
- B5**  Knockout in center of connection plate may be taken out

- B6** Remove the ground screw using a 5/16" nut driver, then remove and discard the ground strap. **Do not discard the ground screw, you will need it later.**

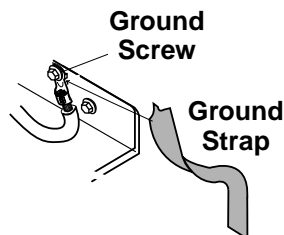

- B7** Install the four-wire cord and strain relief through the hole in the connection plate.

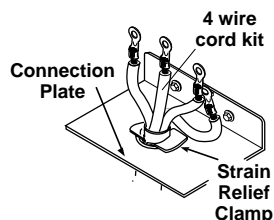

- B8** Attach the green lead below the junction block with the ground screw that was removed earlier.

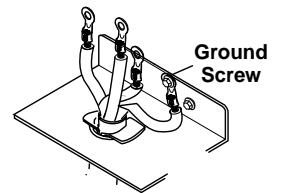

- B9** Connect the red and black leads to the outside terminals and the white lead to the center terminal.

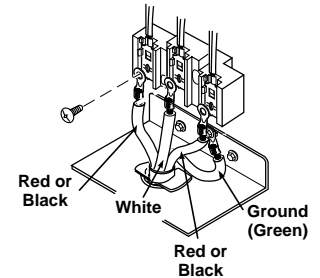

- B10** Push the cord upward (to relieve strain), while tightening the strain relief clamp.

- B11** Re-install the wire cover with the 5 screws removed earlier. Make sure the wires do not become pinched between the wire cover and mainback.

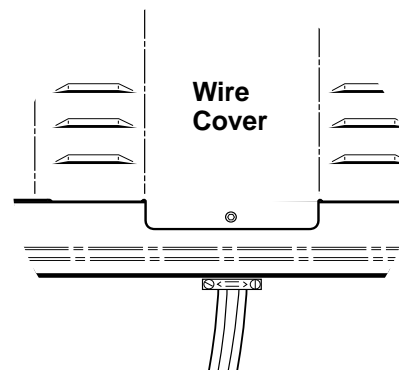

Installation Instructions

B Electrical Connections cont.

THREE- WIRE CORD CONNECTION KIT

B3a Complete 3 wire cord kit. Below are step by step instructions on how to install the kit.

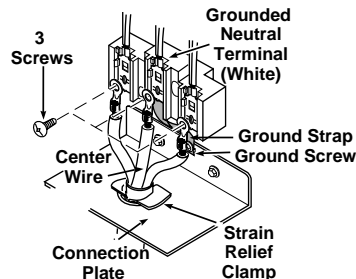

B4a Remove the screws on the terminal block with a 1/4" nut driver or phillips screwdriver.

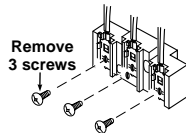

B5a

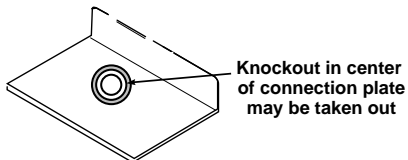

B6a Install the three-wire cord and strain relief through the hole in the connection plate.

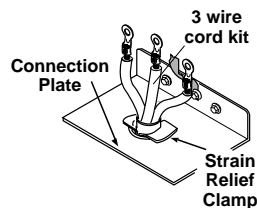

B7a Connect the outer wires to the outside terminals and the center wire to the center terminal. **Do not remove the ground strap**

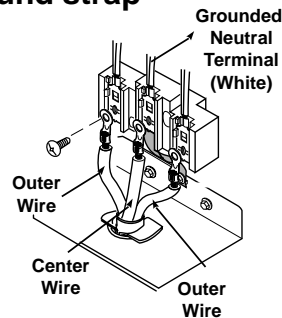

B8a Push the cord upward (to relieve strain), while tightening the strain relief clamp.

B9a Re-install the wire cover with the 5 screws removed earlier. Make sure the wires do not become pinched between the wire cover and mainback.

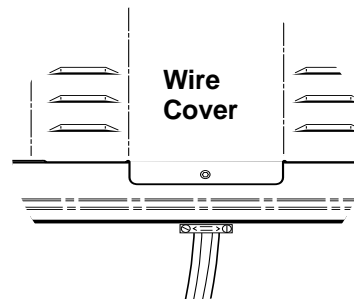

Special note: If local codes require an ungrounded neutral, you must do the following:

- Remove ground strap.
- Fasten the white wire to the center terminal.
- Use grounding terminal or lead to ground unit in accordance with local codes.

Installation Instructions

C Installing the Anti-Tip Bracket

C1 Locating The Bracket

The anti-tip bracket, provided with your literature and broiler pan, must be properly installed to prevent the range from tipping. Please refer to the instructions provided with your anti-tip bracket.

- Decide whether the bracket will be installed on the right or left side of range location.
- If the bracket side of the range has an adjacent cabinet, place the bracket against the back wall and cabinet as shown in Fig. 1. If there is a countertop overhang, offset the bracket by the amount of overhang. If there is no adjacent cabinet, place the bracket to the outside edge of the range side panel and back wall.

Adjacent Cabinet
Or Final Location
Of Range Side Panel

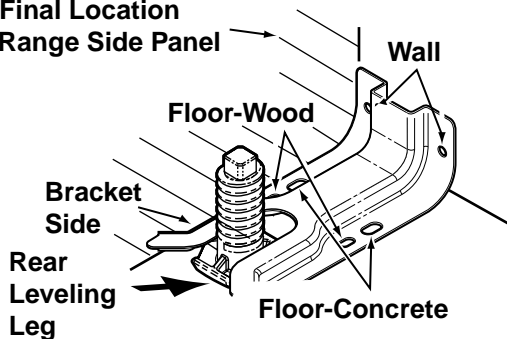

Fig. 1

C2 Installing The Bracket in Wood or Concrete

INSTALLATION-WOOD CONSTRUCTION

- Locate the centers of the four holes identified in Fig. 1 as Floor-Wood and Wall.
- Drill a 1/8" pilot hole through the pre-marked areas. Note the angle of the wall screw in Fig. 2.
- Mount the Anti-Tip bracket with the four screws provided.

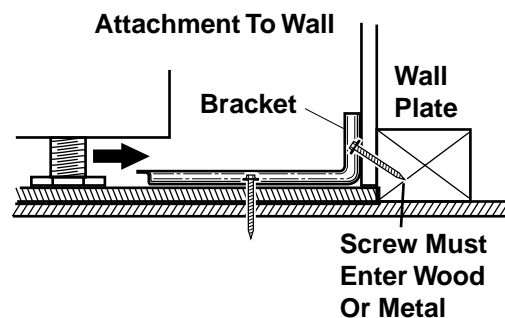

Fig. 2

INSTALLATION-CONCRETE CONSTRUCTION

- For concrete installation you will need two 1/4"x 1-1/2" lag screws, and two sleeve anchors.
- Locate the center of the four holes identified in Fig. 1 as Floor-Concrete and Wall. Drill the recommended size holes in each.
- Install the sleeve anchors into the predrilled concrete holes and install the lag and wall screws through the Anti-Tip bracket. Make sure the screws are securely tightened.

Installation Instructions

D Installing the Range

Storage Drawer Removal

D1 Pull the drawer out until it stops

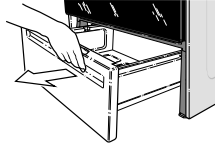

D2 Lift the front of the drawer until the stops clear the guide.

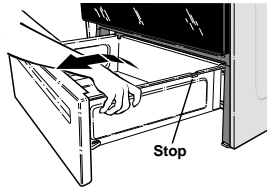

D3 Remove the drawer.

Final Check of the Anti-Tip Bracket

D4 When installation is complete and the range is in place, inspect to be sure the rear leveling leg is fully inserted into the slot of the Anti-Tip Bracket.

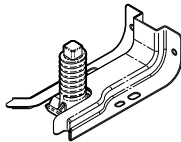

Level the Range

The range must be level for proper cooking and baking.

D5 Install the oven racks. (See Owner's Manual for instructions.)

D6 Put a spirit level or a glass measuring cup partially filled with water on one of the oven racks.

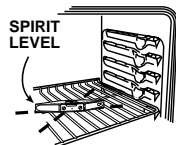

D7 Remove the storage drawer. The front leveling legs can be accessed from the bottom and the rear legs from the top.

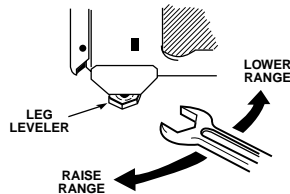

D8 Use an adjustable wrench to adjust all four leg levelers until the range is level.

CAUTION: The oven door is heavy. You may need help lifting the door high enough to slide it into the hinges slots. Do not lift the door by the handle.

Replacing the Oven Door

D9 Pick the Oven Door up by placing both hands on each side. The door is heavy so you may need help. Do not lift the door by the handle.



D10 Place the notch of the hinge arm into the bottom edge of the hinge slot.

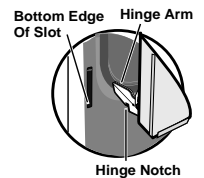

D11 Open the oven door as far as it will open.

Hinge in Locked Position

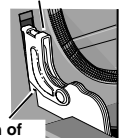

D12 Push the hinge locks up against the front frame of the oven cavity, to the locked position.

D13 Close the oven door.

Installation Instructions

D Installing the Range cont.

Replacing the Storage Drawer

D13 Place the drawer rail on the guides.

D14 Push the drawer in until it stops.

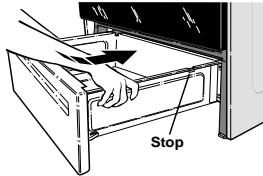

D15 Lift the front of the drawer and push in until the stops clear the guides.

D16 Lower the front of the drawer and push in until it closes.

SPECIAL INSTRUCTIONS IF YOU HAVE PROBLEMS WHILE REPLACING THE STORAGE DRAWER

IF DRAWER WON'T CLOSE

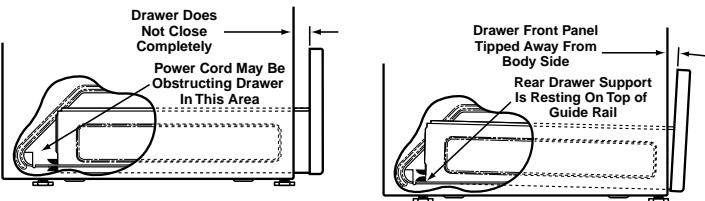

Remove and replace, making sure the power cord is not obstructing the drawer and/or the rail is in the guide.

IF DRAWER IS CROOKED

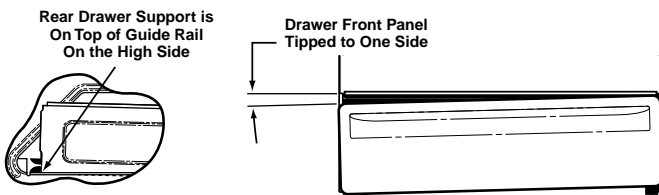

Remove and replace making sure the rail is in the guide.

Installation Instructions

E Final Check List

- Check to make sure the circuit breaker is closed (Reset) or the circuit fuses are replaced.
- Be sure power is in service to the building.
- Check to be sure that all packing materials and tape on metal panel (if applicable) under control knobs have been removed.

F Operation Check List

- Check to make sure the Clock display is energized. If a series of horizontal red lines appear in the display, disconnect power immediately. Recheck the range wiring connections. If change is made to connections, retest again. If no change is required, have building wiring checked for proper connections and voltage. It is recommended that the clock be changed if the red lines appear.
- Push in and turn any one of the four surface knobs to "MED" setting to observe that the element glows within 60 seconds. Turn the knob off when glow is detected. If the glow is not detected within the time limit, recheck the range wiring connections. If change is required, retest again. If no change is required, have building wiring checked for proper connections and voltage.

NOTES

Free Manuals Download Website

<http://myh66.com>

<http://usermanuals.us>

<http://www.somanuals.com>

<http://www.4manuals.cc>

<http://www.manual-lib.com>

<http://www.404manual.com>

<http://www.luxmanual.com>

<http://aubethermostatmanual.com>

Golf course search by state

<http://golfingnear.com>

Email search by domain

<http://emailbydomain.com>

Auto manuals search

<http://auto.somanuals.com>

TV manuals search

<http://tv.somanuals.com>