

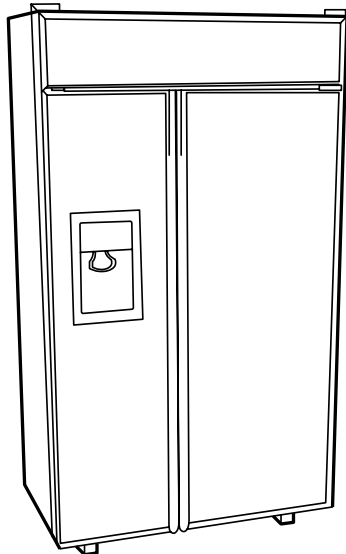

TECHNICAL SERVICE GUIDE

Monogram Side-By-Side Refrigerators With Electronic Controls



MODEL SERIES:

ZIS360NM
ZIS420NM
ZIS480NM
ZIS_360DM
ZIS_420DM
ZIS_480DM





IMPORTANT SAFETY NOTICE

The information in this service guide is intended for use by individuals possessing adequate backgrounds of electrical, electronic, and mechanical experience. Any attempt to repair a major appliance may result in personal injury and property damage. The manufacturer or seller cannot be responsible for the interpretation of this information, nor can it assume any liability in connection with its use.

WARNING

To avoid personal injury, disconnect power before servicing this product. If electrical power is required for diagnosis or test purposes, disconnect the power immediately after performing the necessary checks.

RECONNECT ALL GROUNDING DEVICES

If grounding wires, screws, straps, clips, nuts, or washers used to complete a path to ground are removed for service, they must be returned to their original position and properly fastened.

GE Consumer Home Services Training
Technical Service Guide
Copyright © 2002

All rights reserved. This service guide may not be reproduced in whole or in part in any form without written permission from the General Electric Company.

Table of Contents

| | |
|--|----|
| Technical Data | 3 |
| Model Nomenclature | 4 |
| Rating Plate | 4 |
| Mini-Manual | 4 |
| Serial Number | 5 |
| Component Locator Views | 6 |
| Cabinet | 9 |
| Machine Compartment | 9 |
| Door Closure Mechanism | 10 |
| Doors and Hinges | 10 |
| Door Gaskets | 11 |
| Rollers and Leveling | 11 |
| Ice and Water Dispenser | 12 |
| Controls | 12 |
| Water Valve and Water Tank | 13 |
| Airflow | 14 |
| Damper | 14 |
| Evaporator Fan | 15 |
| Condenser Fan | 19 |
| Defrost System | 20 |
| Adaptive Defrost | 20 |
| Normal Operating Characteristics | 21 |
| Abnormal Operating Characteristics | 21 |
| Liner Protection Mode | 21 |
| Defrost Heater | 22 |
| Evaporator Thermistor | 23 |
| Defrost Overtemperature Thermodisk | 23 |
| Control System | 24 |
| Touch Panel and Temperature Control Board | 24 |
| Main Control Board | 25 |
| Main Control Board Locator Tables | 26 |
| Thermistors | 31 |
| Climate Control Drawer | 32 |
| Strip Circuit | 32 |
| Component Locator View | 33 |
| Operation | 34 |
| Temperature Table | 35 |
| Climate Control Drawer Top Panel (Mullion) | 36 |
| Control Board and Display | 36 |
| Fan and Fan Housing | 38 |
| Dampers | 39 |
| Heater | 40 |
| Thermistor | 40 |
| Airflow | 42 |

Table of Contents (cont.)

| | |
|--|----|
| Compartment Lights | 44 |
| FF/FZ Compartment Lights Diagnostic | 44 |
| Door Switches | 45 |
| Master Light Switch (Sabbath Switch) | 45 |
| Temperature Overload Device (TOD) | 45 |
| Circuit Breakers | 46 |
| Transformers | 46 |
| Light Bulb Replacement | 46 |
| Schematic | 49 |
| Refrigeration System | 50 |
| Compressor | 50 |
| Condenser | 50 |
| Condenser Loop | 50 |
| Dryer | 51 |
| Evaporator | 51 |
| Refrigerant Charge | 51 |
| Diagnostic Mode | 52 |
| Diagnostic Flowcharts | 53 |
| Fresh Food Warm - Freezer Normal | 53 |
| Fresh Food Too Cold - Freezer Normal | 54 |
| Fresh Food Warm - Freezer Warm | 55 |
| Freezer Warm - Fresh Food Normal | 56 |
| Compressor Not Running | 57 |
| Refrigerator Dead - No Sound, No Cooling | 58 |
| Damper Door Does Not Operate | 59 |
| Heavy Frost on Evaporator | 60 |
| Evaporator Fan Not Running | 61 |
| Condenser Fan Not Running | 62 |
| Warranty | 63 |

Technical Data

WARNING: Disconnect power cord before servicing.

Note: Reconnect all grounding devices.

All parts of this appliance capable of conducting electrical current are grounded. If grounding wires, screws, straps, clips, nuts, or washers used to complete a path to ground are removed for service, they must be returned to their original positions and properly fastened.

Caution: To avoid personal injury when servicing the condensing unit, stand on a ladder which will give enough support to allow removal of the top panel and safely allow access to service the unit.

ELECTRICAL SPECIFICATIONS

| | | |
|----------------------------------|----------------------|--|
| Max Defrost Control | | |
| W/No Door Openings |60 hrs @ 35 min | |
| Evap Overtemperature Thermodisc |60 °F-45 °F | |
| Light Thermostat |140 °F-90 °F | |
| Electrical Rating: 115 VAC 60 Hz |9.0 amp | |
| Maximum Current Leakage |0.50 mA | |
| Maximum Ground Path Resistance |0.14 ohms | |
| Energy Consumption (HUMID) |* | |

NO LOAD PERFORMANCE

| | | |
|------------------------------|--------|--------|
| CONTROL POSITION 37-0 °F and | | |
| AMBIENT TEMPERATURE OF | 70 °F | 90 °F |
| Fresh Food, °F | 36-46 | 37-48 |
| Frozen Food, °F | (-6)-6 | (-4)-3 |
| Percent Running Time | 41-46 | 53-55 |

REFRIGERATION DIAGNOSIS

To access the low-pressure side of the system, install a WR86X0097 valve only on the process tube extending from the compressor case.

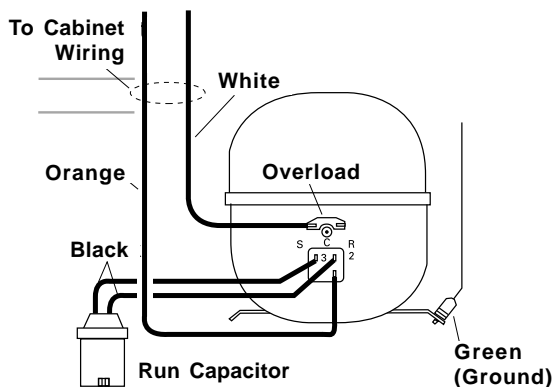

*For Models ZIS 36 & ZIS 36D: 51.2 kWh/mo. Models ZIS 42 & ZIS 42D: 54.6 kWh/mo. Model ZIS 48: 58.1 kWh/mo. Model ZIS 48D: 59.2 kWh/mo.

**For model ZIS 36: WR55X10166. Model ZIS 36D: WR55X10165. Model ZIS 42: WR55X10164. Model ZIS 42D: WR55X10163. Model ZIS 48: WR55X10162. Model ZIS 48D: WR55X10158.

Important Safety Notice:

This information is intended for use by individuals possessing adequate backgrounds of electrical, electronic, and mechanical experience. Any attempt to repair a major appliance may result in personal injury and property damage. The manufacturer or seller cannot be responsible for the interpretation of this information, nor can it assume any liability in connection with its use.

REFRIGERATION SYSTEM

| | |
|-----------------------------|-----------------|
| Compressor |983 Btu/hr |
| Minimum Compressor Capacity | |
| Vacuum |26 inches |
| Minimum Equalized Pressure | |
| @ 70 °F |72 PSIG |
| @ 90 °F |88 PSIG |
| Refrigerant Charge (R134a) |14.50 oz |

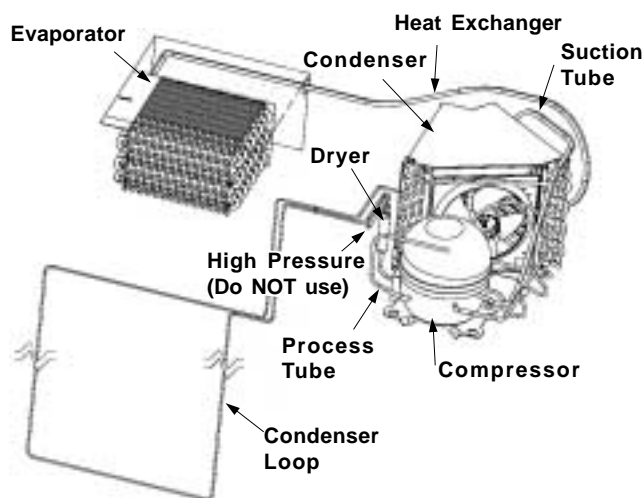

REPLACEMENT PARTS

| | |
|---------------------------------------|-----------------|
| HMI Temperature Control |** |
| Relay |WR07X10031 |
| Overload |WR08X10015 |
| Run Capacitor (15 uF) |WR62X0080 |
| Overtemperature Thermodisc Light |WR50X10035 |
| Overtemperature Thermodisc Evaporator | ..WR50X10036 |
| Defrost Heater |WR51X10065 |
| Drain Trough ASM |WR17X11194 |
| Condenser Fan Motor |WR60X10083 |
| Condenser Fan Blade |WR60X10049 |
| Evaporator Fan Motor |WR60X10043 |
| Evaporator Fan Blade |WR60X10050 |
| Main Board |WR55X10167 |
| Thermistors (2-FF, 1-FZ, 1-EV) |WR55X10025 |
| Damper Assembly Fresh Food |WR60X10085 |
| Evaporator |WR84X10038 |
| Compressor |WR87X10042 |
| Condenser |WR84X10037 |
| Filter Dryer |WR86X0096 |

Model Nomenclature

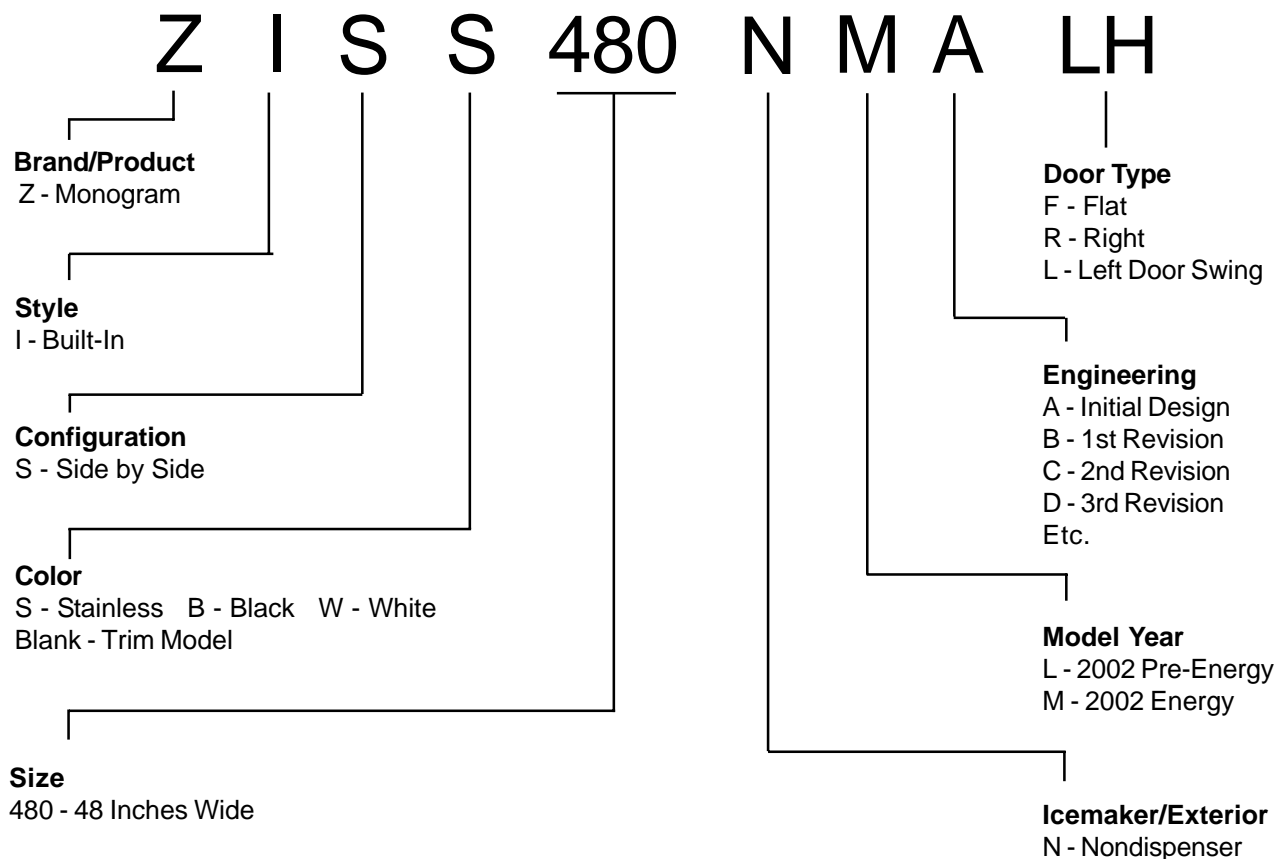

Mini-Manual and Rating Plate

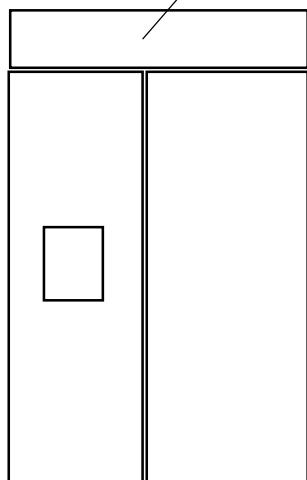

Rating Plate

The rating plate, located behind the grille panel at the top of the refrigerator on the right side of the evaporator box, contains the model and serial numbers. Additionally, the rating plate specifies the minimum installation clearances, electrical voltage, frequency, maximum amperage rating, refrigerant charge, and type.

Mini-Manual

The mini-manual is located behind the grille panel at the top of the refrigerator. When done, return the mini-manual to its original location for future use.

Serial Number

The serial number consists of two letters, followed by six numerals. The two prefix letters of the serial number indicate the month and year the product was manufactured. The year of manufacture does not correspond with the model year of the model number.

| | JAN | FEB | MAR | APR | MAY | JUN | JUL | AUG | SEP | OCT | NOV | DEC |
|------|-----|-----|-----|-----|-----|-----|-----|-----|-----|-----|-----|-----|
| 2000 | AZ | DZ | FZ | GZ | HZ | LZ | MZ | RZ | SZ | TZ | VZ | ZZ |
| 2001 | AA | DA | FA | GA | HA | LA | MA | RA | SA | TA | VA | ZA |
| 2002 | AD | DD | FD | GD | HD | LD | MD | RD | SD | TD | VD | ZD |
| 2003 | AF | DF | FF | GF | HF | LF | MF | RF | SF | TF | VF | ZF |
| 2004 | AG | DG | FG | GG | HG | LG | MG | RG | SG | TG | VG | ZG |
| 2005 | AH | DH | FH | GH | HH | LH | MH | RH | SH | TH | VH | ZH |
| 2006 | AL | DL | FL | GL | HL | LL | ML | RL | SL | TL | VL | ZL |
| 2007 | AM | DM | FM | GM | HM | LM | MM | RM | SM | TM | VM | ZM |
| 2008 | AR | DR | FR | GR | HR | LR | MR | RR | SR | TR | VR | ZR |
| 2009 | AS | DS | FS | GS | HS | LS | MS | RS | SS | TS | VS | ZS |
| 2010 | AT | DT | FT | GT | HT | LT | MT | RT | ST | TT | VT | ZT |
| 2011 | AV | DV | FV | GV | HV | LV | MV | RV | SV | TV | VV | ZV |
| 2012 | AZ | DZ | FZ | GZ | HZ | LZ | MZ | RZ | SZ | TZ | VZ | ZZ |
| 2013 | AA | DA | FA | GA | HA | LA | MA | RA | SA | TA | VA | ZA |
| 2014 | AD | DD | FD | GD | HD | LD | MD | RD | SD | TD | VD | ZD |
| 2015 | AF | DF | FF | GF | HF | LF | MF | RF | SF | TF | VF | ZF |
| 2016 | AG | DG | FG | GG | HG | LG | MG | RG | SG | TG | VG | ZG |
| 2017 | AH | DH | FH | GH | HH | LH | MH | RH | SH | TH | VH | ZH |
| 2018 | AL | DL | FL | GL | HL | LL | ML | RL | SL | TL | VL | ZL |
| 2019 | AM | DM | FM | GM | HM | LM | MM | RM | SM | TM | VM | ZM |
| 2020 | AR | DR | FR | GR | HR | LR | MR | RR | SR | TR | VR | ZR |
| 2021 | AS | DS | FS | GS | HS | LS | MS | RS | SS | TS | VS | ZS |

Component Locator Views

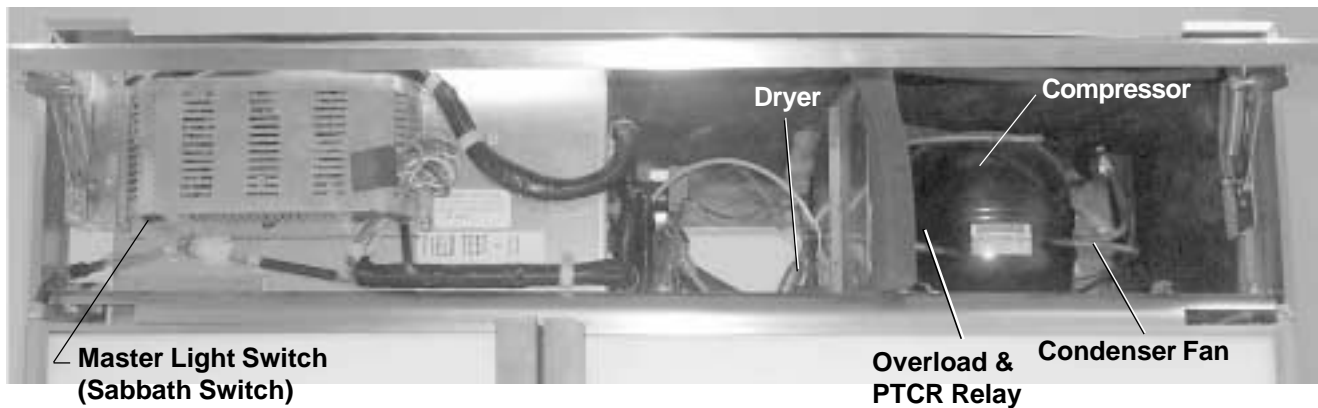

Figure 1 - Machine Compartment

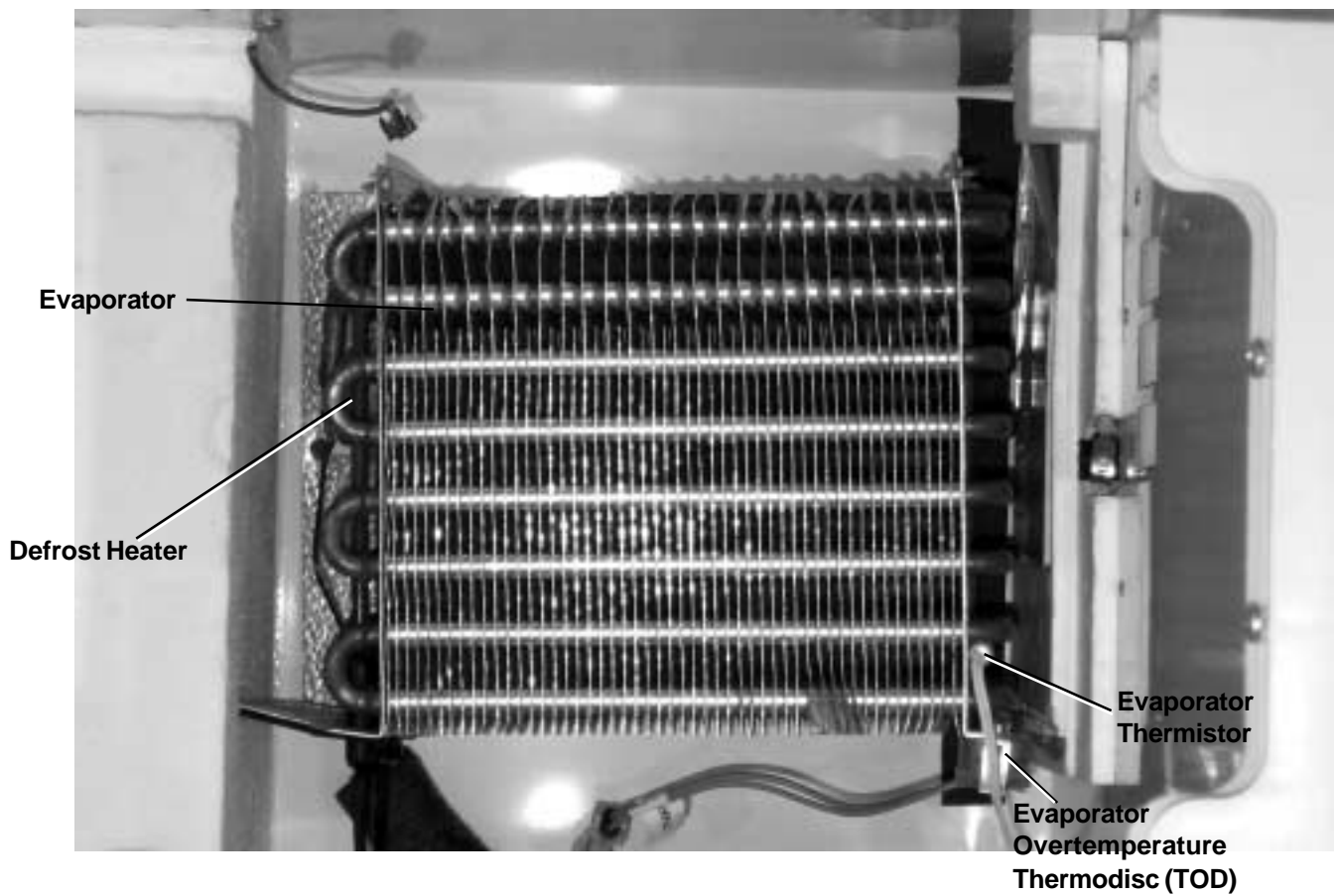

Figure 2 - Evaporator (Top of Freezer)

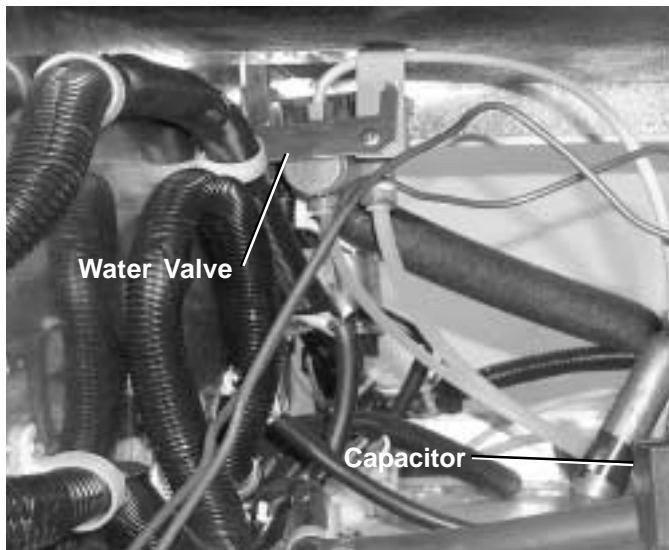

Figure 3 - Water Valve and Capacitor
(Center of Machine Compartment)

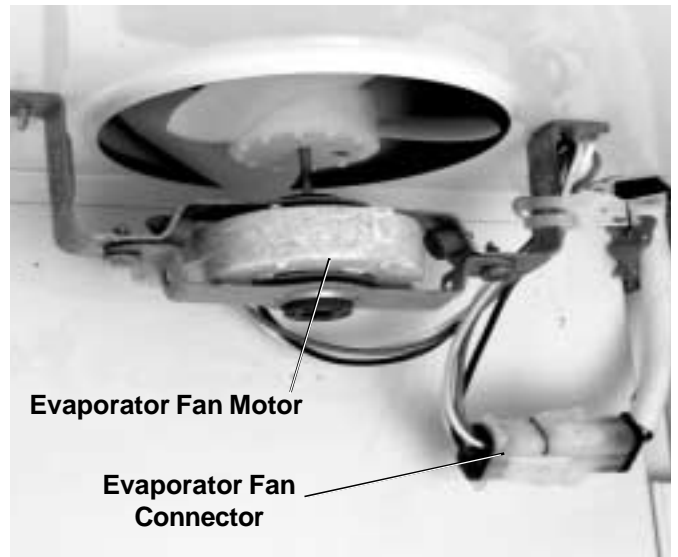

Figure 4 - Evaporator Fan

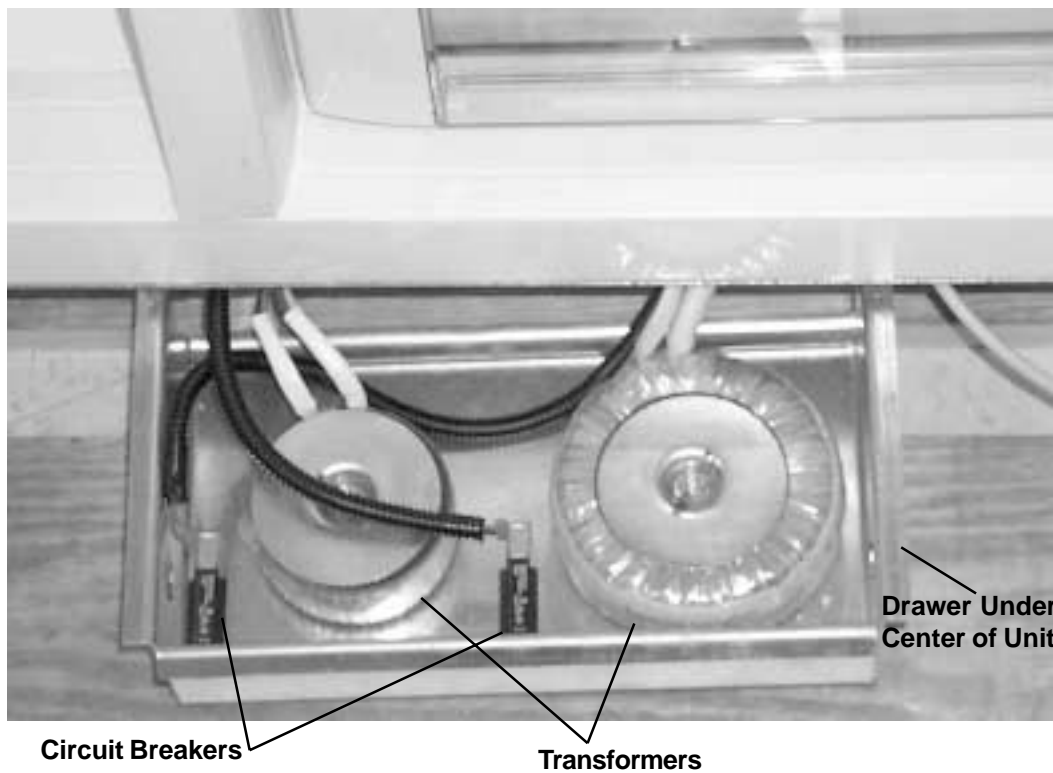

Figure 5 - Light Circuit Transformers

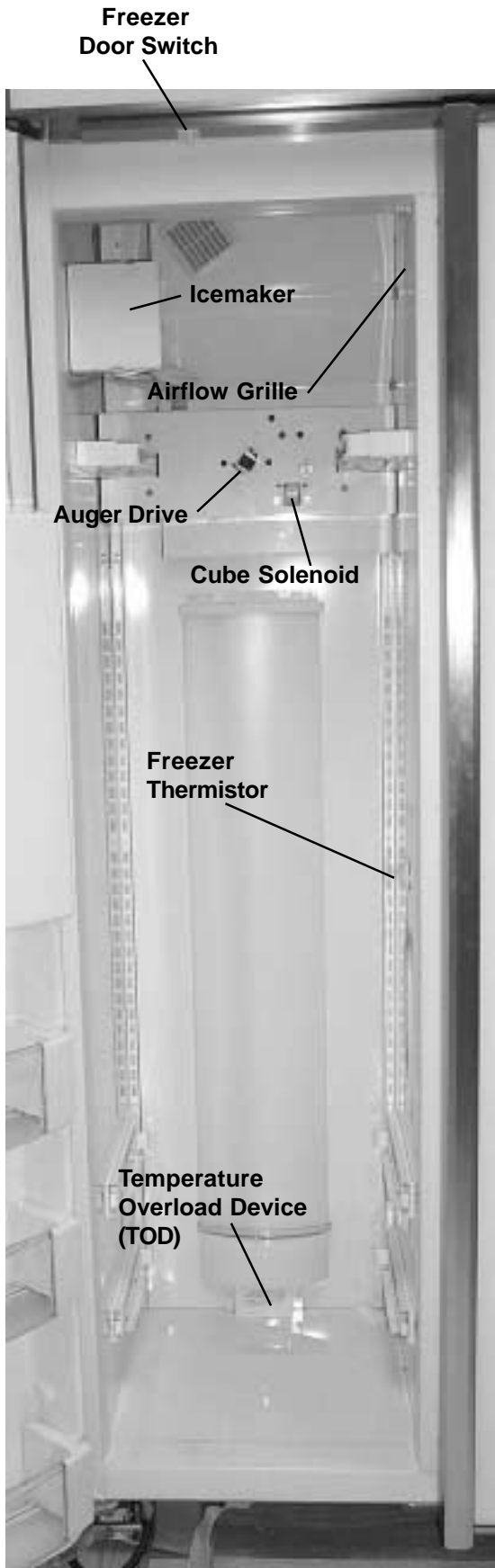

Figure 6 - Freezer Compartment

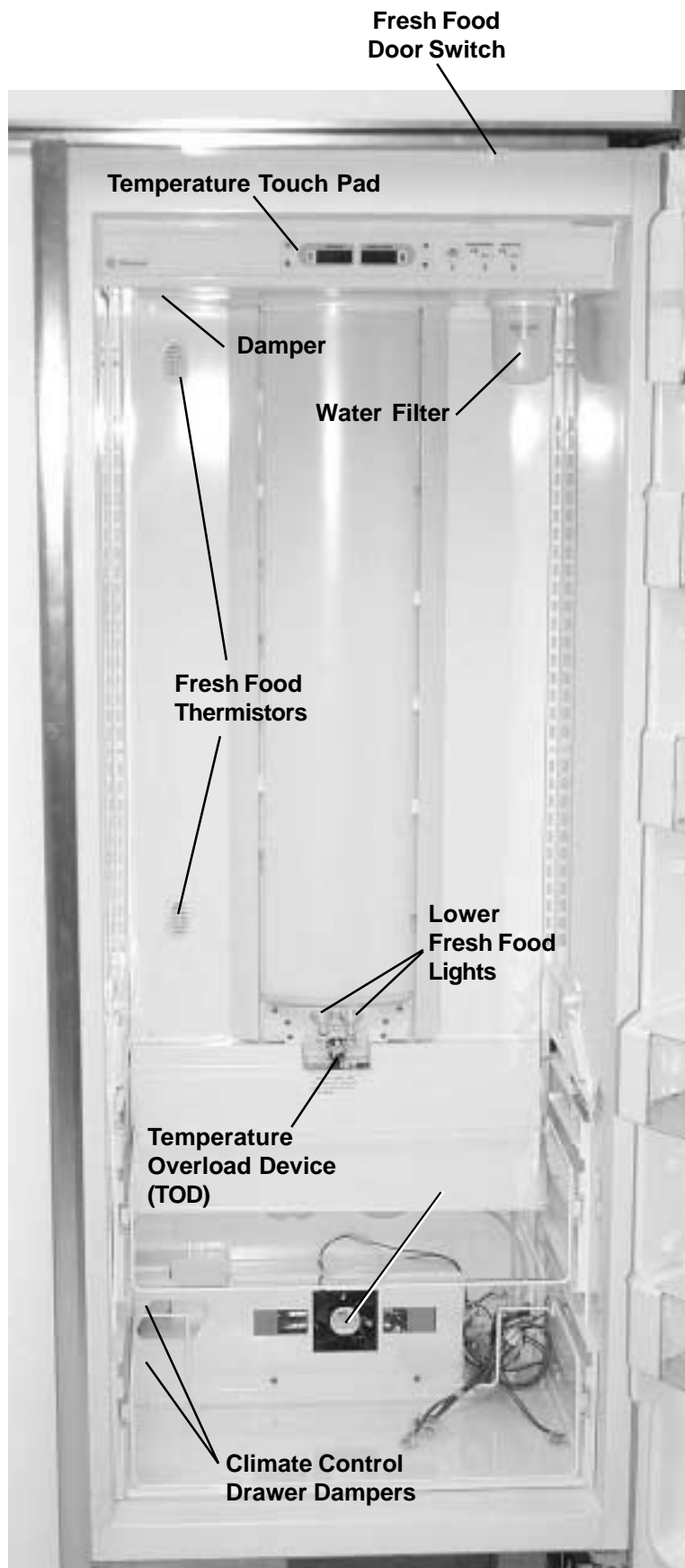

Figure 7 - Fresh Food Compartment

Cabinet

The outer case is made of prepainted galvanized steel. The fresh food and freezer liners are painted metal with a smooth finish. The liners are not removable or replaceable.

Machine Compartment

The machine compartment is located on the top of the unit and has a movable chassis that can be extended from the front of the unit to provide access to the refrigeration system components.

Caution: Avoid kinking the refrigeration lines when sliding the chassis out and back in.

To extend the chassis:

1. Remove the grille panel by removing 2 screws from each side (see photo).
2. Remove the wire guard and rocker switch panel.
3. Remove the condenser baffle.
4. Loosen 2 (7/16-in.) track bolts from the front of the chassis track.
5. Remove 2 (7/16-in.) rear track bolts and the spacers under the rear of the chassis track.
6. Pull the chassis forward until it reaches the stops in the tracks, working the refrigeration tubing as you pull the chassis out.

Note.

- When sliding the chassis back into position, be certain the lines and wiring have not fallen behind the chassis.
- Use the grille screws for adjustment when realigning the grille.

Machine Compartment

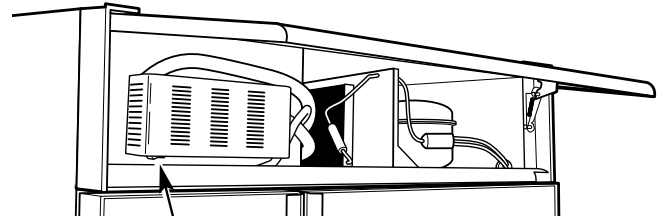

The Master Light Switch (Sabbath switch) is located behind the grille panel.

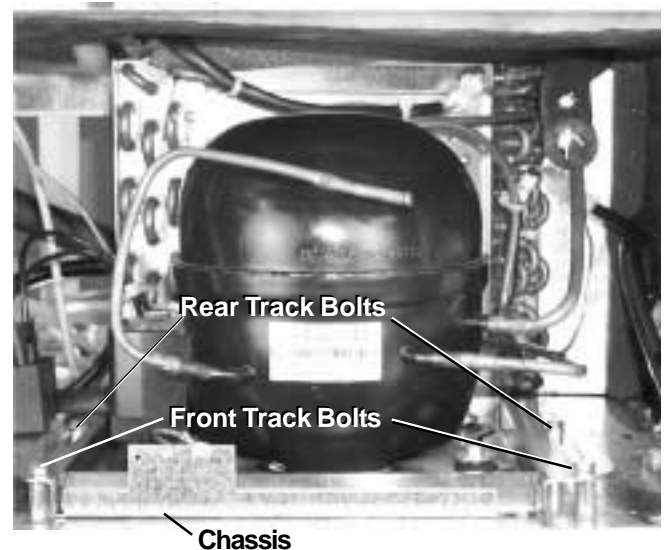
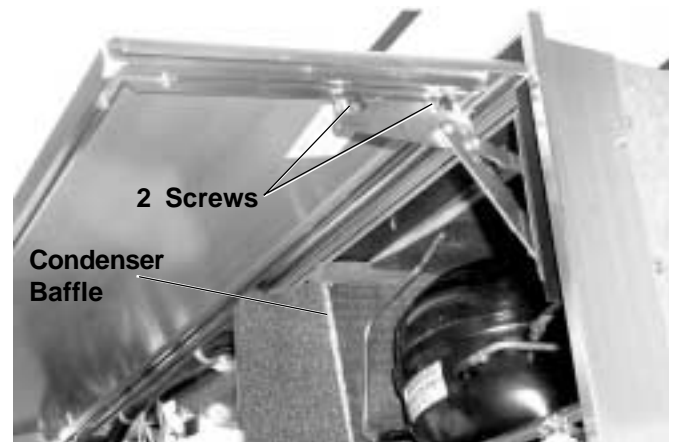

Door Closure Mechanism

The door closure mechanism uses a spring to provide positive door closure from approximately 60 degrees. The door closure mechanism actuator arm has a spring attached to the rear and is supported by guide rollers on either side of the base channel. The roller circumferences and the actuator arm detents are matched for smooth operation. The arm is attached to the door with an Allen head shoulder bolt.

The closure mechanism allows easy opening to approximately 90 degrees, where the arm has a detent to permit the door to remain open at 90 degrees with minimal tension. Once the door is opened beyond 90 degrees, the closure mechanism pulls the door open until the closure arm engages the door stop at approximately 130 degrees (factory setting, the door stop can be field set to 90 degrees). The reverse action occurs when the door is closed.

Note: The actuator arm is spring loaded with moderate spring tension.

1. Disconnect the spring from the pin and the actuator arm.
2. Remove the 3/16-in. Allen head bolt, bushing, and spacer from the door and actuator arm.

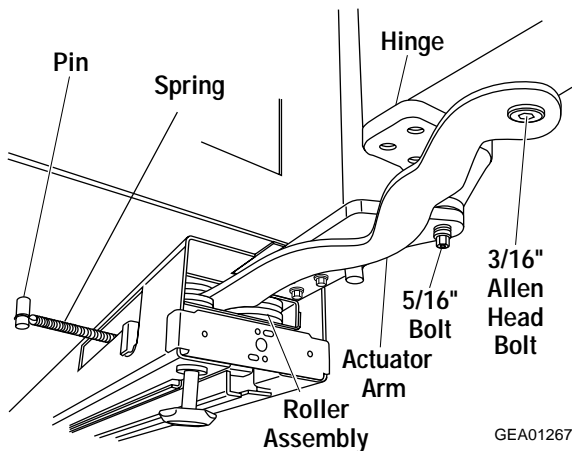

3. Remove 2 screws and the roller assembly from the rail. Replace roller if excessively worn.

Doors and Hinges

The doors are of one-piece construction with foam insulation.

The inner door panel and outer door panel cannot be separated and must be replaced as an assembly.

Door Adjustment

Be sure the top hinge does not hit the cabinet trim. Adjust the door up or down by turning the threaded hinge pin on the bottom hinge of the fresh food door.

The upper hinge on the freezer door is slotted to allow the freezer door to be adjusted left or right.

Door Removal

WARNING: Use the appropriate safety equipment and lifting techniques. Two persons may be required for door removal.

Caution: Use wood or a heavy plastic sheet to protect the floor where the door will be placed.

1. Remove all food and bins from the inner door liner and tape door to cabinet.
2. Disconnect the spring from the pin and the actuator arm.
3. Remove the Allen head bolt, bushing, and spacer from the door and actuator arm.
4. If removing the freezer door, shut off the water supply, and disconnect the water line and electrical connector.
5. Remove the upper hinge.
6. Lift door up and out to remove.

Lower Door Hinge

Note: If replacing lower door hinge, note the placement of the door stop (pin).

1. Remove the door.

Note: Note the placement of spacers and washers for reassembly.

2. Remove 3/8-in. hex screws (4) and hinge from the underside of the cabinet.

- Remove T-27 Torx screws (4) and hinge from the bottom of the door.

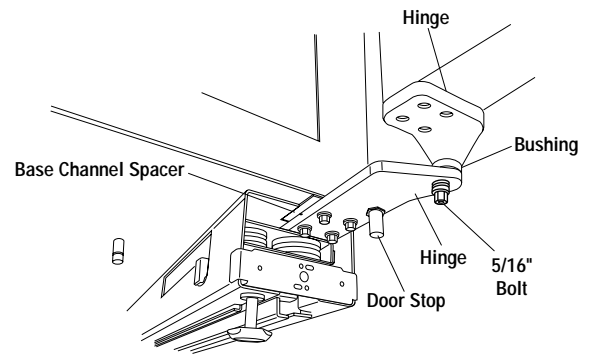

GEA01268

Door Gaskets

The fresh food and freezer doors have magnetic gaskets that create a positive seal to the front of the steel cabinet. The center mullion also has magnets to assist in door sealing. Improper installation of the door gasket will cause same-poled magnets to oppose one another, preventing the door from closing tightly.

The magnetic door gaskets are secured to the doors by a barbed edge that locks into a retainer channel. The side of the gasket that is nearest the handle of the door has a stripe on the inside of the barb (see photo).

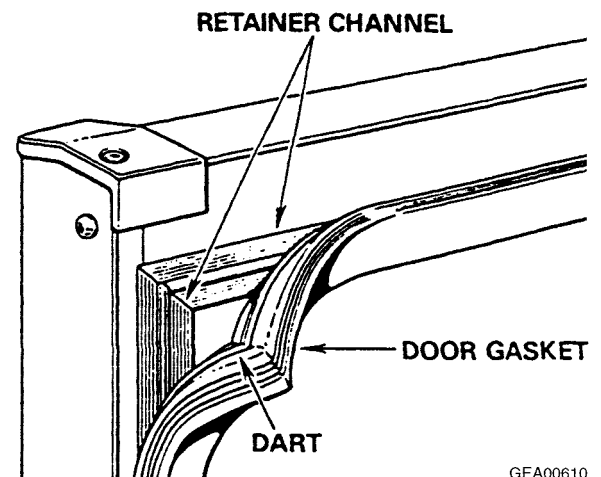

GEA00610

Replacement

- Starting at any corner, pull the old gasket out of the retaining channel.
- Soak the new gasket in warm water to make it pliable.
- Push the barbed edge of the gasket into the retainer channel.

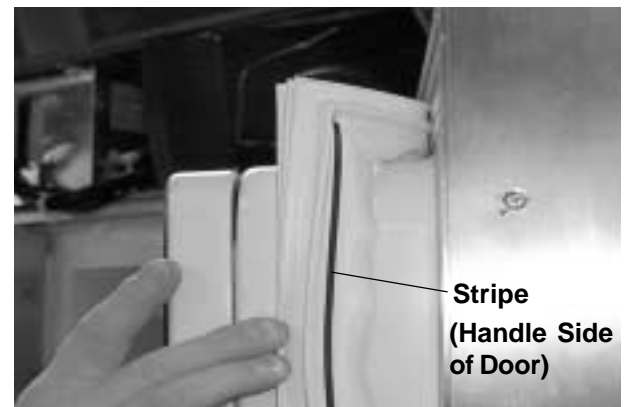

Rollers and Leveling

This model has 4-point leveling provided by adjustable rollers on the rear and leveling legs on the front. It also has 2 nonadjustable front rollers that are used only for unit positioning.

To level the unit:

- Turn the 7/16-in. hex nut, located above the front rollers, to adjust the roller on the rear of the unit. Turn clockwise to raise, counterclockwise to lower.
- Turn the front legs with a 1-1/4 in. open end wrench to adjust the front of the unit. Turn clockwise to raise, counterclockwise to lower.

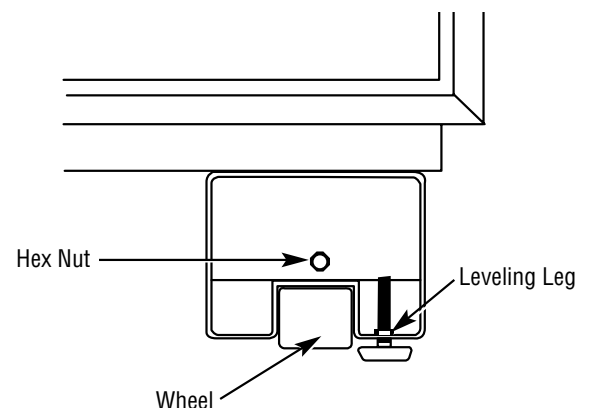

Ice and Water Dispenser

The icemaker is mounted to the upper left wall of the freezer cabinet. Under normal operating conditions, temperatures, door openings, and food load, the icemaker is capable of producing approximately 100 to 130 cubes in a 24-hour period.

To service the icemaker, refer to GE Publication 31-9063.

Controls

The electronic controls on the dispenser are interactive. The control panel is equipped with a proximity sensor that causes the panel to light up as you approach the dispenser (approx. 2 inches).

Removal

1. Remove the bezel from the outside of the freezer door.

Note: On stainless steel models, the front panel must be removed. Remove screws from top, bottom, and hinge side. Pull out on hinge side.

2. Remove the screw from the bottom of the control panel. Lift up and pull the bottom of the panel out. Disconnect the connectors, and remove the control panel.
3. Remove 4 screws and the backing panel.
4. From the back side of the panel, remove the water switch and the light socket.
5. Remove 3 screws and the duct door solenoid.

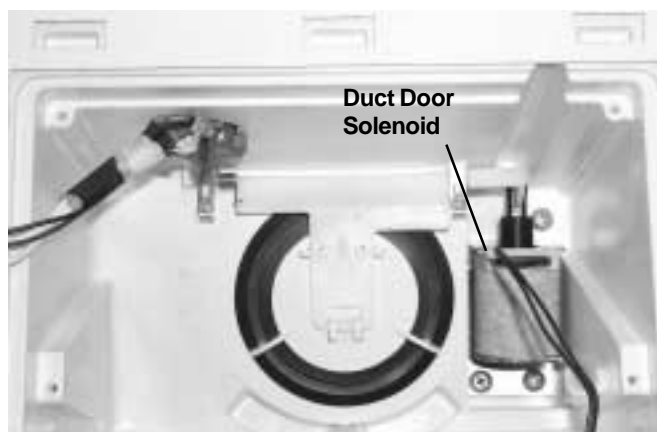
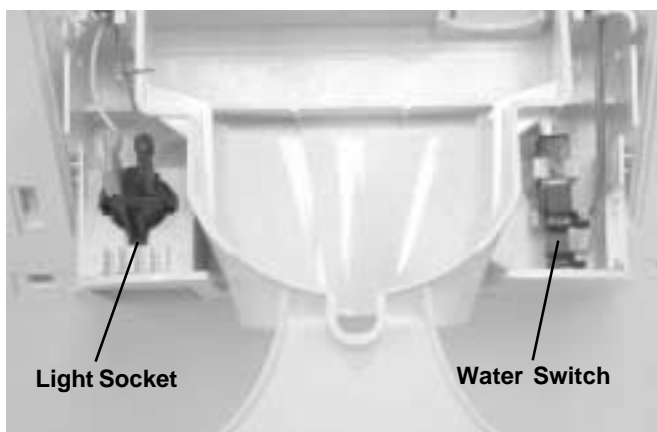
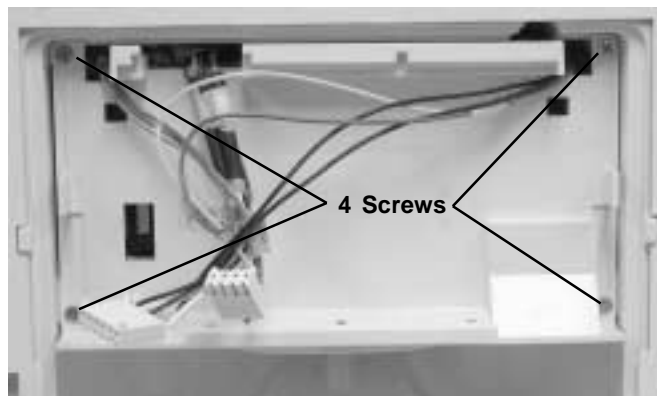
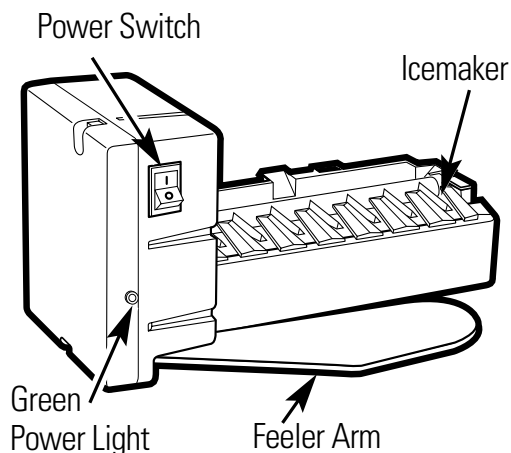

Water Valve and Water Tank

The water valve is mounted in the left side of the machine compartment.

A plastic water line is routed from under the unit, up the back of the cabinet, into the machine compartment, and to the water filter. A line then goes from the water filter to the water valve.

Two low-pressure plastic water lines supply water to the icemaker and door dispenser from the water valve. A plastic water line is routed from the water valve, out the back of the machine compartment, down the back of the cabinet through the bottom of the unit, and into the fresh food compartment where it is attached to the cold water tank. A line is routed from the cold water tank through the bottom of the unit into the freezer door to supply the water dispenser. The icemaker water line is routed from the water valve through the machine compartment to the icemaker. The icemaker fill tube is also plastic.

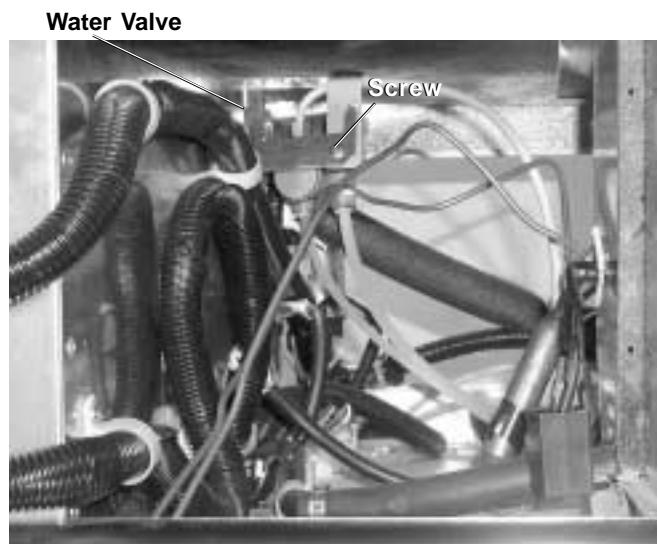

To Replace the Water Valve

Note: Some water may leak from the water supply line and valve when they are disconnected.

1. Shut off the water supply to the unit.
2. Open the grille panel.
3. Remove 1 Phillips screw attaching the water valve to the filter bracket.
4. Disconnect the wiring harness connector and 3 water lines from the water valve and remove.

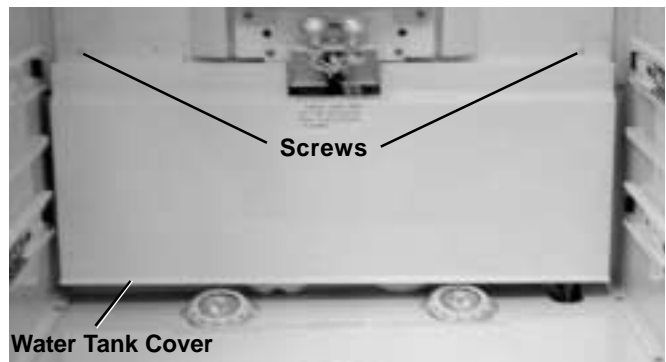

To Replace the Chilled Water Tank

Note: Some water may leak from the water supply line and valve when they are disconnected.

1. Shut off the water supply to the unit.
2. Remove 2 screws and the chilled water tank cover inside the fresh food compartment.
3. Remove 2 screws from the chilled water tank.
4. Cut the water lines leaving enough line to reconnect. Use union WR02X10471 (5/16 x 5/16).



Airflow

Damper

The fresh food compartment receives chilled air via an electronic damper that is positioned at the top rear of the fresh food compartment. The damper is controlled by the main control board and when open, allows the evaporator fan to push chilled air from the evaporator into the fresh food compartment.

To Remove the Damper

1. Remove the light cover.

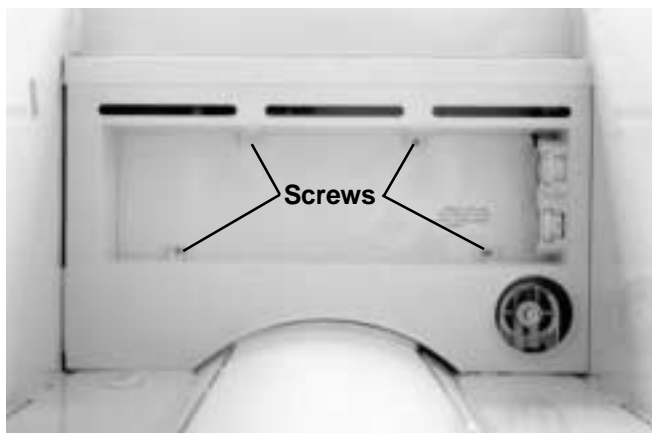

2. Remove 4 Phillips screws and the light assembly.



3. Remove the Styrofoam section covering the damper.
4. Disconnect the damper wiring connector.

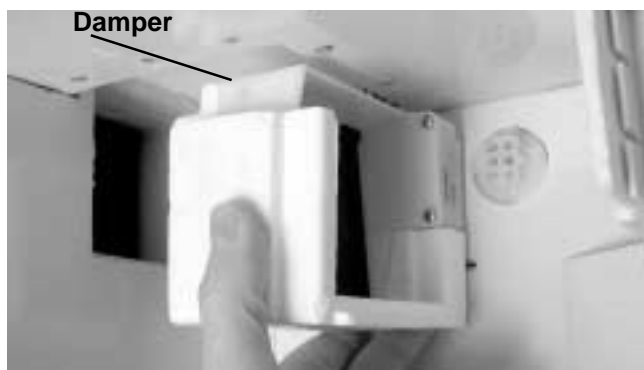

5. Carefully pull the damper out of the mullion and remove.

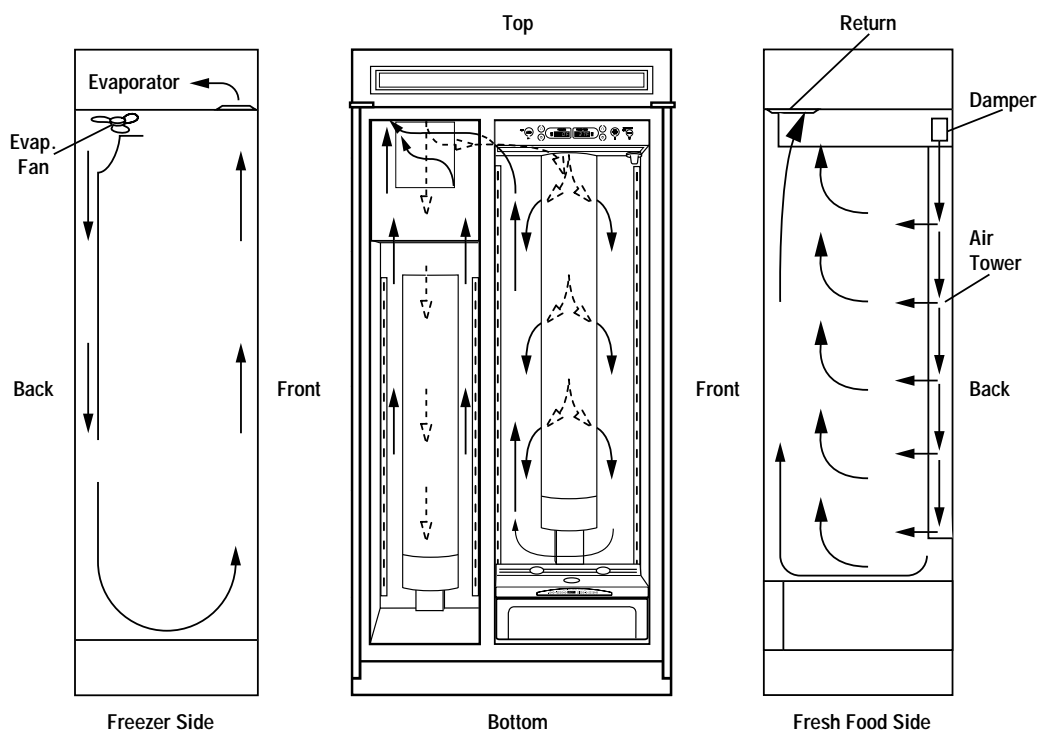

GEA01269

Evaporator Fan

The position of the fan blade in relation to the shroud is critical. Refer to evaporator fan adjustment graphic for specifications.

If the fan shorts, it may damage the main control board. If the resistor on the main control board is burnt, you must replace the fan and the board (see photo).

The evaporator fan utilizes a permanent magnet, 4-pole, DC motor that can operate at three different speeds: high, medium, and low (medium and low are the same speed, controlled by the main control board). The speed of the fan is controlled by the voltage output from the main control board. Voltage output from the control board to the fan is 12.6 VDC; however, in order to regulate the speed of the fan, the control board uses Pulse Width Modulation (PWM) during low-

Evaporator Fan Adjustment

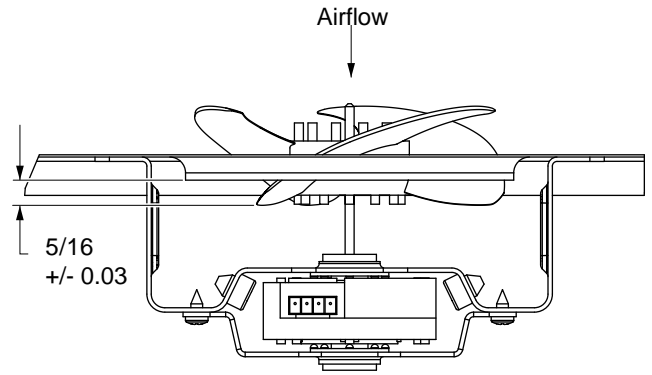

Evaporator and Condenser Fan Resistors

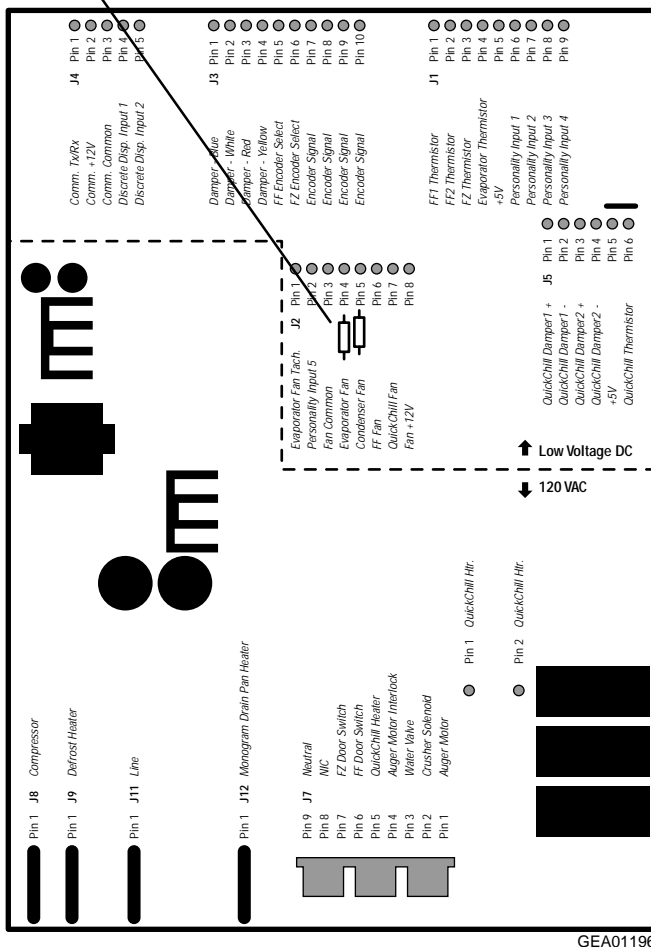

Evaporator Fan Resistor

J2 Connector

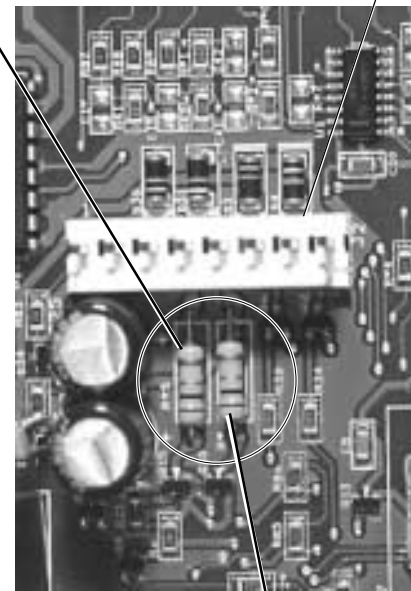

Condenser Fan Resistor

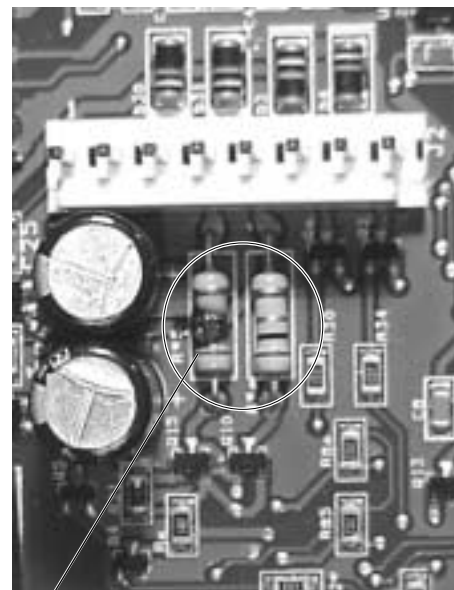

Bad Evaporator Fan Resistor

speed and medium-speed operation. When operating in low and medium speeds, voltage is sent in pulses (much like a duty cycle) as opposed to an uninterrupted flow. This pulsing of 12.6 VDC produces effective voltage being received at the motor, which is the equivalent to a reduction in voltage. Fan speed will be selected and maintained by the control board regulating the length and frequency of the 12.6 VDC pulse.

One complete revolution of the motor is comprised of all 4 poles. To determine the rpm of the fan: Measure the frequency being applied to the motor. Multiply this number by 15 (60 seconds divided by 4 poles). For example, a frequency measurement of 200 Hz multiplied by 15 would show a fan speed of 3000 rpm ($15 \times 200 = 3000$). Temperature may cause some fan speed variation. Fan speed may vary +/- 5%, depending on the temperature, with higher temperatures causing slightly higher speeds.

The evaporator fan motor uses a 4-wire connection, utilizing a common wire (white), feedback/rpm wire (blue), supply wire (red), and a signal wire (yellow).

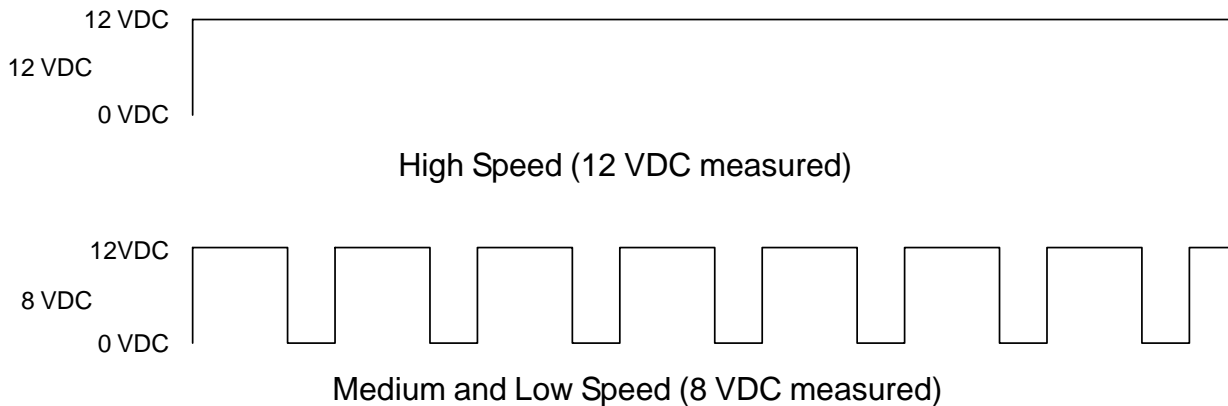

White Wire (DC Common)

The white wire is the DC common wire used for testing. During repairs, DC polarity must be observed. Reversing the DC polarity will cause a shorted motor and/or board.

Red Wire (Supply)

Each motor uses an internal electronic controller to operate the motor. Supply voltage from the main control board remains at a constant 12 VDC.

Blue Wire (Feedback/RPM)

The blue wire feeds rpm (speed) information to the main control board, allowing the board to maintain consistent fan speeds. Loss of feedback from the blue wire will result in the fan accelerating to maximum speed. Measure the fan rpm using the frequency between the blue and white wires.

High speed - 195 to 200 Hz

Medium speed - 145 to 160 Hz

Note: Fan operates at the same speed in low and medium.

Low speed - 145 to 160 Hz (same as medium)

Yellow Wire (Signal)

The yellow wire is the input wire from the main control board. The main control board provides 8.1 VDC effective voltage for low speed, 8.1 VDC effective voltage for medium speed, and 12.6 VDC for high speed. The fan will operate in low speed only when the fresh food thermistor is satisfied.

Note: When testing these motors:

- You cannot test with an ohmmeter.
- DC common is not AC common.
- Verify 2 voltage potentials:
 - a. Red to white - power for internal controller.
 - b. Yellow to white - power for fan.
- Observe circuit polarity.
- Motors can be run for short periods using a 9-volt battery. Connect the white wire to the negative (-) battery terminal only. Connect the red and yellow wires to the positive (+) battery terminal.

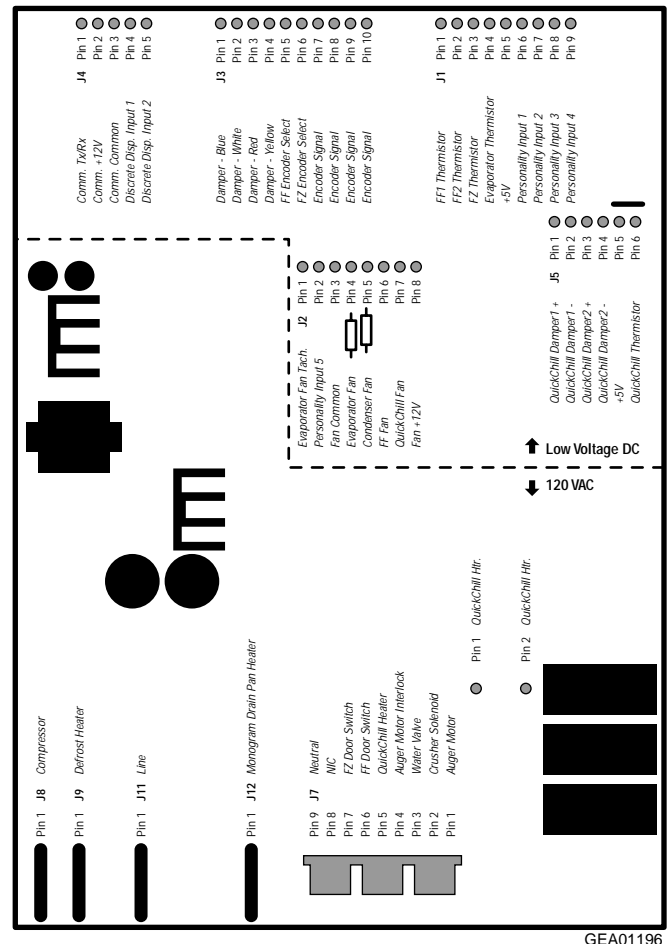

To Remove the Evaporator Fan

1. Remove the ice bucket.
2. Disconnect the icemaker connector. Loosen 2 screws and remove icemaker.
3. Remove 4 screws and slide the icemaker drive motor assembly forward. Disconnect the wiring connector and remove the assembly.

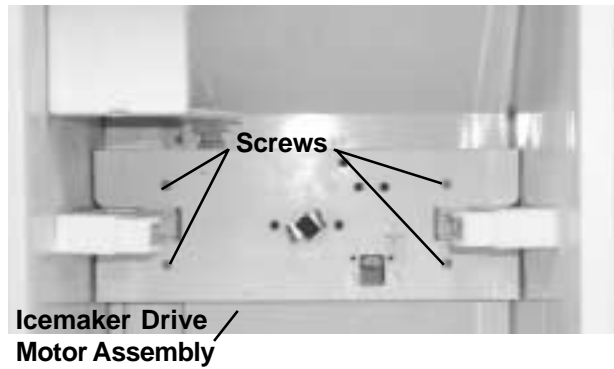

4. Remove 2 screws and inner section of left ice bucket track.

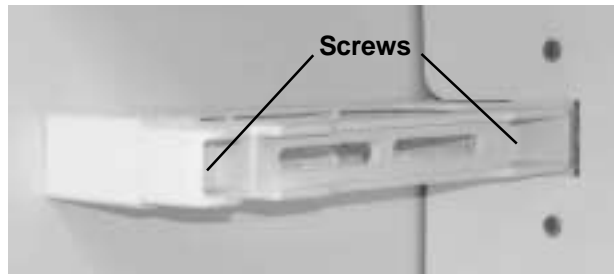

5. Remove 2 screws and wiring cover.

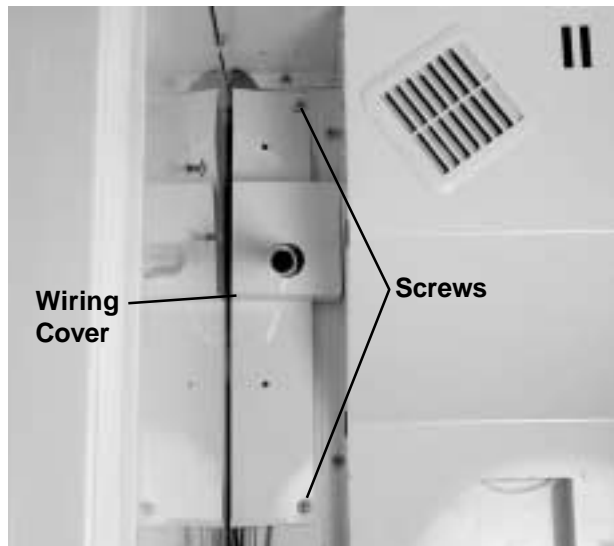

6. Remove 6 screws and evaporator fan cover.

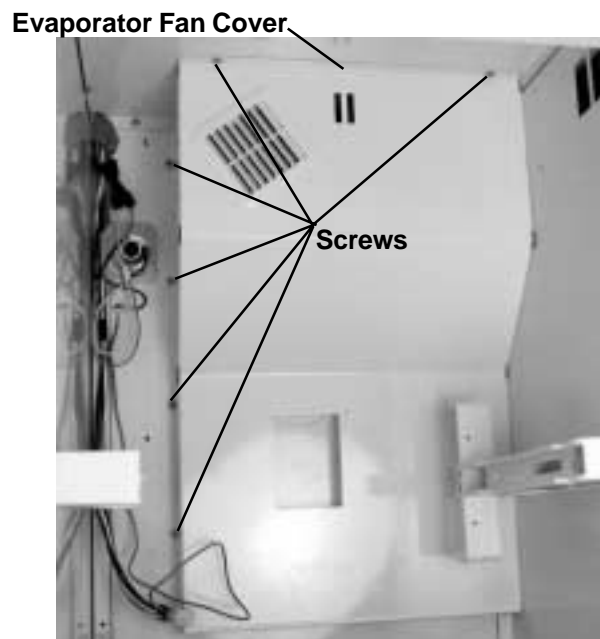

7. Disconnect the evaporator fan wiring connector.
8. Remove 2 screws from the fan mounting bracket and remove the fan.

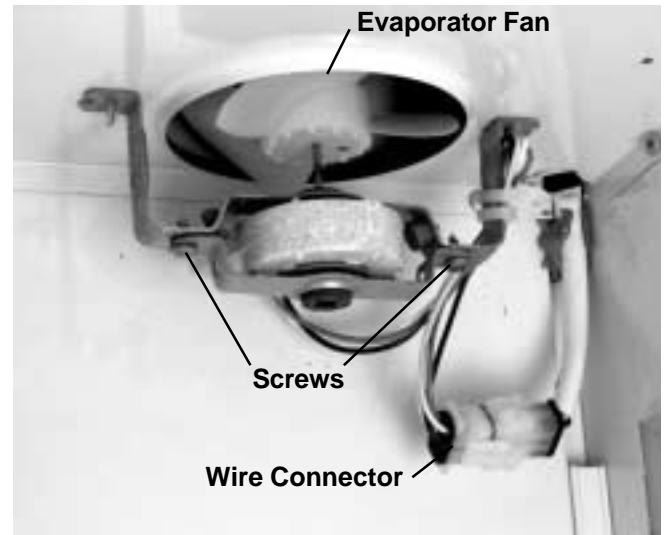

Condenser Fan

The condenser fan utilizes a DC motor that operates at a single speed and is mounted in the machine compartment. When the fan is operating, air is pulled through the condenser, drawing air through the coils. The air is then exhausted past the compressor and out the front of the refrigerator on the right side.

Inlet air is available through the left front and left rear of the machine compartment.

If the fan shorts, it will damage the main control board. If the resistor on the main control board is burnt, you must replace the fan and the board (see photo page 15).

The condenser fan is mounted with screws to a fan shroud and mounting bracket in back of the condenser.

To Remove the Fan

1. Extend the chassis (see Machine Compartment in the Cabinet chapter).
2. Pull the blade off the motor shaft.
3. Cut the wire tie securing the fan wiring to the fan bracket.

Caution: Fan connector can be separated into 3 segments (center, left side, and right side). Disconnect the fan connector at the center only.

4. Disconnect the fan connector.
5. Feed wiring through the hole in the fan shroud.
6. Remove 2 screws, top section of fan bracket, and motor.

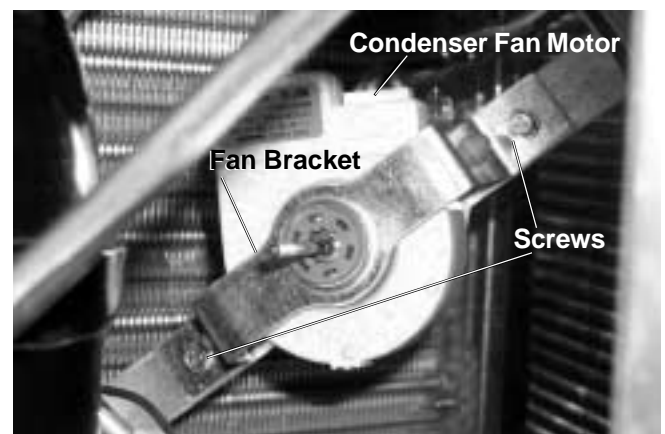

Defrost System

Adaptive Defrost

Adaptive Defrost can be described as a defrost system that adapts to a refrigerator's surrounding environment and household usage.

Unlike conventional defrost systems that use electromechanical timers with a fixed defrost cycle time, Adaptive Defrost utilizes an intelligent, electronic control to determine when the defrost cycle is necessary. In order to accomplish the correct defrost cycle time, the main control board monitors the following refrigerator operations:

- Length of time the refrigerator doors were open since the last defrost cycle
- Length of time the compressor has run since the last defrost cycle
- Amount of time the defrost heaters were on in the last defrost cycle

Adaptive Defrost is divided into 4 separate cycles. Those operations are:

- Cooling Operation
- Pre-Chill Operation
- Defrost Heater Operation
- Dwell Period

(See Pub. #31-9062 for more information on Adaptive Defrost.)

Adaptive Defrost (Cooling Operation)

During the cooling operation, the main control board monitors door opening (fresh food door and freezer drawer) and compressor run times. The board counts the time the doors are open. It reduces the length of time between defrosts by 300 seconds (multiplication factor) for each second that each door is open (if both doors are open, it reduces it by twice the amount). The multiplication factor reduces compressor run time. If the doors are not opened, the compressor will run up to 60 hours between defrosts. If the doors

are opened frequently and/or for long periods of time, the compressor run time between defrosts will be reduced to as little as 8 hours.

Adaptive Defrost (Pre-Chill Operation)

When the main control board determines that defrost is necessary, it will force the refrigerator into a continuous cool mode (pre-chill). During pre-chill, the freezer temperature may be driven below the set point. However, the fresh food temperature will be regulated by the evaporator fan running at low speed. Pre-chill will last for 30 minutes. These models do have an 8-hour defrost holdoff.

Adaptive Defrost (Defrost Heater Operation)

After 30 minutes of pre-chill operation, the main control board turns off the compressor, condenser fan, and evaporator fan.

During defrost operation, the main control board monitors the evaporator temperature using evaporator thermistor inputs. Typically, the evaporator thermistor will sense a temperature of 38 °F within 16 minutes. When the thermistor senses 38 °F, the main control board will terminate defrost heater operation. Maximum defrost cycle (heater on) time is 35 minutes (main control board time out).

The defrost system is protected by a defrost overtemperature thermistor (bimetal switch). The thermostat opens when the evaporator temperature raises to 60 °F and closes when the evaporator temperature lowers to 45 °F.

Adaptive Defrost (Dwell Period)

After defrost heater operation has been terminated by the main control board, a 20-minute dwell period occurs. During this period, the compressor, condenser fan, and evaporator fan remain off. The remaining frost melting from the evaporator will continue to drip and drain so that, prior to the cooling operation, the evaporator will be totally clear of any moisture. The pan heater is on for the entire 20 minute dwell period.

Normal Operating Characteristics

- Evaporator fan running, without compressor or condenser fan.
- Liner Protection Mode, fan comes on when the doors are open for 3 minutes.
- Different sound levels can be heard when the fan changes speed; however, the fan should never be heard oscillating between speeds.
- Response time for drastic temperature change is 2 to 10 minutes. The main control board will only respond to 8 °F of temperature change per minute as determined by resistance of sensor.

Abnormal Operating Characteristics (Incorrect Operation)

- Rapid fan speed changes, fan takes at least 1 minute to change speeds.
- Compressor running without the condenser fan. The compressor and condenser fan should always run at the same time.

Liner Protection Mode

The liner protection mode will activate if either of the doors has been open for 3 minutes. This mode will start the evaporator fan on high speed.

This mode is controlled by 2 timers. Timer #1 monitors door-open time. A 3-minute door-open count begins when the door is opened. If 3 minutes elapse before the door is closed, the liner protection mode will become active. Once the door is closed, timer #1 resets and liner protection mode goes into standby. In standby, normal fan and damper operations resume and timer #2 begins a 3-minute door-closed count. If 3 minutes elapse without a door opening, liner protection mode will completely deactivate. If a door is opened within the timer #2 door-closed count, the remaining time in the door-closed count will be deducted from the timer #1 door-open count.

Defrost Heater

Caution: Use care to avoid scratching the finish on unit walls.

The defrost heater is a single calrod-type, radiant heater mounted on the evaporator.

To remove the defrost heater:

1. Remove the evaporator fan (see Evaporator Fan procedure in the Airflow chapter).
2. Remove 8 screws and freezer ceiling panel.
3. Remove Styrofoam insulation from the bottom of the evaporator drain pan.
4. Loosen evaporator drain hose clamp.
5. Lower left side of evaporator drain pan and slide right side out of drain hose and remove.
6. Disconnect the heater wiring.
7. Remove 2 screws from the left and right heater fasteners.
8. Slide the heater toward the front of the freezer compartment and remove.

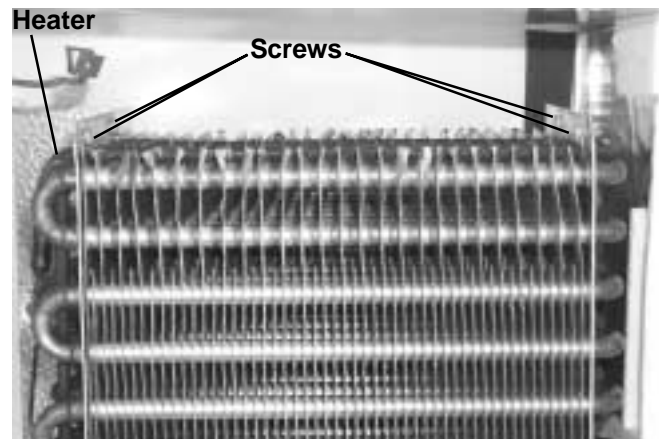

Evaporator Thermistor

The evaporator thermistor is mounted on the upper left side of the evaporator. The defrost cycle will terminate when the main control board detects 38 °F from the evaporator thermistor. The main control board must sense 38 °F in less than 35 minutes, or the defrost cycle will time out. Average time to defrost is less than 16 minutes. Defrost time should not exceed 35 minutes. Defrost time does not include dwell period.

Defrost Overtemperature Thermodisc

The defrost overtemperature thermodisc (bimetal switch) is mounted on the evaporator and provides overtemperature protection during defrost. This thermostat will open at 60 °F and will close at 45 °F.

Note: The main control board will not know if the heater does not come on due to a broken heater, open defrost overtemperature thermodisc, or open wiring harness. The defrost heater is controlled by maximum time on the main control board or temperature at the evaporator thermistor.

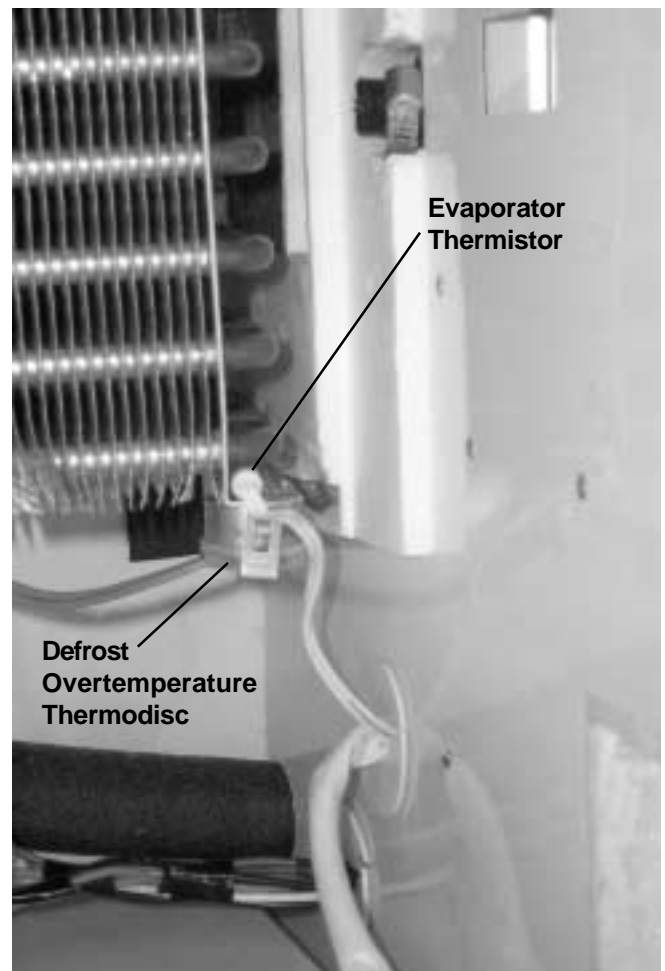

Control System

Touch Panel and Temperature Control Board

The temperature control assembly is located at the top front of the fresh food compartment and contains the touch panel and temperature control board.

The temperature control board receives switched DC voltage from the main control board. Input consists of pins 2 to 3. Failure of input results in default to most recent setting. Pin 1 provides digital communication between the temperature control board and the main control board. Failure of communication results in erratic control.

To remove the temperature control assembly:

1. Remove the light cover.
2. Remove 4 Phillips screws and the light assembly.

Note: Temperature control assembly is mounted on 3 slotted fasteners. Fasteners do not need to be loosened or removed.

3. Cut the RTV around the edge of the temperature control assembly.

Note: Old RTV must be removed from the inside of the fresh food compartment and from the temperature control assembly. RTV 102 must be put in place when the temperature control panel is installed.

4. Disconnect the temperature control assembly wiring connector.
5. Slide the temperature control assembly back to release it from the slotted fasteners and lower the assembly.
6. Disconnect the wiring connector from the temperature control board.
7. Slide the touch panel out of the temperature control assembly.
8. Remove 2 screws and the temperature control board.

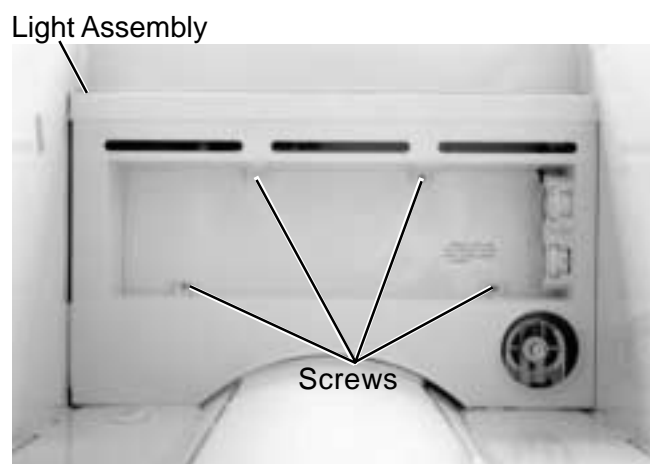

Main Control Board

The main control board, located behind a metal cover at the top of the refrigerator in the machine compartment, manages the operation of the refrigerator by calculating response from various inputs.

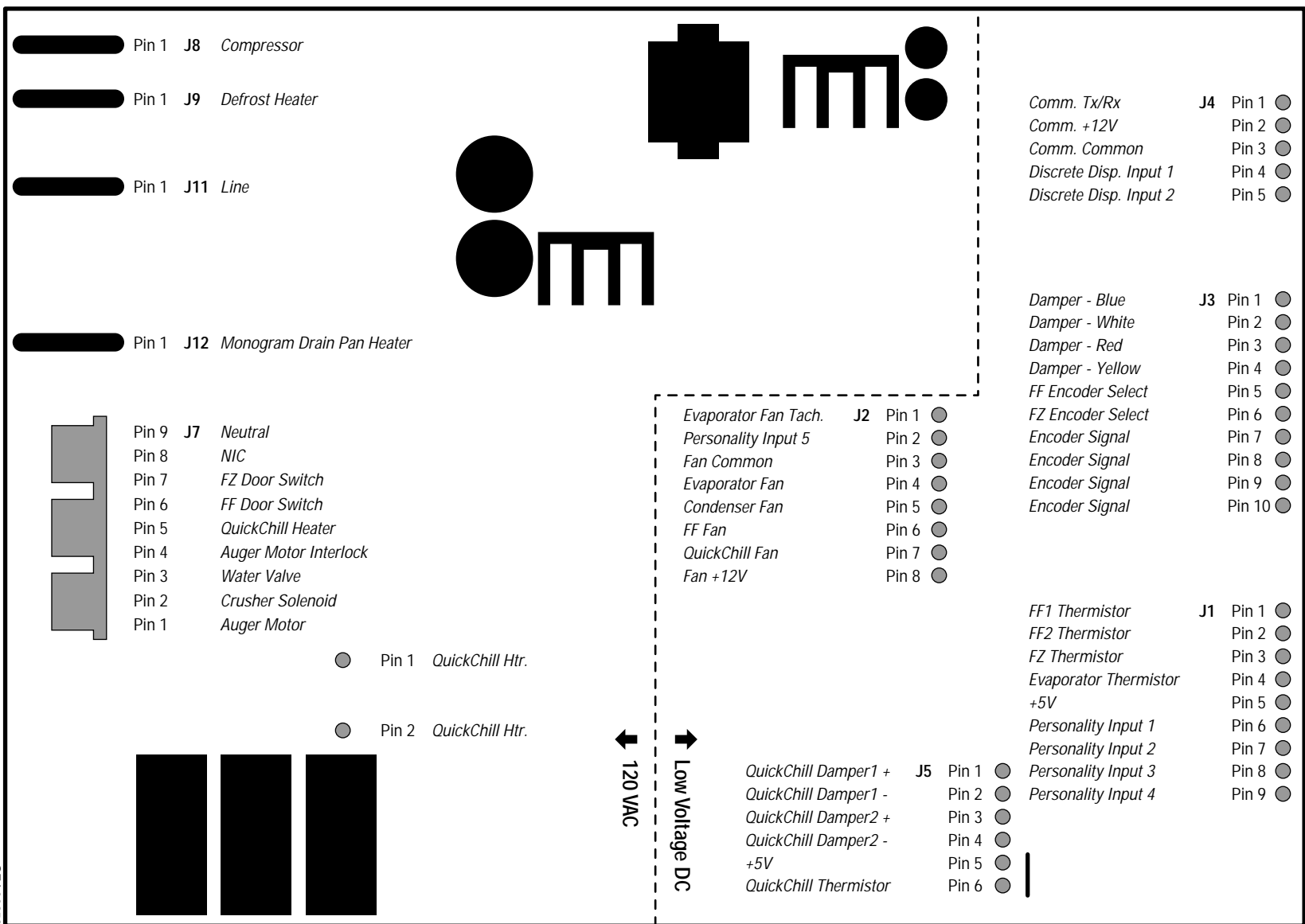

GEA00859

Main Control Board Locator Tables

| CONTROL BOARD PIN DEFINITIONS | | | | |
|-------------------------------|-----|-------|--------|--|
| CONNECTOR | PIN | INPUT | OUTPUT | FUNCTION |
| J1 | 1 | VDC | | Feedback of fresh food thermistor value. Thermistor is NTC, when temperature drops, resistance value increases, causing return voltage reduction. This value is used to cycle fresh food fan (when used), evaporator fan, compressor, and condensor fan. Feedback is filtered to respond to 8 degrees of change per minute. |
| J1 | 2 | VDC | | Feedback of second fresh food thermistor value (when used). Thermistor is NTC, when temperature drops, resistance value increases, causing return voltage reduction. This value is used to cycle fresh food fan (when used), evaporator fan, compressor, and condensor fan. Feedback is filtered to respond to 8 degrees of change per minute. |
| J1 | 3 | VDC | | Feedback of freezer thermistor value. Thermistor is NTC, when temperature drops, resistance value increases, causing return voltage reduction. This value is used to cycle evaporator fan, compressor, and condensor fan, and will not cycle fresh food fan (when used). Feedback is filtered to respond to 8 degrees of change per minute. |
| J1 | 4 | VDC | | Feedback of evaporator thermistor value. Thermistor is NTC, when temperature drops, resistance value increases, causing return voltage reduction. This thermistor value is used to cycle the heater on during defrost when temperature is below defrost value and off when the temperature is above defrost value. This value is also read during power-up to determine if refrigerator goes into pulldown mode or cycle continuation. Feedback is unfiltered, responds immediately. |
| J1 | 5 | | VDC | Provides 5 VDC for thermistors and personality pins on J1. |
| J1 | 9 | VDC | | Selection pin that, when connected in combination with other personality pins, determines model and programming used. Reads combination on power-up only. |

| CONTROL BOARD PIN DEFINITIONS | | | | |
|-------------------------------|-----|-------|--------|---|
| CONNECTOR | PIN | INPUT | OUTPUT | FUNCTION |
| J2 | 1 | Hz | | Feedback from evaporator fan. This feedback frequency is used to control the PWM for fan speeds. |
| J2 | 3 | | VDC | Fan common - VDC ground. |
| J2 | 4 | | VDC | Output to evaporator fan for motor operation. Effective voltage is determined by PWM. |
| J2 | 5 | | VDC | Output to condensor fan for motor operation. Effective voltage is determined by PWM, speed set in EEPROM. |
| J2 | 7 | | VDC | Output to Express Chill (QuickChill) fan for motor operation. Effective voltage is determined by PWM. |
| J2 | 8 | | VDC | Provides 12-VDC supply voltage to all fans, constant voltage. |

| CONTROL BOARD PIN DEFINITIONS | | | | |
|-------------------------------|-----|-------|--------|-----------------------|
| CONNECTOR | PIN | INPUT | OUTPUT | FUNCTION |
| J3 | 1 | | VDC | Damper stepper motor. |
| J3 | 2 | | VDC | Damper stepper motor. |
| J3 | 3 | | VDC | Damper stepper motor. |
| J3 | 4 | | VDC | Damper stepper motor. |

| CONTROL BOARD PIN DEFINITIONS | | | | |
|-------------------------------|-----|-----------------------|-----------------------|---|
| CONNECTOR | PIN | INPUT | OUTPUT | FUNCTION |
| J4 | 1 | Digital Communication | Digital Communication | Two-way digital communication between main control board, temperature control (board), dispenser board, and QuickChill board. |
| J4 | 2 | | VDC | 12-VDC supply. |
| J4 | 3 | | VDC | DC common. |

| CONTROL BOARD PIN DEFINITIONS | | | | |
|-------------------------------|-----|-------|--------|--|
| CONNECTOR | PIN | INPUT | OUTPUT | FUNCTION |
| J5 | 1 | | VDC | 12 VDC to Climate Control Drawer damper when Express Chill (QuickChill) is selected. Common - VDC ground when express thaw is selected. |
| J5 | 2 | | VDC | 12 VDC to Climate Control Drawer damper when Express Thaw is selected. Common - VDC ground when Express Chill (Quick Chill) is selected. |
| J5 | 5 | | VDC | Provides 5 VDC for Express Chill (QuickChill) thermistor. |
| J5 | 6 | VDC | | Feedback of Express Chill (QuickChill) thermistor. Thermistor is NTC, when temperature drops, resistance value increases, causing a reduction in return voltage. |

| CONTROL BOARD PIN DEFINITIONS | | | | |
|-------------------------------|-----|-------|--------|---|
| CONNECTOR | PIN | INPUT | OUTPUT | FUNCTION |
| J7 | 1 | | VAC | Switched L1 voltage to the auger motor - 120 VAC. |
| J7 | 2 | | VAC | Switched L1 voltage to the crusher solenoid - 120 VAC. |
| J7 | 3 | | VAC | Switched L1 voltage to the water valve - 120 VAC. |
| J7 | 4 | VAC | | Receives L1 input from freezer door switch when freezer door is closed. |
| J7 | 5 | | VAC | Switched L1 voltage to the Express Chill (QuickChill) heater - 120 VAC. |
| J7 | 6 | VAC | | Receives L1 input from fresh food door switch when switch closes (door open). This input is used for evaporator fan control, liner protection mode calculations, adaptive defrost calculations, and adaptive defrost calculations. |
| J7 | 7 | VAC | | Receives L1 input from freezer door switch when switch closes (door open). This input is used for evaporator fan control, liner protection mode calculations, adaptive defrost calculations, door alarm calculations, and some door interlock functions. Switch must be closed in door closed position (switch depressed) for dispenser light and duct door magnet to energize. |
| J7 | 9 | VAC | | AC neutral in. |

| CONTROL BOARD PIN DEFINITIONS | | | | |
|-------------------------------|-----|-------|--------|--|
| CONNECTOR | PIN | INPUT | OUTPUT | FUNCTION |
| J8 | 1 | | VAC | Switched L1 voltage to compressor circuit. A timer counts how long circuit is energized and uses this information to determine when the next defrost will occur. |

CONTROL BOARD PIN DEFINITIONS

| CONNECTOR | PIN | INPUT | OUTPUT | FUNCTION |
|-----------|-----|-------|--------|--|
| J9 | 1 | | VAC | Switched L1 voltage to the defrost circuit - 120 VAC. A timer counts how long this circuit is energized and uses this information to determine if the next defrost cycle is adaptive or nonadaptive. |

CONTROL BOARD PIN DEFINITIONS

| CONNECTOR | PIN | INPUT | OUTPUT | FUNCTION |
|-----------|-----|-------|--------|--|
| J11 | 1 | VAC | | Constant L1 voltage to control board circuits - 120 VAC input potential for switched L1 terminals. |

CONTROL BOARD PIN DEFINITIONS

| CONNECTOR | PIN | INPUT | OUTPUT | FUNCTION |
|-----------|-----|-------|--------|-------------------------------------|
| J12 | 1 | | VAC | L1 voltage to the drain pan heater. |

**Main Control Board
J7 Connector (120 VAC Side)**

| Pin | Wire Color | Component Termination | Input/Output | Pin-to-Pin Voltage Reading |
|-----|------------|------------------------------|--------------|---|
| 1 | Black | Auger motor | Output | J7 pin 1 to J7 pin 9 = 120 VAC |
| 2 | Purple | Crusher solenoid | Output | J7 pin 2 to J7 pin 9 = 120 VAC |
| 3 | Blue | Water valve | Output | J7 pin 3 to J7 pin 9 = 120 VAC |
| 4 | Red | Freezer door switch | Input | J7 pin 4 to J7 pin 9 = 120 VAC (FZ door closed) |
| 5 | Violet | QuickChill Heater | Output | J7 pin 5 to J7 pin 9 = 120 VAC |
| 6 | Blue | Fresh food door light switch | Input | J7 pin 6 to J7 pin 9 = 120 VAC (FF door open) |
| 7 | Yellow | Freezer door light switch | Input | J7 pin 7 to J7 pin 9 = 120 VAC (FZ door open) |
| 9 | Orange | Neutral | Neutral | Neutral |

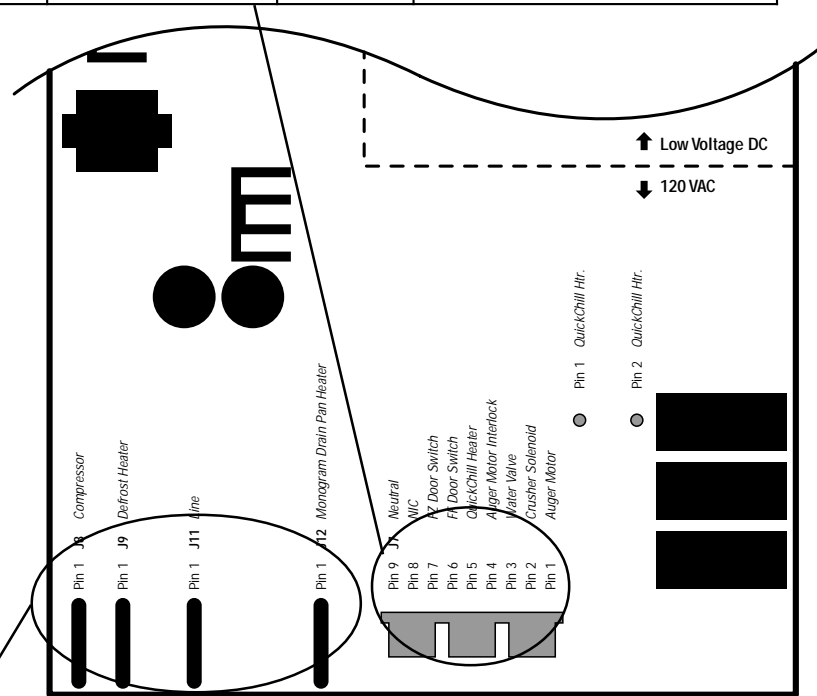

GEA01194

**Main Control Board J8, J9, J11
Connectors (High-Voltage Side)**

| Pin | Wire Color | Input/Output | Pin-to-Pin Voltage Reading |
|-----|------------|--------------|----------------------------|
| J8 | White | Output | J8 to J7 pin 9 = 120 VAC |
| J9 | Red | Output | J9 to J7 pin 9 = 120 VAC |
| J11 | Brown | Input | J11 to J7 pin 9 = 120 VAC |
| J12 | Black | Output | J12 to J7 pin 9 = 120 VAC |

| Main Control Board J4 Connector (Low-Voltage DC Side) | | | | |
|--|------------|-----------------------|---------------|---|
| Pin | Wire Color | Component Termination | Input/Output | Pin-to-Pin Voltage Reading |
| 1 | Red | Temperature control | Communication | Two-way digital communication between main control board, temperature control (board), dispenser board, and QuickChill board. |
| 2 | Brown | Temperature control | VDC | 12-VDC supply. |
| 3 | Orange | Temperature control | VDC | DC common. |

| Main Control Board J3 Connector (Low-Voltage DC Side) | | | | |
|--|------------|-----------------------|--------------|--|
| Pin | Wire Color | Component Termination | Input/Output | Pin-to-Pin Voltage Reading |
| 1 | Blue | Damper Stepper Motor | | J3 pin 1 to J4 pin 3 = Standing Voltage 2.3 VDC Traveling Voltage = 6.0 VDC |
| 2 | White | Damper Stepper Motor | | J3 pin 2 to J4 pin 3 = Standing Voltage 2.3 VDC Traveling Voltage = 6.0 VDC |
| 3 | Red | Damper Stepper Motor | | J3 pin 3 to J4 pin 3 = Standing Voltage 2.3 VDC Traveling Voltage = 6.0 VDC |
| 4 | Yellow | Damper Stepper Motor | | J3 pin 4 to J4 pin 3 = Standing Voltage 2.3 VDC Traveling Voltage = 6.0 VDC |

| Main Control Board J1 Connector (Low-Voltage DC Side) | | | | |
|--|------------|-----------------------------------|--------------|------------------------------------|
| Pin | Wire Color | Component Termination | Input/Output | Pin-to-Pin Voltage Reading |
| 1 | Purple | Fresh food thermistor 1 | Input | J1 pin 1 to pin 5 = 2.8 to 3.5 VDC |
| 2 | Blue | Fresh food thermistor 2 | Input | J1 pin 2 to pin 5 = 2.8 to 3.5 VDC |
| 3 | Red | Freezer thermistor | Input | J1 pin 3 to pin 5 = 2.8 to 3.5 VDC |
| 4 | Black | Evaporator thermistor | Input | J1 pin 4 to pin 5 = 2.8 to 3.5 VDC |
| 5 | Brown | Thermistor supply voltage (5 VDC) | Output | J1 pin 5 to J4 pin 3 = 5 VDC |

| Main Control Board J5 Connector (Low-Voltage DC Side) | | | | |
|--|------------|-------------------------------------|--------------|---|
| Pin | Wire Color | Component Termination | Input/Output | Pin-to-Pin Voltage Reading |
| 1 | Yellow | QuickChill (Custom Cool) Damper | Input/Output | J5 pin 1 to pin 2 = 12 VDC (reversing polarity) |
| 2 | Gray | QuickChill (Custom Cool) Damper | Input/Output | J5 pin 2 to pin 1 = 12 VDC (reversing polarity) |
| 5 | Brown | Supply Voltage (5 VDC) | Output | J5 pin 10 to J2 pin 3 = 5 VDC |
| 6 | Blue | QuickChill (Custom Cool) Thermistor | Input | N/A |

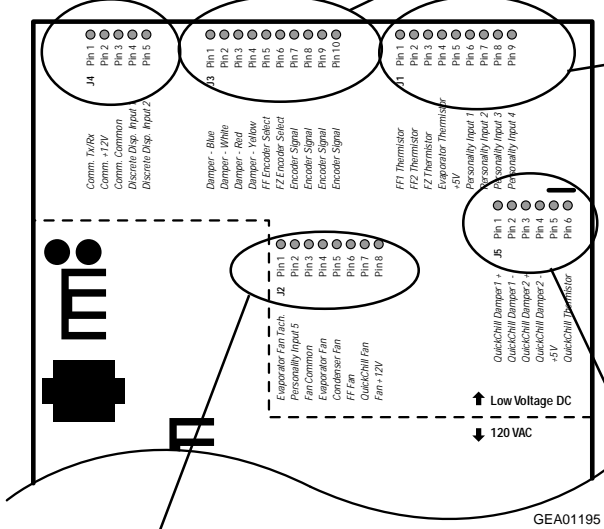

| Main Control Board J2 Connector (Low-Voltage DC Side) | | | | |
|--|------------|-----------------------------|--------------|--|
| Pin | Wire Color | Component Termination | Input/Output | Pin-to-Pin Voltage Reading |
| 1 | Blue | Evaporator fan tachometer | Input | J2 pin 1 to pin 3 = 6.3 VDC |
| 3 | White | Fan common | Common | J2 pin 3 to pin 8 = 12 VDC |
| 4 | Yellow | Evaporator fan | Output | J2 pin 4 to pin 3 = 12.6 VDC (high), 8.1 VDC (med.), 8.1 VDC (low) |
| 5 | Pink | Condenser fan | Output | J2 pin 5 to pin 3 = 13.4 VDC (condenser fan is single speed) |
| 6 | Black | Drain pan fan | Ground | VDC ground |
| 7 | Black | QuickChill fan | Common | J2 pin 8 to pin 7 = 12 VDC |
| 8 | Red | Fan supply voltage (12 VDC) | Output | J2 pin 8 to pin 3 = 12 VDC |

Thermistors

This main control board uses input from 4 thermistors. These thermistors are located in the fresh food section, the freezer section, and on the evaporator. The main control board monitors the thermistors to determine the temperature in these areas of the unit and determines which components to run and when to run them based on this information.

| Thermistor Values | | |
|-------------------------|-------------------------|-------------------------|
| Temperature Degrees (C) | Temperature Degrees (F) | Resistance in Kilo-ohms |
| -40 | -40 | 166.8 kΩ |
| -30 | -22 | 88 kΩ |
| -20 | -4 | 48.4 kΩ |
| -10 | 14 | 27.6 kΩ |
| 0 | 32 | 16.3 kΩ |
| 10 | 50 | 10 kΩ |
| 20 | 68 | 6.2 kΩ |
| 30 | 86 | 4 kΩ |
| 40 | 104 | 2.6 kΩ |
| 50 | 122 | 1.8 kΩ |
| 60 | 140 | 1.2 kΩ |

| Temperature Set Point Chart | | | | | |
|-----------------------------|---|---------|-------------------------|--------------------------------------|---------|
| Fresh Food Control Setting | Fresh Food Thermistor Temperature Range | | Freezer Control Setting | Freezer Thermistor Temperature Range | |
| | Minimum | Maximum | | Minimum | Maximum |
| 34 °F | 32 °F | 36 °F | -5 °F | -10 °F | 0 °F |
| 35 °F | 33 °F | 37 °F | -4 °F | -9 °F | 1 °F |
| 36 °F | 34 °F | 38 °F | -3 °F | -8 °F | 2 °F |
| 37 °F | 35 °F | 39 °F | -2 °F | -7 °F | 3 °F |
| 38 °F | 36 °F | 40 °F | -1 °F | -6 °F | 4 °F |
| 39 °F | 37 °F | 41 °F | 0 °F | -5 °F | 5 °F |
| 40 °F | 38 °F | 42 °F | 1 °F | -4 °F | 6 °F |
| 41 °F | 39 °F | 43 °F | 2 °F | -3 °F | 7 °F |
| 42 °F | 40 °F | 44 °F | 3 °F | -2 °F | 8 °F |
| 43 °F | 41 °F | 45 °F | 4 °F | -1 °F | 9 °F |
| 44 °F | 42 °F | 46 °F | 5 °F | 0 °F | 10 °F |
| 45 °F | 43 °F | 47 °F | 6 °F | 1 °F | 11 °F |

Climate Control Drawer

The Climate Control Drawer can chill or thaw items quickly. It can also store items at their optimum temperatures. This Climate Control Drawer contains the following components:

- Control Board
- Thermistor
- Dampers (2)
- Fan
- Heater

The main control board controls the dampers, fan, and heater based on input from the Climate Control Drawer's control board and the thermistor.

The Climate Control Drawer compartment is sealed to reduce the effect that the drawer temperature has on the rest of the refrigerator. When the drawer features are not being used, the temperature inside the drawer will be the same as the fresh food compartment.

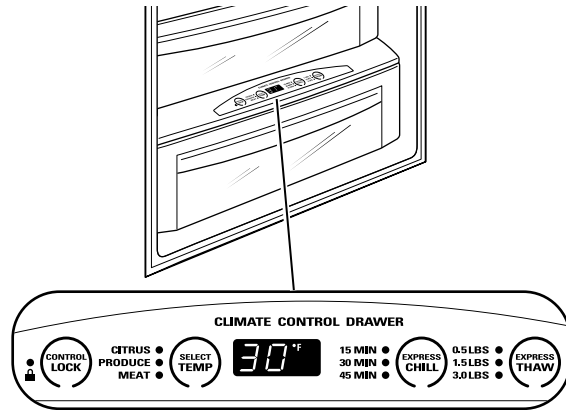

Strip Circuit

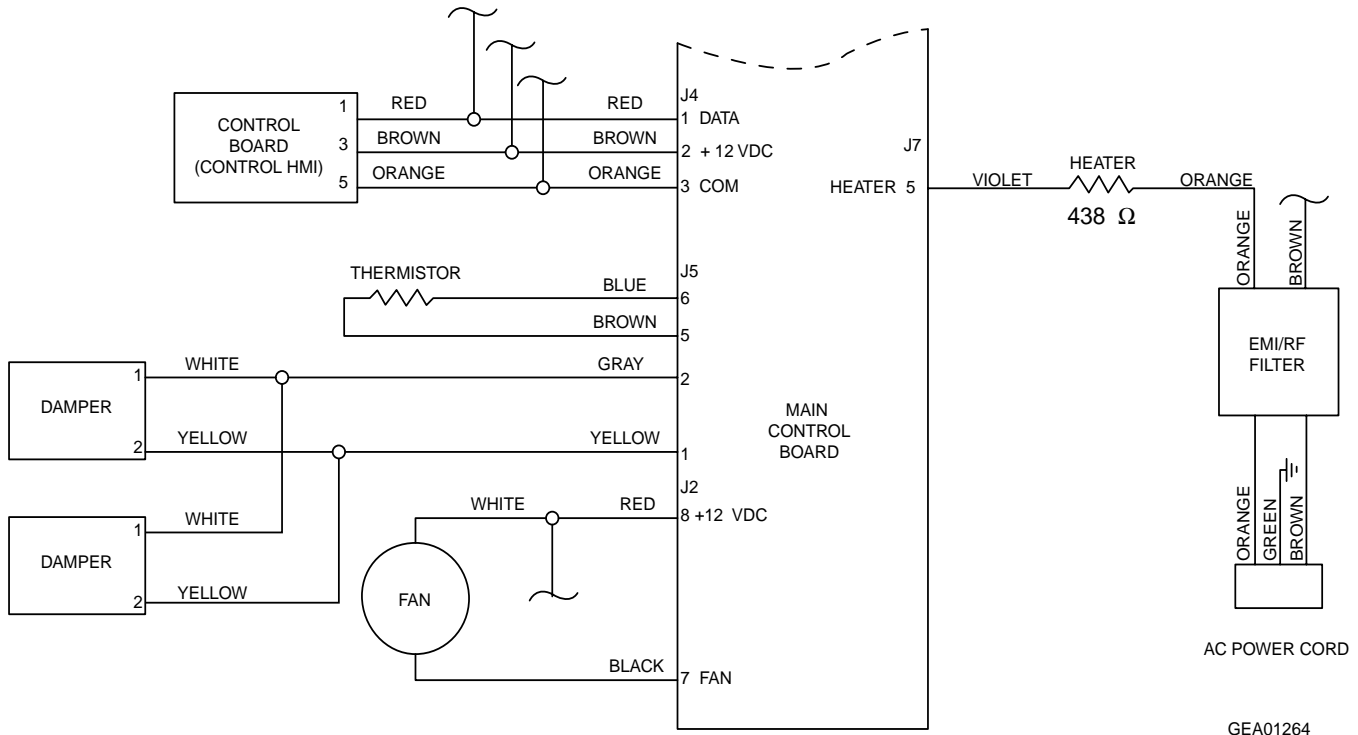

Component Locator View

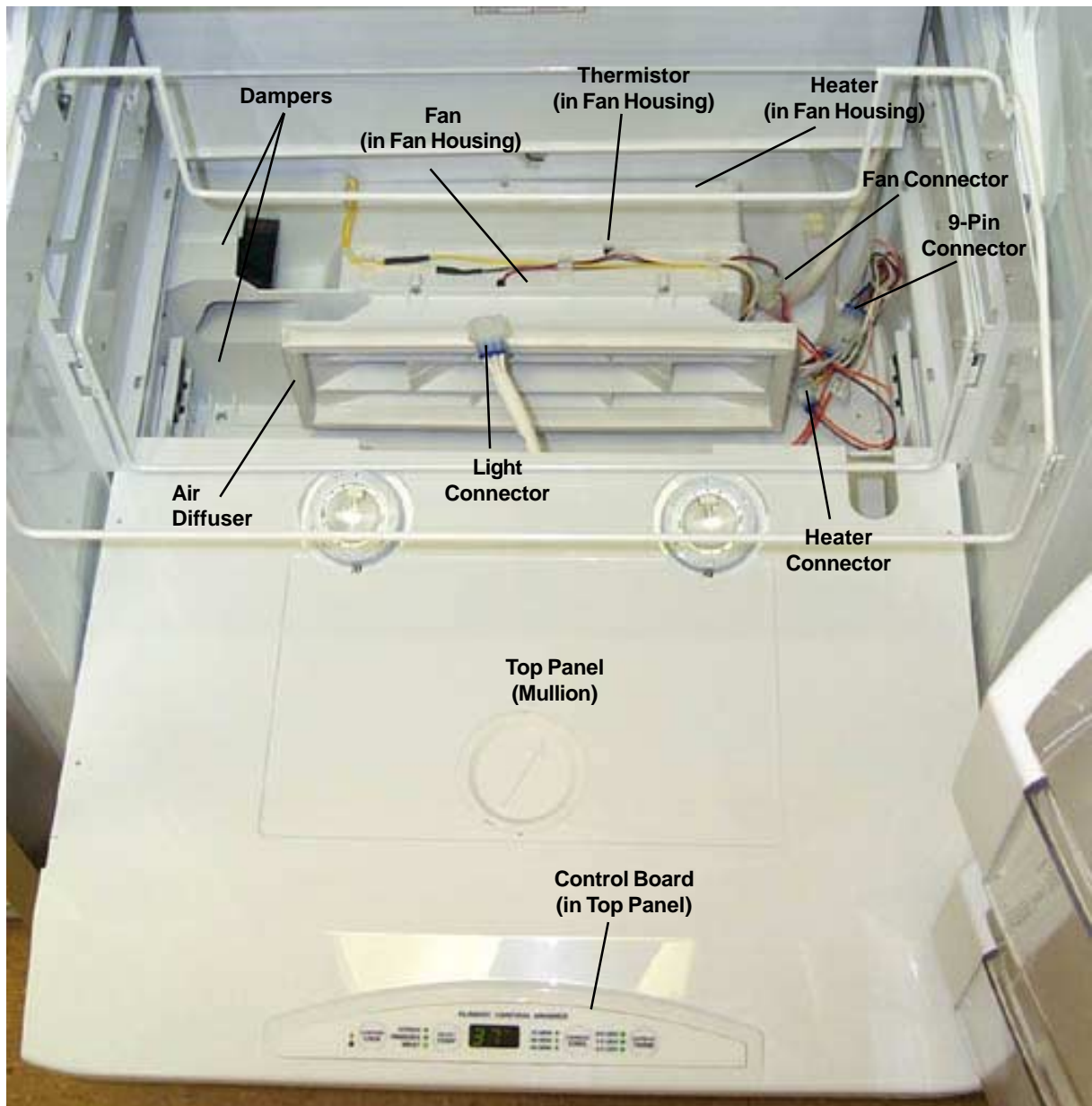

Climate Control Drawer compartment shown with top panel moved out

Operation

During all modes of operation, the main control board will cycle the dampers, fan, and heater as necessary to maintain the desired temperature. Typical operation is as follows:

Select Temp

This feature maintains optimum temperatures for specific items.

The CITRUS setting will maintain a drawer temperature of 43 °F by circulating warmed air or cooled air as needed. The dampers will close and the heater will turn on if warmed air is required to maintain 43 °F. The dampers will open if cooled air is required.

The PRODUCE setting will maintain a drawer temperature of 34 °F by circulating warmed air or cooled air as needed. The dampers will close and the heater will turn on if warmed air is required to maintain 34 °F. The dampers will open if cooled air is required.

The MEAT setting will maintain a drawer temperature of 32 °F by circulating warmed air or cooled air as needed. The dampers will close and the heater will turn on if warmed air is required to maintain 32 °F. The dampers will open if cooled air is required.

The Climate Control drawer display will show the selected temperature for approximately 4 seconds after a Select Temp mode has been selected. After approximately 4 seconds, the actual temperature of the drawer will be displayed. Refer to the Temperature Table for drawer temperatures.

Express Chill

This feature cools items by opening the dampers and circulating air from the freezer compartment throughout the drawer. The fan will be on at all times during Express Chill.

The Climate Control Drawer display will show the number of minutes (or minutes remaining) for the Express Chill mode selected on the control panel. The display will not show the temperature of the drawer. Refer to the Temperature Table for drawer temperatures.

Express Thaw

This feature thaws items by circulating warmed air throughout the drawer. Temperature is maintained in the drawer by cycling a small heater on and off as needed. The dampers will be closed during Express Thaw. The fan will be on at all times during Express Thaw.

When the Express Thaw cycle is complete, the drawer will automatically adjust to 30 °F.

The Climate Control Drawer display will show the number of hours (or hours remaining) for the Express Thaw mode selected on the control panel (.5 LBS = 4 HRS, 1.5 LBS = 8 HRS, 3 LBS = 12 HRS). The display will not show the temperature of the drawer. Refer to the Temperature Table for drawer temperatures.

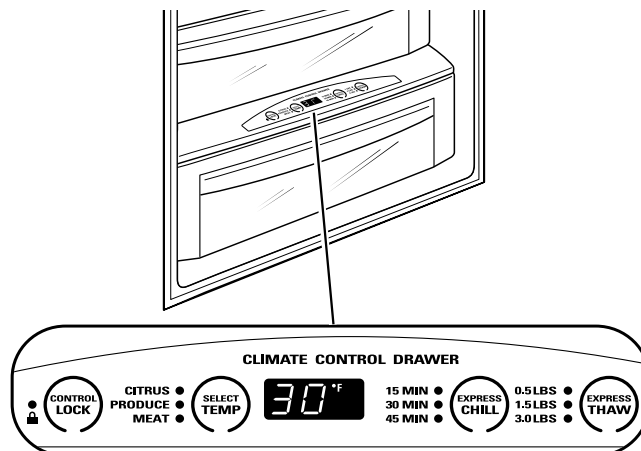

Temperature Table

When using the Temperature Table, please note the following:

- FF and FZ compartments should be within 3 °F of the temperature set point when checking drawer temperature.
- All temperatures listed are as measured by the thermistor and displayed by the Climate Control Drawer display.
- Actual drawer temperature will be displayed in Select Temp mode only. The Climate Control Drawer display will show the selected temperature for approximately 4 seconds after a Select Temp mode has been selected. After approximately 4 seconds, the actual temperature of the drawer will be displayed.
- The actual-temperature display is based on the temperature that the main control board sees from the thermistor. The selected-temperature (example: CITRUS – 43 °F) is based on the logic of the Climate Control Drawer control board. If the actual temperature that is displayed is incorrect, the thermistor and main control board are suspect. If the temperature associated with the Select Temp mode is incorrect, the Climate Control Drawer control board is faulty.

| EXPRESS THAW | | EXPRESS CHILL | | SELECT TEMP | |
|--------------|--------------------------|---------------|--------------------------|-------------|--------------------|
| MODE | TEMP | MODE | TEMP | MODE | TEMP |
| .5 LBS. | 42 to 46 °F ¹ | 15 MIN. | 25 °F ² | CITRUS | 43 °F ³ |
| 1.5 LBS. | 42 to 46 °F ¹ | 30 MIN. | 15 to 20 °F ² | PRODUCE | 34 °F ⁴ |
| 3 LBS. | 42 to 46 °F ¹ | 45 MIN. | 15 to 20 °F ² | MEAT | 32 °F ⁵ |

Note 1 Climate Control Drawer may take up to **1 hour and 45 minutes** to achieve temperature with no load in drawer (except metal tray) and minimal or no door openings. When the Express Thaw cycle is complete, the drawer will automatically adjust to 30 °F.

Note 2 Temperature should lower to **25 °F or less within 15 minutes** with no load in drawer (except metal tray) and minimal or no door openings. Temperature should lower to a temperature between **15 °F to 20 °F within 30 minutes** with no load in drawer (except metal tray) and minimal or no door openings. If refrigerator is defrosting, temperature in drawer may go below 15 °F.

Note 3 Climate Control Drawer may take up to **1 hour and 45 minutes** to achieve temperature with no load in drawer (except metal tray) and minimal or no door openings.

Note 4 Climate Control Drawer may take up to **1 hour** to achieve temperature with no load in drawer (except metal tray) and minimal or no door openings.

Note 5 Climate Control Drawer may take up to **45 minutes** to achieve temperature with no load in drawer (except metal tray) and minimal or no door openings.

Climate Control Drawer Top Panel (Mullion)

Removal

1. Remove 2 storage bins and the glass panel over Climate Control Drawer.
2. Remove 4 screws from climate control top and slide back to access wire connectors.
3. Disconnect the connectors and remove the top panel.

Note: Note that there is a Styrofoam insert in the slot at the back, right-hand corner of the top panel.

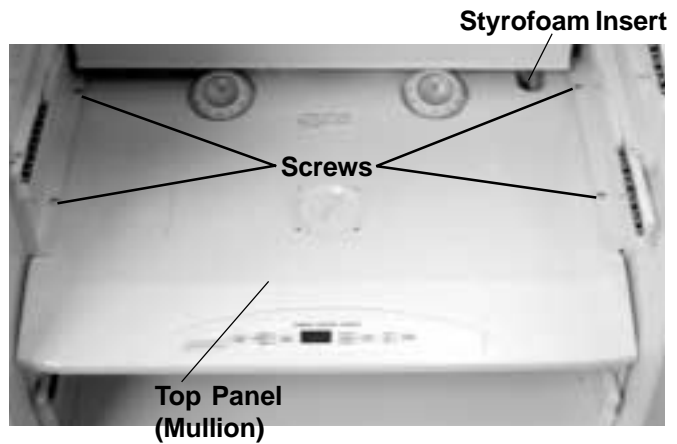

Control Board and Display

The control board and display are located in the Climate Control Drawer top panel (mullion). The control board and display are part of the mullion and cannot be replaced separately.

Input from the Climate Control Drawer's control board and the thermistor is used by the main control board to control the dampers, fan, and heater.

Actual drawer temperature will be displayed in Select Temp mode only. The Climate Control Drawer display will show the selected temperature for approximately 4 seconds after a Select Temp mode has been selected. After approximately 4 seconds, the actual temperature of the drawer will be displayed.

The actual-temperature display is based on the temperature that the main control board sees from the thermistor. The selected temperature (example: CITRUS – 43 °F) is based on the logic of the Climate Control Drawer control board. If the actual temperature that is displayed is incorrect, the thermistor and main control board are suspect. If the temperature associated with the Select Temp mode is incorrect, the Climate Control Drawer control board is faulty.

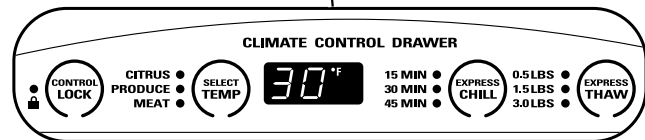
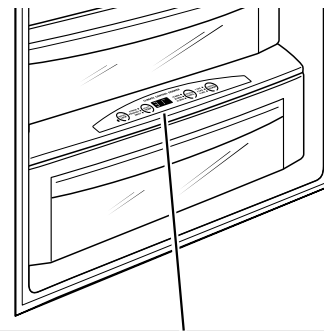

Caution: When assembling the top panel, use care to prevent pinched wires.

Troubleshooting

Use this diagnostic flowchart if the Climate Control Drawer control panel and display are not operating properly.

If the problem is drawer temperature and the control panel and display appear to be operating normally, check the thermistor, damper, fan, and heater first.

If the actual drawer temperature displayed is incorrect, suspect the thermistor and main control board.

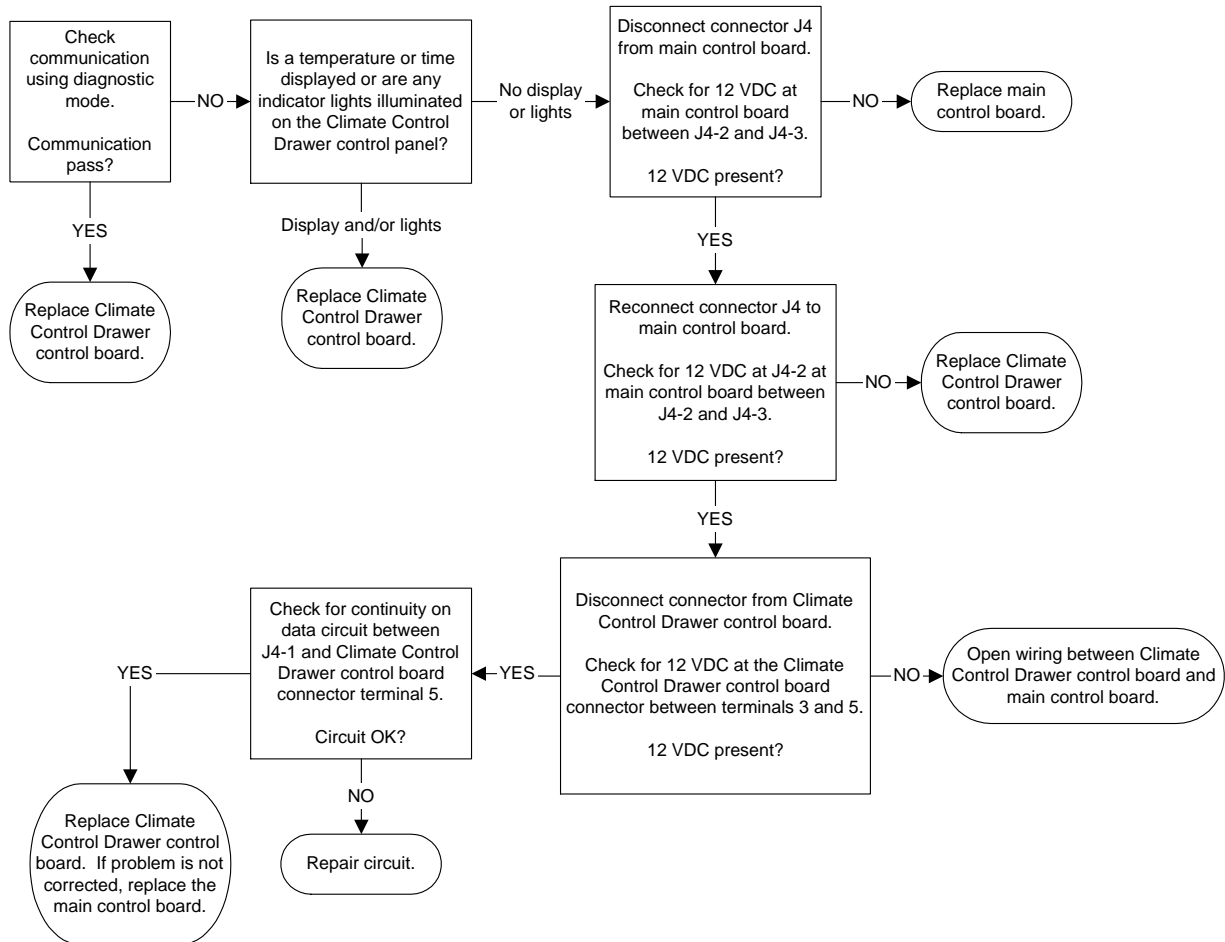

9-Pin Connector Behind Climate Control Drawer

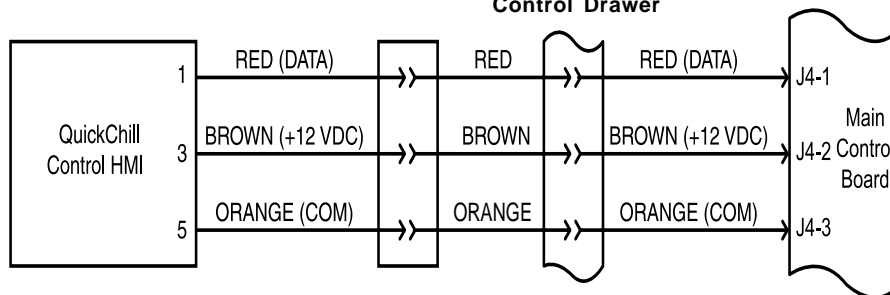

Fan and Fan Housing

The 12 VDC fan is controlled by the main control board. The main control board turns the fan on and off based on input from the Climate Control Drawer control board and thermistor. The fan should always come on any time Express Chill or Express Thaw is selected.

Troubleshooting

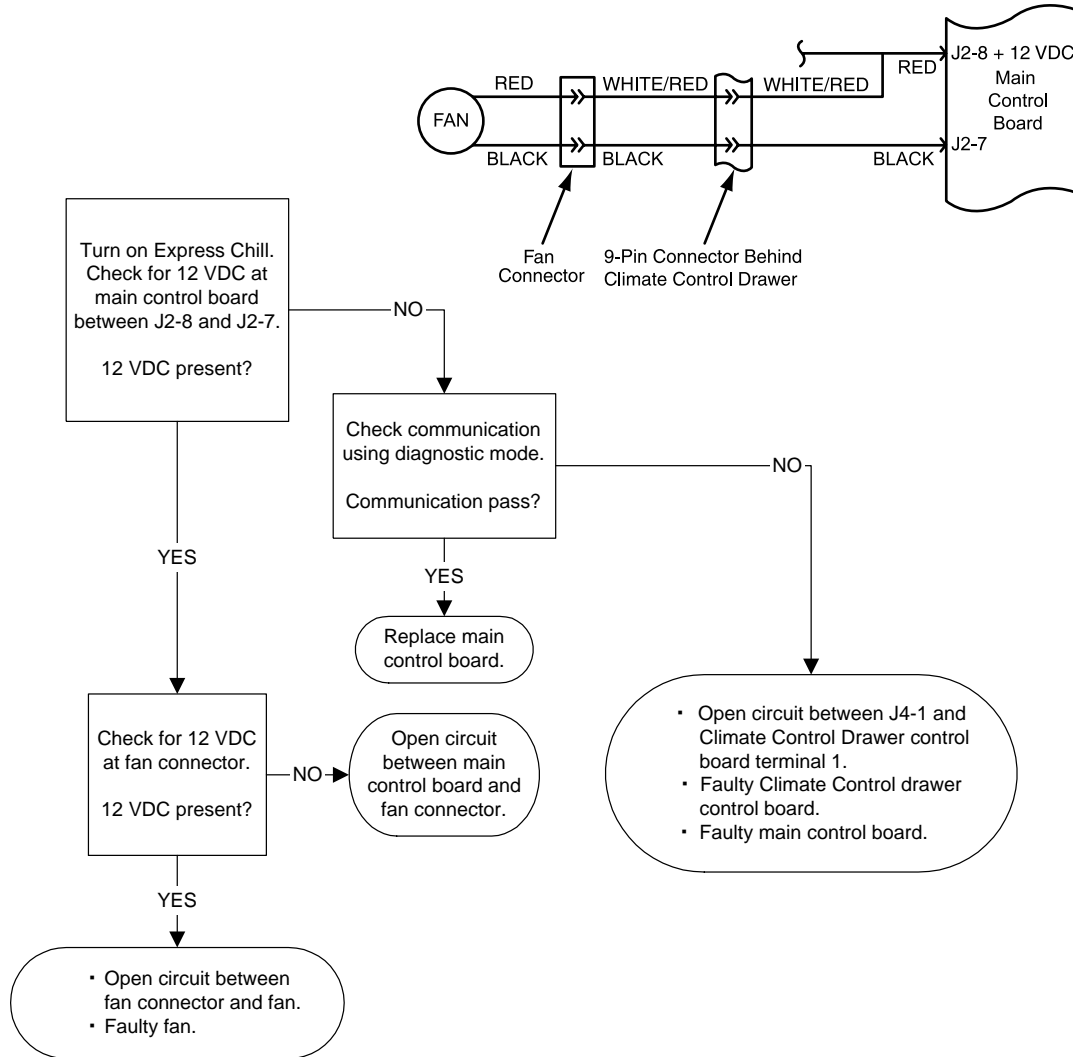

Removal

1. Remove Climate Control Drawer top panel.
2. Loosen 2 bottom screws, remove 2 top screws, and remove air diffuser from fan housing.

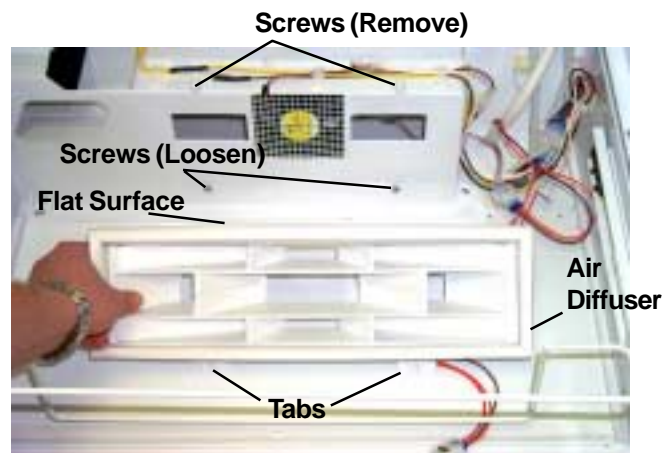

3. This step for fan removal only: Remove screen from front of fan and fan from housing.
4. Remove 2 screws and the sheet metal cover from the right-hand side of the housing.
5. Disconnect fan connector.
6. This step for fan removal only: Cut fan wires at fan to remove.

Note: When installing new fan, fan wires do not have to be installed under plastic wire holders.

7. Disconnect heater connector and 9-pin connector.
8. Remove 5 screws and fan housing from fresh food compartment.

Note: When installing the diffuser onto the fan housing, the tabs must be on the bottom and the flat surface must be on top. Incorrect installation will prevent the drawer from cooling and warming properly.

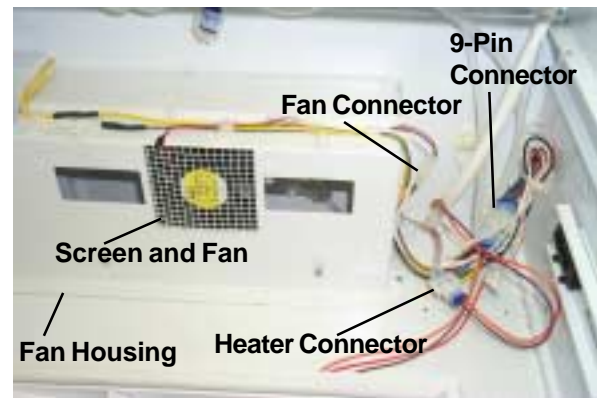

Dampers

Caution: Do not manually move damper door. Manually moving damper door will damage damper.

The dampers are located between the fan housing and the center mullion. The fan housing must be removed from the fresh food compartment to replace the dampers.

Both dampers always operate at the same time. The upper damper can be viewed from the Climate Control Drawer compartment. The lower damper can be viewed from the freezer compartment. Dampers will be closed during Express Thaw and will be open during Express Chill.

The main control board opens and closes the damper based on input from the Climate Control Drawer control board and the thermistor.

After selecting **Express Thaw**, 12 VDC are output from the main control board for approximately 4 seconds to close the damper. This voltage can be measured at the following points:

- Main control board J5-2 to J5-1 with positive (red) test meter lead on J5-2.
- 9-pin connector behind Climate Control Drawer. Check from gray wire to yellow wire with positive (red) test meter lead on gray wire.

After selecting **Express Chill**, 12 VDC are output from the main control board for approximately 4 seconds to open the damper. This voltage can be measured at the following points:

- Main control board J5-1 to J5-2 with positive (red) test meter lead on J5-1.
- 9-pin connector behind Climate Control Drawer. Check from yellow wire to gray wire with positive (red) test meter lead on yellow wire.

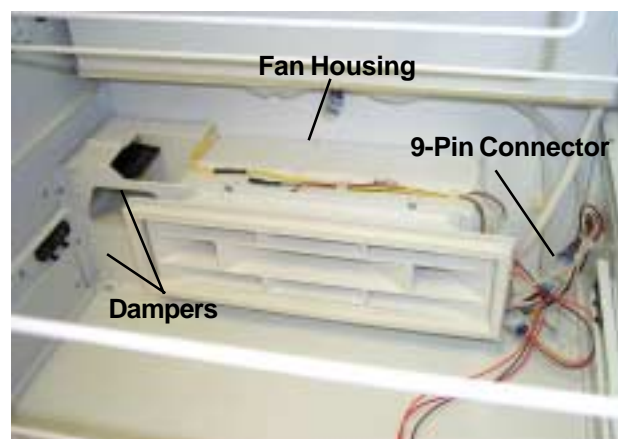
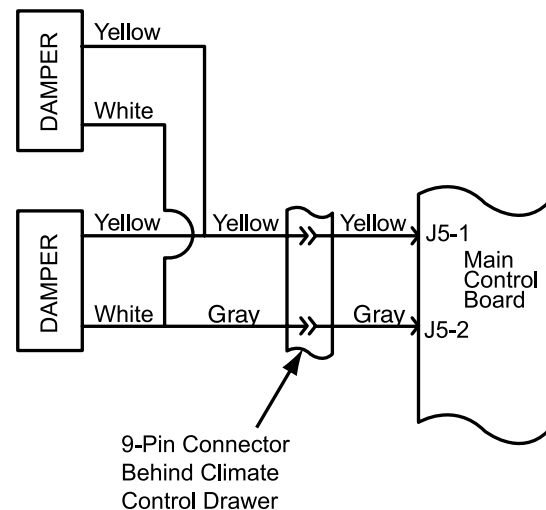

Heater

The 120 VAC heater is located in the fan housing. The fan housing must be removed from the fresh food compartment to access the heater.

The heater is controlled by the main control board. The main control board turns the heater on and off based on input from the Climate Control Drawer control board and the thermistor.

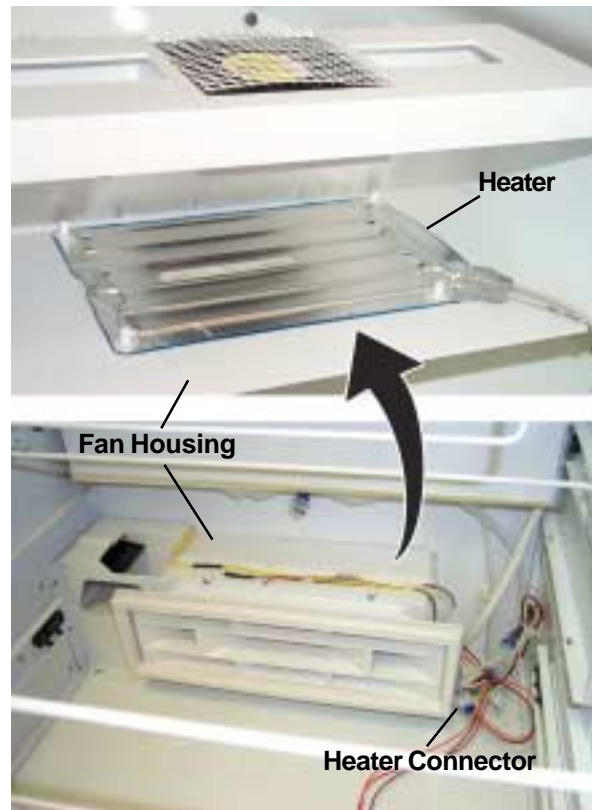
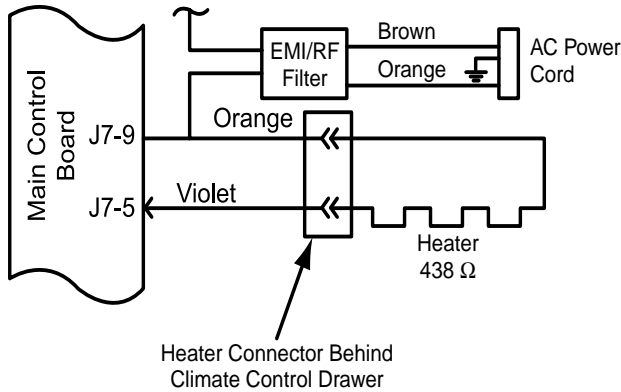

Heater resistance should be 438Ω and can be checked at 2 places:

- J7-5 to J7-9 at main control board. Connector J7 should be disconnected from main control board when checking resistance.
- Heater (2-pin) connector located behind the Climate Control Drawer. Connector should be disconnected when checking resistance.

The heater can usually be turned on by entering any of the Quick Thaw modes.

120 VAC output to the heater can be checked at 2 places:

- J7-5 to J7-9 at main control board.
- Heater (2-pin) connector located behind the Climate Control Drawer.

Thermistor

The thermistor is clipped to the inside of the fan housing.

The main control board controls the dampers, fan, and heater based on input from the Climate Control Drawer's control board and the thermistor.

Actual drawer temperature will be displayed in Select Temp mode only. The Climate Control Drawer display will show the selected temperature for approximately 4 seconds after a Select Temp mode has been selected. After approximately 4 seconds, the actual temperature of the drawer will be displayed.

The actual-temperature display is based on the temperature that the main control board sees from the thermistor. The selected temperature (example: CITRUS – 43 °F) is based on the logic of the Climate Control Drawer control board. If the actual temperature that is displayed is incorrect, the thermistor and main control board are suspect. If the temperature associated with the Select Temp mode is incorrect, the Climate Control Drawer control board is faulty.

All thermistors can be checked using Diagnostic Mode.

Access

After removing the diffuser, the thermistor can be accessed through the hole on the right-hand side of the fan. After removing the thermistor from the clip (on the inside of the fan housing), the thermistor can be removed from the fan housing through the hole in the top of the housing.

Note: When installing the diffuser onto the fan housing, the tabs must be on the bottom and the flat surface must be on top. Incorrect installation will prevent the drawer from cooling and warming properly.

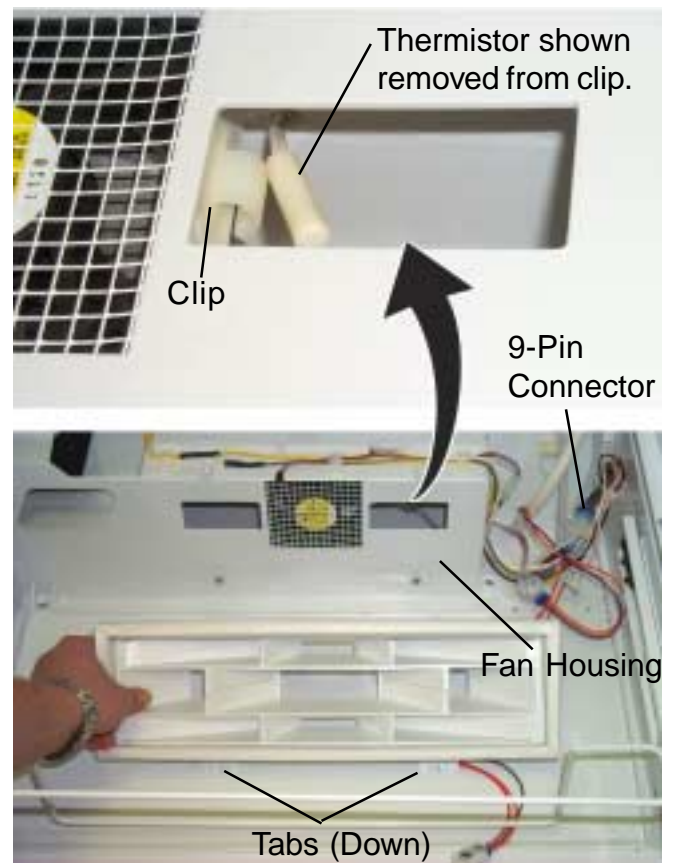

Note: All thermistors can be checked using Diagnostic Mode.

Refer to the Thermistor Values chart for resistance values. Thermistor resistance can be checked at 2 places:

- J5-5 to J5-6 at main control board. Connector J5 should be disconnected from main control board when checking resistance.
- 9-pin connector located behind the Climate Control Drawer. Connector should be disconnected when checking resistance.

5 VDC output to the thermistor can be checked at 2 places:

- J5-5 to J5-6 at main control board.
- 9-pin connector located behind the Climate Control Drawer.

| Thermistor Values | | |
|-------------------------|-------------------------|-------------------------|
| Temperature Degrees (C) | Temperature Degrees (F) | Resistance in Kilo-ohms |
| -20 | -4 | 48.4 k Ω |
| -10 | 14 | 27.6 k Ω |
| 0 | 32 | 16.3 k Ω |
| 10 | 50 | 10 k Ω |

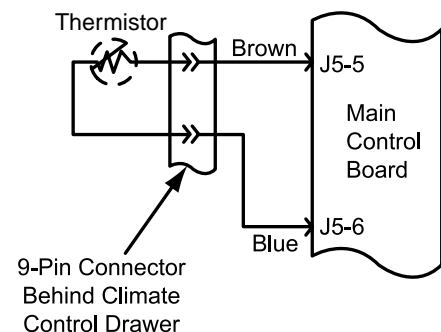

Air Flow

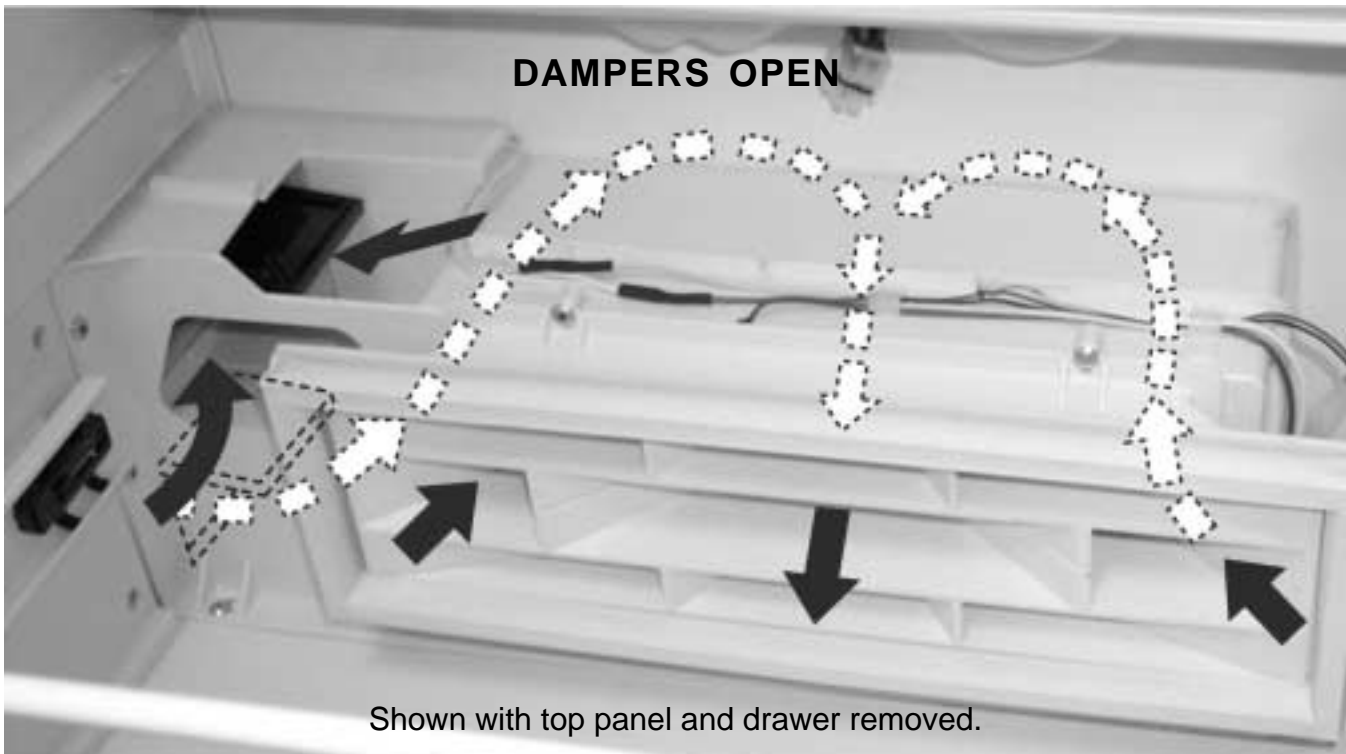

With the dampers open, cold air moves from the FZ compartment through the lower damper and into the fan housing. The fan blows the cold air through the diffuser into the drawer. The air returns from the drawer through the diffuser and into the fan housing. Air also moves over the top of the drawer, into the Climate Control Drawer compartment (not into the FF compartment), and then out of the compartment via the top damper.

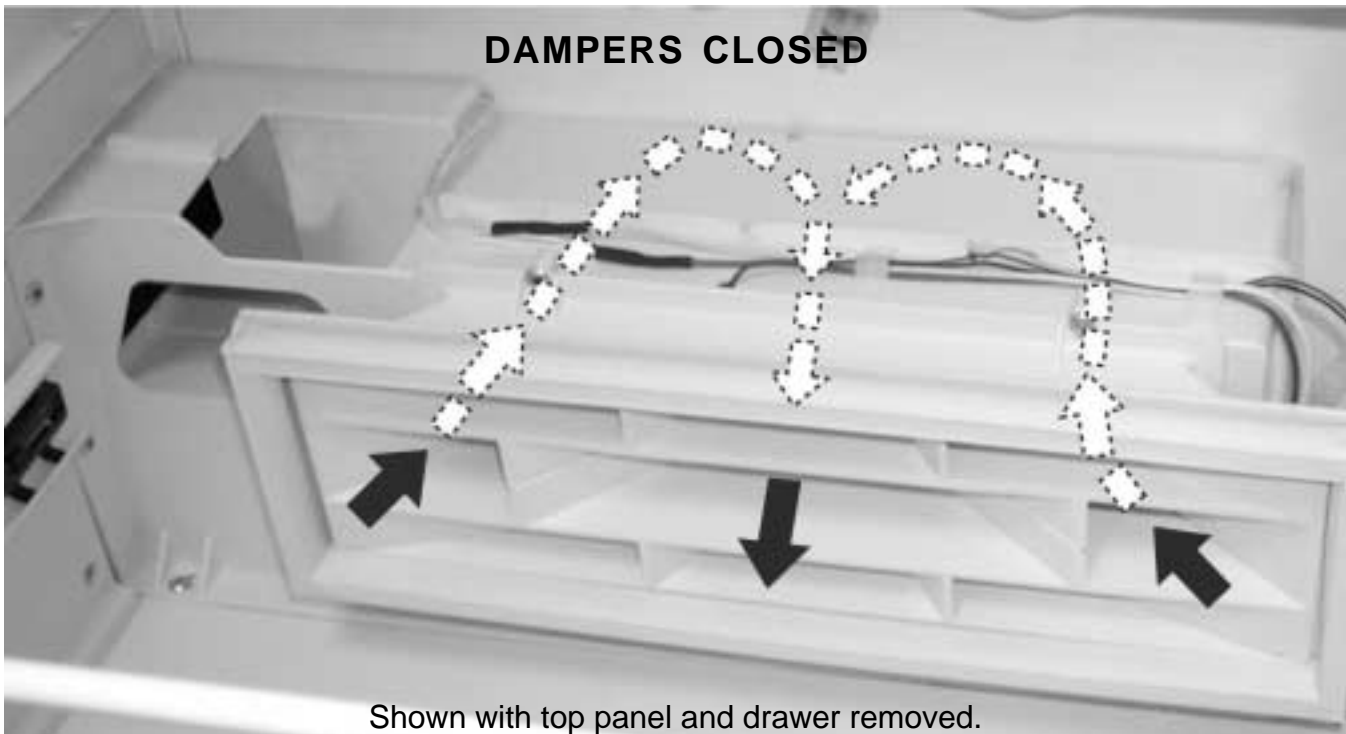

With the dampers closed, the fan moves air from the fan housing, through the diffuser, to the drawer. Air returns from the drawer, through the diffuser, to the fan compartment.

Compartment Lights

The new Monogram side-by-side refrigerator uses 12 VAC halogen lights in both the fresh food and freezer compartments. The fresh food compartment is equipped with two 35-watt bulbs and five 20-watt bulbs producing a total of 170 watts. The freezer compartment is equipped with two 35-watt bulbs producing a total of 70 watts. Power is supplied to all interior lighting by 2 transformers. The transformers convert 120 VAC to 12 VAC.

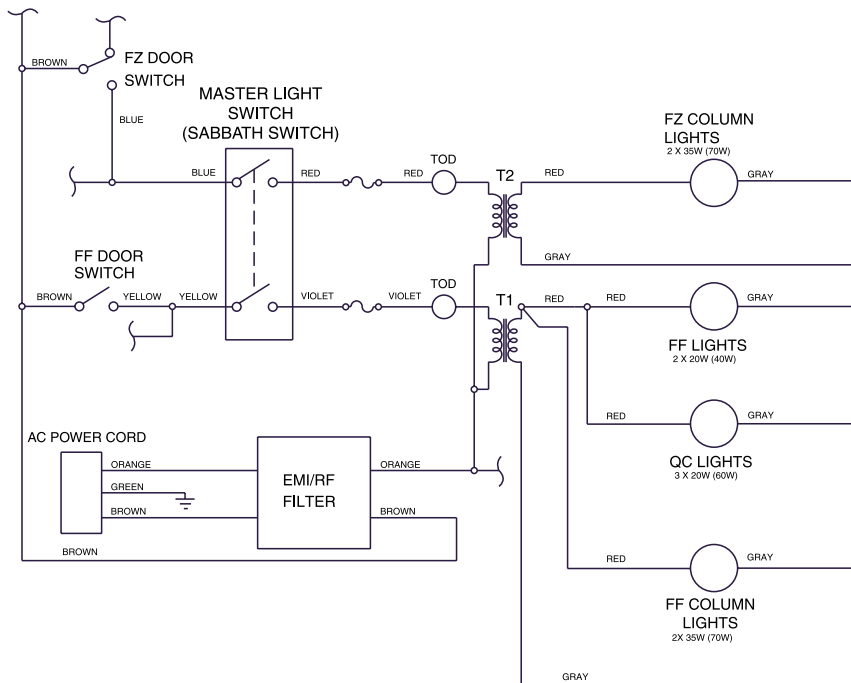

GEA01266

FF/FZ Compartment Lights Diagnostic

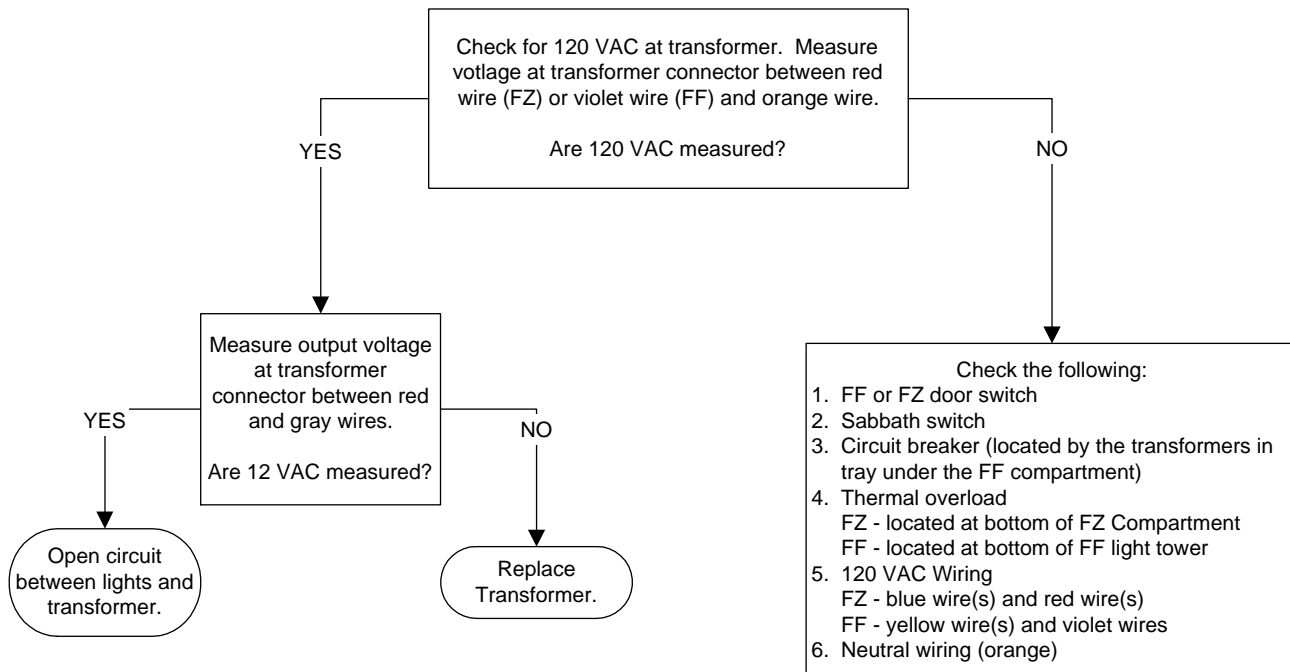

Door Switches

The fresh food and freezer door switches are located at the top of the fresh food and freezer compartments.

The fresh food door switch closes when the door is open, providing L1 to the fresh food compartment light transformer.

The freezer door switch is a dual-pole switch. It provides L1 to the main control board when the freezer door is closed. When the freezer door is open, the switch provides L1 to the freezer compartment light transformer.

Master Light Switch (Sabbath Switch)

The master light switch is located behind the grille panel, on the main control board cover. The switch will open the circuits between the door switches and the transformers, disabling both transformers and stopping voltage output to the interior lights.

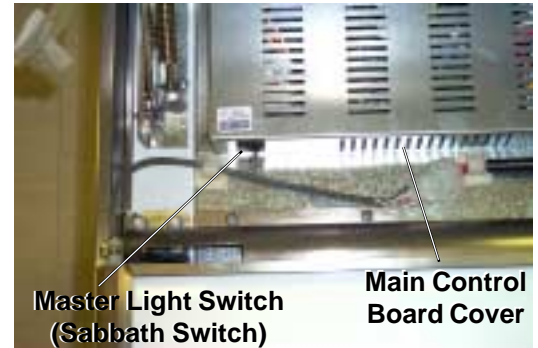

Temperature Overload Device (TOD)

A temperature overload device is wired in series with both the fresh food and freezer compartment transformers. If the interior lights should reach excessive temperatures due to a door being open for an extended period, the corresponding TOD will open the circuit that supplies 120 VAC to the transformer. The TOD will open at 150 °F and close at 90 °F.

The freezer TOD is located behind a metal cover on the back wall of the freezer compartment, at the base of the light tower. The fresh food TOD is located on the back wall of the fresh food compartment, at the base of the light tower.

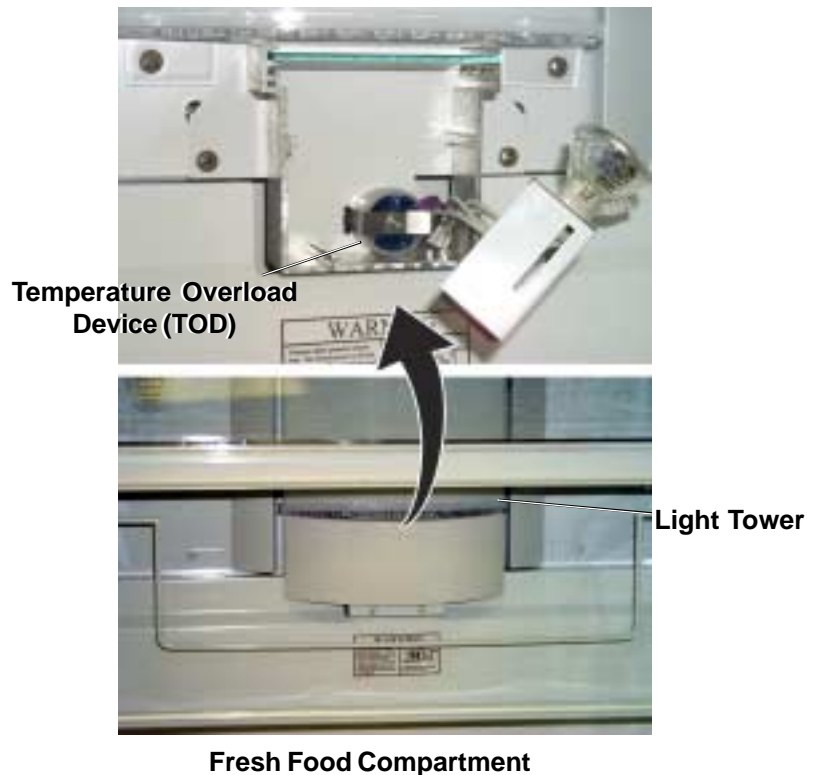
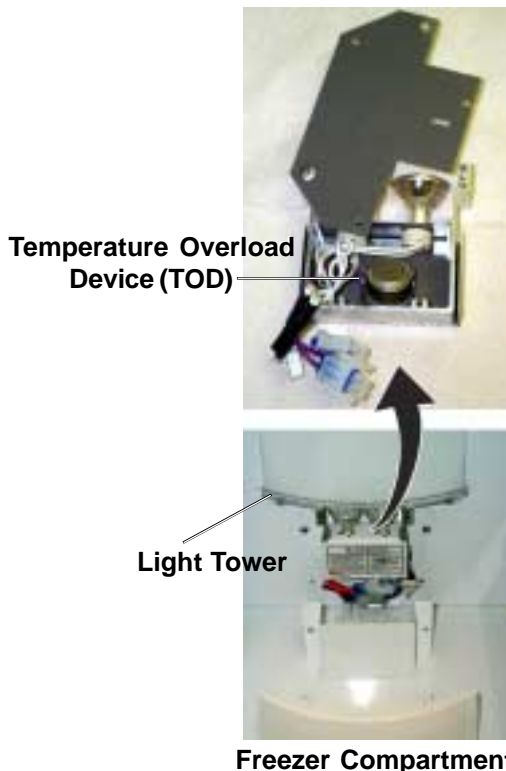

Circuit Breakers

Two resettable circuit breakers are located on the front of the transformer tray. Should a circuit breaker trip (open), it will open the transformer circuit it is associated with (freezer compartment or fresh food compartment), disabling that transformer and stopping voltage output to the interior lights.

Transformers

Power is supplied to all interior lighting by 2 transformers. One transformer is used for each compartment. The transformers supply low-voltage power to the lights by converting 120 VAC into 12 VAC.

The transformers are located in a tray under the center of the refrigerator. The tray is accessible from the front of the refrigerator. To access the transformers, lift up on the front of the tray and pull out.

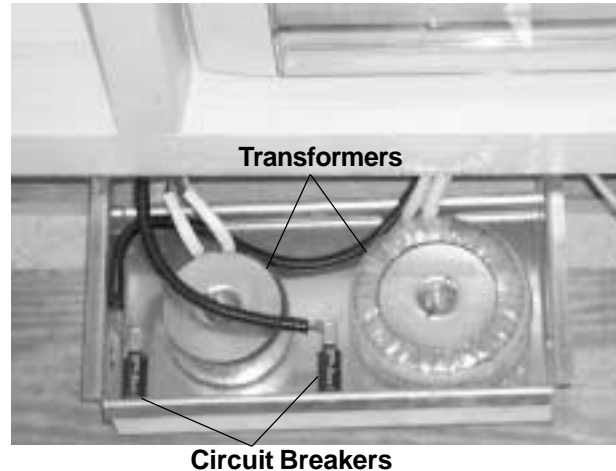

Light Bulb Replacement

WARNING: Halogen lights generate intense heat. Be certain power is **off** and lamps have sufficient time to **cool** before attempting to replace.

Note: The Styrofoam protector in the light lens is for shipping and must be removed prior to installation.

Power to the lamps can be turned off at the Sabbath switch, located behind the grille panel at the top of the refrigerator.

Note: Turning the temperature control to the OFF position does **NOT** remove power to the light circuits.

The refrigerator uses 2 types of halogen bulbs:

Type 1

The columns along the back wall of the fresh food and freezer compartments are lit up by lamps located behind the top pan in the fresh food compartment and the bottom basket in the freezer compartment. Type 1 bulbs are 35-watt and have a life expectancy of about 3500 hours.

Type 2

These lamps are located inside the light shield at the top of the fresh food compartment and on top of the Climate Control drawer at the bottom of the fresh food compartment. Type 2 bulbs are 20-watt and have a life expectancy of about 2000 hours.

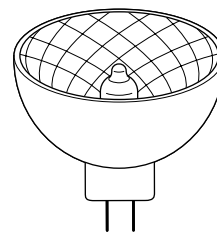
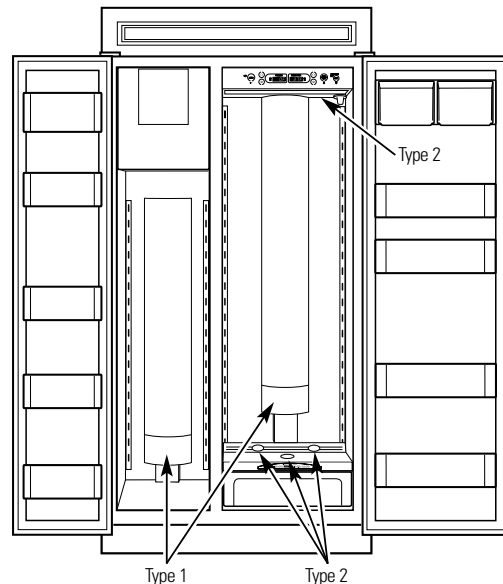

Type 1

This is a 35 watt, 12 volt, Type **MR11** bulb.
If ordering through
GE Parts and Accessories,
order part WR02X11183.



Type 2

This is a 20 watt, 12 volt, Type **T** bulb.
If ordering through
GE Parts and Accessories,
order part WR02X11184.

Type 1 Bulb Replacement

WARNING: Halogen lights generate intense heat. Be certain power is **off** and lamps have sufficient time to **cool** before attempting to replace.

1. Set the master light switch to the OFF position and allow the lamps to cool.
2. To access the lamps in the fresh food compartment, remove the top pan.
3. Grasp each end of the curved light shield and pull the shield toward you to remove.
4. Remove the glass above the bulbs by pulling it straight out.

Note: Always follow bulb manufacturer's directions for handling and replacing bulbs.

5. Remove the bulb by holding the base and pulling straight up. Replace with a new bulb.
6. Replace the glass by sliding it into place. Then, replace the light shield by resting the top lip of the shield on top of the light housing. Then, press the sides until the tabs pop into the slots in the housing.

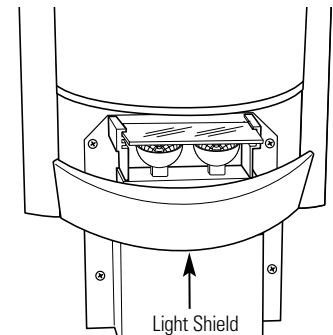

WARNING: The light shield must be replaced, or the heat from the bulb could damage the refrigerator.

Type 2 Bulb Replacement

WARNING: Halogen lights generate intense heat. Be certain power is **off** and lamps have sufficient time to **cool** before attempting to replace.

1. Set the master light switch to the **OFF** position and allow the lamps to cool.
2. If a water filter cartridge is installed, remove it and replace with a filter bypass plug.
3. Holding the light shield with one hand, rotate the support tabs until they clear the front of the light shield. Then, push back on the light shield, lower the shield at the front, and take out.
4. Remove the 4 screws securing the light housing to the ceiling. There are two screws at the front and two at the back.
5. Lower the light housing at the front, then pull it toward you so the tabs at the back of the light housing come out of the slots on the back wall. The lamp assemblies will release from the holders.

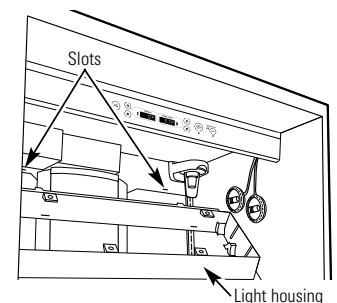
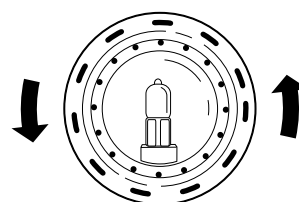
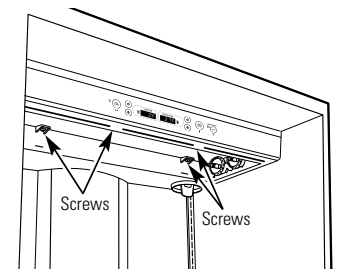
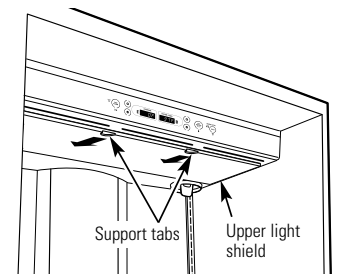

6. Turn the lamp protector to access the bulb.

Note: Always follow bulb manufacturer's directions for handling and replacing bulbs.

7. Remove the bulb by holding the base and pulling straight out. Replace with a new bulb and replace the lamp protector.

WARNING: Lamp protectors must be replaced, or the heat from the bulb could damage the refrigerator.

8. Holding up the light housing, place each lamp assembly in its holder. Feed the attached wires through the slots and tuck the wires outside the side of the light housing.

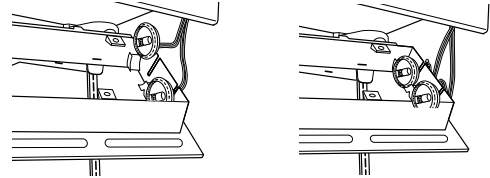

9. Insert the tabs on the back of the light housing in the slots on the back wall. Raise the light housing into position and secure with the four screws.

10. Replace the light shield and rotate the support tabs back out to support the front of the shield.

11. Remove the filter bypass plug and replace with the water filter cartridge. Reset the Sabbath switch to the ON position.

Climate Control Drawer Type 2 Bulb Replacement

WARNING: Halogen lights generate intense heat. Be certain power is **off** and lamps have sufficient time to **cool** before attempting to replace.

1. Set the master light switch to the **OFF** position and allow the lamps to cool.
2. To access the lamps, remove the second produce pan.
3. The lamps at the back, which face up, can be lifted out. To access the lamp that shines into the Climate Control drawer, twist the holder until the arrow points toward the back of the refrigerator, then lift up.

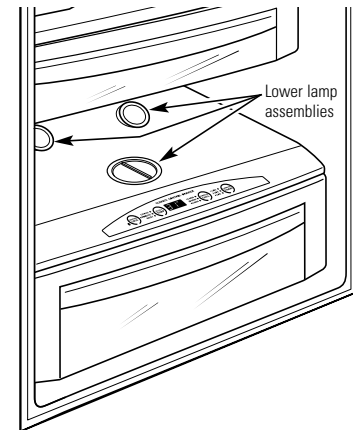
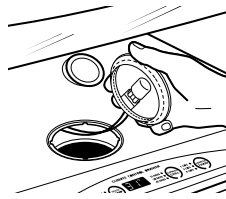

4. Turn the lamp protector to access the bulb.

Note: Always follow bulb manufacturer's directions for handling and replacing bulbs.

5. Remove the bulb by holding the base and pulling straight out. Replace with a new bulb and replace the lamp protector.

WARNING: Lamp protectors must be replaced, or the heat from the bulb could damage the refrigerator.

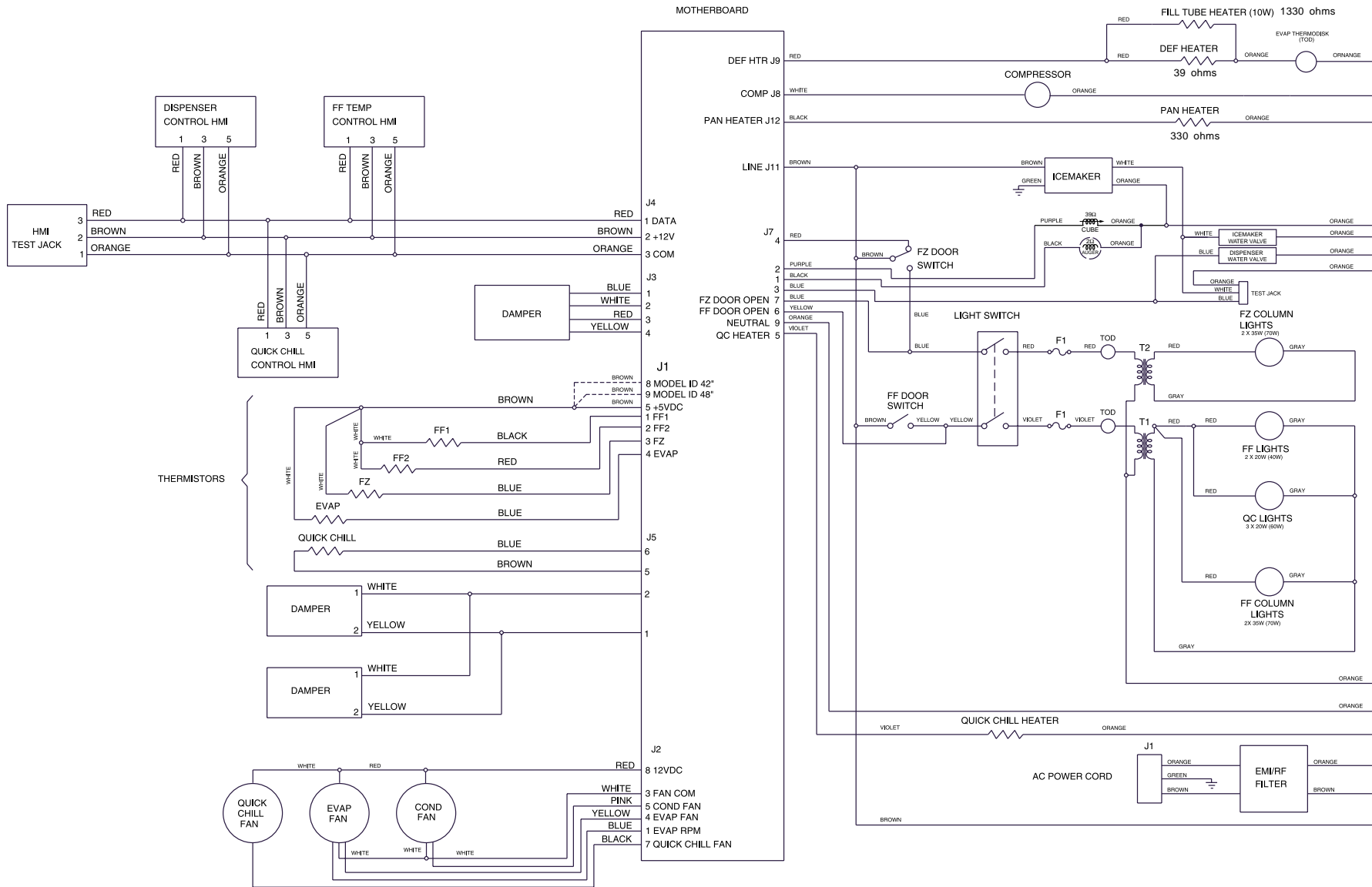

Schematic

Note: Climate Control Drawer is referred to as Quick Chill.

Refrigeration System

The major components of the refrigeration system are a reciprocating-type compressor, condenser, condenser loop, dryer, and evaporator. These components, except for the condenser loop, are all replaceable separately.

Compressor

The compressor is a reciprocating type. Refer to the mini-manual for the BTU/hour rating and the compressor capacity test specification.

A copper process tube is provided for access to the low-pressure side of the refrigeration system.

Note: The woodpecker clip holds the capillary tube in thermal contact with the compressor discharge tube. If the capillary tube is not clipped to the discharge tube, a knocking noise may occur during compressor operation.

Refer to the compressor replacement instructions included with the replacement compressor.

Condenser

The condenser is located behind the grille panel at the top of the refrigerator and is made of copper tubing. The outlet of the condenser is connected to a copper jumper tube that is connected to the inlet of the condenser loop. In a normal home environment, there is no need for routine condenser cleaning. However, in environments that may be particularly dusty or greasy, the condenser should be cleaned periodically for efficient refrigeration operation. An ordinary appliance brush should be all that is needed. Functionally, the condenser does the same job as previous models. Air is drawn through the condenser by the condenser fan from the front left and rear left of the machine compartment. Air exits only from the right side of the machine compartment.

Condenser Loop

The condenser loop, made of copper tubing, is foamed in place behind the breaker frame on the freezer compartment side. It is not accessible for replacement. The tubing is routed from the machine compartment, forwarded to the mullion, down to the freezer compartment, around the front perimeter of the freezer, and back into the machine compartment. The outlet of the condenser loop is connected to the dryer inlet.

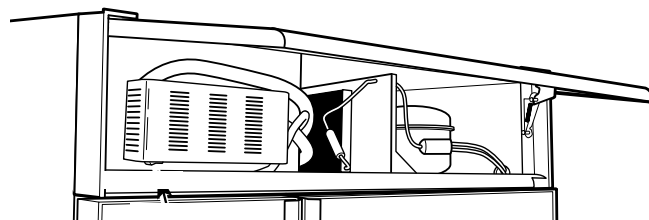
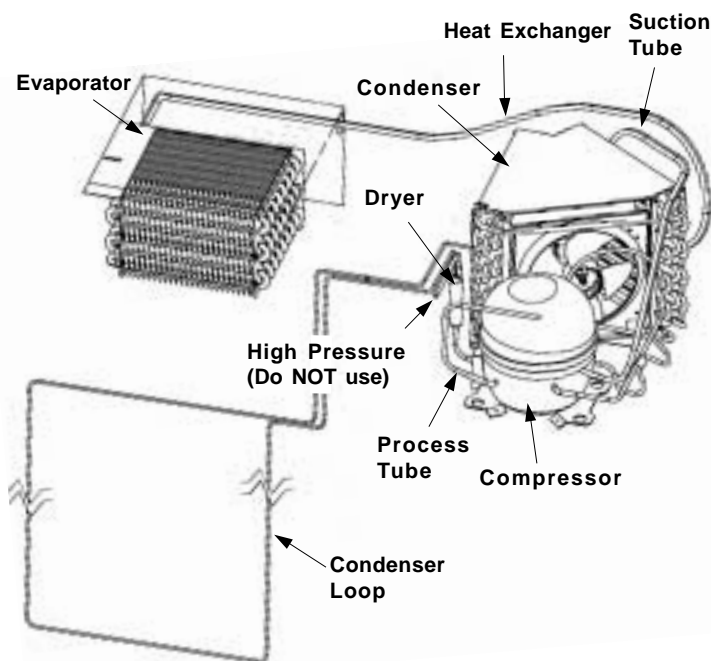

Dryer

The dryer is positioned vertically in the center of the machine compartment. A copper process tube, connected to the inlet of the dryer, provides access to the high-pressure side of the refrigeration system. The capillary is connected to the outlet of the dryer. Replacement of filter dryer requires additional refrigerant when installed (0.5 oz).

Evaporator

The evaporator is made of copper and aluminum and is located above the evaporator fan at the top of the freezer compartment.

To replace the evaporator

1. Recover the refrigerant.
2. Remove the evaporator fan (see procedure).
3. Remove the defrost heater (see procedure).
4. Remove the defrost overtemperature thermodisk and evaporator thermistor.
5. Disconnect the ground wire from the evaporator and position all wiring to allow for evaporator removal.
6. Remove the screws securing the evaporator to the cabinet.

Caution: Protect wiring from heat during desoldering and resoldering.

7. Desolder the capillary tube from the evaporator.
8. Desolder the suction line.
9. Remove the evaporator.
10. Using a file, score the capillary tube just above the old solder and break the solder-covered section off. This will help prevent the capillary tube from becoming plugged when resoldering.
11. Position the new evaporator in the cabinet. Insert the suction line and capillary tube into the evaporator.
12. Solder the suction line to the evaporator using silfos.
13. Solder the capillary tube to the evaporator using silfos.
14. Install a replacement dryer.
15. Evacuate and recharge the system using currently accepted procedures.

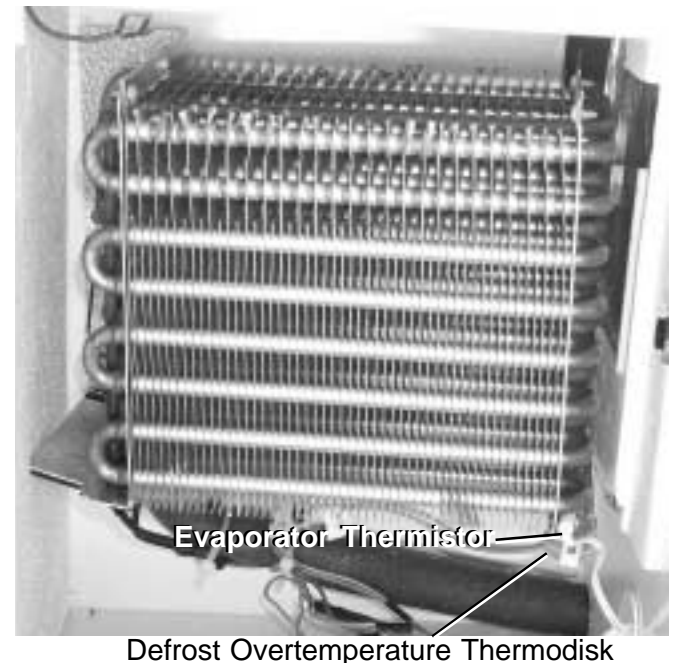
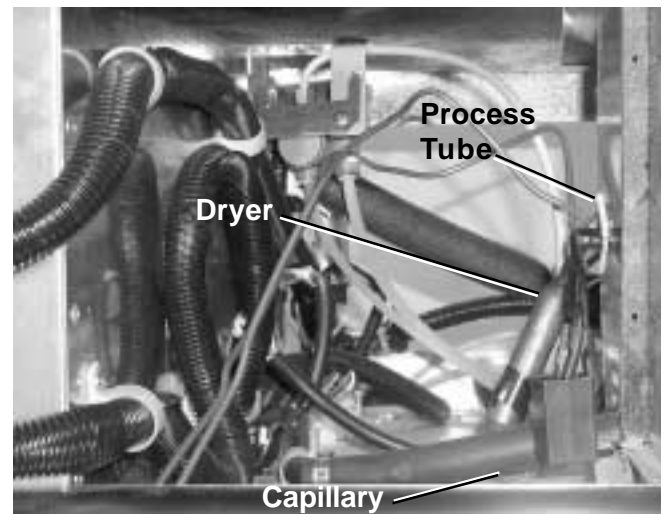

Refrigerant Charge

The refrigerant used in this model is type R134a. Refer to the mini-manual or model tag for the exact refrigerant charge quantity.

Diagnostic Mode

Enter the diagnostic mode by pressing both the freezer temperature pads (plus and minus) and the refrigerator temperature pads (plus and minus) simultaneously. All 4 pads must be held for approximately 3 seconds. Blinking "0's" in both displays indicate the refrigerator has entered the test mode.

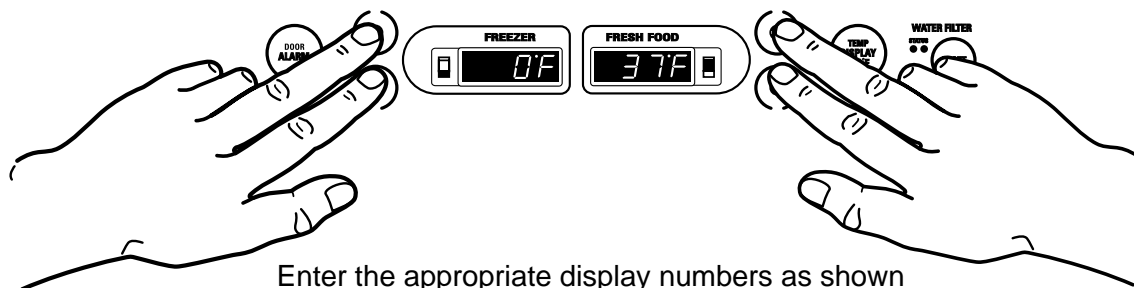

Enter the appropriate display numbers as shown below and press any pad other than the temperature pads to activate that test mode.

| Freezer Display | Fresh Food Display | Diagnostics | Results | Comments |
|-----------------|--------------------|---|---|--|
| 0 | 1 | Showroom Mode. | Unit in showroom mode. | FF door must be closed and reopened to start showroom mode. |
| 0 | 2 | Communication check between temperature control and main control board. | "P" on FZ display if OK. "F" on FZ display means problem is found. | |
| 0 | 3 | Communication check between temperature control and dispenser. | "P" on FZ display if OK. "F" on FZ display means problem is found. | |
| 0 | 4 | Communication check between dispenser and main control board. | "P" on FZ display if OK. "F" on FZ display means problem is found. | |
| 0 | 6 | HMI (temperature control) Self Test. | All LED's and numeric segments will illuminate. | When "Express Thaw" pad is pressed "Express Thaw" LED's will turn off. When "Express Chill" pad is pressed "Express Chill" LED's will turn off. |
| 0 | 7 | Control and Sensor System Self Test. | Checks each thermistor and displays "P" for pass and "0" for fail. | See note 1 below. |
| 0 | 8 | Open Duct Door. | Duct door opens for 10 seconds then closes. | |
| 0 | 9 | Dispenser Recess Heater Test. | Turns the dispenser recess heater on for 60 seconds. | |
| 1 | 0 | Dampers Test. | Each damper will open, pause briefly, then close. | |
| 1 | 2 | 100% Run Time. | Sealed system on 100% of the time. Times out after 1 hour. | Cannot be entered if refrigerator is set to off. |
| 1 | 3 | Pre-chill Test. | Starts pre-chill mode. Unit returns to normal on its own. | Cannot be entered if refrigerator is set to off. |
| 1 | 4 | Defrost Test. | Toggles the defrost cycle. See note 2 below. | Must press again to turn heaters off. Cannot be entered if refrigerator is set to off. See note 2 below. |
| 1 | 5 | Main Control Reset. | Causes a system reset. | |
| 1 | 6 | Exit Diagnostic Mode. | Causes a temperature control board reset. | |
| 1 | 7 | Degree C/F. | Changes temperature display from F to C. | |

Note 1: Display order is: 1) Fresh Food 1, 2) Fresh Food 2, 3) Custom Cool, 4) Evaporator, 5) Freezer. Thermistor test results are P = pass, 0 = fail, S = short to 5 VDC, B = bad amplifier (replace main control).

Note 2: You must enter the defrost test again to toggle the defrost heater off at the end of the test. The heater will not come on if the evaporator thermistor or overtemperature thermodisc is warm.

Diagnostic Flowcharts

Fresh Food Warm - Freezer Normal

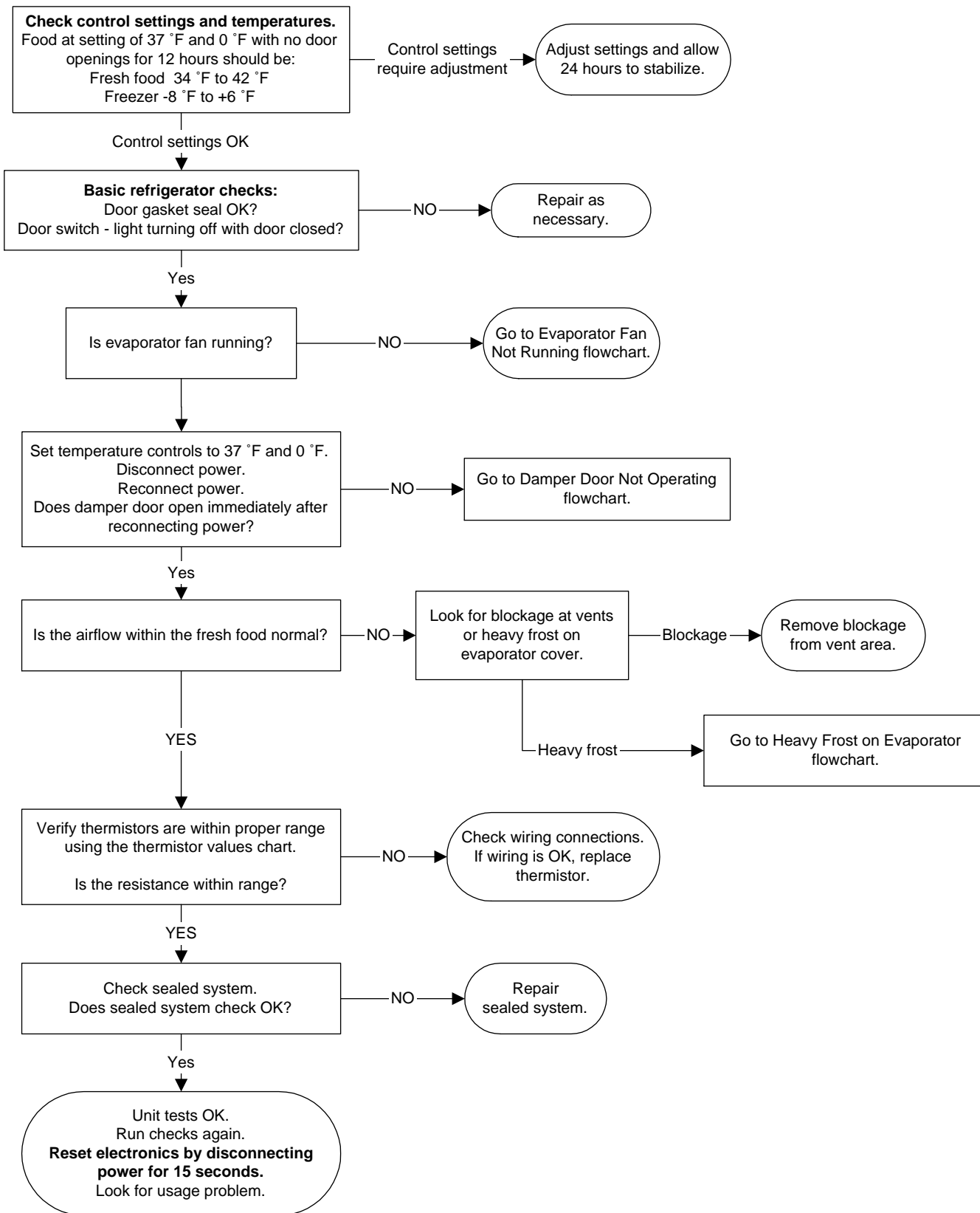

Fresh Food Too Cold - Freezer Normal

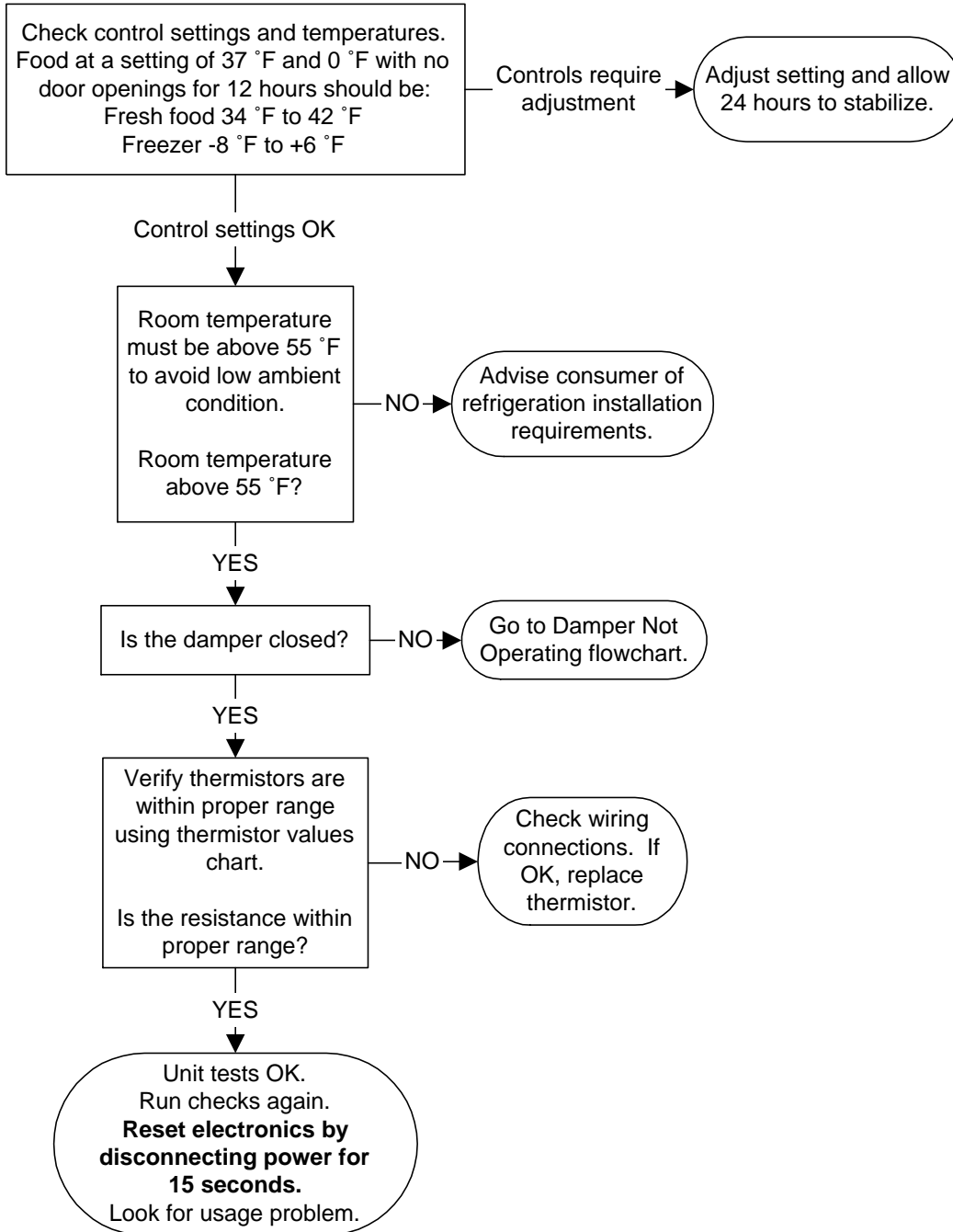

Fresh Food Warm - Freezer Warm

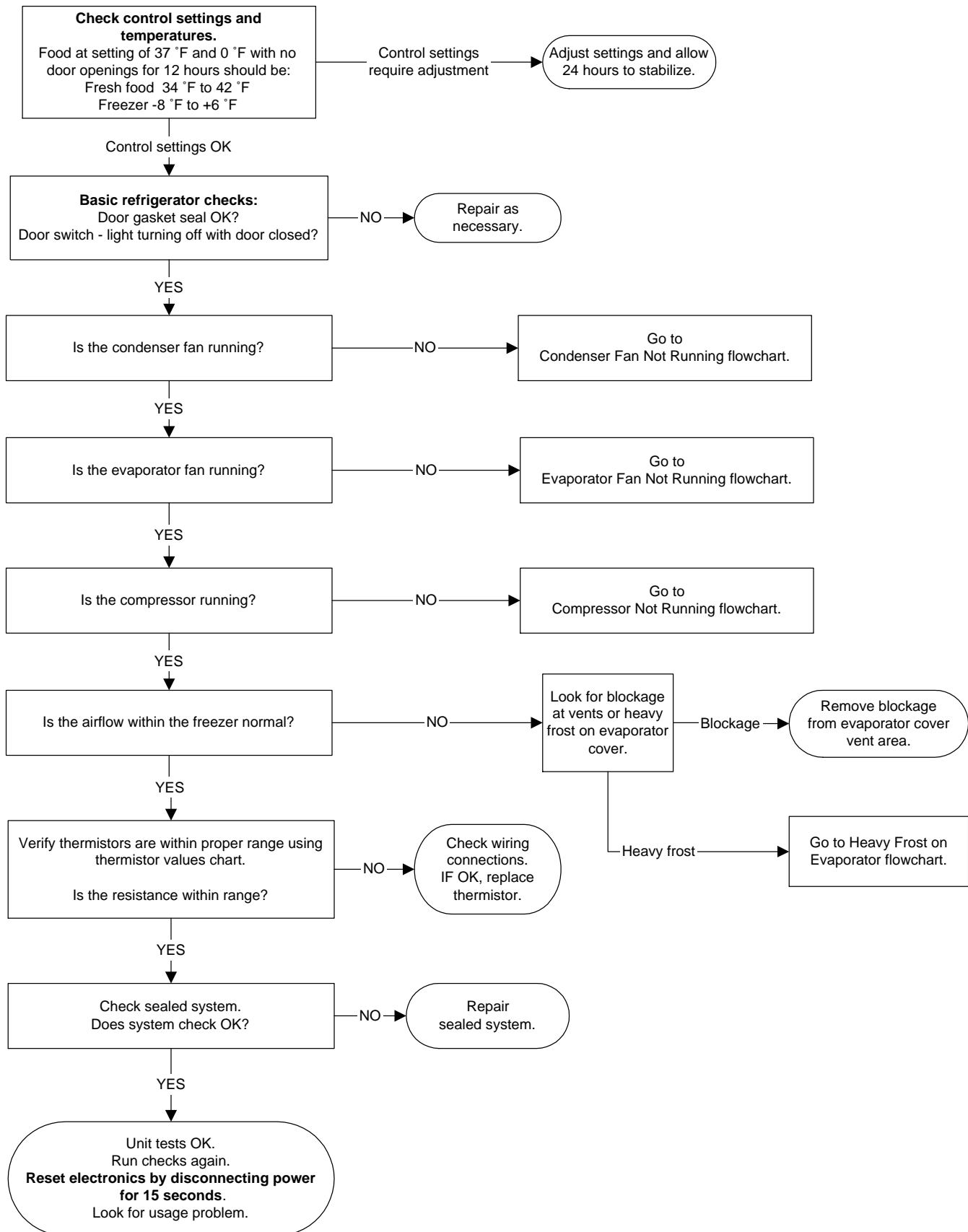

Freezer Warm - Fresh Food Normal

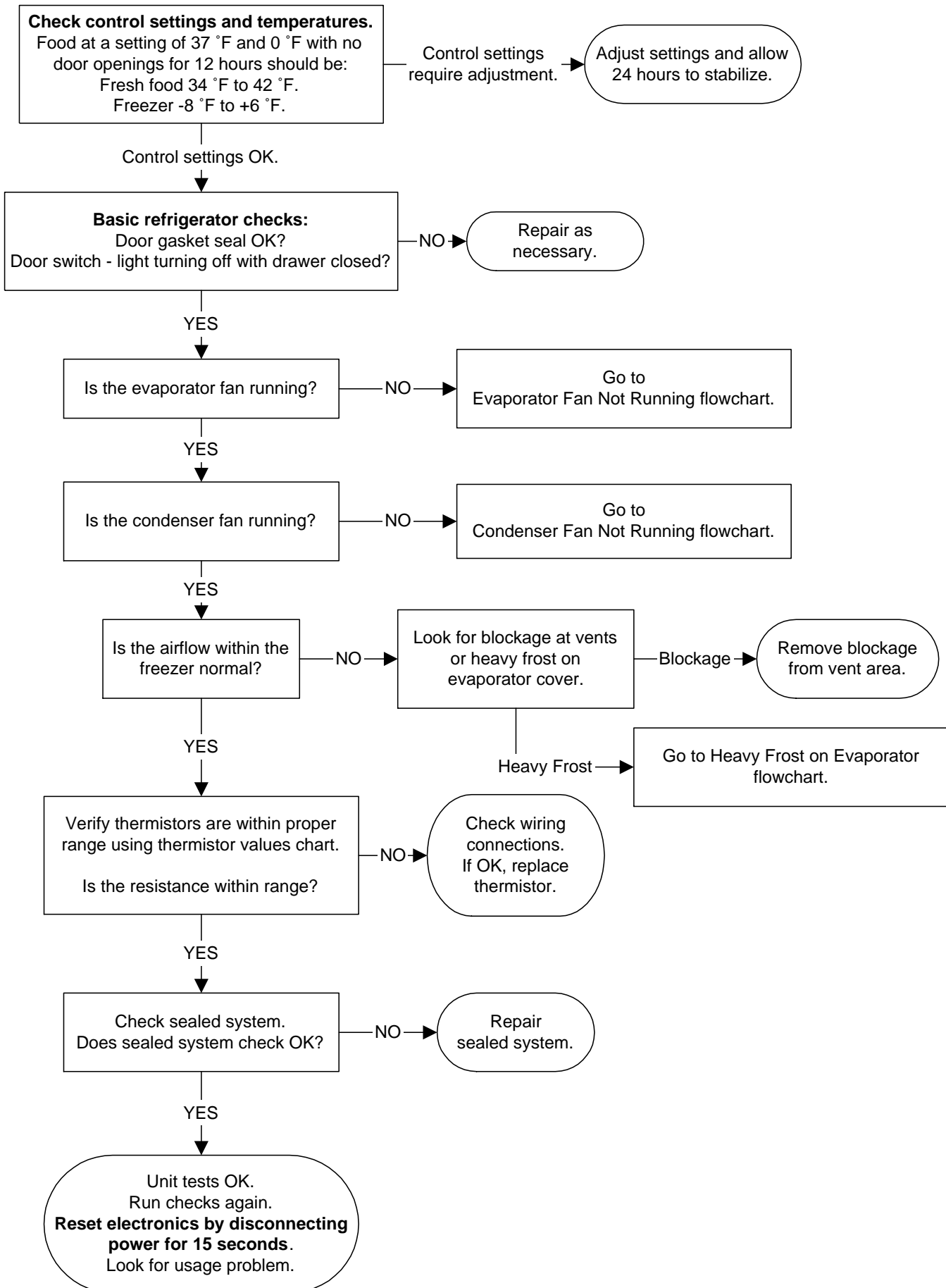

Compressor Not Running

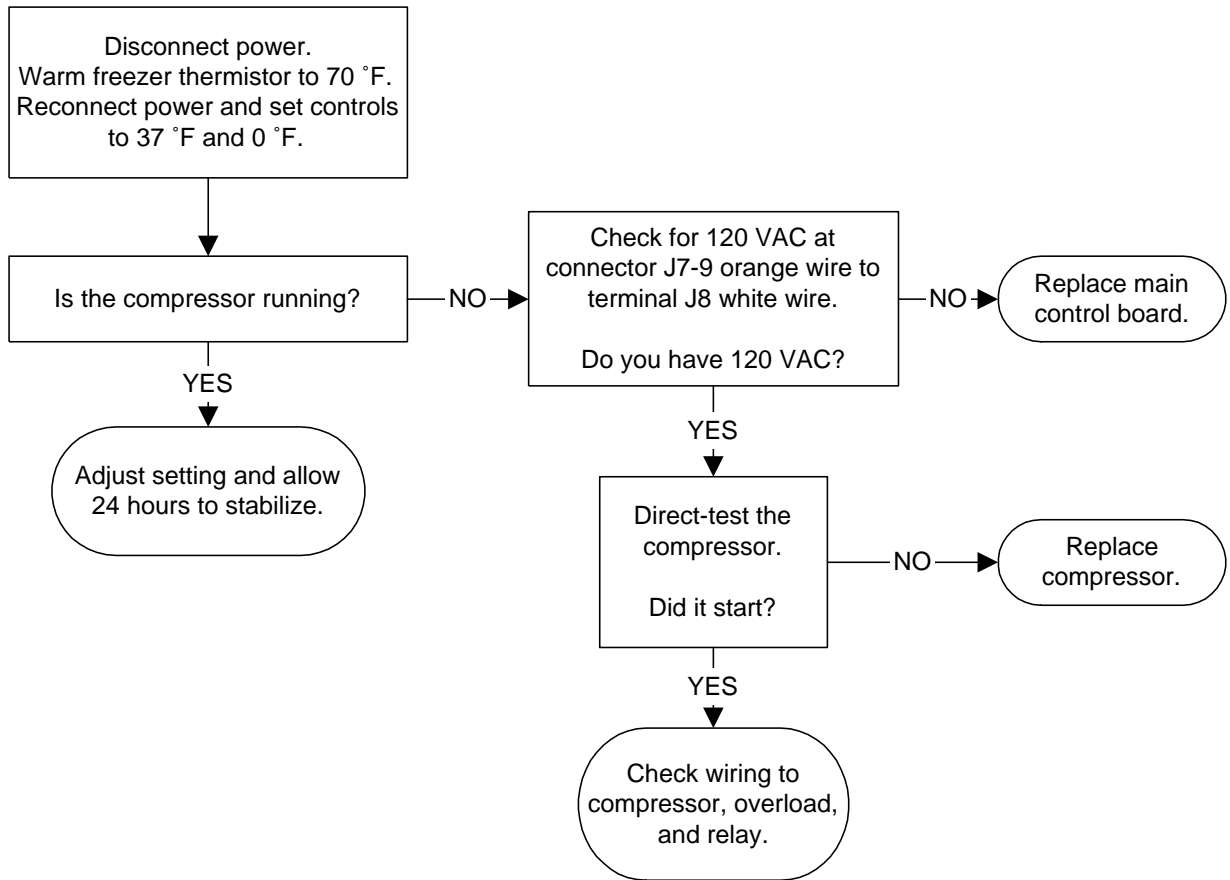

Refrigerator Dead - No Sound, No Cooling

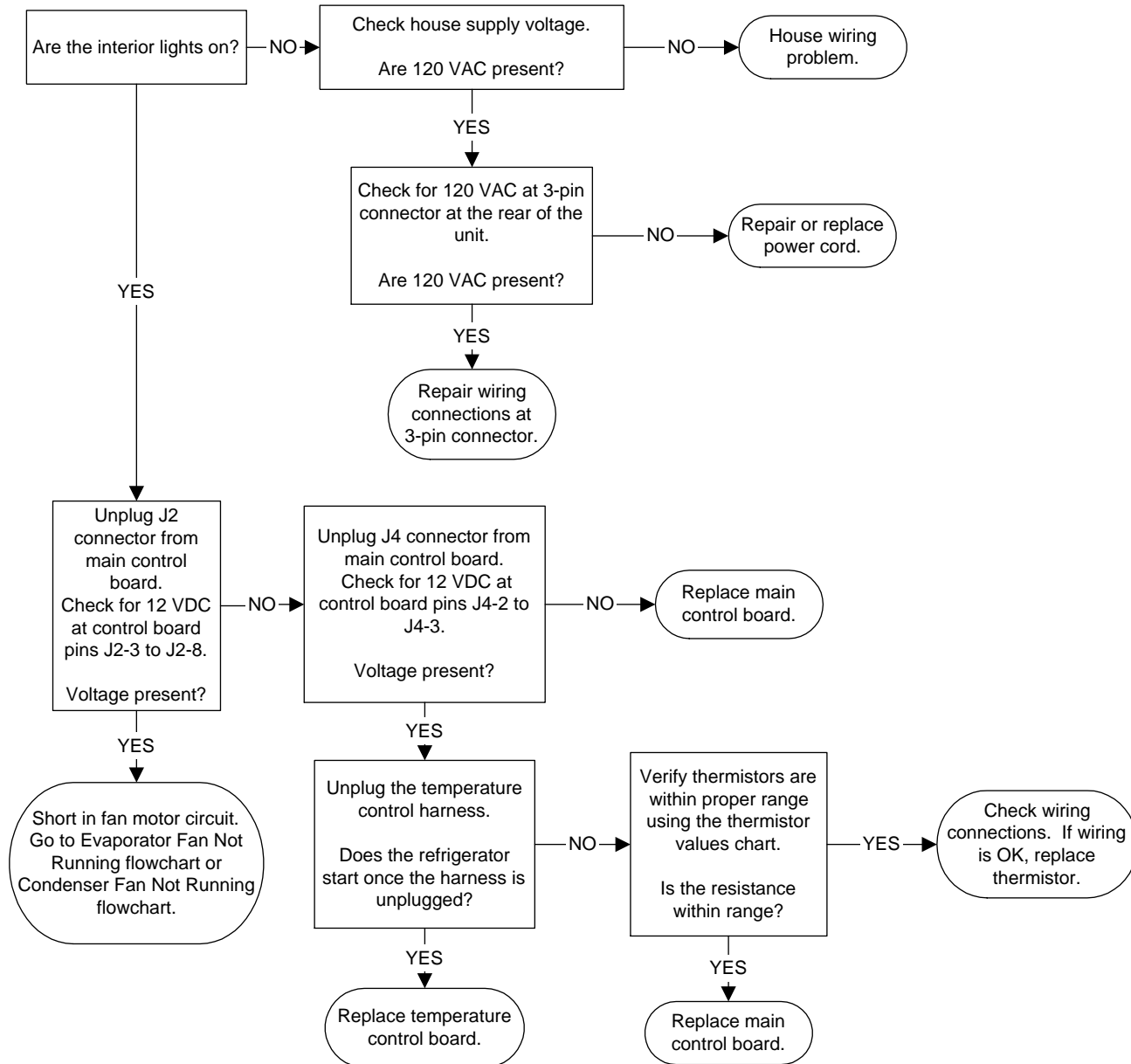

Damper Door Does Not Operate

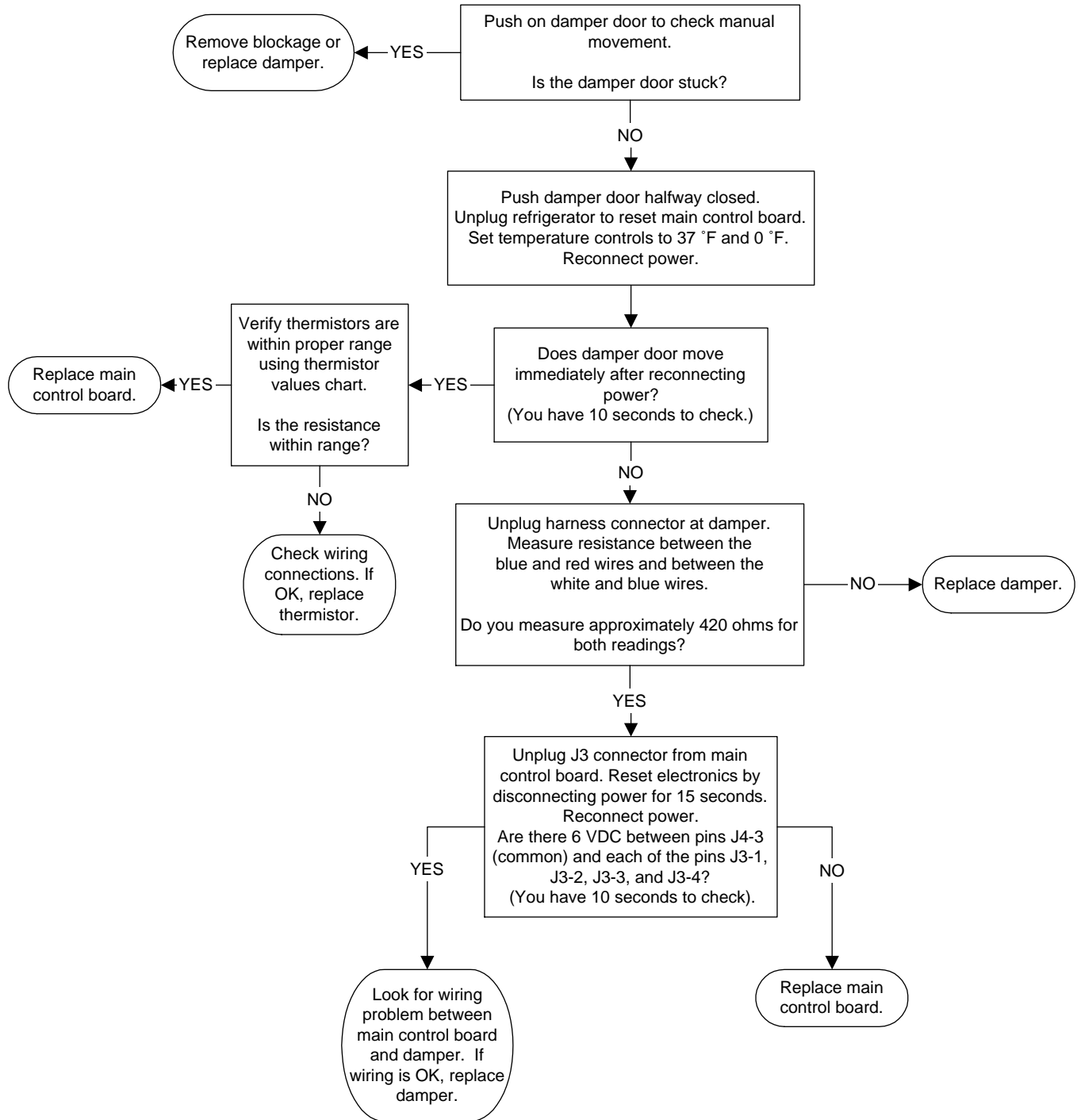

Heavy Frost on Evaporator

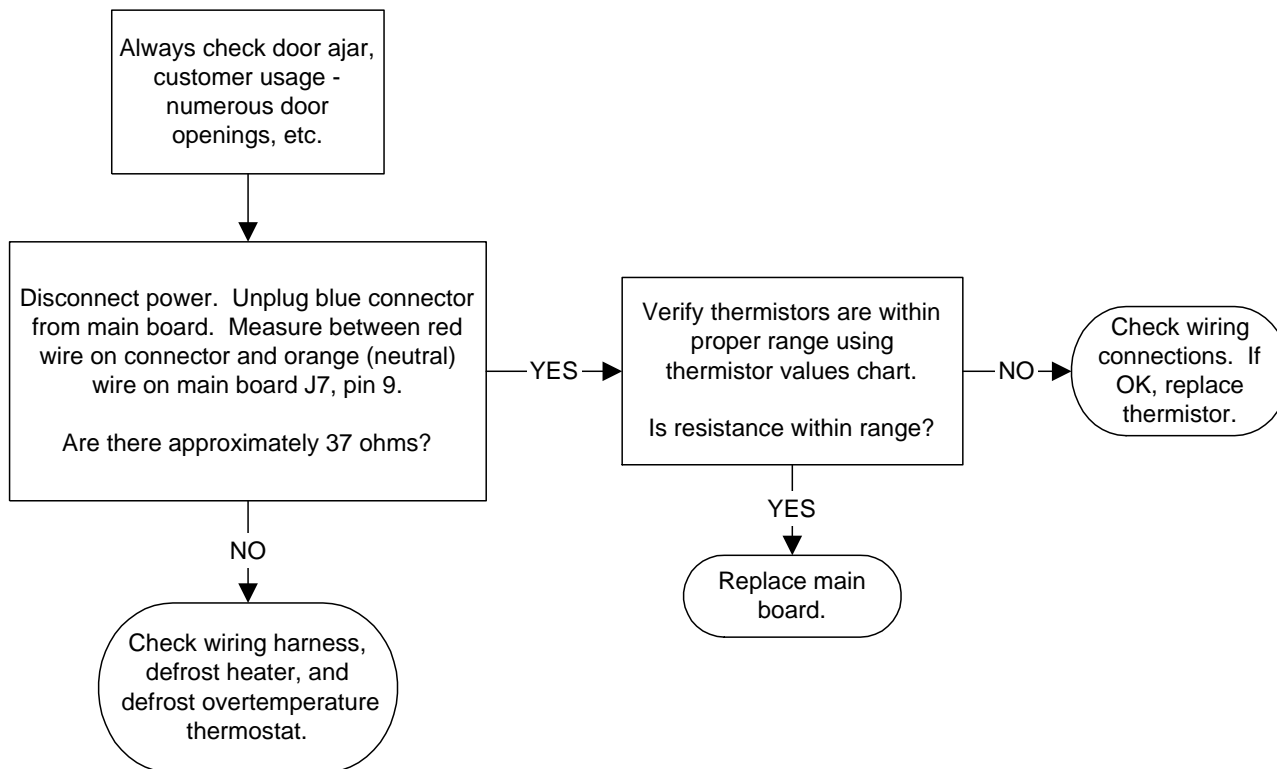

Evaporator Fan Not Running

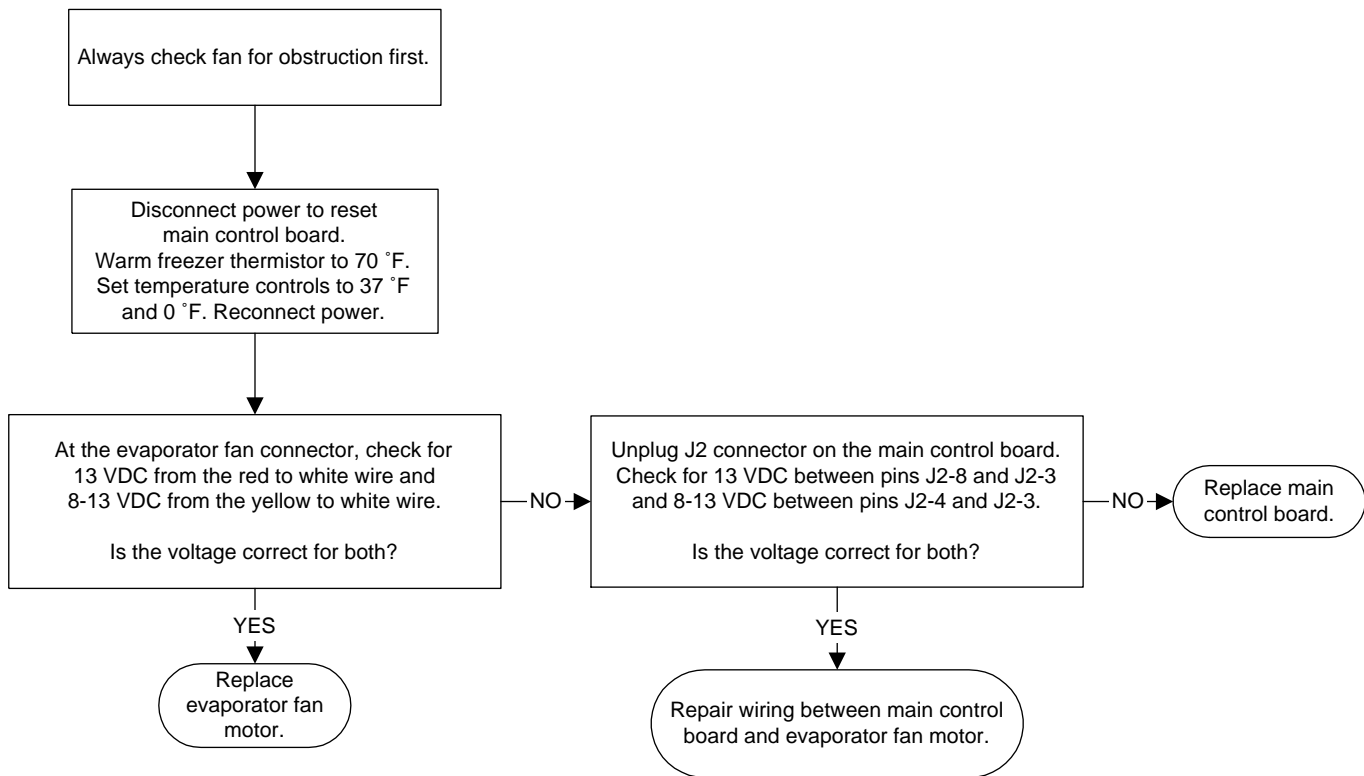

Condenser Fan Not Running

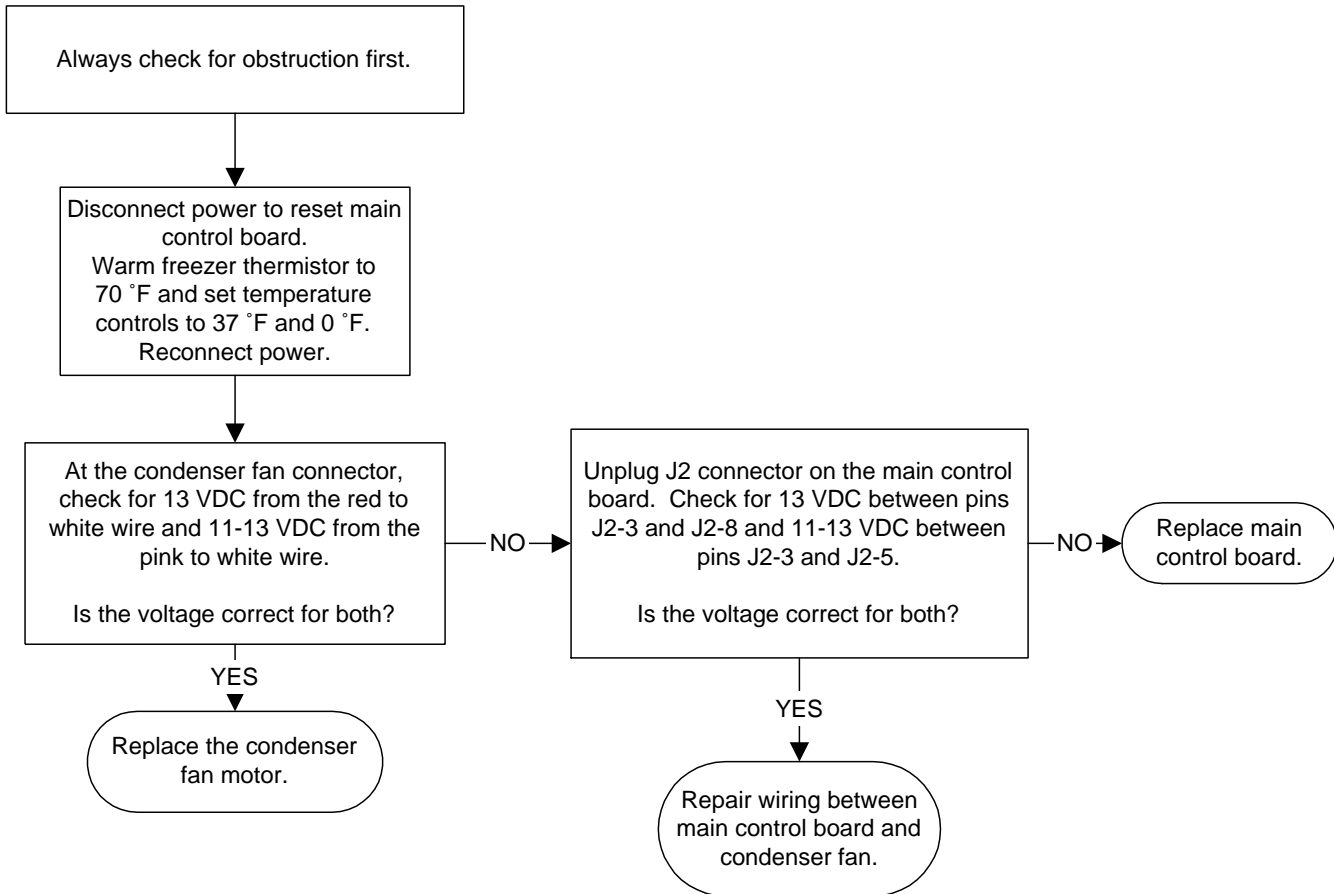

Warranty

YOUR MONOGRAM REFRIGERATOR WARRANTY

Staple sales slip or cancelled check here. Proof of original purchase date is needed to obtain service under warranty.

WHAT IS COVERED

From the Date of the Original Purchase

FULL TWO-YEAR WARRANTY

For two years from date of original purchase, we will provide, free of charge, parts and service labor in your home to repair or replace *any part of the refrigerator* that fails because of a manufacturing defect.

FULL FIVE-YEAR WARRANTY

For five years from date of original purchase, we will provide, free of charge, parts and service labor in your home to repair or replace *any part of the sealed refrigerating system* (the compressor, condenser, evaporator and all connecting tubing) that fails because of a manufacturing defect.

LIMITED ADDITIONAL SEVEN-YEAR WARRANTY ON THE SEALED SYSTEM

For the sixth through twelfth year from the date of the original purchase, we will provide, free of charge, replacement parts for *any part of the sealed refrigerating system* (the compressor, condenser, evaporator and all connecting tubing) that fails because of a manufacturing defect. You pay for the service trip to your home and for service labor charges.

LIMITED LIFETIME WARRANTY ON ACCURIDE® SLIDES

From the date of the original purchase we will provide, free of charge, replacement parts for *any part of the Accuride Slides* that fails because of a manufacturing defect. You pay for the service trip to your home and for service labor charges.

.....
This warranty is extended to the original purchaser and any succeeding owner for products purchased for ordinary home use in the 48 mainland states, Hawaii and Washington, D.C. In Alaska the warranty is the same except that it is LIMITED because you must pay to ship the product to the service shop or for the service technician's travel costs to your home.

All warranty service will be provided by our Factory Service Centers or by our authorized Customer Care® servicers during normal working hours.

Should your appliance need service, during warranty period or beyond, in the U.S.A. call 800.444.1845. In Canada: 888.880.3030.

WHAT IS NOT COVERED

- Service trips to your home to teach you how to use the product.
- Replacement of house fuses or resetting of circuit breakers.
- Damage to the product caused by accident, fire, floods or acts of God.
- Failure of the product if it is used for other than its intended purpose or used commercially.
- Improper installation.
If you have an installation problem, contact your dealer or installer. You are responsible for providing adequate electrical, plumbing and other connecting facilities.
- Loss of food due to spoilage.
- Incidental or consequential damage caused by possible defects with this appliance.

Some states do not allow the exclusion or limitation of incidental or consequential damages, so the above limitation or exclusion may not apply to you. This warranty gives you specific legal rights, and you may also have other rights which vary from state to state. To know what your legal rights are in your state, consult your local or state consumer affairs office or your state's Attorney General.

Warrantor: General Electric Company, Louisville, KY 40225

Free Manuals Download Website

<http://myh66.com>

<http://usermanuals.us>

<http://www.somanuals.com>

<http://www.4manuals.cc>

<http://www.manual-lib.com>

<http://www.404manual.com>

<http://www.luxmanual.com>

<http://aubethermostatmanual.com>

Golf course search by state

<http://golfingnear.com>

Email search by domain

<http://emailbydomain.com>

Auto manuals search

<http://auto.somanuals.com>

TV manuals search

<http://tv.somanuals.com>