

Use and Care Guide

Spacemaker™ Laundry



Safety Instructions3- 5



Operating Instructions, Tips

Controls Setting Guide.....	10, 11
Knits Drying Tips.....	9
Lint Filter.....	4, 9, 20, 21
Loading.....	7
Operating the Washer.....	8
Operating the Dryer.....	9
Permanent Press Drying Tips.....	9-11
Sorting Clothes.....	6, 7



Care and Cleaning.....20, 21

Dryer Exhaust.....	21
Exterior.....	20
Lint Filter.....	8, 9, 20, 21
Storage and Vacation Tips.....	20
User Maintenance Instructions.....	20, 21



Problem Solver.....15-19

More questions?...call
GE Answer Center® 800.626.2000



Preparation

Other Laundry Products.....	12
Hard Water.....	13
Loading the Washer.....	7
Pretreating.....	6, 12, 13
Sorting Clothes.....	6, 7
Stains.....	13
Stain Removal Guide.....	14



Consumer Services

Appliance Registration.....	2
Model and Serial Numbers.....	2
Repair Service.....	2
Warranty.....	Back Cover

Models: WSM2700 WSM2780

GE Quality Product

Part No. 175D1807P280
Pub. No. 49-90013

7-99 JR
P/N 131871400

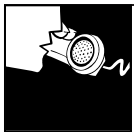

HELP US HELP YOU...

Before using your Spacemaker™ Laundry, read this book carefully.

It is intended to help you operate and maintain your new appliance properly.

Keep it handy for answers to your questions.

If you don't understand something or need more help, call:

GE Answer Center®
800.626.2000

24 hours a day, 7 days a week

Save time and money.

Before you request service... check the Problem Solver section. It lists causes of minor operating problems that you can correct yourself.

If you received a damaged appliance...

Immediately contact the dealer (or builder) that sold you the appliance.

Write down the model and serial numbers.

You'll find them on a label on the inside of the dryer door.

These numbers are also on the Consumer Product Ownership Registration Card that came with your appliance. Before sending in this card, please write these numbers here:

Model Number

Serial Number

Use these numbers in any correspondence or service calls concerning your appliance.

WARNING: For your safety the information in this manual must be followed to minimize the risk of fire or explosion or to prevent property damage, personal injury or loss of life.

- Do not store or use gasoline or other flammable vapors and liquids in the vicinity of this or any other appliance.
- WHAT TO DO IF YOU SMELL GAS
 - Do not try to light any appliance.
 - Do not touch any electrical switch; do not use any phone in your building.
 - Clear the room, building or area of all occupants.
- Immediately call your gas supplier from a neighbor's phone. Follow the gas supplier's instructions.
- If you cannot reach your gas supplier, call the fire department.
- Installation and service must be performed by a qualified installer, service agency or the gas supplier.

All washing and drying instruction terms in this book conform to the Care Labeling Rule established by the Federal Trade Commission, January 1984.

If You Need Service

We're proud of our service and want you to be pleased. If for some reason you are not happy with the service you receive, here are steps to follow for further help.

First, contact the people who serviced your appliance. Explain why you are not pleased. In most cases, this will solve the problem.

NEXT, if you are still not pleased, write all the details—including your phone number—to:

Manager, Consumer Relations
GE Appliances, Appliance Park
Louisville, KY 40225

IMPORTANT SAFETY INSTRUCTIONS

Read all instructions before using this appliance.



California Safe Drinking Water and Toxic Enforcement Act

This act requires the governor of California to publish a list of substances known to the state to cause cancer, birth defects or other reproductive harm and requires businesses to warn customers of potential exposure to such substances.

Gas appliances can cause minor exposure to four of these substances, namely benzene, carbon monoxide, formaldehyde and soot, caused primarily by the incomplete combustion of natural gas or LP fuels.

Properly adjusted dryers will minimize incomplete combustion. Exposure to these substances can be minimized further by properly venting the dryer to the outdoors.



Warning—To reduce the risk of fire, electric shock, or injury to persons when using your appliance, follow basic precautions, including the following:

- Use this appliance only for its intended purpose as described in this Use and Care Book.



- This appliance must be properly installed and located in accordance with the Installation Instructions before it is used.

If you did not receive an Installation Instructions sheet with your appliance, you can obtain one by calling, toll free, the GE Answer Center,[®] 800.626.2000.

- Properly ground to conform with all governing codes and ordinances. Follow details in Installation Instructions.
- Locate where the temperature is above 50°F. (10°C.) for satisfactory operation of the appliance control system. Do not install or store the appliance where it will be exposed to the weather.
- Connect to a properly rated, protected and sized power supply circuit to avoid electrical overload.
- Exhausting to the outside is **STRONGLY RECOMMENDED** to prevent large amounts of moisture and lint from being blown into the room. Carefully follow the details in the Installation Instructions. If your appliance is *not* vented to the outside, see special instructions in Care and Cleaning section. If this appliance has a gas dryer, it must be exhausted outside.



- Do not repair or replace any part of the appliance or attempt any servicing unless specifically recommended in this Use and Care Book or in published user-repair instructions that you understand and have the skills to carry out.

- Turn off water faucets when the washer is not in use to relieve pressure on hoses and valves, and to minimize leakage if a hose or valve should break or rupture.



- When disconnecting this appliance pull by the plug rather than the cord to avoid damage to the cord or junction of cord and plug. Make sure that the cord is located so that it will not be stepped on, tripped over or otherwise subjected to damage or stress.

To Minimize the Possibility of a Fire Hazard

- Exhaust Duct—See Installation Instructions. Use only metal duct inside for exhausting dryer to the outside. USE OF PLASTIC OR OTHER COMBUSTIBLE DUCTWORK CAN CAUSE A FIRE. FOIL OR OTHER EASILY PUNCTURED DUCTWORK CAN CAUSE A FIRE IF IT COLLAPSES OR BECOMES OTHERWISE RESTRICTED IN USE OR DURING INSTALLATION.
- Do not use heat to dry articles containing rubber, plastic, or similar materials (such as padded bras, tennis shoes, galoshes, bath mats, rugs, bibs, baby pants, plastic bags, etc.) as these materials may melt or burn. Also, some rubber materials, when heated, can under certain circumstances produce fire by spontaneous combustion.
- Do not store items that may burn or melt (such as clothing, paper material, plastics or plastic containers, etc.) on top of the appliance during operation.
- Garments labeled “Dry Away from Heat” (such as life jackets containing Kapok) must not be put in your dryer.

(continued next page)



IMPORTANT SAFETY INSTRUCTIONS

(continued)

- Any article on which you have used a cleaning solvent, or which contains flammable materials (such as cleaning cloths, mops, towels used in beauty salons, restaurants or barber shops, etc.) must not be placed in or near the dryer until all traces of these flammable liquids or solids and their fumes have been removed. There are many highly flammable items used in homes such as: acetone, denatured alcohol, gasoline, kerosene, some household cleaners, some spot removers, turpentine, waxes, wax removers and products containing petroleum distillates.



- **Clean the dryer lint filter before each load to prevent lint accumulation inside the dryer or in the room. DO NOT OPERATE THE DRYER WITHOUT THE LINT FILTER IN PLACE.**

- **Keep the area around and underneath your appliances free from the accumulation of combustible materials, such as lint, paper, rags, chemicals, etc.**
- **The interior of the machine and the exhaust duct connection inside the dryer should be cleaned periodically by a qualified individual.**

To Minimize the Possibility of Injury

- Do not mix chlorine bleach with ammonia or acids such as vinegar and/or rust remover. Mixing can produce a toxic gas which may cause death.
- Do not wash or dry articles that have been cleaned in, washed in, soaked in, or spotted with combustible or explosive substances (such as paint, gasoline, degreasers, dry-cleaning solvents, cooking oils, kerosene, etc.) which may ignite or explode.

Do not add these substances to the wash water and do not use or store these substances on/or around your washer and dryer during operation.

- Do not place items exposed to cooking oils in your dryer. Items contaminated with cooking oils may contribute to a chemical reaction that could cause a clothes load to catch fire.



WARNING—HYDROGEN GAS is produced by the chemical action within your water heater and the gas can accumulate in the water heater and/or water pipes if hot water has not been used for a period of two weeks or longer. HYDROGEN GAS CAN BE EXPLOSIVE UNDER THESE CIRCUMSTANCES. So to prevent the possibility of damage or injury, if you have not used hot water for two weeks or more, or move into a residence in which the hot water system may not have been used for some time, turn on all hot water faucets and allow them to run for several minutes before using any electrical appliance which is connected to the hot water system. This will allow any hydrogen gas to escape. Since the gas is flammable, do not smoke or use an open flame or appliance during this process.

- Never reach into washer while it is moving. Before loading, unloading or adding clothes, push the Cycle Selector knob in, then wait until the machine has completely stopped before opening the lid.
- Never reach into the dryer while the drum is moving. Before loading, unloading or adding clothes, wait until the drum has completely stopped.
- Do not wash or dry fiberglass articles in your appliance. Skin irritation could result from the remaining glass particles that may be picked up by clothing during subsequent appliance uses.



- **The laundry process can reduce the flame retardancy of fabrics.** To avoid such a result, the garment manufacturer's care instructions should be followed very carefully.

- Close supervision is necessary if this appliance is used by or near children. Do not allow children to play inside, on, or with this appliance or any discarded appliance. Dispose of discarded appliances and shipping or packing materials properly. Before discarding an appliance, or removing from service, remove the lid or door.

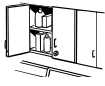

- **Keep all laundry additives (such as detergents, bleaches, fabric softeners, etc.) out of the reach of children**, preferably in a locked cabinet. Observe all warnings on container labels to avoid personal injury.
- **Keep the floor around your appliance clean and dry to reduce the possibility of slipping.**



- **To minimize the possibility of electric shock**, unplug this appliance from the power supply before attempting any maintenance or cleaning (except the removal and cleaning of the lint filter).

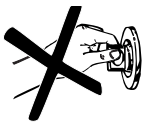

NOTE: Pushing the washer Cycle Selector knob in or turning the dryer Cycle Selector to OFF does NOT disconnect the appliance from the power supply.

- **Do not tamper with the controls.**
- **Do not operate this appliance if it is damaged, malfunctioning, partially disassembled, or has missing or broken parts, including a damaged cord or plug.**
- **Never climb on or stand on the dryer top.**

For washer operation

- **Do not leave washer lid up during cycle.** This will stop the spin action and prevent completion of the cycle.

Dryer-applied Fabric Softeners or Anti-static Conditioners

You may wish to soften your laundered fabrics or reduce the static electricity in them.

We recommend you use either a fabric softener in the wash cycle, according to the manufacturer's instructions for those products, or try a dryer-added product for which the manufacturer gives written assurance on the package that their product can be safely used in your dryer.

Service or performance problems caused by the use of these products are the responsibility of the manufacturers of those products and are not covered under the warranty of this appliance.

SAVE THESE INSTRUCTIONS



HOW TO SORT CLOTHES FOR YOUR WASHER

It pays to check and prepare clothes for washing.

- Empty pockets, brush out cuffs, zip zippers, snap snaps, hooks and buttons.
- Do any necessary mending—rips, hems, tears.
- Check all items for areas of heavy soil or stain.
- Remove stains. See Stain Removal Guide.
- Turn poly knits inside-out to minimize fabric surface damage.

Soaking and Pretreating—a good way to loosen deep soils and stains.

A thorough soaking with detergent or special soaking agent is another way to remove heavy soils, embedded dirt and even some stains.

For information on how to soak in your washer, see Operating Instructions.

FOR INFORMATION on SOAKING AGENTS, see Other Laundry Products section.

Pretreat heavy soil by rubbing in a small amount of liquid detergent or a paste made of water and powdered detergent or soap. For best results, wait 1/2 hour before washing.

Sort by Surface Texture

Separate

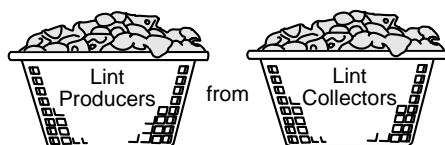

LINT PRODUCERS—such as terry toweling and chenille—give up lint.

LINT COLLECTORS—such as man-made fibers and napped fabrics like velveteen and corduroy— attract lint. These must be washed separately.

For more information on lint control, see The Problem Solver section.

Sort by Fabric

Separate

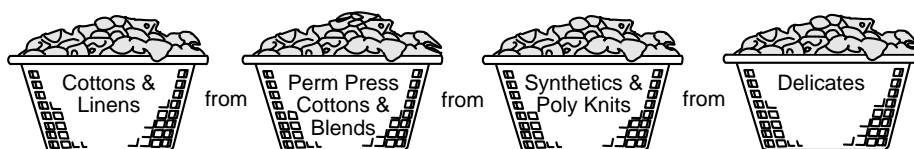

In addition to sorting to reduce lint collection, it is recommended that fabrics of similar construction be washed together whenever possible.

Sort by Soil

Separate

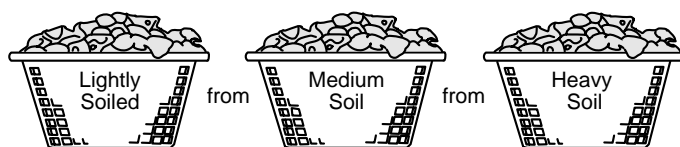

Sort by Color

Separate

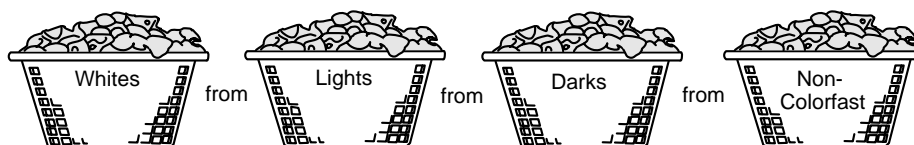

For instructions on different fabrics and loads, see the Controls Setting Guide.

HOW TO SORT CLOTHES FOR YOUR DRYER



Sort by Weight

Separate

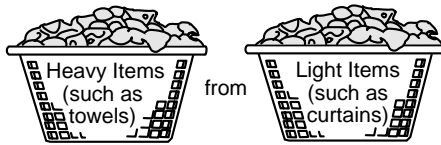

Normally, if you sort clothes correctly for washing, you will have properly sorted drying loads.

LOADING THE WASHER PROPERLY

- Add measured amount of detergent.
- **Load clothes loosely.** Dry clothes level should be no higher than the top row of circular holes in the wash tub. Do not put clothes on the agitator or wind them around it. For best results, mix large items with small ones. When washing a single heavy item, such as a shag rug or bedspread, add one or two other pieces to balance the load. Large items should be no more than one-half of the total load.
- **To bleach the load,** measure liquid bleach according to directions on container. After washer has filled and agitated for several minutes, add diluted bleach to the bleach dispenser.

For information on how to use bleaches and fabric softeners, see Other Laundry Products section.

- **Close lid.** Washer will fill and agitate but will not spin with lid open. This washer has a Safety Lid Lock. As a safety measure, the lid will be automatically locked during the spin portion of each cycle. The lid will automatically unlock about one minute after the end of the spin cycle. To open lid during spin cycle, push Cycle Selector IN and wait for lid lock to release, about one minute, before opening.



For your personal safety, never reach into washer while parts are moving. Always stop washer to load, unload, add forgotten items or additional laundry additives.

- Always flush the dispenser with one cup of water to avoid bleach carry-over to the next wash load.

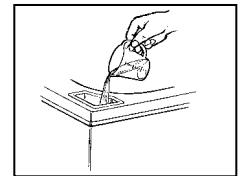

NOTE: Do not use powdered bleach in the bleach dispenser. Follow directions on the package when using powdered bleach in the wash load.



CAUTION: Failure to follow these directions can cause bleach damage to the wash load.



WARNING: Do not use chlorine bleach and ammonia in the same load. Poisonous gas can occur, resulting in serious injury or death.

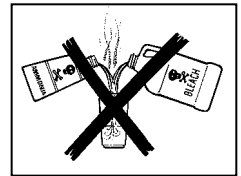



HOW TO OPERATE YOUR WASHER

WARNING—To reduce the risk of fire, electric shock, or injury to persons, read the **IMPORTANT SAFETY INSTRUCTIONS** before operating this appliance.

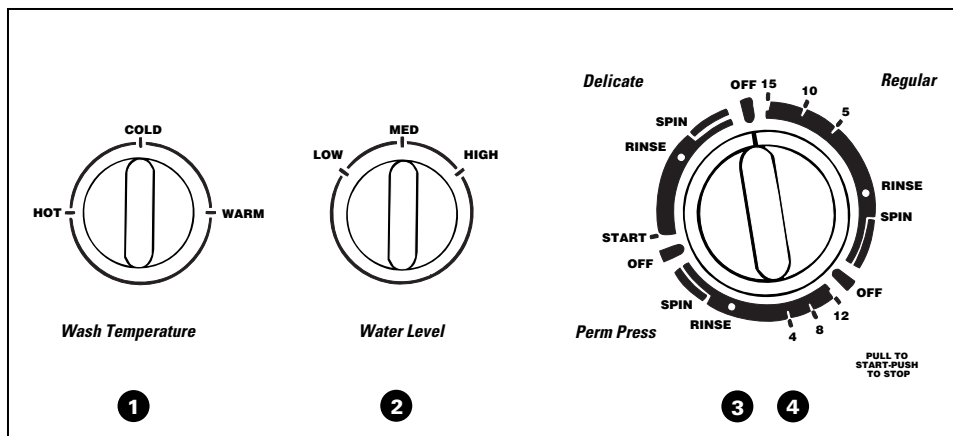

Set the controls

See the Controls Setting Guide.

- 1** Select Wash Temperature. Cold rinse will be automatically provided with all cycles.
- 2** Select Water Level.
LOW: Washer is less than 1/3 full of clothes.
MED: Between 1/3 and 2/3 full.
HIGH: Over 2/3 full of clothes.

- 3** Push Cycle Selector in and turn clockwise to your selected wash cycle.
- 4** Pull Cycle Selector out to start the cycle.

NOTE: If you wish to change cycle setting after washer has started, push Cycle Selector in and wait for washer to stop. Then reset to the new position. Setting can be changed at any time during the Regular, Perm Press or Delicate cycles.

Self-cleaning lint filter

The lint filter needs no attention from you. Lint collected during washing and rinsing of clothes is automatically flushed down the drain.

How to soak in the washer

Set wash temperature control. Add detergent or soak agent. Turn Cycle Selector to desired cycle. Start the washer. After washer fills and begins to agitate, push in the Cycle Selector to stop washer. Allow to soak, turn to Spin. Pull out the Cycle Selector to complete the cycle.

Delicate Cycle

To get the full benefit of the Delicate Cycle, always set the Cycle Selector at the beginning of the cycle. During wash, the Delicate Cycle alternates between agitation and pause, to protect delicate clothes.

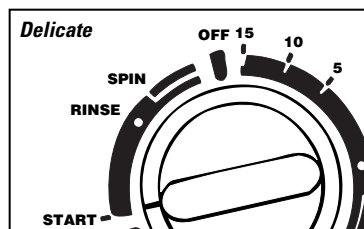

HOW TO OPERATE YOUR DRYER



WARNING—To reduce the risk of fire, electric shock, or injury to persons, read the **IMPORTANT SAFETY INSTRUCTIONS** before operating this appliance.

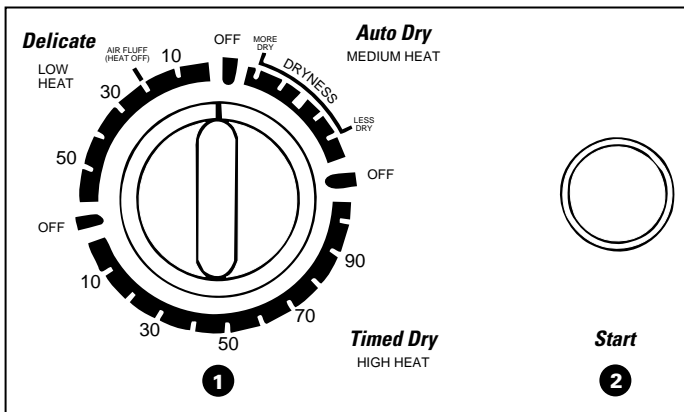

Set the controls

See the Controls Setting Guide.

- 1 Turn Cycle Selector clockwise to desired cycle and select correct dryness level or drying time for load type.
- 2 Press the Start button. (Opening door during operation stops dryer. To re-start, close door and press the Start button again.)

Load the dryer properly

- Load sorted clothes into dryer. See Loading section.
- Clean lint filter before each load.

Remove the lint filter by pulling straight up. Wipe all accumulated lint from screen. Properly reposition lint filter after cleaning. Occasionally wash filter using soap and warm water. Rub lightly, rinse and dry thoroughly. This will help remove all fabric softener buildup.

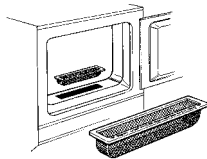

Do not use dryer-applied fabric softeners unless you follow these lint cleaning instructions.

Do not operate dryer without lint filter in place.

- Close door. Door must be closed before dryer will operate.

Polyester Knits & Perm Press Drying Tips

- **Do not overload**—Garments being dried or dewrinkled should tumble freely.
- **Remove clothes immediately**—To help prevent wrinkling, remove clothes from the dryer immediately at the end of the drying cycles.

- **Place on hangers**—Permanent Press and Polyester Knit garments look best if placed on hangers after drying.

How Timed and Automatic Drying Differ

Automatic drying—The Automatic Dry Control system continually senses air temperature in dryer drum. Wet laundry keeps this air cool. When drum air is warm enough, heat turns off. When the air cools, heat turns back on. This on and off cycling may happen a number of times (depending on the fabric, load size and Cycle Selector setting). The Cycle Selector advances (when the heat is off) until it automatically turns dryer off.

Timed drying—You select the number of minutes you wish the dryer to run and it turns off at the end of this time period.

Dryness Guide for the Automatic Cycle

<p>Set to Middle Position</p>	<ul style="list-style-type: none"> • For most normal loads.
<p>Set toward MORE DRY</p>	<ul style="list-style-type: none"> • For loads that include heavyweight fabrics. • If you desire to remove more moisture.
<p>Set toward LESS DRY</p>	<ul style="list-style-type: none"> • For most normal loads. • For very small loads. (Add two or more similar articles, even if dry, to assist tumbling.) • If you desire to remove less moisture.



CONTROLS SETTING GUIDE

Controls Setting Guide for different fabrics and loads

Load	Wash Water Temperature	Wash Cycle	Wash Cycle Setting	Dry Cycle
Baby Clothes				
Plastic-lined items	Warm	Delicate*	Set at START	Air Fluff (No Heat)
Diapers	Hot	Regular	See #1 below	Timed Dry (High Heat)
Man-made fabrics**	Warm	Delicate*	Set at START	Delicate (Low Heat)
Mixed cottons	Warm	Perm Press	See #2 below	Automatic Dry (Medium Heat)
Bedspreads	Follow Label Directions			
Blankets				
Electric	Warm	Delicate*	Set at START	Delicate (Low Heat)
Man-made**	Warm	Delicate*	Set at START	Delicate (Low Heat)
Woolen	Warm	Delicate*	Set at START	Delicate (Low Heat)
Cotton & Linens				
Colorfast/White	Hot	Regular	See #1 below	Timed Dry (High Heat)
Non-Colorfast	Cold			
Curtains				
Cotton	Hot or Warm	Regular	See #1 below	Timed Dry (High Heat)
Man-made,** Sheers	Warm	Delicate*	Set at START	Delicate (Low Heat)
Permanent Press	Warm	Perm Press	See #2 below	Automatic Dry (Medium Heat)
Delicates				
Lingerie, Knits	Warm	Delicate*	Set at START	Delicate (Low Heat)
Foundation Garments†	Warm	Delicate*	Set at START	Delicate (Low Heat)
Glass Fiber	Do not wash or dry glass fiber in the Spacemaker Laundry.			
Permanent Press				
Curtains	Warm	Perm Press	See #2 below	Automatic Dry (Medium Heat)
Draperies	Warm	Delicate*	Set at START	Automatic Dry (Medium Heat)
Dresses, sportswear	Warm	Perm Press	See #2 below	Automatic Dry (Medium Heat)
Heavy slacks	Warm	Perm Press	See #2 below	Automatic Dry (Medium Heat)
Knits, man-made**	Warm	Delicate*	Set at START	Delicate (Low Heat)
Lingerie	Warm	Delicate*	Set at START	Delicate (Low Heat)
Sheets & pillowcases	Hot	Perm Press	See #2 below	Automatic Dry (Medium Heat)
White shirts, blouses	Hot	Perm Press	See #2 below	Automatic Dry (Medium Heat)
Work clothes	Hot	Perm Press	See #2 below	Automatic Dry (Medium Heat)
Plastic	Warm	Delicate*	Set at START	Air Fluff (No Heat)
Quilted Items	Follow Label Directions			
Swimsuits	Follow Label Directions			
Sweaters, man-made fabrics**	Warm	Delicate*	Set at START	Delicate (Low Heat)
Synthetic Sheets	Warm	Delicate*	Set at START	Delicate (Low Heat)
Washable Woolens	Warm	Delicate*	Set at START	Delicate (Low Heat)
Work Clothes	Hot	Regular	See #1 below	Timed Dry (High Heat)

#1 Regular Cycle: 10 –15 minutes for Heavy soil, 5 –10 for Normal soil, up to 5 for Light soil.

#2 Perm Press Cycle: 12 minutes for Heavy soil, 4 –8 for Normal soil, up to 4 for Light soil.

*Delicate cycle alternates between pauses and agitation during wash.

**Man-made fibers (synthetics) such as polyester, nylon and acrylics must be dried using the Delicate (low heat) Cycle. If you mix various types of fabrics in your drying load, set the controls for the lightest weight fabrics and remove when dry. Then reset the control for the remaining fabrics.

†Never dry foam rubber or similarly textured, rubber-like materials in the dryer except on AIR FLUFF (no heat). Fire hazard may result.

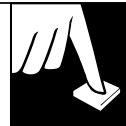

Save and refer to Garment Manufacturer's Care Labels

For more information on care labeling, send for "What's New About CARE LABELS."

For sale by the Superintendent of Documents, U.S. Government Printing Office, Washington, D.C. 20402.

Dry Cycle Setting	Special Instructions
Up to 20	Plastic-lined pants, bibs, pads, crib sheets may be washed with regular load but should be dried separately.
45 -60	Rinse at once, soak in diaper pail with solution of cold water and borax (1¼ teaspoons to gallon). Soak before washing with a presoak product. Use warm water.
25 -40	
Midpoint	Pretreat heavily soiled areas; brush on a little liquid detergent, or wet area and rub in detergent. Use Warm Soak for oil and juice stains. Use Cold Soak for egg, milk and cereal stains.
Follow Label Directions	
85 -95	Shake out excess dust. Remove stains. Pretreat heavily soiled areas with detergent. Wash one large or two small blankets at a time.
65 -95	
40	See "Washable Woolens" instructions below.
Full loads 65 -75 Small loads 35 -45	
25 -35	If badly sun-weakened, even hand washing will cause tearing. Be sure colors are fast and fabric is washable. Remove hooks and non-washable trim. Use Warm Soak if heavily soiled.
30	
Less Dry	
20 -30	
30 -40	Frequent washing lengthens life, helps retain shape. Remove non-washable trim. Close zippers; fasten hooks.
Do not wash or dry glass fiber in the Spacemaker Laundry.	
Less Dry	If badly sun-weakened, even hand washing will cause tearing. Be sure colors are fast and fabric is washable. Remove hooks and non-washable trim. Use Warm Soak if heavily soiled.
Midpoint	
Midpoint	
More Dry	Turn slacks and dark items inside out to prevent whitening of seams and creases.
25 -35	
20 -30	
Midpoint	Use Warm Soak for pillowcases stained with hair oil.
Midpoint	Pretreat collars and cuffs with liquid laundry detergent.
More Dry	See "Work Clothes" instructions below.
15 -20	Some plastics will tear if machine washed. Place small items in mesh bag for washing. If shower curtains are soap-streaked, add Calgon brand to wash water; don't use detergent.
Follow Label Directions	
Follow Label Directions	
40 -55	Pretreat around neckline. Follow manufacturer's recommendations.
30 -40	
30 -40	As a general rule, if wool can be hand washed, it can be "washed" by soaking in the washer. A liquid detergent is preferred because it dissolves faster in soak than a granulated detergent. Pretreat woolens with liquid detergent. Never use chlorine bleach.
65 -85	Pretreat heavily soiled areas by rubbing in liquid laundry detergent. Let stand 30 to 60 minutes. If clothes are heavily soiled, use Warm Soak for greasy and oily soil. Cold Soak for flour, dust, blood-stained garments. Use 1/4 to 1/2 cup liquid laundry detergent in SOAK; 1/2 to 1 cup in Wash.

DO NOT tumble dry jackets or pillows containing Kapok. Fire hazard may result.

NOTE: The Cycle Selector settings indicated here are to be used as a guide. You may find that best results are obtained for some of your fabrics by setting the Cycle Selector to either side of the recommended settings.



OTHER LAUNDRY PRODUCTS

Laundry Product and Type	How to Use It	Special Instructions
<p>BLEACH Chlorine liquid such as Clorox™ brand</p> <p>Non-chlorine such as Clorox 2™ brand</p>	<p>After wash action has started and detergent is dissolved, add bleach to dispenser and flush with one cup of water (see Loading the Washer Properly section).</p> <p>Follow package directions. Put bleach into washer with detergent.</p>	<p>1) Do not pour undiluted liquid chlorine bleach directly into washer or on dry clothes.</p> <p>2) Some of today's washable fabrics should not be chlorine bleached such as: 100% cotton flame-retardant children's sleepwear, silk, wool, mohair, spandex, leather, or non-fast colors. Dilute bleach before using on any fabric.</p> <p>3) Check Manufacturers' Care Labels for special instructions.</p> <p>1) May be used on all kinds of fabrics. 2) Is most effective in hot water.</p>
<p>FABRIC SOFTENERS Rinse additive such as Downy™ brand</p> <p>Wash additive such as Rain Barrel™ brand</p>	<p>Mix recommended amount with one cup (240 ml) water and add at start of rinse cycle.</p> <p>Follow package directions. Add during wash cycle.</p>	<p>1) Helps make clothes fluffy and soft. 2) Reduces static electricity. 3) Use carefully. Too much may cause staining on some clothes. 4) Do not pour directly on clothes. 5) For those recommended for adding to the wash cycle, such as Rain Barrel™ brand, follow manufacturer's instructions exactly.</p>
<p>SANITIZER Chlorine bleach such as Clorox™ brand</p>	<p>Use in case of infection and contagious disease. See Bleach above.</p>	<p>Guards against infection by killing most bacteria and viruses.</p>
<p>WATER SOFTENER Non-precipitating such as Calgon™ brand</p> <p>Precipitating such as Borax™ brand</p>	<p>Follow package directions. Add at start of wash cycle.</p> <p>Follow package directions. Use with detergent in wash cycle.</p>	<p>Suspends hardness minerals in solution, keeping water clear.</p> <p>Combines with water hardness minerals to form precipitate which gives cloudy or milky appearance to water.</p>
<p>SOAK AGENT Such as Biz™ brand</p>	<p>Follow package directions.</p>	
<p>PRETREATING, STAIN AND SPOT REMOVERS Such as Spray'n Wash™ and K2R™ brands</p>	<p>Follow package directions. Treat only heavily soiled areas. Check garments' care labels for instructions.</p>	<p>CAUTION: Washer control panels and finishes may be damaged by some laundry pretreatment soil and stain remover products if such products are sprayed on or have direct contact with the washer. Apply these pretreatment products away from washer. The fabric may then be washed normally. Damage to your washer caused by pretreatment products is not covered by your warranty.</p>
<p>TINTS AND DYES Powdered such as Rit™ and Tintex™ brands</p>	<p>Follow package directions. NOTE: Tinted garments may not be colorfast. Wash separately.</p>	<p>Clean washer to avoid discoloration of next load. Go through complete cycle (5-minute wash) using hot water, 1/2 cup (120 ml) detergent, 1 cup (240 ml) bleach. Wipe exterior parts. CAUTION: Tinting may discolor plastic in washer. Subsequent washings will reduce discoloration but may never eliminate it.</p>

HARD WATER—DO YOU HAVE IT?

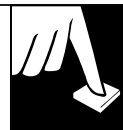

Before you can decide what to do about hard water, you need to know if you have it and, if so, how hard it is.

- If you live in a municipal area, contact your water company.
- If you live in a rural area, or in some suburban areas, contact your county agent.

The answer will be “you have ‘so many grains’ per gallon (3.8 liters)” which means:

0 to 3 grains per gallon (3.8 liters)—SOFT

4 to 10 grains—HARD

11 to 19 grains—VERY HARD

20 grains and over—EXTREMELY HARD

If your water is SOFT, you have no problem.

But, if you have more than 10 grains, you will need to soften your water with either...

1. An installed water softener in your home, or
2. The use of a packaged water softener.

HOW TO REMOVE STAINS

1. Try to remove stains as soon as possible.
The fresher the stain, the easier it is to remove.
 2. Before attempting to remove any stain, take these steps:
 - Find the fabric and the finish in the chart on the next page, and use only recommended methods.
 - Check the care label instructions that came with the garment.
- Test stain removal product on a hidden inside seam or on a sample of the material.
 - Avoid use of hot water on unknown stains. It can set some stains.
3. Follow stain removal with a thorough rinsing.
 4. Wash with recommended amount of detergent.

Stain Removal Hint—Using Chlorine Bleach for White and Bleachable Fabrics

Mix 1/4 cup (60 ml) chlorine bleach with one gallon (3.8 liters) of cool water—approximately 80°F. (27°C.)—in a sink or pan. Soak stained area for 5 minutes and launder in washer.

The Case of the “Invisible” Stain

Food or cooking oils on your synthetic garments may cause stains which are virtually invisible and which you may not notice as you put your clothes into the washer.

If these stains are not completely removed in the wash, the oily spots may pick up dirt from the wash water. Then they will become very visible and you may think they were caused by the wash cycle itself.

Once These Spots Become Visible, How Can You Remove Them?

- Rub in undiluted liquid detergent and let stand 30 minutes.
- Rewash using hottest water the fabric can stand.

How Can You Prevent These “After-You-Wash” Stains?

- Increase the amount of detergent normally used.
- Increase water temperature where fabric will permit.
- Wash synthetic garments more often.

(continued next page)



STAIN REMOVAL GUIDE

Stain	White and Bleachable Fabrics See Controls Setting Guide.	Other Washable Fabrics
Adhesives (Chewing Gum, etc.)	Rub with ice or immerse in very cold water. <i>Use dull tool to carefully scrape off as much adhesive or gum as possible.</i> Sponge with a safe dry cleaning fluid,* then launder.	Same as white and bleachable fabrics.
Antiperspirants, Deodorants	Apply undiluted liquid detergent. Rinse. If stain remains, bleach according to the Stain Removal Hint on previous page. If color has changed, you may be able to restore it by sponging with ammonia.** Rinse thoroughly.	Same as white and bleachable fabrics except use non-chlorine bleach.
Blood	Soak in cold water, then launder. If stain remains, bleach according to the Stain Removal Hint on previous page, launder.	Sponge or soak in cool water, then launder.
Chocolate, Cream, Ice Cream and Milk	Soak in cold water. Treat stain with a safe dry cleaning fluid*; Apply undiluted liquid detergent, launder, dry. Bleach according to the Stain Removal Hint on previous page, launder and dry.	Soak in cold water. Sponge with a safe cleaning fluid.* Apply undiluted liquid detergent. Launder.
Coffee and Tea	Without cream: Bleach according to the Stain Removal Hint on previous page. Launder. With cream: Follow guide directions for cream.	Sponge with warm water. If stain remains, apply warm glycerine, let stand 30 minutes and rinse well, or sponge with a safe dry cleaning fluid.* Launder.
Cosmetics: Eye Shadow, Lipstick, Mascara, Liquid or Pancake Makeup, Rouge, Powder; Crayon; Grease, Oil, Tar, Cod Liver Oil	Treat stain with safe dry cleaning fluid.* Apply undiluted liquid detergent; launder and dry. Bleach according to the Stain Removal Hint on previous page.	Sponge with a safe dry cleaning fluid.* Launder.
Fresh Fruit, Fruit Juices, Wine, Vegetables or Food Coloring	Soak stain in cool water. If stain remains, bleach according to the Stain Removal Hint on previous page, launder.	Sponge with warm water. Bleach remaining stain with non-chlorine bleach.
Grass, Foliage, Flowers, Mildew, Scorch	Apply undiluted liquid detergent. Launder. (Treat mildew spots while they are fresh, before mold has a chance to weaken fabric.) If either type stain remains, bleach according to the Stain Removal Hint on previous page, launder. (Severe scorch cannot be removed.)	Sponge with warm water. Apply <i>undiluted liquid detergent</i> . Bleach remaining stain with non-chlorine bleach, then launder. Old mildew stains can seldom be removed. Scorch can seldom be removed.
Ink, Ballpoint	Fresh stains: Place stain face down on an absorbent towel and sponge with dry cleaning fluid,* or use spray cleaner. Apply undiluted liquid detergent. Old stains: Bleach according to the Stain Removal Hint on previous page.	Same as white and bleachable fabrics except launder using non-chlorine bleach.
Perspiration	Apply undiluted liquid detergent and launder. If color has changed you may be able to restore it by treating with ammonia or vinegar.** If any stain remains, treat with safe dry cleaning fluid* or bleach according to the Stain Removal Hint on previous page, launder and dry.	Launder. Rinse well. Bleach with non-chlorine bleach.
Rust	Apply rust remover,** using manufacturer's directions. Rinse and launder.	Same as white and bleachable fabrics.



***CAUTION:** Because cleaning fluids tend to be toxic, be sure you are in a well ventilated room when using them. No cleaning fluid should be used unless user is familiar with the limitations and required cautions (usually printed on label). Use extreme caution with flammable compounds.

Under no circumstances should fabrics containing flammable materials (waxes, cleaning fluids, etc.) be washed in washer.

**Do not mix chlorine bleach with ammonia or acids such as vinegar and/or rust remover. Mixing can produce a toxic gas which may cause death.

Save and refer to garment manufacturer's care labels.

QUESTIONS? USE THIS PROBLEM SOLVER



PROBLEM	POSSIBLE CAUSE
WASHER OR DRYER WON'T START	<ul style="list-style-type: none"> • Make sure controls are properly set and washer Cycle Selector is pulled out or dryer START button is pushed. • Appliance unplugged. Make sure cord is firmly plugged into electrical outlet. • No power to appliance. Check fuses and circuit breakers to make sure appliance is getting current. • Dryer door is open. Dryer will not run with door open. Make sure washer lid is closed. Washer will fill but will not spin with lid open. • Make sure both hot and cold faucets are turned on.
WON'T DRAIN	<ul style="list-style-type: none"> • Kinked or pinched hose. Check and correct. • Top of drain outlet should be less than 8 feet above the floor.
WATER LEAKS	<ul style="list-style-type: none"> • Make sure hose connections are tight at faucets. • Make sure end of drain hose is correctly inserted into and secured to drain facility.
WASHER WON'T SPIN AND COMPLETE CYCLE	<ul style="list-style-type: none"> • Lid not closed. Washer will not progress through spin cycle with lid up. Make sure lid is closed. Lid will be automatically locked during spin portion for safety.
CLOTHES ARE ABNORMALLY WET AFTER SPIN	<ul style="list-style-type: none"> • Load may have been excessively out of balance. Redistribute clothes and rerun through final spin.
APPLIANCE IS NOISY	<ul style="list-style-type: none"> • Heavily unbalanced loads can cause the washer to vibrate excessively during spin, and may cause it to move from its original position. To correct, open the lid and redistribute the load evenly about the wash basket. Close the lid and restart. • Metallic "clicks" heard as timer advances during operation are normal. • Uneven floor. Make sure appliance is level and firm to floor.
WATER DOES NOT ENTER OR ENTERS SLOWLY	<ul style="list-style-type: none"> • Faucets turned off. Make sure faucets are on and adjusted correctly. • Hoses kinked. Check and correct. • Clogged screen in water valve. Unscrew fill hose from washer and clean screen if necessary. When reassembling, make hand tight plus 1/3 turn with pliers.
WATER TEMPERATURE INCORRECT	<ul style="list-style-type: none"> • Faucets not adjusted to give desired temperature. Readjust them. • Household water heater not set to deliver correct temperature—140° to 150°F. (60° to 66°C.). Reset it. • Water valve screens may be clogged. Remove inlet hoses from water valve. Clean the screens and reinstall the hoses. • Make sure selector controls are properly set. • Make sure hoses are connected to correct faucets—hot to hot, cold to cold.
WASHER PAUSES IN CYCLE	<ul style="list-style-type: none"> • Washer normally pauses about 1/2 minute in progressing from one portion of its cycle to the next. • Alternate pauses in the agitation are normal in the delicate wash cycle. Agitation will resume in 1-2 minutes. • The brief pause in the final spin of each cycle is normal operation for this washer.

(continued next page)



THE PROBLEM SOLVER

(continued)

PROBLEM	POSSIBLE CAUSE
GREASY OR OILY STAINS ON LAUNDERED GARMENTS	<p>These are sometimes called “Invisible Stains” because you may not notice them before washing clothes. However, if oily soils are not completely removed in wash cycle, the oily spots may pick up dirt from the wash water. The spots will then be very visible. They are not caused by the washer. Wash synthetic garments as soon as possible after wearing. Use more detergent than normal and hottest water fabric can stand. If spots appear, rub in undiluted liquid detergent, let stand 30 minutes and rewash using hottest water fabric can stand.</p>
YELLOWED CLOTHES	<ul style="list-style-type: none">• Incomplete removal of body soil due to constant use of insufficient detergent. Check hem of T-shirt or pillow case. If they are white and center is yellow, it contains body oil. Restore whiteness following procedures on “Grayed Clothes,” in this section.• Chlorine bleach may yellow some fabrics with resin finishes. Use oxygen bleach (such as Clorox 2™ brand). Refer to garment manufacturers’ care instructions. Restore color using color remover (such as Rit™ or Tintex™ brands), follow package directions.• Iron or manganese in water may cause overall yellowing or yellow spots.<ol style="list-style-type: none">1. Use extra detergent plus a non-precipitating water softener dissolved in water before adding clothes. Use non-chlorine bleach.2. Have a special filter or chemical feeder installed in your home to remove iron and manganese from water.3. Run hot water for a few minutes to clean iron residue buildup in lines; drain water heater occasionally.4. To remove spots: spread stained portion over pan of boiling water and squeeze lemon juice through stain. To remove overall yellow, use a commercially available rust scale remover, following package instructions.
BLUE OR GRAY COLOR STAINS	<ul style="list-style-type: none">• Improper use of fabric softener. Never pour fabric softener directly on clothes; always dilute before adding to rinse water. To remove stains: Dampen stained area and rub with undiluted liquid detergent. Re-wash, using chlorine bleach if safe for fabric.
GRAYED CLOTHES	<ul style="list-style-type: none">• Water is not hot enough for type of load. Make sure water heater is set to deliver hot water at the washer 140°–150°F. (60°–66°C.). Do not wash when other hot water needs—such as dishwashing or family baths—are heavy.• Poor or inferior detergent <p>Follow these steps:</p> <ul style="list-style-type: none">• Use water conditioner (such as Calgon™ brand).• Use hottest water possible.• Pretreat stains.• Use presoak aids.• Install water softener.• Washer overloaded. Clothes cannot move freely to loosen and remove soil, causing gray appearance. Follow correct loading procedures for size of loads.• Improper soaking, with insufficient detergent. Usually a 30-minute soak is sufficient. However, when using extended soaks for heavily soiled garments, you may need to use twice the recommended amount of detergent.• Washing too long may result in increased soil redeposition. Use shorter wash time for smaller loads.



PROBLEM	POSSIBLE CAUSE
GRAYED CLOTHES (continued)	<ul style="list-style-type: none">• Detergent dissolves too slowly. It is important that detergent be present in the wash solution at the start of wash agitation. <p>To restore grayed clothes—</p> <p>Most grayed clothes can be at least partially restored by the following procedure:</p> <ul style="list-style-type: none">(a) Put clothes in washer.(b) Fill with HOT water. Check manufacturers' hang tags to determine if hot water is suitable for garment.(c) Add a non-precipitating type of water softener such as Calgon™ brand with phosphate. Use 2½ times as much as you need for normal water softening.(d) Do not add detergent.(e) Allow clothes to go through complete cycle.(f) Repeat, if necessary.(g) If you prefer to soak clothes, use water softener in place of soak agent or pre-wash detergent and allow clothes to soak for about 20 minutes.
HEAVILY SOILED AREAS such as collars and cuffs	<ul style="list-style-type: none">• Pretreat with liquid detergent.
LINT OR RESIDUE ON CLOTHES IN CYCLE	<ul style="list-style-type: none">• Incorrect sorting of clothes. Separate lint-producers (such as terry towels and chenille) from lint-receivers (such as man-made fabrics, velveteen, corduroy).• Washing too long, especially for smaller loads. For normal soil, use 1 minute per pound of dry clothes.• Use of non-phosphate detergents which combine with hardness minerals in water to form a precipitate which can be mistaken for lint.• Use phosphate detergent or liquid detergent; use warmer wash water or soften water with an installed mechanical softener or a packaged water softener.• Undissolved granular detergent may leave powdery residue on fabrics which can be mistaken for lint.<ul style="list-style-type: none">(a) See Detergent Guide for recommendations on how to add detergent to speed up complete dissolving.(b) Use a liquid or special cold water detergent.(c) Predissolve granular detergent in hot water, or make sure detergent is dissolved completely in wash water before adding clothes.(d) Make certain clothes have ample room to move in washer.(e) Use a warmer wash water.• Overloading of washer will cause abrasion which creates excessive lint. Wash fewer items in each load. Make sure water level is correct for size of load.• Too much bleach. Over-bleached items, such as towels, will shed excessive lint. Use correct amount of bleach according to package directions.• Not enough detergent. Enough detergent must be used to hold lint in suspension during wash cycle. Increase amount of detergent used. Amount is determined by water hardness, size of load, degree of soil and amount of water. See Detergent Guide.• Incorrect use of fabric softener. If used in wash cycle, many softeners may react with detergent to create a white deposit. Use fabric softeners only in rinse cycle.• Pilling, usually on polyester-cotton blends, is caused by normal wear and may look like lint. Turning clothes inside out may help.• Static electricity caused by overdrying will cause attraction. Use fabric softener in rinse cycle.

(continued next page)



THE PROBLEM SOLVER

(continued)

PROBLEM	POSSIBLE CAUSE
LINT OR RESIDUE ON CLOTHES IN CYCLE (continued)	To correct— All residue except pilling can usually be removed from garments through use of correct laundry procedures.
SNAGS, HOLES, TEARS, RIPS OR EXCESSIVE WEAR <i>There is no solution once this type of damage has occurred.</i>	<ul style="list-style-type: none">• Pins on garments or sharp objects left in pockets. Remove all pins, check pockets of all garments before putting in washer. Also check washer to see if any objects remained in wash tub.• Snaps, hooks, sharp buttons, belt buckles, zippers. Make sure all hooks, snaps and buttons are fastened. Remove sharp buttons and belt buckles. This is very important when washing knits, which snag easily. Turn knits inside out.• Improper use of chlorine bleach. Holes may have random square shape; yellow discoloration, fabric will be weak at edges of hole.<ul style="list-style-type: none">(a) Use only correct, measured amount of bleach.(b) Never add undiluted bleach to washer tub nor allow clothes to come in contact with undiluted bleach. Do not wipe up bleach spills with clothes.(c) Damage from chemicals such as hair preparations (bleach, dye, home permanent solution), battery acid, some toilet bowl cleaners. Immediately rinse towels and other articles thoroughly which have come in contact with these chemicals before putting them in washer. Avoid contaminating items of clothing with such chemicals.• Small, unnoticed holes, tears or ripped seams may enlarge during washing. Check garments carefully before loading washer and mend all rips and tears.• As permanent press garments age, they may show fraying at collars and cuffs. This is due to the weakening of the fibers by the permanent press process. It is not caused by the washer. You can slow this process by washing small permanent press loads with a large water level. Do not wash heavy items, such as towels, with permanent press. When possible, remove collar stays.• Roughness or burrs on agitator due to damage incurred by heavy belt buckles, etc. Examine agitator for roughness or burrs and smooth by filing if necessary.• May be using wrong cycle for delicate fabrics. Use delicate cycle. Refer to garment manufacturer's care instructions.• Garments weakened by aging, sun or atmosphere. This is an inevitable process and is not caused by the washer. You may slow down process by use of delicate cycle.• Too little water in washer or too large a load. Load washer only with the number of items that will move freely. Select correct water level.
WRINKLING IN PERM PRESS AND "NO-IRON" ITEMS	<ul style="list-style-type: none">• Leaving clothes in dryer after tumbling stops. Immediately after dryer stops tumbling, remove clothes and place them on hangers.• Too many items in dryer. Dry only one washer load at a time. Do not combine loads.• Too few items in dryer. If drying only one article, add two or more similar articles, even if dry, to insure proper tumbling.• Improper loads. Avoid laundering heavy permanent press items, such as work clothes, with lighter permanent press items such as shirts or blouses. Also do not wash or dry permanent press items with regular laundry.• Too many items in washer. Items must have room to move freely. Permanent press loads should always be smaller than regular loads...no more than medium loads.• Use of incorrect wash and dry cycles. Use Permanent Press wash cycle which provides a cool-down rinse to minimize wrinkling. Also, use automatic dry cycle.



PROBLEM	POSSIBLE CAUSE
WRINKLING IN PERM PRESS AND "NO-IRON" ITEMS (continued)	<ul style="list-style-type: none">• Incorrect water level. Use high level for medium load; medium level for small load.• Repeated washing in too hot water. Wash in cold or warm water with plenty of detergent.• Accumulation of lime scale due to use of carbonate detergents. Avoid the use of a carbonate-built detergent. <p>To remove stubborn wrinkles—</p> <ul style="list-style-type: none">• Retumble small loads on automatic dry setting.• Rinse and dry on automatic dry setting.• If unsuccessful, retumble on high heat for 10-12 minutes and hang immediately.• Iron carefully.• Send to cleaners for pressing.• Some wrinkles may remain which cannot be removed*. <p>*NOTE: If you follow good laundry procedures and permanent press clothes still come out wrinkled, the finish may not be good quality. Also, in permanent press synthetic/cotton blends, the cotton portion of the fabric can eventually wear away leaving only the synthetic. Since the cotton has resin finish that imparts the memory, a loss or decrease of permanent press performance will result.</p>
SHRINKAGE, GENERAL	<ul style="list-style-type: none">• Some fabrics will shrink whether washed in a washer or by hand; others may be safely washed but will shrink in a dryer. Follow garment manufacturers' care instructions exactly. If in doubt, do not machine wash or dry.
SHRINKAGE, KNITS	<ul style="list-style-type: none">• Relaxation shrinkage can occur in knit fabrics that have been improperly stretched and elongated by the manufacturer. When this occurs, garment may be pressed back into shape after each wash and dry cycle.• Progressive or delayed shrinkage is caused when starch or sizing (in some fabrics) is gradually removed by laundering. May be noticed in older garments that have been washed many times without previous shrinkage. Treat as for Relaxation Shrinkage above.• Shrinkage caused by overheating occurs in certain knit fabrics that have been heat-shaped. When washing, drying or ironing temperatures exceed the temperatures used to set the shapes, shrinkage may occur. This cannot be corrected, but it can be prevented by washing in cool or warm water; drying on low or delicate heat.
CLOTHES TAKE TOO LONG TO DRY	<ul style="list-style-type: none">• Controls improperly set. Check all controls to make sure they are correctly set for the load you want to dry.• Improper ducting. Make sure dryer is ducted in accordance with Installation Instructions.• Obstruction in exhaust ducting. Make sure ducting is clean and free of obstruction; make sure damper in outside wall cap operates easily. If metal flexible ducting is used, be sure it is not kinked and it is installed according to Installation Instructions.• Blown fuses or tripped circuit breakers. Check household fuses or circuit breakers. Most electric dryers use two. It is possible for one to be blown or tripped, and the dryer to still tumble without heat.• Improper sorting. Do not mix heavy, hard-to-dry items with lightweight articles.• Too many items in dryer. Dry only one washer load at a time. Do not combine loads.• Too few items in dryer. If drying only one article, add two or more similar articles even if dry, to insure proper tumbling.• If your dryer is operating on a 208-volt circuit, longer drying times can be expected.• Clothes were excessively wet when they were put into the dryer.
WASHER OR DRYER WON'T START	<ul style="list-style-type: none">• Dryer door is open. Dryer will not run with door open. Make sure lint filter is in proper position. Make sure washer lid is closed. Washer will fill but will not spin with lid open.

If you need more help...call, toll free: GE Answer Center® 800.626.2000 consumer information service

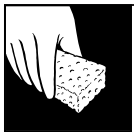

CARE AND CLEANING

USER MAINTENANCE INSTRUCTIONS

- Wipe the cabinet with a damp cloth. Occasionally wash it with mild soap and water and then apply a light coat of appliance polish to help preserve the finish.
- Keep the area around and underneath your appliance free of combustible materials such as lint, paper, rags, chemicals, etc.
- Keep the floor around your appliance clean and dry to reduce the possibility of slipping.

For long vacations

Be sure water supply is shut off at faucets. Drain all water from hoses if the appliance will be exposed to freezing weather.

Winterizing instructions:

The washer cannot be operated in freezing temperatures. Before you store the appliance, remove water from all parts of the washer.

1. Turn off water supply faucets. (The front access panel between washer and dryer may have to be removed. See procedure at right.) Disconnect hoses from faucets and drain.
2. Add 1 gallon (3.8 liters) of non-toxic RV antifreeze (available from a hardware or recreational vehicle store) to the washer tub.
3. Push the Cycle Selector in, turn the knob to the right to SPIN and pull the knob out.
4. Let the washer spin for 1 or 2 minutes to let all the water drain out. Some but not all of the RV antifreeze will be expelled.
5. Push in the Cycle Selector, disconnect the electrical plug, dry the tub interior, close the lid.
6. Store the appliance in an upright position.
7. Before reusing washer, after storage, run washer through a cycle to rinse out the antifreeze.

Washer

- **The self-cleaning lint filter** needs no attention from you. See How to Operate Your Washer section.
- **Wash tub.** After each use, leave the lid open to allow moisture to evaporate. Clean thoroughly with nonabrasive household cleanser to remove deposit left by heavily soiled clothes. Do not use harsh, gritty or abrasive cleaners.

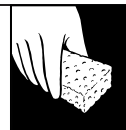

Dryer

If your dryer is exhausted to the outside, inspect and clean the dryer exhaust ducting at least once a year.

A clothes dryer produces combustible lint. When the dryer is not exhausted to the outside, this lint is more apt to accumulate in and near the dryer, which could create a fire hazard.

How to reduce the possibility of a fire hazard, if your dryer (Gas dryers must be exhausted outside) is not exhausted to the outside:

- Clean the lint filter before every load. See How to Operate Your Dryer section.
- Inspect the area behind your front access panel at least once a year and clean out any lint that may have accumulated. Wipe or vacuum, being careful not to disturb any of the electrical mechanical connections.

How to remove the front access panel between the washer and dryer

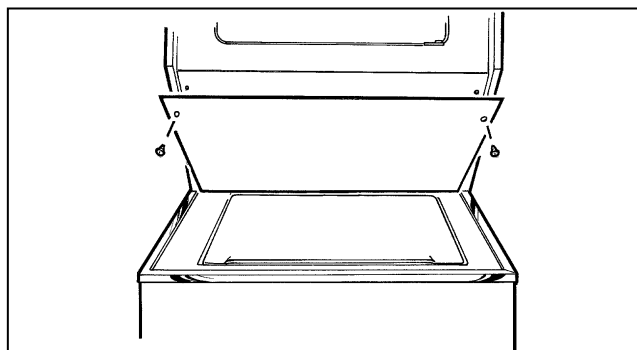

Remove two Phillips-head screws at top of panel.

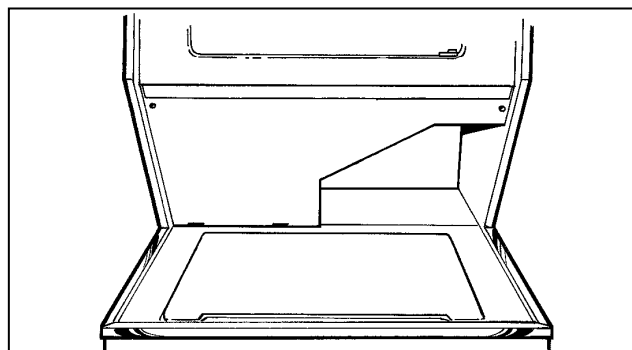

Lift access panel up until tabs at sides of panel slip out of slots at sides of dryer.

To replace access panel, fit tabs on panel into slots at sides of dryer, push panel back in place and replace screws.

NOTES

NOTES

YOUR GE SPACEMAKER™ LAUNDRY WARRANTY

Staple sales slip or cancelled check here. Proof of original purchase date is needed to obtain service under warranty.

WHAT IS COVERED

FULL ONE-YEAR WARRANTY

For one year from date of original purchase, we will provide, free of charge, parts and service labor in your home to repair or replace **any part of the Spacemaker™ laundry** that fails because of a manufacturing defect.

LIMITED ADDITIONAL FOUR-YEAR WARRANTY

For the second through fifth year from date of original purchase, we will provide, free of charge, replacement parts for **any part of the washer transmission** that fails because of a manufacturing defect. You pay for the service trip to your home and service labor charges. Or, if you desire, we will provide a **completely reconditioned transmission**. You pay for the shop reconditioning labor, the service trip to your home and service labor charges.

This warranty is extended to the original purchaser and any succeeding owner for products purchased for ordinary home use in the 48 mainland states, Hawaii and Washington, D.C. In Alaska the warranty is the same except that it is LIMITED because you must pay to ship the product to the service shop or for the service technician's travel costs to your home.

All warranty service will be provided by our Factory Service Centers or by our authorized Customer Care® servicers during normal working hours.

Should your appliance need service, during warranty period or beyond, call 800-GE-CARES (800-432-2737).

WHAT IS NOT COVERED

- Service trips to your home to teach you how to use the product.

Read your Use and Care material.

If you then have any questions about operating the product, please contact your dealer or our Consumer Affairs office at the address below, or call, toll free:

GE Answer Center®
800.626.2000
consumer information service

- Improper installation.

If you have an installation problem, contact your dealer or installer. You are responsible for providing adequate electrical, plumbing, exhausting and other connecting facilities.

- Replacement of house fuses or resetting of circuit breakers.
- Failure of the product if it is used for other than its intended purpose or used commercially.
- Damage to product caused by accident, fire, floods or acts of God.

WARRANTOR IS NOT RESPONSIBLE FOR CONSEQUENTIAL DAMAGES.

Some states do not allow the exclusion or limitation of incidental or consequential damages, so the above limitation or exclusion may not apply to you. This warranty gives you specific legal rights, and you may also have other rights which vary from state to state. To know what your legal rights are in your state, consult your local or state consumer affairs office or your state's Attorney General.

Warrantor: General Electric Company

**If further help is needed concerning this warranty, write:
Manager—Consumer Affairs, GE Appliances, Louisville, KY 40225**

WSM2700
WSM2780

Printed in the United States

Free Manuals Download Website

<http://myh66.com>

<http://usermanuals.us>

<http://www.somanuals.com>

<http://www.4manuals.cc>

<http://www.manual-lib.com>

<http://www.404manual.com>

<http://www.luxmanual.com>

<http://aubethermostatmanual.com>

Golf course search by state

<http://golfingnear.com>

Email search by domain

<http://emailbydomain.com>

Auto manuals search

<http://auto.somanuals.com>

TV manuals search

<http://tv.somanuals.com>