



Ampli DECT 150 Ampli DECT 300



DEEMARC
CLEARSOUND[®]
HEAR THE DIFFERENCE

CAUTION: THIS TELEPHONE PRODUCT IS SPECIFICALLY DESIGNED FOR PEOPLE WITH HEARING DIFFICULTIES AND IS PROVIDED WITH A HANDSET EARPIECE WITH VOLUME CONTROL FOR INDIVIDUAL REQUIREMENTS. DUE CARE MUST BE TAKEN BY ALL USERS THAT THE HANDSET EARPIECE VOLUME CONTROL IS SET TO THE LOWEST LEVEL ACCEPTABLE BY EACH RESPECTIVE USER. CARE SHOULD THEREFORE BE EXERCISE TO ENSURE THAT ANY NEW USERS ARE FAMILIAR WITH THIS REQUIREMENT.

CONTENTS

CONTENTS

CONTENTS	1	PHONE BOOK	25
INTRODUCTION	3	Create a Phone Book Entry	26
Unpacking the Telephone	4	Dialing using the Phone Book	27
		Modify a Phone Book Entry	27
		Delete a Phone Book Entry	28
DESCRIPTION	5		
General Description	5	CALLER DISPLAY	29
		View Caller Display	29
INSTALLATION	12	Dial a Number from the Caller Display List	30
Location	12	Delete an Entry from the Caller Display List	30
Setting Up	13	Store Names and Numbers into the Phone Book	31
Battery Use	13		
BASE SETTINGS	14	ANSWERING MACHINE (AMPLI DECT 300)	32
Base Ringer Volume	14	Operating the Answering Machine from the Handset	32
		Answering Machine Settings	37
HANDSET SETTINGS	15	Operating the Answering Machine Remotely	40
Ringer Settings	15	Answer Only Mode	42
Shaker Settings	17		
Handset Registration	17	ADDITIONAL HANDSETS & BASES	43
Technical Settings	18	Using Several Handsets	43
		Internal Calls	46
USING THE TELEPHONE	20	Call Transfer	46
Making a Call	20	Using Several Bases	47
Receiving a Call	20	Other Optional Accessories	48
Recalling Recent Numbers	21		
Deleting Recent Numbers	21	TROUBLESHOOTING	49
Receiving Volume and Tone Adjustment	22		
Paging the Handset	24	RESTORE FACTORY SETTINGS	51
Call Timer	24	SAFETY INFORMATION	52
		GUARANTEE	53

INTRODUCTION

Congratulations on purchasing your Geemarc Ampli DECT telephone. This telephone offers all the advantages of cordless technology (compliant with Digitally Enhanced Cordless Telecommunications-DECT standard) coupled with features which maximize clarity and minimize feedback throughout a telephone call and provide an overall increase in the usefulness of the telephone. These features include extra volume and tone, visual and vibrator ringer and a super loud ringer for the base

Its is important that you read the instructions below in order to use your Geemarc telephone to its full potential. Keep this user guide in a safe place for future reference.

This guide explains how to use the following telephones:

Ampli DECT150 Ampli DECT300



Information about the answering machine is only relevant to the Ampli DECT300.

This guide applies to single and multiple handset systems.

INTRODUCTION

Unpacking the Telephone

When unpacking the telephone, you should find the following in the box:

- 1 Ampli DECT150/300 handset
- 1 Ampli DECT150/300 base
-  Mains power adaptor
-  Telephone line cord
-  Belt clip
- 2 x AAA rechargeable batteries
- 1 Battery compartment cover



For product support and help visit our website at www.geemarc.com
Telephone 01707 384438
Or fax 01707 372529

DESCRIPTION

General Description

Handset Description

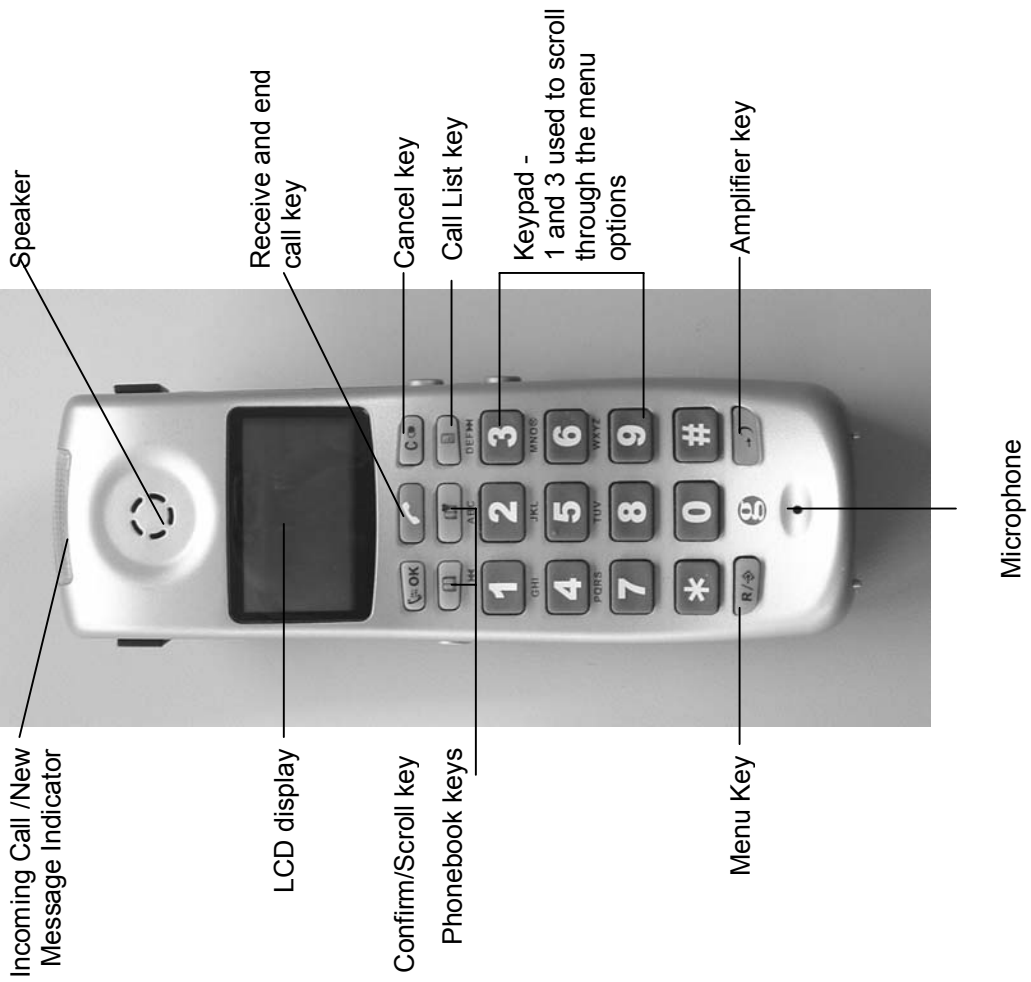

DESCRIPTION

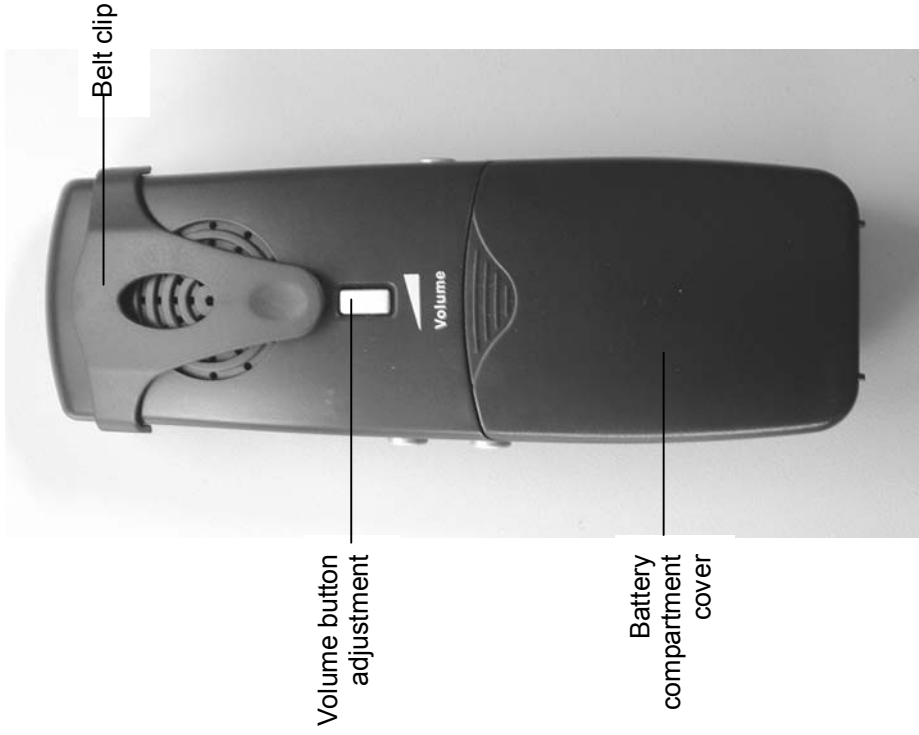

DESCRIPTION

Base Description



DESCRIPTION

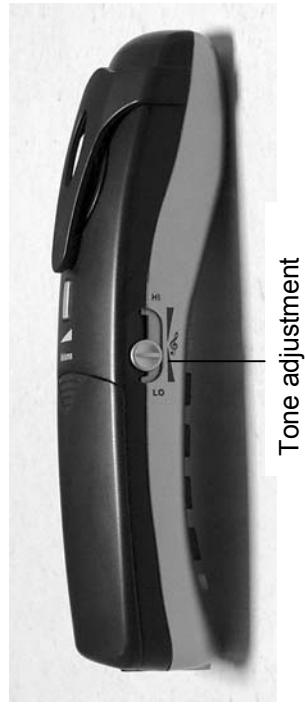
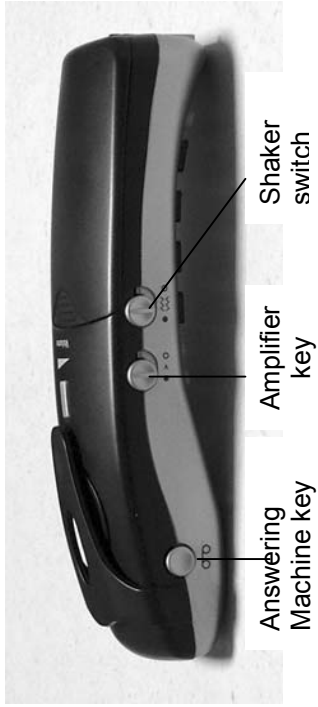

DESCRIPTION

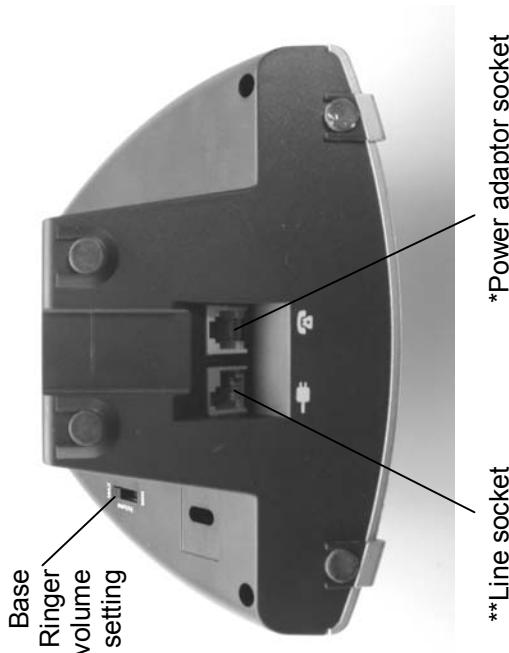

(*)Classified "hazardous voltage" according to EN60950 standard
 (**) Classified TNV-3 according to EN60950 standard

DESCRIPTION

LCD Screen Description

The LCD screen is split into two distinct areas:

The icon area. This is found around the outside of the screen. This displays the various system icons which help you to use the telephone.

The main area. This is found across the centre of the screen. It displays the following:

- number being dialled
- call display information
- phonebook

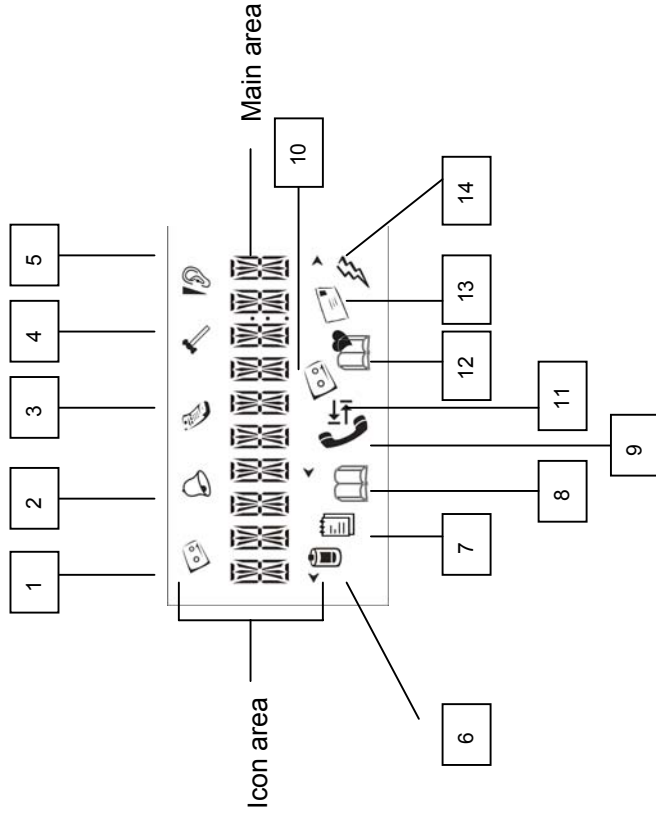

- 1** Answering Machine Menu
- 2** Ringer Volume/Melody Menu
- 3** Handset Registration Menu
- 4** Technical Settings Menu
- 5** Earpiece Volume Adjustment
- 6** Battery Charge Level
- 7** Caller Display Numbers (and Names)
- 8** Phone book 1
- 9** Flashing= Incoming Call, Fixed=During a call
- 10** Answering Machine activated
- 11** Call Transfer
- 12** Phone Book 2
- 13** (New) Answering Machine Message
- 14** Flashing= Handset not registered to the base, Fixed= Handset registered to the base

LCD Screen Navigation

The **R/↔** key is used to activate and deactivate the menu.

The **1** and **3** keys are used to scroll through the menu.

- 1** : move backward through the menu
- 3** : move forward through the menu

The **OK** key is used to confirm an action or choice on a screen. This key is also used to scroll through some submenus.

The **C** key is used to cancel an action/entry.

Location

Ensure you situate the telephone close enough to the power socket so that the cable will reach safely without stretching. Also, the mains power needs to be easily accessible in case you need to disconnect the power.

Make sure the telephone is at least 1 metre away from other electrical products e.g. TV, radio and monitors so as to avoid interference. Also, avoid direct heat and sunlight.

We advise you to place the telephone on a table cloth or similar, as the rubber feet on the base can mark some surfaces

Handset Range

The telephone has a range of up to 300 metres. The range will be reduced when there is no clear line of sight between the base and handset. Place the base as high yet as practical as possible to ensure the best signal between the base and the handset. A warning signal (beep) will be heard when the handset is out of range, the call will be stopped if the handset is not brought nearer to the base.

Setting Up

Plug the power cable into the power socket on the base. Plug the adaptor into the mains supply and switch the supply on. (*) The Power/Charging indicator lights up (green).

Connect the line cord plug to the line socket on the base. Connect the other end of the line cord to the PTT socket. (**)

Install the rechargeable batteries in the handset. The handset requires two Nickel Metal Hydride (NiMH) AAA batteries. These are supplied with your telephone. Check the battery polarity diagrams on the handset when inserting the batteries. Fit the battery cover (this can be found in the packaging with the batteries).

Place the handset on the base, a short beep will be heard. The Power/Charging indicator lights up (red). The battery symbol  will be displayed on the handset. This will flash during the charging process. Once the handset is fully charged, the display will show a full battery symbol and will stop flashing.

The phone has an automatic charging control to avoid excessive charging.

Before the handset can be used, the handset battery must be charged for a minimum of 15 hours on the Ampli DECT base.

Battery Use

If the handset battery symbol is empty and flashing  and you hear a warning beep you will need to recharge your handset before you can use it. If the phone does not have enough power or is not completely recharged, it will switch itself off automatically until it is returned to the base.





Under ideal conditions, the handset battery should give about 8 hours talktime or 170 hours standby on a single charge.

(*) Classified "hazardous voltage" according to EN60950 standard

(**) Classified TNV-3 according to EN60950 standard.

Base Ringer Volume

A slider switch located on the rear of the telephone base allows the base ringer volume to be adjusted. The following settings are available:

-  Off
-  Min
-  Mid
-  Max

HANDSET SETTINGS

Ringer Settings

Ringer Volume

There is a choice of four handset ringer volume levels.

Ringer Melody

There is a choice of seven handset ringer melodies to notify you of incoming calls.

Phone Book One Ringer Settings

There is a choice of seven handset ringer melodies for phone book 1. The selected melody will notify you that the incoming call is from a telephone number stored in phone book 1. This setting is only relevant if you have subscribed to a Caller Display service.

Phone Book Two Ringer Settings

There is a choice of seven handset ringer melodies for phone book 2. The selected melody will notify you that the incoming call is from a telephone number stored in phone book 2. This setting is only relevant if you have subscribed to a Caller Display service.

HANDSET SETTINGS

Press **R/↔** to activate the menu

Use **1** and **3** to scroll through the menu to find the desired ringer icon - . The selected icon will flash on the display.

Press **OK** to scroll through the ringer volume/melody menu until you reach the required level:

1/4 - the volume menu

Use **1** and **3** to scroll through the 4 volume levels available to find the desired volume

++++ = maximum volume + = minimum volume

2/4 - the melody menu

Use **1** and **3** to scroll through the 7 melodies available to find the desired melody

3/4 - the melody for phone book 1 menu.

The  icon will flash while in this menu

Use **1** and **3** to scroll through the 7 melodies available to find the desired melody

4/4. - the melody for phone book 2 menu

The  icon will flash while in this menu

Use **1** and **3** to scroll through the 7 melodies available to find the desired melody

Press **OK** to confirm the settings and exit ringer volume/melody submenu

Press **R/↔** to exit the menu and return to the standby position

HANDSET SETTINGS

Shaker Settings

A switch located on the right side of the telephone handset allows the shaker to be activated when receiving an incoming call.

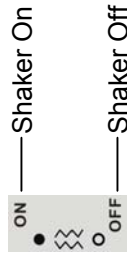

Handset Registration

The handset that came with your base is already registered to the base (factory setting). The  icon will be fixed on the display. If this icon is flashing, the handset is not registered to the base and you will need to register it. (See Additional Handsets and Bases section).

HANDSET SETTINGS

Technical Settings

Caller Display Settings

There is a choice of two Caller Display settings:
1 for UK
2 for France

Dialling Mode (Tone/Pulse) Settings

In the UK, all telephone exchanges now use Tone dialling. The Tone/Pulse setting is pre-set to Tone on your telephone. If your phone does not dial out, it is probably being used from an older private switchboard (PBX). In this case, the Tone/Pulse setting must be changed to Pulse.

Telephone Network Settings

There is a choice of four telephone network settings. These settings are used to match the signal level when working on different telephone networks.

- A = Factory Setting – default value
- B = Normal
- C = Low
- D = Very Low

Flash Time Settings

Your telephone works with a flash time setting for United Kingdom (R=100ms). In France, flash time setting should be R=300ms.

Dial Pause Settings

This setting enables you to insert a 3 second pause after the first digit dialed. The rest of the telephone number is dialed normally. This can be used when plugged in at a private telephone exchange (in a hotel, an office etc).

HANDSET SETTINGS

Press **R/↔** to activate the menu

Use **1** and **3** to scroll through the menu to find the desired ringer icon - . The selected icon will flash on the display

Press **OK** to scroll through the technical settings menu until you reach the required level:

1/5 – the Caller Display Settings menu

Use **1** and **3** to scroll through the 2 options available until you find the required option:

2/5 – the TONE/PULSE settings menu

Use **1** and **3** to scroll through the 2 options available until you find the required option

3/5 – the telephone network settings menu

Use **1** and **3** to scroll through the 4 options available until you find the required option

4/5 – the flash time settings menu.

Use **1** and **3** to scroll through the 2 options available until you find the required option

5/5 – the dial pause settings menu

Use **1** and **3** to scroll through the 2 options available until you find the desired option.

Press **OK** to confirm the settings and exit technical settings submenu

Press **R/↔** to exit the menu and return to the standby position

USING THE TELEPHONE

Making a Call

Pick up handset.
Press 

When you hear dialling tone, dial the number on the keypad. You can press  to cancel an incorrect entry

To end the call simply press  again or place the handset on the base

Pre-Dialling

Pick up handset. Dial the number on the keypad. You can press  to cancel an incorrect entry

Press , the number is automatically dialled

To end the call simply press  again or place the handset on the base

Receiving a Call

When an incoming call is received, proceed as follows:



Pick up handset. Press  to take the line and speak

To end the call simply press  again or place the handset on the base

USING THE TELEPHONE

Recalling Recent Numbers

You can call back any of the last 5 numbers dialled as follows:

- Press .
- Use **1** and **3** to scroll through the list in order to find the number you wish to dial.
- Press  and the number will be dialled automatically.

NOTE: To exit this menu at any time, press .

Deleting Recent Numbers

- Press .
- Use **1** and **3** to scroll through the list in order to find the number you wish to delete.
- Press **6** and the number will be deleted. A short beep will be heard as a means of confirmation.
- Press  to exit the menu and return to the standby position.

USING THE TELEPHONE

Receiving Volume and Tone Adjustment

You can alter the receiving volume and tone according to your hearing requirements.

Use the Volume button at the rear of the telephone handset to adjust the level according to your hearing requirements. . The volume can be adjusted in four stages using this button.

The **Amplify** switch on the right side of the telephone handset provides additional amplification. 

 = OFF

 = ON



Use the Tone slide switch on the left side of the telephone handset to adjust the bass/treble according to your hearing requirements. This function is not available when in loud speaker mode when using the answering machine.



Setting a Default for Amplification.

The amplify switch on the right of the telephone handset allows the amplification facility to be switched ON or OFF as a default each time you use the telephone.

Amplify Switch at ON Position ●

The additional amplification and tone controls are automatically activated each time you use the telephone. The Amplify key  will be lit. If  is not lit, press it to activate the additional amplification and tone controls.

USING THE TELEPHONE



Pressing the Amplify key  during a call will turn off the additional amplification and tone controls. However, you can still adjust the handset receive volume with the Volume button at the rear of the handset.

VOLUME

16db  20db  24db  28db

Bass +10db Max   Treble +10db max

Amplify Switch at OFF Position

The additional amplification is deactivated each time you use the telephone. The Amplify key  will be lit. The tone controls and volume button are still activated. If  is not lit, press it to activate the tone controls.

Pressing the Amplify key  during a call will turn off the tone controls. However, you can still adjust the handset receive volume with the Volume button at the rear of the handset.

VOLUME

4db  8db  12db  16db

TONE

Bass +10db Max   Treble +10db max

USING THE TELEPHONE

Paging the Handset

If you wish to locate the handset simply follow the instructions below:

Press , located on the front of the base

All registered handsets will be paged and will ring

Press  twice on the located handset to stop paging mode.
Alternatively, pressing  stops paging mode

Call Timer

The call time counter will be displayed a few seconds after the phone number is connected and starts ringing.

PHONE BOOK



Names and phone numbers can be stored in the two phone books available on the telephone.

If you have subscribed to a Caller Display service and if the caller name and number have been stored in the phonebook, the name and the number of the caller will be displayed during the incoming call.

There are two phone books on this telephone. Each phone book can contain 10 entries. One phone book could be used for friends and family numbers, the other for business contacts. The entries in both phone books are sorted alphabetically. Each name can contain up to 10 characters and each phone number can contain up to 25 digits.

Phone Book Handset Melody Settings

It is possible to have a different ring tone for each of the phone books. If you have subscribed to a Caller Display service, you will be able to differentiate between calls from the two phone books.

1. Normal phone calls – not stored in either phone book
2. Calls from names and phone numbers in the first phone book 
3. Calls from names and phone numbers in the second phone book 

IMPORTANT:

Even if a caller is stored in a phone book, the normal ring tone may be triggered as the caller may have used the private number function. See Ringer Settings section to change the ringer melodies for either phone book.

Key	Characters	Key	Characters
1	(space) - 1	6	MNO6
2	ABC2	7	PQRS7
3	DEF3	8	TUV8
4	GHI4	9	WXYZ9
5	JKL5	0	0

PHONE BOOK

Create a Phone Book Entry

You can store 20 entries into the two phone books with the name and phone numbers of your correspondent.



Enter the telephone number (and code) you wish to store – up to 25 digits

Select one of the two phonebooks you wish to store the number in.  or 

A beep will be heard and the phone book icon selected will flash

Enter a name corresponding to the telephone number. The name can contain up to 10 characters

Select the desired letter by pressing on the corresponding key on the numerical keypad. You can use the table above or the letters printed on the keypad to help you.

 or  will confirm your key entry and allow you to enter the next character.

e.g to enter BOB – press B  O  B. Alternatively, pause between each key entry. The pause allows you to enter the next character.

Use  to correct an incorrect character

Press  to store the entry. A beep will be heard to confirm storage

Note: To leave the phonebook press  or .



PHONE BOOK

Dialling Using the Phone Book

Select the desired phonebook by pressing  or .

Use **1** and **3** to scroll through the phonebook to find the number you wish to dial

Press . The number will be dialled automatically

Note: To leave the phonebook press  or .

Modify a Phone Book Entry

Select the desired phonebook by pressing  or .

Use **1** and **3** to scroll through the phonebook to find the number you wish to dial

Press 

The number will be displayed. Digits can be deleted pressing 

Enter the new number and press  to store

PHONE BOOK

Delete a Phone Book Entry

Select the desired phonebook by pressing  or .

Use **1** and **3** to scroll through the phonebook to find the number you wish to dial

Press 

The telephone number will be displayed. Press **6** to delete the entry

OK?

Press  to confirm. A beep will be heard by means of confirmation

CALLER DISPLAY

The features described in this section are only available if you subscribe to a Caller Display service from your network provider.

Caller Display means you can see who is calling on your handset display (provided the number is not withheld, unavailable or is an international call). If you have stored a name to go with the number in your handset phonebook, the corresponding name will be displayed with the correct phonebook ringer melody.

The display shows ***** for a withheld number.

Whether you take a call or not, the caller's details are stored in the Call list. The call list stores the last 10 incoming calls. When the call list memory is full, a new call will take the place of the oldest call. You can display, scroll through, dial and copy numbers in the list.

Note: The  symbol will be shown on the handset display if you receive a call in your absence

View Caller Display List

Press the Call List key 

Use **1** and **3** to scroll through the call list. Name will be displayed if present in the phone book, otherwise number will be displayed. Two short beeps will be heard if you reach the end of the list

Press  to display the telephone number

Press  to display the date and time of the call

Press  to exit and to return to standby

CALLER DISPLAY

Dial a Number from the Caller Display List

Press the Call List key 

Use **1** and **3** to scroll through the call list to find the number you wish to dial

Press . The number will be dialled automatically

Press  to exit and to return to standby

Delete an Entry from the Caller Display List

Press the Call List key 

Use **1** and **3** to scroll through the call list to find the number you wish to delete

Press **6** to delete the entry. A short beep will be heard by means of confirmation

Press  to exit and to return to standby

CALLER DISPLAY

Store Names and Numbers into the Phone Book

Press the Call List key 

Use **1** and **3** to scroll through the call list to find the number you wish to store

Select one of the two phonebooks you wish to store the number in



Enter a name corresponding to the telephone number. The name can contain up to 10 characters

Select the desired letter by pressing on the corresponding key on the numerical keypad

Use **C** to correct an incorrect character

Press **OK** to store the entry. A beep will be heard to confirm storage

ANSWERING MACHINE

This chapter is only relevant for the Ampli DECT 300.

Your Ampli Dect 300 answering machine can be operated from either:

- the handset
- remotely from any external telephone.

The default setting for the answering is On.

Operating the Answering Machine from the Handset

You can use any registered handset to switch your answering machine on and off, hear your messages and adjust the answering machine settings.

Activate and Deactivate the Answering Machine

Press **9** button located on the right side of your telephone

Press **7** to activate, the  icon is displayed. A tone will be heard for confirmation. The answering machine can now record messages

O R

Press **9** to deactivate, the  icon is not displayed. A tone will be heard for confirmation

Press **9** to exit

NOTE: The answering machine can only be activated/deactivated whilst there are no messages being read.

ANSWERING MACHINE

Listening to Messages

 icon will flash when you have a new message. The new message indicator will also be lit.

 icon will be displayed, however, not flashing when you have messages that you have listened to but not deleted.

ANSWERING MACHINE

Listening to Messages

Press **9** button located on the right side of your telephone

The number of messages, the day of the week and the time will be displayed. The telephone will state the number of messages received and play the recorded messages

05 1-10:53

If you have new messages, these will be read out automatically in chronological order

O R

If you have old messages. These will be read out automatically in chronological order

Whilst listening to messages:

-  = toggle between earpiece and speaker mode
- 1** = Start the message again
- 3** = Skip to the next message
- 8** = Stop
- 2** = Start at the beginning of all the messages

Press **9** to exit

ANSWERING MACHINE

Deleting a Message

If you wish to delete a message, press **6** whilst the message is playing. A beep will be heard by means of confirmation.

Deleting all Messages

If you wish to delete all messages, press and hold the **6** key after listening to all the messages. 00 will be displayed on the screen and a beep will be heard by means of confirmation.

Record an Outgoing Message

The answering machine has a default outgoing message " Please leave your message after the tone". You may want to change it as follows:

Press 9 button located on the right side of your telephone
Press 4 and then 5 . A beep will be heard
Record your outgoing message
Press 8 to stop recording. A second tone will be heard
Press 9 to exit

NOTE: The outgoing message can only be recorded whilst there are no messages being read.

35

ANSWERING MACHINE

Listen to an Outgoing Message

Press 9 button located on the right side of your telephone
Press 5
Outgoing message will be read
Press 9 to exit

NOTE: The outgoing message can only be read whilst there are no messages being read.

Record an Incoming Message

With this function, you can leave a message for your family members just like any other incoming recorded message. This function acts as a memo pad.

Press 9 button located on the right side of your telephone
Press 4 and then 2 . A beep will be heard
Record your outgoing message
Press 8 to stop recording. A second tone will be heard
Press 9 to exit

36

ANSWERING MACHINE

Answering Machine Settings

System Day and Time

Day and time of the message recording will be added automatically to each message. When using the handset, the day and time of the message is also displayed on the screen. If you subscribe to your network provider's Caller Display service, the date and time are set automatically when your telephone receives its first call, however, if you do not subscribe you will need to change these settings.

Day

The default day is 1.

Time

The default time is 00:00

Delay

This setting allows you to choose how long to wait before the answering machine is activated during an incoming call e.g. after 2 rings, etc. There is also an option called toll saver, this allows the machine to answer the call after 3 rings if new messages have been received instead of 5 in the case of no new messages. The default delay is toll saver

Remote Control Code

A confidential ID code is required to activate/deactivate the answering machine or read your messages from a remote external telephone. The default code is 1111. This can be changed to a different code for confidentiality reasons

Recording Quality

The telephone can record up to 4 min. 40 secs of top quality messages or 7 min. of standard quality messages. The default is top quality.

ANSWERING MACHINE

Press **R/↔** to activate the menu

Use **1** and **3** to scroll through the menu to find the desired ringer icon - . The selected icon will flash on the display

Press **OK** to scroll through the answering machine settings menu until you reach the required level:

1/5 – the system day menu

Use **1** and **3** to scroll through the 7 days available in the system day menu to find the correct day:

1=Monday, 2=Tuesday, 3=Wednesday, 4=Thursday, 5=Friday, 6=Saturday, 7=Sunday

2/5 – the system time menu

Use the keypad to type in the correct time (24hr clock)

3/5 – the delay menu

Use **1** and **3** to scroll through the 6 options available in the delay menu to find the desired delay

2 rings, 3 rings, 4 rings, 5 rings, toll

4/5 – the remote control code menu

Use the keypad to type in the new code. The range is 0000 – 9999

5/5 – the quality menu

Use **1** and **3** to scroll through the 2 options available in the quality menu to find the desired quality

****A = Top quality, ****B = Standard quality

Press **OK** to confirm the settings and exit the answering machine settings submenu

Press **R/↔** to exit the menu and return to the standby position

ANSWERING MACHINE

Answering Machine Volume

The volume at which answering machine messages are listened to via the earpiece can be altered.

Press **R/↔** to activate the menu

Use **1** and **3** to scroll through the menu to find the desired ringer icon - . The selected icon will flash on the display

Press **OK** to select the  icon and enter the answering machine menu

Use **1** and **3** to scroll through the 4 volume options available in the volume menu to find the desired volume.

++++ is maximum volume
+ is minimum volume

1/1 +++++

Press **OK** to confirm the settings and exit the volume menu

Press **R/↔** to exit the menu and return to the standby position

ANSWERING MACHINE

Operating the Answering Machine Remotely

You can get remote access to your answering machine via a simple telephone call. You will need the 4 digit remote control code. The default setting is 1111, this can be changed as shown in the answering machine settings section. This is advisable due to confidentiality reasons.

Remote Activate Answering Machine

If you forget to switch on your answering machine, you can also do it from another telephone. Likewise, you can switch off your answering machine.

Dial your telephone number from the remote telephone and let it ring

After 9 rings a beep will be heard, press the ***key**

Enter the code (1111 or your secret code)

Press **7** on the telephone to activate the answering machine

Remote Deactivate Answering Machine

If you forget to switch on your answering machine, you can also do it from another telephone. Likewise, you can switch off your answering machine.

Dial your telephone number from the remote telephone and let it ring

During the outgoing message, press the ***key**

Enter the code (1111 or your secret code)

Press **9** on the telephone to deactivate the answering machine

ANSWERING MACHINE

Remote Access to Answering Machine

Dial your telephone number from the remote telephone and let it ring

During the outgoing message, press the * key

Enter the code (1111 or your secret code)

The answering machine will announce the number of messages received. The following keys can be used whilst listening to your messages:

- 1** = Start the message again
- 3** = Skip to the next message
- 8** = Stop
- 2** = Start at the beginning of all the messages
- 6** = Delete the message

Hang up the telephone when all the messages have been read

ANSWERING MACHINE

Answer Only Mode

The answer machine is set to answer and record mode as default. This mode can be changed to answer only mode.

Press **R/↔** to activate the menu

Press **9** then **8**

1/1--->+<---

Use **1** and **3** to scroll through the two options to find 'answer only' mode

1/1--->

Press **OK** to confirm and return to standby menu

Note: The default outgoing message is set up foethe 'answer and record' mode. You will need to change the outgoing message. See Reord an Outgoing Message section.

ADDITIONAL HANDSETS & BASES

Up to 4 handsets can be registered to one base. This means you can make internal calls between registered handsets, transfer an incoming call between handsets and answer a call anywhere in the office or home as all the handsets will call at the same time.

You can also register up to 2 bases to each handset. This will increase the phone range, allowing you to move between the telephone coverage areas.

The additional handsets will not be equipped with the answering machine function. This function is only assigned to the main handset (Ampli DECT 300 only).

Using Several Handsets

If you buy new handsets to use with your Ampli DECT telephone, they will have to be registered to the base before you can use them.

ADDITIONAL HANDSETS & BASES

Handset Registration

Unplug the mains adaptor from the base for a few seconds

Replace the mains adaptor. The handset  icon will be flashing

Press **R / ↵** to activate the menu

Use **1** and **3** to scroll through the menu to find the desired ringer icon - . The selected icon will flash on the display

Press **OK** to select the  icon and enter the registration menu

Use the keypad to type in the base PIN (default 1111)

1 / 1 0000

Press **OK** to confirm the PIN and exit the PIN menu

The handset is now searching for the base to be registered

A beep will be heard when the handset is registered to the base.  will stop flashing

ADDITIONAL HANDSETS & BASES

Handset Deregistration for All Additional Handsets

Press **R/↔** to activate the menu

Press **9** followed by **5**

Use the keypad to type in the base PIN (default 1111)

1/1 0000

All additional handsets will be deregistered from the base

Handset Deregistration for Current Handsets

Press **R/↔** to activate the menu

Press **9** followed by **4**

Use the keypad to type in the base PIN (default 1111)

1/1 0000

The current handset will be deregistered from the base

ADDITIONAL HANDSETS & BASES

Internal Calls

When using several handsets registered to the same base, you can make internal calls between handsets.

Press  **OK**

All the other registered handsets will ring

Press  to answer the call

Note: If you receive an external call during an internal call, a tone will be heard. To answer the external call you must finish the internal call first by pressing  to end.

Call Transfer

External calls can be transferred to another registered handset from the answering handset (both handsets must be registered to the same base).

Press  to answer the call

Press  **OK** to transfer the call

All the other registered handsets will ring

Press  to answer the call on the other handset

ADDITIONAL HANDSETS & BASES

Using Several Base

A second base can be connected to the network in order to extend the range of the handsets. When another base is registered to a handset, the handset can automatically search for the next base if you go outside the range of the first base. The transfer between bases is handled automatically, although this cannot be done whilst a call is in progress.

The bases coverage areas must overlap to ensure there are no gaps in the coverage.

Adding a Base

Connect the base to the mains power and telephone network as described in the Installation section

Register the handset as described in the Handset Registration section



Remark: The first registered handset has priority on the first base. It will be activated when the handset move to the second base

To check if your handset or all handsets registered to this new base are actually registered, simply press the **PAGE** button on the new base, all handsets registered to this base will ring.

IMPORTANT: If you connect several bases together, the handsets registered to the additional bases will ring for a few seconds during an incoming call even if you take the line with one of the first base handsets.

ADDITIONAL HANDSETS & BASES

Other Optional Accessories

If you wish you can connect a handset ref: **HEADCL_BLK (CLA3)** or a neck loop Ref : **CLA7** to the socket located on the bottom of the handset. You can still use all phone functions as described before. To answer a call simply press  to take the line and press  a second time to release the line.

TROUBLESHOOTING

General Checks

- Make sure that the telephone line cord and adaptor are correctly plugged in and they are not damaged.
- Make sure the batteries are inserted correctly.
- Make sure that the batteries are fully charged.
- Connect another telephone to the telephone PTT socket or move your telephone to another socket to track if the failure is coming from your telephone or your PTT socket.

Handset not registering

- Check that the base is plugged into the mains power and switched on.
- Make sure the batteries are inserted correctly.
- Make sure that the batteries are fully charged.

No display

- Make sure the batteries are inserted correctly.
- Make sure that the batteries are fully charged.

No connection between handset and base

- You may be out of range of the base. Move closer to the base

Handset on the base does not charge

- Make sure the handset is placed properly on the base. When charging, the battery symbol should be shown filling up.

Handset does not ring

- Make sure the batteries are inserted correctly.
- Make sure that the batteries are fully charged.

No tone when you press

- Make sure the batteries are inserted correctly.
- Make sure that the batteries are fully charged.

-  icon must be fixed. If it is flashing, you must register the handset (see Handset Registration section)

A warning tone is heard during a call:

- The batteries are empty. The handset needs to be replaced in the base in order to recharge.
- You are over the base coverage area.

TROUBLESHOOTING

No number is displayed when the telephone rings:

- Please contact your telephone network provider to get the caller display service.
- Even if you have subscribed to caller display, if the caller does not want to show their number (private number), the display will show *****.
- It could be a call from a PBX. Caller display may not work properly if the telephone is connected to a PBX.

The answering machine does not work or you do not receive messages

- Check that the answering machine is activated
- Check that you have an outgoing message recorded (see the recording an outgoing message section)

You lost some messages :

- Your voicemail box was full and the oldest messages have been cleaned automatically. This automatic deletion allows new messages to be recorded. Ensure you delete your messages after listening to them.

You cannot hear your messages

If the answering machine is not responding and you have lost the link with the base

- Make sure the batteries are inserted correctly.
- Make sure that the batteries are fully charged.

Consistently short battery life

- Clean the charge contacts
- Replace the batteries

RESTORE FACTORY SETTINGS

The factory settings can be restored to the telephone. This is very useful if you forget the secret PIN code you set up. The factory PIN code is 1111.

Remove one of the batteries

Press *** ***

Replace the battery (keeping *** *** pressed down)

All the icons will be displayed on the screen Release *** *** once  icon has stopped flashing

Use the keypad to type the following code

*** #**

The display will clear

Use the keypad to type the following code

7 3 3 7 * #

Factory settings will have been restored

SAFETY INFORMATION

General

Only use the power supply included with the product.

Only use the approved rechargeable batteries supplied.

Do not open the handset (except to replace the handset batteries) or base. Contact the helpline for all repairs.

Never dispose of batteries in a fire. There is a serious risk of explosion and/ or the release of toxic chemicals.

Cleaning

Clean the telephone with a soft cloth. Keep the base and handset charging contacts clean. Never use polishes or cleaning agents - they could damage the finish or the electrics inside.

Environmental

Do not expose to direct sunlight.

Always ensure there is a free flow of air over the surfaces of the telephone.

Do not place any part of your product in water and do not use it in damp or humid conditions e.g. bathrooms.

Do not expose your product to fire or other hazardous conditions.

Unplug your phone from the telephone socket during thunderstorms because it could damage your telephone. Your guarantee does not cover thunderstorm damage.

GUARANTEE

From the moment your Geemarc product is purchased, Geemarc guarantee it for the period of one year. During this time, all repairs or replacements (at our discretion) are free of charge. Should you experience a problem then contact our help line or visit our website at www.geemarc.com. The guarantee does not cover accidents, negligence or breakages to any parts. The product must not be tampered with or taken apart by anyone who is not an authorised Geemarc representative. The Geemarc guarantee in no way limits your legal rights.

IMPORTANT: YOUR RECEIPT IS PART OF YOUR GUARANTEE AND MUST BE RETAINED AND PRODUCED IN THE EVENT OF AWARRANTY CLAIM.

Please note: The guarantee applies to
the United Kingdom only

DECLARATION: Geemarc Telecom SA hereby declares that this product is in compliance with the essential requirements and other relevant provisions of the Radio and Telecommunications Terminal Equipment Directive 1999/5/EEC and in particular article 3 section 1a, 1b and section 3. The telephone does not operate if the line current is lower than 18 mA.



GUARANTEE

Electrical connection: The apparatus is designed to operate from a 230V 50Hz supply only. (Classified as 'hazardous voltage' according to EN60950 standard). The apparatus does not incorporate an integral power on/off switch. To disconnect the power, either switch off supply at the mains power socket or unplug the AC adaptor. When installing the apparatus, ensure that the mains power socket is readily accessible.

Telephone connection: Voltages present on the telecommunication network are classified TNV-3 (Telecommunication Network Voltage) according to the EN60950 standard.



For product support and help visit our website at www.geemarc.com
Telephone 01707 384438
Or fax 01707 372529

Free Manuals Download Website

<http://myh66.com>

<http://usermanuals.us>

<http://www.somanuals.com>

<http://www.4manuals.cc>

<http://www.manual-lib.com>

<http://www.404manual.com>

<http://www.luxmanual.com>

<http://aubethermostatmanual.com>

Golf course search by state

<http://golfingnear.com>

Email search by domain

<http://emailbydomain.com>

Auto manuals search

<http://auto.somanuals.com>

TV manuals search

<http://tv.somanuals.com>