



CL400

MULTIFUNCTION TELEPHONE

TELEPHONE MULTIFONCTIONS



User guide :p2

Notice d'utilisation p 48

GB CAUTION: THIS TELEPHONE PRODUCT IS SPECIFICALLY DESIGNED FOR PEOPLE WITH HEARING DIFFICULTIES AND IS PROVIDED WITH A HANDSET EARPIECE VOLUME CONTROL FOR INDIVIDUAL REQUIREMENTS. DUE CARE MUST BE TAKEN BY ALL USERS THAT THE HANDSET EARPIECE VOLUME CONTROL IS SET TO THE LOWEST LEVEL ACCEPTABLE BY EACH RESPECTIVE USER. CARE SHOULD THEREFORE BE EXERCISED TO ENSURE THAT ANY NEW USERS ARE FAMILIAR WITH THIS REQUIREMENT.

F ATTENTION: CE TELEPHONE PEUT ETRE DESTINE AUX PERSONNES AYANT DES PROBLEMES D'AUDITION. IL POSSEDE UN ECOUTEUR A VOLUME VARIABLE. A LA PREMIERE UTILISATION, ASSUREZ VOUS QUE LE BOUTON DE REGLAGE DU VOLUME SOIT POSITIONNE SUR LA POSITION VOLUME MINIMUM. LES PERSONNES MALENTENDANTES POURRONT PAR LA SUITE AUGMENTER LE VOLUME POUR L'ADAPTER A LEUR AUDITION.

INDEX

DESCRIPTION

- General description 5
- LCD screen 7
- Screen display 8

INSTALLATION

- Connecting 9
- Wall mounting 11

SETTINGS

- Ringer settings 12
- Alarm and ringer settings 13
- Dialling mode (P/T) 13
- New call indicator & Hotel message switch 14
- Choose the date / hour format 14
- Date and hour settings 16
- Set the language 16
- Screen contrast adjustment 17
- Auto-on hook 18
- DIM:X---->x 19
- Time break recall setting "R" function 20

USING THE PHONE

- Answer a call 21
- Make a call 22
- Use the amplifier 24

INDEX

- Last number redial	24
- Recall one of the last 30 number dialed	25
- Delete one of the last 30 numbers dialed	25
- Mute button	26
- R, * and # keys	26
- Store a telephone number in memory	27
- Dialling stored numbers	28
- Use the headset (option)	29
- Use the neckloop (option)	29
- Use the shaker (option)	30

SENDING LEVEL SETTINGS 31

RECEIVING TONE AND VOLUME SETTINGS 32

PHONE BOOK

- Create an entry	34
- Create an entry from the incoming call list	36
- Delete a phone book entry	37
- Modify a phone book entry	37
- Make a call from a phone book entry	38

CID FEATURE

- Use the CID list	39
- Recall a number from the CID list	41
- Delete a record from the CID list	42

INDEX

- Delete all records from the CID list	43
- Call waiting	43
- Message waiting	46
GUARANTEE	47



For product support and help visit our website at

www.geemarc.com

telephone 01707 384438

or fax 01707 372529

DESCRIPTION

1- GENERAL DESCRIPTION

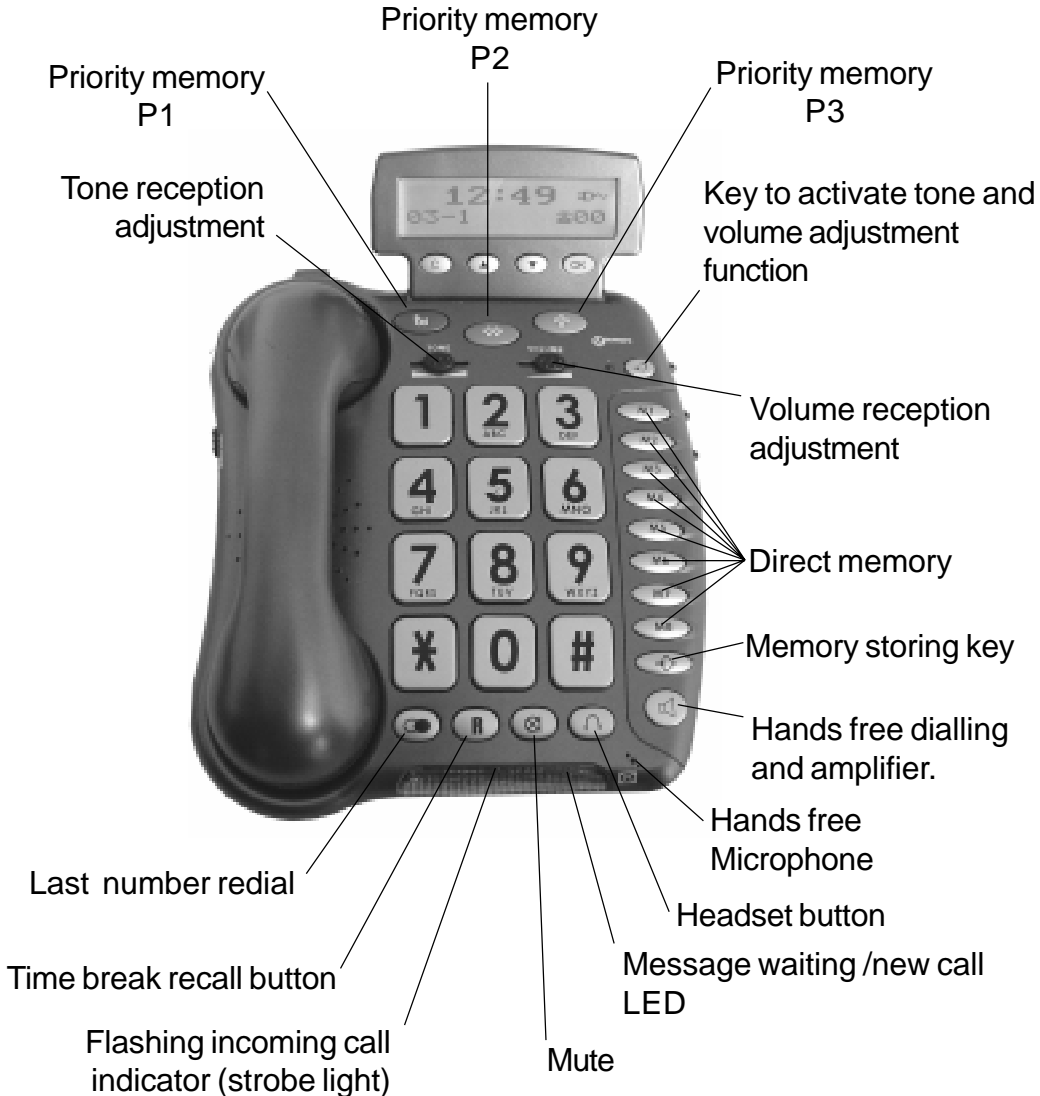

DESCRIPTION

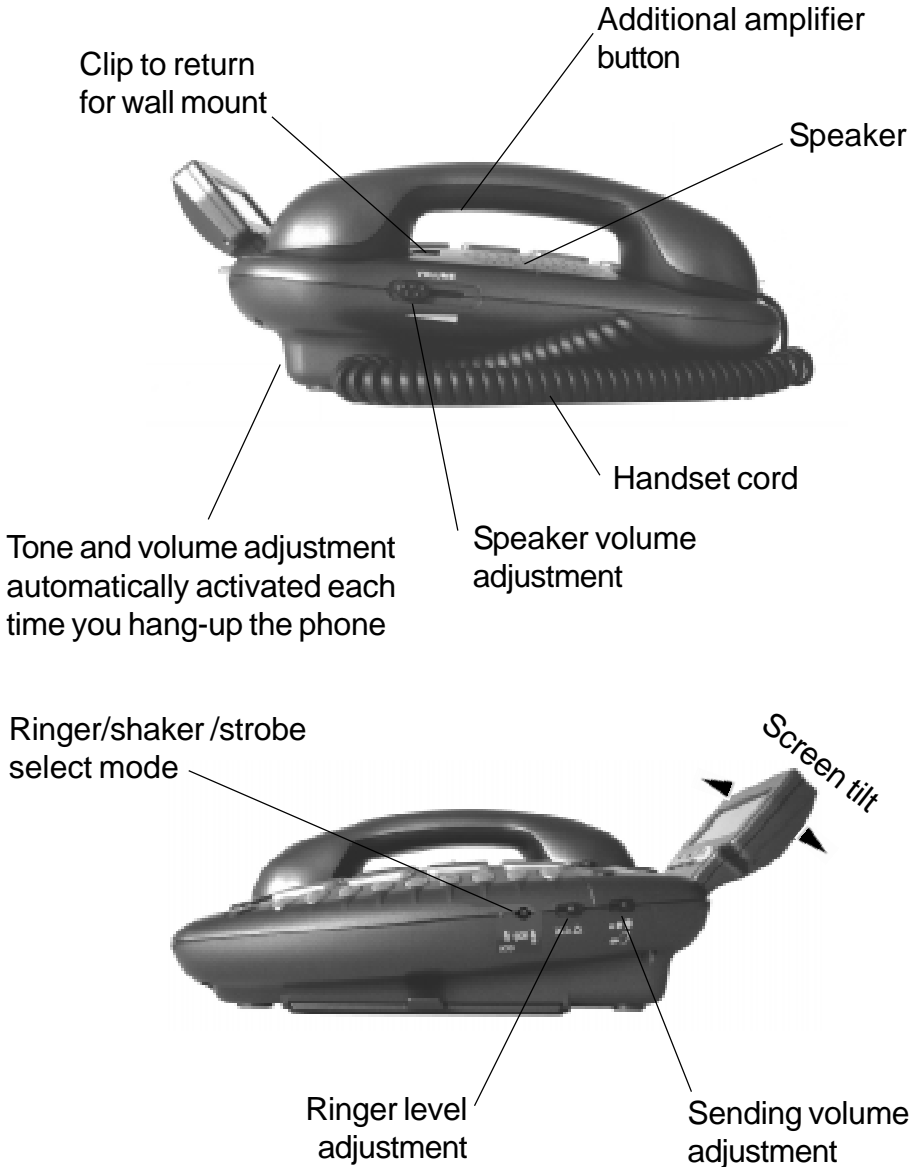

DESCRIPTION

2 - LCD SCREEN

Screen example (On hook position)

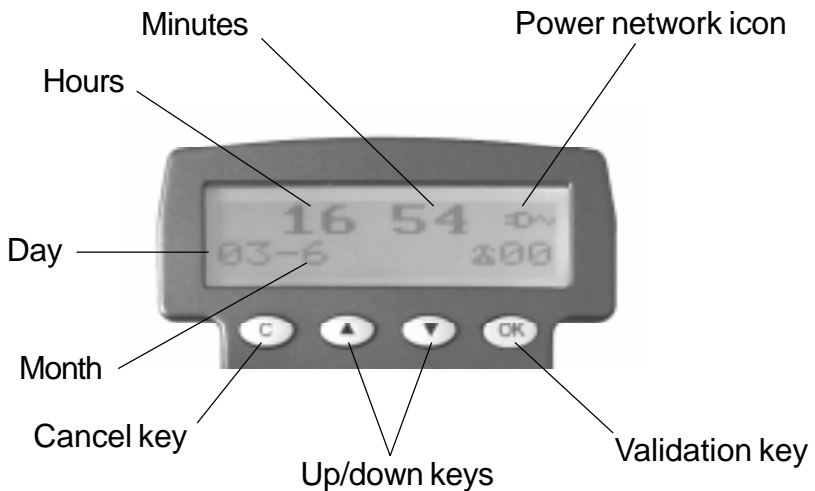

- **OK** key is used to confirm action or a choice on the screen.
- **▲ ▼** keys are used to scroll through the menu.
- In general, the **C** key is used to cancel an action/entry, it can also be used to confirm a choice (for example to cancel a stored number).

DESCRIPTION

3 - SCREEN DISPLAY

Your CL400 has a screen with different icons which help you to use the telephone.



The telephone is supplied by battery + battery indicator



The telephone is supplied by adaptor



Memory storing is required.



Screen contrast level.



“Mute” is activated.



Speaker is activated.



Precede the CID call record number.



To show new records.

INSTALLATION

1 - CONNECTING



(*) Classified TNV-3 according to EN60950 standard.

(**) Classified "hazardous voltage" according to EN60950 standard.

Important: Only Shaker, Neckloop, Headset and Adaptor with Geemarc reference can be connected to the sockets.

- Connect the handset.
- Open the battery compartment.
- Insert 4 alkaline batteries without mercury (AAA 1.5V type not supplied) with good polarity into the compartment located on the telephone base.

Note : Do not use a rechargeable battery, do not put the battery into the household rubbish. Pay attention to the battery regulations regarding battery disposal.

- Replace the battery cover.
- Connect the line cord to the socket located at rear of telephone then connect the plug to the wall socket(*) .

INSTALLATION

- Connect the adaptor plug to the adaptor socket located on the back of the telephone then connect it to the wall socket (**). Please choose an adaptor wall socket near your line plug to enable you to unplug the adaptor quickly in case of a problem.

Note: The adaptor is required for the telephone to work correctly. Batteries are necessary in case of network power failure to save stored number in memory and are required for phone book use. If the adaptor is accidentally unplugged (or in case of power failure) and if the batteries are empty or not in place, minimal restricted phone features only will work on the phone (make a call or answer incoming call).

INSTALLATION

2 - WALL MOUNTING

To wall-mount your telephone, slide out the clip, turn around and slide back into the wall mounting position. This will ensure that the handset stays firmly in position.

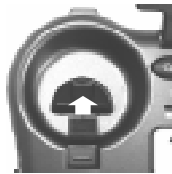

Make 2 holes in the wall 80mm apart (use the wall mount template), insert the wall plugs and the wall mounting screws.

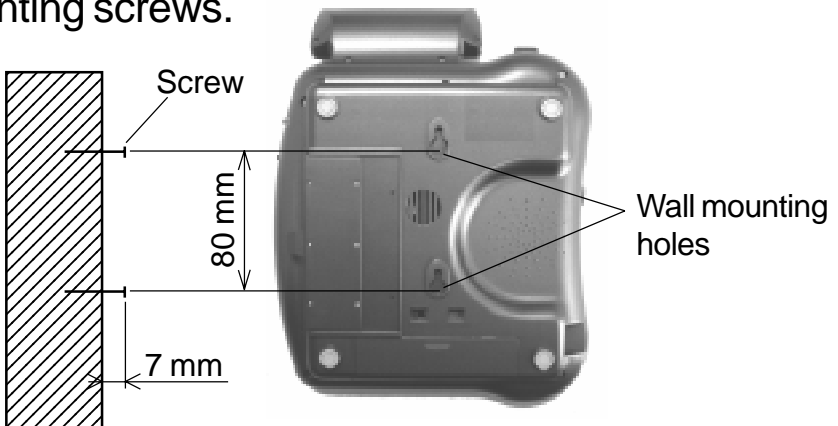

The screws should protrude from the wall by 6-7 mm. Place the phone onto the screw-heads and slide down to secure.

SETTINGS

1 - RINGER SETTINGS

A switch located on right side allows the ringer to be switched HI,LOW,OFF:

 : Off



 : Low

 : Hi

Your phone comes with the ringer switched to «High».

If you don't like the ringer melody, you can choose a new one by changing the settings between four settings as follow:



In on hook position,

- Press the  key.
- Use the  or  keys to select «**SET PHONE**».
- Press the **OK** key to confirm.
- Select «**SET RING**»
- Press the **OK** key to confirm.
- Select the ring you would like.
- Press the **OK** key to confirm.
- New ring will be heard.
- Press the **C** key 3 times to exit.

SETTINGS

2 - ALARM AND RINGER SETTINGS

A 3 position switch located on the right side of the phone allows the settings below:



-  : Ringer and strobe flash are activated.
-  : Ringer and shaker are activated.
-  : Ringer, shaker and strobe flash are activated.

3 - DIALLING MODE (T/P)

The Tone/Pulse switch is factory pre-set to Tone position (T). In the UK, all telephone exchanges now use Tone dialling. If your phone does not dial out, it is probably being used from an older private switch-board (PBX). In this case, the Tone/Pulse switch must be moved to Pulse (P).

SETTINGS

4 - NEW CALL INDICATOR & HOTEL MESSAGE WAITING SWITCH

Hotel **message waiting** is used with the new services provided on hotel network. The **New call indicator** is used to indicate a new incoming call. A switch  located on the base of your phone allows to set **ON/OFF** the hotel message waiting or new call light functions. When the switch is set to **ON**, **new call** light  will flashes when a **new call** is received. When the switch is set to **OFF** and when you receive a message, the red light  is lit to inform you that you have a **message** on the phone (from hotel for example).

5- CHOOSE THE DATE / HOUR FORMAT

Date format

You can choose between two formats:

Day - Month or Month - Day.

In on hook position,

- Press the  key.

- Use the  or  keys to select «**SET PHONE**».

SETTINGS

- Press the **OK** key to confirm.
- Select «**DATE FORMAT**».
- Press the **OK** key to confirm.
- Select «**DAY-MONTH**» or «**MONTH-DAY**».
- Press the **OK** key to confirm.
- Press the **C** key twice to exit.

Hour format

You can choose between two formats:
12 hours or 24 hours.

In on hook position,

- Press the  key.

Use the  or  keys to select «**SET PHONE**».





- Press the **OK** key to confirm.
- Select «**HOURLY FORMAT**».
- Press the **OK** key to confirm.
- Select «**12 HOUR**» or «**24 HOUR**».
- Press the **OK** key to confirm.
- Press the **C** key twice to exit.

If you choose «**12 HOUR**», hours before noon will be displayed with «**AM**» and «**PM**» for the hours after noon.

SETTINGS

6 - DATE AND HOUR SETTING

In on hook position,

- Press the  key.
- Use the  or  keys to select «**SET TIME**».
- Press the **OK** key to confirm.
- Use the  or  keys to select the desired digit.
- Press the **OK** key to confirm and pass to the next digit.

You will set the time like this:

HOURS - MINUTES - MONTH - DAY

- Press the **C** key to exit.

Note: When you receive your first call, all these parameters will be set automatically if you have the CID feature.



7 - SET THE LANGUAGE

You can choose between 16 different languages including English and French .

SETTINGS

To change the language, follow the settings as below:

In on hook position,

- Press the  key.
- Use the  or  keys to select «**SET PHONE**».
- Press the **OK** key to confirm.
- Select «**SET LANGUAGE**».
- Press the **OK** key to confirm.
- Select «**FRENCH**» (for example).
- Press the **OK** key to confirm.
- Press the **C** key twice to exit.

8 - SCREEN CONTRAST ADJUSTMENT

Your screen has a backlight which automatically switches off after 15 seconds of inactivity.

Simply follow the settings as follows to decrease or increase the contrast:

In on hook position,

- Press the  key.
- Use the  or  keys to select «**SET PHONE**».

SETTINGS

- Press the **OK** key to confirm.
- Select «**LCD CONTRAST**».
- Press the **OK** key to confirm.
- Use the ▲ or ▼ keys to adjust the contrast level.
- Press the **C** or the **OK** keys to exit.

9 - AUTO- ON HOOK

This function cancels the line after 8 seconds if the line is busy.

In on hook position,







- Press the ☒ key.
- Use the ▲ or ▼ keys to select «**SET PHONE**».
- Press the **OK** key to confirm.
- Use the ▲ or ▼ keys to select «**AUTO ON HOOK**».
- Press the **OK** key to confirm.
- Use the ▲ or ▼ keys to select «**ON**» or «**OFF**» to activate or deactivate the function.
- Press the **OK** key to confirm.
- Press the **C** key twice to exit.

SETTINGS

10 - DIM:X---->x

If the auto-screen sizing is activated, the screen can display up to 18 digits of the number you dial, otherwise only 8 digits will be displayed on the screen.

In on hook position,

- Press the  key.
- Use the  or  keys to select «**SET PHONE**».
- Press the **OK** key to confirm.
- Use the  or  keys to select «**DIM:X---->x**».
- Press the **OK** key to confirm.
- Use the  or  keys to select «**ON**» or «**OFF**» to activate or deactivate the function.
- Press the **OK** key to confirm.
- Press the **C** key twice to exit.





SETTINGS

11 - TIME BREAK RECALL SETTING "R" FUNCTION

Your phone works with a time break recall for United Kingdom (R=100ms).

If you wish to change this value, follow instructions below:

In on hook position,

- Press the  key.
- Use the  or  keys to select «**SET PHONE**».
- Press the **OK** key to confirm.
- Use the  or  keys to select «**SET FLASH**».
- Press the **OK** key to confirm.
- Select a new setting, 300 or 600ms and press **OK** to confirm.
- Press the **C** key twice to exit.

USING THE PHONE

Your CL400 allows you to speak hands free, surrounding people can also hear the conversation.

1 - ANSWER A CALL



During an incoming call, your phone will ring and then the Number or/and the Name of the caller is displayed on the screen, if you have subscribed to the CID service.

1st solution :

- Lift the handset and speak.
- On completion of the call, carefully replace the handset in the cradle to release the line.

2nd solution :

You can use the «hands free» function to speak with your caller.

- Press the  key to speak with your caller hands free.
- Press the  key to release the line.

USING THE PHONE

2 - MAKE A CALL

1st solution

- Lift the handset.
- Await the dial tone and dial required number(the number is displayed on the screen).
- On completion of the call,carefully replace the handset in the cradle to clear the line.

2nd solution (Pre-dialling)

- Dial the required number in the on hook position. The **C** key allows you to come back to delete a wrong digit when dialling the number.
- Lift the handset, the number will be automatically dialled .
- On completion of the call,carefully replace the handset in the cradle to clear the line.



3rd solution (hands free)

You can use the «hands free» function to make a call.



- Dial the required number in the on hook position. The **C** key allows you to come back to delete a

USING THE PHONE

wrong digit when dialling the number.

- Press the  key, the number will be automatically dialled.
- When the person answers you, simply speak into the microphone located on the base. You can adjust the speaker level with the slide button located on the left side of your telephone.
- On completion of the call, simply press the  key to clear the line.

Notes: To deactivate the «hands free» function during a call, lift the handset.

The symbol  light off. The symbol  appears. To activate the «hands free» function during a call, press and hold the  key and replace the handset on the cradle at the same time.

Call time counter will be displayed a few seconds after the call is engaged.

- If you wish to stop the time counter, press the **C** key.
- If you press **C** key twice, the time counter will be reset to 0.



USING THE PHONE

3 - USE THE AMPLIFIER

During a call, if you wish to use the amplifier function with the speaker phone:



- Press the  key.
- Adjust the sound level with the **VOLUME** slide button located on the left side of your telephone.

During a call, if you wish to use the «hands free» function:

- Press and hold the  key and replace the handset on the cradle at the same time.
- Then release the  key.
- Hands free function is activated.

4 - LAST NUMBER REDIAL

With this function you can redial the last number dialled.

- Lift the handset or press the  or .
- Await the dial tone and press  button.
- The previously dialled number will be automatically redialled (not in use for memory numbers).
- Press **OK** to confirm.

USING THE PHONE

5 - RECALL ONE OF THE LAST 30 NUMBERS DIALLED

You can call back the last 30 numbers dialled.
To call back one of them, follow instructions below:

In on hook position,

- Press the **OK** key.

Screen will display “**DIALLED**”, the last number dialled, the total of numbers, the date and the hour of records.

- Use the ▲ or ▼ keys to move into the record menu and select the number you wish to dial.

- Lift the handset or press the , the number will be automatically dialled.

6 - DELETE ONE OF THE LAST 30 NUMBERS DIALLED

In on hook position,

- Press the **OK** key.

Screen will display “**DIALLED**”.

- Use the ▲ or ▼ keys to move into the record

USING THE PHONE

menu and select the number you wish to delete.

- Press the **C** key.

The screen will display “**DEL ?**”.

- Press again the **C** key to confirm .

- Press the **OK** key to exit.

7 - MUTE FUNCTION

If you wish, you can speak privately to someone else in the room without your caller overhearing. You will still be able to hear the caller but they cannot hear you during the mute operation.

- During a call press the  key.

The screen will display .

Your caller cannot hear you anymore.

- Press the  key to resume the conversation.

8 - R, * and # KEYS

These are used with the new services provided on digital exchanges. For details please contact your network operator.

USING THE PHONE

9 - STORE A TELEPHONE NUMBER IN MEMORY

Your phone can store 8 direct memories including 3 priorities numbers (30 digits maximum for each memory).

For example, the 3 priority **P1**, **P2**, **P3** memories allow you to store the 3 numbers below:

- Local, Police station,
- Your doctor
- 1471

It is recommended to store these numbers during installation



To store a number please follow instructions below:

- Lift the handset.
- Press  button.
- Dial the number.
- Press **M1**, **M2**, ..., or **M8** or one of 3 priorities numbers **P1**, **P2**, **P3** to store your number.
- The screen will display «**SAVE OK**».

Note: Numbers will be lost after a few hours if you disconnect your phone. Entering a new number in memory will automatically erase the previous number.

USING THE PHONE

10 - DIALLING STORED NUMBERS

- Lift the handset or press  or  and await the dial tone.
- Press appropriate button **M1**, **M2**, ..., or **M8** or one of the 3 priority **P1**, **P2**, **P3** numbers, the stored number will be dialled automatically. To register your stored phone numbers, use the index card located under the base. Use this table below to prepare the phone book.

	1	
	2	
	3	
	4	
	5	
	6	
	7	
	8	
	9	

Example :

Pierre	1	01 64 57 ...
--------	---	--------------

USING THE PHONE

11 - USE THE HEADSET WITH MICROPHONE (OPTION)

Headset: If you wish to answer or make call by using a Geemarc headset ref: HEADSCL_BLK, connect the headset plug in the headset socket  located behind your phone.

- Press the  key to get the dial tone.
- Dial the number.

Note: You can adjust the reception volume and tone level with the **VOLUME** and **STONE** slide button located on the top of the phone (if function is active) and the sending level with the 3 position switch  located on the right side.

12 - USE THE NECKLOOP (OPTION)

Neckloop: If you wish to answer or make call by using a neckloop, connect the neckloop in the neckloop plug  located behind your phone. The neckloop is now ready to use.

USING THE PHONE

You have three possibilities to use:

1st solution:

Press the  to activate the neckloop and headset, speak into the headset microphone.

2 nd solution:

Press the  to activate the neckloop and the amplifier, speak into the microphone located on the base.

3 rd solution:

Lift the handset and speak into the handset microphone.

Note: You must connect the adaptor to use the neckloop. You can also adjust the reception level.

13 - USE THE SHAKER (OPTION)

The shaker: If you wish to complement your phone by using a shaker ref: SHAKCL_WH connect the

SENDING LEVEL

shaker plug in the socket  located at the back of your phone. When an incoming call is received, the shaker will be activated during ringing.

Note: This option must be set in the ALARM AND RINGER OPTIONS item (page 12) to be activated.

Important: For your security, only connect the Geemarc SHAKCL_WH model, any other shaker model can damage your telephone.

1 - SENDING LEVEL ADJUSTMENT

If your voice is quiet or called parties have difficulty hearing you, you can increase the sending level volume with the switch located on the right side. You can also decrease the sending volume if required.

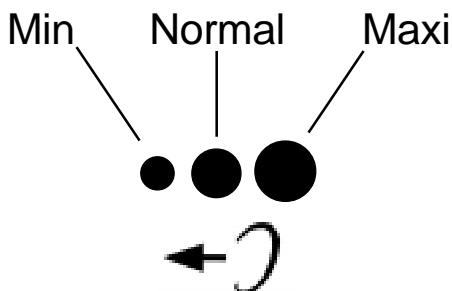

RECEIVING TONE AND VOLUME

1-VOLUME AND TONE RECEIVING ADJUSTMENT

You can increase the volume and adjust the receiving tone according to your own hearing requirements. The button  allows extra-receiving and tone functions to be activated during the conversation.

When the function is activated, the red light of extra-receiving and tone function located near the button  is lit.





Use the **TONE** and **VOLUME** buttons to adjust the level according to your own hearing requirements.

Note: Tone and volume adjustment (15dB to 30dB) is only activated when the button  is set to **ON**. When this button is set to **OFF** only the volume can be adjusted from 0dB to 15dB.

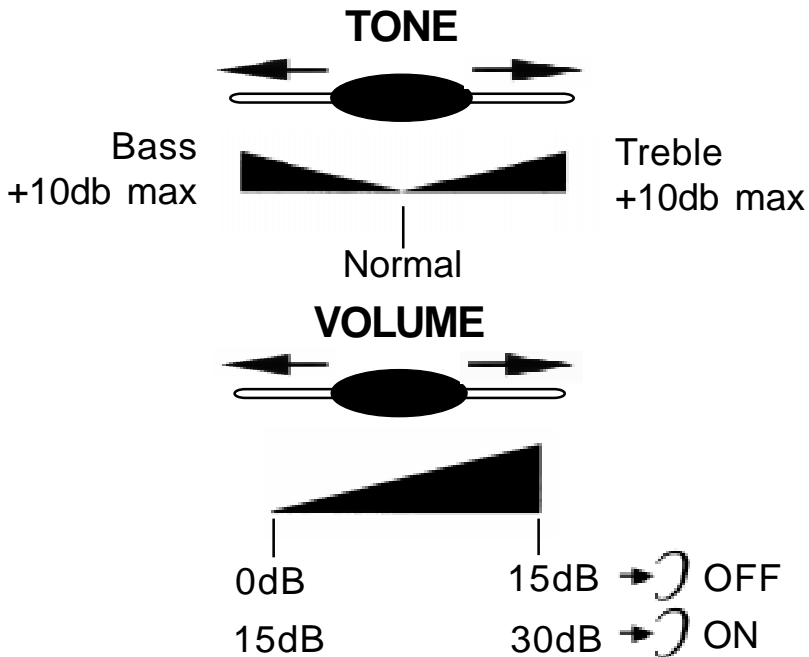
In both cases you can increase the reception volume with the switch located on the handset to 12 dB (see general description for location).

RECEIVING TONE AND VOLUME





Note: When the tone (treble), earpiece volume and sending levels are set to the maximum, whistling may appear. If whistling occurs the sending level settings should be decreased (sending level switch  located on the right side). When the switch  located behind the phone is **ON**, the extra-receiving and tone functions are automatically activated each time you use the phone. When the switch  is switched **OFF**, you will need to activate the function by pressing the button .

PHONE BOOK

1 - CREATE A PHONE BOOK ENTRY

You can store 99 entries into the phone book with the name and phone numbers of your correspondent.

In on hook position,

- Press the  key.
- Use the  or  keys to select «**PHONE BOOK**».
- Press the **OK** key to confirm.
- Select «**ADD**».
- Press the **OK** key to confirm.
- Enter the number (30 digits max per memory).
- Use the **C** key to delete a wrong digit.
- When the number is correct, press the **OK** key to confirm and enter the name corresponding to entered number.
- Select the desired letter by a pressing on the corresponding key.

You can use the table below or the letters printed on the keypad to help you.

PHONE BOOK

Key	Characters	Key	Characters
1	1 . , ? - " ' <	6	M N O m n o 6 Ö Ø
2	A B C a b c 2 Æ Ø	7	P Q R S p q r s 7
3	D E F d e f 3	8	T U V t u v 8 Ü
4	G H I g h i 4	9	W X Y Z w x y z 9
5	J K L j k l 5	0	0 + & @ / \$ %

- To insert a «space», press on the **OK** key twice.
- If the next letter is the same as the previous letter (or located on the same key), press first on the OK key to move and select the desired letter.
- Use the **C** key to delete a wrong letter.
- When the number is correct, press the **OK** key for 3 seconds to confirm the Number and Name storage.
- Now you can create a new entry.
- Press the **C** key to exit.

Note : If you wish to insert a pause in the stored number, press the  key whilst entering (a **P** will be displayed on the screen).

PHONE BOOK

2 - CREATE AN ENTRY FROM THE INCOMING CALL LIST

If you have subscribed to a caller identification service (CID feature), you have the possibility to create an entry from the incoming call list because each call is stored into the phone book as a CID entry.





In on hook position,

- Incoming calls will be displayed on the screen.
- Use the ▲ or ▼ keys to select the number you wish to store into the phone book.
- Press and hold the **OK** key until the last number digit flashes.
- Press the **OK** key.
- You can now modify and enter the name of the caller with the correct number or press and hold for 3 seconds the **OK** key to confirm the proposed CID name.
- Press the **C** key to exit.

PHONE BOOK





3 - DELETE A PHONE BOOK ENTRY

In on hook position,

- Press the  key.
- Use the  or  keys to select «**PHONE BOOK**» then «**REVIEW**».
- Use the  or  keys to select the number you wish to delete.
- Press the **C** key, screen display «**DEL?**»
- Press the **C** key to confirm.
- Press the **OK** key to exit.

4 - MODIFY A PHONE BOOK ENTRY

In on hook position,







- Press the  key.
- Use the  or  keys to select «**PHONE BOOK**» then «**REVIEW**».
- Press the **OK** key.
- Use the  or  keys to select the number you wish to modify.
- Press and hold the **OK** key until the last selected number flashes.

PHONE BOOK

- Press the **C** key to modify the number and insert new number.
- Press the **OK** key.
- You can now modify the name.
- Press the **C** key to delete a letter.
- For help see the «CREATE A PHONE BOOK ENTRY» p.34 to modify the name.
- Press the **OK** key for 3 seconds to confirm the new entry.
- Press the **C** key to exit.

5 - MAKE A CALL FROM A PHONE BOOK ENTRY

In on hook position,

- Press the  key.
- Use the  or  keys to select «**PHONE BOOK**» then «**REVIEW**», then press the **OK** key.
- Use the  or  keys to select the number you wish to dial. You can also get access quickly to a phone book entry by entering the first letter of the name.
- Lift the handset or press the  or .
- Number will be dialled automatically.

CID FEATURES

Note : You can review the incoming call list during a call by pressing the OK key, then use the ▲ & ▼ keys to move through the phone book list.

1 - USE THE INCOMING CALL LIST

Associated with the CID feature, the call list allows you to store the incoming calls. When the call list memory is full, a new call will take the place of the oldest call. Each call is stored as an entry with the date, the hour and in arrival order.

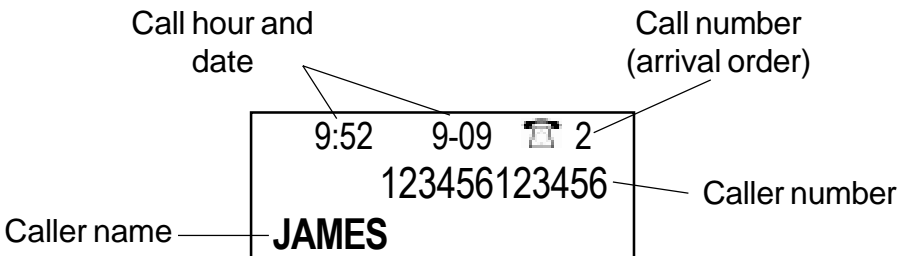

Note : If the caller does not wish to show his phone number or his name, the screen will display **PRIVATE**.

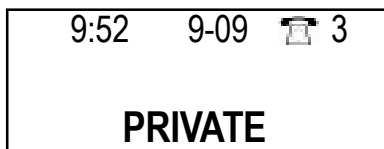

CID FEATURES

If the number is unknown from the telephone center (international incoming call for example), the screen will display **OUT OF AREA**:

9:52	9-09		3
OUT OF AREA			

When the same caller calls several times, only the last call will be stored into the incoming call list and the screen will display **+**.

9:52	9-09	N 2+
654321654321		
HELEN		

Note : During the entries review, the screen will display **N** for a new entry which has not been reviewed.

When a new call or new calls have been received, the new call LED will flash and the screen displays:

9:52	9-09
28	01
TOTAL	NEW

This example shows the total number of calls in the incoming call list is 28 with a new one.

CID FEATURES

To review the new calls, use the ▲ & ▼ keys.

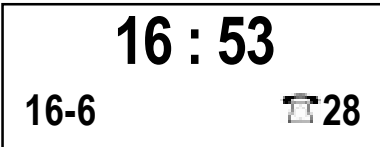

When all new calls have been reviewed, the new call LED will disappear and the screen will come back to idle state after a few seconds. The total number of incoming call entries on the incoming call list will still be displayed on the screen.

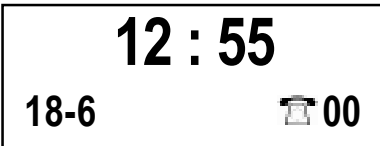

When the incoming call list is empty (if records have been deleted for example) the screen will display **00**.



2 - RECALL A NUMBER FROM THE CID LIST

You have 2 solutions :



In on hook position,

- Use the ▲ or ▼ keys to move into the list and select the required number to dial.

CID FEATURES

- Lift the handset or press the  or the  keys.
- The number will be dialed automatically.



Lift the handset,

- Use the  or  keys to move into the list and select the required number to dial.
- Press the **OK** key.
- The number will be dialed automatically.

Note : The call back function from incoming call list is not available for a number which displays **PRIVATE** or **OUT OF AREA**.

3 - DELETE A RECORD FROM THE CID LIST

In on hook position,

- Use the  &  keys to move into the list and select the required number to delete.
- Press the **C** key.
- The screen display «**DEL?**».
- Press again the **C** key to confirm.

CID FEATURES

- Press the **OK** key to exit.

4 - DELETE ALL RECORDS FROM THE CID LIST

In on hook position,

- Press the ▲ or ▼ keys.
- Press and hold the **C** key until the screen displays «**ALL DEL?**».
- Press the **C** key to confirm.







5 - CALL WAITING

With this service, you are made aware that a new call is coming through when you are in conversation. You can take this call and switch between callers. To be active, you must have subscribed to this service with your network provider.

The call waiting function is factory set to “OFF”. To activate this function, follow instruction below:

CID FEATURES

In on hook position,

- Press the  key.
- Use the  or  keys to select «**SET PHONE**».
- Press the **OK** key.
- Use the  or  keys to select «**CALL WAITING**».
- Press the **OK** key.
- Use the  or  keys to select «**ON**».
- Press the **OK** key and then **C** twice to exit.

Note : When the call waiting function is activated on your telephone and if you wish to deactivate it simply select «**OFF**» in the menu «**CALL WAITING**».

- When you are in conversation with caller N°1. CID information will be displayed on the screen (Name and Number).

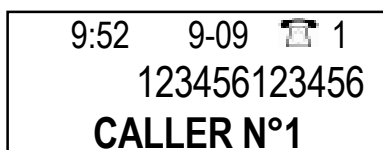

CID FEATURES

A beep tone will be heard when a second call is incoming. Caller N°2 CID information will be displayed on the screen (Name and Number).

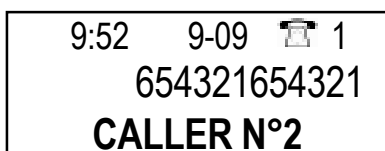

For more information about the «**CALL WAITING**» service contact your network provider.

Note : If you don't answer call N°2, the call will be recorded into the incoming call list. Then you will be able to call them later.



For product support and help visit our website at

www.geemarc.com

telephone 01707 384438

or fax 01707 372529

CID FEATURES

6 - MESSAGE WAITING

This system provides the capability of the caller to leave a message.

You will be informed of an incoming call by the incoming call list that you have a message. This call is distinguished from other calls and screen displays «**MSG WAITING**», the message waiting LED is activated.

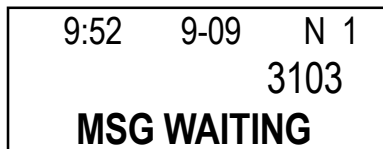

Note : «**MSG WAITING**» will be displayed to indicate message not read. After review «**MSG WAITING**» will be automatically removed from the screen.

GUARANTEE

GUARANTEE

From the moment your Geemarc product is purchased, Geemarc guarantee it for the period of one year. During this time, all repairs or replacements (at our discretion) are free of charge. Should you experience a problem then contact our helpline or visit our website at www.geemarc.com. The guarantee does not cover accidents, negligence or breakages to any parts. The product must not be tampered with or taken apart by anyone who is not an authorised Geemarc representative. The Geemarc guarantee in no way limits your legal rights.

IMPORTANT: YOUR RECEIPT IS PART OF YOUR GUARANTEE AND MUST BE RETAINED AND PRODUCED IN THE EVENT OF A WARRANTY CLAIM

Please note: The guarantee applies to the United Kingdom only.

DECLARATION: Geemarc Telecom SA hereby declares that this product is in compliance with the essential requirements and other relevant provisions of the Radio and Telecommunications Terminal Equipment Directive 1999/5/EEC and in particular article 3 section 1a, 1b and section 3. The telephone does not operate if the line current is lower than 18 mA.

Electrical connection : The apparatus is designed to operate from a 230V 50Hz supply only. (Classified as «hazardous voltage» according to EN60950 standard). The apparatus does not incorporate an integral power on/off switch. To disconnect the power, either switch off supply at the mains power socket or unplug the AC adaptor. When installing the apparatus, ensure that the mains power socket is readily accessible.

Telephone connection : Voltages present on the telecommunication network are classified TNV-3 (Telecommunication Network Voltage) according to the EN60950 standard.



Free Manuals Download Website

<http://myh66.com>

<http://usermanuals.us>

<http://www.somanuals.com>

<http://www.4manuals.cc>

<http://www.manual-lib.com>

<http://www.404manual.com>

<http://www.luxmanual.com>

<http://aubethermostatmanual.com>

Golf course search by state

<http://golfingnear.com>

Email search by domain

<http://emailbydomain.com>

Auto manuals search

<http://auto.somanuals.com>

TV manuals search

<http://tv.somanuals.com>