



USER'S GUIDE
V:1437-0819-09



TD910B

TV with DVD Player

For the most up-to-date version of this User's Guide, go to www.gpx.com

WARNINGS AND PRECAUTIONS

- **CAUTION:** TO PREVENT ELECTRIC SHOCK, MATCH WIDE BLADE OF PLUG TO WIDE SLOT, FULLY INSERT.
- **WARNING:** To prevent fire or shock hazards, do not expose this unit to rain or moisture.
- **CAUTION:** Use of controls or adjustments or performance of procedures other than those specified may result in hazardous radiation exposure.
- **WARNING:** Changes or modifications to this unit not expressly approved by the party responsible for compliance could void the user's authority to operate the equipment.
- **WARNING:** Do not place the unit on top of any soft, porous, or sensitive surfaces to avoid damaging the surface. Use a protective barrier between the unit and surface to protect the surface.
- **WARNING:** Use of this unit near fluorescent lighting may cause interference regarding use of the remote. If the unit is displaying erratic behavior move away from any fluorescent lighting, as it may be the cause.
- **CAUTION:** Danger of explosion if battery is incorrectly replaced. Replace only with the same or equivalent type.
- **PRÉCAUTION:** Danger d'explosion si les piles sont remplacées de façon incorrecte. Remplacer les piles seulement par le même type de pile ou l'équivalent.
- **WARNING:** There is a danger of explosion if you attempt to charge standard Alkaline batteries in the unit. Only use rechargeable NiMH batteries.
- **WARNING:** The remote control's button cell battery contains mercury. Do not put in the trash, instead recycle or dispose of as hazardous waste
- **WARNING:** Lithium batteries, like all rechargeable batteries are recyclable and should be recycled or disposed of in normal household waste. Contact your local government for disposal or recycling practices in your area. They should never be incinerated since they might explode.





Main plug is used as disconnect device and it should remain readily operable during intended use.

Do not mix old and new batteries.

Do not mix alkaline, standard (carbon-zinc), or rechargeable (ni-cad, ni-mh, etc) batteries.

No mezcle baterias viejas y nuevas.

No mezcle baterias alcalinas, estándar (carbono-zinc) o recargables (ni-cad, ni-mh, etc.).

	<p>WARNING: TO REDUCE THE RISK OF ELECTRIC SHOCK, DO NOT REMOVE COVER (OR BACK). NO USER-SERVICEABLE PARTS INSIDE. REFER SERVICING TO QUALIFIED SERVICE PERSONNEL.</p>
	<p>The lightning flash with arrowhead symbol, within an equilateral triangle, is intended to alert the user to the presence of uninsulated "dangerous voltage" within the product's enclosure that may be of sufficient magnitude to constitute a risk of electric shock to persons.</p>
	<p>The exclamation point within an equilateral triangle is intended to alert the user to the presence of important operating and maintenance (servicing) instructions in the literature accompanying the appliance.</p>
	<p>This product utilizes a Class 1 laser to read Compact Discs. This laser Compact Disc Player is equipped with safety switches to avoid exposure when the CD door is open and the safety interlocks are defeated. Invisible laser radiation is present when the CD Player's lid is open and the system's interlock has failed or been defeated. It is very important that you avoid direct exposure to the laser beam at all times. Please do not attempt to defeat or bypass the safety switches.</p>

IMPORTANT SAFETY INSTRUCTIONS

1. Read these Instructions.
2. Keep these Instructions.
3. Heed all Warnings.
4. Follow all instructions.
5. Do not use this apparatus near water.
6. Clean only with a dry cloth.
7. Do not block any ventilation openings. Install in accordance with the manufacturer's instructions.
8. Do not install near any heat sources such as radiators, heat registers, stoves, or other apparatus (including amplifiers) that produce heat.
9. Do not defeat the safety purpose of the polarized or grounding - type plug. A polarized plug has two blades with one wider than the other. A grounding type plug has two blades and a third grounding prong. The wide blade or the third prong are provided for your safety. When the provided plug does not fit into your outlet, consult an electrician for replacement of the obsolete outlet.
10. Protect the power cord from being walked on or pinched particularly at plugs, convenience receptacles, and the point where they exit from the apparatus.
11. Only use attachments/accessories specified by the manufacturer.
12. Use only with a cart, stand, tripod, bracket, or table specified by the manufacturer, or sold with the apparatus. When a cart is used, use caution when moving the cart/apparatus combination to avoid injury from tip-over.



13. Unplug this apparatus during lightning storms or when unused for long periods of time.
14. Refer all servicing to qualified service personnel. Servicing is required when the apparatus has been damaged in any way, such as power-supply cord or plug is damaged, liquid has been spilled or objects have fallen into the apparatus, the apparatus has been exposed to rain or moisture, does not operate normally, or has been dropped.

FCC Warnings

NOTE: This equipment has been tested and found to comply with the limits for a Class B digital device, pursuant to Part 15 of the FCC Rules. These limits are designed to provide reasonable protection against harmful interference in a residential installation. This equipment generates, uses, and can radiate radio frequency energy and, if not installed and used in accordance with the instructions, may cause harmful interference to radio communications. However, there is no guarantee that interference will not occur in a particular installation. If this equipment does cause harmful interference to radio or television reception, which can be determined by turning the equipment off and on, the user is encouraged to try to correct the interference by one or more of the following measures:

- Reorient or relocate the receiving antenna.
- Increase the separation between the equipment and receiver.
- Connect the equipment into an outlet on a circuit different from that to which the receiver is connected.
- Consult the dealer or an experienced radio/TV technician for help.

Additional Warnings

- The apparatus shall not be exposed to dripping or splashing and that no objects filled with liquids, such as vases, shall be placed on apparatus.
L'appareil ne doit pas être exposé aux écoulements ou aux éclaboussures et aucun objet ne contenant de liquide, tel qu'un vase, ne doit être placé sur l'objet.
- Main plug is used as disconnect device and it should remain readily operable during intended use. In order to disconnect the apparatus from the mains completely, the mains plug should be disconnected from the mains socket outlet completely.
La prise du secteur ne doit pas être obstruée ou doit être facilement accessible pendant son utilisation. Pour être complètement déconnecté de l'alimentation d'entrée, la prise doit être débranchée du secteur.
- Battery shall not be exposed to excessive heat such as sunshine, fire or the like.
Les piles ne doivent pas être exposées à de forte chaleur, tel qu'à la lumière du soleil, au feu ou autres choses de semblable.
- Caution marking is located at the bottom of apparatus.
Les précautions d'emploi sont inscrites en bas de l'appareil.
- The marking information is located at the bottom of apparatus.
Les marquages sont inscrits en bas de l'appareil.

TV WITH DVD PLAYER

Features

- 9" TFT TV with Built-In DVD Player
- Built-In Digital Tuner
- Aspect Ratio: 4:3/16:9
- Resolution: 640(H)x234(V)
- Contrast: 500:1
- Brightness: 220 nits
- Multi-Language OSD: On-Screen Display in English, French & Spanish
- Thin Profile, Portable
- Plays DVD, DVD±R/RW, JPEG Picture Discs
- Plays Audio CD, CD-R/RW Discs
- MP3 Playback
- Skip Forward/Reverse
- Playback through SD/MMC/MS Expansion Memory Card Slot
- A/V Output Jack, 3.5mm type
- Stereo Headphone Jack
- RF Input Jack for Antenna, Digital 75 Ohm Coaxial Jack
- USB Jack for Thumb Drives
- Built-In Speakers
- Full-Feature Remote Control
- Mute Function
- Uses 'CR2025' Button Cell Battery, battery included
- AC/DC-Powered:
 - AC: AC/DC Adaptor, Dual Voltage 100-240V/50-60Hz
 - DC: 12V DC Car Adaptor
- Built-In Rechargeable Battery, up to 2 Hrs of play time

Included

- TD910B
- AC/DC Adapter
- 12V DC Car Adapter
- A/V Cable 3.5mm male to 3 x RCA male (Video, Audio L&R)
- Remote Control, remote battery (pre-installed)
- Earbuds
- RF Antenna
- TV Stand
- Car Seat Mount Bracket and Strap

TABLE OF CONTENTS

INTRODUCTION	6
SETUP	8
TELEVISION	10
DVD & CD	12
DVD SETUP MENU	13
MEMORY CARD SLOT & USB (THUMB DRIVE) CONNECTION	14
AV OUTPUT	15
COMPANY INFORMATION	16

INTRODUCTION

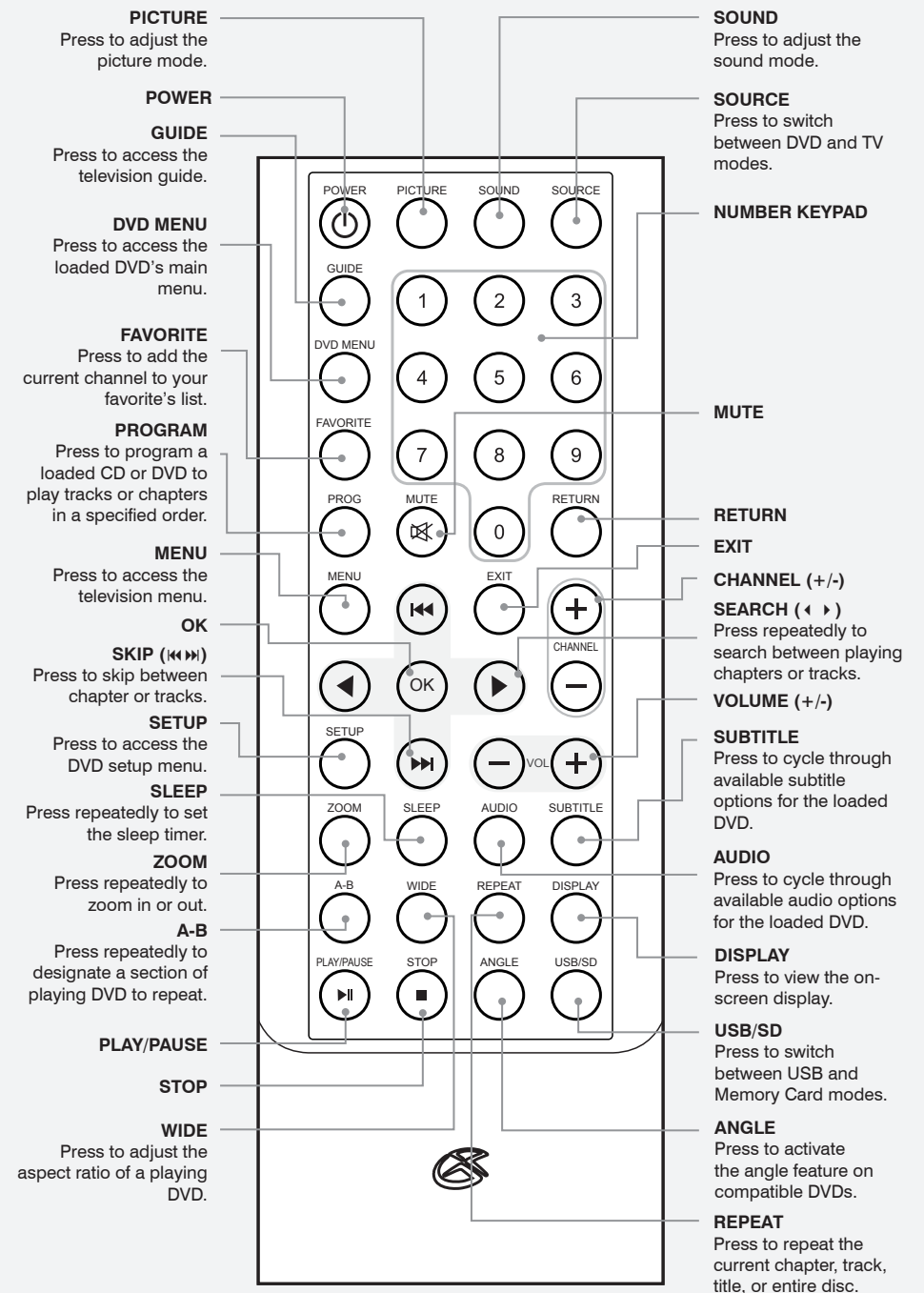
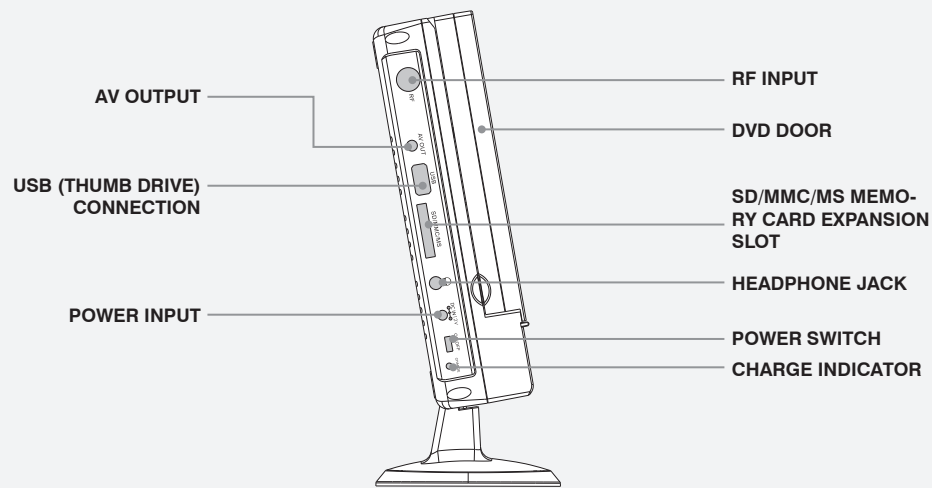
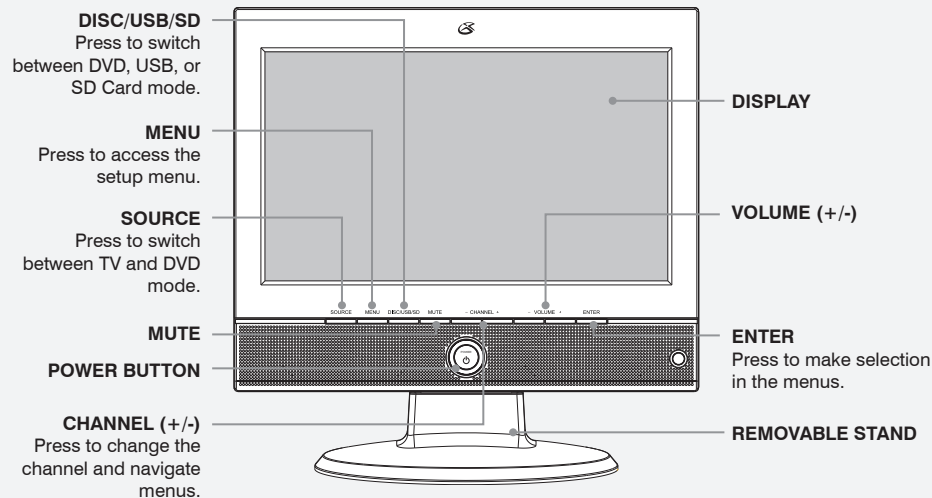

SETUP

AC Power

Plug the included AC/DC adapter into the **POWER INPUT** and a standard AC power outlet to power the TV with DVD Player.

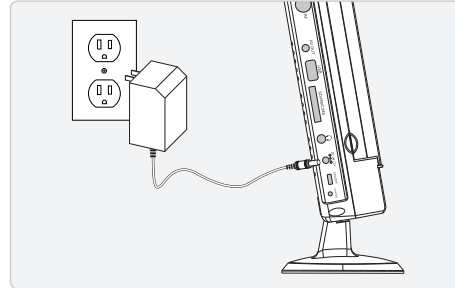

DC Car Power

Plug the included DC car adapter into the **POWER INPUT** and a DC car power outlet to power the TV with DVD Player.

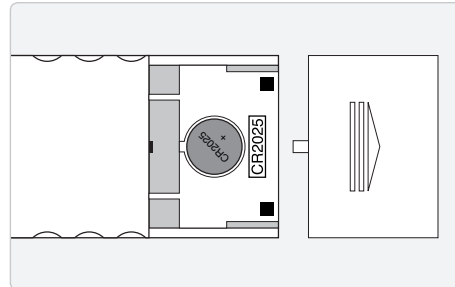

Remote Control

Requires one CR2025 battery (pre-installed)

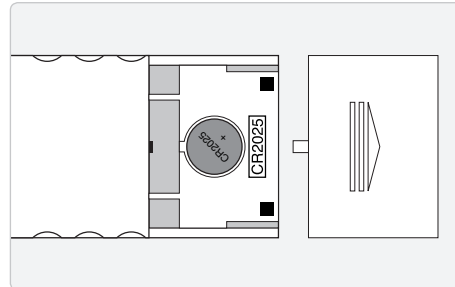

RF Antenna

Connect the included RF antenna to the **RF INPUT**, and place the RF antenna in an open area or near a door or window.

If you are experiencing issues receiving television channels, adjust the position of the RF antenna to improve channel reception.

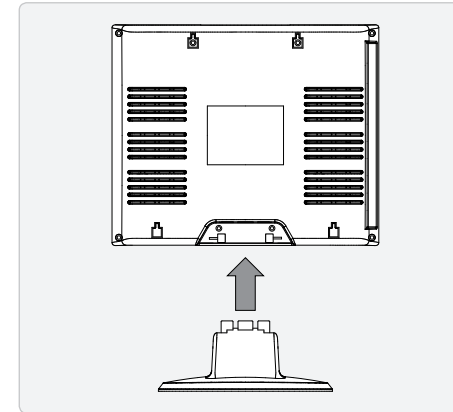

Included TV Stand

Connect the included TV stand to the bottom of the TV with DVD player as shown in the image to your left.

The stand can be removed by holding down the TV stand and pulling up on the TV with DVD player.

WARNING: Do not hold, carry, or move the TV with DVD player by the TV stand only. Always grab a hold of the main unit firmly when moving.

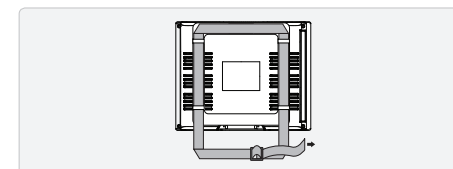
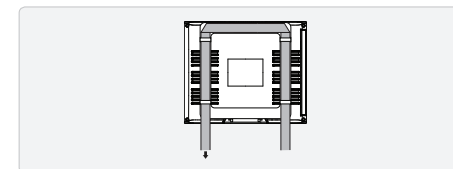
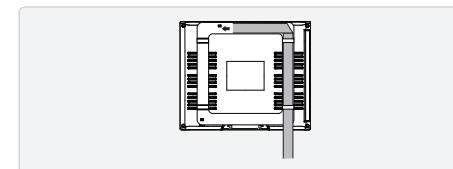
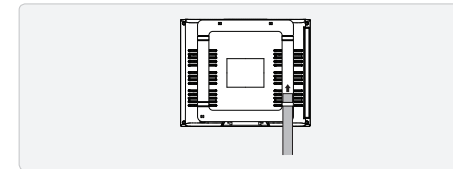

Car Seat Strap

- 1 Connect the **CAR SEAT MOUNT BRACKET** to the back of the TV with DVD Player.
- 2 Run the **CAR SEAT STRAP** through the **CAR SEAT MOUNT BRACKET** as shown in the images to your left.
- 3 Wrap the slack at the top and bottom of the **CAR SEAT STRAP** around the headrest of the car seat.
- 4 Tighten the **CAR SEAT STRAP** to ensure a firm hold on the car seat.

TELEVISION

Auto Scan

NOTE: THIS OPERATION MUST BE FOLLOWED BEFORE THE TV WITH DVD PLAYER CAN BEGIN RECEIVING TELEVISION CHANNELS.

THE RF ANTENNA MUST BE CONNECTED BEFORE FOLLOWING THIS OPERATION.

- 1 Adjust the **POWER SWITCH** on the side of the unit to the "ON" position.
- 2 Press the **POWER BUTTON** on the front of the TV with DVD Player.
- 3 Press the **SOURCE** button, switch to TV mode, and press the **ENTER** button.
- 4 Press the **MENU** button on the TV with DVD player to access the television menu.
- 5 Press the **VOLUME** buttons on the TV with DVD player to navigate to the magnifying glass icon.
- 6 Press the **CHANNEL -** button to highlight "AUTO SCAN".
- 7 Press the **ENTER** button.

The TV with DVD player will begin scanning for available channels.



Favorites

Favorites are saved television channels that can be easily accessed by pressing the **FAVORITE** button on the remote.

- 1 Press the **SOURCE** button, switch to TV mode, and press the **ENTER** button.
- 2 Press the **MENU** button on the TV with DVD player to access the television menu.
- 3 Press the **VOLUME** buttons on the TV with DVD player to navigate to the magnifying glass icon.
- 4 Press the **CHANNEL -** button to highlight "FAVORITES".
- 5 Highlight the channels you want to add to the favorites list, and press the **ENTER** button.

A check mark will appear next to the channels that have been saved as favorites.

- 6 After choosing your favorites and exiting the menu, press the **FAVORITE** button on the remote to view and select channels from your favorites list.

DVD & CD

Loading a DVD or CD

Open the **DVD DOOR**, and load a DVD or CD into the TV with DVD player (label side facing out).

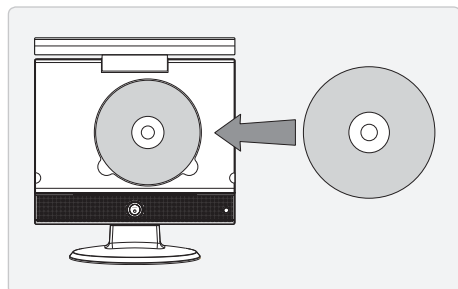
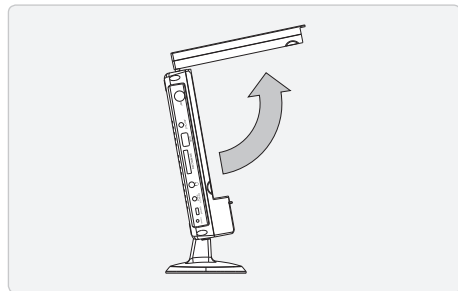

Playing a DVD or CD

- 1 Adjust the **POWER SWITCH** on the side of the unit to the "ON" position.
- 2 Press the **POWER BUTTON** on the front of the TV with DVD Player.
- 3 Press the **SOURCE** button, switch to DVD mode, and press the **ENTER** button.
- 4 The loaded disc will begin playing automatically. If it doesn't, press the **PLAY/PAUSE** button on the remote.

Programming a DVD or CD

- 1 Begin playing a DVD or CD.
- 2 Press the **PROG** button on the remote.
- 3 Use the **NUMBER KEYPAD** on the remote to enter the DVD chapters and titles, or the CD tracks in the order you would like them to play.
- 4 Press the on-screen **START** button to begin playing the programmed DVD or CD.

DVD SETUP MENU

DVD Setup Menu

To access the DVD setup menu, press the **SOURCE** button to switch to DVD mode, then press the **SETUP** button on the remote.

General Setup Page

- TV Display
- Angle Mark
- TV Type
- Screen Saver
- OSD Language
- Last Memory

Audio Setup Page

- Analog Audio Setup

Preference Page

- Audio
- Subtitle
- Disc Menu
- Default

Exit Setup Menu

MEMORY CARD SLOT & USB (THUMB DRIVE) CONNECTION

Loading a MMC, SD, or MS Card

Insert an SD, MMC, or MS memory card into the memory card expansion slot as shown in the diagram to the right. Only one card can be inserted at a time.

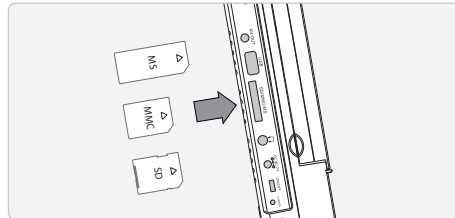

Loading a USB Thumb Drive

Insert a USB Thumb Drive into the USB Connection.

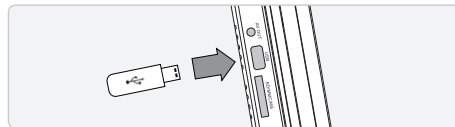

Playing Files from a Memory Card or USB

- 1 Adjust the **POWER SWITCH** on the side of the unit to the "ON" position.
- 2 Press the **POWER BUTTON** on the front of the TV with DVD Player.
- 3 Insert an MS, MMC, or SD card into the memory card expansion slot, or a USB Thumb Drive into the **USB CONNECTION** on the side of the TV with DVD player.
- 4 Press the **SOURCE** button, switch to DVD mode, and press the **ENTER** button.
- 5 Press the **DISC/USB/SD** button.
- 6 Press the **CHANNEL (+/-)** buttons to select DVD or MEDIA. Press the **ENTER** button.
- 7 Use the **SKIP (◀◀ ▶▶)** buttons and **SEARCH (◀ ▶)** buttons to navigate through files and folders on the loaded memory card.
- 8 Press the **ENTER** button on the remote to view selected JPEG photos, or to play selected MP3 audio files.

AV OUTPUT

Connecting to a Television

Requires a *3.5mm mini-phono to composite A/V cable* (included).

- 1 Connect the 3.5mm mini-phono plug into the **AV OUT** on the TV with DVD player.
- 2 Connect the composite A/V plugs to the audio and video inputs on a television.
- 3 Adjust the television to the appropriate input setting to receive audio and video from the portable DVD player.
- 4 Media played through the TV with DVD player will now play through the connected television.

COMPANY INFORMATION

Green Initiative

Environmental Commitment to 'Protect for Today and Sustain for Tomorrow'

2009 marks the official launch of DPI, Inc.'s corporate campaign for a greener and cleaner world. DPI and its four brands, iLive, WeatherX, Capri, and GPX, are building upon environmental initiatives introduced at all of their facilities to help formulate and sustain significant and important conservation efforts within its manufacturing and marketing communities. In addition to targeting and selecting energy efficient product features, and structuring 'green office' procedures, other initial program efforts include:

- Reduction of all packaging sizes
- Recyclable plastics for clamshell packages, with a plan to eventually replace plastic with recyclable paper
- Recycled fiber board in place of the polyfoam in packing boxes
- Recycled plastics in place of the virgin material in product construction

International Support

To download this User's Guide in English, Spanish, or French, visit the support section at www.gpx.com.

Para transferir esta guía de usuario en inglés, español, o francés, visite la sección de la ayuda en www.gpx.com.

Pour télécharger ce guide de l'utilisateur en anglais, espagnol, ou français, visitez la section de soutien chez www.gpx.com.

Contact Information

Address: 2116 Carr Street, St. Louis MO, 63106

Phone: 1-314-621-2881

Fax: 1-314-588-1805

Email: prodinfo@gpx.com

Parts Email: partsinfo@dpi-global.com

Website: www.gpx.com

Free Manuals Download Website

<http://myh66.com>

<http://usermanuals.us>

<http://www.somanuals.com>

<http://www.4manuals.cc>

<http://www.manual-lib.com>

<http://www.404manual.com>

<http://www.luxmanual.com>

<http://aubethermostatmanual.com>

Golf course search by state

<http://golfingnear.com>

Email search by domain

<http://emailbydomain.com>

Auto manuals search

<http://auto.somanuals.com>

TV manuals search

<http://tv.somanuals.com>