



USER'S GUIDE
V:1153-1008-10



TDE2480 24" Class TV/DVD Combo

For the most up-to-date version of this User's Guide, go to www.gpx.com

Warnings and Precautions

- **CAUTION:** TO PREVENT ELECTRIC SHOCK, MATCH WIDE BLADE OF PLUG TO WIDE SLOT, FULLY INSERT.
- **WARNING:** To reduce the risk of fire or electric shock, do not expose this apparatus to rain or moisture.
- **AVERTISSEMENT:** Pour réduire le risque d'incendie ou de choc électrique, ne pas exposer cet appareil sous la pluie et l'humidité.
- **CAUTION:** Use of controls or adjustments or performance of procedures other than those specified may result in hazardous radiation exposure.
- **WARNING:** Changes or modifications to this unit not expressly approved by the party responsible for compliance could void the user's authority to operate the equipment.
- **WARNING:** Do not place the unit on top of any soft, porous, or sensitive surfaces to avoid damaging the surface. Use a protective barrier between the unit and surface to protect the surface.
- **WARNING:** Use of this unit near fluorescent lighting may cause interference regarding use of the remote. If the unit is displaying erratic behavior move away from any fluorescent lighting, as it may be the cause.
- **CAUTION:** Danger of explosion if battery is incorrectly replaced. Replace only with the same or equivalent type.
- **PRÉCAUTION:** *Danger d'explosion si les piles sont remplacées de façon incorrect. Remplacer les piles seulement par le même type de pile ou l'équivalent.*
- **WARNING:** There is a danger of explosion if you attempt to charge standard Alkaline batteries in the unit. Only use rechargeable NiMH batteries.
- **WARNING:** The remote control's button cell battery contains mercury. Do not put in the trash, instead recycle or dispose of as hazardous waste

- **WARNING:** Lithium batteries, like all rechargeable batteries are recyclable and should be recycled or disposed of in normal household waste. Contact your local government for disposal or recycling practices in your area. They should never be incinerated since they might explode.
- **WARNING:** Shock hazard - Do Not Open.
- **AVIS:** *RISQUE DE CHOC ÉLECTRIQUE - NE PAS OUVRIR*

Mains plug is used as disconnect device and it should remain readily operable during intended use. In order to disconnect the apparatus from the mains completely, the mains plug should be disconnected from the mains socket outlet completely.

La prise du secteur est utilisé pour déconnecter le système.

La prise du secteur ne doit pas être obstruée ou doit être facilement accessible pendant son utilisation. Pour être complètement déconnecté de l'alimentation d'entrée, la prise doit être débranchée du secteur.

Do not mix old and new batteries.

Do not mix alkaline, standard (carbon-zinc), or rechargeable (ni-cad, ni-mh, etc) batteries.

No mezcle baterías viejas y nuevas.

No mezcle baterías alcalinas, estándar (carbono-zinc) o recargables (ni-cad, ni-mh, etc.).



WARNING: TO REDUCE THE RISK OF ELECTRIC SHOCK, DO NOT REMOVE COVER (OR BACK). NO USER-SERVICEABLE PARTS INSIDE. REFER SERVICING TO QUALIFIED SERVICE PERSONNEL.



The lightning flash with arrowhead symbol, within an equilateral triangle, is intended to alert the user to the presence of uninsulated "dangerous voltage" within the product's enclosure that may be of sufficient magnitude to constitute a risk of electric shock to persons.



The exclamation point within an equilateral triangle is intended to alert the user to the presence of important operating and maintenance (servicing) instructions in the literature accompanying the appliance.



This product utilizes a Class 1 laser to read Compact Discs. This laser Compact Disc Player is equipped with safety switches to avoid exposure when the CD door is open and the safety interlocks are defeated. Invisible laser radiation is present when the CD Player's lid is open and the system's interlock has failed or been defeated. It is very important that you avoid direct exposure to the laser beam at all times. Please do not attempt to defeat or bypass the safety switches.

Important Safety Instructions

1. Read these Instructions.
2. Keep these Instructions.
3. Heed all Warnings.
4. Follow all instructions.
5. Do not use this apparatus near water.
6. Clean only with a dry cloth.
7. Do not block any ventilation openings. Install in accordance with the manufacturer's instructions.
8. Do not install near any heat sources such as radiators, heat registers, stoves, or other apparatus (including amplifiers) that produce heat.
9. Do not defeat the safety purpose of the polarized or grounding - type plug. A polarized plug has two blades with one wider than the other. A grounding type plug has two blades and a third grounding prong. The wide blade or the third prong are provided for your safety. When the provided plug does not fit into your outlet, consult an electrician for replacement of the obsolete outlet.
10. Protect the power cord from being walked on or pinched particularly at plugs, convenience receptacles, and the point where they exit from the apparatus.
11. Only use attachments/accessories specified by the manufacturer.



12. Use only with a cart, stand, tripod, bracket, or table specified by the manufacturer, or sold with the apparatus. When a cart is used, use caution when moving the cart/apparatus combination to avoid injury from tip-over.

13. Unplug this apparatus during lightning storms or when unused for long periods of time.
14. Refer all servicing to qualified service personnel. Servicing is required when the apparatus has been damaged in any way, such as power-supply cord or plug is damaged, liquid has been spilled or objects have fallen into the apparatus, the apparatus has been exposed to rain or moisture, does not operate normally, or has been dropped.

FCC Warnings

WARNING: Changes or modifications to this unit not expressly approved by the party responsible for compliance could void the user's authority to operate the equipment.

NOTE: This equipment has been tested and found to comply with the limits for a Class B digital device, pursuant to Part 15 of the FCC Rules. These limits are designed to provide reasonable protection against harmful interference in a residential installation. This equipment generates, uses, and can radiate radio frequency energy and, if not installed and used in accordance with the instructions, may cause harmful interference to radio communications. However, there is no guarantee that interference will not occur in a particular installation. If this equipment does cause harmful interference to radio or television reception, which can be determined by turning the equipment off and on, the user is encouraged to try to correct the interference by one or more of the following measures:

- Reorient or relocate the receiving antenna.
- Increase the separation between the equipment and receiver.
- Connect the equipment into an outlet on a circuit different from that to which the receiver is connected.
- Consult the dealer or an experienced radio/TV technician for help.

Additional Warnings

- The apparatus shall not be exposed to dripping or splashing and that no objects filled with liquids, such as vases, shall be placed on apparatus.
L'appareil ne doit pas être exposé aux écoulements ou aux éclaboussures et aucun objet ne contenant de liquide, tel qu'un vase, ne doit être placé sur l'objet.
- Main plug is used as disconnect device and it should remain readily operable during intended use. In order to disconnect the apparatus from the mains completely, the mains plug should be disconnected from the mains socket outlet completely.
La prise du secteur ne doit pas être obstruée ou doit être facilement accessible pendant son utilisation. Pour être complètement déconnecté de l'alimentation d'entrée, la prise doit être débranchée du secteur.
- Battery shall not be exposed to excessive heat such as sunshine, fire or the like.
Les piles ne doivent pas être exposées à de forte chaleur, tel qu'à la lumière du soleil, au feu ou autres choses de semblable.
- Caution marking is located at the rear or back of the apparatus.
Attention marquage est situé à l'arrière ou à l'arrière de l'appareil
- The marking information is located at the rear or back of apparatus.
Les informations de marquage est situé à l'arrière ou à l'arrière de l'appareil.

This product incorporates copyright protection technology that is protected by U.S. patents and other intellectual property rights. Use of this copyright protection technology must be authorized by Rovi Corporation, and is intended for home and other limited viewing uses only unless otherwise authorized by Rovi Corporation. Reverse engineering and disassembly are prohibited.

24" Class TV/DVD Combo

Features

- 23.6" LED display
- DVD player: DVD, DVD±R/RW
- CD player: CD, CD-R/RW, JPEG CD
- Resolution: 1920 x 1080
- Max color: 16.7 million
- Brightness: 300 cd/m²
- Contrast: 1000 : 1
- Response time: <5ms
- Viewing angle: H=170, V=160
- V-chip
- Closed captioning
- Electronic program guide
- Sleep timer
- Multi-language OSD
- RF input
- 2 HDMI inputs
- 2 RCA audio inputs
- VGA/PC video input
- 3.5mm PC audio input
- 2 Composite video inputs
- 2 Component video inputs
- USB port
- Memory card reader
- AC power: requires an AC power cable (included)

Included

- Stand and 3 screws
- Remote control: requires 2 AAA batteries (included)
- AC power cable

** Please note, LCD panel specifications are subject to change without notice.*

Table of Contents

24" Class TV/DVD Combo	4
Features	
Included	
Table of Contents	5
Introduction	6
Setup	8
Power	
Remote Power	
Connecting the Stand	
Television Setup	9
Connecting a TV Antenna	
Connecting Basic Cable	
Connecting a Set-Top Box	
Auto Scanning for Channels	
Television	10
Channel List	
Saving a Channel as a Favorite	
Viewing Favorites	
Parental Controls	
Accessing the TV Menu	
Setting the Clock	
DVD	11
Loading and Playing a Disc	
Programming a DVD	
Accessing the DVD Setup Menu	
Memory Card Reader	12
Connecting a Memory Card	
Accessing the Connected Memory Card	
USB Port	13
Connecting a USB Thumb Drive	
Accessing the Connected USB Thumb Drive	
Connecting Other Devices	14
Connecting a Set-Top Box	
Connecting a Gaming Device	
Connecting a DVD Player or VCR	
Connecting a Computer	
Company Information	16
International Support	
Contact Information	
Green Initiative	

Introduction

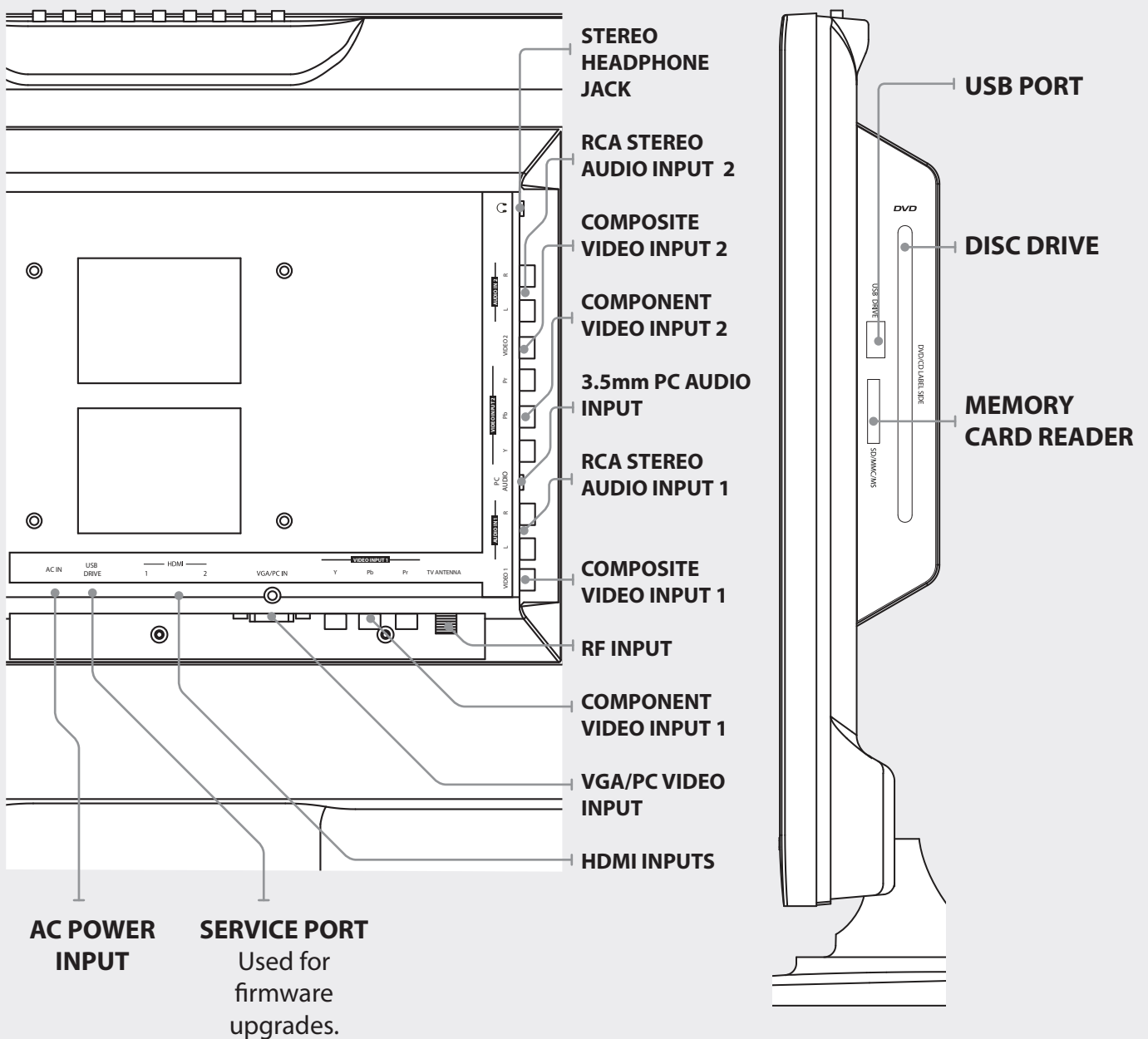
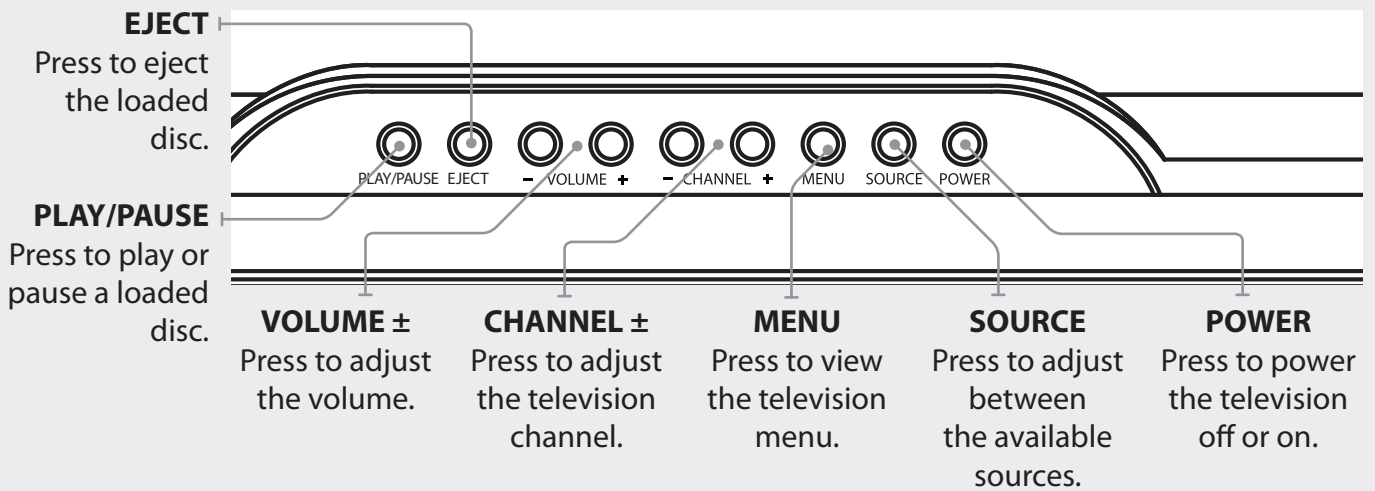

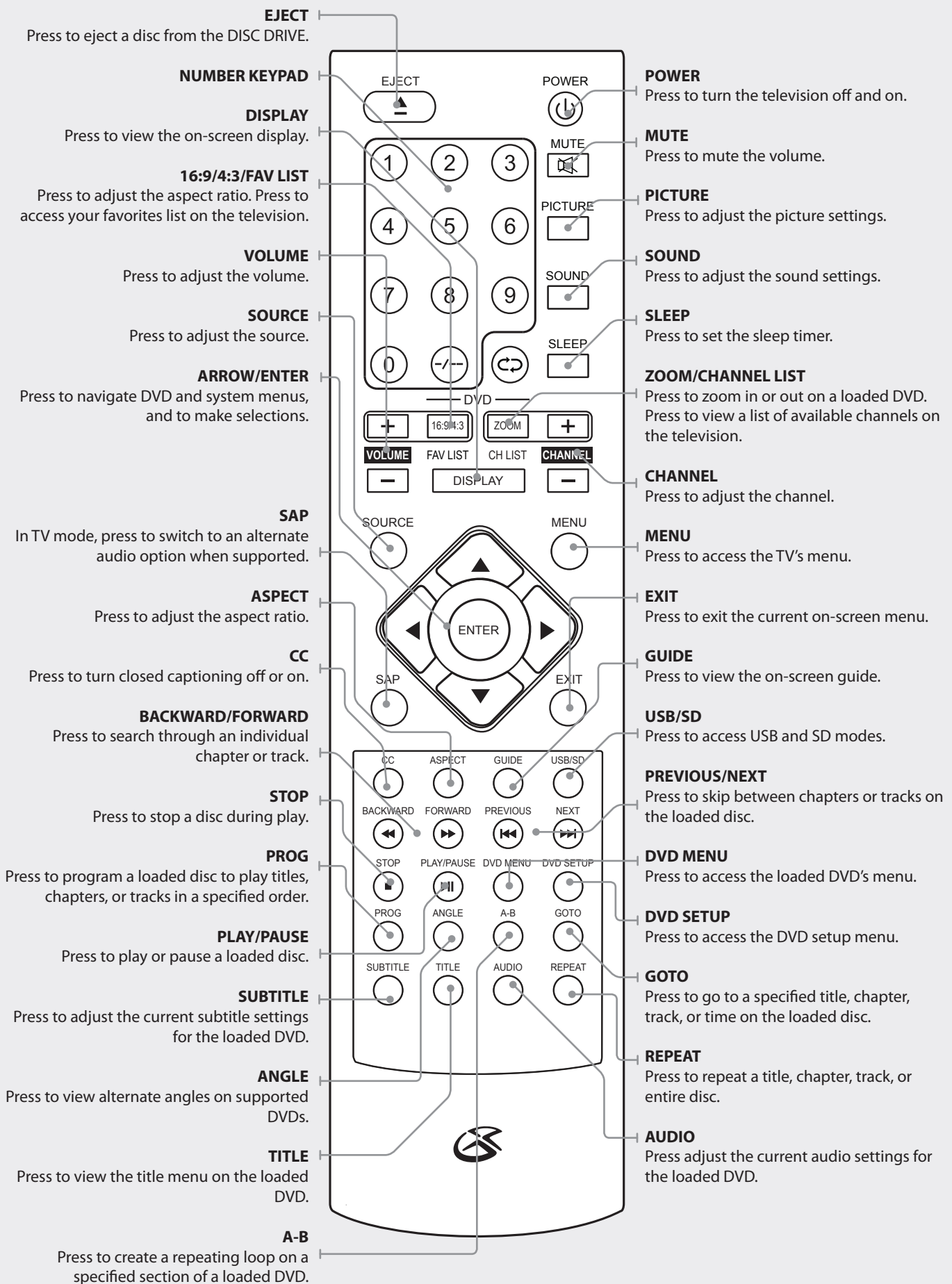

Setup

Power

Plug the attached AC cord into a standard AC power outlet to power the television.

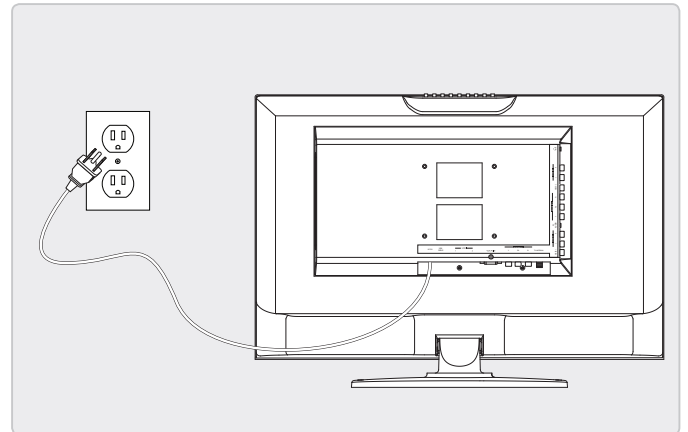

Remote Power

Requires 2, AAA size, batteries (included)

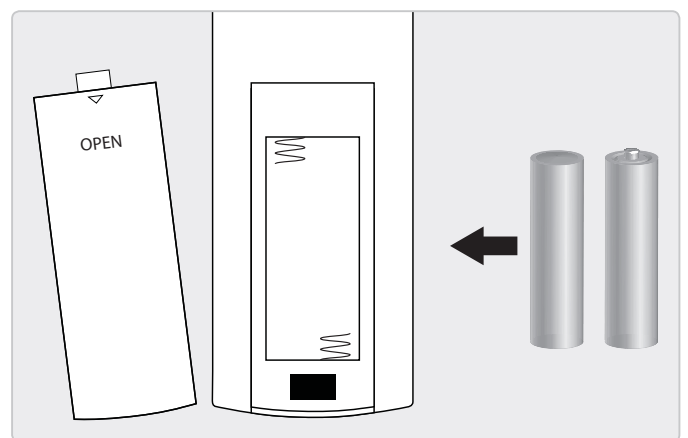

Connecting the Stand

Requires stand and 3 machine screws (all included)

1. Insert a single machine screw through the bottom of the stand and up into the television. Tighten by hand using a philips-head screw driver.
2. Insert the remaining two screws through the back of the stand and into the television. Tighten by hand using a philips-head screw driver.

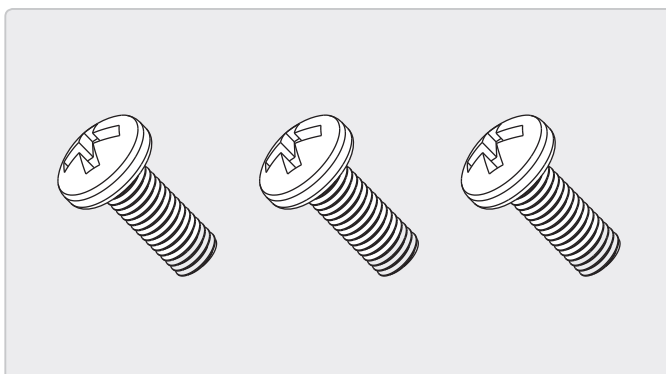
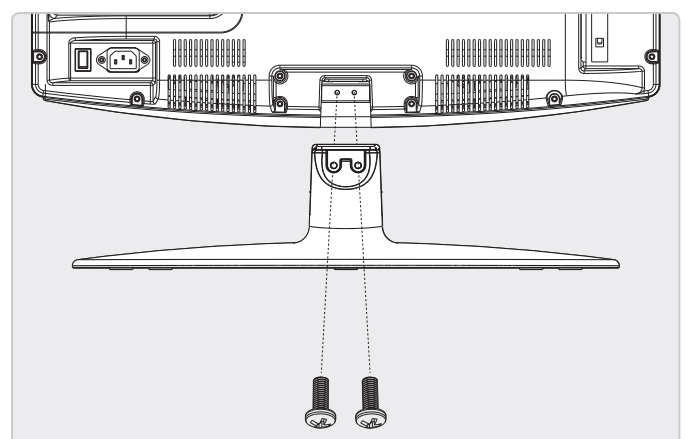
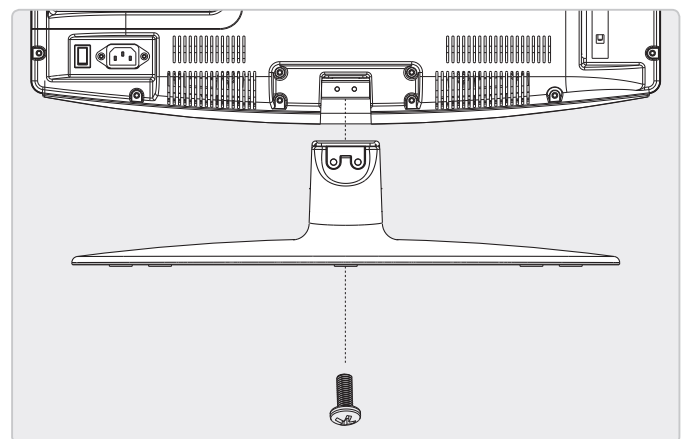

Television Setup

Connecting a TV Antenna

Requires a TV antenna (not included).

1. Connect a VHF, UHF, or HDTV antenna to the **RF INPUT** on the television.
The Auto Channel Scan must be run before any channels can be viewed on the television.
2. Press the **SOURCE** button and switch to TV mode.
3. Press the **MENU** button.
4. Use the **ARROW** buttons to select Channel in the on-screen menu. Press the **ENTER** button.
5. Use the **ARROW** buttons to select Signal Type in the on-screen menu. Press the **ARROW** buttons to change the Signal Type to Air.
6. Use the **ARROW** buttons to select Auto Channel Search in the on-screen menu. Press the **ENTER** button to automatically scan for available channels.

Connecting Basic Cable

Requires a cable connection.

1. Connect a cable to the **RF INPUT** on the television.
The Auto Channel Scan must be run before any channels can be viewed on the television.
2. Press the **SOURCE** button and switch to TV mode.
3. Press the **MENU** button.
4. Use the **ARROW** buttons to select Channel in the on-screen menu. Press the **ENTER** button.
5. Use the **ARROW** buttons to select Signal Type in the on-screen menu. Press the **ARROW** buttons to change the Signal Type to Cable.
6. Use the **ARROW** buttons to select Auto Channel Search in the on-screen menu. Press the **ENTER** button to automatically scan for available channels.

Connecting a Set-Top Box

Requires a Set-Top Box (not included).

If your Set-Top Box has an HDMI Output:

- Connect the HDMI output on the Set-Top Box to the **HDMI INPUT** on the television using an HDMI cable (not included).

If your Set-Top Box has a Composite Video Output:

- Connect the video output on the Set-Top Box to the **COMPOSITE VIDEO INPUT** on the television using an A/V RCA cable (not included). Connect the audio output on the Set-Top Box to the **RCA STEREO AUDIO INPUT** on the television.

If your Set-Top Box has a Component Video Output:

- Connect the component video output on the Set-Top Box to the **COMPONENT VIDEO INPUTS** on the television using a component RCA cable (not included). Connect the audio output on the Set-Top Box to the **RCA STEREO AUDIO INPUT** on the television.

After connecting your Set-Top Box:

- Press the **SOURCE** button to switch between TV, AV 1 or 2, YPbPr 1 or 2, HDMI 1 or 2, and VGA to match the connection used.

Auto Scanning for Channels

The Auto Channel Scan must be run before any channels can be viewed on the television.

1. Press the **SOURCE** button and switch to TV mode.
2. Press the **MENU** button.
3. Use the **ARROW** buttons to select **CHANNEL** in the on-screen menu. Press the **ENTER** button.
4. Use the **ARROW** buttons to select Auto Channel Search in the on-screen menu. Press the **ENTER** button to automatically scan for available channels.

Television

Channel List

Press the **CHANNEL LIST** button on the remote to view a list of available channels on the television.

If there are no channels in your channel list, you may need to re-run the Auto Scan for Channels. (see page 9)

Saving a Channel as a Favorite

1. In TV mode, press the **MENU** button.
2. Use the **ARROW** buttons to select Channel in the on-screen menu. Press the **ENTER** button.
3. Use the **ARROW** buttons to select Channel Setting in the on-screen menu. Press the **ENTER** button.
4. Use the **ARROW** buttons to select the Channel Number you want to save as a favorite.
5. Use the **ARROW** buttons to select Favorite Channel. Press the **ENTER** button to save the selected channel as a favorite.

Viewing Favorites

1. In TV mode, press the **FAVORITES LIST** button on the remote to access your favorites list on the television.
2. Use the **ARROW/ENTER** buttons to highlight and select a channel from the favorites list.

Parental Controls

1. In TV mode, press the **MENU** button.
2. Use the **ARROW** buttons to select Parental Control in the on-screen menu. Press the **ENTER** button.
3. The default passcode for the parental lock is: **0000**

From the V-CHIP settings you can lock TV and movies that have specific ratings.

Use the Front Panel Lock to lock the buttons on the television. *(The remote will still work if the Front Panel Lock is checked)*

Accessing the TV Menu

1. In TV mode, press the **MENU** button.
*To exit the TV menu, press the **EXIT** button on the remote.*

Setting the Clock

1. In TV mode, press the **MENU** button.
2. Use the **ARROW** buttons to select Setup in the on-screen menu. Press the **ENTER** button.
3. Use the **ARROW** buttons to select Clock in the on-screen menu. Press the **ENTER** button.
4. Use the **ARROW** buttons to select your time zone.
5. Use the **ARROW** buttons to highlight Setup Time.
6. Use the left and right **ARROW** buttons and **ENTER** button to adjust and save the date and time.

DVD

Loading and Playing a Disc

1. Press the **SOURCE** button to switch to DVD mode.
2. Insert a DVD or CD into the DISC DRIVE, label-side facing the rear of the TV.
The loaded disc will begin playing automatically.
3. If the loaded disc does not automatically play, press the **PLAY/PAUSE** button.

Programming a DVD

1. Follow the instructions for [Loading and Playing a Disc](#).
2. Press the **PROGRAM** button on the remote.
3. Use the **NUMBER KEYPAD** and **ARROW** buttons to enter title (TT) and chapters (CH) from the loaded DVD in the order you want them to play.

Disc title and chapter information can be obtained by pressing the DISPLAY button during DVD playback.

4. Press the **PLAY/PAUSE** button or use the **ARROW** buttons to highlight the on-screen PLAY button and press **ENTER** to begin playing the programmed DVD.

Accessing the DVD Setup Menu

1. To access the DVD Setup Menu, press the **DVD SETUP** button on the remote.

To exit the DVD setup menu, press the DVD SETUP button.

Memory Card Reader

Connecting a Memory Card

1. Load an SD, MS, or MMC memory card into the **MEMORY CARD READER** as shown in the image to the right.

Accessing the Connected Memory Card

1. Follow the instructions for [Connecting a Memory Card](#).
2. Press the **SOURCE** button to switch to DVD mode.
3. Press the **USB/SD** button on the remote to switch to CARD mode.
4. Use the **ARROW/ENTER** buttons to select and play content from the connected memory card.

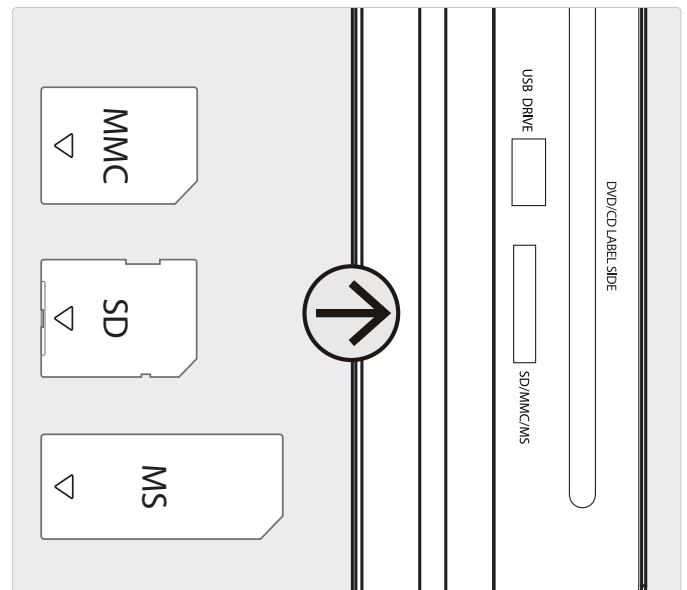

USB Port

Connecting a USB Thumb Drive

1. Connect a USB thumb drive to the **USB PORT** as shown in the image to the right.

Accessing the Connected USB Thumb Drive

1. Follow the instructions for [Connecting a USB Thumb Drive](#).
2. Press the **SOURCE** button to switch to DVD mode.
3. Press the **USB/SD** button on the remote to switch to USB mode.
4. Use the **ARROW/ENTER** buttons to select and play content from the connected USB thumb drive.

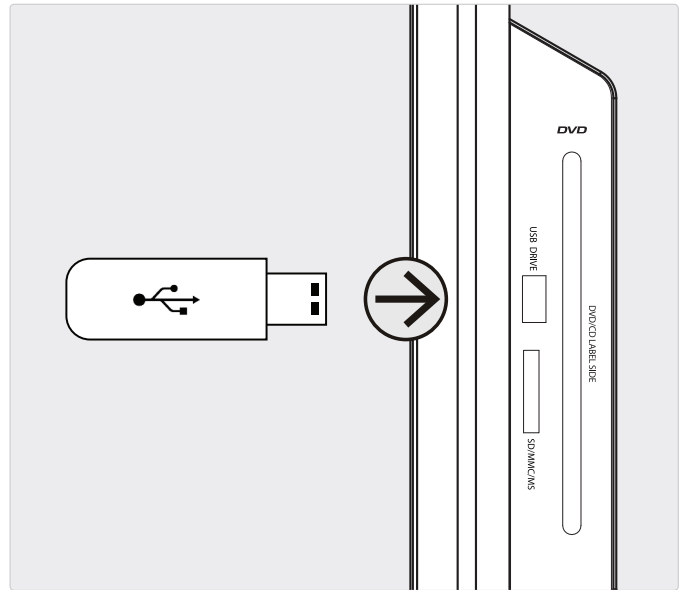

Connecting Other Devices

Connecting a Set-Top Box

- You will need: a set-top box, composite and RCA stereo cables or component and RCA stereo cables or an HDMI cable. (not included)
- Connect the set-top box's *audio* and *video outputs* to the corresponding audio and video inputs on the television.
- Press the **SOURCE** button to switch between TV, AV 1 or 2, YPbPr 1 or 2, HDMI 1 or 2, and VGA to match the connection used.

Connecting a Gaming Device

- You will need: a gaming device, composite and RCA stereo cables or component and RCA stereo cables or an HDMI cable. (not included)
- Connect the gaming device's *audio* and *video outputs* to the corresponding audio and video inputs on the television.
- Press the **SOURCE** button to switch between TV, AV 1 or 2, YPbPr 1 or 2, HDMI 1 or 2, and VGA to match the connection used.

Connecting a DVD Player or VCR

- You will need: a DVD player or VCR, composite and RCA stereo cables or component and RCA stereo cables or an HDMI cable.
- Connect the DVD player or VCR's *audio* and *video outputs* to the corresponding audio and video inputs on the television.
- Press the **SOURCE** button to switch between TV, AV 1 or 2, YPbPr 1 or 2, HDMI 1 or 2, and VGA to match the connection used.

Connecting a Computer

- You will need: a PC with a VGA output, and a VGA cable. (not included)
- Connect the computer's *VGA output* to the **VGA/PC INPUT** on the television.
- Power the television on and press the **SOURCE** button to switch to the *VGA Mode*.
- Audio from the connected PC can be input to the television through the TV's **PC AUDIO INPUT** by using a 3.5mm audio cable (not included).

Company Information

International Support

To download this User's Guide in English, Spanish, or French, visit the support section at www.gpx.com.

Para transferir esta guía de usuario en inglés, español, o francés, visite la sección de la ayuda en www.gpx.com.

Pour télécharger ce guide de l'utilisateur en anglais, espagnol, ou français, visitez la section de soutien chez www.gpx.com.

Contact Information

Phone:

1-888-999-4215

Email:

prodinfo@gpx.com

Parts Email:

partsinfo@dpi-global.com

Website:

www.gpx.com

Green Initiative



Environmental Commitment to 'Protect for Today and Sustain for Tomorrow'

2009 marked the official launch of DPI, Inc.'s corporate campaign for a greener and cleaner world. DPI is building upon environmental initiatives introduced at all of their facilities to help formulate and sustain significant and important conservation efforts within its manufacturing and marketing communities. In addition to targeting and selecting energy efficient product features, and structuring 'green office' procedures, other initial program efforts include:

- Reduction of all packaging sizes
- Recyclable plastics for clamshell packages, with a plan to eventually replace plastic with recyclable paper
- Recycled fiber board in place of the polyfoam in packing boxes
- Recycled plastics in place of the virgin material in product construction

Free Manuals Download Website

<http://myh66.com>

<http://usermanuals.us>

<http://www.somanuals.com>

<http://www.4manuals.cc>

<http://www.manual-lib.com>

<http://www.404manual.com>

<http://www.luxmanual.com>

<http://aubethermostatmanual.com>

Golf course search by state

<http://golfingnear.com>

Email search by domain

<http://emailbydomain.com>

Auto manuals search

<http://auto.somanuals.com>

TV manuals search

<http://tv.somanuals.com>