

Read all instructions BEFORE assembly and use of this product.

Keep instructions for future use.

We recommend that you keep these instructions with your Pack 'N Play. A storage pocket has been provided for them on the bottom panel of your unit.

GRACO® Pack 'N Play®

OWNER'S MANUAL

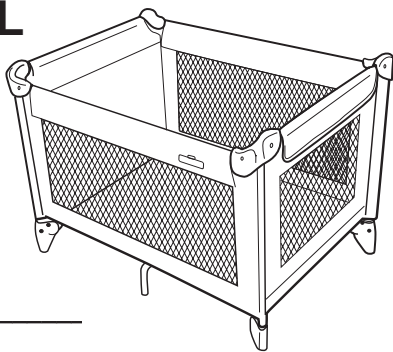

Model No. _____
Serial No. _____

Dear Customer,
Please fill in the model and serial numbers above from the label on the center of the bottom of your new Pack 'N Play.

**Models 9000, 9010, 9040, 9048,
9050, 9080, 9700, 9710, 9718,
9748 & 9749**

Congratulations on your purchase of a Graco® Pack 'N Play®!

Graco is the recognized leader in the design and manufacture of quality baby products. We believe your new Graco® Pack 'N Play® is a wise choice, promising many hours of enjoyment for your baby.

Customer Satisfaction

Our goal is to make every product the best it can be! We are also committed to supporting our products after purchase. If you would like to speak to Graco about your product, please contact our **Customer Service Department at 1-800-345-4109**. Our knowledgeable staff will be ready to answer any questions you may have concerning parts, use, or maintenance. When you call, please have the **model and serial numbers** ready so your call may be processed quickly and efficiently.

Your Pack 'N Play® may be used as a play yard or portable crib. Please read all instructions in this manual and those found on the bottom panel of your unit. Spend reading the instructions and warnings will help you use your product safely.

⚠ WARNING

Failure to follow the instructions could result in injury or death.

Setting Up the Pack 'N Play

- THIS PRODUCT REQUIRES ADULT ASSEMBLY.
- Keep fingers clear of top corners during set-up. Be sure Pack 'N Play is completely set-up before use. Check that the 4 top rails are completely latched, the center of the floor is pushed down, and the mattress is flat and secured by the VELCRO® strips. Always follow the instructions in the owner's manual to set up the Pack 'N Play.
- Before each use, inspect this product for damaged hardware, loose joints, missing parts or sharp edges. Do not use Pack 'N Play if any parts are missing or broken. Call 1-800-345-4109 for replacement parts or owner's manual. Do not substitute parts.

Using the Pack 'N Play

- The Pack 'N Play can be used as a play yard or a sleeping crib. When used as a play yard, never leave child unattended and always keep child in view. When used as a sleeping crib, you must still provide the supervision necessary for the continued safety of your child.
- Always keep the Pack 'N Play away from hazards in the area that may injure your child.
- Do not add padding or other objects inside the Pack 'N Play that will permit your child to climb out.
- Stop using this product when your child reaches 35 inches (890 mm) in height, or weighs more than 30 pounds (14 kg) or is able to climb out.
- Do not modify Pack 'N Play or add any attachments that are not listed in the owner's manual, including an add-on bassinet.

Avoiding Suffocation Hazards

- Unlike cribs that have rigid sides, the Pack 'N Play has flexible sides. As a result, the Pack 'N Play mattress is specially designed to prevent suffocation. The Pack 'N Play mattress has a solid base, a certain

⚠ WARNING

Failure to follow the instructions could result in injury or death.

ard or portable crib. Read and follow the warnings and on the bottom of the Pack 'N Play. The short time you s will help you use your Pack 'N Play properly.

Follow these warnings and the assembly s could result in serious injury or death.

length and width, and is less than one inch thick in order to meet safety standards. Using a thicker or a different sized mattress may allow a child's head to get between mattress and the side of the Pack 'N Play causing suffocation.

- To help prevent suffocation from entrapment, **USE ONLY THE MATTRESS PROVIDED BY GRACO.** Never use additional mattress or padding.
- Never use plastic shipping bags or other plastic film as mattress covers not sold and intended for that purpose. They can cause suffocation.
- Do not use a water mattress with the Pack 'N Play.

Avoiding Strangulation Hazards

- Strings and cords can cause strangulation. Keep strings and cords away from child.
 - Do not place the Pack 'N Play near a window where cords from blinds or drapes can strangle a child.
 - Do not hang strings on or over the Pack 'N Play.
 - Do not place items with a string around a child's neck, such as hood strings, pacifier cords, etc.
 - Do not attach strings to toys.

This product is not intended for commercial use.

CARE AND MAINTENANCE

FROM TIME TO TIME CHECK YOUR PACK 'N PLAY for worn parts, torn material or stitching. Replace or repair the parts as needed. Use only Graco® replacement parts.

IF PACK 'N PLAY IS USED AT THE BEACH, you **MUST** clean sand off your Pack 'N Play, including the feet, before packing it into cover. Sand in top rail lock may damage it.

TO CLEAN PACK 'N PLAY, use only household soap or detergent and warm water. **NO BLEACH.**

TO WASH CARRY BAG AND FITTED SHEET (on certain models), machine wash in lukewarm water on delicate cycle and drip-dry. **NO BLEACH.**

ure to follow these warnings and s could result in serious injury or death.

Setting up the Pack 'N Play® is easy, but only if you know how.

To Set Up Your Pack 'N Play®

Step 1.

Undo the three VELCRO® straps. Fold VELCRO® straps back onto themselves.

Set mattress aside.

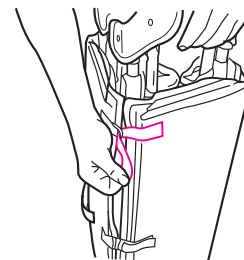

Step 2.

IMPORTANT: Leave center of floor UP until all four top rails are latched.

Grasp the bottom of two of the top rails, and pull up until you hear a "click."

Be sure top rails have become rigid.

If not, pull up again until they are rigid.

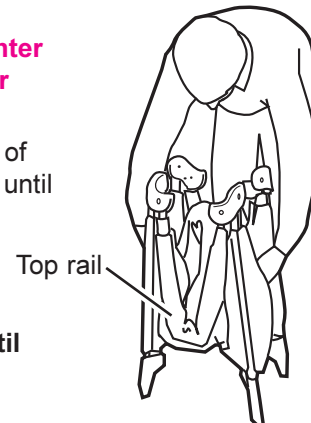

FOR SMOOTH SETUP and takedown, it's important to remember one thing: the center of the floor must be at least halfway up when locking OR unlocking rails (see picture below). Therefore:

- **When setting up, lock rails BEFORE lowering center.**
- **When taking down, raise center halfway BEFORE unlocking rails.**

Step 3.

Pull up the other two sides until they latch.

NOTE: If top rails do not latch, lift the center of the floor higher. Center of floor must be at least halfway up for the latches to catch properly.

Be sure all top rails are rigid.

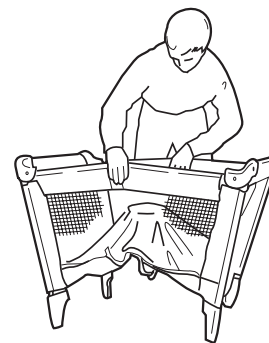

Step 4.

Hold one end of the unit up and push the center of the floor down.

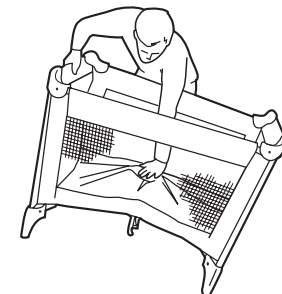

At first your Pack 'N Play may be like a new pair of shoes. You may need to break it in by slightly stretching the netting and fabric. If the center does not stay down, place some weight (several books) in the center of the unit and let it stand overnight.

Step 5.

Do not use your Pack 'N Play without the mattress provided by Graco.

Cover soft side of mattress with fitted sheet (on certain models). Place mattress into your unit with padded side up.

Always use your unit with mattress installed soft side up.

Slide the two VELCRO® straps through slots in bottom of Pack 'N Play and fasten to VELCRO® on underside. This will prevent mattress from moving.

Make sure the mattress is installed properly before placing your child in the Pack 'N Play.

Your Pack 'N Play is ready to use.

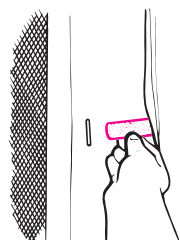
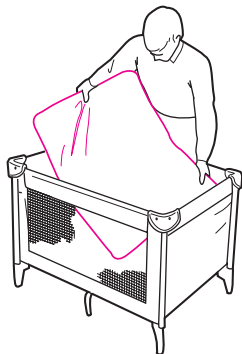

Accessory Features (on certain models)

SIDE FLAPS:

You can raise side and end flaps if desired.

Unfasten VELCRO® strips at bottom of flap. Roll flap up.

Fasten in place with snap loops at top.

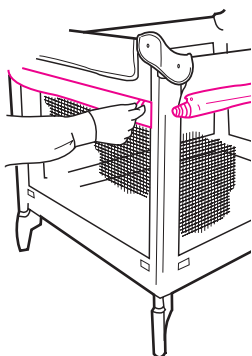

TOY BAG:

Toy bag snaps on at top of end without flap. Maximum weight 2 lbs (0.9 kg).

DO NOT machine wash or dry in a dryer. DO NOT dry clean. Spot clean with a damp cloth and a mild detergent. NO BLEACH.

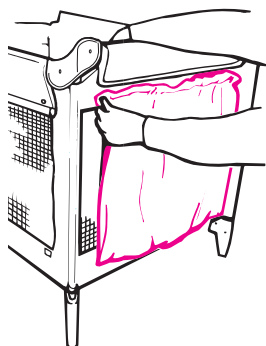

MESH NET:

Mesh net can be fitted to the top of the Pack 'N Play if desired.

CARGO BAG:

The cargo bag can be snapped on to the end of the Pack 'N Play for easy access. Unzip both ends and tuck inside the bag. Maximum weight 5 lbs (2.3 kg).

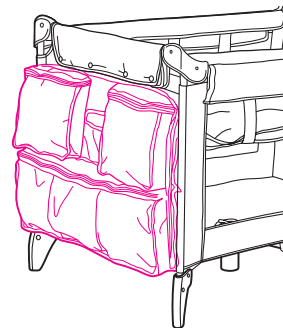

CASTERS:

To apply the locks, push **DOWN** on the levers.

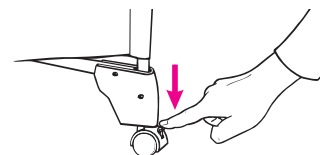

To release the locks, lift **UP** on the levers.

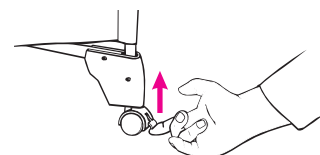

WHEELS:

To apply the locks, push **DOWN** on the levers.

To release the locks, lift **UP** on the levers.

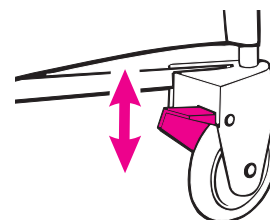

To Fold Your Pack 'N Play®

Step 1.

Lower any roll-down flaps. Apply locks on wheels or casters. Release the two VELCRO® straps under the Pack 'N Play and remove the mattress.

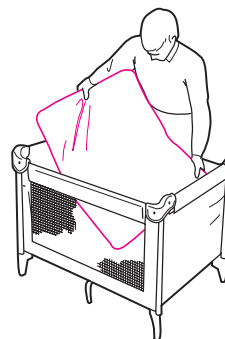

Step 2.

IMPORTANT: Raise center halfway **BEFORE** unlocking rails.

Grasp center loop as shown and pull up approximately halfway to the top rails.

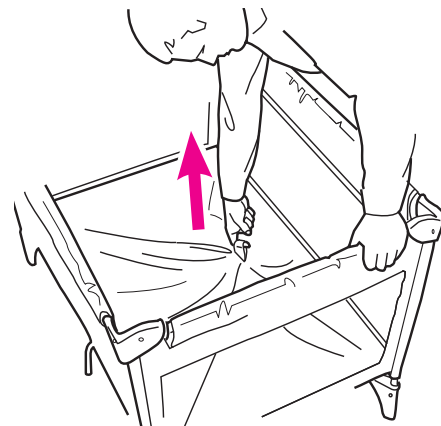

Step 3.

The top rail has a center piece with two tubes hidden under the fabric. The button on the bottom of the center piece releases the two tubes when it is pushed up.

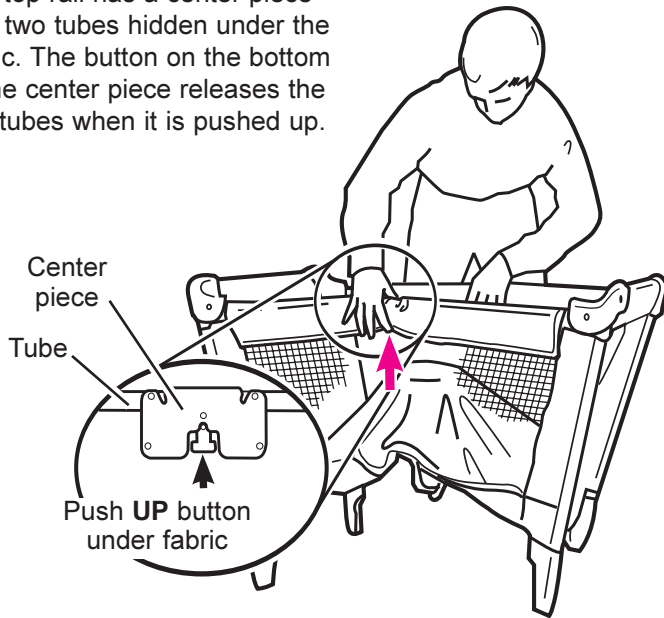

To fold the top rail:

- Lift up slightly on the top rail.
- Push up on the button located under the symbol  to release the two tubes.
- Push down.

HINTS:

- If top rails do not unlatch, lift the center of the floor higher.
- Both tubes must be released for the top rail to fold.

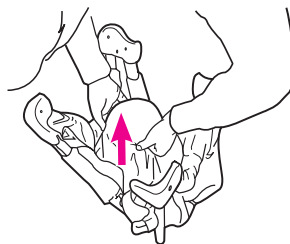
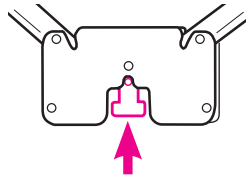

Step 4.

Pull center up all the way.

Step 5.

Gather your unit together. Do not force.

If unit will not fold, look for a partially latched top rail. Squeeze the latch button to release the rail.

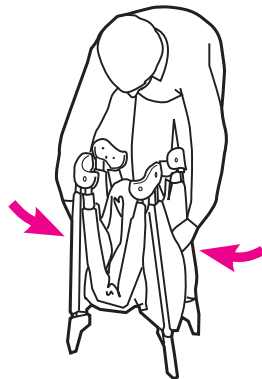

Step 6.

Find the bottom corner belt loop (only one). This loop is for holding unit and mattress together while carrying.

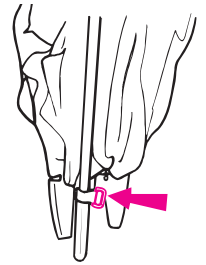

Step 7.

Wrap the mattress around your unit. Fasten together the VELCRO® straps, attaching the bottom strap to the bottom corner belt loop.

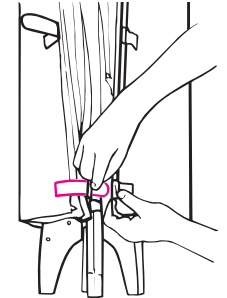

To Cover Your Pack 'N Play®

Step 1.

Pull cover over your unit. Be sure the carrying handle attached to the mattress is exposed.



Step 2.

On models with wheels, push the plastic end of bag over the wheels and feet of the unit.

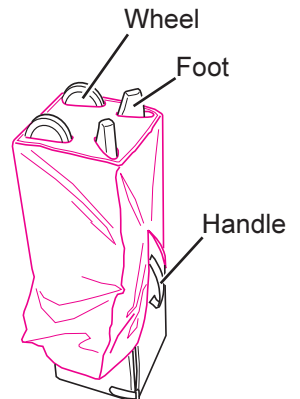

Step 3.

Zip together.

The cargo bag (on certain models) opens on either end. Slip the bag over the Pack 'N Play. Check that the carrying handle attached to the mattress sticks out the hole in the bag. Zip both ends.



Replacement Parts

Instructions for ordering Pack 'N Play® parts:

Complete form below. Your Pack 'N Play model number **MUST** be included on the form to ensure proper replacement parts. Your model number can be found on a label on the center of the bottom of the unit.

Payment must accompany your order.

Parts List:	Price:**
Mattress	\$17.50
Carry bag	\$12.00
Cargo bag*	\$15.00
Toy bag*	\$12.00
Mesh net*	\$ 8.00
Caster assembly*	\$ 5.00 (each)/\$8.00 (2)
Wheels*	\$ 7.00 (each)/\$10.00 (2)
Fitted sheet*	\$10.00

* On certain models

** Prices subject to change without notice.

IF YOU NEED HELP

If you have any questions, please call toll-free:

1-800-345-4109

Return the form below with payment to:
GRACO CHILDREN'S PRODUCTS INC.
CUSTOMER SERVICE DEPARTMENT
P.O. BOX 100, MAIN STREET
ELVERSON, PA 19520

Model Number	SHIP TO:
(Must be filled in)	Name _____
<input type="checkbox"/> Mattress	Address _____
<input type="checkbox"/> Carry bag	City, State, Zip _____
<input type="checkbox"/> Cargo bag	() _____
<input type="checkbox"/> Toy bag	Telephone _____
<input type="checkbox"/> Mesh net	
<input type="checkbox"/> Caster assembly	<input type="checkbox"/> Check enclosed (payable to Graco Children's Products Inc.)
<input type="checkbox"/> Wheels	<input type="checkbox"/> Charge to credit card:
<input type="checkbox"/> Fitted sheet	<input type="checkbox"/> Visa
	<input type="checkbox"/> MasterCard
	<input type="checkbox"/> Discover
Total: _____	Account #: _____
6% sales tax (PA only): _____	Expiration date: _____
Total amount due: _____	Signature: _____

Free Manuals Download Website

<http://myh66.com>

<http://usermanuals.us>

<http://www.somanuals.com>

<http://www.4manuals.cc>

<http://www.manual-lib.com>

<http://www.404manual.com>

<http://www.luxmanual.com>

<http://aubethermostatmanual.com>

Golf course search by state

<http://golfingnear.com>

Email search by domain

<http://emailbydomain.com>

Auto manuals search

<http://auto.somanuals.com>

TV manuals search

<http://tv.somanuals.com>