

EM-40 SERIES
Horizontal Mount - Vertical Airflow Down
Application and Design

The EM-40 series is a horizontally mounted backdraft damper that is designed to allow vertical airflow down and prevent reverse airflow. The damper is opened by air pressure differential and closed by gravity. Standard models include adjustable counterbalance weights to assist closing.

Ratings (See page 2 for specific limitations)

Pressure: 4.0 - 10.0 in. wg (996 Pa - 2491 Pa) differential pressure

Velocity: 2500 to 3500 fpm (13m/s - 18 m/s)

Temperature: 180°F (82°C)

Standard Construction

Frame: Heavy gauge 6063T5 extruded aluminum. (0.125 in. [3.2mm] thickness)

Blades: Heavy gauge 6063T5 extruded aluminum. (0.070 in. [1.8mm] thickness)

Axles: 3/4 in. (19mm) dia. metallic

Bearings: Synthetic (acetal) sleeve type

Linkage: 1/8 in. (3mm) plated steel

Blade Seals: Vinyl

Size Limitations

Minimum Size: 8 in. W x 11 in. H (203mm x 279mm)

Maximum Panel Size: 48 in. W x 74 in. H (1219mm x 1880mm)

Sizes larger than maximum shown will be supplied as two or more equal size smaller dampers required to make up the size specified. These larger multiple damper assemblies require field assembly and may require additional reinforcement (not supplied by Greenheck) to support the assembly.

Options and Accessories

- 1 1/2 in. flange on discharge: EM-41
- 1 1/2 in. flange on intake: EM-42
- APC (Adjustable Pressure Controller). Allows field setting of relief pressure on all EM dampers. Use one per panel. Maximum recommended pressure set limitations are as follows:

Area ft ² (m ²)	Maximum Set Pressure in. wg (Pa)
4 (.37)	.75 (187)
6 (.56)	.50 (125)
8 (100)	.40 (100)
10 (.93)	.30 (75)
15 (1.39)	.20 (50)
20 (1.86)	.15 (37)
24 (2.23)	.125 (31)

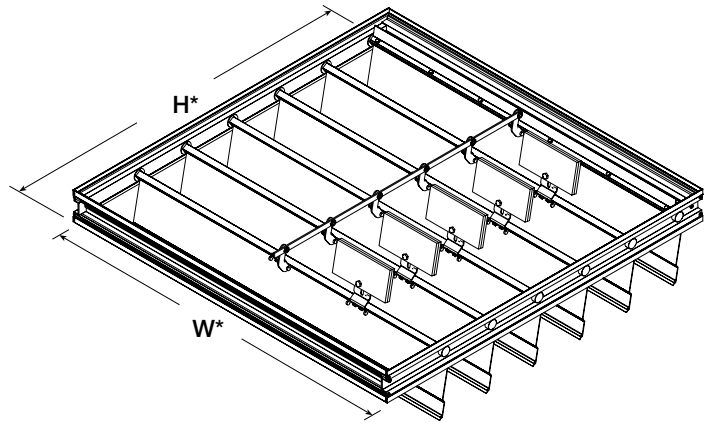

*W & H dimensions furnished approximately 1/4 in. (6mm) under size.

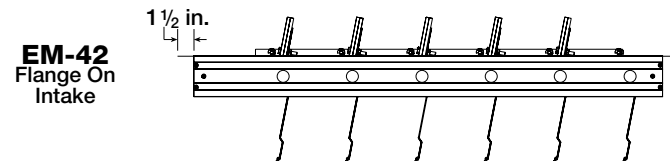
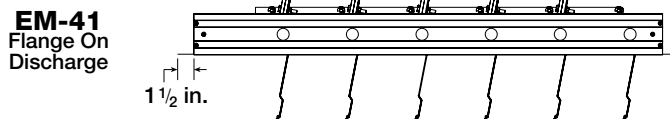
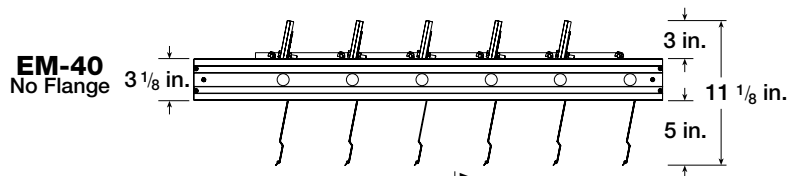

Counterbalance weights may require field adjustment. Instructions are available at www.greenheck.com.

Performance data results from testing a 36 in. x 36 in. (914mm x 914mm) damper in accordance with AMCA Standard 500-D using Figure 5.7A (unducted). All data has been corrected to represent standard air at 0.075 lb/ft³ (1.201 kg/m³).

Operational Data		ΔP in. wg (Pa)	Velocity fpm (m/s)
Damper with Standard Bearings	Blades Start to Open	0.07 (17)	50 (.254)
	Blades Fully Open	0.20 (50)	1200 (6.2)

Leakage testing was conducted in accordance with AMCA Standard 500-D and is expressed as CFM per sq. ft. of damper face area. All data has been corrected to represent standard air at 0.075 lb/ft³ (1.201 kg/m³).

Leakage
36 in. x 36 in. Damper

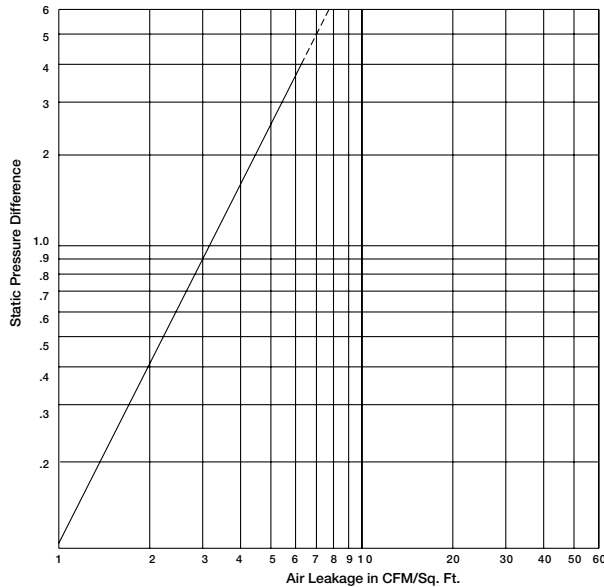

Pressure Drop

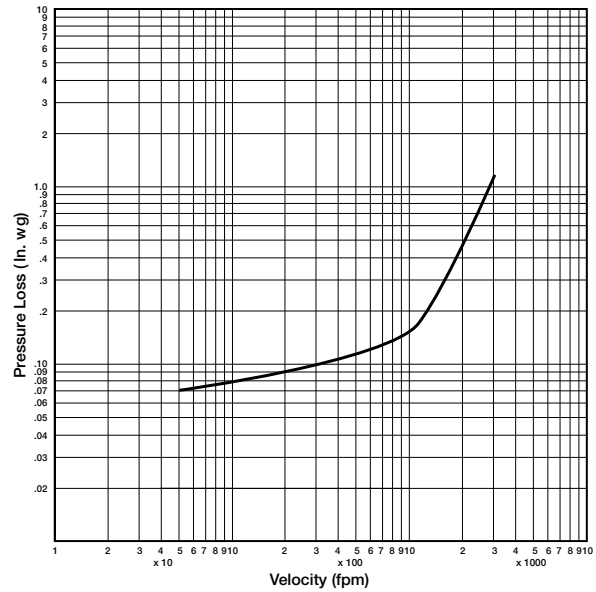

Pressure Limitations

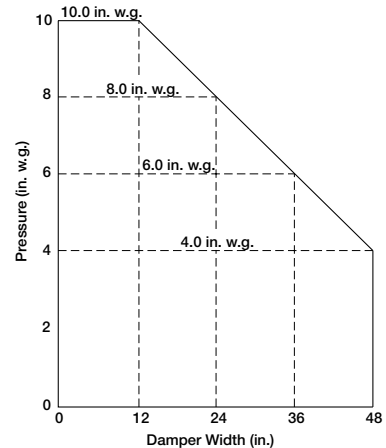

Specifications

Backdraft dampers meeting the following specifications shall be furnished and installed where shown on plans and/or as described in schedules. Dampers shall consist of: heavy gauge 6063T5 extruded aluminum channel frame (0.125 in. [3.2mm] thick) with 3 1/8 in. (79mm) depth; blades from 0.070 in. (1.8mm) 6063T5 extruded aluminum; 3/4 in. (19mm) dia. metallic axles turning in acetal bearings; damper shall be equipped with extruded vinyl blade seals; and internal 1/8 in. (3mm) plated steel blade-to-blade linkage. Damper manufacturer's printed application and performance data including pressure, velocity and temperature limitations shall be submitted for approval showing damper suitable for pressures to 10 in. wg (2491 Pa), velocities to 3500 fpm (18 m/s) and temperatures to 180°F (82°C). Testing and ratings to be in accordance with AMCA Standard 500-D. Basis of design is Greenheck model EM-40.

Velocity Limitations

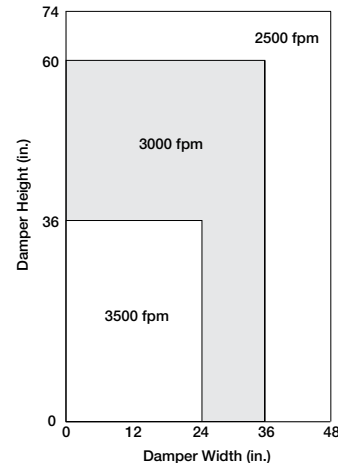

P.O. Box 410 • Schofield, WI 54476-0410 • 715.359.6171 • greenheck.com

Copyright © 2008 Greenheck Fan Corporation
EM-40 Rev 4 Aug 2008

Free Manuals Download Website

<http://myh66.com>

<http://usermanuals.us>

<http://www.somanuals.com>

<http://www.4manuals.cc>

<http://www.manual-lib.com>

<http://www.404manual.com>

<http://www.luxmanual.com>

<http://aubethermostatmanual.com>

Golf course search by state

<http://golfingnear.com>

Email search by domain

<http://emailbydomain.com>

Auto manuals search

<http://auto.somanuals.com>

TV manuals search

<http://tv.somanuals.com>