

Grizzly Industrial, Inc.®

3 HP AIR COMPRESSOR

MODEL H3372

INSTRUCTION MANUAL



COPYRIGHT © APRIL, 2003 BY GRIZZLY INDUSTRIAL, INC.
**WARNING: NO PORTION OF THIS MANUAL MAY BE REPRODUCED IN ANY SHAPE
OR FORM WITHOUT THE WRITTEN APPROVAL OF GRIZZLY INDUSTRIAL, INC.**
PRINTED IN CHINA

ONLINE MANUAL DISCLAIMER

THE INFORMATION IN THIS MANUAL REPRESENTS THE CONFIGURATION OF THE MACHINE AS IT IS CURRENTLY BEING SHIPPED. THE MACHINE CONFIGURATION CAN CHANGE AS PRODUCT IMPROVEMENTS ARE INCORPORATED. IF YOU OWN AN EARLIER VERSION OF THE MACHINE, THIS MANUAL MAY NOT EXACTLY DEPICT YOUR MACHINE. CONTACT CUSTOMER SERVICE IF YOU HAVE ANY QUESTIONS ABOUT DIFFERENCES. PREVIOUS VERSIONS ARE NOT AVAILABLE ONLINE.

WARNING

Some dust created by power sanding, sawing, grinding, drilling, and other construction activities contains chemicals known to the State of California to cause cancer, birth defects or other reproductive harm. Some examples of these chemicals are:

- Lead from lead-based paints.
- Crystalline silica from bricks, cement, and other masonry products.
- Arsenic and chromium from chemically treated lumber.

Your risk from these exposures varies, depending on how often you do this type of work. To reduce your exposure to these chemicals: work in a well ventilated area, and work with approved safety equipment, such as those dust masks that are specially designed to filter out microscopic particles.

SAFETY

WARNING

For Your Own Safety Read Instruction Manual Before Operating This Equipment

The purpose of safety symbols is to attract your attention to possible hazardous conditions. This manual uses a series of symbols and signal words which are intended to convey the level of importance of the safety messages. The progression of symbols is described below. Remember that safety messages by themselves do not eliminate danger and are not a substitute for proper accident prevention measures.

DANGER

Indicates an imminently hazardous situation which, if not avoided, WILL result in death or serious injury.

WARNING

Indicates a potentially hazardous situation which, if not avoided, COULD result in death or serious injury.

CAUTION

Indicates a potentially hazardous situation which, if not avoided, MAY result in minor or moderate injury. It may also be used to alert against unsafe practices.

NOTICE

This symbol is used to alert the user to useful information about proper operation of the equipment.

WARNING

Safety Instructions For Pneumatic Tools

- 1. KEEP ALL SAFETY DEVICES IN PLACE** and in working order.
- 2. REMOVE ADJUSTING KEYS AND WRENCHES.** Form a habit of checking to see that keys and adjusting wrenches are removed from tool before operation.
- 3. KEEP WORK AREA CLEAN.** Cluttered areas and benches invite accidents.
- 4. DO NOT USE IN DANGEROUS ENVIRONMENT.** DO NOT use pneumatic tools in damp or wet locations, or where any flammable or noxious fumes may exist. Keep work area well lighted.
- 5. KEEP CHILDREN AND VISITORS AWAY.** All children and visitors should be kept at a safe distance from work area.
- 6. MAKE WORKSHOP CHILD PROOF** with padlocks, master switches, or by removing air hoses from tools.
- 7. DO NOT FORCE TOOL.** It will do the job better and safer at the rate for which it was designed.
- 8. USE THE RIGHT TOOL.** DO NOT force tool or attachment to do a job for which it was not designed.
- 9. DO NOT USE UNDER THE INFLUENCE OF DRUGS OR ALCOHOL.**

WARNING

Safety Instructions For Pneumatic Tools

10. **USE PROPER AIR HOSE** for the tool. Make sure your air hose is in good condition and is long enough to reach your work without stretching.
11. **WEAR PROPER APPAREL.** DO NOT wear loose clothing, gloves, neckties, rings, bracelets, or other jewelry which may get caught in moving parts. Non-slip footwear is recommended. Wear a protective hair covering to contain long hair.
12. **ALWAYS USE SAFETY GLASSES.** Also use a face or dust mask if cutting operation is dusty. Everyday eyeglasses only have impact resistant lenses, they are NOT safety glasses.
13. **WEAR APPROVED HEARING PROTECTION.**
14. **SECURE WORK.** Use clamps or a vise to hold work when practical. It is safer than using your hand and frees both hands to operate tool.
15. **DO NOT OVERREACH.** Keep proper footing and balance at all times.
16. **MAINTAIN TOOLS WITH CARE.** Keep tools lubricated and clean for best and safest performance. Follow instructions for lubricating and changing accessories.
17. **REDUCE THE RISK OF UNINTENTIONAL STARTING.** DO NOT carry tool with hand on trigger and always disconnect from air when not in use.
18. **DISCONNECT TOOLS** before servicing and changing accessories.
19. **USE THE RECOMMENDED ACCESSORIES.** Consult the owner's manual for recommended accessories. The use of improper accessories may cause risk of injury.
20. **CHECK DAMAGED PARTS.** Before further use of the tool, a guard or other part that is damaged should be carefully checked to determine that it will operate properly and perform its intended function. Check for alignment of moving parts, binding of moving parts, breakage of parts, mounting, and any other conditions that may affect its operation. A guard or other part that is damaged should be properly repaired or replaced.
21. **NEVER LEAVE UNATTENDED TOOL CONNECTED TO AIR.** Disconnect the air hose and DO NOT leave tool until it is relieved of any built up pressure.
22. **NEVER ALLOW UNTRAINED USERS TO USE THIS TOOL WHILE UNSUPERVISED.**
23. **IF YOU ARE UNSURE OF THE INTENDED OPERATION, STOP USING THE TOOL.** Seek formal training or research books or magazines that specialize in pneumatic tools.

WARNING

Additional Safety For Air Compressors

- 1. READ THIS ENTIRE MANUAL BEFORE OPERATING THE COMPRESSOR.**
- 2. OPERATE THE COMPRESSOR IN A WELL VENTILATED AREA** free of acids, vapor, explosive gases and flammable or unstable materials.
- 3. DO NOT PULL ON THE GAUGES OR REGULATORS TO MOVE THE COMPRESSOR!**
- 4. DO NOT USE THE COMPRESSOR FOR FILLING BREATHING OR DIVING APPARATUS.** Compressed air from this compressor cannot be used for pharmaceutical, food or health requirements without further treatment.
- 5. NEVER TRANSPORT THE COMPRESSOR UNDER PRESSURE.** Always release the pressure in the storage tanks before moving.
- 6. NEVER RUN THE COMPRESSOR BEYOND THE ADVISED DUTY CYCLE!** The advised duty cycle is described on **page 7**.
- 7. DRAIN TANK DAILY OR AT THE END OF EACH USE** to avoid tank corrosion and possible tank rupture.
- 8. AVOID TOUCHING THE TOP OF THE MOTOR HOUSING,** it will become hot during operation.
- 9. MAKE SURE TO ADD OIL!** Use compressor oil or a non-detergent 30 weight oil.
- 10. NEVER LEAVE COMPRESSOR TURNED ON WHEN NO ONE IS AROUND!** A leak could develop causing compressor to run continuously causing overheating and possibly a fire.
- 11. NEVER AIM THE AIR NOZZLE DIRECTLY AT YOURSELF OR OTHERS.** Pressurized air can break or bruise the skin.
- 12. NEVER LOAD YOUR COMPRESSOR PAST THE MAXIMUM PSI RATING OF 115 PSI.**

CAUTION

Always be aware of the duty cycle for your air compressor. Failure to operate the air compressor properly could result in overheating and motor seizure. There could also be risk of fire hazard due to overheating. Be sure to use a compressor capable of handling the air demand of connected tools

WARNING



Operating this compressor can propel objects into the air, causing immediate eye damage. To protect yourself, always wear American National Standards Institute (ANSI) approved safety glasses or goggles when operating this equipment.

INTRODUCTION AND SET UP

Commentary

We are proud to offer the Grizzly Model H3372 3 HP Air Compressor. This model is part of a growing Grizzly family of fine power tools. When used according to the guidelines set forth in this manual, you can expect years of trouble-free, enjoyable operation and proof of Grizzly's commitment to customer satisfaction.

The Model H3372 features a powerful 220V 3 HP motor, two cylinder aluminum pump with cast iron cylinder liners, an incredible 10.9 CFM@ 40 PSI, 9.1 CFM @90 PSI, 11 gallon welded steel tank, and a 115 PSI maximum working pressure. The Model H3372 compressor fills its 11 gallon tank from 0 to 115 PSI in a little over a minute!

We are pleased to provide this manual with the Model H3372. It was written to encourage safety considerations and guide you through general operating procedures and maintenance. This manual represents our effort to produce the best documentation possible.

The specifications, details, and photographs in this manual represent the Model H3372 as supplied when the manual was prepared. However, owing to Grizzly's policy of continuous improvement, changes may be made at any time with no obligation on the part of Grizzly.

If you have any comments regarding this manual, please write to us at the following address:

Grizzly Industrial, Inc.
c/o Technical Documentation
P.O. Box 2069
Bellingham, WA 98227-2069

Most important, we stand behind our tools. If you have any service questions or parts requests, please call or write us at the location listed below.

Grizzly Industrial, Inc.
1203 Lycoming Mall Circle
Muncy, PA 17756
Phone: (570) 546-9663
Fax: (800) 438-5901
E-Mail: techsupport@grizzly.com
Web Site: <http://www.grizzly.com>

! WARNING

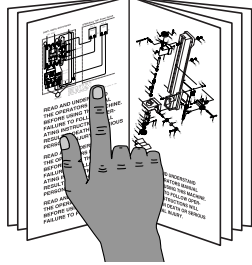

Read the manual before assembly and operation. Become familiar with this tool, its safety instructions, and its operation before beginning any work. Serious personal injury may result if safety or operational information is not understood or followed.

Unpacking

This air compressor is shipped from the manufacturer in a carefully packed carton. If you discover the machine is damaged after you have signed for delivery, and the truck and driver are gone, you will need to file a freight claim with the carrier. Save the containers and all packing materials for possible inspection by the carrier or its agent. Without the packing materials, filing a freight claim can be difficult. *If you need assistance determining whether you need to file a freight claim, or with the procedure to file one, please contact our Customer Service at (570) 546-9663.*



Site Placement

When determining where to set up the compressor in the shop, or when taking the air compressor to a job site, the most important consideration is access to an adequate and properly fused power supply. Refer to *Circuit Requirements* for the needs of your particular compressor.

Also, make sure the compressor is not operating in an environment where there are any explosive, flammable or caustic fumes or gases. A clear and well ventilated area is best for its safe operation.

Place the compressor on a solid and level surface. Make sure that the hoses you attach to your pneumatic device will be unrestricted in movement and not subject to being run over by vehicles or punctured by any sharp objects in the area.

Since air compressors are often used for a sustained period of time, sometimes in restricted areas, it is also best to wear ear protection to avoid long term exposure to the sound of the electric motor and compression pump.

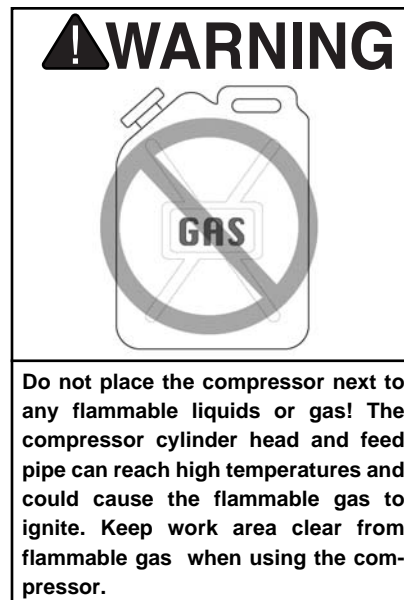

CIRCUIT REQUIREMENTS

220V Operation

Wiring:

The Model H3372 3 HP Air Compressor is wired for 220V operation.

Amperage Draw

The Model H3372 has a 3 HP motor and draws the following amperage.

H3372 Motor.....18 Amps

Circuit Breaker Requirements

Install your air compressor on a dedicated circuit to reduce the possibility of overloading the circuit and tripping the circuit breaker. However, if an unusual load does not exist, and the circuit breaker still trips, have the circuit inspected by a qualified electrician. Never use a larger circuit breaker than stated below, or you will increase the risk of fire.

Circuit Breaker.....20 Amp Double Pole

Extension Cords

If you find it necessary to use an extension cord with your compressor, make sure the cord is rated Standard Service (grade S) or better. The extension cord must also contain a ground wire and plug pin. Always repair or replace extension cords when they become worn or damaged.

CAUTION

Overheating, short circuit and fire damage will result from inadequate wiring. Follow the guidelines in this section.

Grounding

In the event of an electrical short, grounding reduces the risk of electric shock by providing a path of least resistance to disperse electric current. These machines are equipped with power cords having an equipment-grounding conductor. See **Figure 1**. The outlet must be properly installed and grounded in accordance with all local codes and ordinances.

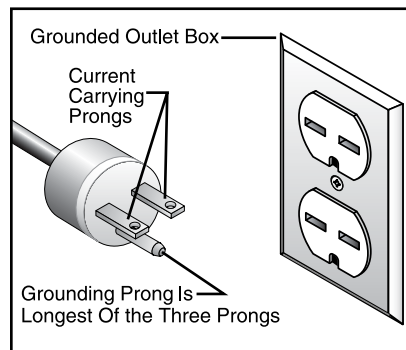

Figure 1. Ground plug configuration.

WARNING



Potential for electrical shock hazard, this equipment must be grounded. Verify that any existing electrical outlet and circuit you use is actually grounded.

PREPARING FOR USE

Before using your Grizzly Air Compressor, follow these steps :

1. Remove all packing materials and any protective plastic bags, zip-tie labels or tags from the compressor cylinder head or oil plug.
2. Be sure the air filter is attached to the cylinder head as shown in **Figure 2**.

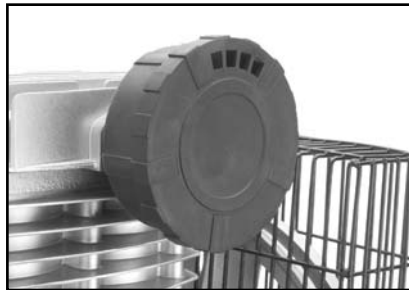

Figure 2. Air filter attached to cylinder head.

3. **ADD OIL TO THE CRANKCASE.** Oil has been supplied with your air compressor. The oil level should be in the center of the sight gauge shown in **Figure 3**.

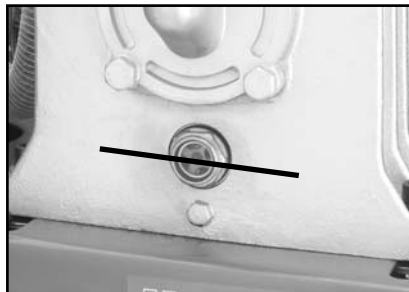

Figure 3. Proper oil level.

4. Make sure the drain valve under the air tank is closed.

NOTICE

The machine should never be run without a full oil reservoir. The oil provides lubrication to the cylinder rings which deliver the compressed air. Severe damage to the internal moving parts can occur if there is not adequate oil flow. Check the oil level frequently, and change the oil on a regular schedule.

Duty Cycle

The Model H3372 3 HP Air Compressor should not be operated on more than a 50% duty cycle. This means an air compressor that pumps air for over 30 minutes in one hour is considered misuse. This could mean that the air compressor is undersized for the required air demand. The maximum compressor pump time per hour is 30 minutes.

CAUTION

Always be aware of the duty cycle for your air compressor. Failure to operate the air compressor properly could result in overheating and motor seizure. There could also be risk of fire hazard due to overheating. Be sure to use a compressor capable of handling the air demand.

STARTING

To start the air compressor:

1. Make sure the compressor switch is in the *OFF* position (knob with red cap above pressure gauges shown in **Figure 4** pressed down) before connecting the power supply.



Figure 4. ON/OFF button.

2. Close the drain valve, shown in **Figure 5**, so the tank can build up pressure.

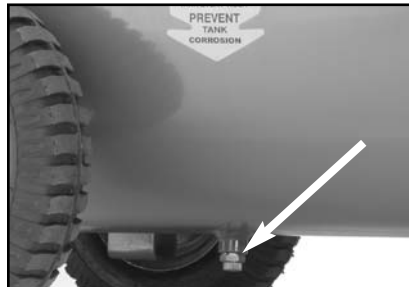

Figure 5. Drain valve location.

3. Double check the oil level to make sure it is at the proper height.
4. Connect the compressor to the power supply.
5. Pull the switch up to the ON position to start compressor.

Check the pressure gauge to see that the tank pressure climbs to approximately 100-115 PSI or around 8 BAR, then automatically turns off.

Note—If the compressor does not automatically kick off, flip the ON/OFF switch to OFF before pressure gets too high. See the Pressure Regulator sub-section.

!WARNING

Operating this equipment has the potential for flying debris to cause eye injury. Always wear safety glasses or goggles when operating equipment. Everyday glasses or reading glasses only have impact resistant lenses, they are not safety glasses. Be certain the safety glasses you wear meet the appropriate standards of the American National Standards Institute (ANSI).

AIR CONTROL

Delivered Pressure

The tank pressure is displayed on the left pressure gauge, and the air to be delivered to the tool is displayed on the right pressure gauge shown in **Figure 6**.



Figure 6. Pressure gauges.

To control the air delivery to your tool:

1. Adjust the air control knob, shown in **Figure 7**, to set the PSI that will be delivered to your tool. Turn the knob clockwise to increase the pressure and counter-clockwise to decrease the pressure.

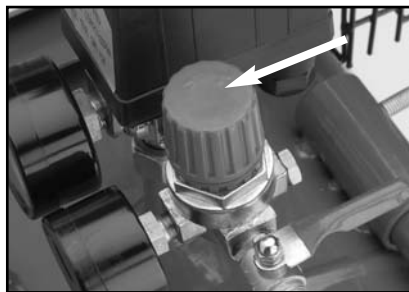

Figure 7. Air control knob.

Note—The air tool that you attach to the air compressor should have a preferred PSI operating level. Set the pressure to be delivered to the tool according to this preferred level. Understand the duty cycle of the air compressor that is described on page 7.

H3372 3 HP Air Compressor

Air Release

There are two ways to release air from the compressor tank other than through your regulator and the use of air tools:

- The drain valve.
- The safety drain valve.

To release air by using the drain valve, simply turn the release nut to allow air to flow out of the tank. The drain valve is shown in **Figure 5**. The drain valve is also used to drain condensation that builds up in the tank.

The safety valve automatically releases pressure if the tank reaches 130 PSI.

To manually release the air in the tank by using the safety drain valve:

1. Locate the safety drain valve on the tank. The drain valve is shown below in **Figure 8**.

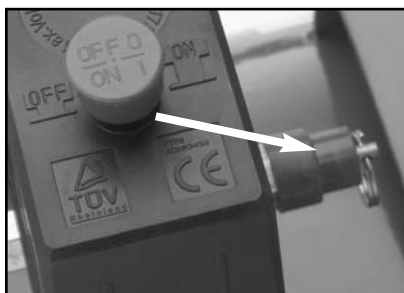

Figure 8. Safety drain valve.

2. Pull the metal ring on top of the safety valve to bleed pressure from the tank. *Note—The ring is preset to release air if the tank exceeds its maximum pressure of 130 PSI. **DO NOT** try to adjust the safety valve!*

-9-

Tank Pressure Regulator

The pressure regulator has been factory set for the highest quality operating performance.

The pressure regulator adjusts the desired PSI range where the air compressor kicks in and out to keep the tank pressurized for the best operating performance.

NOTICE

The Model H3372 3 HP Air Compressors have been factory set to kick off at the proper PSI range. Only attempt to adjust the pressure regulator if your air compressor does not reach or pressurizes beyond the proper PSI level.

To adjust the pressure regulator:

1. **Unplug the air compressor from the power supply.**
2. Make sure the compressor switch is in the *OFF* position.
3. Drain the pressure from the tank.
4. Remove the black *ON/OFF* switch cover by removing the screw which is in the recess on the top of the cover. Pull the black cover up and set it aside.
5. Turn the pressure adjustment bolt (**Figure 9**) a half turn clockwise to increase the tank pressure and a half turn counter-clockwise to decrease the pressure.
6. Connect the compressor to the power supply and start the compressor.
7. If the PSI level still needs adjustment repeat **steps 1 through 6**.
8. Replace the cover when the proper adjustments have been made.

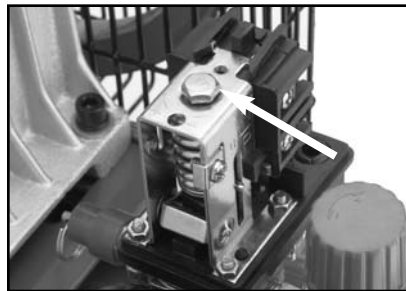

Figure 9. Pressure Regulator.

CONNECTING TOOLS

To connect air tools to your air compressor:

1. Make sure the compressor model you use has a sufficient cubic feet per minute (CFM) output for the air tool you plan to connect. (Most air tools will have an air requirement stated in terms of a specific CFM at a specific pressure.)
2. The compressor should put out a higher CFM than the tool requires.

—If you are connecting multiple tools that will be used simultaneously, then the CFM for each tool should be added together and compared to the compressor output value.
3. Connect the tool, using a good quality air line with an adequate length to reach from the compressor to the point of use.

Note—Quick-connect couplers, shown in **Figure 10**, are a good option for fast and sure connection of tools and air hoses. This accessory and many like it can be found in the Grizzly Catalog.

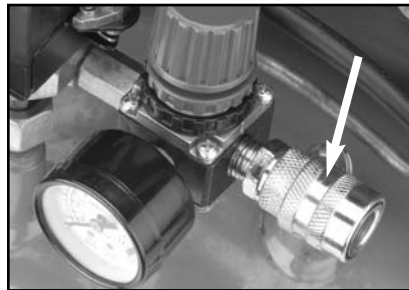
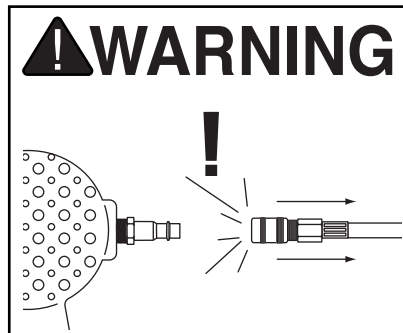

Figure 10. Quick connect couplers.

Make certain the air hose will not be placed in a position where it can become constricted or cut by a sharp object. Note—*Running over a hose with heavy vehicles may not cause an immediate leak, but it will shorten the life of the hose.*

Consideration should also be given to the type of usage. A nailer or staple gun uses air in short bursts and it is easier for the compressor to maintain pressure. A paint sprayer or grinder tends to use a more continuous stream of air as these tools are run for longer time periods. It is always better to oversize a compressor to allow for variation in the type of usage and the number of tools to be powered. Air tools being operated with insufficient air volume will not perform their function satisfactorily.



Always disconnect air hose from tools whenever not in use or while servicing! During maintenance, a tool connected to air may operate accidentally, causing serious personal injury!

! WARNING

The Model H3372 3 HP Air Compressors are specifically designed for air tool operation. **DO NOT MODIFY OR USE THIS MACHINE FOR ANY OTHER PURPOSE.** Modifications or improper use of this tool will void the warranty. If you are confused about any aspect of this machine, **DO NOT** use it until you have answered all your questions. Serious personal injury may occur.

MAINTENANCE

Before Each Use

Regular periodic maintenance on your Air Compressor will ensure its optimum performance. Make a habit of inspecting the following items before each time you use the air compressor.

Check the following items:

1. **Check Oil Level!** Use the sight gauge on the bottom of the crankcase to make sure the oil level is at the proper height.
2. Drain the tanks of any condensation by opening the drain valve on the bottom of the tank. Note—*Depending upon the amount of use and the weather conditions, a certain amount of condensed water may be released. For longevity of the compressor seals and the air tools you connect, it is best to keep the tanks free of water. The tanks are best drained if the drain valve is open when the system is pressurized. Once water has stopped coming out, you can close the drain valve.*

3. Clean off cylinder head cooling fins of any dirt which might hamper air flow.
4. Check for worn or damaged cords and plugs.
5. Check the air pressure in the tires when transporting the air compressor.
6. Check for any other condition that could hamper the safe operation of this machine.

WARNING

Always wear safety glasses and use extreme caution when working around compressed air. The force of the air stream can cause small bits of debris to become airborne and cause potential injury to the eyes or other parts of the body.

Changing V-belt

To change the V-belt drive on your air compressor:

1. Remove the belt guard from the air compressor shown in **Figure 11**. The guard is attached to the compressor frame by the two mounting bolts shown in **Figure 11**.

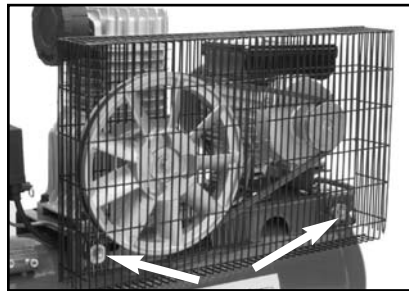

Figure 11. Belt Guard and mounting bolts.

2. Loosen the four nuts (one side shown in **Figure 12**) that secure the motor to the compressor frame so the motor can slide towards crankcase, relieving the tension on the V-belt.

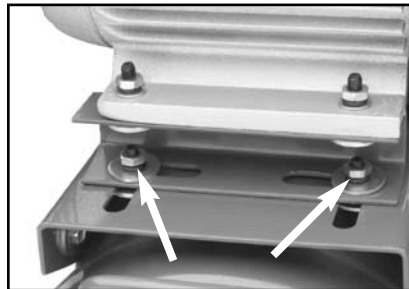

Figure 12. Mounting bolt locations.

3. Remove the V-belt from the motor pulley and fly pulley.
4. Install the new V-belt.
5. Reposition the motor in its original place so the belt is tensioned, and secure the four mounting bolts loosened in **step 2**.
6. A properly tensioned V-belt will have about a $\frac{1}{2}$ inch deflection as shown in **Figure 13**. Replace the belt guard.
7. Replace belt guard.

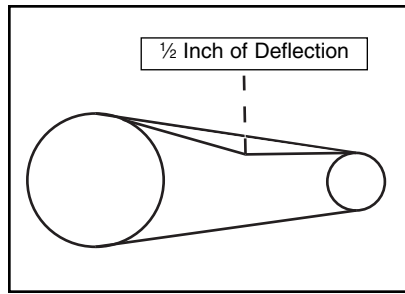

Figure 13. V-belt deflection.

!WARNING

Make sure the V-belt is properly tensioned. If the V-belt is too tight, the motor could overheat and cause machine damage or fire. If the V-belt is too loose, the belt will slip on the pulley and cause belt damage and compressor inefficiency.

After First 50 Hours Of Use

After the first 50 working hours or 30 days, whichever comes first, perform the following maintenance:

- Replace the oil in the motor with compressor oil (use ISO 100 of SAE 30W viscosity, non detergent type).
- Make sure that all the fittings are tight.
- Remove the air filter foam element shown in **Figure 14** and rinse it out with water. Allow it to dry and re-install.

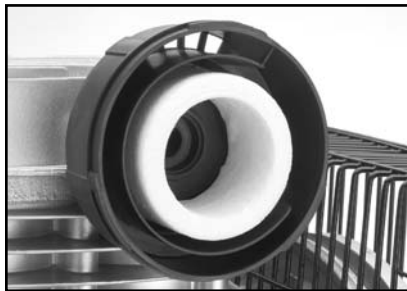

Figure 14. Air filter foam element

- Blow out any accumulated dirt between the cylinder cooling fins.

Weekly

If the compressor is used on a daily basis, perform the following checks each week:

- Rinse the air filter foam element in water.
- Check for loose bolts or fittings.

WARNING

The Model H3372 3 HP Air Compressors are specifically designed for air tool operation. DO NOT MODIFY AND/OR USE THIS MACHINE FOR ANY OTHER PURPOSE. Modifications or improper use of this tool will void the warranty. If you are confused about any aspect of this machine, DO NOT use it until you have answered all your questions. Serious personal injury may occur.

WARNING

Like all power tools, there is danger associated with operating this equipment. Accidents are frequently caused by lack of familiarity or failure to pay attention. Use this tool with respect and caution to lessen the possibility of operator injury. If normal safety precautions are overlooked or ignored, serious personal injury may occur.

Every 300 Hours

After every 300 hours or 3 months of regular operation, perform the following maintenance items:

- Change the compressor motor oil. Use compressor oil or a non-detergent 30 weight oil.
- Rinse the air filter foam element in water.
- Check for air leaks and correct as needed.
- Clean the cylinder head fins for proper cooling.
- Check for loose bolts or fittings.

WARNING

Like all power tools, there is danger associated with operating this equipment. Accidents are frequently caused by lack of familiarity or failure to pay attention. Use this machine with respect and caution to lessen the possibility of operator injury. If normal safety precautions are overlooked or ignored, serious personal injury may occur.

Storage

When storing your air compressor follow these guidelines:

1. Set the ON/OFF button to OFF.
2. Turn the regulator counter-clockwise to set the delivery pressure to zero.
3. Disconnect air tools or accessories.
4. Pull the safety drain valve ring to bleed excess pressure from tank. The pressure gauge for the tank should read 15-20 PSI.
5. Drain water from the tank by opening the drain valve on the bottom of the tank.
6. Close the drain valve when all the water has been released.
7. Store the air compressor in its normal operating position in a cool protected area.

NOTICE

Water will condense in the air compressor tank. Water left in the tank can cause the tank to weaken and corrode, increasing the risk of tank rupture.

TROUBLESHOOTING

PROBLEM	CAUSE	ACTION
Pump motor will not start.	<ol style="list-style-type: none"> 1. Low voltage. 2. Open circuit in motor, switch or cord. 3. Tank already pressurized. 4. Thermal overload switch. 	<ol style="list-style-type: none"> 1. Check power line for proper voltage. 2. Inspect all lead connections on motor, switch and cord for loose or open connections. 3. Motor will not start if tank pressure is too high. 4. Thermal overload switch has tripped, wait for motor to cool, then reset switch by pressing red button.
Pump motor starts; but fuses blow or circuit breakers trip.	<ol style="list-style-type: none"> 1. Short circuit in line cord or plug. 2. Short circuit in motor or loose connections. 3. Incorrect fuses or circuit breakers in power line. 	<ol style="list-style-type: none"> 1. Inspect cord or plug for damaged insulation and shorted wires. 2. Inspect all connections on motor for loose or shorted terminals or worn insulation. 3. Install correct fuses or circuit breakers.
Low pressure at the tool.	<ol style="list-style-type: none"> 1. Air leaks in flexible hoses. 2. Pressure gauge bad. 3. Pressure regulator bad. 4. Hose is too long. 	<ol style="list-style-type: none"> 1. Check air hoses and all connections for leaks. 2. Check pressure in line with known good gauge. 3. Adjust pressure regulator, if no improvement inspect regulator for leaks or replacement. 4. Install a shorter hose.
Low pressure at the tanks.	<ol style="list-style-type: none"> 1. Air leaks in tanks or delivery pipes. 2. Drain valve open. 3. Safety valve releasing below 125 PSI. 4. Air filter clogged. 5. Gaskets leaking. 6. Worn rings. 	<ol style="list-style-type: none"> 1. Check air tanks, pipes and all connections for leaks. 2. Close drain valve. 3. Replace safety valve. 4. Inspect and clean air filter. 5. Check gaskets on cylinder head assembly, repair or replace as needed. 6. Inspect and replace pump piston rings.
Compressor knocking.	<ol style="list-style-type: none"> 1. Improper oil level. 2. Air filter clogged. 3. Piston assembly loose. 	<ol style="list-style-type: none"> 1. Check oil level and add oil. 2. Inspect and clean air filter. 3. Inspect and repair piston and connecting rod.

PROBLEM	CAUSE	ACTION
Motor runs hot.	<ol style="list-style-type: none"> 1. Cooling fins dirty. 2. Air filter clogged. 3. Compressor is exceeding its duty-cycle. 	<ol style="list-style-type: none"> 1. Clean cylinder fins and motor area. 2. Inspect and clean air filter. 3. Do not allow the compressor to run over its recommended duty cycle.
Pressure relief valve stays open and motor won't stop running.	<ol style="list-style-type: none"> 1. Faulty pressure switch, unit is trying to overpressure the tank. 2. Faulty pressure relief valve. 	<ol style="list-style-type: none"> 1. Turn compressor off, unplug from power supply, drain tank. DO NOT USE until switch is repaired or replaced. 2. Relief valve is relieving pressure too early, test pressure relief and repair or replace.
Air leaks from pressure switch.	<ol style="list-style-type: none"> 1. Faulty check valves. 2. faulty pressure switch. 	<ol style="list-style-type: none"> 1. Clean dirt or debris from rubber membrane of check valve after removing top nut. 2. Repair or replace pressure switch.
Air is dirty or has excessive moisture.	<ol style="list-style-type: none"> 1. Tank is not drained. 2. Delivery pipes are dirty. 	<ol style="list-style-type: none"> 1. Open drain cocks on both tanks and make certain all condensation water is drained out. 2. Remove delivery pipes, clean out and replace.

Model H3372 3 HP Air Compressor

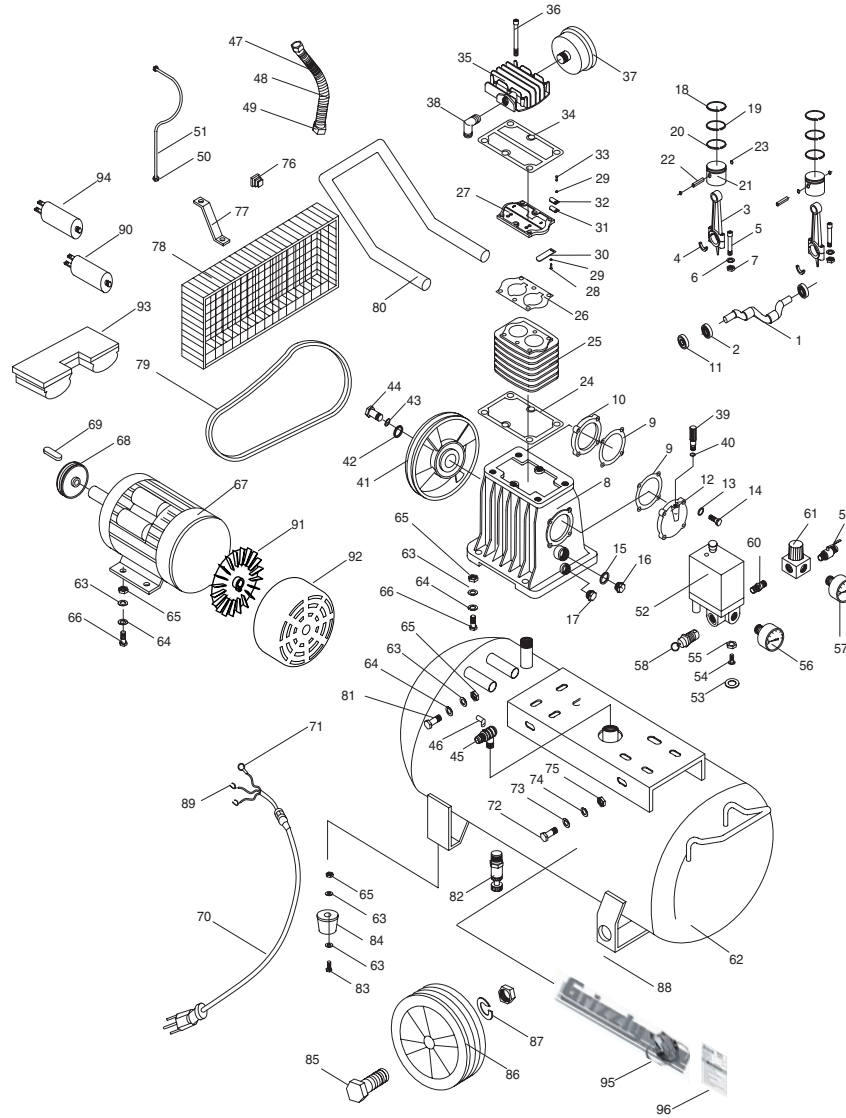

REF	PART #	DESCRIPTION
1	PH3372001	CRANK
2	P6202	BEARING 6202
3	PH3372003	CONNECTING ROD
4	PH3372004	ROD BEARING
5	PSB29M	CAP SCREW M6-1 X 40
6	PLW03M	LOCK WASHER 6MM
7	PN01M	HEX NUT M6-1.0
8	PH3372008	CRANKCASE
9	PH3372009	GASKET
10	PH3372010	CRANK CASE FRONT COVER
11	PH3372011	OIL SEAL B25 X 47 X 7
12	PH3372012	REAR COVER
13	PW01M	FLAT WASHER 8MM
14	PB09M	HEX BOLT M8-1.25 X 20.
15	PH3372015	GASKET
16	PH3370024	OIL SIGHT GLASS G½
17	PH3372017	HEX BOLT ½ MPT
18	PH3372018	COMPRESSION RING
19	PH3372019	COMPRESSION RING
20	PH3372020	OIL RING
21	PH3372021	PISTON
22	PH3370017	PISTON PIN 12 X 37.5MM
23	PR49M	INT RETAINING RING 12MM
24	PH3372024	CYLINDER TO CRANKCASE GASKET
25	PH3372025	CYLINDER
26	PH3372026	GASKET
27	PH3372027	VALVE PLANK
28	PB108M	HEX BOLT M3-.5 X 10
29	PLW09M	LOCK WASHER 3MM
30	PH3372030	INLET VALVE PATCH
31	PH3372031	OUTLET VALVE PATCH
32	PH3372032	RISE LIMITER
33	PB109M	HEX BOLT M3-.5 X 12
34	PH3372034	CYLINDER HEAD GASKET
35	PH3372035	CYLINDER HEAD
36	PSB98M	CAP SCREW M8-1.25 X 160
37	PH3372037	AIR INTAKE FILTER
38	PH3372038	90° ELBOW ½ MPT X ¾-16 UNF
39	PH3372039	OIL BREATHER

REF	PART #	DESCRIPTION
40	PH3372040	O-RING
41	PH3372041	PULLEY
42	PH3372042	GASKET 8MM
43	PLW04M	LOCK WASHER 8MM
44	PB20M	HEX BOLT M8-1.25 X 35
45	PH3372045	CHECK VALVE
46	PH3372046	ELBOW 1/8 MPT X 1/16 MPT
47	PH3372047	DISCHARGE PIPE 12MM
48	PH3372048	COOLER
49	PH3372049	COMPRESSION NUT 3/8 FPT
50	PH3370062	FLARE CONNECTOR ID10MM
51	PH3372051	EXHAUST PIPE 6MM
52	PH3372052	PRESSURE SWITCH
53	PH3372053	GASKET
54	PH3370057	STEM ADAPTER 1/4 MPT
55	PH3370058	FLARE CONNECTOR 3/8 FPT
56	PH3372056	PRESSURE GAUGE
57	PH3372057	PRESSURE GAUGE
58	PH3372058	SAFETY VALVE
59	PH3372059	BALL VALVE 1/4 NPT
60	PH3372060	NIPPLE 1/4 X 1/8 NPT
61	PH3372061	REGULATOR
62	PH3372062	TANK 11 GALLON
63	PW01M	FLAT WASHER 8MM
64	PLW04M	LOCK WASHER 8MM
65	PN03M	HEX NUT M8-1.25
66	PB26M	HEX BOLT M8-1.25 X 30
67	PH3372067	MOTOR
68	PH3372068	MOTOR PULLEY
69	PK41M	KEY 8 X 8 X 40
70	PH3372070	POWER CORD
71	PH3372071	RING TERMINAL #10
72	PB08M	HEX BOLT M6-1 X 20
73	PW03M	FLAT WASHER 6MM
74	PLW03M	LOCK WASHER 6MM
75	PN01M	HEX NUT M6-1.0
76	PH3372076	BUTTON
77	PH3372077	SUPPORTING PLATE
78	PH3372078	BELT GUARD

REF	PART #	DESCRIPTION
79	PH3372079	BELT A1143
80	PH3372080	HANDLE
81	PB21M	HEX BOLT M8-1.25 X 42
82	PH3370070	DRAIN VALVE 14MM
83	PB09M	HEX BOLT M8-1.25 X 20
84	PH3372084	CUSHION FOOT
85	PB80M	HEX BOLT M16-2.0 X 55
86	PH3372086	PNEUMATIC TIRE 8.5"
87	PW08M	FLAT WASHER 16MM
88	PN13M	HEX NUT M16-2.0
89	PH3372089	FORK TERMINAL #10
90	PH3372090	CAPACITOR 250 MFD 250VAC
91	PH3372091	MOTOR FAN
92	PH3372092	FAN COVER
93	PH3372093	CAPACITOR COVER
94	PH3372094	CAPACITOR 40 MFD 400VAC
95	PH3372095	GRIZZLY LOGO LABEL
96	PH3372096	MACHINE ID LABEL

WARRANTY AND RETURNS

Grizzly Industrial, Inc. warrants every product it sells for a period of **1 year** to the original purchaser from the date of purchase. This warranty does not apply to defects due directly or indirectly to misuse, abuse, negligence, accidents, repairs or alterations or lack of maintenance. This is Grizzly's sole written warranty and any and all warranties that may be implied by law, including any merchantability or fitness, for any particular purpose, are hereby limited to the duration of this written warranty. We do not warrant or represent that the merchandise complies with the provisions of any law or acts unless the manufacturer so warrants. In no event shall Grizzly's liability under this warranty exceed the purchase price paid for the product and any legal actions brought against Grizzly shall be tried in the State of Washington, County of Whatcom.

We shall in no event be liable for death, injuries to persons or property or for incidental, contingent, special, or consequential damages arising from the use of our products.

To take advantage of this warranty, contact us by mail or phone and give us all the details. We will then issue you a "Return Authorization Number," which must be clearly posted on the outside as well as the inside of the carton. We will not accept any item back without this number. Proof of purchase must accompany the merchandise.

The manufacturers reserve the right to change specifications at any time because they constantly strive to achieve better quality equipment. We make every effort to ensure that our products meet high quality and durability standards and we hope you never need to use this warranty.

Please feel free to write or call us if you have any questions about the machine or the manual.

Grizzly Industrial, Inc.
1203 Lycoming Mall Circle
Muncy, PA 17756
Phone: (570) 546-9663
Fax: (800) 438-5901

E-Mail:
techsupport@grizzly.com

Web Site: <http://www.grizzly.com>

Thank you again for your business and continued support. We hope to serve you again soon!

WARRANTY CARD

Name _____
 Street _____
 City _____ State _____ Zip _____
 Phone Number _____ E-Mail _____ FAX _____
Model # _____ **Serial#** _____ **Order #** _____

The following information is given on a voluntary basis. It will be used for marketing purposes to help us develop better products and services. Of course, all information is strictly confidential.

1. How did you learn about us?
 Advertisement Friend
 Catalog Card Deck
 World Wide Web
 Other _____
2. What is your annual household income?
 \$20,000-\$29,999 \$60,000-\$69,999
 \$30,000-\$39,999 \$70,000-\$79,999
 \$40,000-\$49,999 \$80,000-\$89,999
 \$50,000-\$59,999 \$90,000 +
3. What is your age group?
 20-29 50-59
 30-39 60-69
 40-49 70 +
4. How long have you been a woodworker?
 0 - 2 Years 8 - 20 Years
 2 - 8 Years 20+ Years
5. How would you rank your woodworking skills?
 Simple Advanced
 Intermediate Master Craftsman
6. What stationary woodworking tools do you own?
 Check all that apply.
 Air Compressor Panel Saw
 Band Saw Planer
 Drill Press Power Feeder
 Drum Sander Radial Arm Saw
 Dust Collector Shaper
 Spindle Sander Jointer
 Table Saw Lathe
 Mortiser Wide Belt Sander
 Horiz.Boring Machine
 Vacuum Veneer Press
 Other _____
7. How many of your woodworking machines are Grizzly? _____
8. Which benchtop tools do you own? Check all that apply.
 1"x42" Belt Sander 6" - 8" Grinder
 5" - 8" Drill Press Mini Lathe
 8" Table Saw 8" - 10" Bandsaw
 Scroll Saw Disc/Belt Sander
 Spindle/Belt Sander Mini Jointer
 10"-12" Thickness Planer
 Other _____
9. How many of the machines checked above are Grizzly? _____
10. Which portable/hand held power tools do you own?
 Check all that apply.
 Belt Sander Orbital Sander
 Biscuit Joiner Palm Sander
 Circular Saw Portable Planer
 Detail Sander Saber Saw
 Drill/Driver Reciprocating Saw
 Miter Saw Router
 Other _____
11. What machines/supplies would you like Grizzly Industrial to carry?

12. What new accessories would you like Grizzly Industrial to carry?

13. What other companies do you purchase your tools and supplies from?

14. Do you think your purchase represents good value?
 Yes No
15. Would you recommend Grizzly to a friend?
 Yes No
16. Would you allow us to use your name as a reference for Grizzly customers in your area? **Note: We never use names more than three times.**
 Yes No
17. Comments: _____

Send a Grizzly Catalog to a friend:

Name _____
Street _____
City _____ State _____ Zip _____

FOLD ALONG DOTTED LINE

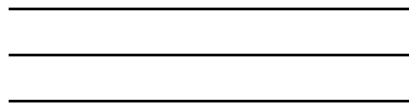

Place
Stamp
Here



GRIZZLY INDUSTRIAL, INC.
P.O. BOX 2069
BELLINGHAM, WA 98227-2069



TAPE ALONG EDGES--PLEASE DO NOT NAIL

Free Manuals Download Website

<http://myh66.com>

<http://usermanuals.us>

<http://www.somanuals.com>

<http://www.4manuals.cc>

<http://www.manual-lib.com>

<http://www.404manual.com>

<http://www.luxmanual.com>

<http://aubethermostatmanual.com>

Golf course search by state

<http://golfingnear.com>

Email search by domain

<http://emailbydomain.com>

Auto manuals search

<http://auto.somanuals.com>

TV manuals search

<http://tv.somanuals.com>