

Grizzly *Industrial, Inc.*®

MODEL G0738 HANGING 3-SPEED AIR FILTER OWNER'S MANUAL (For models manufactured since 1/12)



COPYRIGHT © FEBRUARY, 2012 BY GRIZZLY INDUSTRIAL, INC.
**WARNING: NO PORTION OF THIS MANUAL MAY BE REPRODUCED IN ANY SHAPE
OR FORM WITHOUT THE WRITTEN APPROVAL OF GRIZZLY INDUSTRIAL, INC.**
#TS14735 PRINTED IN CHINA



WARNING!

This manual provides critical safety instructions on the proper setup, operation, maintenance, and service of this machine/tool. Save this document, refer to it often, and use it to instruct other operators.

Failure to read, understand and follow the instructions in this manual may result in fire or serious personal injury—including amputation, electrocution, or death.

The owner of this machine/tool is solely responsible for its safe use. This responsibility includes but is not limited to proper installation in a safe environment, personnel training and usage authorization, proper inspection and maintenance, manual availability and comprehension, application of safety devices, cutting/sanding/grinding tool integrity, and the usage of personal protective equipment.

The manufacturer will not be held liable for injury or property damage from negligence, improper training, machine modifications or misuse.



WARNING!

Some dust created by power sanding, sawing, grinding, drilling, and other construction activities contains chemicals known to the State of California to cause cancer, birth defects or other reproductive harm. Some examples of these chemicals are:

- **Lead from lead-based paints.**
- **Crystalline silica from bricks, cement and other masonry products.**
- **Arsenic and chromium from chemically-treated lumber.**

Your risk from these exposures varies, depending on how often you do this type of work. To reduce your exposure to these chemicals: Work in a well ventilated area, and work with approved safety equipment, such as those dust masks that are specially designed to filter out microscopic particles.

Table of Contents

INTRODUCTION	2	SECTION 5: ACCESSORIES	17
Manual Accuracy	2	SECTION 6: MAINTENANCE	18
Contact Info.....	2	Cleaning Filters	18
Identification.....	3	SECTION 7: SERVICE	19
Machine Data Sheet	4	Troubleshooting	19
SECTION 1: SAFETY	5	Motor & Electrical	19
Safety Instructions for Machinery	5	Air Filter Operations	19
Additional Safety for Air Filters	7	Replacing Fuse	20
SECTION 2: POWER SUPPLY	8	Remote Control Battery Replacement.....	20
Availability.....	8	SECTION 8: WIRING	21
Full-Load Current Rating	8	Wiring Safety Instructions	21
Circuit Requirements	8	Electrical Wiring Diagram	22
Grounding & Plug Requirements.....	9	SECTION 9: PARTS	23
Extension Cords	9	Cabinet & Remote Control.....	23
SECTION 3: SETUP	10	Control Panel	24
Needed for Setup.....	10	Motor & Impeller	25
Unpacking	10	Machine Labels.....	26
Inventory	10	WARRANTY & RETURNS	29
Power Connection.....	11		
Connecting Power	11		
Disconnecting Power.....	11		
Test Run	11		
Site Planning.....	12		
Mounting to Ceiling.....	14		
SECTION 4: OPERATIONS	16		
General	16		
Turning ON & OFF	16		
Changing Air Flow Speeds.....	16		
Setting Timer	16		
Machine Storage.....	16		
Filtering Performance.....	16		

INTRODUCTION

Manual Accuracy

We are proud to offer this manual with your new machine! We've made every effort to be exact with the instructions, specifications, drawings, and photographs of the machine we used when writing this manual. However, sometimes we still make an occasional mistake.

Also, owing to our policy of continuous improvement, **your machine may not exactly match the manual**. If you find this to be the case, and the difference between the manual and machine leaves you in doubt, check our website for the latest manual update or call technical support for help.

Before calling, find the manufacture date of your machine by looking at the date stamped into the machine ID label (see below). This will help us determine if the manual version you received matches the manufacture date of your machine.

Grizzly Industrial		MODEL GXXXX MACHINE NAME
SPECIFICATIONS	WARNING!	
Motor: Specification: Specification: Specification: Weight: Date Serial Number <small>Manufactured for Grizzly in Taiwan</small>	Manufacture Date of Your Machine 4. make sure the motor has stopped and disconnect power before adjustments, maintenance, or service. 5. DO NOT expose to rain or dampness. 6. DO NOT modify this machine in any way. 7. DO NOT remove safety guards. 8. Never leave machine running unattended. 9. DO NOT operate under the influence of drugs or alcohol. 10. Maintain machine carefully to prevent accidents.	

For your convenience, we post all available manuals and manual updates for free on our website at www.grizzly.com. Any updates to your model of machine will be reflected in these documents as soon as they are complete.

Contact Info

We stand behind our machines. If you have any questions or need help, use the information below to contact us. Before contacting, please get the serial number and manufacture date of your machine. This will help us help you faster.

Grizzly Technical Support
1203 Lycoming Mall Circle
Muncy, PA 17756
Phone: (570) 546-9663
Email: techsupport@grizzly.com

We want your feedback on this manual. What did you like about it? Where could it be improved? Please take a few minutes to give us feedback.

Grizzly Documentation Manager
P.O. Box 2069
Bellingham, WA 98227-2069
Email: manuals@grizzly.com



Identification

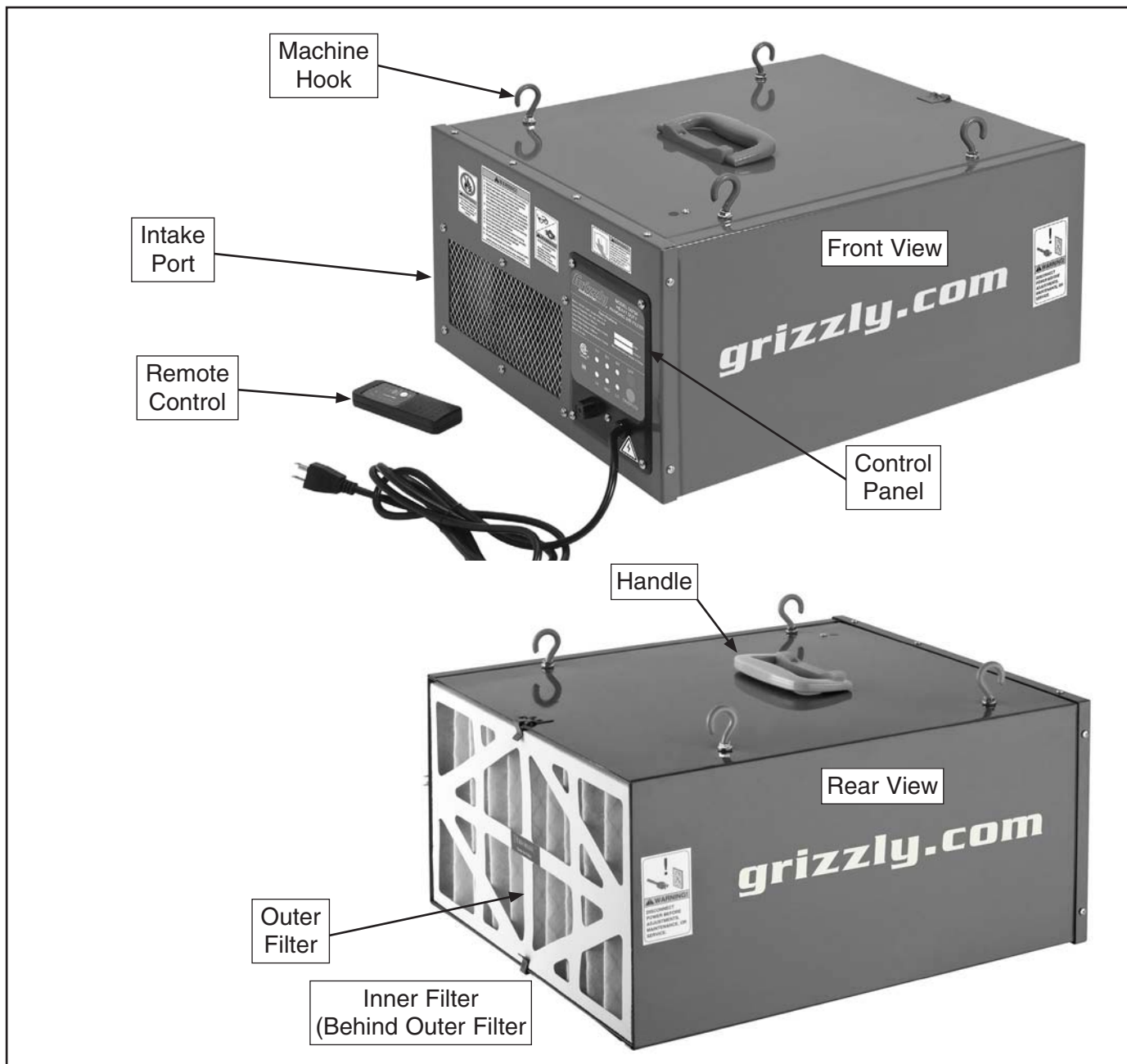

	<p>⚠ WARNING To reduce the risk of serious injury, read and understand this entire document before using the machine!</p>
--	--





MACHINE DATA SHEET

Customer Service #: (570) 546-9663 · To Order Call: (800) 523-4777 · Fax #: (800) 438-5901

MODEL G0738 HANGING AIR FILTER 300, 350, 400 CFM

Product Dimensions:

Weight..... 31 lbs.
Width (side-to-side) x Depth (front-to-back) x Height..... 20 in. x 17 in. x 10 in.
Footprint (Length x Width)..... 20 in. x 17 in.

Shipping Dimensions:

Type..... Cardboard
Content..... Machine
Weight..... 34 lbs.
Length x Width x Height..... 24 x 20 x 13 in.

Motors:

Main

Horsepower..... 1/8 HP
Voltage..... 120V
Phase..... Single-Phase
Amps..... 1A
Speed..... 1200, 1400, 1750 RPM
Cycle..... 60 Hz
Number of Speeds..... 3

Main Specifications:

Operation

Airflow Capacity..... 260, 362, 409 CFM

Impeller Information

Impeller Type..... Squirrel Cage
Impeller Size..... 5-1/2 - 5-1/5 in.

Construction

Frame..... Steel Q325
Impeller..... Steel
Paint..... Powder-Coated
Blower Housing..... Steel

Other Specifications:

Warranty 1 Year
Sound Rating 62, 67, 69dB



SECTION 1: SAFETY

WARNING

For Your Own Safety, Read Instruction Manual Before Operating this Machine

The purpose of safety symbols is to attract your attention to possible hazardous conditions. This manual uses a series of symbols and signal words intended to convey the level of importance of the safety messages. The progression of symbols is described below. Remember that safety messages by themselves do not eliminate danger and are not a substitute for proper accident prevention measures.



Indicates an imminently hazardous situation which, if not avoided, **WILL** result in death or serious injury.



Indicates a potentially hazardous situation which, if not avoided, **COULD** result in death or serious injury.



Indicates a potentially hazardous situation which, if not avoided, **MAY** result in minor or moderate injury. It may also be used to alert against unsafe practices.

NOTICE

This symbol is used to alert the user to useful information about proper operation of the machine.

WARNING

Safety Instructions for Machinery

OWNER'S MANUAL. Read and understand this owner's manual **BEFORE** using machine. Untrained users can be seriously hurt.

EYE PROTECTION. Always wear ANSI-approved safety glasses or a face shield when operating or observing machinery to reduce the risk of eye injury or blindness from flying particles. Everyday eyeglasses are not approved safety glasses.

HAZARDOUS DUST. Dust created while using machinery may cause cancer, birth defects, or long-term respiratory damage. Be aware of dust hazards associated with each workpiece material, and always wear a NIOSH-approved respirator to reduce your risk.

WEARING PROPER APPAREL. Do not wear clothing, apparel, or jewelry that can become entangled in moving parts. Always tie back or cover long hair. Wear non-slip footwear to avoid accidental slips which could cause a loss of workpiece control.

HEARING PROTECTION. Always wear hearing protection when operating or observing loud machinery. Extended exposure to this noise without hearing protection can cause permanent hearing loss.

MENTAL ALERTNESS. Be mentally alert when running machinery. Never operate under the influence of drugs or alcohol, when tired, or when distracted.



WARNING

DISCONNECTING POWER SUPPLY. Always disconnect machine from power supply before servicing, adjusting, or changing cutting tools (bits, blades, cutters, etc.). Make sure switch is in OFF position before reconnecting to avoid an unexpected or unintentional start.

APPROVED OPERATION. Untrained operators can be seriously hurt by machinery. Only allow trained or properly supervised people to use machine. When machine is not being used, disconnect power, remove switch keys, or lock-out machine to prevent unauthorized use—especially around children. Make workshop kid proof!

DANGEROUS ENVIRONMENTS. Do not use machinery in wet or rainy locations, cluttered areas, around flammables, or in dark areas. Keep work area clean, dry, and well-lighted.

ONLY USE AS INTENDED. Only use machine for its intended purpose. Never modify machine for a purpose not intended by the manufacturer!

USE RECOMMENDED ACCESSORIES. Consult this owner's manual or the manufacturer for recommended accessories. Using improper accessories will increase the risk of serious injury.

CHILDREN & BYSTANDERS. Keep children and bystanders a safe distance away from work area. Stop using machine if children or bystanders become a distraction.

REMOVE ADJUSTING TOOLS. Never leave adjustment tools, chuck keys, wrenches, etc. in or on machine—especially near moving parts. Verify removal before starting!

SECURING WORKPIECE. When required, use clamps or vises to secure workpiece. A secured workpiece protects hands and frees both of them to operate the machine.

FEED DIRECTION. Unless otherwise noted, feed work against the rotation of blades or cutters. Feeding in the same direction of rotation may pull your hand into the cut.

FORCING MACHINERY. Do not force machine. It will do the job safer and better at the rate for which it was designed.

GUARDS & COVERS. Guards and covers can protect you from accidental contact with moving parts or flying debris. Make sure they are properly installed, undamaged, and working correctly before using machine.

NEVER STAND ON MACHINE. Serious injury or accidental contact with cutting tool may occur if machine is tipped. Machine may be damaged.

STABLE MACHINE. Unexpected movement during operations greatly increases risk of injury or loss of control. Before starting, verify machines are stable and mobile base (if used) is locked.

AWKWARD POSITIONS. Keep proper footing and balance at all times when operating machine. Do not overreach! Avoid awkward hand positions that make workpiece control difficult or increase the risk of accidental injury.

UNATTENDED OPERATION. Never leave machine running while unattended. Turn machine **OFF** and ensure all moving parts completely stop before walking away.

MAINTAIN WITH CARE. Follow all maintenance instructions and lubrication schedules to keep machine in good working condition. An improperly maintained machine increases risk of injury.

CHECK DAMAGED PARTS. Regularly inspect machine for damaged parts, loose bolts, mis-adjusted or mis-aligned parts, binding, or any other conditions that may affect safe operation. Always repair or replace damaged or mis-adjusted parts before operating machine.

MAINTAIN POWER CORDS. When disconnecting cord-connected machines from power, grab and pull the plug—NOT the cord. Pulling the cord may damage the wires inside. Do not handle cord/plug with wet hands. Avoid cord damage by keeping it away from heated surfaces, high traffic areas, harsh chemicals, and wet/damp locations.

EXPERIENCING DIFFICULTIES. If at any time you are experiencing difficulties performing the intended operation, stop using the machine! Contact our Technical Support Department at (570) 546-9663.



Additional Safety for Air Filters

WARNING

INTENDED USE. This air filter is designed to capture dust from ambient air in a woodworking shop for a short time after cutting or sanding operations. **DO NOT** use this air filter to collect particles of silica, metal, lead paint, asbestos, or hazardous bacterium. **DO NOT** allow this filter to collect liquids, combustible fumes, burning or smoking material, or toxic fumes.

HAZARDOUS DUST. Dust exposure may cause cancer, birth defects, or long-term respiratory damage. Be aware of the dust hazards associated with each workpiece material, and always wear a NIOSH-approved respirator to reduce your risk.

LEAD PAINT DUST AND ASBESTOS FIBERS. **DO NOT** try to collect lead paint or asbestos fibers with this machine. Due to the high hazard to human health, these materials must be collected with special equipment.

DUST ALLERGIES. Dust from certain woods may cause an allergic reaction in people and animals. Make sure you know what type of wood dust you will be exposed to in case there is a possibility of an allergic reaction.

WEAR RESPIRATOR. Fine dust that is too small to be caught in the filter will be blown into the ambient air during operation. Wearing a NIOSH approved respirator during this time will reduce your risk of permanent respiratory damage.

EMPTYING DUST. When removing dust from the filters, turn **OFF** the switch, disconnect power, and wear a respirator and safety glasses. Empty dust away from ignition sources and into an approved container.

DISCONNECTING POWER SUPPLY. Turn the switch **OFF**, disconnect the air filter from the power supply, and allow the impeller to come to a complete stop before leaving the machine unattended or doing any service, cleaning, maintenance, or adjustments.

REGULAR CLEANING. For best performance, regularly check/clean the filters to avoid the buildup of fine dust. Make sure to regularly clean the surrounding area where the machine is operated—excessive dust buildup on overhead lights, heaters, electrical panels, or other heat sources will increase the risk of fire.

SUSPENDED DUST PARTICLES AND IGNITION SOURCES. **DO NOT** operate the air filter in areas where explosion risks are high. Areas of high risk include, but are not limited to, areas near pilot lights, open flames, or other ignition sources.

FIRE SUPPRESSION. Only operate the air filter in locations that contain a fire suppression system or have a fire extinguisher nearby.

IMPELLER HAZARDS. **DO NOT** place your hands or tools inside the air filter housing during operation for any reason. The powerful suction could easily cause accidental contact with the impeller which could cause serious personal injury or damage to the machine.

OPERATING LOCATION. **DO NOT** operate the air filter in rainy or wet locations—exposure to water may create a shock hazard or decrease the life of the machine.

WARNING

Like all machinery there is potential danger when operating this air filter. Accidents are frequently caused by lack of familiarity or failure to pay attention. Use this machine with respect and caution to reduce the risk of operator injury. If normal safety precautions are overlooked or ignored, serious personal injury may occur.



SECTION 2: POWER SUPPLY

Availability

Before installing the machine, consider the availability and proximity of the required power supply circuit. If an existing circuit does not meet the requirements for this machine, a new circuit must be installed. To minimize the risk of electrocution, fire, or equipment damage, installation work and electrical wiring must be done by a qualified electrician in accordance with all applicable codes and standards.

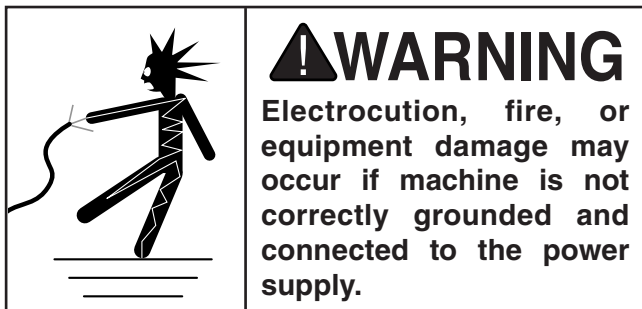

Full-Load Current Rating

The full-load current rating is the amperage a machine draws at 100% of the rated output power. On machines with multiple motors, this is the amperage drawn by the largest motor or sum of all motors and electrical devices that might operate at one time during normal operations.

Full-Load Current Rating at 120V 1 Amp

The full-load current is not the maximum amount of amps that the machine will draw. If the machine is overloaded, it will draw additional amps beyond the full-load rating.

If the machine is overloaded for a sufficient length of time, damage, overheating, or fire may result—especially if connected to an undersized circuit. To reduce the risk of these hazards, avoid overloading the machine during operation and make sure it is connected to a power supply circuit that meets the requirements in the following section.

! WARNING

Serious injury could occur if you connect the machine to power before completing the setup process. DO NOT connect to power until instructed later in this manual.

Circuit Requirements

This machine is prewired to operate on a 120V power supply circuit that has a verified ground and meets the following requirements:

Nominal Voltage 120V
Cycle 60 Hz
Phase Single-Phase
Power Supply Circuit 15 Amps

A power supply circuit includes all electrical equipment between the breaker box or fuse panel in the building and the machine. The power supply circuit used for this machine must be sized to safely handle the full-load current drawn from the machine for an extended period of time. (If this machine is connected to a circuit protected by fuses, use a time delay fuse marked D.)

! CAUTION

For your own safety and protection of property, consult a qualified electrician if you are unsure about wiring practices or electrical codes in your area.

Note: *The circuit requirements listed in this manual apply to a dedicated circuit—where only one machine will be running at a time. If this machine will be connected to a shared circuit where multiple machines will be running at the same time, consult a qualified electrician to ensure that the circuit is properly sized for safe operation.*



Grounding & Plug Requirements

This machine **MUST** be grounded. In the event of certain malfunctions or breakdowns, grounding reduces the risk of electric shock by providing a path of least resistance for electric current.

This machine is equipped with a power cord that has an equipment-grounding wire and a grounding plug (similar to the figure below). The plug must only be inserted into a matching receptacle (outlet) that is properly installed and grounded in accordance with all local codes and ordinances.

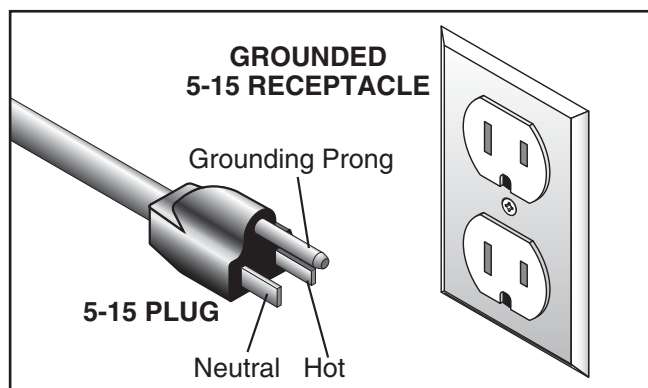
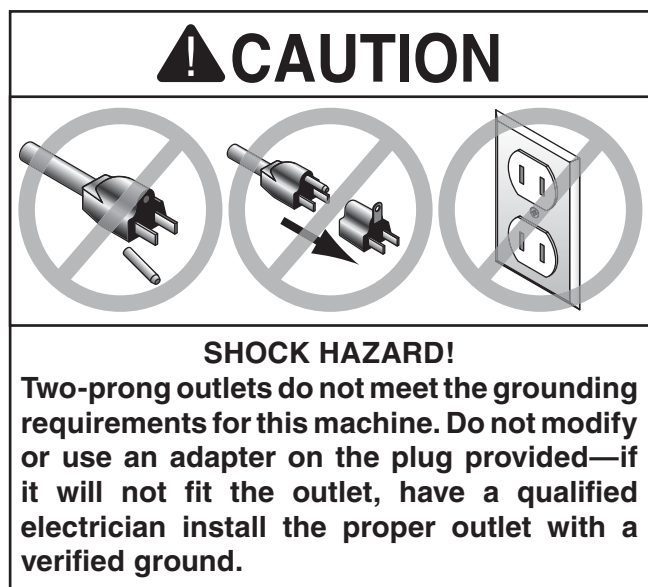

Figure 1. Typical 5-15 plug and receptacle.



Improper connection of the equipment-grounding wire can result in a risk of electric shock. The wire with green insulation (with or without yellow stripes) is the equipment-grounding wire. If repair or replacement of the power cord or plug is necessary, do not connect the equipment-grounding wire to a live (current carrying) terminal.

Check with a qualified electrician or service personnel if you do not understand these grounding requirements, or if you are in doubt about whether the tool is properly grounded. If you ever notice that a cord or plug is damaged or worn, disconnect it from power, and immediately replace it with a new one.

Extension Cords

We do not recommend using an extension cord with this machine. If you must use an extension cord, only use it if absolutely necessary and only on a temporary basis.

Extension cords cause voltage drop, which may damage electrical components and shorten motor life. Voltage drop increases as the extension cord size gets longer and the gauge size gets smaller (higher gauge numbers indicate smaller sizes).

Any extension cord used with this machine must contain a ground wire, match the required plug and receptacle, and meet the following requirements:

Minimum Gauge Size16 AWG
Maximum Length (Shorter is Better).....50 ft.



SECTION 3: SETUP

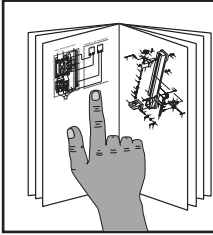

!WARNING

To reduce the risk of serious injury, read and understand this entire document before using the machine!

Needed for Setup

The following are needed to complete the setup process, but are not included with your machine.

Description	Qty
• Additional People	1
• Safety Glasses	1 Per Person
• Phillips Screwdriver #2	1
• Wrench 10mm	1
• Drill	1
• Drill Bit 3/32"	1
• Ladders	2

Unpacking

Your machine was carefully packaged for safe transportation. Remove the packaging materials from around your machine and inspect it. If you discover any damage, *please call us immediately at (570) 546-9663 for advice.*

Save the containers and all packing materials for possible inspection by the carrier or its agent. *Otherwise, filing a freight claim can be difficult.*

When you are completely satisfied with the condition of your shipment, inventory the contents.

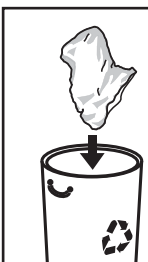

!WARNING

SUFFOCATION HAZARD!

Keep children and pets away from plastic bags or packing materials shipped with this machine. Discard immediately.

Inventory

The following is a description of the main components shipped with your machine. Lay the components out to inventory them.

If any non-proprietary parts are missing (e.g. a nut or a washer), we will gladly replace them; or for the sake of expediency, replacements can be obtained at your local hardware store.

Shipping Inventory: (Figure 2)	Qty
A. Air Filter Unit.....	1
B. Hanging Chains.....	4
C. Ceiling Hooks	4
D. Machine Hooks.....	4
E. Remote Control w/Batteries	1

Installed & Not Shown	Qty
• Outer Filter.....	1
• Inner Filter	1

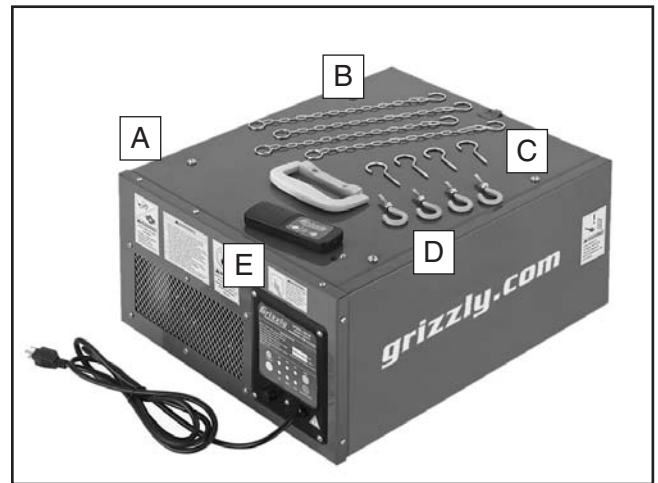

Figure 2. Shipping inventory.

NOTICE

If you cannot find an item on this list, carefully check the machine and the packaging materials. Some of these items may be pre-installed for shipping or become misplaced during unpacking.



Power Connection

To avoid unexpected startups or property damage, use the following steps whenever connecting or disconnecting the machine.

Connecting Power

Insert the power cord plug into a matching power supply receptacle. The machine is now connected to the power source.

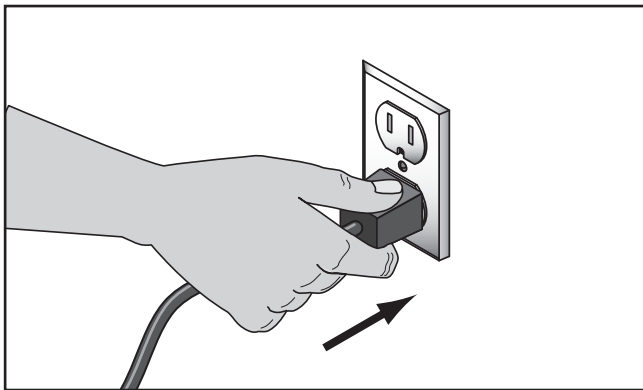

Figure 3. Connecting power.

Disconnecting Power

Grasp the molded plug and pull it completely out of the receptacle. Do not pull by the cord as this may damage the wires inside.

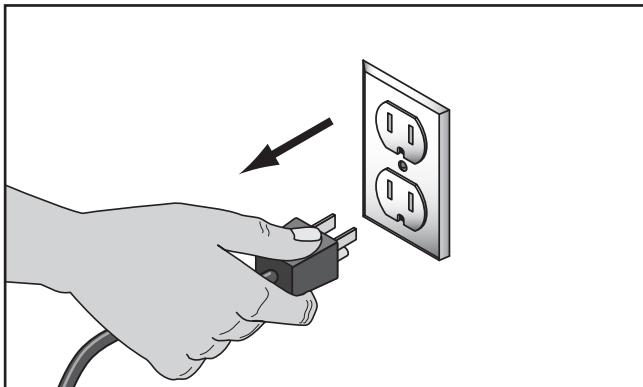

Figure 4. Disconnecting power.

Test Run

Once the assembly is complete, test run your machine to make sure it runs properly.

If, during the test run, you cannot easily locate the source of an unusual noise or vibration, stop using the machine immediately, then review the **Troubleshooting on Page 19**.

If you still cannot remedy a problem, contact our Tech Support at (570) 546-9663 for assistance.

To test run the machine:

1. Make sure you have read the safety instructions at the beginning of the manual.
2. Place the air filter on a workbench or similar stable surface that can support the load.
3. Connect the air filter to power.
4. Press the ON SPEED button on the control panel of the air filter (see **Figure 5**) to turn the unit **ON**. The machine should run smoothly with little or no vibration.



Figure 5. Air filter control panel.

—Strange or unusual noises should be investigated and corrected before operating the machine further. Always disconnect the machine from power when investigating or correcting potential problems.



5. Push the ON SPEED button repeatedly to cycle through the three air flow speed options. The lights on the control panel should display the selected speed.
6. Press the OFF button to turn the machine **OFF**.
7. Point the remote control directly at the control panel and press the remote control ON SPEED button to turn the machine **ON**.
8. Push the remote control ON SPEED button repeatedly to cycle through the air flow options. The lights on the control panel should display the selected speed.
9. Push the remote control TIME button repeatedly to cycle through the three time options. The lights on the control panel should display the amount of time the air filter will run before automatically turning **OFF**.
10. Press the remote control OFF button to turn the air filter **OFF**.

Site Planning

Site planning is an important step to maximize the effectiveness of the hanging air filter. Air circulation must be thought out and all obstructions to the air path considered.

Think of air circulation in terms of the circular motion of the air before and after the air filter. The air exiting the filter is exhausted at a higher velocity than that entering it. Consequently, exhaust being vented inside a building can have an effect on the pattern of air circulation.

Air circulation patterns will vary depending upon which air flow speed is used and according to your specific shop setup. **Figure 6** shows an example of good air circulation.

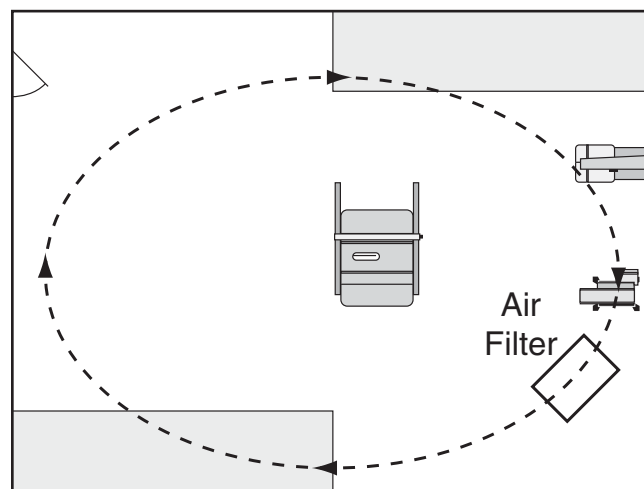

Figure 6. Good air circulation. The air filter placement promotes circular air motion.



Figure 7 shows an example of poor air circulation, where the air filter is placed too close to obstructions. In this situation, the velocity of the air is lost and circulation is diminished.

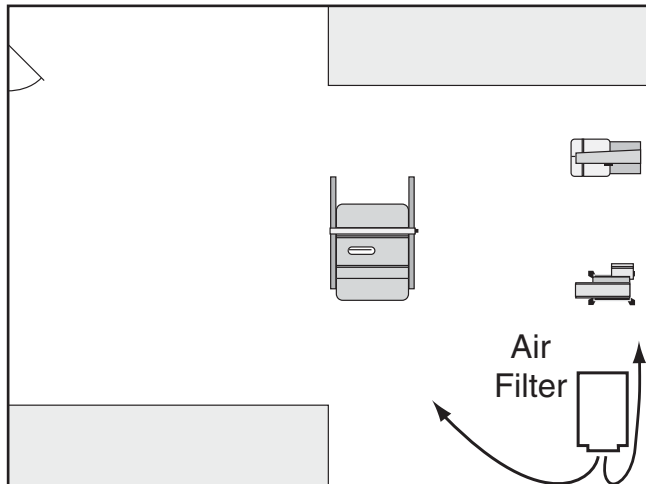

Figure 7. Poor air circulation. Placed too close to the wall, the air circulation short cycles, leaving much of the room unfiltered.

Below is a list of things to keep in mind when selecting a spot for the air filter:

- Study your shop layout and try to determine the best location for the hanging air filter. Air flow that is obstructed will cause a short cycle effect, producing unsatisfactory results. There must be a clearance of at least 3 ft. from any obstructions in front and back of the unit.
- Try to place the air filter in front of high dust producers like sanders or near areas where sanding will take place.
- Do not place the hanging air filter where garage doors may pass closely or where it may impede transport or movement of any other object.
- Try to place the unit where it is easy to access for turning it on, cleaning and maintenance.

It is very important that the hanging air filter be supported properly. Please follow these guidelines when planning where to mount the unit:

- Where the mounting brackets attach is the top of the unit. The hanging air filter can only be secured by the machine hooks on its top.
- Make sure that an electrical outlet with a properly grounded receptacle is available at the location you choose.
- The hanging air filter must be supported by wood joists. These joists should be capable of supporting at least 100 lbs each. **DO NOT** attach the hanging air filter to only sheet rock, press board or paneling. These materials cannot support the filter, and it may fall.
- Avoid hitting your head on the hanging air filter. Make sure there is enough clearance between the unit and the ground, especially important in a basement. If possible, position the air filter in an area that has little foot traffic but still offers easy access to the switch and filters.



Mounting to Ceiling

The Model G0738 can be operated from a stable surface that can support its weight or hung from the ceiling.

The advantage of operating the air filter mounted to the ceiling is the air circulation pattern is not blocked by equipment and obstacles closer to the floor.

When choosing a location to mount the air filter to the ceiling, keep in mind the clearance necessary underneath the machine for foot traffic or other operations. The mounting chains can be used at full length, which will bring the bottom of the air filter to approximately 25½" from the ceiling, or the chains can be doubled-up, which will bring the unit approximately 19½" below the ceiling.

Important: *The ceiling hooks must only be screwed into solid wood. Otherwise, they may pull out under load and cause the air filter to fall.*

!WARNING

ONLY mount the air filter unit to joists or table that can hold at least 100 lbs. **DO NOT** mount the unit only to sheet rock, pressboard, paneling, or honeycomb wall panels with expansion-type fasteners. The fasteners can tear out and the air filter can fall. Ignoring this caution can result in injury or property damage.



To mount the air filter to the ceiling:

1. Replace the four Phillips head screws shown in **Figure 8** with the four provided machine hooks (see **Figure 9**).

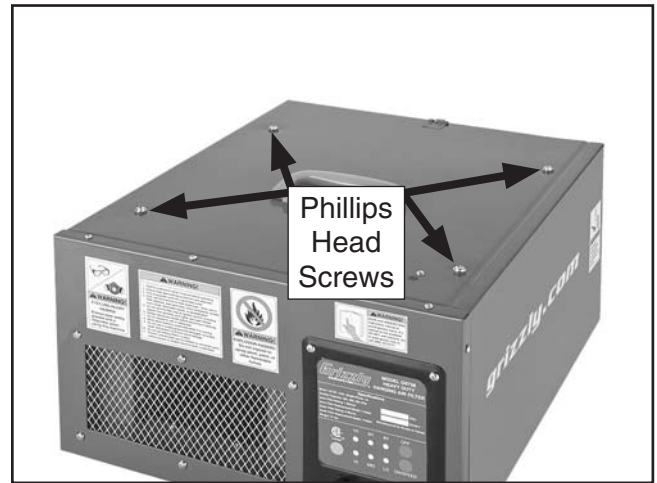

Figure 8. Remove these Phillips head screws.



Figure 9. Machine hook installed.

!WARNING

ALWAYS have at least ½" of the machine hook threaded into the air filter housing to ensure that the hooks will securely hold the air filter.



Note: Some positions for the ceiling hooks may be slightly uneven from each another. To make up for this, minor adjustments can be made to the length of the hanging assembly by adjusting the amount that the machine hook is threaded into the air filter housing (see **Figure 10**). If you do this, tighten the hex nut to secure the hook.

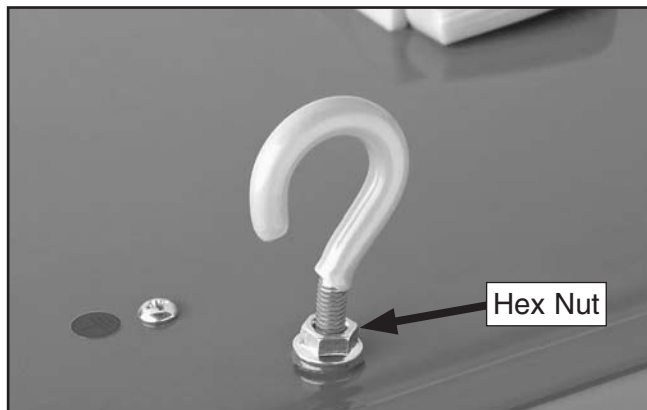

Figure 10. Machine hook partially threaded to adjust the hanging length.

2. Drill a $\frac{3}{32}$ " pilot hole into the center of the joists at the mounting locations, then fully thread the ceiling hooks into the joists (see **Figure 11**).

Important: If the joists are covered with sheet rock or paneling, use a stud finder or other device to locate the center of the joists.

!WARNING

THIS AIR FILTER IS TO BE USED FOR WOOD DUST ONLY. Do not use it to filter toxic fumes, paint spray, or dissipate smoke or fumes, which could damage the filters.

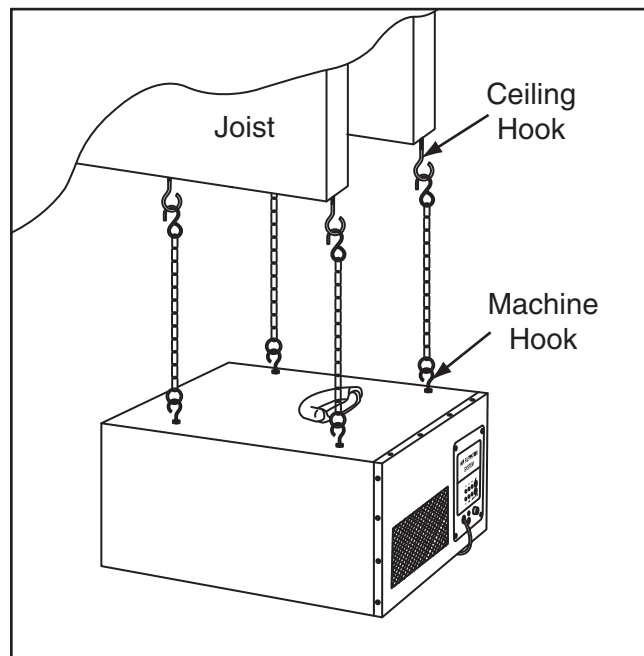

Figure 11. Air filter mounted to the joists.

3. Attach the provided chains to the ceiling hooks.
4. With the help of another person to hold the air filter up, attach the other end of the chains to the machine hooks.



SECTION 4: OPERATIONS

General

Turning ON & OFF

When the air filter is connected to power, press the ON SPEED button on the air filter control panel or the remote control to turn the unit **ON**.

Note: *The remote control communicates with the air filter using infrared (IR) and must be pointed directly at the air filter control panel to work properly.*

Changing Air Flow Speeds

The air filter can be set to operate in three air flow speeds—260 (LO), 362 (MED), and 409 CFM (HI). CFM is the acronym for Cubic Feet per Minute of air flow that is generated through the air filter.

To cycle through the available speeds, press the ON SPEED button on the control panel or remote control repeatedly. This will illuminate the corresponding lights on the control panel.

Setting Timer

The air filter can be set for a timed performance of 1, 2, or 4 hours. At the end of this time, the air filter will automatically turn **OFF**.

To cycle through the available time settings, press the TIME button on the remote control repeatedly. This will illuminate the corresponding lights on the control panel.

Machine Storage

When the air filter is not in use, unplug the power cord from the power source. Secure the power cord away from potential hazards, such as high traffic areas, sharp objects, heat sources, harsh chemicals or fumes, damp areas, etc.

Filtering Performance

When used in conjunction with an efficient dust collection system, the Model G0738 removes most fine wood particles up to 1 micron from the air. This air filter is capable of recirculating the air in a room measuring 20' x 20' x 8' approximately 7.7 times an hour. We recommend that the volume of air in your room be recirculated 6–9 times an hour for the best filtering effect.

Therefore, rooms with a larger volume may require two or more air filters to achieve proper filtering.

To calculate the recirculating rate for your shop space:

1. Calculate the volume of air in your shop by multiplying the length x width x height of the room (see the example below). Then, divide the volume by the speed (CFM) you have chosen to operate the air filter. This will give you how many minutes it takes to recirculate the air in the room.

Example: *The room measures 20' x 20' x 8' and you are operating the air filter at 409 CFM (HI).*

$$\frac{20' \times 20' \times 8'}{409 \text{ CFM}} = \frac{3200 \text{ ft}^3}{409 \text{ CFM}} = 7.8 \text{ Minutes}$$

2. Calculate how many times per hour the room volume is recirculated through the air filter by dividing 60 minutes by the circulating time from **Step 1**. This will give you how many times an hour the air in the room is recirculated through the air filter.

$$\frac{60 \text{ Min.}}{7.8 \text{ Min.}} = 7.7 \text{ Times per Hour}$$



SECTION 5: ACCESSORIES

⚠️ WARNING

Some aftermarket accessories can be installed on this machine that could cause it to function improperly, increasing the risk of serious personal injury. To minimize this risk, only install accessories recommended for this machine by Grizzly.

NOTICE

Refer to the newest copy of the Grizzly Catalog for other accessories available for this machine.

Call 1-800-523-4777 To Order

T10503—Inner Filter for Model G0738

T10504—Outer Filter for Model G0738

We recommend that you keep a set of filters on hand to ensure uninterrupted service of your air filter.

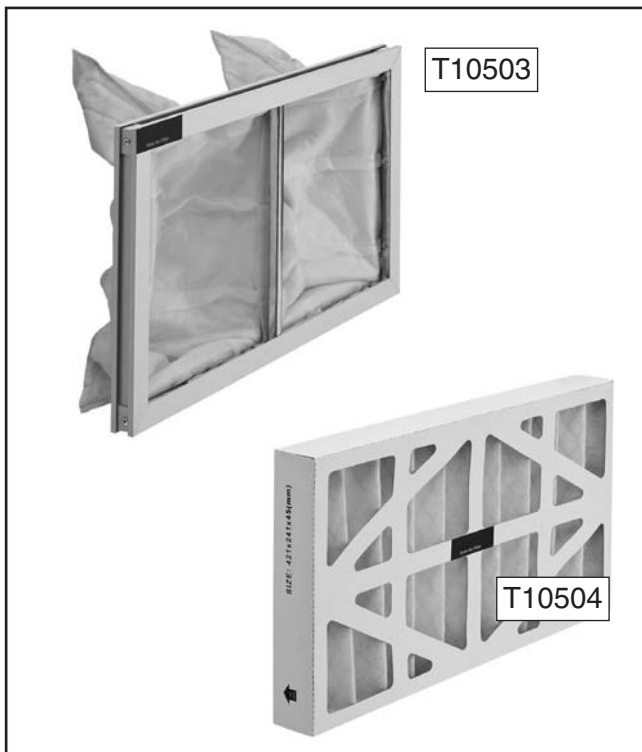

Figure 12. Model T10503 inner filter and Model T10504 outer filter for Model G0738 air filter.

G9955—Bench Top Dual-Fan Dust Filter

Two separately switched fan motors can be used to draw a maximum 400 CFM of your dusty shop air through the 5 micron pleated filter. Perfect for sanding and power carving, the clear plastic hood helps to direct flow from the work area directly into the filter.



Figure 13. Model G9955 Bench Top Dust Filter.

G0573—Two-Speed Floor Air Filter

Roll this large air filter anywhere around the shop that it is needed, then roll it out of the way when not in use. Features a 12" air outlet, two-speed motor and easy open door for filter cleaning. Air movement is 1000 and 2000 CFM. Overall size is 30½"L x 25¾"W x 29⅝"H.



Figure 14. Model G0573 Floor Air Filter.



SECTION 6: MAINTENANCE

Cleaning Filters

The amount of air filter operation has a direct bearing on when you must clean or replace the filters.

To maintain efficient operation, check the filters approximately every 40 hours of use in light or moderately dusty environments. In very dusty environments, check the filters every eight hours of use. Always wear a respirator when checking the filters.

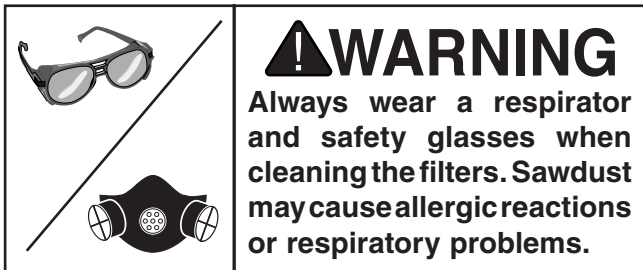
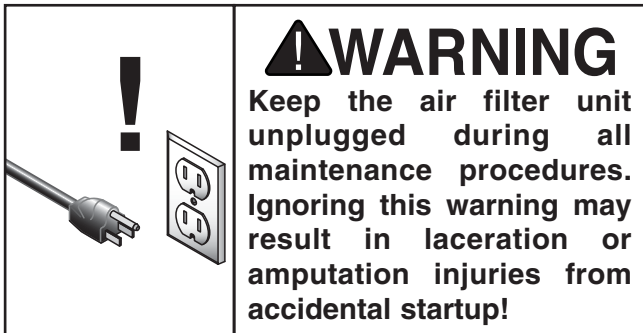

To change and service the filters:

1. DISCONNECT MACHINE FROM POWER!
2. Un-latch the filter retaining clips from the top and bottom of the unit, as shown in **Figure 15**, and remove the outer filter. Place the filter in a trash bag and shake it gently to remove the bulk of the dust.

If you choose to use compressed air to further clean the filter, do so outdoors and in an appropriate environment where people are not in the immediate vicinity.

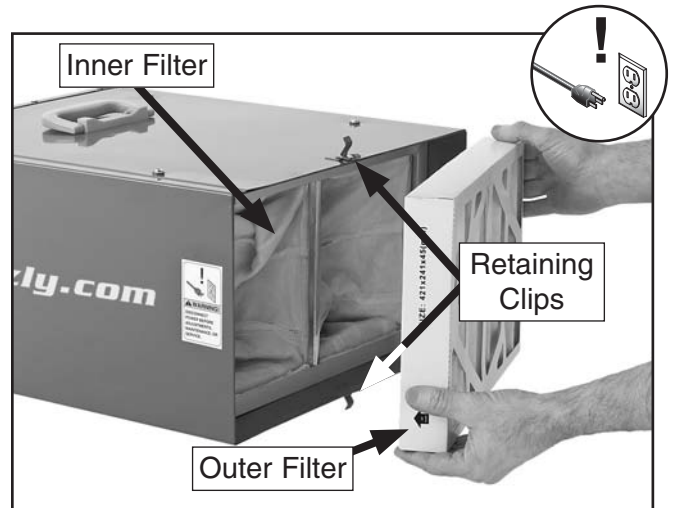

Figure 15. Filters exposed for cleaning.



3. Remove the inner filter, place it inside a trash bag and gently shake the dust from the inside of the filter.

Optional: Wash the inner filter with water to remove the remaining dust, then let it air dry completely.
4. Re-install the inner filter, then re-install the outer filter with the wire mesh facing to the inside.
5. Re-latch the retaining clips to secure the filters.

Note: During regular use the filters can be cleaned several times before replacement becomes necessary. To determine whether the filters need to be replaced, hold them up to the sunlight and visually inspect them. If you cannot see through the filters due to caked dust and grim, replace them before putting air filter back into operation.



SECTION 7: SERVICE

Review the troubleshooting and procedures in this section if a problem develops with your machine. If you need replacement parts or additional help with a procedure, call our Technical Support at (570) 546-9663.

Note: Please gather the serial number and manufacture date of your machine before calling.

Troubleshooting

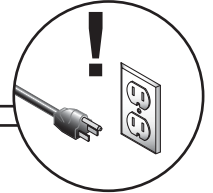

Motor & Electrical

Symptom	Possible Cause	Possible Solution
Machine does not start or a breaker trips.	<ol style="list-style-type: none"> 1. Power supply switched OFF or is at fault. 2. Remote control not working or batteries are dead. 3. Infrared transmission is blocked or remote too far away. 4. Wall circuit breaker tripped. 5. Control panel fuse blown. 6. Wiring is open/has high resistance. 7. Infrared receiver at fault. 8. Control panel ON SPEED button at fault. 9. Motor at fault. 	<ol style="list-style-type: none"> 1. Ensure power supply is ON/has correct voltage. 2. Replace batteries; point remote control directly at control panel. 3. Make sure the infrared receiver on the control panel is not blocked; try using the remote closer to the filter. 4. Ensure circuit size is correct/replace weak breaker. 5. Check filters/resolve reason for blown fuse; replace with a fast-acting 2 amp, 250 volt fuse. 6. Check/fix broken, disconnected, or corroded wires. 7. Inspect/replace if faulty. 8. Replace faulty ON SPEED button. 9. Test/repair/replace.
Machine stalls or is underpowered.	<ol style="list-style-type: none"> 1. Run capacitor at fault. 2. Motor overheated. 3. Motor at fault. 	<ol style="list-style-type: none"> 1. Test/repair/replace. 2. Clean motor, let cool, and reduce workload. 3. Test/repair/replace.
Machine has vibration or noisy operation.	<ol style="list-style-type: none"> 1. Motor or component loose. 2. Motor fan rubbing on fan cover. 3. Motor bearings at fault. 	<ol style="list-style-type: none"> 1. Inspect/replace damaged bolts/nuts, and re-tighten with thread locking fluid. 2. Fix/replace fan cover; replace loose/damaged fan. 3. Test by rotating shaft; rotational grinding/loose shaft requires bearing replacement.

Air Filter Operations

Symptom	Possible Cause	Possible Solution
Loud, repetitious noise, or excessive vibration coming from air filter.	<ol style="list-style-type: none"> 1. Air filter is not mounted properly and wobbles. 2. Impeller fan is damaged, loose, or unbalanced. 3. The motor mounting is loose. 4. Motor fan housing is dented, causing the motor fan blade to hit the housing while spinning. 	<ol style="list-style-type: none"> 1. Stabilize the air filter. 2. Unplug air filter, and inspect the impeller for dents, bends, loose fins. Replace impeller if any damage is found. 3. Make sure all fasteners on the air filter are tight. 4. Replace motor fan housing.
Air filter does not adequately collect dust; poor performance.	<ol style="list-style-type: none"> 1. The filters are dirty. 	<ol style="list-style-type: none"> 1. Clean the filters.



Replacing Fuse

The fuse on the control panel will blow in the case of a thermal overload.

Replace the fuse only with a fast-acting, 2 amp, 250V fuse (F2A250V). The correct fuse is available from Grizzly as Part Number P0738055.

Tool Needed	Qty
Phillips Screwdriver #2	1

To replace the machine fuse:

1. DISCONNECT MACHINE FROM POWER!
2. Unthread the fuse holder cap from the control panel (see **Figure 16**) and remove it. The fuse will come out with it.



Figure 16. Fuse holder cap on the control panel.

3. Replace the fuse and fully thread the cap in to secure it.

Remote Control Battery Replacement

The remote control uses two AA batteries. To replace them, slide the battery compartment cover down and off the remote (see **Figure 17**). Insert the batteries in the proper direction and replace the cover.

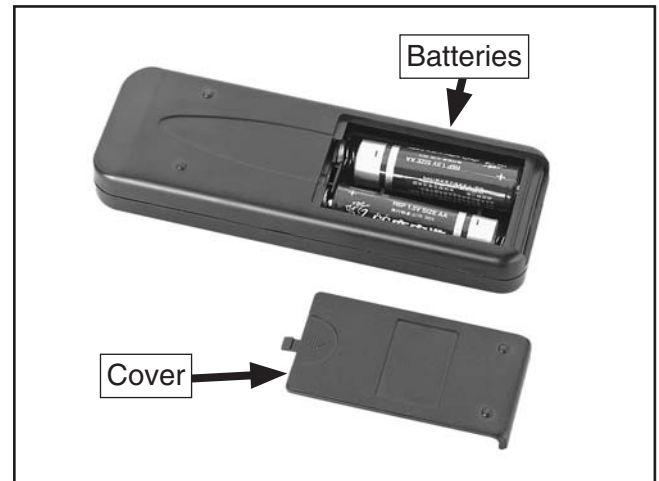

Figure 17. Remote control battery compartment cover removed.



SECTION 8: WIRING

These pages are current at the time of printing. However, in the spirit of improvement, we may make changes to the electrical systems of future machines. Compare the manufacture date of your machine to the one stated in this manual, and study this section carefully.

If there are differences between your machine and what is shown in this section, call Technical Support at (570) 546-9663 for assistance BEFORE making any changes to the wiring on your machine. An updated wiring diagram may be available. **Note:** *Please gather the serial number and manufacture date of your machine before calling. This information can be found on the main machine label.*

WARNING

Wiring Safety Instructions

SHOCK HAZARD. Working on wiring that is connected to a power source is extremely dangerous. Touching electrified parts will result in personal injury including but not limited to severe burns, electrocution, or death. Disconnect the power from the machine before servicing electrical components!

MODIFICATIONS. Modifying the wiring beyond what is shown in the diagram may lead to unpredictable results, including serious injury or fire. This includes the installation of unapproved after-market parts.

WIRE CONNECTIONS. All connections must be tight to prevent wires from loosening during machine operation. Double-check all wires disconnected or connected during any wiring task to ensure tight connections.

CIRCUIT REQUIREMENTS. You MUST follow the requirements at the beginning of this manual when connecting your machine to a power source.

WIRE/COMPONENT DAMAGE. Damaged wires or components increase the risk of serious personal injury, fire, or machine damage. If you notice that any wires or components are damaged while performing a wiring task, replace those wires or components.

MOTOR WIRING. The motor wiring shown in these diagrams is current at the time of printing but may not match your machine. If you find this to be the case, use the wiring diagram inside the motor junction box.















CAPACITORS/INVERTERS. Some capacitors and power inverters store an electrical charge for up to 10 minutes after being disconnected from the power source. To reduce the risk of being shocked, wait at least this long before working on capacitors.

EXPERIENCING DIFFICULTIES. If you are experiencing difficulties understanding the information included in this section, contact our Technical Support at (570) 546-9663.

NOTICE

The photos and diagrams included in this section are best viewed in color. You can view these pages in color at www.grizzly.com.

COLOR KEY

BLACK		BLUE		YELLOW		LIGHT BLUE	
WHITE		BROWN		YELLOW GREEN		BLUE WHITE	
GREEN		GRAY		PURPLE		TURQUOISE	
RED		ORANGE		PINK			



Electrical Wiring Diagram

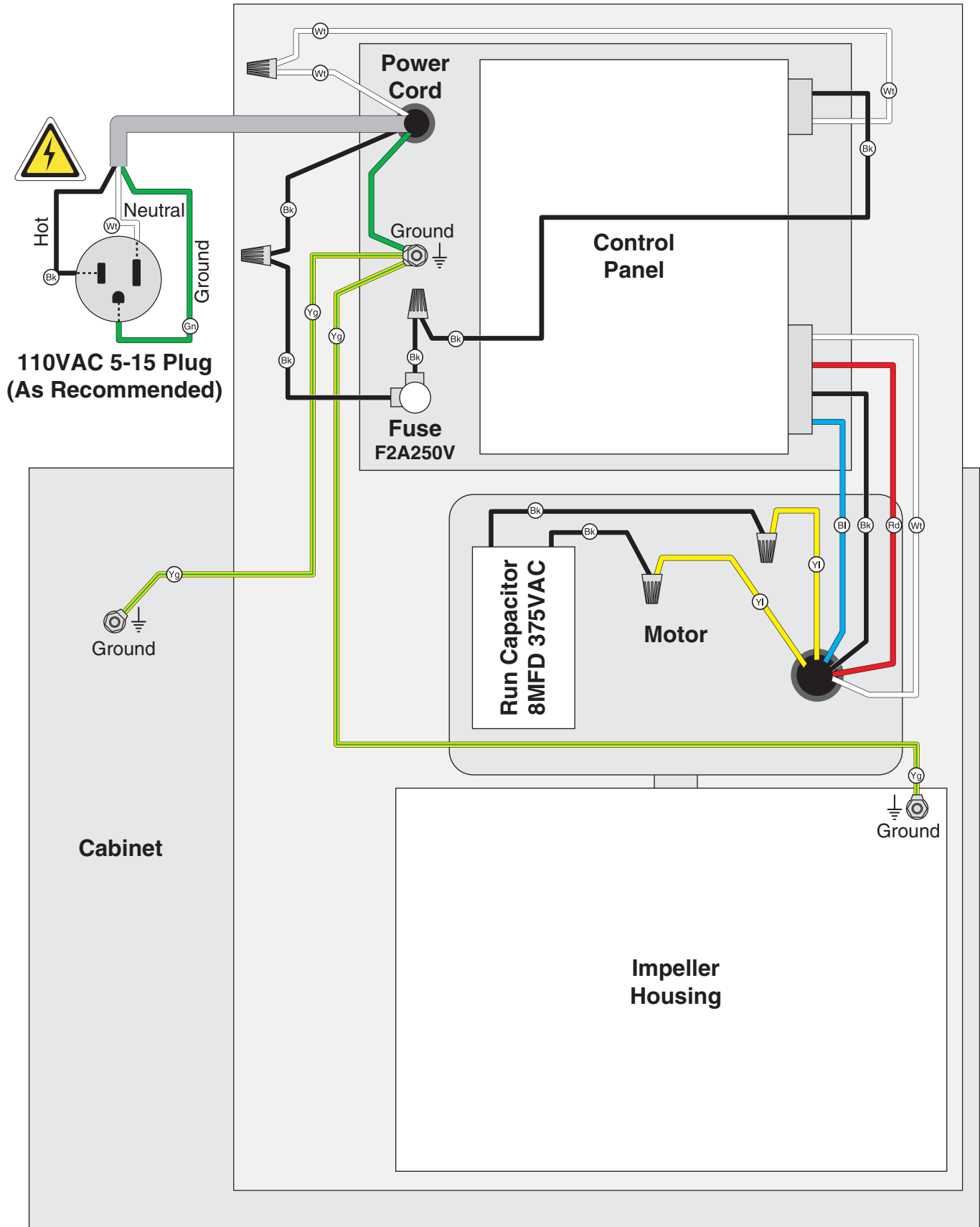

SECTION 9: PARTS

Cabinet & Remote Control

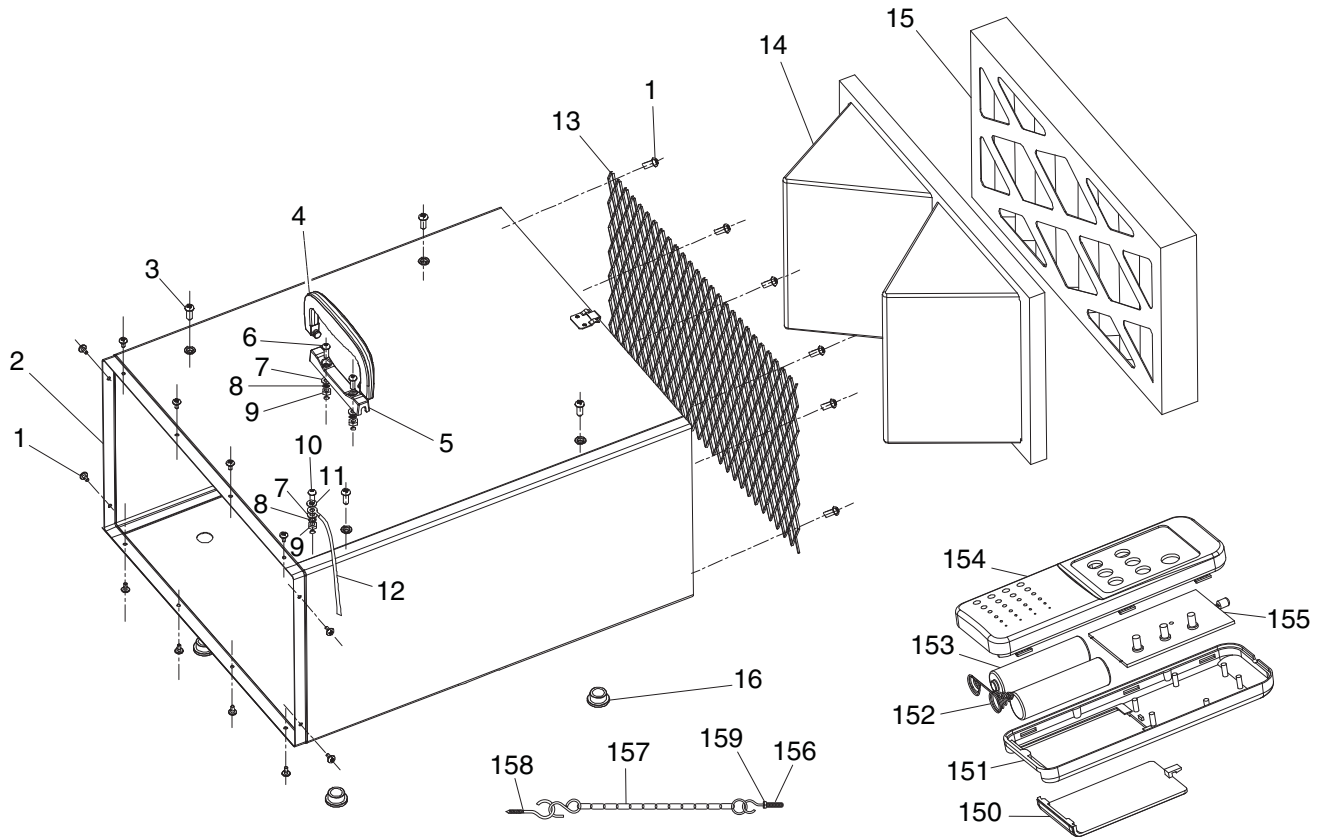

REF	PART #	DESCRIPTION
1	PHTEK15M	TAP SCREW M4 X 10
2	P0738002	CABINET
3	PS14M	PHLP HD SCR M6-1 X 12
4	P0738004	CABINET HANDLE
5	P0738005	HANDLE BRACKET
6	PS40M	PHLP HD SCR M5-.8 X 16
7	PW02M	FLAT WASHER 5MM
8	PLW01M	LOCK WASHER 5MM
9	PN06M	HEX NUT M5-.8
10	PS08M	PHLP HD SCR M5-.8 X 12
11	PTLW02M	EXT TOOTH WASHER 5MM
12	P0738012	GROUND WIRE 18AWG 335MM
13	P0738013	WIRE MESH 251 X 528MM

REF	PART #	DESCRIPTION
14	T10503	INNER FILTER 421 X 241 X 160MM
15	T10504	OUTER FILTER 421 X 241 X 45MM
16	P0738016	RUBBER FOOT
150	P0738150	BATTERY COVER
151	P0738151	REMOTE CONTROL BOTTOM COVER
152	P0738152	BATTERY SPRING
153	P0738153	BATTERY AA
154	P0738154	REMOTE CONTROL TOP COVER
155	P0738155	REMOTE CONTROL CIRCUIT BOARD
156	P0738156	THREADED HOOK M6-1 X 35
157	P0738157	HANGING CHAIN 11-1/2"
158	P0738158	HOOK SCREW M6 X 25
159	PFN02M	FLANGE NUT M6-1



Control Panel

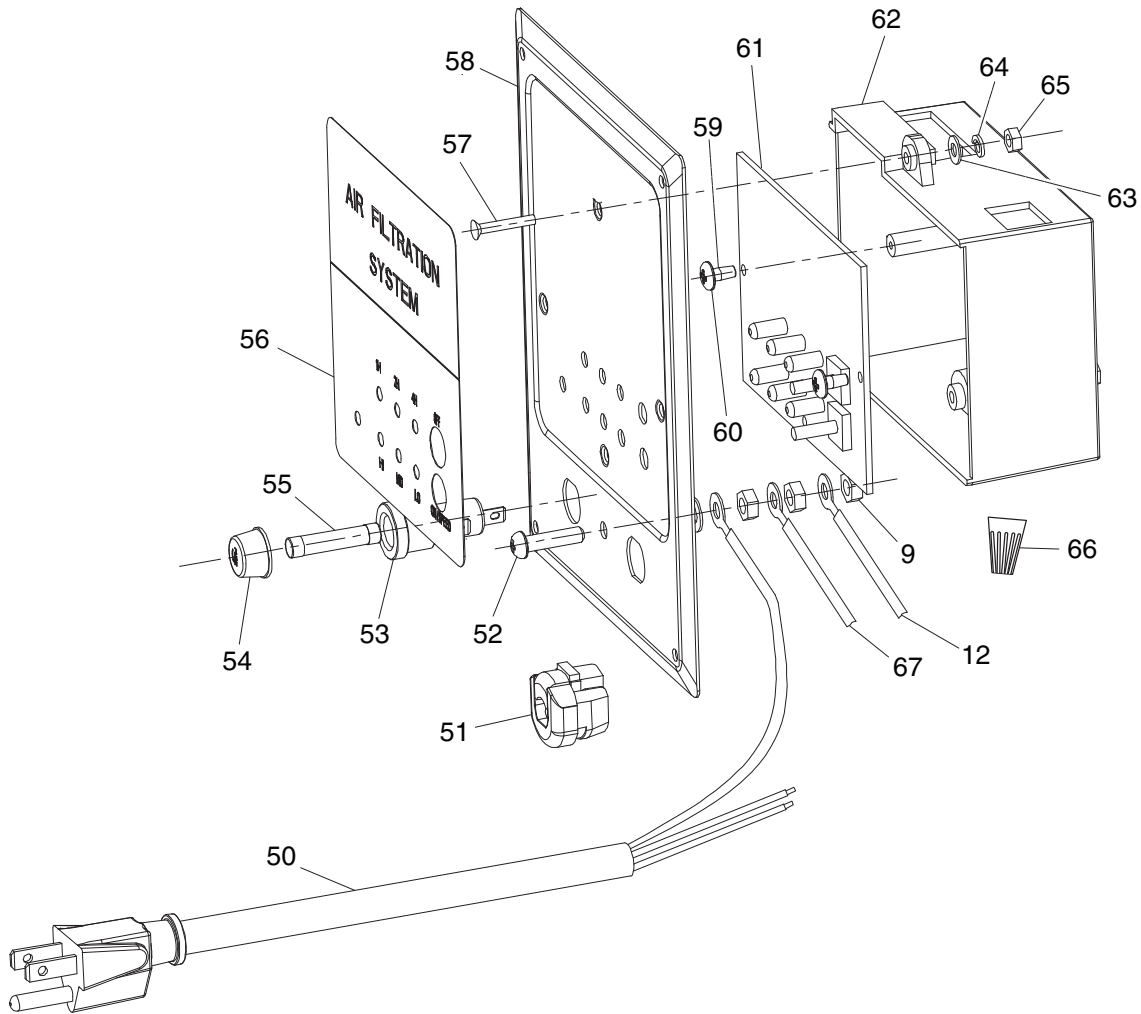

REF	PART #	DESCRIPTION
9	PN06M	HEX NUT M5-.8
12	P0738012	GROUND WIRE 18AWG 335MM
50	P0738050	POWER CORD 18G 3W 72" 5-15
51	P0738051	STRAIN RELIEF 6P-4
52	PS06M	PHLP HD SCR M5-.8 X 20
53	P0738053	FUSE HOLDER CFH052S CR3-13
54	P0738054	FUSE HOLDER CAP
55	P0738055	FUSE F2A250V
56	P0738056	CONTROL PANEL LABEL
57	PFH85M	FLAT HD SCR M3-.5 X 30

REF	PART #	DESCRIPTION
58	P0738058	CONTROL PANEL PLATE
59	P0738059	INSULATED FLAT WASHER 3MM
60	PHTEK31M	TAP SCREW M4 X 14
61	P0738061	PRINTED CIRCUIT BOARD
62	P0738062	CONTROL PANEL BOX
63	PW07M	FLAT WASHER 3MM
64	PLW09M	LOCK WASHER 3MM
65	PN07M	HEX NUT M3-.5
66	P0738066	WIRE NUT 18AWG
67	P0738067	WIRE 18AWG 6-3/4"



Motor & Impeller

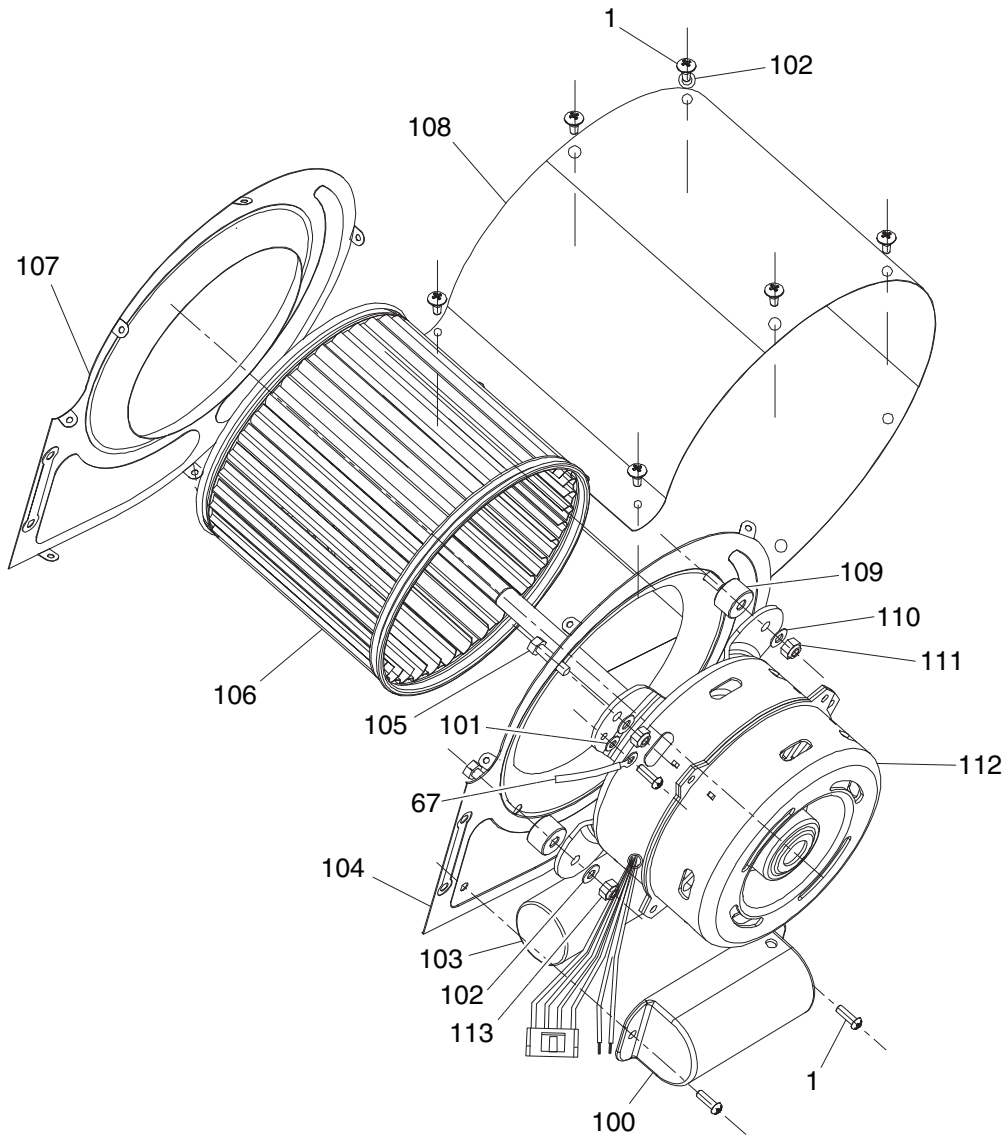

REF	PART #	DESCRIPTION
1	PHTEK15M	TAP SCREW M4 X 10
67	P0738067	WIRE 18AWG 6-3/4"
100	P0738100	CAPACITOR COVER
101	PTLW01M	EXT TOOTH WASHER 4MM
102	PW05M	FLAT WASHER 4MM
103	P0738103	R CAPACITOR 8M 375V 1-1/4 X 2-1/2
104	P0738104	FRONT IMPELLER HOUSING COVER
105	PB94M	HEX BOLT M5-.8 X 25

REF	PART #	DESCRIPTION
106	P0738106	SQUIRREL CAGE IMPELLER
107	P0738107	REAR IMPELLER HOUSING COVER
108	P0738108	IMPELLER HOUSING
109	P0738109	RUBBER SPACER
110	PWF05M	FENDER WASHER 5MM
111	PLN02M	LOCK NUT M5-.8
112	P0738112	MOTOR 1/8HP 120V 60HZ
113	PS02M	PHLP HD SCR M4-.7 X 12



Machine Labels

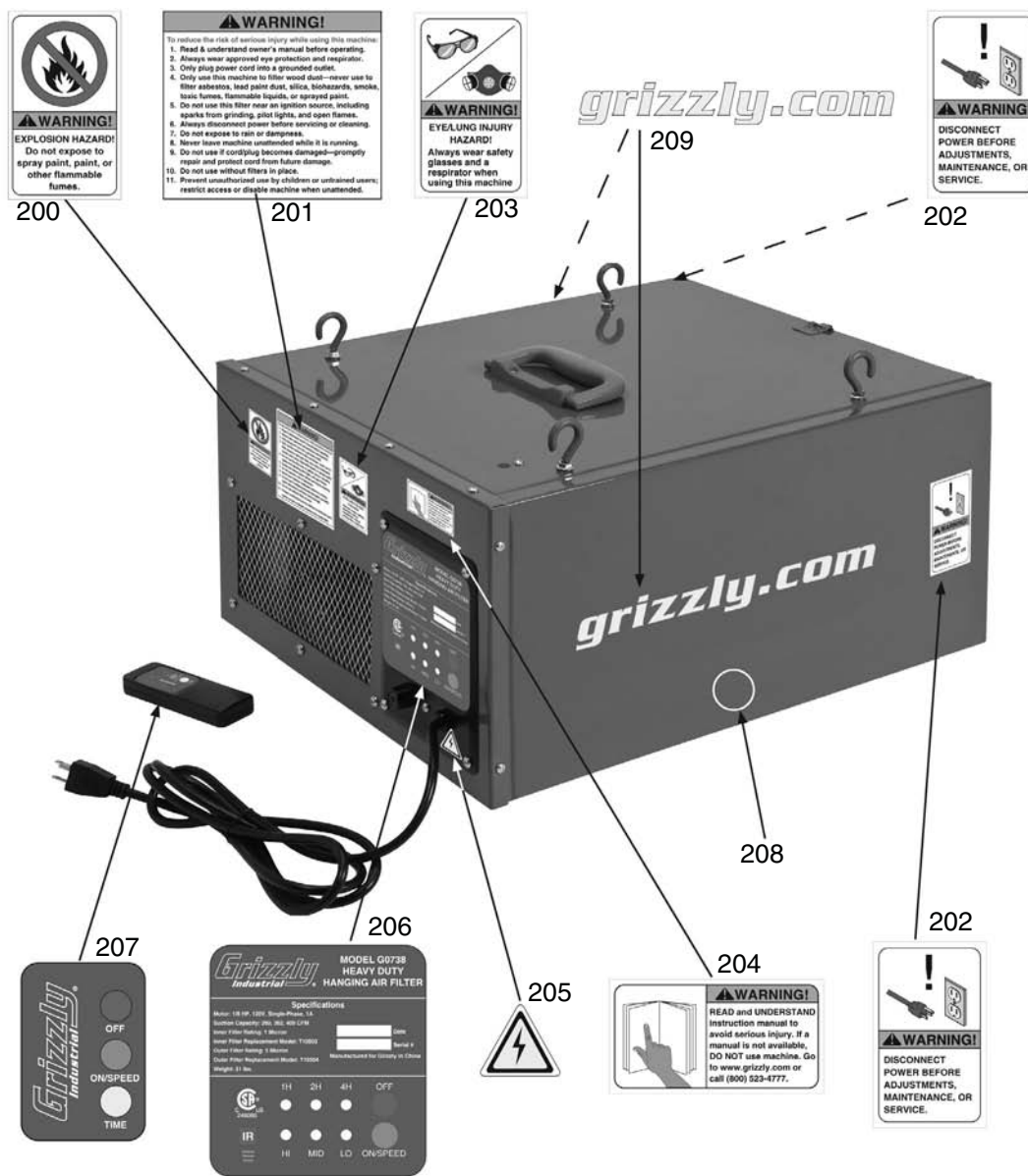

REF	PART #	DESCRIPTION
200	P0738200	EXPLOSION HAZARD LABEL
201	P0738201	GENERAL WARNINGS LABEL
202	PLABEL-62A	DISCONNECT LABEL
203	PLABEL-57A	EYE/LUNG HAZARD LABEL
204	PLABEL-12D	READ MANUAL LABEL

REF	PART #	DESCRIPTION
205	PLABEL-14B	ELECTRICITY LABEL
206	P0738206	CONTROL PANEL LABEL
207	P0738207	REMOTE CONTROL LABEL
208	PPAINT-1	GRIZZLY GREEN TOUCH-UP PAINT
209	P0738209	GRIZZLY.COM LABEL

WARNING

Safety labels help reduce the risk of serious injury caused by machine hazards. If any label comes off or becomes unreadable, the owner of this machine **MUST** replace it in the original location before resuming operations. For replacements, contact (800) 523-4777 or www.grizzly.com.





WARRANTY CARD

Name _____
 Street _____
 City _____ State _____ Zip _____
 Phone # _____ Email _____ Invoice # _____
 Model # _____ Order # _____ Serial # _____

The following information is given on a voluntary basis. It will be used for marketing purposes to help us develop better products and services. **Of course, all information is strictly confidential.**

1. How did you learn about us?

<input type="checkbox"/> Advertisement	<input type="checkbox"/> Friend	<input type="checkbox"/> Catalog
<input type="checkbox"/> Card Deck	<input type="checkbox"/> Website	<input type="checkbox"/> Other:

2. Which of the following magazines do you subscribe to?

<input type="checkbox"/> Cabinetmaker & FDM	<input type="checkbox"/> Popular Science	<input type="checkbox"/> Wooden Boat
<input type="checkbox"/> Family Handyman	<input type="checkbox"/> Popular Woodworking	<input type="checkbox"/> Woodshop News
<input type="checkbox"/> Hand Loader	<input type="checkbox"/> Precision Shooter	<input type="checkbox"/> Woodsmith
<input type="checkbox"/> Handy	<input type="checkbox"/> Projects in Metal	<input type="checkbox"/> Woodwork
<input type="checkbox"/> Home Shop Machinist	<input type="checkbox"/> RC Modeler	<input type="checkbox"/> Woodworker West
<input type="checkbox"/> Journal of Light Cont.	<input type="checkbox"/> Rifle	<input type="checkbox"/> Woodworker's Journal
<input type="checkbox"/> Live Steam	<input type="checkbox"/> Shop Notes	<input type="checkbox"/> Other:
<input type="checkbox"/> Model Airplane News	<input type="checkbox"/> Shotgun News	
<input type="checkbox"/> Old House Journal	<input type="checkbox"/> Today's Homeowner	
<input type="checkbox"/> Popular Mechanics	<input type="checkbox"/> Wood	

3. What is your annual household income?

<input type="checkbox"/> \$20,000-\$29,000	<input type="checkbox"/> \$30,000-\$39,000	<input type="checkbox"/> \$40,000-\$49,000
<input type="checkbox"/> \$50,000-\$59,000	<input type="checkbox"/> \$60,000-\$69,000	<input type="checkbox"/> \$70,000+

4. What is your age group?

<input type="checkbox"/> 20-29	<input type="checkbox"/> 30-39	<input type="checkbox"/> 40-49
<input type="checkbox"/> 50-59	<input type="checkbox"/> 60-69	<input type="checkbox"/> 70+

5. How long have you been a woodworker/metalworker?

<input type="checkbox"/> 0-2 Years	<input type="checkbox"/> 2-8 Years	<input type="checkbox"/> 8-20 Years	<input type="checkbox"/> 20+ Years
------------------------------------	------------------------------------	-------------------------------------	------------------------------------

6. How many of your machines or tools are Grizzly?

<input type="checkbox"/> 0-2	<input type="checkbox"/> 3-5	<input type="checkbox"/> 6-9	<input type="checkbox"/> 10+
------------------------------	------------------------------	------------------------------	------------------------------

7. Do you think your machine represents a good value? Yes No
8. Would you recommend Grizzly Industrial to a friend? Yes No
9. Would you allow us to use your name as a reference for Grizzly customers in your area?
Note: We never use names more than 3 times. Yes No

10. Comments: _____

CUT ALONG DOTTED LINE

FOLD ALONG DOTTED LINE



Place Stamp Here



GRIZZLY INDUSTRIAL, INC.
P.O. BOX 2069
BELLINGHAM, WA 98227-2069



FOLD ALONG DOTTED LINE

Send a Grizzly Catalog to a friend:

Name _____
Street _____
City _____ State _____ Zip _____

TAPE ALONG EDGES--PLEASE DO NOT STAPLE

WARRANTY & RETURNS

Grizzly Industrial, Inc. warrants every product it sells for a period of **1 year** to the original purchaser from the date of purchase. This warranty does not apply to defects due directly or indirectly to misuse, abuse, negligence, accidents, repairs or alterations or lack of maintenance. This is Grizzly's sole written warranty and any and all warranties that may be implied by law, including any merchantability or fitness, for any particular purpose, are hereby limited to the duration of this written warranty. We do not warrant or represent that the merchandise complies with the provisions of any law or acts unless the manufacturer so warrants. In no event shall Grizzly's liability under this warranty exceed the purchase price paid for the product and any legal actions brought against Grizzly shall be tried in the State of Washington, County of Whatcom.

We shall in no event be liable for death, injuries to persons or property or for incidental, contingent, special, or consequential damages arising from the use of our products.

To take advantage of this warranty, contact us by mail or phone and give us all the details. We will then issue you a "Return Number," which must be clearly posted on the outside as well as the inside of the carton. We will not accept any item back without this number. Proof of purchase must accompany the merchandise.

The manufacturers reserve the right to change specifications at any time because they constantly strive to achieve better quality equipment. We make every effort to ensure that our products meet high quality and durability standards and we hope you never need to use this warranty.

Please feel free to write or call us if you have any questions about the machine or the manual.

Thank you again for your business and continued support. We hope to serve you again soon.

grizzly.com[®]

TOOL WEBSITE

Buy Direct and Save with Grizzly[®] – Trusted, Proven and a Great Value!
~Since 1983~

*Visit Our Website Today For
Current Specials!*

**ORDER
24 HOURS A DAY!
1-800-523-4777**



Free Manuals Download Website

<http://myh66.com>

<http://usermanuals.us>

<http://www.somanuals.com>

<http://www.4manuals.cc>

<http://www.manual-lib.com>

<http://www.404manual.com>

<http://www.luxmanual.com>

<http://aubethermostatmanual.com>

Golf course search by state

<http://golfingnear.com>

Email search by domain

<http://emailbydomain.com>

Auto manuals search

<http://auto.somanuals.com>

TV manuals search

<http://tv.somanuals.com>