

**User's Manual**

P/N 071791-001

Trakker Antares<sup>®</sup>  
**243X Hand-Held Terminal**

 **ntermec**

A **UNOVA** Company

Intermec Technologies Corporation  
6001 36th Avenue West  
P.O. Box 4280  
Everett, WA 98203-9280

U.S. service and technical support: 1-800-755-5505  
U.S. media supplies ordering information: 1-800-227-9947

Canadian service and technical support: 1-800-668-7043  
Canadian media supplies ordering information: 1-800-268-6936

Outside U.S.A. and Canada: Contact your local Intermec service supplier.

The information contained herein is proprietary and is provided solely for the purpose of allowing customers to operate and/or service Intermec manufactured equipment and is not to be released, reproduced, or used for any other purpose without written permission of Intermec.

Information and specifications in this manual are subject to change without notice.

© 2001 by Intermec Technologies Corporation  
All Rights Reserved

The word Intermec, the Intermec logo, INCA (under license), MobileLAN, JANUS, IRL, Trakker Antares, EZBuilder, TE 2000, Data Collection Browser, dcBrowser, Universal Access Point, UAP, and CrossBar are either trademarks or registered trademarks of Intermec.

Throughout this manual, trademarked names may be used. Rather than put a trademark (<sup>TM</sup> or ®) symbol in every occurrence of a trademarked name, we state that we are using the names only in an editorial fashion, and to the benefit of the trademark owner, with no intention of infringement.

There are U.S. and foreign patents pending.

# Contents

**Before You Begin vii***Warranty Information vii**Safety Summary vii**Warnings, Cautions, and Notes viii**About This Manual viii*

## 1

---

**Learning About the Terminal****What Are the Trakker Antares 243X Terminals? 1-3***Learning About the 243X's Features 1-4**Options for the Terminals 1-5**Accessories for the Terminals 1-6***Unpacking the Terminal 1-7****Using the Terminal's Battery Pack 1-8***Determining When the Battery Pack Is Low 1-8**Charging the Battery Pack 1-9**Installing the Battery Pack 1-9**Managing Battery Power 1-11***Using the Keypad 1-11***Finding the Special Keys 1-12**Typing the Characters Printed on the Keypad 1-13**Using the Suspend/Resume Key 1-13**Using the Modifier Keys 1-14**Capitalizing All Characters 1-14**Using the International Keypads 1-15**Using the TE 2000 Keypads 1-16***Using the Screen 1-17****Learning About the Status Icons 1-18****Learning About the Audio Signals 1-19****Using the Terminal's Serial Port 1-20**

***Using the Terminal's Scanner 1-21***

*Learning About the Connector Modules 1-23*

*Connecting an Input Device 1-24*

*Scanning Options 1-24*

***Connecting to a Serial Device or Network 1-24***

***Defining the Terminal's Drives 1-25***

***Using the Terminal for the First Time 1-26***

**2**

---

***Configuring the Terminal***

***How to Configure the Terminal 2-3***

*About the Configurations 2-3*

***Configuring the Terminal With the Menu System 2-4***

*Accessing Online Help 2-6*

*Selecting Menus and Commands 2-6*

*Filling In Fields 2-6*

*Marking Check Boxes 2-7*

*Entering ASCII Control Characters 2-8*

*Exiting Screens and Saving Changes 2-9*

*Exiting the Menu System 2-10*

***Configuring the Terminal With the Clone Application 2-11***

***Configuring Drives and Memory on the Terminal 2-12***

*Configuring the RAM Drive 2-12*

*Configuring Flash Memory 2-13*

**3**

---

***Operating the Terminal in a Network***

***How the Terminals Fit Into Your Network 3-3***

***Using Serial Communications on the Terminal 3-7***

*Choosing a Communications Protocol 3-8*

*Binary Protocol 3-8*

*Configurable Protocol 3-9*

*Master Polling Protocol 3-10*

*Point-to-Point Protocol 3-10*

*Polling Mode D Protocol 3-10*

**Using RF Communications on the Terminal 3-11***Planning the Network Connection 3-11**Configuring the DCS 30X 3-12**Configuring the Access Points 3-12**OpenAir Radio 3-13**802.11b Radio 3-13**About the Network Parameters 3-14**Monitoring Network Communications 3-14***4**

---

**Troubleshooting and Maintaining the Terminal****How to Use This Chapter 4-3***Problems While Operating the Terminal 4-4**Problems While Configuring the Terminal 4-6**Problems Communicating With RF Network Devices 4-11**Problems While Running Applications 4-13**Problems Transmitting Data Through the Serial Port 4-14**Problems Transmitting Data Through the DCS 30X 4-14**Problems Scanning Bar Code Labels 4-15***Booting the Terminal 4-17***Booting the Terminal on Resume 4-17**Using the Boot Menu 4-18***Troubleshooting a Locked Up Application 4-18****Resetting the Terminal 4-19****Cleaning the Scanner Window and Terminal Screen 4-20****A**

---

**Specifications****Physical and Environmental Specifications A-3****Pin Assignments A-6***Pin Assignments for COM1 A-6**Pin Assignments for the Input Device Connectors A-7***I**

---

**Index**



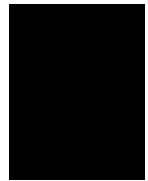

## ***Before You Begin***

---

This section introduces you to standard warranty provisions, safety precautions, warnings and cautions, document formatting conventions, and sources of additional product information. A documentation roadmap is also provided to guide you in finding the appropriate information.

---

### ***Warranty Information***

To receive a copy of the standard warranty provision for this product, contact your local Intermec support services organization. In the U.S.A. call 1-800-755-5505, and in Canada call 1-800-668-7043. If you live outside the U.S.A. or Canada, you can find your local Intermec support services organization on the Intermec Web site at [www.intermec.com](http://www.intermec.com).

---

### ***Safety Summary***

Your safety is extremely important. Read and follow all warnings and cautions in this book before handling and operating Intermec equipment. You can be seriously injured, and equipment and data can be damaged if you do not follow the safety warnings and cautions.

**Do not repair or adjust alone** Do not repair or adjust energized equipment alone under any circumstances. Someone capable of providing first aid must always be present for your safety.

**First aid** Always obtain first aid or medical attention immediately after an injury. Never neglect an injury, no matter how slight it seems.

**Resuscitation** Begin resuscitation immediately if someone is injured and stops breathing. Any delay could result in death. To work on or near high voltage, you should be familiar with approved industrial first aid methods.

**Energized equipment** Never work on energized equipment unless authorized by a responsible authority. Energized electrical equipment is dangerous. Electrical shock from energized equipment can cause death. If you must perform authorized emergency work on energized equipment, be sure that you comply strictly with approved safety regulations.

---

## Warnings, Cautions, and Notes

The warnings, cautions, and notes in this manual use the following format.



### Warning

*A warning alerts you of an operating procedure, practice, condition, or statement that must be strictly observed to avoid death or serious injury to the persons working on the equipment.*

### Avertissement

*Un avertissement vous avertit d'une procédure de fonctionnement, d'une méthode, d'un état ou d'un rapport qui doit être strictement respecté pour éviter l'occurrence de mort ou de blessures graves aux personnes manipulant l'équipement.*



### Caution

*A caution alerts you to an operating procedure, practice, condition, or statement that must be strictly observed to prevent equipment damage or destruction, or corruption or loss of data.*

### Conseil

*Une précaution vous avertit d'une procédure de fonctionnement, d'une méthode, d'un état ou d'un rapport qui doit être strictement respecté pour empêcher l'endommagement ou la destruction de l'équipement, ou l'altération ou la perte de données.*



**Note:** Notes are statements that either provide extra information about a topic or contain special instructions for handling a particular condition or set of circumstances.

---

## About This Manual

This manual contains all of the necessary information to connect, operate, configure, troubleshoot, and maintain the Trakker Antares® 2430 and 2435 hand-held terminal. Use this manual in conjunction with the *Trakker Antares 2400 Family System Manual* (Part No. 071389), which contains detailed information about configuring, operating, and programming all terminals in the 2400 Family.

This manual was written for two audiences:

- All users who need to know how to use the terminal to collect data.
- MIS personnel, operations personnel, analysts, and programmers who need to know how to install, configure, test, troubleshoot, and use the terminal to operate in a network. You should have a good knowledge of your company's network and data collection software. You should be familiar with data communications and network protocols.





## What You Will Find in This Manual

This table summarizes the information in each chapter and appendix.

Chapter	Summary
1	Introduces the Trakker Antares 2430 and 2435 hand-held terminals and their features. Also describes the batteries, memory, drives, and input devices.
2	Describes the different methods that you can use to configure the 243X and its memory and drives. Also explains how to configure the terminal using the TRAKKER Antares 2400 Menu System and the clone application.
3	Describes how to install and configure the 243X in a serial or RF network. Also explains how the 243X fits into a particular network and how to use serial or network communications.
4	Lists problems you may encounter while using the terminal and provides some possible solutions. Also describes how to boot or reset the terminal and clean the scanner window and terminal screen.
A	Lists the Trakker Antares 243X terminal's specifications.

This manual explains how to use the features and options available on the 243X. For more detailed information about configuring, operating, and programming the 243X, see the *Trakker Antares 2400 Family System Manual* (Part No. 071389).

For additional help using terminal emulation, see the appropriate TE 2000 manual:

- *TE 2000 5250 Terminal Emulation Programmer's Guide* (Part No. 977-055-004)
- *TE 2000 3270 Terminal Emulation Programmer's Guide* (Part No. 977-055-003)
- *TE 2000 VT/ANSI Terminal Emulation Programmer's Guide* (Part No. 977-055-005).

For additional help using dcBrowser, see the documentation that ships with your DCS 30X or dcBrowser gateway software.

## Terminology

You should be aware of how these terms are being used in this manual:













Term	Description
DCS 300 and Model 200 Controller	The DCS 300 is a data collection server that replaced the Model 200 Controller. The 2435 can communicate with either the DCS 300 or the Model 200 Controller. Unless otherwise noted, you can use either the DCS 300 or the Model 200 Controller.
DCS 30X	DCS 30X refers to the DCS 300, the DCS 301, and the DCS 302 data collection servers. The term DCS 30X is used throughout this manual. Unless otherwise noted, you can use either the DCS 300, the DCS 301, or the DCS 302.

**Terminology (continued)**

<b>Term</b>	<b>Description</b>
Host	The term “host” refers to a personal computer or other computer that communicates with the terminal.
243X	The generic term “243X” indicates either the Trakker Antares 2430 terminal or the Trakker Antares 2435 terminal.
Terminal	The generic term “terminal” indicates either the Trakker Antares 2430 terminal or the Trakker Antares 2435 terminal.
Trakker Antares	The term “Trakker Antares” identifies the product family of Trakker Antares 2400 Family terminals, which includes the hand-held terminals, stationary terminals, vehicle-mount terminals, and light industrial terminals.

**Conventions for Input From a Keypad or Keyboard**

This table describes the formatting conventions for input from PC or host computer keyboards and terminal keypads:

<b>Convention</b>	<b>How to Interpret the Convention</b>		
Special text	Shows the command as you should enter it into the terminal. See “Conventions for Commands” later in this chapter.		
<i>Italic text</i>	Indicates that you must replace the parameter with a value. See “Conventions for Commands” later in this chapter.		
<b>Bold text</b>	Indicates the keys you must press on a PC or host computer keyboard. For example, “press <b>Enter</b> ” means you press the key labeled “Enter” on the PC or host computer keyboard.		
	Shows the key you must press on the terminal. For example, “press     	Shows a series of terminal keys you must press and release in the order shown. For example, “Press      — 	Shows a series of terminal keys you must press simultaneously. Also, you must press and hold the keys in the order shown.



**Note:** You must use the Field Exit key ( on the 57-key keypad or the Return key ( on the 39-key keypad to access the TRAKKER Antares 2400 Main Menu. Do **not** use the Enter key ( in this key sequence.



### **Conventions for Bar Codes**

You can scan the bar codes listed in this manual to enter data or perform a command. The bar code labels in this manual are printed in the Code 39 symbology. Each bar code includes the name and human-readable interpretation. For example:

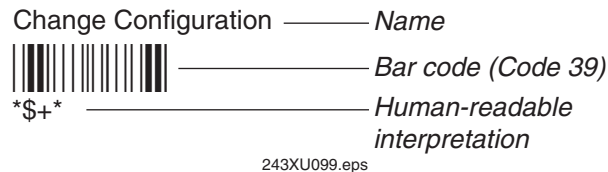

The asterisks (\*) at the beginning and end of the human-readable interpretation are the start and stop codes for a Code 39 bar code label. If you are using a bar code printing utility, it may automatically supply the asterisks as the start and stop code, so that you only need to type the actual text of the command. You can also create and print configuration labels and reader command labels in Code 93, which has its own start and stop codes.

### **Conventions for Software Screens and Messages**

This manual includes illustrations that represent how the Trakker Antares 2430 and 2435 terminals display software screens and messages. Here are two examples:

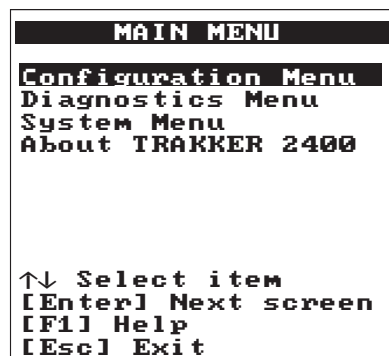

243XU050.eps

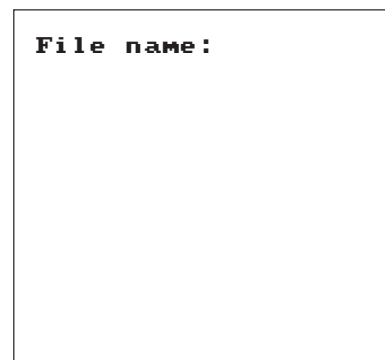

243XU060.eps

The TRAKKER Antares 2400 Menu System software screens are 16 lines by 20 characters (like the Main Menu screen example shown here). These screens are centered and formatted to fit on the 2430 and 2435 screens.

### **Conventions for Commands**

This manual includes sample commands that are shown exactly as you should type them on your terminal or network device. The manual also describes the syntax for many commands, defining each parameter in the command. This example illustrates the format conventions used for commands:

To send a configuration command from the DCS 30X, use this syntax:

```
$+command [command] . . . [command n]
```

where:

`$+` is the Change Configuration command.

*command* is a configuration command. For example, BV is the command to set the Beep Volume on the terminal. Enter the command BV0 to turn off the beep volume. You can include multiple configuration *command* parameters in the command to configure the terminal.

This table defines the conventions used in the example:

<b>Convention</b>	<b>Description</b>
Special font	Commands appear in this font. You enter the command exactly as it is shown.
<i>Italic text</i>	Italics indicate a variable, which you must replace with a real value, such as a number, filename, keyword, or command.
[ ]	Brackets enclose a parameter that you may omit from the command. Do not include the brackets in the command.
Required parameters	If a parameter is not enclosed in brackets [ ], the parameter is required. You <b>must</b> include the parameter in the command; otherwise, the command will not execute correctly.
where	This word introduces a list of the command's parameters and explains the values you can specify for them.

### **Other Intermec Manuals**

You may need additional information when working with the 243X in a data collection system. Please visit our Web site at [www.intermec.com](http://www.intermec.com) to download many of our current manuals in PDF format. To order printed versions of the Intermec manuals, contact your local Intermec representative or distributor.



# ***Learning About the Terminal***



*This chapter introduces the Trakker Antares 2430 and 2435 hand-held terminals and their features including the batteries, memory, drives, and input devices. It also describes how to start using the 243X.*

## **What Are the Trakker Antares 243X Terminals?**

---

The 2430 and 2435 are ergonomic hand-held data collection terminals. You can use these programmable terminals to run custom applications or terminal emulation applications.



**2430** The 2430 is a programmable data collection terminal that runs custom batch applications. The 2430 has a flash drive to store applications and files and an integrated input/output (I/O) port to transmit data to and accept data from a host computer or other serial device using RS-232 communications. The versatile display features of the 2430 allow you to resize the screen based on operator preference and work environment.

**2435** The 2435 has all of the same functionality as the 2430 with the additional ability for real-time communications through an RF network. The 2435 can communicate with a host either through the access points and the DCS 30X or directly through the access points. The 2435 can also run client/server applications, TE 2000™ terminal emulation applications, and Data Collection Browser™ (dcBrowser™), which lets you run Web-based applications.



The 2435 with an IEEE 802.11b radio (with radio firmware 4.52/6.04 and higher) installed is Wi-Fi certified for interoperability with other 802.11b wireless LAN devices.

## Learning About the 243X's Features

The 243X is designed to make data collection easy and includes these features:

### CGA-compatible screen

The screen is a backlit LCD that is configurable up to 21 lines by 31 characters. The screen also supports double-byte characters, user-programmable fonts, and bitmap graphics.

### Good Read LED and audio signals

The Good Read LED indicates the status of bar code scanning. The 243X also has status icons and a beeper that provide you with feedback for terminal operations.

**Keypad** There are two keypad options with different overlays. The 243X ships with a keypad and an overlay that supports the type of application that you ordered.

**Integrated I/O connector** The 6-pin connector acts as a serial port or power supply. You can connect the 243X to a serial device with the serial adapter cable. You can also connect the 243X to the external power supply with the external power adapter cable.

**Input device connector** The 9-pin connector on the connector module allows you to connect an input device to the 243X. Depending on the type of connector module you choose, the terminal supports either non-decoded input devices or decoded input devices.

**Docking connector** The docking connector allows you to insert the 243X into the vehicle dock accessory.

**Handstrap** The elastic handstrap attaches to the back of the terminal to let you hold the terminal easily and securely for long periods of use.

**Rechargeable battery pack and backup power source** The 243X uses a rechargeable lithium-ion battery pack as its main power source. The terminal has a backup power source that maintains the terminal's status, memory, and real-time clock (for up to 15 minutes) when the battery pack is changed.

**Internal Antenna (2435 only)** The 2435 uses an internal antenna that supports RF communications.

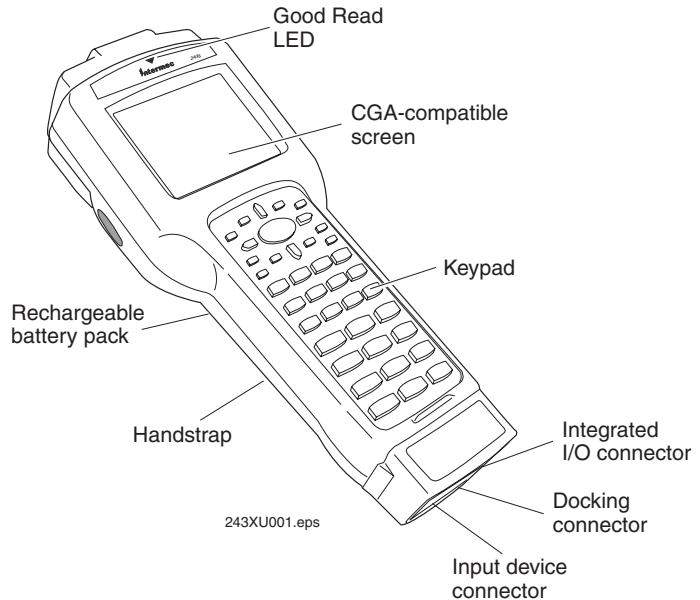



---

## **Options for the Terminals**

These options are available for the 2430:

- Programmable terminal with 57-key alphanumeric or 39-key function numeric keypad and overlays for U.S. English or International languages
- Integrated laser scanner (standard range, long range, or extra long range)
- 2MB or 4MB extended storage drive, used for custom applications or files
- Standard connector module (supports non-decoded tethered scanners) or serial connector module (supports decoded tethered scanners)
- Trakker Antares ROM-DOS™ support

These options are available for the 2435:

- Programmable terminal with 57-key alphanumeric or 39-key function numeric keypad and overlays for U.S. English or International languages
- Integrated laser scanner (standard range, long range, or extra long range)
- Standard connector module (supports non-decoded tethered scanners) or serial connector module (supports decoded tethered scanners)
- IBM 3270, IBM 5250, and VT100/220/320 and ANSI TE 2000 terminal emulation application with 57-key alphanumeric or 39-key function numeric keypads
- UDP Plus (DCS 30X network) or TCP/IP network protocol
- dcBrowser application
- Trakker Antares ROM-DOS™ support
- WLI Forum 2.4 GHz OpenAir radio or IEEE 802.11b radio

This manual explains how to use the features and options available on all models of the Trakker Antares terminals.

For additional help using terminal emulation, see the appropriate TE 2000 manual:

- *TE 2000 5250 Terminal Emulation Programmer's Guide* (Part No. 977-055-004)
- *TE 2000 3270 Terminal Emulation Programmer's Guide* (Part No. 977-055-003)
- *TE 2000 VT/ANSI Terminal Emulation Programmer's Guide* (Part No. 977-055-005)

For additional help using dcBrowser, see the documentation that ships with your DCS 30X, the dcBrowser gateway software, or the *Data Collection Browser Client User's Guide* (Part No. 070011).

---

## **Accessories for the Terminals**

You can use these accessories (sold and ordered separately) with the 243X:

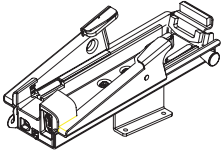

**Vehicle Dock** The vehicle dock is available in a standard model (Part No. 071805) and a powered model (Part No. 071695). This accessory allows you to easily mount the 243X to a variety of surfaces.

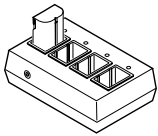

**Z2400 Battery Charger** The battery charger (Part No. Z2400A) lets you charge up to four lithium-ion battery packs at one time. The battery charger senses when a battery pack is fully charged and will not overcharge it, ensuring long and consistent battery pack life.



**Handle** The detachable pistol-grip handle (Part No. 067802) provides a convenient way to hold the terminal and use trigger-activated scanning.

**External Power Supply** The external power supply (Part No. 065236) allows you to power the terminal and charge the battery pack. The power supply comes with a North American power cord. If you are using the terminal outside North America, you need to purchase the appropriate power cord for your local power supply.

**External Power Supply Adapter Cable** The external power supply adapter cable (Part No. 071776) is shipped with the 243X. Use this cable to connect the 243X to the external power supply.

**Serial Adapter Cable** The serial adapter (Part No. 216-807-001) allows the 243X to communicate with a host computer or other serial device through the serial port.

**Cloning Cable** The cloning cable (Part No. 216-909-001) allows you to connect two 243X terminals so that you can use the clone application to copy configuration parameters from one 243X to another 243X.

## Unpacking the Terminal

When you remove the 243X from its box, save the box and shipping material in case you need to ship or store the terminal.

The terminal shipping box contains:

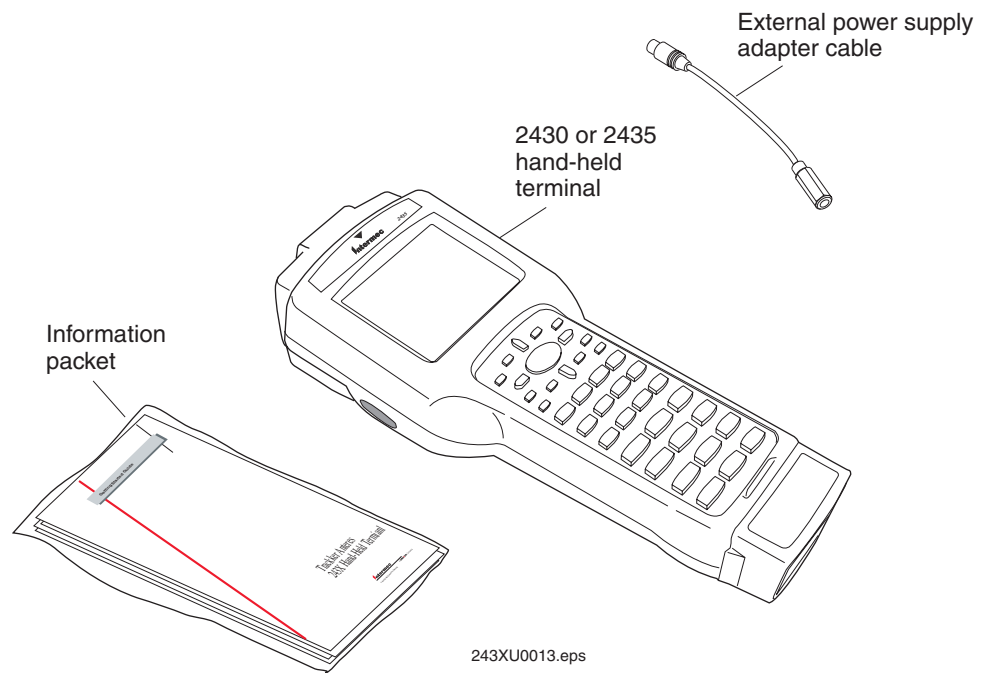

- 2430 or 2435 hand-held terminal
- External power supply adapter cable
- 243X quick start guide
- Manual safety supplement (Important 243X Information!)
- Handstrap (attached to the back of the 243X)

## Using the Terminal's Battery Pack

---



### Warning

*The lithium-ion battery pack that is used in this device may present a fire or chemical burn hazard if it is mistreated. Do not disassemble it, heat it above 100°C (212°F) or incinerate it.*

### Avertissement

*Le paquet de piles d'ions de lithium qui est utilisé dans cet appareil peut présenter un risque feu ou un risque chimique de brûlure s'il est maltraité. Il ne faut pas le désassembler, le réchauffer à une température plus élevée que 100° C (212° F) ou l'incinérer.*

The main power source for the 243X is a lithium-ion battery pack. When you change the battery pack, a backup power source maintains the terminal status, memory, and real-time clock for at least 15 minutes. Follow these tips to get the best battery performance and life possible:



**Note:** Do not press  when there is no battery pack installed in the terminal.

- Keep a spare, fully charged battery pack on hand.
- Keep a charged battery pack installed in the terminal to maximize the backup power source's life and so you can continue to operate the terminal without interruption.
- If the terminal turns off due to a low battery, do not turn the terminal back on. Replace or charge the battery pack before you continue using the terminal.

---

## Determining When the Battery Pack Is Low

The battery pack is the main power source for the terminal, and it charges the backup power source when required. If the battery charge goes low, you need to replace it with a charged battery pack or charge the battery pack as soon as possible.

There are two ways to determine if the battery pack is low:

- The Battery status icon turns on and the terminal beeps once every 15 seconds. For help using the status icons, see "Learning About the Status Icons" on page 1-18.
- Check the status of the battery pack using the Battery/PIC Status diagnostic test. For help, see Chapter 4, "Running Diagnostics," in the *Trakker Antares 2400 Family System Manual* (Part No. 071389).



**Note:** While the battery is charging, do not use this diagnostic test to determine when the battery is fully charged. To determine when the battery is fully charged, use the status LEDs on the battery chargers.

---

## Charging the Battery Pack

You must fully charge the battery pack before you can use the terminal.

### To charge the battery pack

- Place the battery pack in an empty slot in the battery charger. The battery pack fully charges in 3 to 4 hours. For help, see the documentation that came with your charger.
- Install the battery pack in the terminal. For help, see the next section, “Installing the Battery Pack.” Connect one end of the AC power supply adapter cable to the AC power supply, and connect the other end of the AC power supply adapter cable to the power port on the 243X. The battery pack is fully charged in about 3 to 4 hours.

You can also use the powered vehicle dock (Part No. 071695) (sold and ordered separately) connected to an external power supply to charge the battery. For help, see the *Trakker Antares 243X Vehicle Dock Installation Instructions* (Part No. 071793).



### Warning

*Replace the battery pack with Part No. 068537 only. The use of any other battery pack may present a risk of fire or explosion.*

### Avertissement

*Remplacez le bloc-batterie par la pièce réf. n° 068537 seulement. L'utilisation de tout autre bloc-batterie présente un risque d'incendie ou d'explosion.*

Contact your local Intermec sales representative for a replacement battery pack.  
DISPOSE OF USED BATTERY PACKS PROMPTLY. KEEP THEM AWAY FROM CHILDREN.

---

## Installing the Battery Pack



**Note:** Do not press  when there is no battery pack installed in the terminal.

### To install the battery pack

1. The 243X ships with the handstrap installed. Before you install the battery pack, you must remove the handstrap. Rotate the handstrap hook 90 degrees, and unhook it from the 243X.

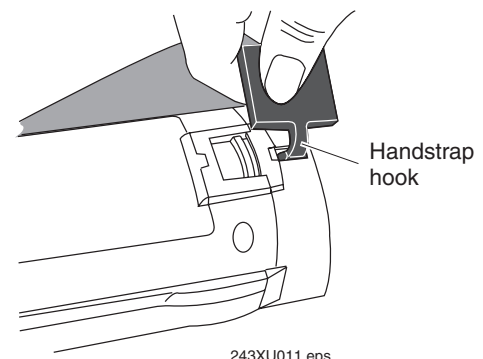

## Trakker Antares 243X Hand-Held Terminal User's Manual

2. Open the battery door.
  - a. Push down on the battery door latch and slide it toward the bottom end of the 243X.
  - b. Lift up the bottom edge of the battery door to remove it. You may need to pry the door open with a pointed object. Remove the foam insert if necessary.

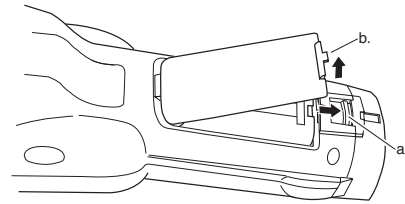

243XU015.eps

3. Place the battery pack into the battery compartment with the contacts pointed toward the bottom of the 243X.
4. Push the battery pack down until it locks into the connectors in the battery compartment.
5. Insert the top edge of the battery door into the top of the battery compartment. Push the door down to close it over the battery compartment.
6. Push the battery door latch up and slide it toward the top end of the 243X to lock the door in place.

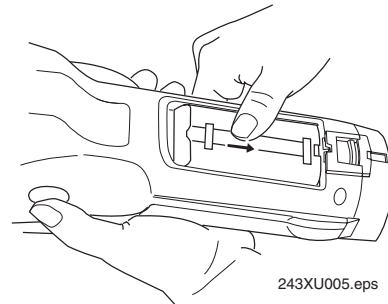

243XU005.eps

The 243X initializes after you install a charged battery pack. The green LED above the screen turns on briefly.

7. Attach the handstrap by inserting the handstrap hook as shown and rotating the handstrap hook 90 degrees toward the top of the terminal.

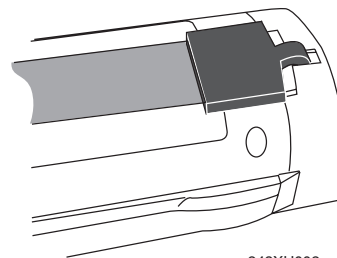
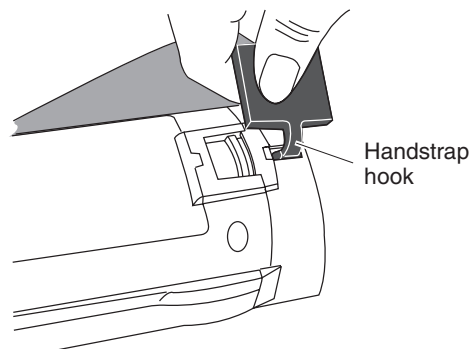

243XU002.eps



**Note:** The handstrap is most effective if it crosses the entire back of the hand and not just the fingers.

---

## Managing Battery Power

To maximize the life of the battery pack, use these power management features.

### Situation

You are operating the terminal and the Battery status icon turns on.

### Ways to Save Battery Power

Press  to turn off the terminal. Remove the battery pack and insert another fully charged battery pack. You must insert another fully charged battery pack within 15 minutes of removing the old battery pack or you may lose data.

Or, if you want to continue using the terminal and you do not have another battery pack, insert the terminal into the powered vehicle dock. The vehicle dock must be connected to an external power supply.

You are not using the terminal for 5 minutes or longer.

Make sure the Battery status icon is not on. Press  to turn off the terminal.

Or, use the Automatic Shutoff feature. Automatic shutoff turns off the terminal when there is no activity on the terminal for the length of time you set. For help, see “Automatic Shutoff” in Chapter 6 of the 2400 Family system manual.

You are going to store the terminal for more than a day.

Save your data and end your terminal session to minimize the risk of data loss. Press  to turn off the terminal. Insert a fully charged battery pack before you store the terminal.

---

## Using the Keypad

The 243X has the following keypad options and overlays:

- 57-key alphanumeric keypad
- 39-key function numeric keypad
- TE 2000 terminal emulation overlays

The 57-key alphanumeric keypad and the 39-key function numeric keypad are available in U.S. English and International. The International option supports French, German, Italian, Portuguese, and Spanish. Although the keypads are smaller than standard PC or terminal keyboards, you can use special keys to access all the keys and functions that you need.

Both keypad options support overlays for TE 2000 3270, TE 2000 5250, and TE 2000 VT/ANSI. When you order a TE 2000 application, you also receive the appropriate TE 2000 keypad overlay. Each TE 2000 keypad overlay is similar to the standard U.S. English keypad overlay, but it contains additional keys that are available on an IBM 3270, IBM 5250, or VT/ANSI keyboard. For additional help using terminal emulation, see the appropriate TE 2000 manual.

## Finding the Special Keys

Before you use the terminal's keypad, make sure you are familiar with the different types of keys on the keypad. You need to use these special keys on all keypad options. The special keys that you use to type characters or perform functions are explained in the next sections.



**Note:** You must use the Field Exit key (FIELD EXIT) on the 57-key keypad or the Return key (RETURN) on the 39-key keypad to access the TRAKKER Antares 2400 Main Menu. Do **not** use the Enter key (ENTER) in the key sequence to access the main menu.

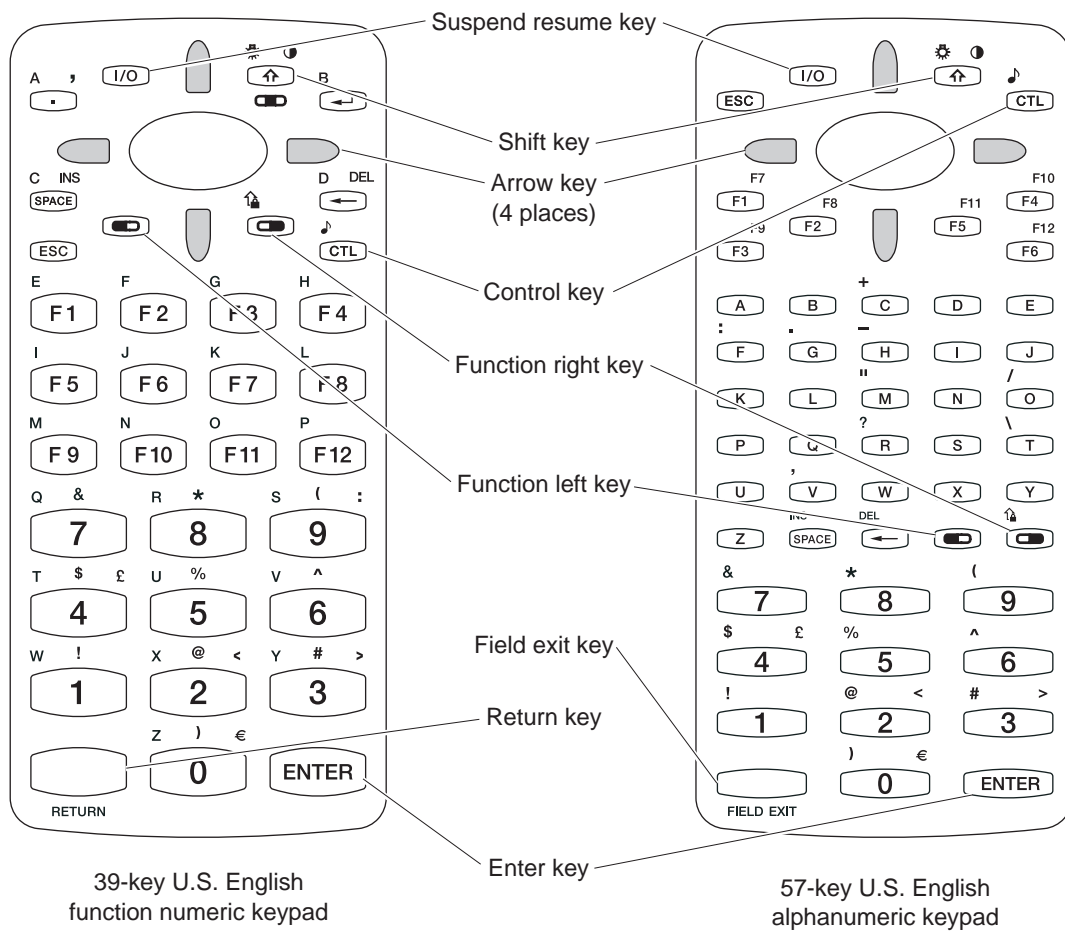



243XU034.eps



## Typing the Characters Printed on the Keypad

The keypads are easy to use. Characters, symbols, and functions are printed in four places on or above the keys. The keys are also color-coded to make it easier to remember key combinations.



Position on the Keypad	Color on Overlay	To Type the Character
Printed on the key		Press the key.
Left side above the key	Orange	Press the  key and then the key.
Centered above the key	Pink	Press the  key and then the key.
Right side above the key	Blue	Press the  key and then the key.

To learn how to type characters, use the following illustration and example from the 57-key U.S. English alphanumeric keypad.

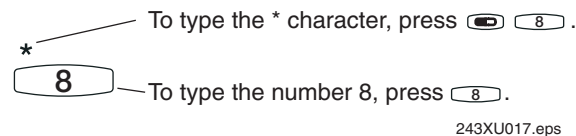
### Typing characters using the 57-key U.S. English alphanumeric keypad



## Using the Suspend/Resume Key

The terminal's Suspend/Resume key is the  key on the top left side of the keypad. When you press  to turn off the terminal, the terminal does not actually shut off but goes into a Suspend mode. In Suspend mode, the terminal continues to power all memory and turns off the power to most of the hardware. This mode is referred to as "off" in the rest of this manual.

When you press  to turn on the terminal, the terminal either resumes exactly where it was when you turned it off, or the terminal boots and restarts your application. Resume is controlled through the Resume Execution command. For help, see "Resume Execution" in Chapter 6 of the 2400 Family system manual.



**Note:** The terminal displays the boot menu the first time you turn it on. At the boot menu, press  to initialize the firmware and boot the terminal.

---

## Using the Modifier Keys

The keypad does not have a physical key for every character and function available. You use the Function Left (⏏), Function Right (⏏), Control (Ct), and Shift (⇧) keys to access characters or perform functions that do not have a physical key on the keypad. You also use the Shift key to type uppercase alphabetic characters.

When you press ⏏, ⏏, Ct, or ⇧, the key is held in a buffer until you press another key. The Modifier Key status icon on the right side of the terminal's screen turns on to remind you that the key is being held in the buffer. When you press another key, the key combination is entered into the terminal. The Modifier Key status icon turns off unless the second key that you pressed is another modifier key that is different from the first one that you pressed. For help using the status icons, see "Learning About the Status Icons" on page 1-18.

To flush the ⏏, ⏏, Ct, or ⇧ key from the buffer without performing any action, just press the key again. The Modifier Key status icon turns off.

### To use the Function Left, Function Right, Control, and Shift keys

1. Press ⏏, ⏏, Ct, or ⇧. The Modifier Key status icon turns on.
2. Press the second key. The Modifier Key status icon turns off.

For example, to type the Euro symbol (€) on a 39-key keypad, press ⏏. The Modifier Key status icon turns on. Press Ⓜ. The Modifier Key status icon turns off, and a Euro symbol appears on the screen.

---

## Capitalizing All Characters

To type all alphabetic characters as uppercase letters, you can



- press ⇧ before every letter you type.
- enable the Caps Lock feature. For help, continue with the next procedure.



**Note:** You cannot access the TRAKKER Antares 2400 Menu System while the Caps Lock feature is enabled.

- use the Keypad Caps Lock configuration command. For help, see "Keypad Caps Lock" in Chapter 6 of the 2400 Family system manual.



**To enable Caps Lock**

1. Press . The Modifier Key status icon turns on.
2. Press . The Caps Lock icon turns on and the Modifier Key icon turns off.
3. Type an alphabetic character. The letter appears as an uppercase character on the terminal's screen. The Caps Lock feature remains on until you disable it.

**To type a lowercase letter with Caps Lock enabled**

- Press  and an alphabetic character.

**To disable Caps Lock**



1. Press . The Modifier Key status icon turns on.
2. Press . The Caps Lock and Modifier Key status icons turn off.
3. Type an alphabetic character. The letter appears as a lowercase letter on the terminal's screen.











---

**Using the International Keypads**

You can order the 243X with an International keypad overlay that supports French, German, Italian, Portuguese, and Spanish. Like the U.S. English keypads, you use the international keypad to enter all the characters printed on or above the keys. For help, see “Typing the Characters Printed on the Keypad” on page 1-13. You can also use the international keypad to type characters with diacritical marks.



**To type characters with a diacritical mark**

1. (39-key keypad) Press  . The Caps Lock status icon turns on.
2. Press . The Modifier Key status icon turns on.
3. Press the key that the diacritical mark appears above.

To Type	39-Key	57-Key
^ (circumflex)		
` (grave)		
¨ (umlaut)		
´ (acute)		
~ (tilde)		

To flush the accent mark from the keypad buffer without entering any key, press  twice. The Modifier Key status icon turns off.



4. Enter one of the following types of characters:

- To accent a lowercase character  
(39-key keypad) Press , and then press the character.  
(57-key keypad) Press the character.
- To accent an uppercase character  
(39-key keypad) Press the character.  
(57-key keypad) Press , and then press the character.
- (57-key keypad) To type the accent mark by itself, press the  key.

(39-key keypad) The accented character or accent mark appears on the screen, the Modifier Key status icon turns off, and the Caps Lock status icon remains on.

(57-key keypad) The accented character or accent mark appears on the screen and the Modifier Key status icon turns off.



**Note:** If you are using a 39-key keypad, you must use the Left Arrow key () and the Right Arrow key () to type an accent mark above the letters “U” and “Y” respectively.

If you try to accent a character and the resulting character is not supported on the terminal, the plain (unaccented) character appears on the terminal screen. For a complete list of the international characters available in the terminal font, see Appendix C, “International Character Support,” in the 2400 Family system manual.

---

## **Using the TE 2000 Keypads**

The 243X supports TE 2000 VT100/220/320/340 and ANSI, TE 2000 5250, and TE 2000 3270. When you order a TE 2000 application, you also receive the appropriate TE 2000 keypad overlay. TE 2000 keypad overlays let you enter the same keys that you can enter from a VT/ANSI keyboard, an IBM 5250 keyboard, or an IBM 3270 keyboard.

Like the 39-key function numeric and the 57-key alphanumeric keypad overlays, the TE 2000 keypad overlay lets you enter all the characters printed on or above the keys. For help, see “Typing the Characters Printed on the Keypad” on page 1-13. The TE 2000 keypad overlays also come with the same special keys that are on the 39-key function numeric and the 57-key alphanumeric keypad overlays. For help, see “Finding the Special Keys” on page 1-12.

For more help, see the appropriate TE 2000 manual.

## Using the Screen

---

You can use the terminal's screen to view data, run applications, monitor the terminal's status, and perform many other functions. The CGA-compatible screen is a backlit LCD that is configurable up to 21 lines by 31 characters. The screen also supports double-byte characters, user-programmable fonts, and bitmap graphics.



The 243X screen has versatile display features that allow you to resize the screen based on operator preference and work environment. For help, see "Display Spacing" in Chapter 6 of the 2400 Family system manual. Depending on the application, you can also use the viewport feature to move around a full 25-line by 80-character screen.



 The Shift key is built into the terminal's keypad. You can use the Shift key to

- turn the backlight on and off.
- adjust the display contrast.

When you use this key to change the backlight or contrast, these changes are not saved permanently in flash memory.

### To turn the backlight on and off

- Press  .





Turn the backlight on to see the terminal's screen more easily in dimly lit environments. The backlight stays on for the length of time set in the Display Backlight Timeout command as long as there is no keypad or scanning activity or until you press   again. For more information, see "Display Backlight Timeout" in Chapter 6 of the 2400 Family system manual.



**Note:** You use the battery power at a faster rate with the backlight turned on.

### To change the display contrast

- Press  .

Each time you press  , it makes the display contrast one level darker. There are eight contrast levels. If the contrast is at the darkest level and you press  , the contrast changes to the lightest contrast level. For help, see "Display Contrast" in Chapter 6 of the 2400 Family system manual.

## Learning About the Status Icons

You can use the status icons on the right side of the screen to monitor the status of battery power, special keys, and network communications. The status icons only turn on to indicate the current status. When the 243X is off, the icons are also off.

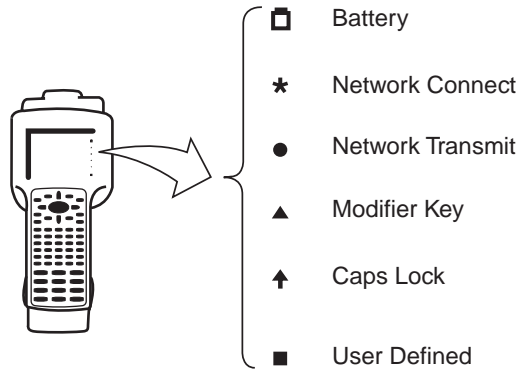

243XU032.eps



**□ Battery** This icon remains off when you have a charged battery pack in the terminal. The icon turns on when there is a low battery charge and the terminal is on. When the terminal beeps once every 15 seconds, replace the battery pack with a charged battery pack or charge the battery pack as soon as possible.

**\* Network Connect** This icon tells you if the 2435 is connected to your network. The Network Connect status icon may be off, blinking, or on.

Protocol	Status Icon Off	Status Icon Blinks	Status Icon On
TCP/IP	Not connected.	Nothing	Connected to an access point.
UDP Plus	Not connected.	Connected to an access point, but not to a DCS 30X.	Connected to a DCS 30X.

When the Network Connect icon is off, you are not connected to the network. Make sure the Network Activate command is enabled and that the terminal is configured correctly for your RF network. Make sure that you are in range of an access point.

In a UDP Plus network, this icon is not instantaneously updated, but it does tell you the communications status the last time data was sent or received from the 2435.

- **Network Transmit** This icon turns on when data is buffered in the RF network interface. The data is either waiting to be transmitted to the DCS 30X or host, or received data has not been accepted by the application on the 2435. When no data is being buffered in the interface, the Network Transmit icon is off.
- ▲ **Modifier Key** This icon indicates that one of the modifier keys, such as , is enabled. When you press another key, the key combination is available to the application. The Modifier icon turns off unless the second key that you pressed is another modifier key that is different from the first one that you pressed.
- ↑ **Caps Lock** This icon turns on when you press  to enable the Caps Lock feature. When you press  again to disable Caps Lock, the icon turns off. If Caps Lock is enabled, this icon remains on until you disable Caps Lock.
- **User Defined** This icon is user defined. You can program this icon to turn on and off for any task or error within your application.









## Learning About the Audio Signals



The terminal has a beeper that provides you with audio feedback as you use the terminal. For example, you hear a beep tone each time you enter or scan a valid command. You can change the beep volume and the beep duration to meet the needs of your working environment.

When you change the beep volume, you also change the keyclick volume if the Keypad Clicker command is enabled. The keyclick is the sound that you hear when you press a key on the terminal.

There are three ways to change the beep volume:

- Press  . Each time you press  , the beep volume becomes one level louder. There are five beep volume levels including off. If the volume is at the loudest level and you press  , the beep volume is turned off. If you press   again, the volume changes to the quietest level.



**Note:** When you use the keypad to change the beep and keyclick volume, the changes are not saved permanently in flash memory. You can save the changes in flash memory later. For help, see “Exiting Screens and Saving Changes” in Chapter 2.

- Use the TRAKKER Antares 2400 Menu System. From the Main Menu, choose Configuration Menu, then Terminal Menu, and then Beeper.
- Use the Beep Volume command. For help, see “Beep Volume” in Chapter 6 of the 2400 Family system manual.

This table lists each beep sequence and describes the situations under which they occur.

<b>Beep Sequence</b>	<b>Situation</b>
High beep	You entered valid data, you entered a valid command, the terminal decoded a label, or the terminal decoded the last row of a two-dimensional bar code.
Three low beeps	You entered or scanned an invalid command or data.
Four low beeps	You booted the terminal and the power-on self test (POST) was successful.
Low beep, high beep, low beep, high beep	You booted the terminal and the POST failed. For help, see "Problems While Operating the Terminal" in Chapter 4.
Click	You pressed a key and the Keypad Clicker command was enabled. To disable the keyclick, see "Keypad Clicker" in Chapter 6 of the 2400 Family system manual.
Low beep (every 15 seconds)	The battery pack is low. You must replace or recharge the battery pack. For help, see "Using the Terminal's Battery Pack" on page 1-8.

## ***Using the Terminal's Serial Port***

---

Serial ports, also called COM (communications) ports, are locations from which data can be passed into and out of the terminal. The 243X supports RS-232 serial communications.

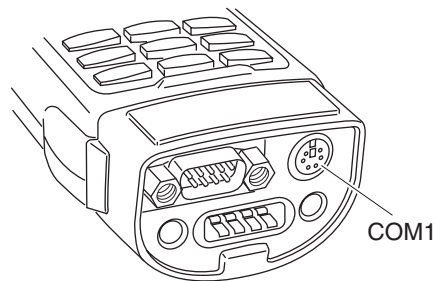

243XU008.eps

<b>Port</b>	<b>COM Port Designation for Applications</b>
COM1	Use for serial port communications on the terminal. You can use a serial cable to connect this terminal to another serial device, such as a modem, a PC, or a printer. If you have a serial connector module, you can also use the input device connector as COM1. For help, see "Learning About the Connector Modules" on page 1-23.



## Port COM Port Designation for Applications



**Note:** The serial/power connector and the input device connector lead to the same serial port, COM1. Do **not** connect more than one serial device to the 243X.

RF (NET) Use for RF communications on the 2435. The Trakker Antares PSK functions use NET to designate the RF network port.

## Using the Terminal's Scanner



### Warning

*Do not look directly into the window area or at a reflection of the laser beam while the laser is scanning. Long-term exposure to the laser beam can damage your vision.*

### Avertissement

*Ne regardez pas directement la réflexion d'un rayon laser ou dans la fenêtre du laser lorsque celui-ci est en opération. Si vous regardez trop longtemps un rayon laser, cela peut endommager votre vue.*

You can use the scanner to scan and enter bar code data. When you press the Scan button or one of the side scan buttons, the scanner emits a beam of laser light that is visible on the bar code label as you scan it. The terminal decodes the bar code and enters the data or command you scanned.



**Note:** The Scan button on the keypad and the side scan buttons on the terminal do not activate the tethered input device that may be connected to the terminal.

When you unpack the 243X, these three bar code symbologies are enabled:

- Code 39
- Code 128
- UPC/EAN

To scan other bar code symbologies, you must enable them on the 243X. For help, find the symbology in Chapter 6 of the 2400 Family system manual.

### To scan a bar code label with the scanner

1. Press  to turn on the terminal.
2. Hold the terminal at a slight angle a few inches from the bar code label. The scanner must be pointing toward the label.



**Note:** If you have a long range or extra long range scanner, you may need hold the terminal further away.

3. Push the Scan button on the keypad or one of the side scan buttons on the terminal. Direct the beam so that it falls across all bars in the bar code label. When the terminal successfully reads the label, you will hear a high beep.

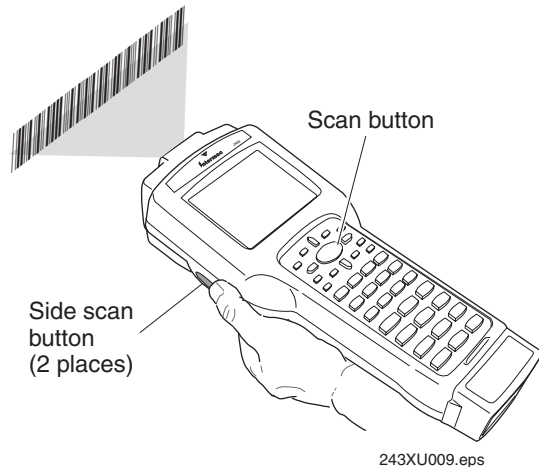

The green Good Read LED turns on when you successfully scan a bar code label with the integrated scanner or an input device that is connected to the terminal. This LED turns off after 2 seconds unless you start scanning another label.

4. Release the Scan button.



**Note:** You can configure scanning options to scan multiple bar code labels without pressing the Scan button each time. For help, see “Scanning Options” on page 1-24.

To successfully read a bar code label, the laser beam in the scan module must see all the bars in a label and a clean, non-printed space, or “quiet zone,” at each end of the label.

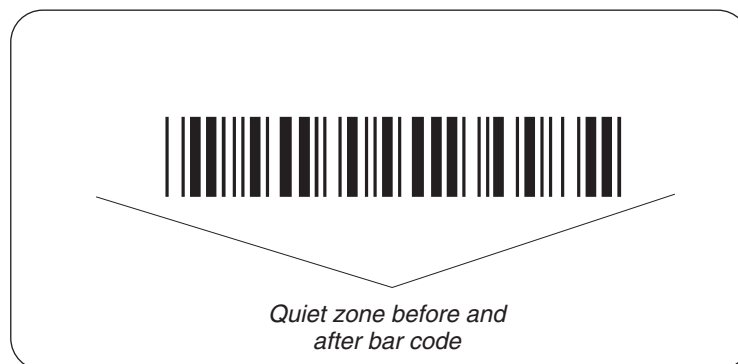

Use the following guidelines to achieve a successful scan:

- Hold the terminal so that the scanner is pointing toward the bar code label. Tilt the terminal up or down slightly (20 degrees).
- Optimum scan angles vary with the type and print quality of the bar code label, the distance of the scanner from the label, and the lighting in the area.
- Do not scan the bar code label “straight on.” In a 2-degree conical “dead zone” directly above the label, the laser beam may reflect back into the scanner window and prevent the terminal from reading the label. At certain angles and straight on, you may not see the laser beam.

## Learning About the Connector Modules

The 243X has two different connector module options.

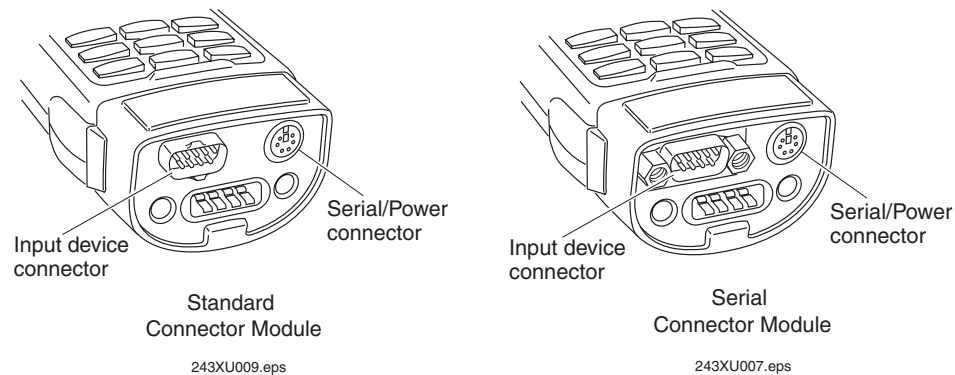

**Standard Connector Module** The input device connector on the standard connector module supports non-decoded input devices. For a list of these input devices, see “Input Devices and Cables” in Appendix A.

**Serial Connector Module** The input device connector on the serial connector module supports decoded input devices. For a list of these input devices, contact your local Intermec sales representative. You can also use the input device connector to connect to a serial device. For help, see “Connecting to a Serial Device or Network” on page 1-24.



**Note:** The serial/power connector and the input device connector lead to the same serial port, COM1. Do **not** connect more than one serial device to the 243X.

The 243X supports different bar code symbologies depending on the type of input device connected to the terminal. For a list of these symbologies, see “Bar Code Symbologies” in Appendix A.

---

## Connecting an Input Device

1. Use the appropriate interface cable to attach an input device to the input device connector on the connector module. For a list of supported input devices and cables, see “Input Devices and Cables” in Appendix A.
2. Configure the Scanner Selection command and select the input device that is connected to the terminal. For help, see “Scanner Selection” in Chapter 6 of the 2400 Family system manual.



**Note:** You must configure the Scanner Selection command. If this command is not defined for the appropriate input device, the scanner trigger on the input device may activate the integrated scanner on the terminal.

---

## Scanning Options

After you connect an input device to the 243X, you can modify the following scanner command options to meet your needs:

- Decode Security
- Scan Ahead
- Scanner Mode
- Scanner Redundancy
- Scanner Selection
- Scanner Timeout
- Scanner Trigger

For more information about these commands, see Chapter 6, “Configuration Command Reference,” in the 2400 Family system manual.

---

## Connecting to a Serial Device or Network

You can physically connect the 243X to a serial device, such as a host computer or printer, through the serial/power connector using a serial adapter cable. If you have a serial connector module, you can use either the serial/power connector or the input device connector to connect to a serial device.

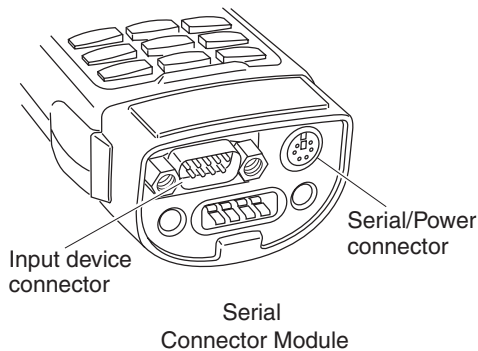

243XU007.eps



**Note:** The serial/power connector and the input device connector lead to the same serial port, COM1. Do **not** connect more than one serial device to the 243X.

#### To connect the 243X to a serial device using the serial/power connector

1. Attach a serial device to the serial adapter cable (Part No. 216-807-001) (sold and ordered separately).
2. Connect the serial adapter cable to the serial/power connector on the 243X.

#### To connect the 243X to a serial device using the input device connector

1. Attach a serial device to the RS-232 null-modem serial cable (Part No. 070268) (sold and ordered separately).
2. Connect the serial cable to the input device connector on the 243X.

You can transfer data between the 243X and the serial device. For help, see “Using Serial Communications on the Terminal” in Chapter 3.

## Defining the Terminal's Drives

The terminals come with the following memory and drives. On each drive, filenames are customer defined using eight characters with a three-character extension. You cannot define any subdirectories.

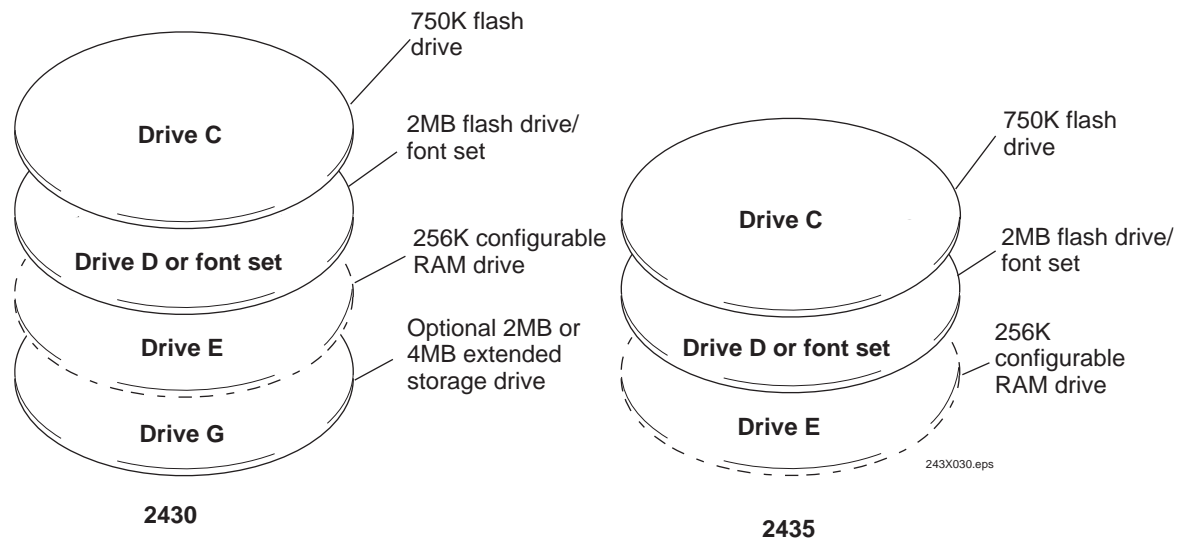

**Drive C** is a 2MB flash drive. You can use up to 750K of this flash drive to store up to 128 files on drive C. Applications must be stored on drive C. You use standard ANSI C library interface definitions to access the information on this drive.

**Drive D or font set** is 2MB drive of flash memory that you can configure as drive D. Use this flash drive to store large lookup tables and data files. You can store up to 128 files. You can also order the flash memory to come pre-loaded with a double-byte font set. To configure this flash memory, see "Flash Memory Configuration" in Chapter 6 of the 2400 Family system manual.

**Drive E** is a configurable RAM drive (up to 256K). The contents of this drive are erased when you boot or reset the terminal. You can store up to 128 files on drive E, and you can access these files using standard ANSI C functions. By default, the RAM drive is not configured and the memory is available for programmable (Malloc) memory allocations. To configure the RAM drive, see "RAM Drive Size" in Chapter 6 of the 2400 Family system manual.

**Drive G (optional)** is an optional 2MB or 4MB extended storage drive that is only available on the 2430. Use this drive to store large lookup tables and data files. You can store up to 128 files on drive G, and you can access these files using standard ANSI C functions.

**Malloc/free memory** On the terminals, applications are customer defined. You have 512K total RAM that you can use for the application execution space. You can also configure this RAM to be the RAM drive (up to 256K). The remaining RAM is the Malloc/free memory pool.

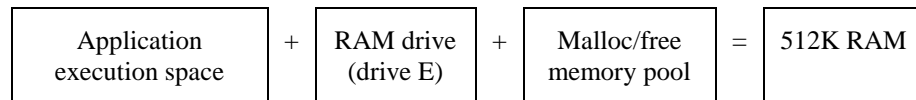

## ***Using the Terminal for the First Time***

---

Before you can use the 243X for the first time, you must perform certain steps, such as setting the time and date. You can find this information throughout this user's manual. However, if you want to start using the terminal immediately, see the *Trakker Antares 243X Hand-Held Terminal Quick Start Guide* (Part No. 071792).

### **To use the 243X for the first time**

1. Unpack the terminal and documentation.
2. Charge and install the battery pack (sold separately). For more information about batteries, see "Using the Terminal's Battery Pack" on page 1-8.
3. Press  $\text{I/O}$  to turn on the terminal. For more information about the keypad, see "Using the Keypad" on page 1-11.
4. (Optional) Set the time and date. For help using the TRAKKER Antares 2400 Menu System, see "Configuring the Terminal With the Menu System" in Chapter 2.

5. Configure the serial port parameters. For more information, see “Using Serial Communications on the Terminal” in Chapter 3.
6. (2435 only) Configure the RF parameters. For more information, see “Using RF Communications on the Terminal” in Chapter 3.
7. Enable the bar code symbologies that you want to be able to scan. For more information, see Chapter 6, “Configuration Command Reference,” in the 2400 Family system manual.
8. Exit the menu system and save your configuration changes to flash memory. For help, see “Exiting the Menu System” in Chapter 2.

When you are done with these steps, the default application or TE 2000 application that is loaded on your terminal will start. You are ready to use the terminal.





# 2

## ***Configuring the Terminal***



*This chapter describes the different methods that you can use to configure the 243X and its memory and drives. It also explains how to configure the terminal using the TRAKKER Antares 2400 Menu System and the clone application.*

## ***How to Configure the Terminal***

---

You can customize many of the operating characteristics of the 243X terminals, such as the volume of their audio signals and the bar code symbologies they decode. These characteristics are controlled by configuration parameters. The values you set for these configuration parameters determine how the terminal operates. To learn about each parameter, see Chapter 6, “Configuration Command Reference,” in the 2400 Family system manual.

You can configure the terminals by using any of these methods:

**Use the TRAKKER Antares 2400 Menu System** You can use the menus and screens of the TRAKKER Antares 2400 Menu System to view the current configuration and change the configuration parameters. For help, see “Configuring the Terminal With the Menu System” on page 2-4.

**Scan bar code labels** You can change the terminal’s configuration parameters by scanning Code 39 or Code 93 bar code labels that contain configuration commands. This method is a fast, easy way to change the terminal’s configuration. You can scan the bar code labels in this manual and the 2400 Family system manual, or you can create your own bar code labels. For help, see Chapter 2, “Configuring the Terminals,” in the 2400 Family system manual.

**Send commands through the serial port** You can change the terminal’s configuration parameters by sending commands from a host computer or PC that is connected to the terminal’s serial port. For help, see Chapter 2, “Configuring the Terminals,” in the 2400 Family system manual.

**Send commands through the RF port (2435 only)** You can change the terminal’s configuration parameters by sending commands through the UDP Plus or TCP/IP network. This method lets you configure one or more terminals at the same time. For help, see Chapter 2, “Configuring the Terminals,” in the 2400 Family system manual.

**Use the clone application** You can set the terminal’s configuration parameters by using the clone application to copy configuration parameters from one 243X to another 243X. This method is a fast, easy way to configure your new 243X with the same parameters as your existing 243X. For help, see “Configuring the Terminal With the Clone Application” on page 2-11.

---

### ***About the Configurations***

The terminal uses three configurations: current, active, and default. Having separate current and active configurations lets you control the active configuration while letting each operator make some changes to the current configuration, such as scanning a bar code to change the beep volume.

**Current** This configuration, also called the runtime configuration, uses the configuration that is saved in RAM. When you change a parameter by using the menu system, by scanning a bar code, by sending it from a host application, or by sending it from the DCS 30X, the terminal updates the current configuration. The changes to the current configuration are lost when you boot or reset the terminal.

**Active** When you update the flash memory, the terminal copies the current configuration to the active configuration. The active configuration is the configuration that the terminal uses when you boot or reset the terminal.

**Default** This configuration is the factory default configuration. To restore the default configuration, see “Restoring the Terminal’s Default Configuration” in Chapter 2 of the 2400 Family system manual.





## ***Configuring the Terminal With the Menu System***

---

The TRAKKER Antares 2400 Menu System is a menu-driven application that lets you configure the terminal, manage files, view system information, and run diagnostics. You can access the TRAKKER Antares 2400 Menu System while running any application.

When you are using the menu system, you may not see a parameter until you set a value for another key field. For example, EOM is a key field when you configure the Configurable protocol. That is, several fields are invalid (do not appear) until you enable EOM. You also may not see a parameter if your terminal does not support a particular feature.

### **To access the TRAKKER Antares 2400 Menu System**

- Press   **2** **4** **8** (57-key keypad),   **2** **4** **8** (39-key keypad), or scan this bar code:

Menu System



\*..\*

The Main Menu appears, displaying four menu options.

**Configuration Menu** Choose this menu to configure bar code symbologies, network and communications parameters, serial port parameters, and the terminal’s operating characteristics. In the Symbologies Menu, active symbologies are noted with an asterisk (\*).

**Diagnostics Menu** Choose this menu to run hardware, software, or system diagnostics to help analyze and fix problems. You can also view battery and system information. For help, see Chapter 4, “Running Diagnostics” in the 2400 Family system manual.

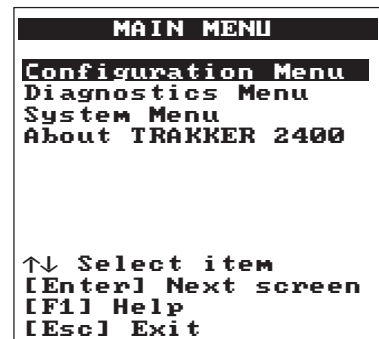

243XU050.eps

**System Menu** Choose this menu to manage files, load the default configuration, set the time and date, store the terminal's configuration in flash memory, and upgrade the firmware.

**About TRAKKER 2400** Choose this option to see the part number, firmware version, radio, and RF protocol (UDP Plus or TCP/IP) that is loaded on the terminal. You may need this information if you are working a problem with an Intermec representative.

### The TRAKKER Antares 2400 Menu System at a Glance

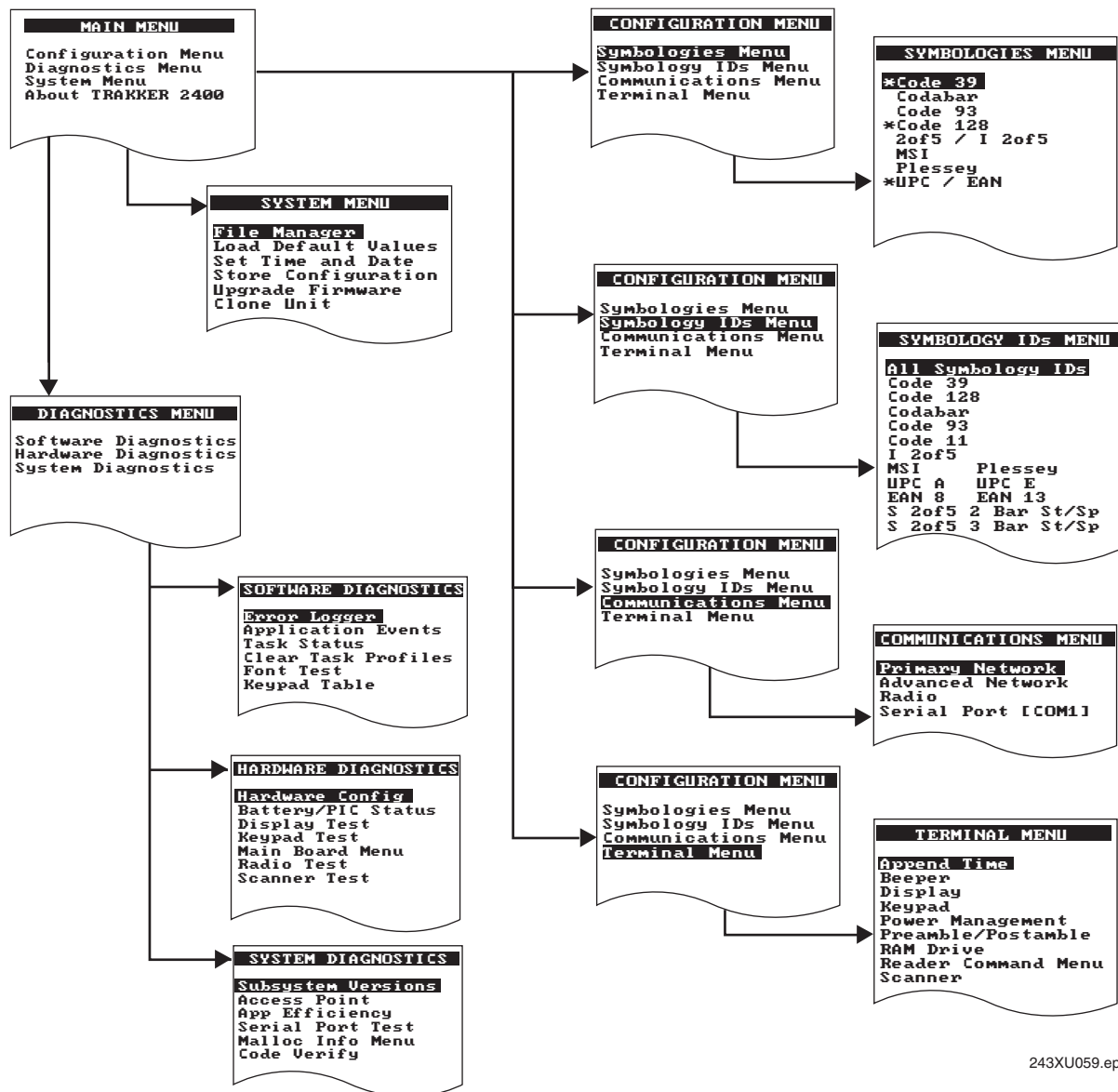

243XU059.eps

---

## Accessing Online Help

The TRAKKER Antares 2400 Menu System provides online help for the menus and commands.

### To access a help screen

- Press **F1** to access a help screen.

### To exit a help screen

- Press **Esc** to exit the help screen.

---

## Selecting Menus and Commands

A menu consists of a list of secondary menu items or commands. From the Main Menu, you can press **↑** or **↓** to select a menu, and then press **ENTER**.

For example, from the Main Menu, press **↓** **↓** **ENTER** to display the System Menu:

```
MAIN MENU
Configuration Menu
Diagnostics Menu
System Menu
About TRAKKER 2400

↑↓ Select item
[Enter] Next screen
[F1] Help
[Esc] Exit
```

243XU050.eps

```
SYSTEM MENU
File Manager
Load Default Values
Set Time and Date
Store Configuration
Upgrade Firmware
Clone Unit

↑↓ Select item
[Enter] Next screen
[F1] Help
[Esc] Exit
```

243XU051.eps

---

## Filling In Fields

Screens contain fields into which you can enter data. In the TRAKKER Antares 2400 Menu System, this data configures the terminal. You can press **↑** or **↓** to choose a field on a screen and then enter data.

There are two types of fields: toggle fields and entry fields.

- In a toggle field, press **←**, **→**, or **SPACE** to view the options for that field.
- In an entry field, type a value into the field. To edit the data in an entry field, use the **←**, **→**, or **↔** keys. You can also use the Delete (DEL) and Insert (INS) keys to edit an entry field.

For example, the Primary Network screen has toggle and entry fields. The Activate field is a toggle field. Press  to toggle between Disabled and 802.11 DS or OpenAir. The Host IP Address and Terminal IP Address fields are entry fields. You type a value into the field for each IP address.

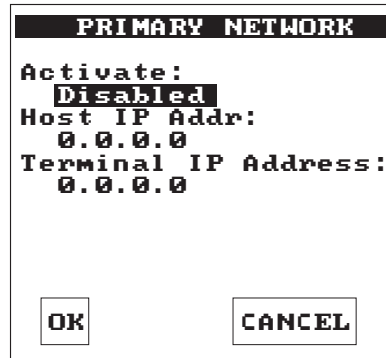

243XU062.eps

## Marking Check Boxes

Screens may contain check boxes. Check boxes are used when you can select more than one option at a time. To mark or clear check boxes, press . For example, press  or  to choose the Backspace check box and press  to clear the check box. The Backspace command is now disabled.

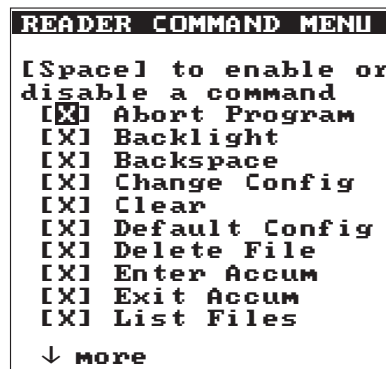

243XU053.eps

## Entering ASCII Control Characters

You can include ASCII control characters in a postamble or preamble by using the TRAKKER Antares 2400 Menu System. For a definition of the postamble or preamble, see Chapter 6, "Configuration Command Reference," in the 2400 Family system manual.

You can configure the postamble or preamble to be characters from the full or extended ASCII character sets. For example, the Field Exit code (Ü) for 5250 terminal emulation is an extended ASCII character that is often configured as the postamble.



**Note:** For help using the 5250 Field Exit code, see the appropriate TE manual.

### To enter ASCII characters for a preamble or postamble

1. Decide which ASCII control character you want to set for the preamble or postamble. Look up the control character in the "Full ASCII Table" in Appendix B of the 2400 Family system manual and find the two-digit hexadecimal number. For example, ETX in the Full ASCII Table is the hexadecimal value 03.

To enter an extended ASCII character, look up the two-digit hexadecimal number for the character in the "Trakker Antares Terminal Font Set" in Appendix C of the 2400 Family system manual. For example, Ü (the 5250 Field Exit code) has the hexadecimal value 9A.

2. Use the TRAKKER Antares 2400 Menu System to configure a preamble or postamble. From the Main Menu, choose Configuration Menu.
3. From the Configuration Menu, choose Terminal Menu.
4. From the Terminal Menu, choose Preamble/Postamble.
5. Move the cursor to the field for the preamble or postamble.

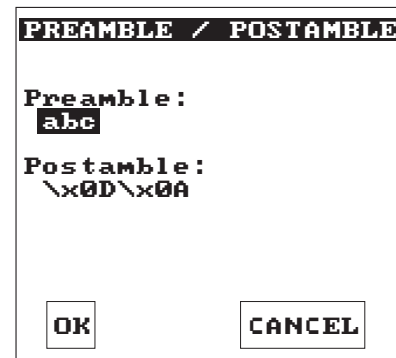

243XU057.eps



6. Type the control character, extended ASCII character, or escape character sequence in the preamble or postamble field.

- To type a control character or extended ASCII character in the preamble or postamble field, use this syntax:

```
\xhh
```

where *hh* is the two-digit hexadecimal number for the control character or extended ASCII character. For example, to enter ETX as a preamble, type:

```
\x03
```

To enter Û (the 5250 Field Exit code) as the postamble, type:

```
\x9A
```

- To type an escape character (backslash) in the preamble or postamble field, you must type two backslashes. The application ignores the first backslash (\) character and saves the next characters. For example:

Enter These Characters	Preamble/Postamble Saved
\\	\
\\k	\k
\	no data

7. Press **ENTER** or choose OK to save your changes and exit the screen.

For help exiting the menu system, see the next two sections, “Exiting Screens and Saving Changes” and “Exiting the Menu System.”

---

## Exiting Screens and Saving Changes

When you exit a screen, you can save or discard your changes:

Task	Description
To exit a screen and save the changes	Choose OK and press <b>ENTER</b> . You can also press <b>ENTER</b> with the cursor positioned anywhere except on the Cancel button.
To exit a screen and discard the changes	Choose Cancel and press <b>ENTER</b> . You can also press <b>Esc</b> with the cursor in any field.

---

## Exiting the Menu System

1. Press **Esc** until you exit the TRAKKER Antares 2400 Menu System. If you have made any changes to the current configuration, the next screen prompts you to save the configuration parameters that are currently enabled on the terminal to RAM.

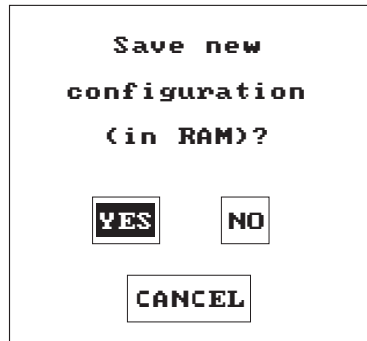

243XU052.eps

2. Choose Yes and press **ENTER** to save your changes in RAM and update the current configuration on the terminal. The Main Menu appears.

Choose No and press **ENTER** to exit without changing the configuration. The Main Menu appears.

Choose Cancel and press **ENTER** to return to the previous menu or screen.

3. From the Main Menu press **Esc**. If you have made any changes, the next screen prompts you to store the changes in flash memory.

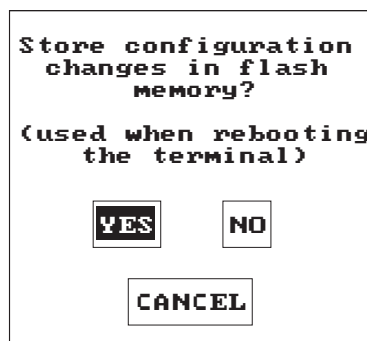

243XU054.eps



**Note:** You can also save the current configuration in flash memory by choosing the Store Configuration command from the System Menu. For help, see “Saving Configuration Changes in Flash Memory” in Chapter 2 of the 2400 Family system manual.

4. Choose Yes and press **ENTER** to save your changes in flash memory. The terminal saves the current configuration as the active configuration. The Exiting TRAKKER Antares 2400 Menu System screen appears.

Choose No and press **ENTER** to exit without saving. The terminal continues to use your changes until you boot or reset the terminal. The Exiting TRAKKER Antares 2400 Menu System screen appears.

Choose Cancel and press **ENTER** to return to the Main Menu.



243XU055.eps

5. Choose OK and press **ENTER** to exit the TRAKKER Antares 2400 Menu System. Choose Cancel and press **ENTER** to return to the Main Menu.

After you exit the menu system, the terminal will resume the application you were running when you started the menu system.

## ***Configuring the Terminal With the Clone Application***

---

The clone application uses XMODEM-1K protocol to copy configuration parameters and applications from one 243X (server terminal) to another (client terminal). The server and client terminals must have the same

- hardware configuration.
- version of firmware.
- version of the clone application.

The clone application copies all configuration parameters, except for terminal IP address, from the server terminal to the client terminal. You must configure the terminal IP address separately. The clone application also removes all existing files on the client terminal's C drive, and replaces them with the files on the server terminal's C drive.

For more information about upgrading firmware, see Chapter 2 in the 2400 Family system manual. For more information about downloading applications, see “How to Download and Run Applications” in Chapter 3 of the 2400 Family system manual.

### **To clone configuration parameters and applications**

1. Make sure the server terminal's configuration is saved in flash memory by scanning this bar code:

Save Configuration in Flash Memory



\*.+1\*

2. Load all applications and files to clone on the server terminal's C drive.
3. Run the clone application on the server unit.
  - a. From the Main Menu, select System Menu, and then select Clone Unit.
  - b. Select Server.
4. Connect COM1 on the server terminal to COM1 on the client terminal using the cloning cable (Part No. 216-909-001) (sold and ordered separately).

The cloning process automatically begins once you connect the terminals. The client terminal lists the applications when cloning is complete.

5. On the server terminal, press **Esc** to exit. You can also configure another terminal by connecting it to the server terminal.

## ***Configuring Drives and Memory on the Terminal***

---

The 243X come with a 750K flash drive (C), 512K RAM reserved for applications, and an additional 2MB extended flash memory. You can customize the terminal to your needs by configuring

- up to 256K of the 512K RAM as a RAM drive.
- the additional 2MB flash memory to either store double-byte fonts or to use as a 2MB drive.

### ***Configuring the RAM Drive***

The 243X has a total of 512K RAM for the application execution space. You can configure up to 256K of the total 512K application execution space as a RAM drive. If the RAM drive is configured, your application execution space is reduced by the amount of the RAM drive.

For example, if your application size is 64K and drive E is configured as a 256K RAM drive, you are using 320K of the 512K application execution space. The application uses the remaining 192K of RAM as a Malloc/free dynamic memory pool.

By default, the RAM drive is not configured and the memory is available for applications. You can configure the size of the RAM drive (E) and use drive E to temporarily store data and files (up to 128 files).

After you disable or configure the RAM drive, you must save the configuration in flash memory and boot the terminal for the change to take effect. For help, see “Saving Configuration Changes in Flash Memory” in Chapter 2 of the 2400 Family system manual.



**Note:** When you boot or reset the terminal, all files on the RAM drive are destroyed.

For help configuring the RAM drive, see “RAM Drive Size” in Chapter 6 of the 2400 Family system manual.

---

## **Configuring Flash Memory**

You can use the 2MB extended flash memory either to store double-byte fonts or to use as a 2MB drive. By default, the 2MB of flash memory is configured to store a double-byte font set (up to 2MB maximum).

If you are not using double-byte fonts, you can configure the 2MB flash memory as a storage drive (D). If you configure the flash memory as drive D, use this drive to store large lookup tables and data files (up to 128 files).



**Note:** You can only configure the 2MB flash memory as a drive or to store fonts. You cannot use the space for both. If you configure drive D, you cannot store a font in flash memory.

For help configuring flash memory, see “Flash Memory Configuration” in Chapter 6 of the 2400 Family system manual. For help loading double-byte fonts, see “Loading Double-Byte Fonts” in Chapter 2 of the 2400 Family system manual.



## ***Operating the Terminal in a Network***





*This chapter describes how to install and configure the 243X in a serial or RF network. It also explains how the 243X fits into a particular network and how to use serial or network communications.*

## How the Terminals Fit Into Your Network

The 2430 and 2435 are versatile hand-held terminals that you can easily add to your network or distributed data collection system.

The terminals have a serial port to transmit data to and receive data from a host computer or PC through RS-232 serial communications. You can use the 2430 and the 2435 as end devices in your wired network. You can also use the 2435 as an end device in the RF network.

### 243X in a Wired Network

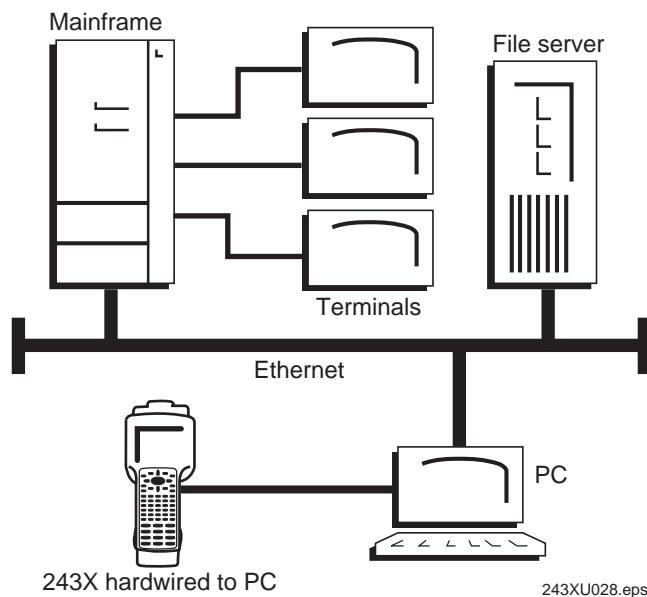

**UDP Plus Network** In a UDP Plus RF network, the 2435 communicates with a host computer through the DCS 30X. The DCS 30X translates UDP Plus packets on the RF network into TCP/IP packets on the wired network and vice versa. The access point acts as a bridge to allow communications between the wired network and the RF network.

**TCP/IP Direct Connect Network** In a TCP/IP network, the 2435 communicates with a host computer directly using TCP/IP for the RF protocol. The access point acts as a bridge to allow communications between the wired network and the RF network.

---

***2435s in a UDP Plus Network or a TCP/IP Direct Connect Network***

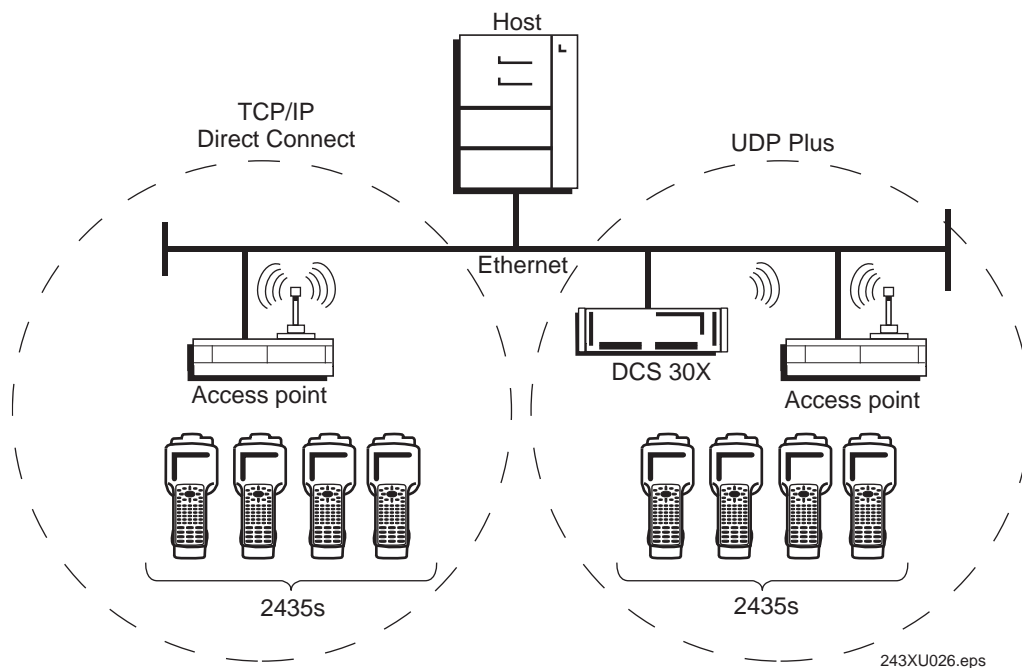

**Multiple Subnetworks (UDP Plus)** In a UDP Plus network, you can install the 2435 terminals, access points, and DCS 30X as shown in the next illustration. All the terminals and access points in this illustration communicate with the DCS 30X at IP address 192.9.175.7. If you are using access points, a terminal can roam across subnetworks.

If you are using the 011X Access Points, a terminal can only communicate with access points that are in the same subnetwork. In this illustration, if you substituted the 011X Access Points for the 21XX access points, the terminal at IP address 192.9.200.5 could not communicate with the DCS 30X on the 192.9.175.X subnetwork.

### 2435s in Multiple Subnetworks (UDP Plus)

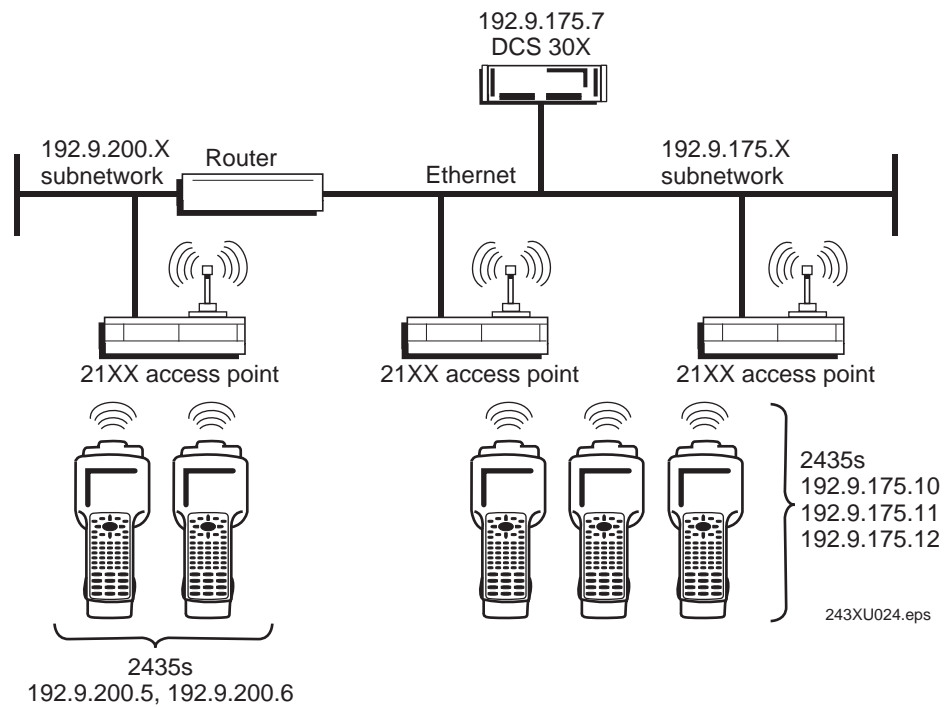

**Multiple Subnetworks (TCP/IP)** In a TCP/IP network, you can install the 2435 terminals and access points as shown in the next illustration. All the terminals and access points in this illustration communicate with the host at IP address 192.9.175.7. If you are using 21XX access points, a terminal can roam across subnetworks.

If you are using the 011X Access Points, a terminal can only communicate with access points that are in the same subnetwork. In this illustration, if you substituted the 011X Access Points for the 21XX access points, the terminal at IP address 192.9.200.5 could not communicate with the host on the 192.9.175.X subnetwork.

---

**2435s in Multiple Subnetworks (TCP/IP)**

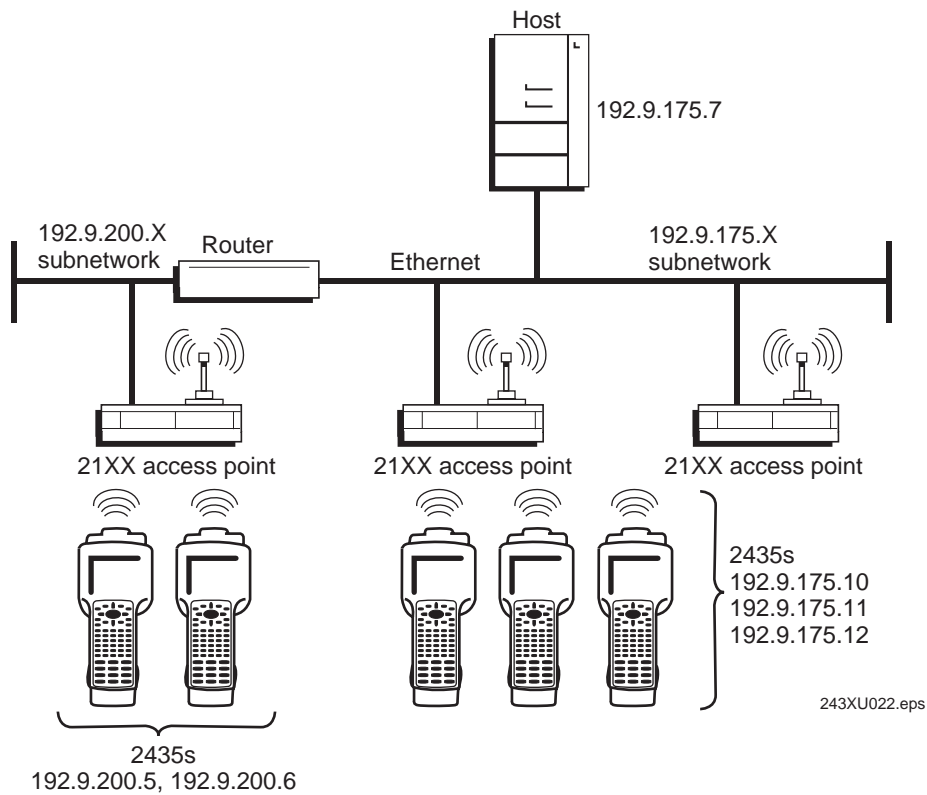

**Communicating Across Subnetworks (UDP Plus)** You can install the 2435 terminals and access points in one subnetwork and install the DCS 30X or host in another subnetwork. In this network, you must configure additional network parameters (default router and subnet mask). The next illustration shows the DCS 30X in another subnetwork from the terminals.

### 2435s Communicating Across Subnetworks (UDP Plus)

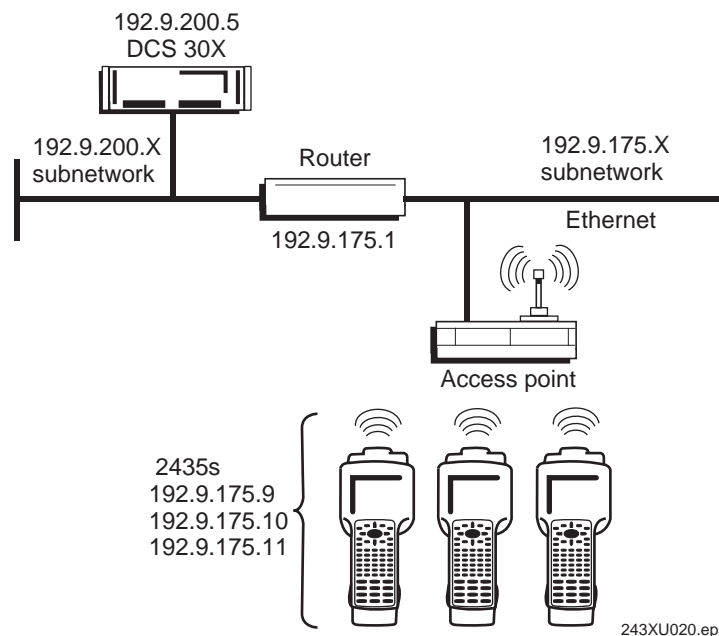

## Using Serial Communications on the Terminal

The 243X has a serial port to transfer data to and from another device, such as a printer, modem, or PC, using serial communications. Before you can use serial communications, you must perform these steps:

1. Connect the terminal to a serial device or network. For help, see “Connecting to a Serial Device or Network” in Chapter 1.
2. Choose a communications protocol. For help, see the next section, “Choosing a Communications Protocol.”
3. Configure the serial port parameters to allow the terminal to communicate with a host computer or serial device in a wired network. For help configuring the terminal, see Chapter 2.

Depending on the protocol you choose in Step 2, you must set some or all of the serial port parameters to have the terminal communicate with a host computer or serial device in a wired network. The values you set for the terminal's serial port parameters must match the values set for the host's (or other device's) serial port parameters.

---

## ***Choosing a Communications Protocol***

After you connect the 243X to a host computer or other serial device, you are ready to configure the serial port parameters on the two devices. The terminal uses a communications protocol and XMODEM or YMODEM to handle data communications through the serial ports.

You can configure a different communications protocol for each COM port. The terminal's built-in file operations use XMODEM or YMODEM for file transfer.

Communications protocols determine exactly how data is transmitted between the terminal and the connected device. Each protocol has parameters you can set, such as baud rate and parity. Both the terminal and the connected device must use the same protocol and parameter settings to communicate properly. For help with protocols, see the *Data Communications Reference Manual* (Part No. 044737).

### ***Binary Protocol***

Binary protocol has no protocol. Characters are sent and received without being altered. The Data Link Escape character (DLE) is **not** inserted before any character, and DLE characters are not stripped out of the incoming data stream. No protocol characters, such as EOM or SOM, are added. Binary mode supports CTS/RTS flow control.

You can configure the following serial port parameters:

- Baud rate
- Data bits
- Parity
- Stop bits
- Flow control

### ***Configurable Protocol***

Configurable protocol is based on Intermec's Polling Mode D protocol except that you have the option to change some of the serial port protocol parameters or remove specific events from the protocol, such as poll or handshake.

You can configure the following serial port parameters:

- Baud rate
- Data bits
- Parity
- Stop bits
- Flow control
- EOM (End of Message)
  - Configuration commands via serial port
  - LRC
  - SOM (Start of Message)
  - Handshake (enabled or disabled)
    - Poll (Polling) (enabled or disabled)
    - Timeout Delay

Configurable protocol uses EOM to determine one of the following serial communications modes.

**Character mode** When EOM is disabled, the terminal communicates in Character mode processing each character. Character mode supports both XON/XOFF and CTS/RTS flow control.

**Frame mode** When EOM is enabled, the terminal communicates in Frame mode. When a terminal sends a packet, it adds a protocol character. When a terminal receives a packet, it strips any protocol characters before it sends the information to the terminal application. Frame mode supports both XON/XOFF and CTS/RTS flow control. In Frame mode, you can also configure the following serial port parameters:

- Configuration commands via serial port
- Handshake
- LRC
- SOM

After you enable Handshake, you can define poll and timeout delay.

### ***Master Polling Protocol***

Master Polling Mode D protocol requires the terminal to ask the downline serial device for data it may have (polling) and to request to send data to the serial device (selecting). There is no automatic polling, so your application must poll periodically for data.

Before each transmit operation, the terminal issues the SEL sequence for the device addressed and sends the data if an acknowledge is received. Before each receive operation, the terminal issues a poll sequence and waits for data or the RES character (no data is available to send).

You can configure the following serial port parameter:

- Baud rate

### ***Point-to-Point Protocol***

Point-to-Point protocol is not directly supported on the terminals. However, you can simulate this protocol by setting the protocol to Configurable and configuring these parameters:

- Baud rate
- Data bits
- Parity
- Stop bits
- Flow control
- EOM (Set EOM1 to \x0D, which is <CR>, and set EOM2 to \x0A, which is <LF>)
- LRC (Disable)
- Handshake (Disable)

With this protocol, you cannot configure values for intercharacter delay, turnaround delay, and timeout delay. This protocol supports CTS/RTS flow control only.

### ***Polling Mode D Protocol***

Polling Mode D protocol requires the host computer to ask the terminal for data it may have (polling) and to request to send data to the terminal (selecting). This protocol uses an RS-232 interface and implements the user interface through reader commands. Polling Mode D also supports XON/XOFF and CTS/RTS flow control.

You can configure the following serial port parameters:

- Baud rate
- Flow control



## Using RF Communications on the Terminal

---

**Caution**

*Make sure all components with antennas are at least 30 cm (1 ft) apart when power is applied. Failure to comply could result in equipment damage.*

**Conseil**

*Assurez-vous que la distance entre tous les éléments avec antennes soit d'au moins 30 centimètres (un pied) avant de faire la connexion avec l'alimentation électrique, faute de quoi vous risquez d'endommager votre installation.*

The 2435 has an internal antenna to transfer data using RF communications. Before you can use RF communications, you must perform these steps:

1. Plan and prepare your RF network. For help, see the next section, “Planning the Network Connection.”
2. (UDP Plus network only) Configure the DCS 30X. For help, see “Configuring the DCS 30X” on page 3-12.
3. Configure the access points. For help, see “Configuring the Access Points” on page 3-12.
4. Configure the network parameters on each terminal in the network.

The set of network parameters you must configure depends on whether you install the terminal on the same subnetwork as the DCS 30X or host (TCP/IP) or on a different subnetwork. For help determining which network parameters you must configure, see “About the Network Parameters” on page 3-14.

---

### **Planning the Network Connection**

To use the 2435 in the RF network, you need these minimum requirements:

- DCS 30X (UDP Plus network)
- Access point

When you first consider purchasing a wireless data collection system, an Intermec representative works with you to perform a site survey at your facility. The site survey analyzes the range of radio frequency devices in your facility and determines the placement of the access points. The site survey ensures that the coverage of each access point overlaps to provide uninterrupted wireless access at any location within the building. This manual assumes that a site survey is complete and the access points are installed in your facility.

You must work with your network administrator to plan and assign the IP address for each device in the RF network. You must assign and set the IP address for each access point (RF) and each 2435. If you are using a UDP Plus network, you must also assign an IP address to the DCS 30X.

---

## ***Configuring the DCS 30X***

The DCS 30X supports and manages communications with other devices in the UDP Plus network. When you install and configure the DCS 30X, you identify the host computers and 2435 terminals in your network. The terminals communicate using a reliable RF protocol (UDP Plus) to the DCS 30X. The DCS 30X translates UDP Plus to a reliable wired protocol (TCP/IP) and sends the data to the host. For more information, see the user's manual for the DCS 30X.



**Note:** You can use a 2435 running TCP/IP and the DCS 30X in a pass-through network. You establish a direct TCP/IP socket connection from the 2435 to the host through the server.

To allow the 2435 to communicate with the DCS 30X, you must perform these tasks on the server:

- Define the host communications parameters, which includes the physical connection (network adapter cards) to the host.
- Configure the UDP Plus network.
- Assign an IP address to each 2435. If your DCS 30X is operating as a DHCP (Dynamic Host Configuration Protocol) server, you also can leave the default terminal IP address as 0.0.0.0 to enable the 243X as a DHCP client. The 243X can receive terminal IP addresses dynamically from the DHCP server. For help, see “DHCP (Terminal)” in Chapter 6 of the 2400 Family system manual.
- Enable all 2435 terminals.
- Define the host environment parameters, which includes configuring for terminal emulation or client/server applications.

To use dcBrowser, you do not define the host environment parameters. You must

- create an HTML application.
- configure the dcBrowser gateway.

---

## ***Configuring the Access Points***

Access points act as bridges to provide communications between the wired network and the RF (UDP Plus or TCP/IP) networks. After you configure the network, you can collect data anywhere within range of the access points in the wireless network. When you move out of range of one access point, the 2435 automatically searches for other access points to continue the network connection.

If you are out of range of all access points in the network, the data is stored in the terminal's radio buffer. The Network Connect status icon turns off. You can continue to collect data until the radio buffer is full. When the buffer is full, the application displays a communication timeout status. When you move back into range and network communications are re-established, the data in the radio buffer is transmitted to the access point and you can once again transmit data.

In a TCP/IP direct connect network with a terminal running a terminal emulation application, the application may disconnect from the host if you remain out of communications range too long or if the host sends "Keep Alive" messages while the terminal is in Suspend mode. You may need to restart the application and log back into the host to re-establish a terminal emulation session. In a UDP Plus network, the session is maintained any time the terminal is out of range or in Suspend mode.

To communicate through the network, all RF terminals must contain the same type of radio, either a WLI Forum 2.4 GHz OpenAir or an IEEE 802.11b radio.

Depending on the radio in the terminal, you must set certain parameters to the same configuration on both the terminal and the access points.

### **OpenAir Radio**

To use OpenAir radios in your network, you must set the following parameters:

- Domain
- (Optional) Security Identification (ID)

These parameters must be set to the same values on the terminals and the access points. Each access point is configured with a different channel/subchannel combination.



**Note:** On the access points, the Domain parameter is called the LAN ID (Domain) parameter.

### **802.11b Radio**

To use 802.11b radios in your network, you must set the following parameters:

- Network Name
- (Optional) WEP Encryption

These parameters must be set to the same value on the terminals and the access points. You can also set the Network Name parameter to "ANY" on the terminal, allowing the terminal to communicate with any access point that has the same radio and is within range. The Network Name parameter is case-sensitive. For more information about the WEP Encryption parameter, see Chapter 6 in the 2400 Family system manual.



**Note:** On the access points, the Network Name parameter is called the SSID (Network Name) parameter.

---

## ***About the Network Parameters***

When you install the 2435 in a network, you must configure the network parameters that control how the terminal communicates in the network.

The set of network parameters you must configure depends on whether you install the terminal on the same subnetwork as the DCS 30X or host (TCP/IP) or on a different subnetwork.

You must define the following network parameters:

- Network Activate
- (UDP Plus) Controller IP Address
- (TCP/IP) Host IP Address
- Terminal IP Address (Non-DHCP environment only)
- Network Port
- (DCS 30X or host on different subnetwork) Default Router
- (DCS 30X or host on different subnetwork) Subnet Mask

For help understanding these parameters and their syntax, see Chapter 6 in the 2400 Family system manual. For more information about network connectivity and protocols, see Chapter 2 in the 2400 Family system manual.

---

## ***Monitoring Network Communications***

After you configure the 2435 in the RF network, you can use the application on the 2435 to collect and transmit data through network communications. If the 2435 is communicating with your host computer, it will connect to your host computer and begin running the application that shipped on the terminal.

As you use the 2435 to collect data, the Network Connect icon helps you monitor network communications between the 2435 and other devices in the RF network. To learn how to use the Network Connect icon, see “Learning About the Status Icons” in Chapter 1.

# 4

## ***Troubleshooting and Maintaining the Terminal***



*This chapter lists problems you may encounter while using the terminal and provides some possible solutions. It also describes how to boot or reset the terminal and clean the scanner window and terminal screen.*

## How to Use This Chapter

---

If you have any problems using the 243X, use this table as a guide to find the problem and solution in this chapter:

<b>Problem</b>	<b>See This Section to Find a Solution</b>	<b>Page</b>
Screen is blank, terminal is locked up, or message is displayed.	“Problems While Operating the Terminal”	4-4
Configuring the terminal	“Problems While Configuring the Terminal”	4-6
(2435 only) RF communications error	“Problems Communicating With RF Network Devices”	4-11
Running applications on the terminal	“Problems While Running Applications”	4-13
Serial port communications error	“Problems Transmitting Data Through the Serial Port”	4-14
DCS 30X application error	“Problems Transmitting Data Through the DCS 30X”	4-14
Scanning labels	“Problems Scanning Bar Code Labels”	4-15
Boot Menu appears or terminal is locked up.	“Booting the Terminal”	4-17
Terminal or application is locked up.	“Troubleshooting a Locked Up Application”	4-18
Terminal is not responding to the Reset Firmware command.	“Resetting the Terminal”	4-19
Scanner window or terminal screen is dirty.	“Cleaning the Scanner Window and Terminal Screen”	4-20

You can also use the error numbers and messages table and the terminal diagnostics to help analyze and solve problems. For help, see Chapter 4, "Running Diagnostics," in the 2400 Family system manual.

If you have problems with the TE 2000 terminal emulation applications, see the appropriate TE manual.

If you send the terminal in for service, it is your responsibility to save the terminal data and configuration. Intermec is only responsible for ensuring that the keypad and other hardware features match the original configuration when repairing or replacing your terminal.

---

## **Problems While Operating the Terminal**

If you are operating the terminal and have trouble, check these possible problems and solutions.

### **Problem**

You press **(I/O)** to turn on the terminal and the screen is blank and nothing happens.

The terminal is booting and you see a message that POST failed.

The terminal displays the Boot Menu.

You are sending and receiving information through the network, and the terminal appears to be operating slowly.

### **Solution**

The battery pack may not be installed correctly. For help, see "Installing the Battery Pack" in Chapter 1.

The battery pack may be discharged. Replace the battery pack with a spare charged battery pack, or charge the battery pack and try again.

The screen displays the system that failed POST. Report the error message to your supervisor.

Press **(Esc)** to exit the error message. The Boot Menu appears. Press **(1)** to boot the terminal. Your application appears on the screen. If the terminal still will not boot, contact your local Intermec service representative for help.

The Boot Menu appears if you just upgraded the firmware on the terminal and POST failed. Press **(1)** to boot the terminal. Report the problem to your supervisor.

If the main battery was removed from the terminal for an extended period of time, when you replace the main battery, the Boot Menu appears. Press **(1)** to boot the terminal and continue working.

For help with the Boot Menu, see "Booting the Terminal" on page 4-17.

The terminal may be configured for the 5x6, 6x8, or 12x16 font type. These font type values may cause the 243X to scroll, and therefore operate, more slowly when it displays information on the screen. Change the font type to a value other than 5x6, 6x8, or 12x16. For help, see "Display Font Type" or "Display Spacing" in Chapter 6 of the 2400 Family system manual. If the terminal continues to operate slowly, contact your local Intermec service representative for help.



**Problems While Operating the Terminal (continued)**

**Problem**

You cannot scan bar code labels.

**Solution**

See “Problems Scanning Bar Code Labels” on page 4-15.

You are scanning bar code labels, and the terminal appears to be operating slowly.

The terminal may be configured for the 5x6, 6x8, or 12x16 font type. These font type values may cause the 243X to scroll, and therefore operate, more slowly when it displays bar code values on the screen. Change the font type to a value other than 5x6, 6x8, or 12x16. For help, see “Display Font Type” or “Display Spacing” in Chapter 6 of the 2400 Family system manual. If the terminal continues to operate slowly, contact your local Intermec service representative for help.

You scan a reader command, such as Change Configuration, and nothing happens.

The reader commands are disabled. Scan the Enable Override command shown here to temporarily enable all of the reader commands. You can also enable or disable reader commands with the TRAKKER Antares 2400 Menu System. For help, see “Command Processing” in Chapter 6 of the 2400 Family system manual. When you are finished, remember to disable the override so that your data is not interpreted as a command.

Enable Override



\*\$+DC3\*

You scan a valid bar code label to enter data for your application. The data decoded by the terminal does not match the data encoded in the bar code label.

The terminal may have decoded the bar code label in a symbology other than the label’s actual symbology. Try scanning the bar code label again. Make sure you scan the entire label.

To operate the terminal quickly and efficiently, you should enable only the bar code symbologies that you are going to scan. If you enable multiple symbologies, the terminal may, on rare occasions, decode a bar code according to the wrong symbology and produce erroneous results.

You want to restore the terminal’s default configuration so that you can reconfigure the terminal.

Scan this bar code label:

Default Configuration



\*.+\*

You can also use the TRAKKER Antares 2400 Menu System. For help, see “Restoring the Terminal’s Default Configuration” in Chapter 2 of the 2400 Family system manual.

After you load the default configuration, you may need to set the primary network communications parameters to communicate with other devices in the network.

---

**Problems While Operating the Terminal (continued)**

**Problem**

The terminal appears to be locked up and you cannot enter data.

**Solution**

Try these possible solutions:

- (2435 only) Wait at least 10 seconds and try again. If the 2435 is still connecting to the DCS 30X or host, it will ignore any input from the keypad or scanner. Make sure the Network Connect icon is on before continuing.
- Scan a bar code label to see if the terminal responds.
- Follow the instructions in "Troubleshooting a Locked Up Application" on page 4-18.
- If the terminal will not boot or reset, contact your local Intermec service representative for help.

---

**Problems While Configuring the Terminal**

You can configure the terminal by using the TRAKKER Antares 2400 Menu System, by scanning configuration commands, or by using the clone application. If you have trouble configuring the terminal, check these possible problems and solutions.

**Problem**

On the 2435, you configure the security ID and the changes do not appear to be saved.

**Solution**

You can only set the security ID with the RF network enabled. The Network Activate command must be set to the RF network before you can save any changes to the Security ID command.

You are configuring SOM or EOM in the Configuration Menu and cannot set two characters.

You may have a space in the SOM or EOM field. The space does not show, but it is a valid character. To clear a space from the field, put the cursor in the field and press . Now set the two-character value for SOM or EOM.

You are scanning a configuration command to set one of the serial port parameters and hear three low beeps. For example, you are trying to set EOM or SOM.

The order in which you scan serial port protocol configuration commands is important. Configurable Serial Port (CSP) protocol uses EOM to determine the serial communications mode. When EOM is disabled, the terminal communicates in Character mode. When EOM is enabled, the terminal communicates in Frame mode.

To use Frame mode, you need to set EOM first. Next, configure Handshake, Configuration Commands Via Serial Port, LRC, SOM, and then Poll. To use Character mode, you need to disable these same parameters in reverse order.

For help, see "Using Serial Communications on the Terminal" in Chapter 3.

You scan or enter an option for the Scanner Selection configuration command and you hear three low beeps.

You may have scanned or entered a Scanner Selection command that does not apply to the type of scanner that you have installed. Try scanning or entering the Scanner Selection command again and select an option for the type of module you have installed.

**Problems While Configuring the Terminal (continued)**

**Problem**

You scan a configuration command, such as Keypad Caps Lock, and nothing happens.

**Solution**

One or more reader commands, such as Change Configuration, may be disabled, so that you cannot change the configuration. Enable all of the reader commands and try again.

The terminal may be waiting for another command to complete the configuration change. If you started by scanning the Enter Accumulate command, you must finish the command by scanning the Exit Accumulate command. For help, see Chapter 6, "Configuration Command Reference," in the 2400 Family system manual.

Scan Enable Override to temporarily enable all of the reader commands. When you are finished, remember to disable the override so that your data is not interpreted as a command.

Enable Override



\*\$+DC3\*

You scan a configuration command, such as Keypad Caps Lock, and you hear three low beeps.

If you are working in the TRAKKER Antares 2400 Menu System, you cannot scan configuration commands. Use the Configuration Menu to change the terminal's configuration, or exit the menu system to scan configuration commands.

Check the command you are trying to scan. Make sure the command is set correctly for the options and network communications you are using with the terminal. For help, see Chapter 6, "Configuration Command Reference," in the 2400 Family system manual.

On the 2435, you scan a configuration command to set one of these parameters and hear three low beeps:

- Controller IP Address (UDP Plus) or Host IP Address (TCP/IP)
- Terminal IP Address
- Default Router
- Network Activate

If the Network Activate command is enabled (RF network enabled) and you are configuring the 2435, these IP addresses must define a valid network configuration. For example, an invalid network configuration would be a controller (or host) IP address set to 0.0.0.0 with the network enabled.

To set these four parameters, follow these steps:

1. Disable the Network Activate (NA) configuration command.
2. Set the terminal IP address and the controller IP address or the host IP address.
3. Set the default router address (if necessary).
4. Enable the Network Activate command.

You can change an IP address with the network enabled as long as it still defines a valid network configuration.

**Problems While Configuring the Terminal (continued)**

**Problem**

**Solution**

You are configuring the serial port and see this error message when exiting the Configuration Menu:

SOM cannot equal the same value that is set for EOM. You cannot set SOM to any of these values: AFF (ACK), DLE, NEG (NAK), Poll, RES (EOT), REQ (ENQ), SEL, XOFF, or XON. You need to change the value of SOM. Choose Serial Port from the Communications Menu.

Serial port configuration error.

For help, see "Start of Message (SOM)" in Chapter 6, "Configuration Command Reference," in the 2400 Family system manual.

SOM cannot equal EOM.

Configuration was not updated.

You are configuring the serial port and see this error message when exiting the Configuration Menu:

EOM or SOM cannot be set to any of these values: AFF (ACK), DLE, NEG (NAK), Poll, RES (EOT), REQ (ENQ), SEL, XOFF, or XON. You must change the value of EOM or SOM. Choose Serial Port from the Communications Menu.

Serial port configuration error. DLE, XON, XOFF are not valid values for either SOM or EOM.

For help, see "End of Message (EOM)" or "Start of Message (SOM)" in Chapter 6, "Configuration Command Reference," in the 2400 Family system manual.

Configuration was not updated.

You are configuring the serial port and see this error message when exiting the Configuration Menu:

EOM can be one or two ASCII characters, but the value for the first character cannot be the same as the value for the second character. Also, EOM cannot be set to any of these values: AFF (ACK), DLE, NEG (NAK), Poll, RES (EOT), REQ (ENQ), SEL, XOFF, or XON. You must change the value of EOM #1 or #2. Choose Serial Port from the Communications Menu.

Serial port configuration error.

For help, see "End of Message (EOM)" in Chapter 6, "Configuration Command Reference," in the 2400 Family system manual.

EOM #1 cannot equal EOM #2. Configuration was not updated.

You are configuring the serial port and see this error message when exiting the Configuration Menu:

You must configure a value for EOM before you can set SOM or disable SOM. You need to change the value of SOM. Choose Serial Port from the Communications Menu.

Serial port configuration error.

Configurable Serial Port (CSP) protocol uses EOM to determine the serial communications mode. When EOM is disabled, the terminal communicates in Character mode. When EOM is enabled, the terminal communicates in Frame mode.

SOM is set. You must also set EOM.

To use Frame mode, you need to set EOM first. Next, configure Handshake, Configuration Commands Via Serial Port, LRC, SOM, and then Poll. To use Character mode, you need to disable these same parameters in reverse order. For help, see "Using Serial Communications on the Terminal" in Chapter 3.

Configuration was not updated.

**Problems While Configuring the Terminal (continued)**

**Problem**

You are configuring the serial port and see this error message when exiting the Configuration Menu:

PG command failed.

Configuration was not updated.

You see this error message when exiting the Configuration Menu:

*Commandname*  
command failed.

Remainder of configuration not updated.

You are configuring a 243X with the clone application and see an error message.

On the 2435, you see this error message when exiting the Configuration Menu:

Network configuration error.  
Network is enabled. Terminal IP address or Controller (Host) IP address set to an invalid address of 0.x.x.x or 127.x.x.x. Configuration was not updated.

**Solution**

PG is the Handshake configuration command. You must change the value of Handshake or set other serial port parameters. Choose Serial Port from the Communications Menu.

The order in which you set serial port protocol configuration commands is important. To use Frame mode, you need to set EOM first. Next, configure Handshake, LRC, SOM, and then Poll. To use Character mode, you must disable these parameters in reverse order. For help, see "Using Serial Communications on the Terminal" in Chapter 3.

The two-character name (syntax) of the configuration command that failed is listed on the first line of the error message.

Check the command listed in the message. To find the command, use the "Configuration Commands by Syntax" table in Appendix A of the 2400 Family system manual. Make sure the command is set correctly for the options and network communications you are using with the terminal. For help, see Chapter 6, "Configuration Command Reference," in the 2400 Family system manual. For example, you may see this message:

SS  
command failed.

There may be a problem with the configuration due to a change made with the Scanner Selection (SS) command.

The server terminal and the client terminal may not have the same hardware or software configuration. Make sure that both terminals have the same hardware configuration, firmware version, and clone application version. For help, see "Configuring the Terminal With the Clone Application" in Chapter 2.

The RF network is enabled and there is a problem with the network configuration. You must change the terminal IP address, the controller IP address (host IP address for a TCP/IP network), or both. Choose Primary Network from the Communications Menu.

The terminal IP address or the controller/host IP address is set to 0.x.x.x or 127.x.x.x. These are invalid addresses. Set a valid IP address for the terminal and DCS 30X or host.

For help, see "Using RF Communications on the Terminal" in Chapter 3. If you cannot fix the addressing problem, check with your network administrator to get the IP address assigned to the terminal and the controller or host.

**Problems While Configuring the Terminal (continued)**

**Problem**

On the 2435, you see this error message when exiting the Configuration Menu:

```
Network configuration error.  
Network is enabled. Terminal IP  
address and Default Router  
address set to the same  
address. Configuration was not  
updated.
```

On the 2435, you see this error message when exiting the Configuration Menu:

```
Network configuration error.  
Network is enabled. Terminal IP  
address or Controller (Host) IP  
address set to the same  
address. Configuration was not  
updated.
```

On the 2435, you see this error message when exiting the Configuration Menu:

```
Network configuration error.  
Network is enabled. Default  
Router address is not on the  
terminal's network.  
Configuration was not updated.
```

**Solution**

The RF network is enabled and there is a problem with the network configuration. You must change the terminal IP address, the default router address, or both. Choose Primary Network or Advanced Network from the Communications Menu.

The terminal IP address and the default router address are both set to the same address. Set a valid IP address for the terminal and the default router.

For help, see "Using RF Communications on the Terminal" in Chapter 3. If you cannot fix the addressing problem, check with your network administrator to get the IP addresses for each RF network device.

The RF network is enabled and there is a problem with the network configuration. You must change the terminal IP address, the controller IP address (host IP address for a TCP/IP network), or both. Choose Primary Network from the Communications Menu.

The terminal IP address and the controller/host IP address are both set to the same address. Set a valid IP address for the terminal and DCS 30X or host.

For help, see "Using RF Communications on the Terminal" in Chapter 3. If you cannot fix the addressing problem, check with your network administrator to get the IP address assigned to the terminal and the DCS 30X or host.

The RF network is enabled and there is a problem with the network configuration. You must change the default router address. Choose Advanced Network from the Communications Menu.

The terminal and DCS 30X (UDP Plus network) or host (TCP/IP network) are on different networks, and the terminal is not on the same network as the default router. When the terminal is on a different IP subnetwork from the DCS 30X or host, you must set the Default Router and Subnet Mask commands. Set a valid IP address for terminal, DCS 30X or host, and default router.

For help, see "Using RF Communications on the Terminal" in Chapter 3. If you cannot fix the addressing problem, check with your network administrator to get the IP addresses for each network device.

## Problems Communicating With RF Network Devices

If the 2435 is not communicating with other devices in the RF network, check these possible problems.

### Problem

When you turn on the terminal after it was suspended for 10-15 minutes or longer, the terminal can no longer send or receive messages over the network.

The Network Connect icon is off. The 2435 is not communicating with the access point.

The Network Connect icon blinks on the terminal screen.



### Solution

The host may have deactivated or lost your current terminal emulation session. In a TCP/IP direct connect network, you need to turn off the “Keep Alive” message (if possible) from the host so that the TCP session is maintained while a terminal is suspended.

Make sure the access point is turned on and operating. You may also be using the terminal out of range of an access point. Try moving closer to an access point to re-establish communications.

Make sure the Network Activate command is enabled. For help, see “Network Activate” in Chapter 6 of the 2400 Family system manual.

Make sure the 2435 is configured correctly for your network. In an OpenAir network, the domain and the security ID on the terminal must match the values set for all access points the terminal may communicate with. In an 802.11b network, the network name on the terminal must match the values set for all access points the terminal may communicate with. For help, see “Using RF Communications on the Terminal” in Chapter 3.

In a TCP/IP direct connect network, you cannot scan or enter data when the 2435 is not communicating with an access point or you may lose your TCP session.

If you are within range of an access point, the Network Activate command is enabled, and the Network Connect icon is still off, you may have a defective radio card. For help, contact your local Intermec service representative.

In a UDP Plus network, the terminal is communicating with an access point, but it is not connected to the DCS 30X. You may need to check the 2435 configuration or make sure the DCS 30X is running and that data collection is started.

The 2435 may be out of range of an access point or the access point may have recently been turned off. Make sure the access point is still turned on and the 2435 is with in range.

Each device in the network must have a valid IP address. The IP addresses set on the terminal must match the addresses configured on the DCS 30X or host. For help, see “Using RF Communications on the Terminal” in Chapter 3.

---

**Problems Communicating With RF Network Devices (continued)**

**Problem**

The Network Connect icon blinks on the terminal screen and you see this message:

```
Unable to connect to  
controller. Error 102.
```

```
Unable to establish connection  
to host. Session ended.
```

The Network Connect icon is on, but you cannot establish a terminal emulation session with the host computer.



The Network Connect icon is on, but the host computer is not receiving any data from the 2435.



The 2435 is connected to the DCS 30X or host computer, and you move to a new site to collect data. The Network Connect icon was on and now begins to blink or turns off.



You are sending and receiving information through the network, and the terminal appears to be operating slowly.

**Solution**

The 2435 is connected to the access point but is trying to establish communications with the DCS 30X and the host computer. Make sure the terminal is correctly configured for your network. In a UDP Plus network, make sure the DCS 30X is configured and data collection is started. In a TCP/IP network, make sure the host computer is configured and running.

If the network is configured correctly, try shutting down and restarting the DCS 30X to establish communications. You can also reset the terminal. For help, see “Resetting the Terminal” on page 4-19.

There may be a problem with the host computer, a problem with the connection between the DCS 30X and the host computer, or a problem with the connection between the access point and the host (TCP/IP). Check with your network administrator to make sure the host is running and allowing users to login to the system.

In a UDP Plus network, there may be a problem with the connection between the DCS 30X and the host computer. Check with your network administrator or use the user's manual for the DCS 30X to troubleshoot any potential problems with the server.

In a TCP/IP network, there may be a problem with the connection between the access point and the host computer. Check with your network administrator or use your access point user's manual to troubleshoot any potential problems with the access point.

You may have gone out of range of an access point. Try moving closer to an access point or to a different location to re-establish communications. Once you are in range again, the Network Connect icon will appear and remain on. Any data you collected while you were out of range will be transmitted over the network.

The terminal may be configured for the 5x6, 6x8, or 12x16 font type. These font type values may cause the 243X to scroll, and therefore operate, more slowly when it displays information on the screen. Change the font type to a value other than 5x6, 6x8, or 12x16. For help, see “Display Font Type” or “Display Spacing” in Chapter 6 of the 2400 Family system manual. If the terminal continues to operate slowly, contact your local Intermec service representative for help.



## Problems While Running Applications

If you are running applications on the terminal and have trouble, check these possible problems and solutions.

### Problem

There is not enough memory to load a program.

You see this error message when trying to load a program:

```
ERROR LOADING MODULE
LIBRARY NAME:
<libraryname>
```

```
FILE NAME:
<filename>
```

where *libraryname* and *filename* are the library and files names of the program.

You see one of these error messages while running a PSK or EZBuilder application:

```
SCREEN ERROR: 30
Code: 9
Hit any key To exit!
```

```
SCREEN ERROR: 31
Code: 3
Hit any key To exit!
```

You try to run a DOS application in the TRAKKER Antares 2400 Menu System and see this message:

```
Not a valid application.
```

A DOS command does not work.

The terminal does not boot after you modified the CONFIG.SYS file to configure a ROM-DOS RAM drive.

### Solution

You need to free conventional memory.

You need to free conventional memory.

You must set the RAM Drive Size configuration command. For help, see "RAM Drive Size" in Chapter 6, "Configuration Command Reference," in the 2400 Family system manual.

You tried to run a DOS .EXE application from the TRAKKER Antares 2400 Menu System. You can only run .BIN applications in the menu system. To run a DOS .EXE application, enter the filename at the DOS prompt. For help, see "Running DOS Applications and Using ROM-DOS Commands" in Appendix D of the 2400 Family system manual.

For a list of commands, see "Using ROM-DOS Commands" in Appendix D of the 2400 Family system manual.

Correct the error in CONFIG.SYS and use the DOS software tools to recreate drive A with the corrected CONFIG.SYS file.

---

## **Problems Transmitting Data Through the Serial Port**

If you are having problems sending or receiving data through the serial port on the terminal, check these possible problems:

- Make sure the terminal is connected to the PC, host computer, or serial device through COM1. For help, see “Connecting to a Serial Device or Network” in Chapter 1.
- Make sure you are using the appropriate cable to connect the terminal to the PC, host, or serial device.
- Make sure the terminal’s serial port parameters are configured to match the serial port configuration on the host computer or serial device. For help, see “Using Serial Communications on the Terminal” in Chapter 3.

---

## **Problems Transmitting Data Through the DCS 30X**

If you have a problem while running the application on the terminal in a UDP Plus network, check these possible communications problems.

### **Problem**

### **Solution**

Transaction Buffer Full.

The buffer holding transactions to be sent to the controller is full. Stop collecting data with this terminal. Make sure the terminal is communicating with the DCS 30X and let the terminal send all the transactions in the buffer before you continue collecting data.

Sending Buffer Transactions.

This is an information message to tell you that buffered transactions are now being sent to the DCS 30X. You can begin collecting data again once the message clears.

Transaction Aborted.

The transaction just sent to the DCS 30X was not received. Try sending the transaction again.

Transmit Error XX, press Enter.

There is an error transmitting data to the DCS 30X. XX represents the status code error. Note the error code listed in the message and contact your local Intermec service representative for help. Press **ENTER** to continue.

Receive Error XX, press Enter.

There is an error receiving data from the DCS 30X. XX represents the status code error. Note the error code listed in the message and contact your local Intermec service representative for help. Press **ENTER** to continue.

Shutting down.

The DCS 30X is shutting down. You may continue collecting data and buffer the transactions in the terminal until the DCS 30X starts again or stop collecting data with the terminal.

Controller Shutdown.

The DCS 30X has shut down. You may continue collecting data and buffer the transactions in the terminal until the DCS 30X starts again or stop collecting data with the terminal.

## Problems Scanning Bar Code Labels

If you cannot scan bar code labels or you are having problems with the scanner, check these possible problems.

### Problem

The terminal is turned off.

You cannot see a red beam of light from the scanner when you press the scan button and aim the scanner at a bar code label.

### Solution

Make sure the terminal is turned on. Press  to turn on the terminal.

You may be too far away from the bar code label. Try moving closer to the bar code label and scan it again.

You may be scanning the bar code label “straight on.” Try changing the scanning angle.



### Warning

*Do not look directly into the window area or at a reflection of the laser beam while the laser is scanning. Long-term exposure to the laser beam can damage your vision.*

### Avertissement

*Ne regardez pas directement la réflexion d'un rayon laser ou dans la fenêtre du laser lorsque celui-ci est en opération. Si vous regardez trop longtemps un rayon laser, cela peut endommager votre vue.*

You have an input device attached to the terminal and it cannot read any bar code labels.

You may not be using an input device that is supported by the 243X. Make sure you are using one of the supported input devices listed in Appendix A, “Specifications.”

Your 243X may not be configured for the input device connected to it. You must configure the Scanner Selection command and select the input device that is connected to the terminal. For help, see “Scanner Selection” in Chapter 6, “Configuration Command Reference,” in the 2400 Family system manual.

You try to scan a bar code label with an input device and the integrated scanner on the terminal turns on.

Your 243X may not be configured for the input device connected to it. You must configure the Scanner Selection command and select the input device that is connected to the terminal. If this command is not defined for the appropriate input device, the scanner trigger on the input device may activate the integrated scanner on the terminal. For help, see “Scanner Selection” in Chapter 6, “Configuration Command Reference,” in the 2400 Family system manual.

The input device connected to the terminal does not appear to work well or read bar code labels very quickly.

Make sure that the Scanner Selection command is set to the specific tethered scanner you have attached. For help, see “Scanner Selection” in Chapter 6, “Configuration Command Reference,” in the 2400 Family system manual.

Check the bar code symbologies you have enabled on the terminal. Enable only the symbologies that you are using.

**Problems Scanning Bar Code Labels (continued)**

**Problem**

**Solution**

The integrated scanner does not read the bar code labels quickly, or the scanning beam seems to be faint or obscured.

The scanner window may be dirty. Clean the window with a solution of mild soap and water. Wipe dry. Do not allow abrasive material to touch the window.

When you release the Scan Button, the Good Read LED does not turn off.

The Good Read LED remains on if you configure the terminal to use edge triggering. If you configure the terminal for level triggering and the Good Read LED remains on, there may be a problem with the LED. Press the Scan Button again without scanning a bar code label. If the LED is still on, contact your local Intermec service representative.

The scanner will not read the bar code label.

Make sure you aim the scanner beam so it crosses the entire bar code label in one pass.

The angle at which you are scanning the bar code label may not be working well, or you may be scanning the label "straight on." Try scanning the bar code label again, but vary the scanning angle.

The bar code label print quality may be poor or unreadable. To check the quality of the bar code label, try scanning a bar code label that you know scans. Compare the two bar code labels to see if the bar code quality is too low. You may need to replace the label that you cannot scan.

Make sure the bar code symbology you are scanning is enabled. Use the TRAKKER Antares 2400 Menu System to check the symbologies. On the Symbologies Menu, each symbology that is enabled has an asterisk (\*) next to the name of the symbology. If your bar code symbology is disabled, enable it and then try scanning the bar code label again.

Make sure that the application you are running on the terminal is expecting input from a bar code. You may need to type this information instead of scanning it.

You are scanning bar code labels, and the terminal appears to be operating slowly.

The terminal may be configured for the 5x6, 6x8, or 12x16 font type. These font type values may cause the 243X to scroll, and therefore operate, more slowly when it displays bar code values on the screen. Change the font type to a value other than 5x6, 6x8, or 12x16. For help, see "Display Font Type" or "Display Spacing" in Chapter 6 of the 2400 Family system manual. If the terminal continues to operate slowly, contact your local Intermec service representative for help.

## Booting the Terminal

---



You seldom need to boot or reset the terminal. When you boot the terminal, it runs through power-on self test (POST) to test each major subsystem. The terminal uses the configuration currently saved in flash memory. After the terminal is finished booting, your application appears on the screen.

You can boot the terminal using these two methods:

- Configure the  key to boot the terminal when you turn on the terminal.
- Use the Boot Menu.

---

### Booting the Terminal on Resume

When you press  to turn off the terminal, it turns off and goes into Suspend mode. When you press  to turn on the terminal, it resumes or boots depending on the terminal configuration.

There are two ways to configure the  key using the Resume Execution configuration command:

**Resume Execution Not Allowed** Configures the terminal to boot and restart your application each time you press  to turn on the terminal. Use this option if you want to restart your application every time you turn on the terminal.

**Resume Execution Allowed** Configures the terminal to resume exactly where it was when you turned off the terminal. Use this option to resume working each time you turn on the terminal.

You can configure the Resume Execution command by using the TRAKKER Antares 2400 Menu System or by scanning these bar code labels. For help, see Chapter 2, “Configuring the Terminal,” or “Resume Execution” in Chapter 6 of the 2400 Family system manual.

Resume Execution Not Allowed



\*\$+ER0\*

Resume Execution Allowed



\*\$+ER1\*

---

## Using the Boot Menu

To access the Boot menu, you can

- upgrade the firmware. For help, see “Upgrading the Firmware” in Chapter 2 of the 2400 Family system manual.
- reset the terminal. For help, see “Resetting the Terminal” on page 4-19.
- remove the main battery and wait longer than 15 minutes to install a charged main battery. This procedure also performs a destructive reset, which can have unpredictable results.

The Boot Menu contains these commands:

**Boot System** Press **1** to boot the terminal. Once the terminal is finished booting, your application appears on the screen.

**Run Loader** Press **2** to load the terminal firmware. To upgrade or load the firmware, use the Firmware Upgrade option in the TRAKKER Antares 2400 Menu System. For help, see Chapter 2 in the 2400 Family system manual.

**Power Down** Press **3** to turn off the terminal. When you turn on the terminal, the Boot Menu screen appears again if POST passes.

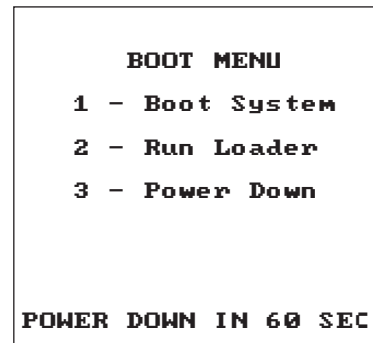

248XU104.eps

---

## Troubleshooting a Locked Up Application

If the terminal or application is locked up and the terminal will not respond to any key sequences, try the following steps in order:

1. Press **I/O** to turn off the terminal. Press **I/O** to turn on the terminal.
2. Use the TRAKKER Antares 2400 Menu System to reboot the terminal.
  - a. Press **FIELD EXIT** **2** **4** **8** or **RETURN** **2** **4** **8** to enter the TRAKKER Antares 2400 Menu System.
  - b. Choose System Menu and then Upgrade Firmware.
  - c. Choose OK, then YES, then press **Esc**. The Boot Menu appears.
  - d. Press **1** to boot the terminal.

3. Scan the Reset Firmware label to restart the firmware and application.

Reset Firmware



\*\_.\*

If the terminal or application still will not respond, reset the terminal. For help, continue with the next section.

## Resetting the Terminal

---

If you performed the steps in “Troubleshooting a Locked Up Application” and the terminal or application is locked up and the terminal will not respond to the Reset Firmware command, follow the steps in this section to reset the terminal.

### To reset the terminal





- Scan the Boot Terminal label to reboot the terminal.

Boot Terminal



\*\_1\*

If the terminal will not scan, you can perform a destructive reset. A destructive reset can have unpredictable results.

1. If possible, press  to turn off the terminal.
2. Press and hold the  key for approximately 12 seconds. The Good Read LED blinks once and the terminal turns off.
3. Press  to turn on the terminal. The Boot Menu appears.
4. Press  to boot the terminal. Once the terminal has finished booting, your application appears.
5. Set the time and date. For help using the TRAKKER Antares 2400 Menu System, see “Configuring the Terminal With the Menu System” in Chapter 2.

## ***Cleaning the Scanner Window and Terminal Screen***

---

The terminals are built for use in an industrial working environment. You may need to perform these minor maintenance tasks to keep the terminal in good working order:

- Clean the scanner window.
- Clean the terminal screen.

Clean the scanner window and terminal screen as often as needed for the environment in which you are using the terminal.

### **To clean the scanner window and terminal screen**

1. Press  to turn off the terminal.
2. Use a solution of mild soap and water.
3. Dip a clean towel or rag in the soap and water solution and wring out the excess solution. Wipe off the scanner window and terminal screen. Do not allow any abrasive material to touch these surfaces.
4. Wipe dry.



#### **Caution**

*There are no user-serviceable parts inside the terminal. Opening the unit will void the warranty and may cause damage to the internal components.*

#### **Conseil**

*La terminal ne contient pas de pièces révisibles par l'utilisateur. Le fait d'ouvrir l'unité annule la garantie et peut endommager les pièces internes.*





# ***Specifications***



*This appendix lists the terminal's physical and environmental specifications.*

## ***Physical and Environmental Specifications***

---

You can use the tables in this section to find technical information about these features and options:

- Terminal Dimensions
- Power Specifications
- Electrical Specifications
- Temperature and Environmental Specifications
- Screen
- Keypad Options
- Application Options
- Connectivity Options
- Memory
- 802.11b Radio Specifications
- OpenAir Radio Specifications
- Wired Data Communications
- Bar Code Symbologies
- Input Devices and Cables
- Pin Assignments

### **Terminal Dimensions**

Length:	25.4 cm (10 in)
Height:	4.6 cm (1.8 in) at grip
Width:	10.2 cm (4 in) at screen
Weight:	708.7 g (25 oz) with battery

### **Power Specifications**

Operating:	Rechargeable 1500 mAh battery pack
Backup:	Rechargeable capacitor

### **Electrical Specifications**

Models:	2430, 2435
Electrical rating:	⎓ 7,4 to 12V; 750 mA

### **Temperature and Environmental Specifications**

Operating the terminal:	-20°C to 50°C	-4°F to 122°F
Storing the terminal:	-20°C to 50°C	-4°F to 122°F
Charging the terminal:	0°C to 40°C	32°F to 104°F
Relative humidity:	0 to 90% non-condensing	

### **Screen**

- CGA-compatible, backlit LCD
- Configurable up to 21 lines by 31 columns

### **Keypad Options**

- (57-key) Alphanumeric keypad, available with programmable, international, 3270 TE, 5250 TE, or VT/ANSI TE overlays
- (39-key) Alphanumeric keypad, available with programmable, international, 3270 TE, 5250 TE, or VT/ANSI TE overlays

### **Application Options**

- Programmable terminal
- (2435) Data Collection Browser (dcBrowser)
- (2435) TE 2000 terminal emulation

### **Connectivity Options**

- RS-232
- (2435) TCP/IP with DHCP
- (2435) UDP Plus with TFTP

### **Memory**

- 4MB flash memory, 750K available for use (additional 2MB flash for double-byte fonts or drive D)
- 1MB battery-backed RAM, 512K available for user
- (2430) Extended memory option for an additional 2MB or 4MB SRAM storage drive

### 802.11b Radio Specifications

Radio type	Direct sequence, spread spectrum
Channels	11 (North America), 13 (Europe), 4 (France), 1 (Japan)
Data rate	11 Mbps (High), 5.5 Mbps (Medium), 2 Mbps (Standard), 1 Mbps (Low) with automatic fallback for increased range
Range (11 Mbps)	160 m (525 ft) open environment 50 m (165 ft) semi-open environment 24 m (80 ft) closed environment
Frequency band	2.4 to 2.5 GHz world-wide

### OpenAir Radio Specifications

Radio type	Frequency hopping, spread spectrum
Channels	15
Data rate	1.6 Mbps, 0.8 Mbps fallback
Range	Up to 150 m (500 ft) indoors Up to 300 m (1,000 ft) outdoors
Frequency band	2.4 to 2.5 GHz worldwide

### Wired Data Communications

- RS-232C serial port (COM1)
- XMODEM/YMODEM protocol for data transfer
- Protocols: Binary, Configurable Serial Protocol, Master Polling, and Polling Mode D

### Bar Code Symbolologies

- Codabar
- Code 11
- Code 2 of 5
- Code 39
- Code 93
- Code 128
- Interleaved 2 of 5
- MSI
- PDF 417
- Plessey
- UPC/EAN



**Note:** The Code 11 symbology is only supported on 243X terminals configured for non-decoded scanning. The PDF 417 symbology is only supported on 243X terminals configured for decoded scanning. For more information, see “Code 11” or “PDF 417” in Chapter 6 of the 2400 Family system manual.

### **Input Devices and Cables**

You must use an interface cable to connect an input device to the input device connector. Use the following table to determine which non-decoded input device you can attach to the 243X and which cable you need:

<b>Non-Decoded Intermec Input Device</b>	<b>Part No.</b>	<b>Cable Part No.</b>
1550C laser scanner	1550C0501	068424
1553E laser scanner	1550E0603	3-606031-00
1550C high visibility laser scanner	1550C0504	068424
1550C standard range laser scanner	1550C0500	068424
1551C standard range laser scanner	1551C0200	068424
1551E standard range laser scanner	1551E0600	Contact your Intermec sales representative.

For a list of decoded input devices, contact your Intermec sales representative.



**Note:** The 243X has two connector module options. The standard connector module supports non-decoded input devices while the serial connector module supports decoded input devices. Make sure that you select the appropriate input device for your connector module. For help, see “Learning About the Connector Modules” in Chapter 1.

Intermec is constantly testing and developing new input devices. For an updated list of Intermec-approved input devices for the 243X or for help determining which adapter cable you need, see your Intermec sales representative.

## **Pin Assignments**

---

You can use these pin assignments to make your own serial cables or troubleshoot problems.

### **Pin Assignments for COM1**

The following illustration shows the type of connector and the pin assignments for the COM1 port.

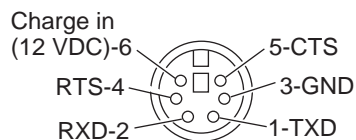

243XU036.eps

## Pin Assignments for the Input Device Connectors

The following illustrations show the type of connectors and pin assignments for the input device connectors on both the standard connector module and the serial connector module.

### Serial Connector Module (Decoded Scanner Connector)

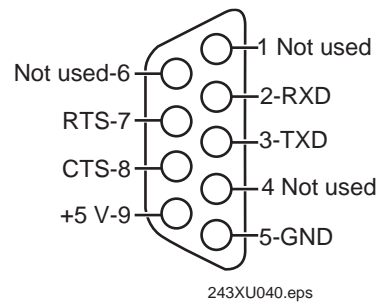

### Standard Connector (Module Non-Decoded Scanner Connector)

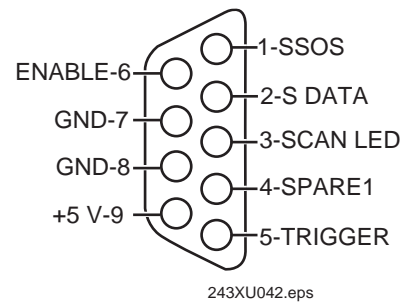





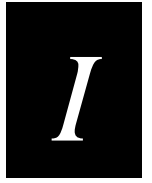





# ***Index***



## Symbols and Numbers

-  key, *See* Control key
-  key, *See* Shift key
-  key, *See* Function Left key
-  key, *See* Function Right key
-  key
  - configuring to boot the terminal, 4-17
  - turning the terminal on and off, 1-13
  - See also* Suspend/Resume key
- 243X, *See* terminal
- 3270 and 5250 terminal emulation, *See* the *TE 2000 5250 Terminal Emulation Programmer's Guide* or the *TE 2000 3270 Terminal Emulation Programmer's Guide*
- 802.11b radio
  - access points, configuring, 3-13
  - specifications, A-5
  - Wi-Fi certified, 1-3

## A

- About TRAKKER 2400 screen, defined, 2-5
- accent marks, entering, 1-15
- accessories, described, 1-6
- active configuration, 2-4
- alphanumeric keypad, options, described, 1-11
- Antares, *See* terminal
- antenna, internal, 1-4
- applications
  - options, described, A-4
  - TRAKKER Antares 2400 Menu System, using, 2-4 to 2-11
  - troubleshooting, 4-13
- ASCII
  - control characters, postamble and preamble, entering, 2-8
  - extended characters, configuring, 2-8
- audio signals, 1-4
  - list of, 1-20
  - volume, adjusting, 1-19
- Automatic Shutoff command, managing battery power, 1-11

## B

- backlight, turning on and off, 1-17
- backup power source
  - described, 1-4
  - specifications, A-3
- bar code conventions, defined, xi
- bar code labels
  - quiet zone, defined, 1-22
  - reader commands, troubleshooting, 4-5, 4-7
  - scanning
    - described, 1-21
    - troubleshooting, 4-15

- bar code symbologies
    - list of, A-5
    - troubleshooting bad decode, 4-5
    - See also* the *Trakker Antares 2400 Family System Manual*
  - battery charger, terminal accessory, described, 1-6
  - battery charger, using, 1-9
  - battery pack
    - charging, 1-9
    - described, 1-4
    - determining when low, 1-8
    - installing, 1-9
    - managing power, 1-11
  - Battery status icon
    - described, 1-18
    - using, 1-8
  - beep
    - audio signals, list of, 1-20
    - three low beeps, troubleshooting, 4-6, 4-7
    - volume, adjusting, 1-19
    - See also* audio signals
  - Binary protocol, described, 3-8
  - blue keys, using, 1-13
  - booting the terminal
    - cold boot, 4-19
    - configuring the  key, 4-17
    - POST failed, error message, 4-4
    - troubleshooting, 4-4
    - turning on the terminal, 1-13
    - warm boot, 4-19
  - box, shipping, contents of, 1-7
- ## C
- cables
    - for input devices, A-6
    - terminal accessories, 1-6
  - capitalizing characters, 1-14
  - Caps Lock status icon, described, 1-19
  - cautions, defined, viii
  - CGA-compatible screen
    - described, 1-4
    - specifications, A-4
  - Character mode
    - EOM, described, 3-9
    - troubleshooting, 4-8
  - characters
    - capitalizing, 1-14
    - typing, 1-13
  - charging the battery pack, 1-9
  - check boxes, marking, 2-7
  - cleaning
    - scanner window, 4-20
    - terminal screen, 4-20
  - clone application, configuring the terminal, 2-11

## **Trakker Antares 243X Hand-Held Terminal User's Manual**

- cloning cable
    - connecting to terminal, 2-12
    - terminal accessory, described, 1-6
  - cold boot, 4-19
  - COM ports, *See* serial port
  - COM1
    - described, 1-20
    - pin assignments, A-6
    - See also* serial port
  - commands
    - conventions, defined, xii
    - selecting, 2-6
    - TRAKKER Antares 2400 Menu System, selecting, 2-6
    - See also the Trakker Antares 2400 Family System Manual*
  - communications
    - protocols
      - Binary, 3-8
      - Configurable, 3-9
      - Master Polling, 3-10
      - Point-to-Point, 3-10
      - Polling Mode D, 3-10
      - serial, described, 3-8
    - RF specifications, A-5
    - status icons, using to monitor, 3-14
    - troubleshooting, 4-11, 4-14
  - Configurable protocol
    - Character mode, described, 3-9
    - described, 3-9
    - Frame mode, described, 3-9
  - configuration
    - active, 2-4
    - current, 2-4
    - default, 2-4
  - configuration commands
    - Automatic Shutoff, 1-11
    - Flash Memory Configuration, 2-13
    - RAM Drive Size, 2-12
    - troubleshooting, 4-6, 4-7
    - See also the Trakker Antares 2400 Family System Manual*
  - Configuration Menu, defined, 2-4
  - Configuration Menu, problems while exiting, 4-6
  - configuring
    - booting the terminal on resume, 4-17
    - drives and memory, 2-12
    - flash memory, 2-13
    - network, overview, 3-11
    - protocol parameters
      - Binary, 3-8
      - Configurable, 3-9
      - Master Polling, 3-10
      - Point-to-Point, 3-10
      - Polling Mode D, 3-10
    - RAM drive, 2-12
    - summary of methods, 2-3
    - configuring (*continued*)
      - TRAKKER Antares 2400 Menu System, 2-4 to 2-11
      - troubleshooting, 4-6
    - connecting an input device, 1-24
    - connectivity options, described, A-4
    - connector modules, described, 1-23
    - connectors, pin assignments
      - COM1, A-6
      - input device, A-7
    - contrast, display, adjusting, 1-17
    - control characters, entering, 2-8
    - Control key, using, 1-14
    - conventions
      - bar code, defined, xi
      - commands, defined, xii
      - keypad, defined, x
      - screens and messages, defined, xi
      - warnings and cautions, defined, viii
    - copying configurations to another terminal, 2-11
    - current configuration, 2-4
    - customizing the terminal, 2-3
- ## **D**
- Data Collection Browser, *See* dcBrowser
  - dcBrowser, configuring, 3-12
  - DCS 30X, troubleshooting, 4-14
  - default configuration
    - described, 2-4
    - restoring, 4-5
  - Default Router command, determining when to configure, 3-14
  - defining, terminal drives, 1-25
  - determining when the battery pack is low, 1-8
  - diacritical marks, entering, 1-15
  - Diagnostics Menu, defined, 2-4
  - dimensions of the terminal, A-3
  - docking connector, terminal accessory, described, 1-6
  - documentation
    - bar code conventions, defined, xi
    - command conventions, defined, xii
    - keypad conventions, defined, x
    - screen and message conventions, defined, xi
    - summary of each chapter, ix
    - warnings and cautions, defined, viii
  - double-byte fonts, configuring flash memory, 2-13
  - drive C, described, 1-26
  - drive D
    - configuring, 2-13
    - described, 1-26
  - drive E
    - configuring, 2-12
    - described, 1-26
  - drive G, described, 1-26

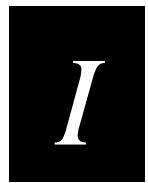

## E

- electrical specifications, A-3
- entering data
  - keypad, using, 1-13
  - troubleshooting, terminal locked up, 4-6
- environmental specifications, A-4
- equipment, required for network, 3-11
- error messages
  - application error, 4-13
  - audio signals, list of, 1-20
  - DCS 30X, 4-14
  - EOM or SOM configuration error, 4-8
  - network configuration error, 4-9, 4-10
  - PG command failed error, 4-9
  - POST failed, 4-4
  - screen error, 4-13
  - unable to connect to controller, 4-12
- escape characters, entering in screens, 2-9
- European languages keypad, described, 1-11
- exiting
  - screens, 2-9
  - TRAKKER Antares 2400 Menu System, 2-10
- extended ASCII characters, configuring, 2-8
- extended memory, specifications, A-4
- external power supply adapter cable, terminal accessory, described, 1-6
- external power supply, terminal accessory, described, 1-6

## F

- fields, filling in, 2-6
- firmware, resetting, 4-18
- flash memory
  - configuring, 2-13
  - saving configuration changes, 2-10
  - specifications, A-4
- Flash Memory Configuration command, 2-13
- fonts, double-byte, configuring flash memory, 2-13
- Frame mode
  - described, 3-9
  - troubleshooting, 4-8
- French
  - accent marks, entering, 1-15
  - keypad, described, 1-11
- Function Left key, using, 1-14
- function numeric keypad, options, described, 1-11
- Function Right key, using, 1-14

## G

- German
  - accent marks, entering, 1-15
  - keypad, described, 1-11

- Good Read LED
  - described, 1-4
  - scanning bar code labels, 1-22
  - troubleshooting, 4-16





## H

- handle, terminal accessory, described, 1-6
- handstrap
  - described, 1-4
  - installing, 1-10
  - removing, 1-9
- horizontal reading angle for scanning, 1-23
- host computer not receiving data, troubleshooting, 4-12

## I

- icons, status, *See* status icons
- input devices
  - connecting to the terminal, 1-24
  - interface cables, list of, A-6
  - list of, A-6
- installing
  - battery pack, 1-9
  - network, overview, 3-11
- integrated I/O connector, 1-4
  - connecting scanner, 1-23
  - described, 1-4
  - using, 1-20
- Intermec support services, vii
- Italian
  - accent marks, entering, 1-15
  - keypad, described, 1-11

## K

- keypad, 1-4
  - characters, capitalizing, 1-14
  - conventions, defined, x
  - international, using, 1-15
  - options, described, 1-11, A-4
  - special keys, finding, 1-12
  - terminal emulation
    - overlay options, described, 1-11
    - using, 1-16
  - typing characters, 1-13
  - using, 1-11 to 1-16
- keys
  - , using, 1-14
  - , using, 1-14
  - , using, 1-14
  - , using, 1-14
  - , using, 1-13
  - click, audio signals, 1-20
  - conventions, defined, x

## Trakker Antares 243X Hand-Held Terminal User's Manual

### keys (*continued*)

- Scan button, 1-21
- side scan buttons, 1-21
- special keys, finding, 1-12

## L

- languages, international keypads, 1-15
- laser scanner, *See* scanner
- LED, *See* Good Read LED
- lock up
  - application, troubleshooting, 4-18
  - terminal, troubleshooting, 4-6

## M

- Malloc/free dynamic memory pool, 2-12
- managing battery power, 1-11
- manual
  - audience and purpose, described, viii
  - bar code conventions, xi
  - command conventions, xii
  - keypad conventions, x
  - software screens and messages conventions, xi
  - summary of each chapter, ix
  - terminology, defined, ix
- Master Polling protocol, described, 3-10
- memory
  - described, 1-25
  - flash, saving configuration changes, 2-10
  - RAM, saving configuration changes, 2-10
  - specifications, A-4
- Menu System, *See* TRAKKER Antares 2400 Menu System
- menus
  - Configuration Menu, defined, 2-4
  - Diagnostics Menu, defined, 2-4
  - selecting, 2-6
  - System Menu, defined, 2-5
  - TRAKKER Antares 2400 Menu System, selecting, 2-6
- messages, conventions defined, xi
- Model 200 Controller
  - described, ix
  - See also* DCS 30X
- models, described, 1-3
- Modifier Key status icon, described, 1-19
- modifier keys, using, 1-14

## N

- NET port, 1-21
- network
  - communications
    - serial protocols, described, 3-8
    - troubleshooting, 4-11, 4-14
  - equipment required, 3-11

### network (*continued*)

- RF
  - TCP/IP direct connect, illustrated, 3-4
  - UDP Plus, illustrated, 3-4
- serial, illustrated, 3-3
- TCP/IP direct connect, illustrated, 3-4, 3-6
- UDP Plus, illustrated, 3-4, 3-5, 3-7
- Network Connect status icon
  - described, 1-18
  - troubleshooting, 4-11, 4-12
- Network Transmit status icon, described, 1-19
- notes, defined, viii

## O

- online help, accessing, 2-6
- OpenAir radio
  - access points, configuring, 3-13
  - specifications, A-5
- operating the terminal
  - humidity range, A-4
  - temperature range, A-4
  - troubleshooting, 4-4 to 4-6
- orange keys, using, 1-13

## P

- pin assignments
  - COM1, A-6
  - input device connector
    - serial connector module, A-7
    - standard connector module, A-7
- Point-to-Point protocol, described, 3-10
- Polling Mode D protocol, described, 3-10
- Portuguese
  - accent marks, entering, 1-15
  - keypad, described, 1-11
- POST
  - failed
    - error message, 4-4
    - status beeps, 1-20
  - success, status beeps, 1-20
- postamble, ASCII control characters, entering, 2-8
- power management
  - Battery status icon, 1-18
  - guidelines for, 1-11
- power supply, terminal accessory, described, 1-6
- preamble, ASCII control characters, entering, 2-8
- Preamble/Postamble screen, using, 2-8
- problems, finding and solving, 4-3
- protocol
  - Binary, described, 3-8
  - communications, described, 3-8
  - Configurable, described, 3-9
  - list of, A-5
  - Master Polling, described, 3-10

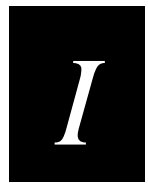

- protocol (*continued*)
  - Point-to-Point, described, 3-10
  - Polling Mode D, described, 3-10
  - RF
    - TCP/IP, described, 3-11 to 3-14, 3-12
    - UDP Plus, described, 3-11 to 3-14, 3-12
- protocol stack, checking the protocol loaded, 2-5
- Q**
- quiet zone, bar code labels, 1-22
- R**
- radio
  - 802.11b
    - access points, configuring, 3-13
    - specifications, A-5
  - OpenAir
    - access points, configuring, 3-13
    - specifications, A-5
  - troubleshooting, 4-11
- RAM
  - described, 1-26
  - RAM Drive Size command, 2-12
  - saving configuration changes, 2-10
  - specifications, A-4
- reader commands, troubleshooting, 4-5, 4-7
- resetting the terminal, 4-19
- resume
  - booting the terminal, 4-17
  - described, 1-13
- RF communications
  - radio specifications, A-5
  - site survey, planning, 3-11
  - status icons, using to monitor, 3-14
  - troubleshooting, 4-11
- RF network
  - equipment required, 3-11
  - illustrated, 3-4
  - installing, overview, 3-11
  - protocol, checking the protocol loaded, 2-5
  - terminal, configuring, 3-14
- RF port, 1-21
- running applications, troubleshooting, 4-13
- S**
- safety procedures, vii
- saving configuration changes
  - exiting screens, 2-9
  - TRAKKER Antares 2400 Menu System, exiting, 2-10
- Scan button, using, 1-21
- scanner
  - commands, listed, 1-24
  - connecting to terminal, 1-24
- scanner (*continued*)
  - troubleshooting, 4-15
  - See also* input devices
- screen
  - cleaning, 4-20
  - contrast, adjusting from the keypad, 1-17
  - conventions, defined, xi
  - specifications, A-4
  - status icons
    - Battery, 1-18
    - Caps Lock, 1-19
    - illustrated, 1-18
    - Modifier Key, 1-19
    - Network Connect, 1-18
    - Network Transmit, 1-19
    - User Defined, 1-19
- Security ID, troubleshooting, 4-6
- serial adapter cable, terminal accessory, described, 1-6
- serial communications, *See* serial port communications
- serial connector module
  - described, 1-23
  - pin assignments, A-7
- serial port, 1-4
  - communications
    - protocols, described, 3-8
    - troubleshooting, 4-6, 4-14
  - network, illustrated, 3-3
  - specifications, A-5
  - using, 1-20
- Shift key, using, 1-14
- shipping box, contents, 1-7
- side scan buttons, using, 1-21
- site survey, planning, 3-11
- sounds, *See* audio signals
- Spanish
  - accent marks, entering, 1-15
  - keypad, described, 1-11
- special keys, finding, 1-12
- standard connector module
  - described, 1-23
  - pin assignments, A-7
- start/stop codes conventions, defined, xi
- starting
  - steps for using the terminal, 1-26
  - TRAKKER Antares 2400 Menu System, 2-4
- status icons
  - Battery, 1-18
  - Caps Lock, 1-19
  - communications, using to monitor, 3-14
  - illustrated, 1-18
  - Modifier Key, 1-19
  - Network Connect, 1-18
  - Network Transmit, 1-19
  - troubleshooting, 4-11

## **Trakker Antares 243X Hand-Held Terminal User's Manual**

status icons (*continued*)  
  understanding, 1-18  
  User Defined, 1-19

storing the terminal  
  humidity range, A-4  
  temperature range, A-4

Subnet Mask command, determining when to configure, 3-14

subnetworks  
  terminal, using across, 3-5, 3-6, 3-7  
  *See also* network

Suspend mode  
  described, 1-13  
  managing battery power, 1-11

Suspend/Resume key, using, 1-13

System Menu, defined, 2-5

### **T**

TCP/IP direct connect network  
  checking the protocol loaded, 2-5  
  illustrated, 3-4, 3-6  
  parameters, listed, 3-14

TE 2000, *See* terminal emulation

temperature, operating and storage range, A-4

terminal  
  accessories, list of, 1-6  
  booting, 4-17  
  configuring  
    summary of methods, 2-3  
    using clone application, 2-11  
    using TRAKKER Antares 2400 Menu System, 2-4 to 2-11  
  described, 1-3  
  dimensions, A-3  
  drives, described, 1-25  
  features, described, 1-4  
  getting started, list of steps, 1-26  
  keypad options, described, 1-11  
  managing power, 1-11  
  manual, audience and purpose, viii  
  models, described, 1-3  
  options, described, 1-5  
  resetting, 4-19  
  scanner, using, 1-21  
  terminology, defined, ix  
  troubleshooting, guide to, 4-3

terminal emulation  
  application options, A-4  
  keypad  
    options, A-4  
    using, 1-16  
  overlay options, described, 1-11  
  session, problems establishing, 4-12

terminal emulation (*continued*)  
  status icons, using to monitor, 3-14  
  *See also* the *TE 2000 5250 Terminal Emulation Programmer's Guide*, *TE 2000 3270 Terminal Emulation Programmer's Guide*, or the *TE 2000 VT/ANSI Terminal Emulation Programmer's Guide*

terminology, defined, ix

TRAKKER Antares 2400 Menu System  
  ASCII control characters, entering, 2-8  
  check boxes, marking, 2-7  
  configuring the terminal, 2-4 to 2-11  
  exiting, 2-10  
  fields, filling in, 2-6  
  illustrated, 2-5  
  menus and commands, selecting, 2-6  
  RAM drive, configuring, 2-12  
  screens, exiting, 2-10  
  starting, 2-4

troubleshooting  
  audio signals, list of, 1-20  
  bar code symbologies, 4-5, 4-16  
  communications, using status icons, 3-14  
  configuring the terminal, 4-6  
  DCS 30X, 4-14  
  EOM or SOM configuration error, 4-6  
  guide to finding problems, 4-3  
  Intermec support services, vii  
  locked up application, 4-18  
  operating the terminal, 4-4 to 4-6  
  preventive maintenance, 4-20  
  resetting the terminal, 4-19  
  RF network communications, 4-11  
  running applications, 4-13  
  scanning bar code labels, 4-15  
  serial communications, 4-14  
  terminal locked up, 4-6  
  terminal will not turn on, 4-4

turning on the terminal  
  Ⓞ key, described, 1-13  
  troubleshooting, 4-4

typing characters on the keypad, 1-13

### **U**

UDP Plus network  
  illustrated, 3-4, 3-5, 3-7  
  parameters, listed, 3-14  
  terminal, checking the protocol loaded, 2-5

User Defined status icon, described, 1-19

using  
  integrated I/O port, 1-20  
  serial port, 1-20  
  terminal emulation keypads, 1-16  
  terminal scanner, 1-21

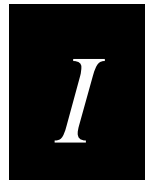

**V**

- vehicle dock
  - charging batteries, 1-9
  - terminal accessory, described, 1-6
- vertical reading angle for scanning, 1-23
- volume, adjusting, 1-19
- VT/ANSI terminal emulation, *See the TE 2000 VT/ANSI Terminal Emulation Programmer's Guide*

**W**

- warm boot, 4-19
- warnings, defined, viii
- warranty information, vii
- Wi-Fi certification, 1-3
- wireless communications, *See* RF communications

**Z**

- Z2400 battery charger, terminal accessory, described, 1-6



## Free Manuals Download Website

<http://myh66.com>

<http://usermanuals.us>

<http://www.somanuals.com>

<http://www.4manuals.cc>

<http://www.manual-lib.com>

<http://www.404manual.com>

<http://www.luxmanual.com>

<http://aubethermostatmanual.com>

Golf course search by state

<http://golfingnear.com>

Email search by domain

<http://emailbydomain.com>

Auto manuals search

<http://auto.somanuals.com>

TV manuals search

<http://tv.somanuals.com>