



IBM 10/100 Fast EtherLink® XL Adapters by 3Com

User Guide

OPTIONS
by IBM

The following paragraph does not apply to the United Kingdom or any country where such provisions are inconsistent with local law: INTERNATIONAL BUSINESS MACHINES CORPORATION PROVIDES THIS PUBLICATION "AS IS" WITHOUT WARRANTY OF ANY KIND, EITHER EXPRESS OR IMPLIED, INCLUDING, BUT NOT LIMITED TO, THE IMPLIED WARRANTIES OF MERCHANTABILITY OR FITNESS FOR A PARTICULAR PURPOSE. Some states do not allow disclaimer of express or implied warranties in certain transactions, therefore, this statement may not apply to you.

This publication could include technical inaccuracies or typographical errors. Changes are periodically made to the information herein; these changes will be incorporated in new editions of the publication. IBM may make improvements and/or changes in the product(s) and/or the program(s) described in this publication at any time.

This publication was produced in the United States of America. This publication was developed for products and services offered in the United States of America. IBM may not offer the products, services, or features discussed in this document in other countries, and the information is subject to change without notice. Consult your local IBM representative for information on the products, services, and features available in your area. It is possible that this publication may contain reference to, or information about, IBM products (machines and programs), programming, or services that are not announced in your country. Such references or information must not be construed to mean that IBM intends to announce such IBM products, programming, or services in your country.

Requests for copies of this publication and for technical information about IBM Personal Computer products should be made to your IBM authorized reseller or IBM marketing representative.

© Copyright International Business Machines Corporation 1998. All rights reserved.

Copyright © 1998, 3Com Corporation. All rights reserved.

CONTENTS

ABOUT THIS GUIDE

- Finding Specific Information in This Guide 1
 - Conventions 2
-

1 INTRODUCTION

- Industry-Leading Performance 1-2
 - DynamicAccess Software 1-2
 - Remote Wake-Up 1-3
 - Installation and Configuration 1-3
 - 10/100 Mbps Support 1-3
 - PC and Server Requirements 1-4
 - How Do I Install the 3C905B-TX Adapter? 1-4
-

2 INSTALLING THE ADAPTER

- Connecting to the Network 2-3
 - Connecting the Remote Wake-Up Cable 2-4
-

3 INSTALLING THE NETWORK DRIVER

- Windows 95 3-1
 - Confirming Installation 3-4
- Windows 98 3-5
 - Confirming Installation 3-5
- Upgrading from Windows 95 to Windows 98 3-6
- Windows NT 3-6
 - Windows NT Version 4.0 3-7
 - Updating the Network Driver 3-7
 - Installing the Network Driver 3-7

Windows NT Version 3.51	3-9
Updating the Network Driver	3-9
Installing the Network Driver	3-9
NetWare for Windows 3.1x, Windows for Workgroups, and DOS	3-10
AutoLink Requirements	3-10
Running the AutoLink Program	3-11
Installing the Novell NetWare Server Driver	3-12
NetWare Version 4.1	3-12
Multiple Adapters	3-13
Supported Network Drivers	3-14

4 CHANGING CONFIGURATION

Configuration Settings	4-1
Displaying Configuration Settings	4-2
Changing Configuration Settings	4-2
Changing PACE Configuration	4-4
Selecting PACE Applications	4-4
Changing PACE Ranges and Protocols	4-5
PACE Advanced Options	4-6
Setting Fast IP	4-6
Using the DOS Configuration Program	4-6

A SPECIFICATIONS

Specifications	A-1
RJ-45 Connector Pin Assignments	A-2

B TECHNICAL SUPPORT

Help and Service Information	B-1
Step 1. Problem Solving	B-2
Step 2. Preparing for the Call	B-3
Step 3. Placing the Call to IBM	B-3
Additional Technical Support Resources	B-4
Troubleshooting	B-4
Status LEDs	B-4

3Com NIC Diagnostics Program	B-6
Accessing the 3C905B-TX Adapter Help System	B-6
Displaying Release Notes, Frequently Asked Questions, and the KnowledgeBase	B-7
Running the Self-Test	B-7
Running the Echo Test	B-9
3Com Support Services	B-10
Removing the 3C905B-TX Adapter PACE and 3NICDIAGS Software	B-12
Windows 95 and Windows NT 4.0	B-12
DOS	B-12
Checking the Remote Wake-up Function	B-12
3Com DOS Diagnostic Program	B-13
Crossover Cable Troubleshooting Tips	B-14
Troubleshooting Hubs with Crossover Cable	B-15
Frequently Asked Questions	B-16
Accessing the 3Com World Wide Web Page	B-20

GLOSSARY

INDEX

STATEMENT OF LIMITED WARRANTY

NOTICES

FEDERAL COMMUNICATIONS COMMISSION (FCC) STATEMENT

INDUSTRY CANADA CLASS B EMISSION COMPLIANCE STATEMENT

AVIS DE CONFORMITÉ À LA RÉGLEMENTATION D'INDUSTRIE CANADA

**DEUTSCHE EMV-DIREKTIVE (ELECTROMAGNETISCHE
VERTRÄGLICHKEIT)**

EUROPEAN UNION - EMISSION DIRECTIVE

**UNION EUROPÉENNE- DIRECTIVE CONFORMITÉ
ÉLECTROMAGNÉTIQUE**

UNION EUROPEA - NORMATIVA EMC

**UNIONE EUROPEA - DIRETTIVA EMC (CONFORMIDAD
ELECTROMAGNÉTICA)**

TRADEMARKS

3COM END USER SOFTWARE LICENSE AGREEMENT

FIGURES

1-1	3C905B-TX Adapter	1-1
1-2	3C905B-TX Adapter Installation Steps	1-4
2-1	Inserting the Adapter	2-2
2-2	Connecting the Network Cable to the RJ-45 Port	2-3
2-3	Connecting the Adapter to the Connector	2-4
4-1	3Com NIC Diagnostics Program General Screen	4-3
4-2	3Com NIC Diagnostics Program Properties Screen	4-3
A-1	RJ-45 Connector Pin Assignments	A-2
B-1	LEDs	B-5
B-2	3Com NIC Diagnostics Program General Screen	B-8
B-3	Diagnostics Screen	B-8
B-4	3Com NIC Diagnostics Program Support Screen	B-11
B-5	Straight-through and Crossover Cable Pinouts	B-14

TABLES

1	Notice Icons	2
2	Text Conventions	2
3-1	Network Driver Text File Names	3-14
4-1	Option Settings	4-1
B-1	LED Descriptions	B-5
B-2	Frequently Asked Questions	B-16

ABOUT THIS GUIDE

About This Guide provides an overview of this guide, describes guide conventions, and tells you where to look for specific information.

This guide describes how to install, configure, and troubleshoot the IBM 10/100 Fast EtherLink® XL Adapters by 3Com.



If the information in the README.TXT file on the EtherDisk® diskette shipped with your product differs from the information in this guide, follow the instructions in the README.TXT file.

Finding Specific Information in This Guide

This table shows where to find specific information in this guide.

If you are looking for	Turn to
Adapter features and PC and server requirements	Chapter 1
Installation and cabling information	Chapter 2
Network driver installation instructions	Chapter 3
Instructions for changing configuration settings	Chapter 4
Specifications and RJ-45 pin assignments	Appendix A
Technical support	Appendix B
Troubleshooting	Appendix B

Conventions

Table 1 and Table 2 list conventions that are used throughout this guide.

Table 1 Notice Icons



Icon	Notice Type	Description
	Information note	Important features or instructions
	Caution	Information to alert you to potential damage to a program, system, or device
	Warning	Information to alert you to potential personal injury

Table 2 Text Conventions

Convention	Description
Commands	The word “command” means you must enter the command exactly as shown in text and press the Return or Enter key. Example: To launch the DOS diagnostics, enter the following command: a: install
Screen displays	This typeface represents information as it appears on the screen.
The words “enter” and “type”	When you see the word “enter” in this guide, you must type something, and then press the Return or Enter key. Do not press the Return or Enter key when an instruction simply says “type.”
<i>Menu commands and buttons</i>	Menu commands or button names appear in italics. Example: From the <i>Help</i> menu, select <i>Contents</i> .
Words in <i>italicized</i> type	Italics emphasize a point or denote new terms at the place where they are defined in the text.
Words in bold-face type	Bold text denotes key features.

1

INTRODUCTION

The IBM 10/100 Fast EtherLink® XL Adapters by 3Com provide a high-performance connection to an Ethernet or Fast Ethernet network. These adapters operate at 100 Mbps or 10 Mbps automatically, depending on the speed of the connected hub.

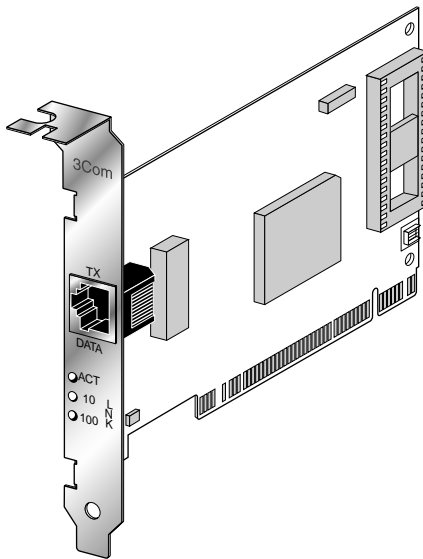

Figure 1-1 3C905B-TX Adapter

There are two types of 3C905B-TX adapters: the 3C905B-TX adapter with Remote Wake-Up and the 3C905B-TX-NM adapter without Remote Wake-Up.

The 3Com Remote Wake-Up adapter (3C905B-TX), shown in Figure 1-1, operates as a wake-up adapter only in PCs with the Remote Wake-Up connector attached to the PC motherboard. This adapter provides a network connection with or without the Remote Wake-Up connector installed.

The 3C905B-TX-NM adapter does not have the Remote Wake-Up connector or functionality.

Unless specifically indicated, the name 3C905B-TX is used throughout this guide to refer to both adapters.

This chapter describes the 3C905B-TX adapter features and PC and server requirements.

Industry-Leading Performance

The 3C905B-TX adapter provides the following performance features:

- Interactive Access technology to minimize CPU utilization
- Parallel Tasking® II architecture for high throughput and low processor utilization
- Full-duplex 10 Mbps and 100 Mbps support
- Hardware IP checksum enabled for better Internet and intranet performance
- Fast IP switching solution that allows you to cost-effectively scale internetwork performance as bandwidth requirements increase
- 32-bit bus master design with full scatter gather and infinite bursting performance
- Flow control (IEEE 802.1x), which optimizes performance in switched networks through efficient data transmissions

DynamicAccess Software

DynamicAccess® software delivers intelligence at the edge of the network to optimize network performance and control.

DynamicAccess features include PACE™ Interactive Access technology, dRMON (distributed RMON) support, and support for PACE real-time and multimedia applications.

PACE class of service drivers enable prioritization of multimedia and business-critical applications like video conferencing and distance learning. With the 3Com PACE drivers, you can set the class of service for each application.

The 3C905B-TX adapter ships with dRMON SmartAgent® intelligent agents that collect remote management information used by the Transcend® Edge Monitor System. Together, they provide full RMON network management information for both switched and Fast Ethernet networks.

Remote Wake-Up

Remote Wake-Up support is enabled for the 3C905B-TX adapter. If you are using the 3C905B-TX adapter in a PC that supports Remote Wake-Up through the PCI bus, the adapter will respond to a remote Wake-Up command or magic packet signal from a sleep state.

Installation and Configuration

The 3Com NIC Diagnostics program allows you to test the 3C905B-TX adapter, configure it, and display the adapter configuration information. If you are running DOS, you cannot use this program.

The NIC Diagnostics Help system includes the 3C905B-TX adapter Release Notes, Frequently Asked Questions, and KnowledgeBase.

Microsoft Windows 95 detects the 3C905B-TX adapter and installs the network driver from 3Com *EtherDisk Diskette #2*.

The AutoLink™ installation software automatically installs all Novell NetWare DOS ODI client software into your operating system.

10/100 Mbps Support

The single RJ-45 connector on the network cable supports 10 Mbps or 100 Mbps speeds.

NWay auto-negotiation enables the 3C905B-TX adapter to automatically run at the speed that the connected hub supports. The 3C905B-TX adapter works with products that comply with IEEE 10BASE-T and 100BASE-TX specifications.

PC and Server Requirements

Your PC or server must have:

- An 80386, 80486, or Pentium processor
- An available bus mastering PCI slot
- A minimum of 640K of memory



Make sure that you are running the latest BIOS for your PC or server, even if your PC is new. Contact your PC manufacturer for more information.

How Do I Install the 3C905B-TX Adapter?

To complete installation, install the adapter in your PC or server, connect it to the network, and install the network driver. The installation steps are depicted in Figure 1-2.

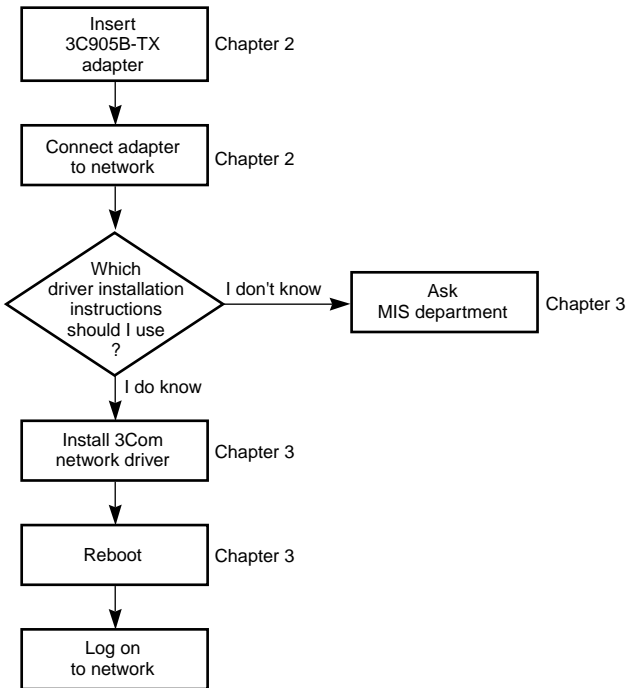

Figure 1-2 3C905B-TX Adapter Installation Steps

Proceed to Chapter 2 to install the 3C905B-TX adapter in your PC or server and connect it to the network.

2

INSTALLING THE ADAPTER

There are two types of 3C905B-TX adapters: the 3C905B-TX adapter and the 3C905B-TX-NM adapter. They are both installed in your PC and connected to the network in exactly the same way.

After you connect the 3C905B-TX adapter to the network, you connect the Remote Wake-Up cable to the motherboard.

Before you begin, make sure that you have the user guide and the 3C905B-TX adapter *EtherDisk* diskettes, and that your PC meets the requirements described in Chapter 1.



CAUTION: *Each adapter is packed in an antistatic container to protect it during shipment. Before handling the adapter, touch the metal chassis of your PC. Maintain grounding by wearing a wrist strap attached to the chassis. Handle the adapter by its backplate and top edge. Do not touch the edge connector.*

To install the 3C905B-TX adapter in your PC or server and connect it to the network, follow these steps:

- 1 Open the shipping container and inspect each item for damage.**
- 2 Remove all jewelry from your hands and wrists. Use only insulated or nonconductive tools.**
- 3 Unplug the PC and disconnect all cables.**
- 4 Remove the PC cover.**
- 5 Choose an empty bus mastering PCI slot.**

A sample PCI slot is shown in Figure 2-1. If you do not know how to identify a PCI slot, check your PC documentation or ask your system administrator. In most PCs, slots 1 and 2 are bus mastering slots. Use slot 1 for the 3C905B-TX adapter if possible. If you have a video PCI card, install it in the last slot (the one farthest from slot 1).

- 6 **Unscrew the screw holding the PCI slot's backplate and remove it.**
- 7 **Insert the 3C905B-TX adapter into an empty PCI slot, shown in Figure 2-1.**

Make sure that the adapter is firmly seated in the slot.

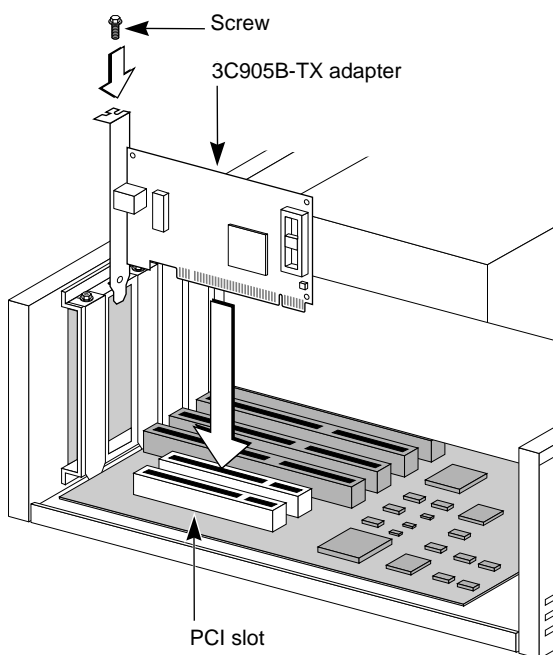

Figure 2-1 Inserting the Adapter

- 8 **Secure the adapter with the screw you removed earlier.**



If you are installing the Remote Wake-Up connector, go to "Connecting the Remote Wake-Up Cable," on page 2-4 at the end of this chapter before replacing the PC cover.

Remote Wake-Up is only supported in systems that provide a 3-pin header for a Wake-Up cable.

- 9 **Replace the PC cover and reconnect all previously connected cables.**
- 10 **Turn on the power to the PC.**

- 11 Proceed to the next section, "Connecting to the Network."

Connecting to the Network

You must connect the adapter to the network before installing the network driver. To connect the 3C905B-TX adapter to the network cable, follow these steps:

- 1 **Connect the network cable to the RJ-45 port on the 3C905B-TX adapter, as shown in Figure 2-2.**

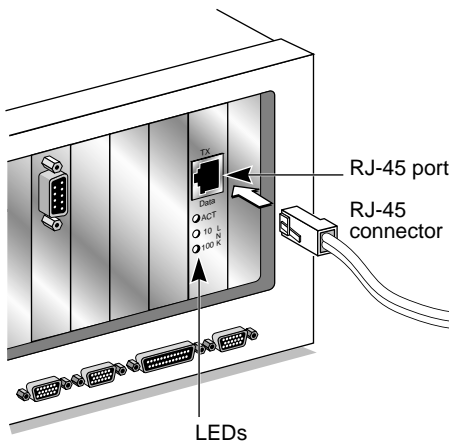

Figure 2-2 Connecting the Network Cable to the RJ-45 Port

- 2 **Connect the other end of the network cable to a 10BASE-T or a 100BASE-TX network port.**
- 3 **Check the LEDs, shown in Figure 2-2.**

After installation, and before you install the network driver, the LEDs indicate the following:

- 10 LNK LED - green - 10 Mbps link integrity
- 100 LNK - green - 100 Mbps link integrity
- ACT LED - OFF - until the network driver is installed

See Table B-1 for more LED information. If you are not installing the Remote Wake-Up cable, go to Chapter 3 to install the network driver.

Connecting the Remote Wake-Up Cable



WARNING: Install the adapter in slot 1 in the PC (as described earlier) before plugging in the 3-pin connector. Only properly trained and authorized personnel should perform service. Contact your PC manufacturer for information about safe service techniques.

1 Insert the cable into the connector on the adapter, shown in Figure 2-3.

Twist the cable twice before attaching the cable to the motherboard.

2 Attach the cable to the connector on the PC motherboard, as shown in Figure 2-3.

The connector is located in different locations depending on the PC.

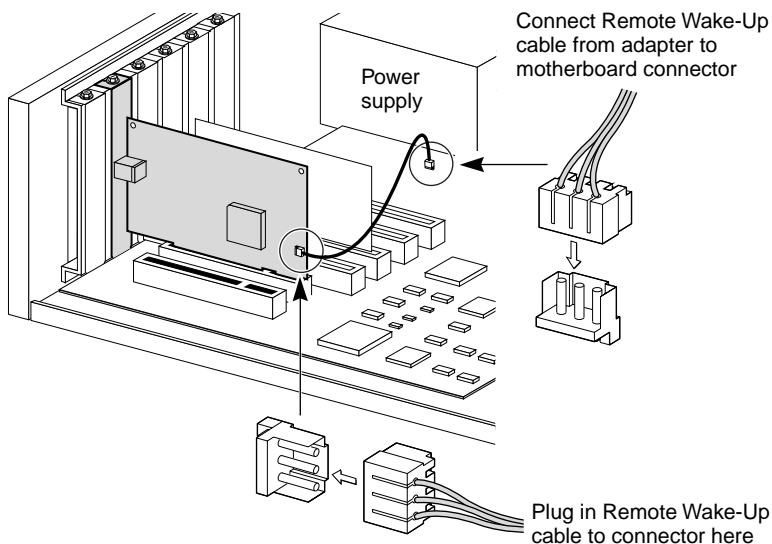

Figure 2-3 Connecting the Adapter to the Connector

3 Reconnect all cables and replace the PC cover.

The 3C905B-TX Remote Wake-Up adapter is installed. Go back to the previous section, "Connecting to the Network," to complete installation.

3

INSTALLING THE NETWORK DRIVER

This chapter describes how to install the network driver that completes your PC connection to the network. The 3C905B-TX adapter software is installed with the network driver.

Instructions are provided for Windows 95, Windows 98, Windows NT, and NetWare DOS client and server driver installation. Table 3-1 provides a complete list of supported drivers and text files that describe how to install them.

Go to the section your MIS department recommends and follow the instructions to install the network driver on your PC.

You can obtain the latest network drivers on 3Com's World Wide Web site. To access the Web site, enter the 3Com URL into your Internet browser:

http://infodeli.3com.com/infodeli/swlib/n_i_c.htm/

The drivers are in the Support area. On the Support Welcome screen, scroll down to *Latest Drivers* and click.

Windows 95

This section describes how to install the network driver when your PC is running Windows 95. This driver supports dRMON and PACE technology.

This driver can be used in Microsoft and NetWare environments, and instructions are included for both.

You need the Windows 95 system installation files (CAB files) to complete the installation.

Do not use the AutoLink software to install the driver if you are running Windows 95.

Follow these steps to install the network driver in a PC running Windows 95:

- 1 Install and configure Windows 95 before installing the 3C905B-TX adapter.**

- 2 Install the 3C905B-TX adapter and connect it to the network, as described in Chapter 2.**

- 3 Restart the PC.**

Windows 95 automatically detects the adapter in the PC.

If Windows 95 does not detect the 3C905B-TX adapter, see "Troubleshooting" in Appendix B.

- 4 Select *Driver from disk provided by the hardware manufacturer* and click *OK*.**

- 5 Insert *EtherDisk Diskette #2* in your drive and, if the diskette is in drive *A*, click *OK*.**

Otherwise, supply the correct drive letter and click *OK*.

Once the 3Com installation files are read, Windows 95 prompts you for the Windows 95 network installation files.

- 6 Enter the correct path to the Windows 95 files (CAB files) and click *OK*.**

If Windows prompts you to reboot, click *No*.

- 7 Open the Windows 95 Control Panel.**

- 8 In the Control Panel, double-click *Network*.**

The Network screen appears.

- 9 For Microsoft networks, select the Configuration tab. For Novell NetWare networks, go to step 10.**

The default Microsoft network setup contains the following components:

```
Client for Microsoft Networks
Client for Novell Networks
3Com EtherLink XL Adapter
3Com dRMON SmartAgent PC software
IPX/SPX compatible protocol
NetBEUI protocol
```

If a protocol is missing, follow these steps:

- a Select the protocol and click *Add*.
- b From the *Select Network Protocol* menu, select *Microsoft* in the left pane. In the right pane, select the protocol and click *OK*.

If a client is missing, follow these steps:

- a Select the client and click *Add*.
- b From the *Select Network Client* menu, select *Microsoft* in the left pane, select the client in the right pane, and click *OK*.

10 For NetWare only, on the Network screen, remove the following network components, if present:

Microsoft Client for Microsoft Network NetBEUI

The network components should now include:

Client for NetWare Networks

3Com EtherLink XL Adapter

3Com dRMON SmartAgent PC software

IPX/SPX Compatible Protocol

If a protocol is missing, follow these steps:

- a Select the protocol and click *Add*.
- b From the *Select Network Protocol* menu, select *Microsoft* in the left pane. In the right pane, select the protocol and click *OK*.

If a client is missing, follow these steps:

- a Select the client and click *Add*.
- b Select *Microsoft*.
- c Click *Client for NetWare Networks* and then *Properties*.

To select the NetWare server, follow these steps:

- a Under the General tab, set your preferred server and the first network drive and click *OK*.
- b Set the primary network logon to *Client for NetWare Networks* and click *OK*.

11 When the configuration is correct, click the **Identification** tab.

- The computer name is the name of your PC. Give your PC a unique name of up to 15 characters. The PC name cannot include blank spaces.
- A workgroup (such as your department) is composed of the PCs you usually communicate with and the workgroup's shared resources (such as printers).
- If you use peer group networking, the workgroup name is your peer group. Peers can see each other when they look in the Network Neighborhood.

For information on peer-to-peer networking, see the W95NDIS3.TXT file in the HELP directory on *EtherDisk Diskette #1*.

- Your computer description is visible to other members of your workgroup in the Network Neighborhood.

12 Click **OK**.

The network connection is configured. Windows 95 prompts you to restart the PC.

13 Click **Yes**.

After the PC restarts, you can log on to your network. If you have problems, see Appendix B.

Confirming Installation

Complete the following procedure to confirm that the 3C905B-TX adapter is properly installed:

1 Double-click the **My Computer** icon.

2 Double-click the **Control Panel** icon.

3 Double-click the **System** icon.

The System Properties box appears, detailing your system setup.

4 Click the **Device Manager** tab.

A list of devices appears, arranged by type.

5 Double-click **Network Adapters**.

The name of the installed 3C905B-TX adapter appears:
3Com EtherLink XL Adapter (3C905B)

- 6 **Double-click the 3C905B-TX name to display a description of the 3C905B-TX adapter and its current status.**

The dialog box confirms that the 3C905B-TX adapter is working properly. If a yellow exclamation point or a red X appears next to the adapter name, go to "Frequently Asked Questions" in Appendix B to troubleshoot the adapter.

- 7 **Click *Cancel* to leave each dialog box and return to the Control Panel.**

Windows 98

To install the network driver in a PC running Microsoft Windows 98, insert *EtherDisk Diskette #2* when the Update Device Driver wizard starts and prompts you for a diskette or CD.



Do not insert EtherDisk Diskette #1, because the installation will be unsuccessful.

Continue with the installation by following the prompts on the screen. For instructions, follow the Windows 95 installation steps on page 3-1 of this chapter.

Confirming Installation

To verify that the network driver was successfully installed in a PC running Windows 98:

- 1 **From the Windows *Start* menu, select *Settings*, and then select *Control Panel*.**
- 2 **Double-click the *System* icon, and then select the *Device Manager* tab.**
- 3 **Double-click *Network adapters* and make sure that the name of the EtherLink or Fast EtherLink XL adapter appears.**

If a red X appears next to the name of the adapter, the installation was not successful. If this occurs, verify that the adapter is not disabled by following these steps:

- a Double-click the name of the adapter.
- b Select the General tab.
- c Make sure that *Disable in this hardware profile* is not selected.

If the adapter is not disabled and a red X still appears next to the name of the adapter, update the driver by following these steps:

- a Double-click the name of the adapter.
- b Select the Driver tab, and then click the *Update Driver* button.
- c Insert *EtherDisk Diskette #2* when prompted for a disk. Continue with the installation by following the prompts on the screen.



If a yellow exclamation point (!) appears next to the name of the adapter, the installation is not complete. See Appendix B for troubleshooting help.

Upgrading from Windows 95 to Windows 98

If you are upgrading a PC from Windows 95 to Windows 98 that already has an EtherLink or Fast EtherLink XL (3C90xB) adapter installed, you may have to update the driver in the Device Manager using *EtherDisk Diskette #2*.

Follow the instructions in the previous section, "Verifying Successful Installation Under Windows 98," to determine if you have to update the driver.

Windows NT

This section describes how to install the network driver in a PC running Windows NT versions 4.0 or 3.51.

Do not use the AutoLink software to install the driver if you are running Windows NT.

Before you begin, obtain *EtherDisk Diskette #2* and Windows NT installation files (on hard disk, diskettes, or CD).

If Windows NT networking is not installed, you may also need the following information from your MIS department:

- Whether you are on a LAN or are connecting to one through a modem
- Protocol used in the Microsoft Windows Network (typically TCP/IP or NetBEUI)
- Name of the Windows NT server domain or workgroup you belong to
- IP address if you are not using DHCP

Windows NT Version 4.0

If you already have the 3C905B-TX network driver and want to update it, follow the instructions provided in the next section.

Updating the Network Driver

To update the driver, follow these steps:

- 1 Install the 3C905B-TX adapter and connect it to the network, as described in Chapter 2.**
- 2 Restart the PC and start Windows NT.**
- 3 In the Control Panel, double-click *Network*.**
- 4 In the Network window, select the Adapter tab.**
- 5 Select *3Com EtherLink XL NIC*.**
- 6 Click *Update*.**
- 7 Insert *EtherDisk Diskette #2*.**

The driver is updated.

Installing the Network Driver

Follow these steps to install the network driver in a PC running Windows NT version 4.0:

- 1 Install the 3C905B-TX adapter and connect it to the network, as described in Chapter 2.**
- 2 Restart the PC and start Windows NT.**
- 3 In the Control Panel, double-click *Network*.**
- 4 In the Network window, select the Adapter tab.**

If this 3C905B-TX adapter is replacing an adapter already installed, follow these steps:

- a Select the existing adapter (that is being replaced) in the Installed Adapters group.
- b Click *Remove*.
- c Click *Yes* in the Warning dialog box.
- d Reboot the PC and repeat steps 2, 3, and 4.

- 5 **Click *Add Adapter*.**
- 6 **In the Select Network Adapter window, select *Have Disk*.**
- 7 **Insert *EtherDisk Diskette #2* in drive A and in the Insert Disk window, click *OK*.**
- 8 **In the Select OEM Option box, select *3Com EtherLink Adapter (3C905B)*.**
- 9 **Click *OK*.**
- 10 **Select the Protocol tab.**
- 11 **Select the appropriate protocol for your network.**
- 12 **In the Network Settings window, click *Close*.**

If you are prompted for network information, enter the information supplied by your MIS department.
Windows NT prompts you to reboot.
- 13 **Click *Yes* to restart your PC.**

The driver installation is complete.

To confirm successful installation, double-click the *Network* icon in the Control Panel. Click the Adapters tab. The 3C905B-TX adapter should appear in the list. If it does not appear, see Appendix B for troubleshooting information.

Windows NT Version 3.51

If you already have the 3C905B-TX adapter network driver and want to update it, follow the instructions provided in the next section.

Updating the Network Driver

To update the driver, follow these steps:

- 1 Install the 3C905B-TX adapter and connect it to the network, as described in Chapter 2.**
- 2 Restart the PC and start Windows NT.**
- 3 In the Control Panel, double-click *Network*.**
- 4 Select the 3Com adapter and click *Properties*.**
- 5 Record the settings for the adapter resources.**
- 6 Click *Cancel*.**
- 7 Double-click *Network* again in the Control Panel.**
- 8 In the list of Network Software and Adapter Cards, select the 3Com adapter.**
- 9 Click *Update*.**
- 10 When prompted, enter the directory path (a:\), insert *EtherDisk Diskette #2*, and click *OK*.**
- 11 Click *OK* to close the Network dialog box and complete the process.**

Installing the Network Driver

Follow these steps to install the network driver in a PC running Windows NT version 3.51:

- 1 Install the 3C905B-TX adapter and connect it to the network, as described in Chapter 2.**
- 2 Restart the PC and start Windows NT.**
- 3 In the Control Panel, double-click *Network*.**
- 4 In the Network Settings window, click *Add Adapter*.**
- 5 In the Add Network Adapter window, select *<Other> Requires disk from manufacturer*.**
- 6 Click *Continue*.**

- 7 **Insert *EtherDisk Diskette #2* in drive A and click *OK*.**
- 8 **In the Select OEM Option box, select *3Com EtherLink XL PCI Adapter (3C905B)*.**
- 9 **Click *OK*.**

The Bus Location window appears.
- 10 **Click *OK*.**

Windows NT copies the files from *EtherDisk Diskette #2*.
If you are prompted for network information, contact your MIS department for the requested information.
- 11 **In the Network Settings Change window, click *OK*.**

Windows NT completes the installation.
- 12 **Click *Restart* to restart your PC.**

If you have problems, see Appendix B for troubleshooting information.

NetWare for Windows 3.1x, Windows for Workgroups, and DOS

The AutoLink program installs DOS client software and drivers for Novell NetWare in Windows 3.1x, Windows for Workgroups 3.11, and DOS environments.



CAUTION: *Do not use the AutoLink program if you are running Windows 95, Windows 98, or Windows NT.*

The AutoLink program modifies the CONFIG.SYS and AUTOEXEC.BAT files. It logs on to the server and updates the client software if your MIS department has already configured a 3Install account on your server.

AutoLink Requirements

To use the AutoLink program, your computer should have only one 3C905B-TX adapter installed and have 1 MB of free hard disk space.

Running the AutoLink Program

- 1 Install the adapter and connect it to the network, as described in Chapter 2.
- 2 Reboot, using a DOS diskette.
- 3 Insert *EtherDisk Diskette #1* in drive A.
- 4 Run the Install program. Enter:
`a:install`
This opens the main menu.
- 5 From the main menu, select *Auto Install and Config for NetWare (AutoLink)* and press Enter.
- 6 Select *DOS, Windows 3.1x, or Windows for Workgroups 3.11* and follow the instructions.
- 7 When the auto installation process is finished, remove *EtherDisk Diskette #1* and reboot the PC.



If you are running Windows 3.1x, after you connect to the NetWare server, run the WSINSTALL program for full Windows support. Contact your MIS department for the location of this NetWare utility.

If you experience problems that occur only when using the AutoLink program, display or print the AUTOLINK.LOG file. The AUTOLINK.LOG file contains a list of all the events that occurred during the AutoLink installation and configuration process.

- To display the file, enter:
`type autolink.log | more`
- To print the file, enter:
`print autolink.log`

Installing the Novell NetWare Server Driver

This driver is installed on a Novell NetWare *server* running NetWare 4.1.

The \NWSERVER subdirectory on *EtherDisk Diskette #1* contains the driver (3C90X.LAN file) and NetWare Loadable Modules (NLMs) needed for NetWare 4.1.

The NetWare server driver can also be used on a NetWare version 3.12 server. Contact Novell to obtain the NLM files and for instructions for installing the driver in a 3.12 environment. The NetWare 3.11 server is not supported by the 3C905B-TX adapter.

NetWare Version 4.1

This section describes how to install the NetWare server driver on *EtherDisk Diskette #1* on a NetWare version 4.1 server.

To import the server driver into a NetWare 4.1 server, follow these steps:

- 1 Install the NetWare server software.**
- 2 When the *NIC Selection* menu appears, insert *EtherDisk Diskette #1* in the drive.**
- 3 Press Insert to add a driver externally.**
- 4 Press F3 to change the path.**
- 5 At the A:\ prompt, enter:**

```
nwserver
```

The installation program gathers the files and prompts you for an adapter selection.

- 6 Select *3Com Fast EtherLink XL 10/100 Ethernet NIC*.**
- 7 Press Enter to continue the server installation.**

Multiple Adapters

To support more than one adapter in a server, edit the AUTOEXEC.NCF file to the following format:

```
load C:\SERVER\3C90X.LAN PORT=<port1>
NAME=<name1> FRAME=<frametype>
load C:\SERVER\3C90X.LAN PORT=<port2>
NAME=<name2> FRAME=<frametype>
```

Port1 and port2 are the 3C905B-TX adapter's PCI port addresses, and name1 and name2 are user-specified names assigned to distinguish the multiple adapters.

The FRAME parameter is optional. The default frame type is Ethernet_802.2. If you want the ODI server driver to support more than one frame type, then both the unique NAME= and FRAME= parameters must be paired on each load driver line. The valid frame types are Ethernet_802.2, Ethernet_802.3, Ethernet_II, and Ethernet_SNAP.

The protocols must be bound to the specific driver configuration using the user-assigned unique names. The following example shows how this can be done:

```
load C:\SERVER\3C90X.LAN PORT=1000
FRAME=Ethernet_802.3 NAME=ADPONE
load C:\SERVER\3C90X.LAN PORT=2000
FRAME=Ethernet_II NAME=ADPTWO
bind IPX to ADPONE
bind IPX to ADPTWO
```

The examples used may require other parameters to work properly. Consult the appropriate Novell NetWare manuals for details.

Supported Network Drivers

Table 3-1 provides the text file names and driver names for supported network drivers. These text files describe how to install the network driver and are located in the HELP directory on *EtherDisk Diskette #1*.

Table 3-1 Network Driver Text File Names

Network Operating System	Text File Name	Network Driver Name
Windows 95	W95NDIS.TXT	EL90XND3.SYS/ EL90XND4.SYS
Windows 95 NDIS 2	W95NDIS2.TXT	EL90X.DOS
Windows NT	WINNT.TXT	EL90XND3.SYS/ EL90XND4.SYS
NetWare Client 32	CLIENT32.TXT	3C90X.LAN
NetWare 4.1 Server	NETWARE.41X	3C90X.LAN
NetWare OS/2	NWOS2ODI.TXT	3C90X.SYS
NetWare client for DOS, Windows 3.1, and Windows for Workgroups	AUTOLINK.TXT (NETWARE directory)	3C90X.COM
Windows for Workgroups (NetWare)	WFWNETWR.TXT	3C90X.COM
Windows for Workgroups (NDIS 2)	WFWNDIS2.TXT	EL90X.DOS
Windows for Workgroups (NDIS 3)	WFWNDIS3.TXT	EL90X.386
Banyan VINES	BANYAN.TXT	EL90X.DOS
Microsoft LAN Manager	LANMAN.TXT	EL90X.DOS
IBM LAN Server (DOS)	LANSRV.TXT	EL90X.DOS
IBM LAN Server (OS/2)	LANSRV.TXT	EL90X.OS2
Artisoft LANtastic	LANTASTK.TXT	EL90X.DOS

4

CHANGING CONFIGURATION

This chapter describes how to display and change configuration settings for the 3C905B-TX adapter using the 3Com NIC Diagnostics program.

Before you change the settings, contact your system administrator.

Configuration Settings

Table 4-1 lists each configuration option, the default setting, and the available settings.

Table 4-1 Option Settings

Option	Default Setting	Available Settings
Network Driver Optimization	Normal	Minimize CPU Utilization, Maximize Network Performance, Normal
Full-Duplex	Auto Select	Enabled, Disabled, Auto Select
Boot PROM	Disabled	Disabled, 8K, 16K, 32K
Media Type	Auto Select	100BASE-TX, 10BASE-T, Auto Select
PACE	Disabled	Enabled, Disabled
NDIS Driver Speed	None	100 Mbps, 10 Mbps (Windows NT only), N/A (Windows 95)
Remote Wake-Up	No	Yes, No



CAUTION: Before setting the 3C905B-TX adapter for full-duplex, make sure that the switch port is also set to full-duplex or supports full-duplex and auto-negotiation (NWay).

Full-duplex at 100 Mbps improves the performance of switch (hub) connections. The 3C905B-TX adapter supports full-duplex at 10 or 100 Mbps. If the switch supports the NWay feature and full-duplex, the 3C905B-TX adapter automatically runs in full-duplex.

Displaying Configuration Settings

If you are running Windows 95, Windows 98, or Windows NT, use the 3Com NIC Diagnostics program to display and change configuration settings.



The 3Com NIC Diagnostics program is automatically installed with the network driver. Driver installation is described in Chapter 3.

To display the current configuration of the 3C905B-TX adapter using the 3Com NIC Diagnostics program, follow these steps:

- 1 Make sure that the 3C905B-TX adapter is installed and connected to the network (Chapter 2) and the network driver is installed (Chapter 3).**
- 2 Start the 3Com NIC Diagnostics program by clicking the Windows *Start* menu.**
- 3 Select *Programs*.**
- 4 Select *3Com NIC Utilities*.**
- 5 Select *3Com NIC Diagnostics*.**

The 3Com NIC Diagnostics Program General screen appears, as shown in Figure 4-1.

- 6 Click *NIC Details* to display the NIC Details screen.**

Each configuration setting is displayed with the current value. Use the scroll bar to display the full list.



Click the Help button to display Help for this screen. Click the question mark (?) at the top of the screen, drag it to a value, and click. The pop-up box displays information about the selected value.

Changing Configuration Settings

To change the 3C905B-TX adapter configuration settings with the 3Com NIC Diagnostics program, follow these steps:

- 1 Click the *Properties* tab on the 3Com NIC Diagnostics *General* screen, shown in Figure 4-1.**

The 3Com NIC Diagnostics Properties screen appears, as shown in Figure 4-2.

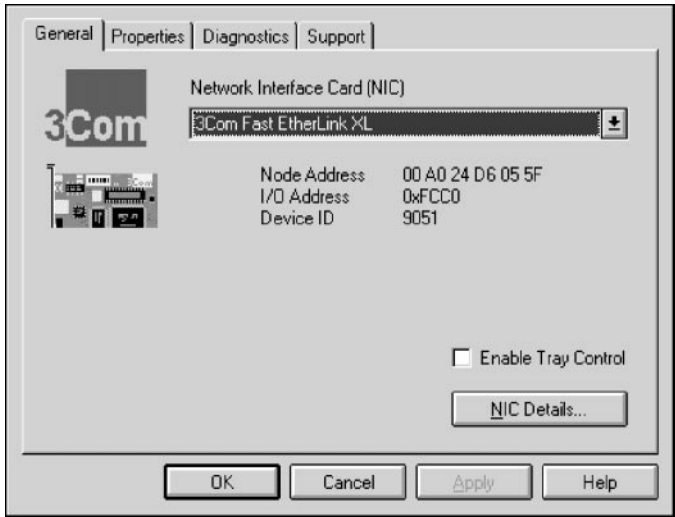

Figure 4-1 3Com NIC Diagnostics Program General Screen

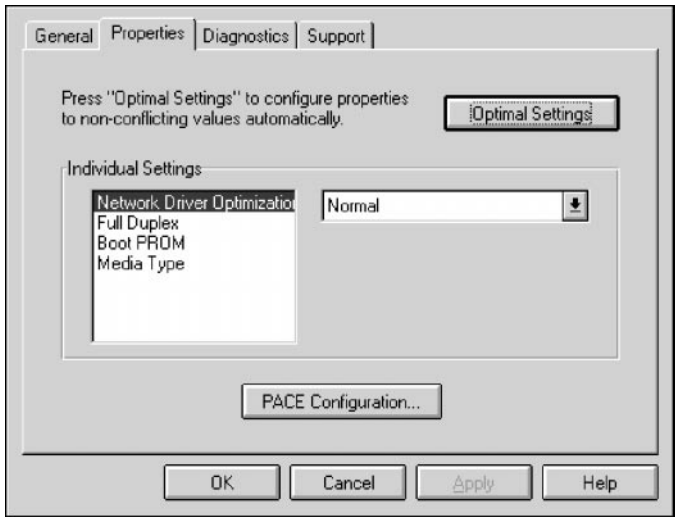

Figure 4-2 3Com NIC Diagnostics Program Properties Screen

- 2 To display the options for each setting, select the setting and scroll through the options pull-down menu to the right.



Click the Help button to display Help for this screen. Click the question mark (?) at the top of the screen, drag it to a value, and click. The pop-up box displays information about the selected value.

- 3 To select a new value, use the pull-down menu and release the mouse button at the value you want.
- 4 Click **OK**.

The new value is selected. Repeat the process to change any configuration setting on the Properties screen. Click **OK** to save values or *Cancel* to exit without saving values.

Changing PACE Configuration

PACE technology allows you to establish class of service in order to prioritize multimedia and real-time data. Prioritization makes sure that critical data for the selected applications gets through as fast as possible. To use PACE technology, you must have a switched connection over switches that are enabled for PACE technology.

Selecting PACE Applications

To select PACE applications, follow these steps:

- 1 On the Properties screen shown in Figure 4-2, click **PACE Configuration**.

The PACE Applications screen appears.

For the PACE driver to recognize high-priority network traffic, it must know if a stream of network traffic was generated by a specific PACE application.

- 2 To enable PACE support for an application, click the box next to the appropriate application name.
- 3 Click **OK**.

Changing PACE Ranges and Protocols

You can add information for PACE applications not listed on the PACE Applications screen. You must specify the port or socket ranges as well as the network protocol being used. Refer to the PACE application user guide. The PACE network driver uses these ranges to determine whether a packet should be treated as high-priority.

1 To add the PACE ranges and protocols, click the Additional Ranges tab.

The PACE Additional Ranges screen appears.

2 Enter the beginning of the port or socket range for the application in the Range Start box.

The range should be a four-digit hexadecimal value.

3 Enter the Range End value of the port or socket range for the application.

The range end should be a four-digit hexadecimal number. If only one port or socket is needed, Range End should match Range Start.

4 Select the protocol that the application uses.

The protocol can be TCP, UDP, or IPX. Some applications support multiple protocols and have port or socket ranges for each protocol. In this case, the range or protocol must match the protocol on the PC.

For example, if only TCP/IP is installed, do not enter the socket range for IPX; otherwise, you could experience a decrease in performance.

5 Once the Range Start, Range End, and Protocol are entered, click *Add*.

The range is added to the list.

To remove a range, select the range in the list and click *Remove*.

PACE Advanced Options

PACE Advanced Options are used to fine-tune the way the network driver handles types of PACE traffic. In general, these values need not be altered. Contact your network administrator before using these options.

- 1 **To display the PACE Advanced Options screen, click the Advanced Options tab on the PACE Applications screen.**

The PACE Advanced Options screen appears.

- 2 **Enter new information as required.**
- 3 **Click *OK* to set the new value.**

To review the PACE settings descriptions, click *Help* on the PACE screens.

Setting Fast IP

You can use Fast IP to improve performance in an environment where most servers and clients are attached to a switched network. Contact your system administrator before you implement Fast IP.

You must have the 3C905B-TX adapter installed and be running either Windows 95 or Windows NT with TCP/IP enabled. In this environment, any application that uses TCP/IP or Microsoft Networking over TCP/IP, FTP, or HTTP can use Fast IP.

For a detailed explanation of Fast IP, go to the 3Com Web site at:

<http://www.3com.com/>

- 1 **Click the Fast IP tab on the PACE Applications screen.**
- 2 **To enable Fast IP, click *Fast IP enabled* on the Fast IP screen.**
- 3 **Click *OK* to save the change.**

Using the DOS Configuration Program

To use the DOS diagnostic program, see the INSTRUCT.TXT file in the HELP directory on *EtherDisk Diskette #1*.



SPECIFICATIONS

This appendix lists the specifications and connector pin assignments for the 3C905B-TX adapter.

Specifications

Network Interface

10 Mbps Ethernet 10BASE-T	Ethernet IEEE 802.3 industry standard for a 10 Mbps baseband CSMA/CD local area network
100 Mbps Ethernet 100BASE-TX	Ethernet IEEE 802.3u industry standard for a 100 Mbps baseband CSMA/CD local area network

Physical Dimensions

Height:	8.57 cm (3.75 in.)
Length:	12.07 cm (4.75 in.)

Environmental Operating Range

Operating temperature:	0° to 70 °C (32° to 158 °F)
Humidity:	10 to 90% noncondensing

Power Requirements

Operating voltage:	+5 V ± 5% @ 650 mA max
--------------------	------------------------

RJ-45 Connector Pin Assignments

Figure A-1 shows the RJ-45 connector pin assignments for the 3C905B-TX adapter.

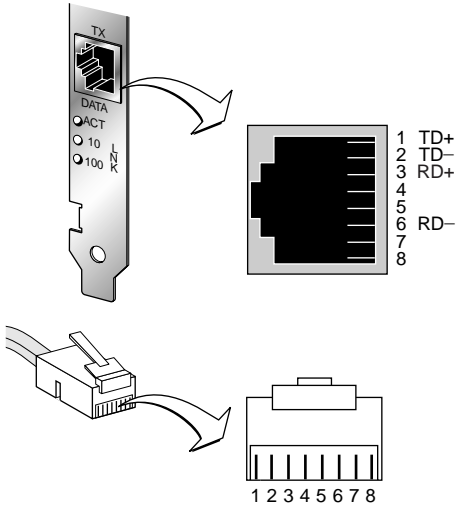
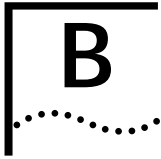

Figure A-1 RJ-45 Connector Pin Assignments



TECHNICAL SUPPORT

Help and Service Information

If you have questions about your new Options by IBM product, or require technical assistance, visit the IBM Personal Computing Web site at:

<http://www.pc.ibm.com>

for information about IBM, Options by IBM, or IBM Service and Support. Additionally, you can receive information from the IBM Automated Fax system at 1-800-426-3395 (in Canada, 1-800-465-3299), or from the Personal Systems Group Bulletin Board System (PSG BBS) at 1-919-517-0001. You can also get help and information through the IBM PC HelpCenter, 24 hours a day, seven days a week. Response time may vary depending on the number and nature of the calls received.

Marketing, installation, and configuration support through the HelpCenter will be withdrawn or made available for a fee, at IBM's discretion, 90 days after the option has been withdrawn from marketing. Additional support offerings, including step-by-step installation assistance, are available for a nominal fee.

During the warranty period, assistance for replacement or exchange of defective components is available. In addition, if your IBM option is installed in an IBM computer, you might be entitled to service at your location. Your technical support representative can help you determine the best alternative.

Step 1. Problem Solving

You may be able to solve the problem yourself. Before calling the HelpCenter, please prepare for the call by following these steps:

- 1 If you are having installation or configuration problems, refer to the detailed sections on installation found in this manual, and review any README.TXT files found on the installation diskettes.**
- 2 Visit the Service and Support section of the Personal Computing Web site specific to the model of option you have purchased. Updated installation instructions, hints and tips, or updated system-specific notes are often published in this section. You might find that later device drivers are available that will improve the performance and compatibility for your new option.**

If you are installing this option in an IBM computer, also visit the applicable Web page for that computer model. These pages might also contain useful hints and tips related to installation of this option and might refer to BIOS or device-driver updates required for your computer model. If you are installing the option in a non-IBM computer, refer to the manufacturer's Web site.

- 3 Uninstall, and then reinstall the option. During the uninstallation process, be sure to remove any files that were installed during the previous installation. Many IBM options include uninstallation programs.**
- 4 Check all cabling to be sure that it is correct as shown in this manual. When you connect a cable to a cable connector, pay close attention to the colored stripes along the edge of the cable, and ensure that they are matched with PIN 1, on both the computer connector and the option connector.**
- 5 If your option contains jumpers or switches, be sure their positions and orientation match the instructions in this manual.**

Step 2. Preparing for the Call

To assist the technical support representative, have available as much of the following information as possible:

- 1 **Option name**
- 2 **Option number**
- 3 **Proof of purchase**
- 4 **Computer manufacturer, model, serial number (if IBM), and manual**
- 5 **Exact wording of the error message (if any)**
- 6 **Description of the problem**
- 7 **Hardware and software configuration information for your system**

If possible, be at your computer. Your technical support representative might want to walk you through the problem during the call.

Step 3. Placing the Call to IBM

If you call 90 days or more after the date of withdrawal or after your warranty has expired, you might be charged a fee.

For the support telephone number and support hours by country, refer to the following table or to the enclosed technical support insert. If the number is not provided, contact your IBM reseller or IBM marketing representative.

Support 24 hours a day, 7 days a week	
Canada	1-800-565-3344
U.S.A. / Puerto Rico	1-800-772-2227

Additional Technical Support Resources

Online assistance can be obtained through the IBM Automated Fax System, the Personal Computing Web page, and the PSG Electronic Bulletin Board System.

Online Technical Support

IBM Personal Computing Web Page	www.pc.ibm.com
IBM PSG BBS	1-919-517-0001
IBM Automated Fax System	1-800-426-3395 1-800-465-3299 (in Canada)

Troubleshooting

The following sections explain how to isolate and solve adapter problems, including the following topics:

- Status LEDs
- 3Com NIC Diagnostics program
- Accessing the 3C905B-TX adapter Help system
- 3Com support services
- Removing the 3C905B-TX adapter software
- Checking Remote Wake-Up
- Crossover cable troubleshooting tips
- Frequently Asked Questions
- Accessing the 3Com World Wide Web page



The 3Com World Wide Web site offers the latest drivers, troubleshooting information, and software updates in the Support area. To access the Web site, enter the 3Com URL address into your Internet browser:

`http://infodeli.3com.com/infodeli/swlib/n_i_c.htm/`

Status LEDs

Before the LEDs can be used for troubleshooting, the adapter must be connected to the network (Chapter 2) and the network driver must be installed (Chapter 3).

The 3C905B-TX adapter has three status LEDs, as shown in Figure B-1 and described in Table B-1.

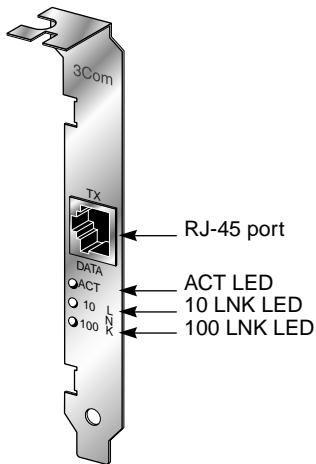

Figure B-1 LEDs

Table B-1 LED Descriptions

LED	Description	Flashing	Steady	Off
10 LNK	Green: Link integrity	Reversed polarity	Good 10BASE-T connection between adapter and hub	No connection between adapter and hub
100 LNK	Green: Link integrity	Reversed polarity	Good 100BASE-TX connection between adapter and hub	No connection between adapter and hub
ACT	Yellow: Port traffic for either speed	Network traffic present	Heavy network traffic	No traffic

3Com NIC Diagnostics Program

Use the 3Com NIC Diagnostics program for Windows 95 and Windows NT to test the 3C905B-TX adapter and change configuration. To change the adapter's configuration, see Chapter 4. If you are running NetWare Client 32 with the NetWare ODI driver, use the DOS diagnostic program described in the INSTRUCT.TXT file in the HELP directory on *EtherDisk Diskette #1*.



The 3Com NIC Diagnostics program is installed with the driver. Driver installation is described in Chapter 3. You must install the driver before you run the program.

Accessing the 3C905B-TX Adapter Help System

You can display the 3C905B-TX adapter Help system, a Windows Help application that includes 3C905B-TX adapter Release Notes, Frequently Asked Questions, and the 3C905B-TX adapter KnowledgeBase. The Help system was installed with the network driver.

To display the 3Com Help system, follow these steps:

- 1 Install the 3C905B-TX adapter, connect it to the network (Chapter 2), and install the driver (Chapter 3).**
- 2 Click the *Windows Start* menu.**
- 3 Select *Programs*.**
- 4 Select *3Com NIC Utilities*.**
- 5 Select *3Com NIC Diagnostics Help*.**
The Help screen for the 3Com NIC Diagnostics General screen appears.
- 6 Click the links to display information about each of the 3Com NIC Diagnostics screens.**

Displaying Release Notes, Frequently Asked Questions, and the KnowledgeBase

To access the Release Notes, Frequently Asked Questions, and KnowledgeBase information, follow these steps:

- 1 **Click the Support tab, shown in Figure B-2.**
- 2 **Click the *Release Notes* button on the Support screen.**

The Release Notes Help screen appears.

- Click the *Release Notes* link to display tips about installing and using the 3C905B-TX adapter.
- Click the *Frequently Asked Questions* link to display common questions asked by customers and answered by 3Com support experts.
- Click the *KnowledgeBase* link to display 3C905B-TX adapter compatibility topics.



To display the entire Help system, click the Help button on each NIC Diagnostics screen. To display information about any item on each screen, click the question mark (?), drag it to the item, and click. The pop-up box displays information about the selected item.

Running the Self-Test

Run the self-test to check the physical components, connectors, and circuitry on the adapter.

- 1 **Make sure that the 3C905B-TX adapter is installed and connected to the network (Chapter 2) and the network driver is installed (Chapter 3).**
- 2 **Start the 3Com NIC Diagnostics program by clicking the Windows *Start* menu.**
- 3 **Select *Programs*.**
- 4 **Select *3Com NIC Utilities*.**
- 5 **Select *3Com NIC Diagnostics*.**

A warning message appears. Click *OK* to disconnect your PC from the network to conduct this test.

The 3Com NIC Diagnostics General screen appears, as shown in Figure B-2.

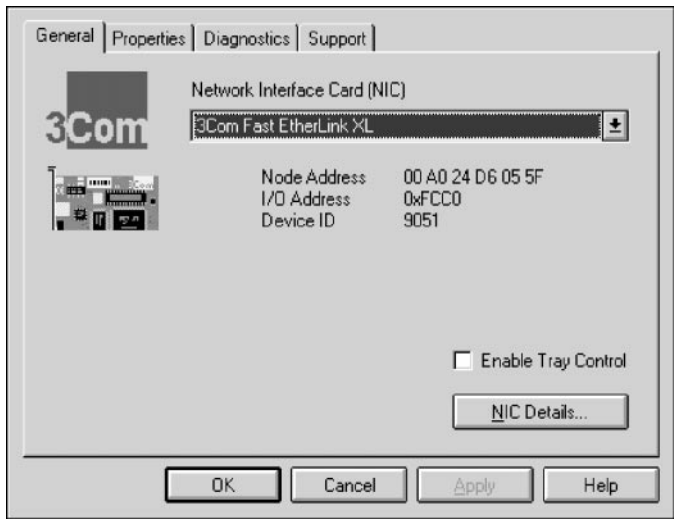

Figure B-2 3Com NIC Diagnostics Program General Screen

To access the 3Com NIC Diagnostics program later by clicking its icon in the system tray, click the check box next to Enable Tray Control.

- 6 Click the **Diagnostics** tab to display the **Diagnostics** screen, shown in **Figure B-3**.

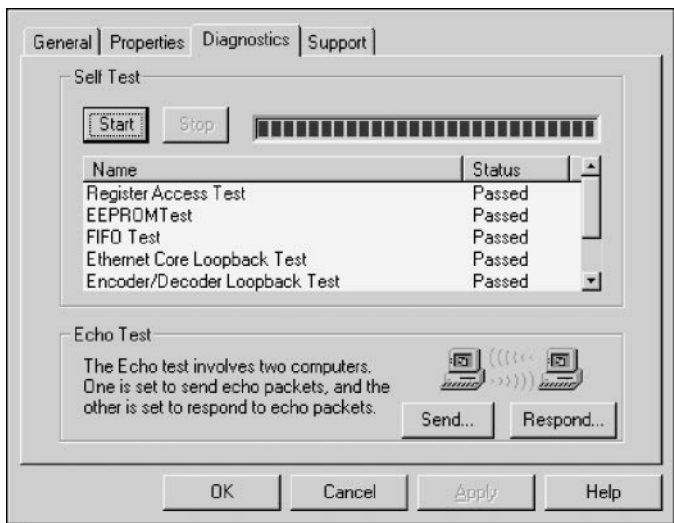

Figure B-3 Diagnostics Screen

7 Click **Start** in the **Self-Test** area.

The following tests run in sequence:

- Register Access
- EEPROM
- FIFO
- Ethernet Core Loopback
- Encoder/Decoder Loopback
- Interrupt

You can click *Stop* to stop the tests. Otherwise, the tests run continuously to completion.



Click the Help button to display help for this screen. Click the question mark (?) at the top of the screen, drag it to a test, and click. The pop-up box displays information about the selected test and what to do if the test fails.

Running the Echo Test

The echo test tests the 3C905B-TX adapter's ability to transmit and receive data while on the network.

You need two PCs with 3Com adapters or IBM 10/100 Fast EtherLink XL Adapters by 3Com installed to run an echo test: one PC to send data and one PC to receive data.



CAUTION: *Running the echo test while connected to an active network can cause intermittent failures. To avoid this, connect to an inactive network on which only the PC being tested is operating.*

To run the echo test, follow these steps:

- 1 Make sure that the 3C905B-TX adapter is installed in the sending PC and connected to the network (Chapter 2) and that the network driver is installed (Chapter 3).**
- 2 Install a 3C905B-TX adapter in another PC (the echo server), connect it to the network, and install the network driver.**

The echo server PC is the *responding* PC.

3 On both PCs:

- a Click the Windows *Start* menu.
- b Select *Programs*.
- c Select *3Com NIC Utilities*.
- d Select *3Com NIC Diagnostics*.
- e Click the Diagnostics tab to display the Diagnostics screen, shown in Figure B-3.

4 Click *Respond* on the Diagnostics screen (Figure B-3) of the responding PC.

The Echo Test Responder screen appears on the responding PC.

5 Click *Start* on the Echo Test Responder screen.**6 On the Diagnostics screen (Figure B-3) of the sending PC, click *Send*.****7 On the Diagnostics screen (Figure B-3) of the sending PC, click *Start*.**

The statistics for the test appear in the Statistic section of the window.



Click the Help button to display Help for this screen. Click the question mark (?) at the top of the screen and drag it to a statistic and click. The pop-up box displays information about the selected statistic.

3Com Support Services

The 3Com NIC Diagnostics Program Support screen, shown in Figure B-4, provides access to the following support services:

- 3Com NIC Diagnostics program
- 3C905B-TX adapter Release Notes
- 3Com BBS telephone numbers and modem speeds
- 3Com World Wide Web information
- 3Com problem report generator (not available to IBM)

- 1 To access the 3Com NIC Diagnostics support screen, click the **Support** tab on the 3Com NIC Diagnostics program main screen, shown in Figure B-2.

The 3Com NIC Diagnostics Program Support screen appears, shown in Figure B-4.

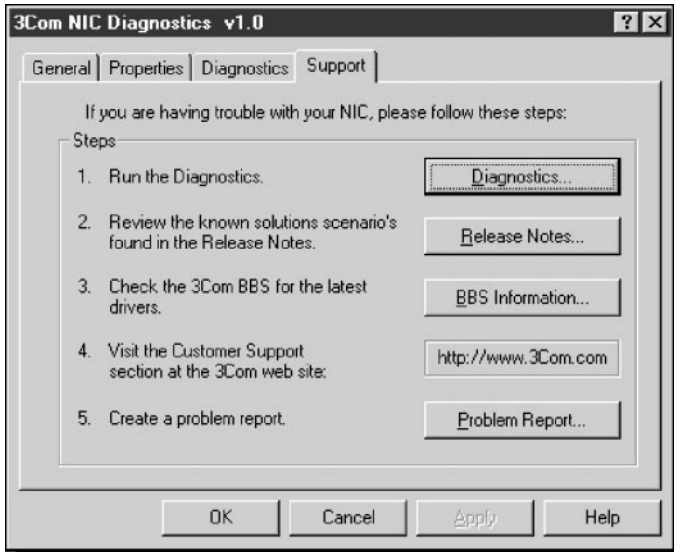

Figure B-4 3Com NIC Diagnostics Program Support Screen

- Click *Diagnostics* to run the 3Com NIC Diagnostics program. Refer to the beginning of this chapter for information on how to use the 3Com NIC Diagnostics program.
- Click *Release Notes* to display the 3C905B-TX adapter Release Notes, Frequently Asked Questions, and the 3C905B-TX adapter KnowledgeBase.
- Click *BBS Information* to display the BBS telephone numbers and modem speeds.
- *The http...* button displays the 3Com World Wide Web address.

Removing the 3C905B-TX Adapter PACE and 3NICDIAGS Software

You can remove the PACE and 3NICDIAGS software from your PC using Windows 95, Windows NT, or DOS.

Windows 95 and Windows NT 4.0

To remove the PACE and 3NICDIAGS software, follow these steps:

- 1 In the Windows Control Panel, select *Add/Remove Programs*.**
- 2 Select *3Com NIC Diagnostic Utilities*.**
- 3 Click *Add/Remove*.**

The 3C905B-TX adapter software is removed from your PC.

DOS

To remove the PACE and 3NICDIAGS software, at the DOS prompt, enter:

un3c90x.exe

The program removes the 3C905B-TX adapter software.

Checking the Remote Wake-up Function

If the PC does not boot up when a Magic Packet wake-up packet is sent, perform these general troubleshooting steps:

- 1 Verify that the Wake on Link and Wake on Magic Packet settings are enabled.**
 - a** Click the *Network Neighborhood* icon.
 - b** Click *Properties*.
 - c** Double-click the *3Com NIC* icon and click the *Advanced* tab.

Make sure that Wake on Link and Wake on Magic Packet are enabled. If these settings do not exist, either the adapter is not a Remote Wake-Up adapter or the driver installation file is outdated. For the latest 3C905B-TX drivers and installation files, download *EtherDisk* diskette 3.1 or later from the 3Com Web site:

<http://www.3com.com/>

2 Verify the driver version.

The driver must be at least version 2.23.40.

a Click *Properties*.

b Click the Version tab.

c Check the EL90X.SYS driver version.

If the version is lower than 3.1, download an updated version of the driver from the 3Com Web site:

<http://www.3com.com/>

3 If the version of the driver is up to date, the keywords are enabled, and the PC still does not wake up, check the BIOS.

a Boot the PC and enter the BIOS.

b Locate the Wake-Up on PME signal or Wake-Up on LAN event setting.

c Verify that the setting is enabled.

If you experience difficulties locating these settings, consult the reference manual for your PC, or contact your PC vendor.

4 Remove the PC cover and check the Remote Wake-Up connection.

Verify that the Remote Wake-Up cable is plugged in to the adapter as well as to the motherboard. Unplug and reinsert the cable if necessary.

5 If the adapter still does not wake up, install a known good working Remote Wake-Up adapter and the Remote Wake-Up cable in the PC and recheck the PC.

If the PC works, contact your network vendor for a replacement of the 3Com adapter. After you verify with a known good working adapter that the PC still does not wake up, there may be a problem with the motherboard. Contact your PC vendor.

3Com DOS Diagnostic Program

For information about running the 3Com DOS diagnostic program, see the INSTRUCT.TXT text file in the HELP directory on *EtherDisk Diskette #1*.

Crossover Cable Troubleshooting Tips

When you work with network cabling, concentrators, and adapters from different vendors, it is possible to connect everything and still have no communication between file servers and workstations.

When there are several unknown variables, it is difficult to determine which component is broken. Use these tips to isolate the problem.

1 Determine whether your equipment complies with the 10BASE-T or 100BASE-TX standard.

This is particularly important for concentrators (hubs or repeaters).

2 Connect a straight-through cable from the PC to the hub.

The hub performs an internal crossover so that the signal can go from TD+ to RD+ and TD- to RD-. When you look at an RJ-45 connector from the front, pin 1 is identified on the left-hand side when the metal contacts are facing up.

3 Make sure that the TD+ and TD- wires are twisted together, and that the RD+ and RD- wires are twisted together. The example in Figure B-5 shows 10BASE-T cabling.

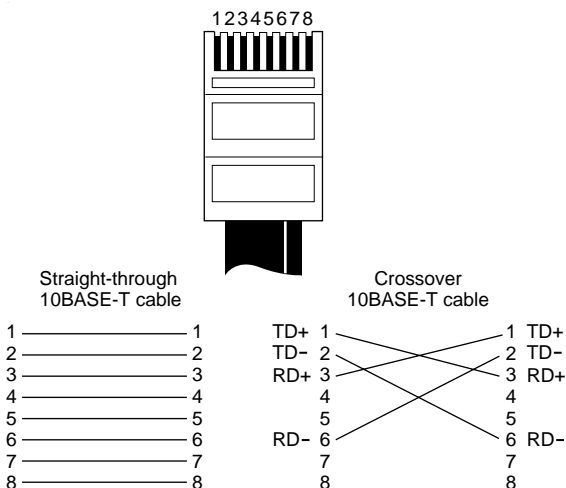

Figure B-5 Straight-through and Crossover Cable Pinouts

Using wires from opposing pairs can cause signals to be lost. For a 100BASE-TX cable, pins #1 and #2, and #3 and #6 must be on the same twisted strand.

Troubleshooting Hubs with Crossover Cable

When there is doubt whether a hub is performing correctly, or if the impedance settings are in question, a crossover cable can help you isolate the failing component.

- 1 Connect a file server and a client PC back to back with a crossover cable to verify that the adapter and network operating system are properly configured.**
- 2 To make a crossover cable, simply connect TD+ to RD+ and TD- to RD-.**

The cable performs the crossover that is usually performed by the hub. Make sure that two twisted-pair wires are used. Figure B-5 shows the pinouts for the crossover cable. On the straight-through cable, make sure that the wires are from the same twisted pair.

If the file server and client PC function together as a small network, then either the existing cabling or the hub is the problem.

- If there is a proper crossover, the appropriate LED comes on.
- If there is a straight-through connection, the LED does not light.
- A blinking LED indicates that there is a polarity mismatch (that is, TD+ to RD- instead of TD+ to RD+).

Frequently Asked Questions

Table B-2 describes some common questions and answers about the 3C905B-TX adapter.

Table B-2 Frequently Asked Questions

Question	Answer
Which PCI slot is best for my PCI adapter?	3Com PCI adapters are designed to work in any bus mastering PCI slot, preferably slot 1. Avoid any PCI slot next to an ISA slot. This is often a shared slot and does not support bus mastering. The adapters perform best in those slots that support bus mastering data transfers. Refer to your PC manual for information on which slots support bus mastering data transfers.
Do I have to configure the 3C905B-TX adapter?	PCI is a self-configuring bus architecture. Most of the time you only need to install the board in your PC; PCI does the rest. However, on some PCI computers, you may be required to configure the computer's BIOS manually after installing your PCI adapter. Refer to the owner's guide for your PC.
What interrupts should I avoid?	<p>You should avoid using any interrupts used by ISA/EISA boards that do not properly support shared interrupts (level-triggered).</p> <p>If you do not know or are unsure whether other devices or adapters in your PC support shared interrupts, then avoid using them.</p> <p>Avoid using the same interrupt as your local hard drive (normally IRQ 14 for IDE drives and IRQ 11 for most SCSI host adapters), since not all hard drives support shared interrupts at this time.</p> <p>Avoid using 9 because it cascades with 2.</p> <p>For Novell NetWare servers, avoid using IRQ 7 or 15. These IRQs only support nonshared devices and may cause problems if they are shared between two devices.</p>
Are my Fast EtherLink XL network drivers Microsoft-certified?	Yes, the Fast EtherLink XL network drivers are Microsoft-certified.
Are my Fast EtherLink XL Bus Master ODI drivers Novell-certified?	Yes, the Fast EtherLink XL ODI drivers are Novell-certified.

(continued)

Table B-2 Frequently Asked Questions (continued)

Question	Answer
How do I remove the 3Com icon from my system tray?	<ol style="list-style-type: none"> 1 Double-click the <i>3Com</i> icon to start the 3Com NIC Diagnostics program. 2 In the right bottom corner of the main window, click the <i>Enable Tray Control</i> check box to remove the check mark. 3 Exit the program and the icon will not appear anymore.
How can I get a SCO driver?	<p>You can get the SCO driver from the 3Com World Wide Web site.</p> <ol style="list-style-type: none"> 1 Enter the 3Com URL: http://www.3com.com/ 2 Click <i>Drivers</i>. 3 Click <i>Latest Drivers</i>. 4 Download the required files. <ul style="list-style-type: none"> ■ 90XSCO3.EXE is for SCO Open Desktop. ■ 90xSCO5.EXE is for SCO Open Server.
How can I remove the 3C905B-TX adapter PACE and 3NICDIAGS software?	<ol style="list-style-type: none"> 1 In the Windows 95 Control Panel, select <i>Add/Remove Programs</i>. 2 Select <i>3Com NIC Diagnostic Utilities</i>. 3 Click <i>Add/Remove</i>. <p>The PACE and 3NICDIAGS software is removed from your PC.</p>
Does the 3C905B-TX adapter support full-duplex?	Yes, the 3C905B-TX adapter supports full-duplex at 10 Mbps and 100 Mbps operation.
Why does the 3C905B-TX adapter install as a "Generic PCI Ethernet Controller" under Other Devices in the Device Manager?	<p>When Windows 95 is installed with the 3C905B-TX adapter already installed, Windows 95 installs the 3C905B-TX adapter as a generic PCI Ethernet controller. To work around this problem, follow these steps:</p> <ol style="list-style-type: none"> 1 In the Device Manager, double-click <i>Other Devices</i>. 2 Click <i>PCI Ethernet Controller</i>. 3 Click <i>Remove</i>. 4 Restart your PC.

(continued)

Table B-2 Frequently Asked Questions (continued)

Question	Answer
What should I do if a yellow exclamation point appears next to the 3C905B-TX adapter name?	<ol style="list-style-type: none"> 1 In the Device Manager, double-click <i>Other Devices</i>. 2 Click <i>PCI Ethernet Controller</i> or the duplicate 3C905B-TX NIC entry. 3 Click <i>Remove</i>. 4 Restart your PC.
What is the hardware IP header checksum?	<p>The header checksum is a field in the IP header.</p> <p>When the 3C905B-TX adapter receives IP data, it computes the IP header checksum, and if an error occurred, the packet is dropped and is not passed to the protocol stack. By computing the CRC through hardware, the adapter can increase the performance of IP traffic and reduce CPU processing required by the protocol stack.</p> <p>To avoid having the CRC computed twice (once in the hardware and again in the software by the protocol stack), make sure that your IP protocol does not compute the CRC or if it does, disable that function.</p>
Does the 3C905B-TX adapter support NetWare versions 3.11 or 4.0x?	<p>The 3C905B-TX adapter does not support NetWare versions 3.11 or 4.0x. These versions require the use of a server driver that conforms to the HSM 3.2 specification. 3Com no longer develops NetWare server drivers to the HSM 3.2 specification.</p>
What does Remote Wake-Up do?	<p>Remote Wake-Up powers up a PC remotely from standby or suspend mode using a wake-up packet that is sent through the LAN. With this method, no one has to be at the PC to turn it on.</p> <p>Remote Wake-Up is also known as Wake on LAN.</p>
How can I tell if my PC supports Remote Wake-Up?	<p>Check to see if there is a 3-pin header for the Remote Wake-Up connector located on the PC motherboard and if your PC has a BIOS that supports wake-up events based on LAN events. If you are unsure, contact your PC vendor for further details.</p>
What can wake up the 3C905B-TX adapter?	<p>The adapter can be awakened by a Magic Packet wake-up packet sent by management software, or by connecting or disconnecting the TP cable.</p>

(continued)

Table B-2 Frequently Asked Questions (continued)

Question	Answer
What is a Magic Packet?	A Magic Packet is a valid Ethernet packet that contains a synchronization stream immediately followed by 16 repetitions of the destination MAC address. This Magic Packet is not protocol-specific as long as the protocol contains the sync stream and the 16 repetitions. This Magic Packet can be routed in order to wake up a remote PC. Since it is a valid Ethernet address, the Remote Wake-Up adapter can accept broadcast or multicast packets.
What is a cable connect/disconnect?	The adapter can also be awakened by connecting or disconnecting the network cable.
What is Fast IP?	Fast IP is software that improves performance on switched networks. Fast IP allows end systems (desktops and servers) to discover switched communication paths. By creating switched shortcuts, Fast IP allows end stations to bypass the router and transfer data across wire-speed switched paths. Fast IP is part of 3Com's DynamicAccess software, an advanced network driver that brings intelligence to end systems to provide improved network performance and control.
What are the PC and network requirements to run Fast IP?	<p>Client requirements:</p> <p>PC running Windows 95 or Windows NT (versions 4 or 3.51), 3Com 3C905B-TX adapter, and the TCP/IP stack</p> <p>Network requirements:</p> <p>Switched path between stations and single broadcast domain</p>
What are the network configuration requirements for Fast IP?	Fast IP is designed to bypass the router, particularly where the router is a bottleneck, as well as to leverage the switched infrastructure. For Fast IP to create shortcuts around routers, there must be a switched path between source and destination.
What is the performance gain when using Fast IP?	Fast IP bypasses the router to provide increased performance in switched networks even if only a small number of network nodes use Fast IP. The performance gain obtained when deploying Fast IP is directly related to traffic load on the backbone router. The more traffic pumped to the router, the greater the latency and response time and the higher the performance gain. Internal tests show performance increases on the order of 600% when routers are loaded at 70 to 75%.

Accessing the 3Com World Wide Web Page

The 3Com Web site features news and information about 3Com products, customer service and support, 3Com's latest drivers, technical information, and more.

To access 3Com's World Wide Web site, enter the 3Com URL into your Internet browser:

`http://infodeli.3com.com/infodeli/swlib/n_i_c.htm/`

The Customer Support section has the latest troubleshooting tips for 3Com adapters.

GLOSSARY

10BASE-T

The IEEE 802.3 standard for a 10 Mbps baseband network on twisted-pair cable.

100BASE-T

The IEEE 802.3 standard for a 100 Mbps baseband network over twisted-pair cable.

100BASE-TX

The IEEE 802.3 standard for a 100 Mbps baseband network over two-pair Category 5 UTP or STP wire.

10/100 auto-negotiation (NWay)

Signaling scheme that allows the adapter and the hub to negotiate between 10BASE-T and 100BASE-T, and automatically select the highest performance level supported by both devices.

dRMON

Distributed RMON. The 3C905B-TX adapter SmartAgent intelligent agents collect remote management information and send it to the Transcend Edge Monitor System to provide full RMON network management in switched and Fast Ethernet networks.

DynamicAccess software

3Com proprietary technology that optimizes network performance. DynamicAccess features include PACE Interactive Access technology, dRMON (distributed RMON) support, Efficient Multicast Control, and support for PACE real-time and multimedia class of service applications.

full scatter gather

Technique that reduces CPU utilization by coordinating multiple storage locations for received data with no CPU utilization and then collecting it from multiple memory locations for transmission.

infinite bursting

Technology that enables the 3C905B-TX adapter to move data continuously across the PCI bus without breaks in the data transfer previously caused by cache size limitations. Previously, cache limitations caused the adapter to release and reacquire the PCI bus after every 64-byte burst. Infinite bursting increases throughput and reduces CPU utilization for better performance.

NDIS

Network Driver Interface Specification. Defines the network driver architecture and interfaces that let a PC support adapters. This architecture provides a standardized way to write drivers for network adapters.

network interface card (NIC)

Network interface card. Also called adapter.

PACE technology

Technology that enhances both real-time, interactive applications and multimedia (data, voice, and video) applications by enhancing network bandwidth utilization, reducing latency, controlling jitter, and supporting multiple traffic priority levels.

Parallel Tasking II architecture

3Com's third-generation Ethernet adapter architecture. Parallel Tasking technology accelerates data transfer by processing data packets simultaneously instead of sequentially.

PCI

Peripheral Component Interconnect. An advanced high-performance local bus that supports multiple peripheral devices. At 33 MHz, the PCI bus transfers data at up to 1056 Mbps.

INDEX

Numbers

- 10/100 auto-negotiation (NWay) 1-3, 4-1
- 3C90X.LAN file 3-12
- 3Com NIC Diagnostics program
 - echo test B-9
 - self-test B-7

A

- adapter
 - connecting to the network 2-3
 - installing drivers 3-1
 - LEDs B-4
 - network interface A-1
- Artisoft LANtastic 3-14
- AUTOEXEC.BAT file 3-10
- AUTOEXEC.NCF file 3-13
- AutoLink auto installation software 1-3, 3-10
- AUTOLINK.LOG file 3-11
- auto-negotiation 1-3, 4-1

B

- Banyan VINES 3-14

C

- changing configuration settings 4-2
- checking Remote Wake-Up B-12
- CONFIG.SYS file 3-10
- configuration settings 4-1
- confirming adapter installation in Windows 95 3-4
- connecting to the network 2-3
- conventions
 - notice icons, About This Guide 2
 - text, About This Guide 2
- CPU utilization 4-1
- crossover cable
 - cable pinouts B-14
 - troubleshooting tips B-14

D

- diagnostic tests
 - echo test B-9
 - self-test B-7
- DOS 3-10
- drivers, installing 3-1
- DynamicAccess features 1-2

E

- echo test B-9

F

- Fast IP 4-6
- Frequently Asked Questions B-16
- full-duplex 4-1

H

- Help system
 - accessing B-6
 - Frequently Asked Questions B-6
 - KnowledgeBase B-6
 - Release Notes B-6

I

- IBM LAN Server 3-14
- installing drivers
 - Artisoft LANtastic 3-14
 - AutoLink 3-14
 - Banyan VINES 3-14
 - IBM LAN Server 3-14
 - LAN Manager 3-14
 - NetWare Client 32 3-14
 - NetWare for DOS, Windows 3.1x, and Windows for Workgroups 3-10

NetWare server driver 3-12
supported network drivers 3-14
WFW NDIS 2 3-14
WFW NDIS 3 3-14
WFW NetWare 3-14
Windows 95 3-1
 16-bit driver 3-14
Windows NT 3-6
installing the adapter 2-1

K

KnowledgeBase B-6

L

LAN Manager 3-14
LAN Server 3-14
LANtastic 3-14
LEDs 2-3, B-4, B-5

M

Media Type option description 4-1
Microsoft LAN Manager 3-14

N

NDIS 2 network driver 3-14
NetWare 3-10
 Client 32 3-14
 OS/2 3-14
 version 4.10 3-12
network driver optimization 4-1

O

operating voltage requirements A-1

P

PACE technology 4-4
 advanced options 4-6
PC and server requirements 1-4
physical dimensions A-1
pin assignments A-2, B-15
power requirements A-1

R

Release Notes B-6
Remote Wake-Up, checking B-12
removing the 3C905B-TXNM-IBM
 adapter PACE and 3NICDIAGS
 software B-12
RJ-45 connector pin assignments A-2

S

server driver, Novell NetWare 3-12
support services B-10
switch port, setting full-duplex 4-1

T

troubleshooting 4-1, B-4
 crossover cable B-14
 LEDs B-5

U

updating the network driver
 Windows NT 3.51 3-9
 Windows NT 4.0 3-7

V

VINES 3-14

W

Windows 3.1x 3-10
Windows 95 1-3, 3-1
 confirming adapter installation 3-4
 installing network driver 3-1, 3-14
Windows for Workgroups 3-10, 3-14
Windows NT 3-6, 3-14
 version 3.51 3-9
 version 4.0 3-7
World Wide Web (WWW) B-20

The following warranty information applies to products purchased in the United States, Canada, and Puerto Rico. For warranty terms and conditions for products purchased in other countries, see the enclosed Warranty insert, or contact your IBM reseller or IBM marketing representative.

International Business Machines Corporation

Armonk, New York 10504

STATEMENT OF LIMITED WARRANTY

The warranties provided by IBM in this Statement of Limited Warranty apply only to Machines you originally purchase for your use, and not for resale, from IBM or your reseller. The term "Machine" means an IBM machine, its features, conversions, upgrades, elements, or accessories, or any combination of them. Unless IBM specifies otherwise, the following warranties apply only in the country where you acquire the Machine. If you have any questions, contact IBM or your reseller.

Machine	IBM 10/100 Fast EtherLink XL Adapter by 3Com
Warranty Period*	3 years

*Contact your place of purchase for warranty service information

PRODUCT STATUS

Each Machine is manufactured from new parts, or new and used parts. In some cases, the Machine may not be new and may have been previously installed. Regardless of the Machine's production status, IBM's warranty terms apply.

THE IBM WARRANTY FOR MACHINES

IBM warrants that each Machine 1) is free from defects in materials and workmanship and 2) conforms to IBM's Official Published Specifications. The warranty period for a Machine is a specified, fixed period commencing on its Date of Installation. The date on your receipt is the Date of Installation, unless IBM or your reseller informs you otherwise.

During the warranty period IBM or your reseller, if authorized by IBM, will provide warranty service under the type of service designated for the Machine and will manage and install engineering changes that apply to the Machine.

For IBM or your reseller to provide warranty service for a feature, conversion, or upgrade, IBM or your reseller may require that the Machine on which it is installed be 1) for certain Machines, the designated, serial-numbered Machine and 2) at an engineering-change level compatible with the feature, conversion, or upgrade. Many of these transactions involve the removal of parts and their return to IBM. You represent that all removed parts are genuine and unaltered. A part that replaces a removed part will assume the warranty service status of the replaced part.

If a Machine does not function as warranted during the warranty period, IBM or your reseller will repair it or replace it with one that is at least functionally equivalent, without charge. The replacement may not be new, but will be in good working order. If IBM or your reseller is unable to repair or replace the Machine, you may return it to your place of purchase and your money will be refunded.

If you transfer a Machine to another user, warranty service is available to that user for the remainder of the warranty period. You should give your proof of purchase and this Statement to that user. However, for Machines which have a life-time warranty, this warranty is not transferable.

WARRANTY SERVICE

To obtain warranty service for the Machine, you should contact your reseller or call IBM. In the United States, call IBM at **1-800-772-2227**. In Canada, call IBM at **1-800-565-3344**. You may be required to present proof of purchase.

IBM or your reseller will provide certain types of repair and exchange service, either at your location or at IBM's or your reseller's service center, to restore a Machine to good working order. Types of service may vary from country to country. IBM or your reseller will inform you of the available types of service for a Machine based on its country of installation.

When a type of service involves the exchange of a Machine or part, the item IBM or your reseller replaces becomes its property and the replacement becomes yours. You represent that all removed items are genuine and unaltered. The replacement may not be new, but will be in good working order and at least functionally equivalent to the item replaced. The replacement assumes the warranty service status of the replaced item. Before IBM or your reseller exchanges a Machine or part, you agree to remove all features, parts, options, alterations, and attachments not under warranty service. You also agree to ensure that the Machine is free of any legal obligations or restrictions that prevent its exchange.

You agree to:

- 1 obtain authorization from the owner to have IBM or your reseller service a Machine that you do not own; and
- 2 where applicable, before service is provided—
 - a follow the problem determination, problem analysis, and service request procedures that IBM or your reseller provides,
 - b secure all programs, data, and funds contained in a Machine, and
 - c inform IBM or your reseller of changes in a Machine's location.

IBM is responsible for loss of, or damage to, your Machine while it is 1) in IBM's possession or 2) in transit in those cases where IBM is responsible for the transportation charges.

EXTENT OF WARRANTY

IBM does not warrant uninterrupted or error-free operation of a Machine.

The warranties may be voided by misuse, accident, modification, unsuitable physical or operating environment, improper maintenance by you, removal or alteration of Machine or parts identification labels, or failure caused by a product for which IBM is not responsible.

THESE WARRANTIES REPLACE ALL OTHER WARRANTIES OR CONDITIONS, EXPRESS OR IMPLIED, INCLUDING, BUT NOT LIMITED TO, THE IMPLIED WARRANTIES OR CONDITIONS OF MERCHANTABILITY AND FITNESS FOR A PARTICULAR PURPOSE. THESE WARRANTIES GIVE YOU SPECIFIC LEGAL RIGHTS AND YOU MAY ALSO HAVE OTHER RIGHTS WHICH VARY FROM JURISDICTION TO JURISDICTION. SOME JURISDICTIONS DO NOT ALLOW THE EXCLUSION OR LIMITATION OF EXPRESS OR IMPLIED WARRANTIES, SO THE ABOVE EXCLUSION OR LIMITATION MAY NOT APPLY TO YOU. IN THAT EVENT SUCH WARRANTIES ARE LIMITED IN DURATION TO THE WARRANTY PERIOD. NO WARRANTIES APPLY AFTER THAT PERIOD.

LIMITATION OF LIABILITY

Circumstances may arise where, because of a default on IBM's part or other liability you are entitled to recover damages from IBM. In each such instance, regardless of the basis on which you are entitled to claim damages from IBM (including fundamental breach, negligence, misrepresentation, or other contract or tort claim), IBM is liable only for:

- 1 damages for bodily injury (including death) and damage to real property and tangible personal property; and
- 2 the amount of any other actual direct damages or loss, up to the greater of U.S. \$100,000 or the charges (if recurring, 12 months' charges apply) for the Machine that is the subject of the claim.

UNDER NO CIRCUMSTANCES IS IBM LIABLE FOR ANY OF THE FOLLOWING: 1) THIRD-PARTY CLAIMS AGAINST YOU FOR LOSSES OR DAMAGES (OTHER THAN THOSE UNDER THE FIRST ITEM LISTED ABOVE); 2) LOSS OF, OR DAMAGE TO, YOUR RECORDS OR DATA; OR 3) SPECIAL, INCIDENTAL, OR INDIRECT DAMAGES OR FOR ANY ECONOMIC CONSEQUENTIAL DAMAGES (INCLUDING LOST PROFITS OR SAVINGS), EVEN IF IBM OR YOUR RESELLER IS INFORMED OF THEIR POSSIBILITY. SOME JURISDICTIONS DO NOT ALLOW THE EXCLUSION OR LIMITATION OF INCIDENTAL OR CONSEQUENTIAL DAMAGES, SO THE ABOVE EXCLUSION OR LIMITATION MAY NOT APPLY TO YOU.

NOTICES

References in this publication to IBM products, programs, or services do not imply that IBM intends to make these available in all countries in which IBM operates. Any reference to an IBM product, program, or service is not intended to state or imply that only that IBM product, program, or service may be used. Subject to IBM's valid intellectual property or other legally protectable rights, any functionally equivalent product, program, or service may be used instead of the IBM product, program, or service. The evaluation and verification of operation in conjunction with other products, except those expressly designated by IBM, are the responsibility of the user.

IBM may have patents or pending patent applications covering subject matter in this document. The furnishing of this document does not give you any license to these patents. You can send license inquiries, in writing, to:

IBM Director Licensing
IBM Corporation
500 Columbus Avenue
Thornwood, NY 10594
U.S.A.

Any references in this publication to non-IBM Web sites are provided for convenience only and do not in any manner serve as an endorsement of those Web sites. The materials at those Web sites are not part of the materials for this IBM product and use of those Web sites is at your own risk.

FEDERAL COMMUNICATIONS COMMISSION (FCC) STATEMENT

Note: This equipment has been tested and found to comply with the limits for a Class B digital device, pursuant to Part 15 of the FCC Rules. These limits are designed to provide reasonable protection against harmful interference in a residential installation. This equipment generates, uses, and can radiate radio frequency energy and if not installed and used in accordance with the instructions, may cause harmful interference to radio communications. However, there is no guarantee that interference will not occur in a particular installation. If this equipment does cause harmful interference to radio or television reception, which can be determined by turning the equipment off and on, the user is encouraged to try to correct the interference by one or more of the following measures:

- Reorient or relocate the receiving antenna.
- Increase the separation between the equipment and receiver.
- Connect the equipment into an outlet on a circuit different from that to which the receiver is connected.
- Consult an IBM authorized dealer or service representative for help.

Properly shielded and grounded cables and connectors must be used in order to meet FCC emission limits. Proper cables and connectors are available from IBM authorized dealers. IBM is not responsible for any radio or television interference caused by using other than recommended cables and connectors or by unauthorized changes or modifications to this equipment. Unauthorized changes or modifications could void the user's authority to operate the equipment.

This device complies with Part 15 of the FCC Rules. Operation is subject to the following two conditions:

- 1 this device may not cause harmful interference, and
- 2 this device must accept any interference received, including interference that may cause undesired operation.

Responsible Party:

International Business Machines Corporation
New Orchard Road
Armonk, NY 10504

INDUSTRY CANADA CLASS B EMISSION COMPLIANCE STATEMENT

This Class B digital apparatus complies with Canadian ICES-003.

AVIS DE CONFORMITÉ À LA RÉGLEMENTATION D'INDUSTRIE CANADA

Cet appareil numérique de la classe B est conform à la norme NMB-003 du Canada.

DEUTSCHE EMV-DIREKTIVE (ELECTROMAGNETISCHE VERTRÄGLICHKEIT)

Dieses Gerät ist berechtigt in Übereinstimmung mit dem deutschen EMVG vom 9.Nov.92 das EG-Konformitätszeichen zu führen.

Der Aussteller der Konformitätserklärung ist die IBM UK, Greenock.

Dieses Gerät erfüllt die Bedingungen der EN 55022 Klasse B.

EUROPEAN UNION - EMISSION DIRECTIVE

This product is in conformity with the protection requirements of EU Council Directive 89/366/ECC on the approximation of the laws of the Member States relating to electromagnetic compatibility.

IBM can not accept responsibility for any failure to satisfy the protection requirements resulting from a non-recommended modification of the product, including the fitting of non-IBM option cards.

This product has been tested and found to comply with the limits for Class B Information Technology Equipment according to CISPR 22 / European Standard EN 55022. The limits for Class B Equipment were derived for typical residential environments to provide reasonable protection against interference with licensed communication devices.

UNION EUROPÉENNE- DIRECTIVE CONFORMITÉ ÉLECTROMAGNÉTIQUE

Ce produit est conforme aux exigences de protection de la Directive 89/336/EEC du Conseil de l'UE sur le rapprochement des lois des États membres en matière de compatibilité électromagnétique.

IBM ne peut accepter aucune responsabilité pour le manquement aux exigences de protection résultant d'une modification non recommandée du produit, y compris l'installation de cartes autres que les cartes IBM.

Ce produit a été testé et il satisfait les conditions de l'équipement informatique de Classe B en vertu de CISPR22 / Standard européen EN 55022. Les conditions pour l'équipement de Classe B ont été définies en protection raisonnable contre l'interférence d'appareils de communication autorisés.

UNION EUROPEA - NORMATIVA EMC

Questo prodotto è conforme alle normative di protezione ai sensi della Direttiva del Consiglio dell'Unione Europea 89/336/CEE sull'armonizzazione legislativa degli stati membri in materia di compatibilità elettromagnetica.

IBM non accetta responsabilità alcuna per la mancata conformità alle normative di protezione dovuta a modifiche non consigliate al prodotto, compresa l'installazione di schede e componenti di marca diversa da IBM.

Le prove effettuate sul presente prodotto hanno accertato che esso rientra nei limiti stabiliti per le apparecchiature di informatica Classe B ai sensi del CISPR 22 / Norma Europea EN 55022. I limiti delle apparecchiature della Classe B sono stati stabiliti al fine di fornire ragionevole protezione da interferenze mediante dispositivi di comunicazione in concessione in ambienti residenziali tipici.

UNIONE EUROPEA - DIRETTIVA EMC (CONFORMITÀ ELETTROMAGNETICA)

Este producto satisface los requisitos de protección del Consejo de la UE, Directiva 89/336/CEE en lo que a la legislación de los Estados Miembros sobre compatibilidad electromagnética se refiere.

IBM no puede aceptar responsabilidad alguna si este producto deja de satisfacer dichos requisitos de protección como resultado de una modificación no recomendada del producto, incluyendo el ajuste de tarjetas de opción que no sean IBM.

Este producto ha sido probado y satisface los límites para Equipos Informáticos Clase B de conformidad con el Estándar CISPR22 y el Estándar Europeo EN 55022. Los límites para los equipos de Clase B se han establecido para entornos residenciales típicos a fin de proporcionar una protección razonable contra las interferencias con dispositivos de comunicación licenciados.

この装置は、情報処理装置等電波障害自主規制協議会（VCCI）の基準に基づくクラスB情報技術装置です。この装置は、家庭環境で使用することを目的としていますが、この装置がラジオやテレビジョン受信機に近接して使用されると、受信障害を引き起こすことがあります。
取扱説明書に従って正しい取り扱いをして下さい。

TRADEMARKS

The following terms are trademarks of the IBM Corporation in the United States or other countries or both:

IBM and OS/2 are registered trademarks of International Business Machines Corporation.

The following terms are trademarks of other companies:

Unless otherwise indicated, 3Com registered trademarks are registered in the United States and may or may not be registered in other countries.

3Com, the 3Com logo, DynamicAccess, EtherDisk, EtherLink, Parallel Tasking, SmartAgent, and Transcend are registered trademarks of 3Com Corporation. AutoLink and PACE are trademarks of 3Com Corporation.

Artisoft and LANtastic are trademarks of Artisoft, Inc. Banyan and VINES are trademarks of Banyan Systems, Incorporated. Alpha, DEC, and PATHWORKS are trademarks of Digital Equipment Corporation. Pentium is a registered trademark of Intel Corporation. Microsoft, Windows, and Windows NT are trademarks of Microsoft Corporation. Novell and NetWare are trademarks of Novell, Inc. Open Desktop and SCO are trademarks of The Santa Cruz Operation, Inc.

Other brand and product names may be registered trademarks or trademarks of their respective holders.

3COM END USER SOFTWARE LICENSE AGREEMENT

IMPORTANT: Read Before Using This Product

YOU SHOULD CAREFULLY READ THE FOLLOWING TERMS AND CONDITIONS BEFORE USING THIS PRODUCT. IT CONTAINS SOFTWARE, THE USE OF WHICH IS LICENSED BY 3COM CORPORATION ("3COM") TO ITS CUSTOMERS FOR THEIR USE ONLY AS SET FORTH BELOW. IF YOU DO NOT AGREE TO THE TERMS AND CONDITIONS OF THIS AGREEMENT, DO NOT USE THE SOFTWARE. USING ANY PART OF THE SOFTWARE INDICATES THAT YOU ACCEPT THESE TERMS.

LICENSE: 3Com grants you a nonexclusive license to use the accompanying software program(s) (the "Software") subject to the terms and restrictions set forth in this License Agreement. You are not permitted to lease, rent, distribute or sublicense the Software or to use the Software in a time-sharing arrangement or in any other unauthorized manner. Further, no license is granted to you in the human readable code of the Software (source code). Except as provided below, this License Agreement does not grant you any rights to patents, copyrights, trade secrets, trademarks, or any other rights in respect to the Software.

The Software is licensed to be used on any workstation or any network server owned by or leased to you, provided that the Software is used only in connection with a 3Com adapter. You may reproduce and provide one (1) copy of the Software and supporting documentation for each such workstation or network server on which the Software is used as permitted hereunder. Otherwise, the Software and supporting documentation may be copied only as essential for backup or archive purposes in support of your use of the Software as permitted hereunder. You must reproduce and include all copyright notices and any other proprietary rights notices appearing on the Software and the supporting documentation on any copies that you make.

NO ASSIGNMENT; NO REVERSE ENGINEERING: You may not transfer or assign the Software and/or this License Agreement to another party without the prior written consent of 3Com. If such consent is given and you transfer or assign the Software and/or this License Agreement, then you must at the same time either transfer any copies of the Software as well as the supporting documentation to the same party or destroy any such materials not transferred. Except as set forth above, you may not transfer or assign the Software or your rights under this License Agreement.

Modification, reverse engineering, reverse compiling, or disassembly of the Software is expressly prohibited. However, if you are a European Community ("EC") resident, information necessary to achieve interoperability of the Software with other programs within the meaning of the EC Directive on the Legal Protection of Computer Programs is available to you from 3Com upon written request.

EXPORT RESTRICTIONS: You agree that you will not export or re-export the Software or accompanying documentation (or any copies thereof) or any products utilizing the Software or such documentation in violation of any applicable laws or regulations of the United States or the country in which you obtained them.

TRADE SECRETS; TITLE: You acknowledge and agree that the structure, sequence and organization of the Software are the valuable trade secrets of 3Com and its suppliers. You agree to hold such trade secrets in confidence. You further acknowledge and agree that ownership of, and title to, the Software and all subsequent copies thereof regardless of the form or media are held by 3Com and its suppliers.

UNITED STATES GOVERNMENT LEGEND: All technical data and Software are commercial in nature and developed solely at private expense. The Software is delivered as Commercial Computer Software as defined in DFARS 252.227-7014 (June 1995) or as a commercial item as defined in FAR 2.101(a) and as such is provided with only such rights as are provided in this License Agreement, which is 3Com's standard commercial license for the Software. Technical data is provided with limited rights only as provided in DFAR 252.227-7015 (Nov. 1995) or FAR 52.227-14 (June 1987), whichever is applicable. You agree not to remove or deface any portion of any legend provided on any licensed program or documentation delivered to you under this License Agreement.

TERM AND TERMINATION: This license will expire fifty (50) years from the date that you first use the Software, if it is not earlier terminated. You may terminate it at any time by destroying the Software and documentation together with all copies and merged portions in any form. It will also terminate immediately if you fail to comply with any term or condition of this License Agreement. Upon such termination you agree to destroy the Software and documentation, together with all copies and merged portions in any form.

GOVERNING LAW: This License Agreement shall be governed by the laws of the State of California as such laws are applied to agreements entered into and to be performed entirely within California between California residents and by the laws of the United States. You agree that the United Nations Convention on Contracts for the International Sale of Goods (1980) is hereby excluded in its entirety from application to this License Agreement.

LIMITED WARRANTY; LIMITATION OF LIABILITY: All warranties and limitations of liability applicable to the Software are as stated on the Limited Warranty Card or in the product manual accompanying the Software. Such warranties and limitations of liability are incorporated herein in their entirety by this reference.

SEVERABILITY: In the event any provision of this License Agreement is found to be invalid, illegal or unenforceable, the validity, legality and enforceability of any of the remaining provisions shall not in any way be affected or impaired and a valid, legal and enforceable provision of similar intent and economic impact shall be substituted therefor.

ENTIRE AGREEMENT: This License Agreement sets forth the entire understanding and agreement between you and 3Com, supersedes all prior agreements, whether written or oral, with respect to the Software, and may be amended only in a writing signed by both parties.

3Com is a registered trademark of 3Com Corporation.

3Com Corporation, 5400 Bayfront Plaza, P.O. Box 58145, Santa Clara, CA 95052-8145.
(408) 326-5000

Free Manuals Download Website

<http://myh66.com>

<http://usermanuals.us>

<http://www.somanuals.com>

<http://www.4manuals.cc>

<http://www.manual-lib.com>

<http://www.404manual.com>

<http://www.luxmanual.com>

<http://aubethermostatmanual.com>

Golf course search by state

<http://golfingnear.com>

Email search by domain

<http://emailbydomain.com>

Auto manuals search

<http://auto.somanuals.com>

TV manuals search

<http://tv.somanuals.com>