

IBM ThinkVision™ L150/150p Monitor



L150/150p

User's Guide

English

First Edition (June/2003)

Note: For important information, refer to the Monitor Safety and Warranty manual that comes with this monitor.

Contents

Safety (Read first)	2
Setting up the monitor	3
Product Description	3
Handling Instructions	3
Workplace Preparation	4
Adjusting the Monitor Position	4
Working Practices	5
Caring for your Monitor	6
Connecting your Monitor for Analog	7
Connecting your Monitor for Digital	8
Switching on your Monitor	9
Device Driver Installation	10
Windows 95/98	10
Windows 2000/Me	11
Windows XP	12
Auto Setup	13
Auto Setup	13
Auto Setup for DOS	14
Auto Setup for Windows95, Windows98, Windows 2000, Windows NT, Windows Me or Windows XP	15
Manual Setup	16
Adjusting Your LCD Monitor	17
User controls	17
On-screen display (OSD) controls	19
Further Information	22
Display modes	23
Power Management	24
Product Disposal	24
Troubleshooting	25
Further Help	28
Specifications	29
Service Information	31
Notices and Trademarks	32



Safety: Read first

Before installing this product, read the Safety Information.

Avant d'installer ce produit, lisez les consignes de sécurité.

Vor der Installation dieses Produkts die Sicherheitshinweise lesen.

Πριν εγκαταστήσετε το προϊόν αυτό, διαβάστε τις πληροφορίες ασφάλειας (safety information).

לפני שתתקינו מוצר זה, קראו את הוראות הבטיחות.

A termék telepítése előtt olvassa el a Biztonsági előírásokat!

Prima di installare questo prodotto, leggere le Informazioni sulla Sicurezza

Antes de instalar este produto, leia as Informações de Segurança.

Läs säkerhetsinformationen innan du installerar den här produkten.

Prije instalacije ovog produkta obavezno pročitajte Sigurnosne Upute.

Les sikkerhetsinformasjonen (Safety Information) før du installerer dette produktet.

Przed zainstalowaniem tego produktu, należy zapoznać się z książką "Informacje dotyczące bezpieczeństwa" (Safety Information).

Пред да се инсталира овој продукт, прочитајте информацијата за безбедност.

Pred inštaláciou tohto zariadenia si peèítajte Bezpeènostné predpisy.

Pred namestitvijo tega proizvoda preberite Varnostne informacije.

Ennen kuin asennat t m n tuotteen, lue turvaohjeet kohdasta Safety Information.

Před instalac tohoto produktu si přečtete příručku bezpečnostních instrukcí.

在安装本产品之前，请仔细阅读 Safety Information (安全信息)。

安裝本產品之前，請先閱讀「安全資訊」。

مج، يجب قراءة دات السلامة

Læs sikkerhedsforskrifterne, før du installerer dette produkt.

製品を設置する前に、安全情報をお読みください。

본 제품을 설치하기 전에 안전 정보를 읽으십시오.

Antes de instalar este producto lea la información de seguridad.

Antes de instalar este produto, leia as Informações de Segurança.

Перед установкой продукта прочтите инструкции по технике безопасности.

Lees voordat u dit product installeert eerst de veiligheidsvoorschriften.

Setting up the monitor

Product Description

The IBM ThinkVision TFT LCD L150/L150p Color Monitor works with a computer with a suitable on-board sub-system or Video Adapter card that can support XGA 1024 x 768, SVGA 800 x 600, or VGA 640 x 480 at 60 Hz

The product package should include the following items:

- *User's Guide and Installation Files CD*
- Monitor Safety and Warranty Information Manual
- *IBM ThinkVision L150/L150p monitor Setup Guide*
- Power Cord
- IBM ThinkVision L150/L150p Monitor
- Analog Interface Cable - Attached to Monitor

Handling Instructions

Do not support the monitor within the screen area. The Liquid Crystal Display is glass and can be damaged by rough handling or excessive pressure.

1. Lift the monitor by placing your hands where indicated below.

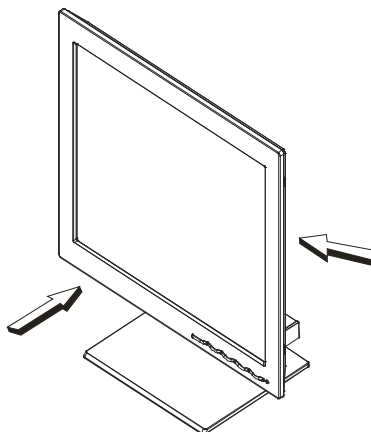

2. Before using your monitor for the first time, remove the clear protective film from the front of the screen.

3. Remove the shipping clip for L150p as shown below

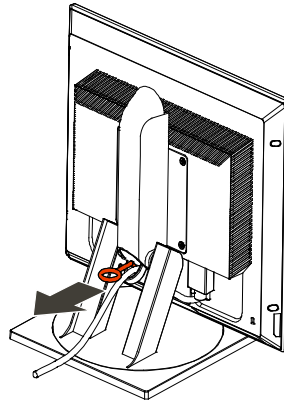

Workplace Preparation

i This section gives advice on what you should consider before you set up your monitor.

Height

Position the monitor so that the top of the screen is slightly below your eye level when you sit at your workstation.

Orientation

Choose a position that gives the least reflection from lights and windows, usually at a right angle to any windows. Position the monitor directly in front of you so that you do not have to twist your body to use it. Tilt the monitor to a comfortable viewing angle.

Adjusting the Monitor Position

The monitor offers the adjusting height, rake, and rotation possibility that enable the monitor to be optimally adjusted for the respective user and the respective situation.

L150

You can tilt the screen backward and forward as shown below.

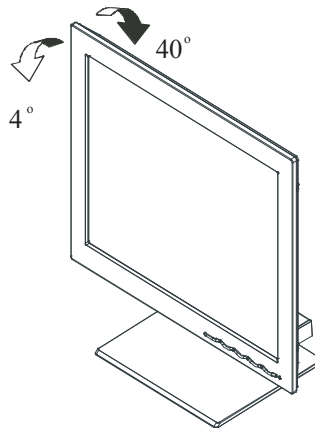

L150p

You can tilt the screen backward and forward, swivel left and right, as well as lift up and down as shown below.

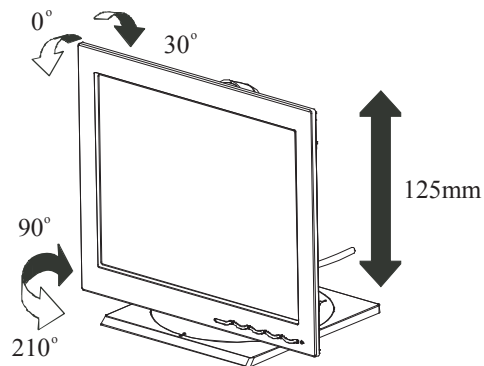

Working Practices

i This section gives advice on how you can work comfortably and reduce fatigue.

Rest

Take regular breaks. Vary your posture, stand up and stretch occasionally as prolonged use of computer workstations can be tiring.

Back

Sit back in your chair and use the backrest.

Hands

Adjust the seat height so that your forearms are approximately horizontal and your wrists are straight when using the keyboard. Your upper arms should be relaxed with your elbows near your body.

Use a light touch on the keyboard, keeping your hands and fingers relaxed. Allow a space in front of the keyboard to rest your wrists when not typing. Consider using a wristpad.

Eyesight

Working with monitors, in common with any prolonged close work, can be visually demanding. Look away from the screen periodically and have your eyesight checked regularly.

Screen settings

Set the screen brightness and contrast to a comfortable level. You may have to adjust this as the lighting changes during the day. Many application programs let you select color combinations which can help you to view in comfort. See the **User controls** section on page 15 for more information.

Caring for your Monitor

Be sure to turn off the power before you perform any maintenance on the monitor. Clean your monitor as follows:

- Gently wipe the device covers and the screen with a soft cloth.
- Remove finger marks and grease with a damp cloth and mild detergent; do not use solvents or abrasives.
- Never use flammable cleaning material to clean your IBM monitor or any other electrical apparatus.

Connecting your Monitor for Analog (for L150 and L150p)

Be sure to read the '**Safety Information**' at the front of this User Guide before carrying out this procedure.

1. Turn off your computer and all attached devices.
2. Connect the signal cable to the video port on the back of your computer. This port might be directly attached to your computer (figure A), or it might be part of a video adapter card (figure B). The video port on your computer or video adapter card might be blue to match the blue connector on your monitor's video cable.

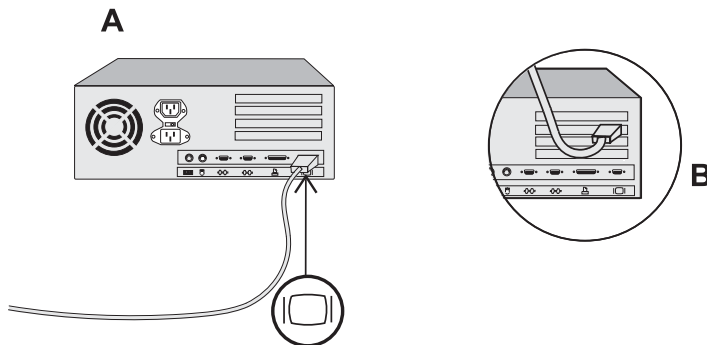

3. For L150, if the power cord is not attached to the monitor, please follow the instructions below:

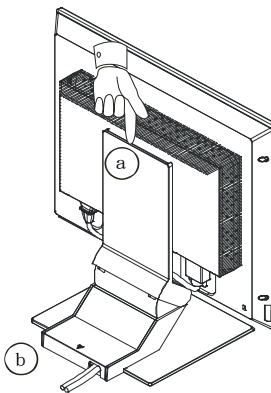

- a. Tilt monitor all the way forward.
 - b. Hold the top of the cable cover (a) and pull it off.
 - c. Gently lift the stand cover (b) along the top and then slide it backwards and off the stand.
 - d. Connect the power cord to the power port on the back of your monitor.
 - e. Replace the rear covers.
4. For L150p, if the power cord is not attached to the monitor, connect it to the power port on the back of the monitor.
 5. Insert the plug into a properly grounded electrical outlet.

Connecting your Monitor for Digital

1. Purchase an industry standard DVI-D cable from your local computer supply store.
2. Turn off your computer and all attached devices.
3. Tilt monitor all the way forward.
4. Connect the DVI connector to the DVI port located on the back of the Monitor. See picture below.

Connecting DVI Cable

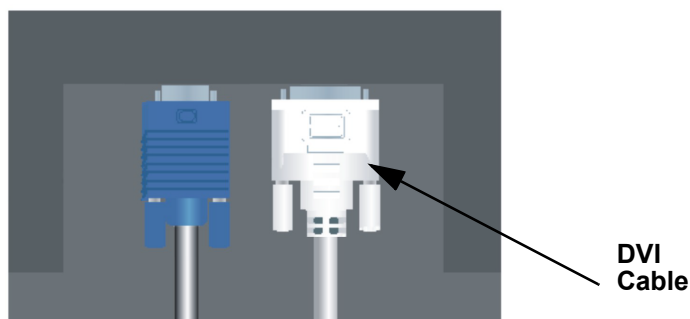

5. Connect the DVI connector at the other end of the signal cable to the DVI port located on the back of the graphics adapter. See picture below

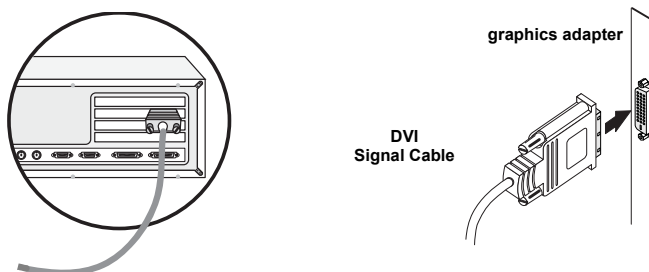

Switching on your Monitor

1. Switch on the power source and your computer.
2. Switch on your monitor by pushing and releasing the power switch marked  .
(To switch off your monitor, push and release the power switch again.)
3. To update or install device drivers, follow the instructions in the **Device Driver Installation** section on page 10.
4. To optimise the displayed image, run Auto Setup by following the instructions in the **Auto Setup** section on page 13.

Device Driver Installation

Driver installation for Windows 95 or Windows 98

This section must be completed before continuing with the Windows 95 or Windows 98 Auto Setup on page 15

***i** On LCD monitors, unlike CRTs, a faster refresh rate does not improve display quality. IBM recommends using either 1024 x 768 at a refresh rate of 60Hz or 640 x 480 at a refresh rate of 60Hz.*

To use the Plug and Play feature in Microsoft® Windows® 95 or Windows 98, files should be loaded from the **IBM Monitor CD**.

1. Turn off the computer and all attached devices.
2. Ensure that the monitor is connected correctly.
3. Turn on the monitor and then the system unit. Allow the system to boot into Windows 95 or Windows 98.
Your computer's Plug and Play code may warn you that your system hardware has changed. This means that it has detected your new monitor for the first time.

4. Open the **DISPLAY PROPERTIES** window by clicking **START, SETTINGS, CONTROL PANEL** and then double - clicking on the **DISPLAY** icon.

5. Click the **SETTINGS** tab.

• **In case of Windows 95 :**

6. 1. Click the **CHANGE DISPLAY TYPE** button.
2. Click the **CHANGE MONITOR TYPE** button.

• **In case of Windows 98 :**

6. 1. Click the **ADVANCED** button.
2. Click the **MONITOR** tab.
3. Open the **UPGRADE DEVICE DRIVER WIZARD** window by clicking on **CHANGE** button and then select the **NEXT** button.
4. Click the "Display a list of the known drivers for this device so that I can choose a specific driver" and then select the **NEXT** button.
7. Insert the Setup CD into the CD driver: and click the **HAVE DISK** button.
8. Click **OK**.
9. Ensure that the CD drive letter is selected, and then select 'Drivers' folder.
10. Choose **IBM ThinkVision L150/150p monitor** and **Click OK**. The files will be copied from the CD to your hard disk drive.
11. Close all open windows and remove the CD.
12. Restart the system.
The system will automatically select the maximum refresh rate and corresponding Color Matching Profiles.

Driver Installation for Windows 2000 or Windows Me

This section must be completed before continuing with the Windows 2000, Windows Me Auto Setup on page 15

i On LCD monitors, unlike CRTs, a faster refresh rate does not improve display quality. IBM recommends using either 1024 x 768 at a refresh rate of 60Hz or 640 x 480 at a refresh rate of 60Hz.

To use the Plug and Play feature in Microsoft® Windows® 2000 or Microsoft Windows Millennium Edition(Me) files should be loaded from the **IBM Monitor CD**.

1. Turn off the computer and all attached devices.
2. Ensure that the monitor is connected correctly.
3. Turn on the monitor and then the system unit. Allow the system to boot into Windows 2000 or Windows Me.
4. Open the **DISPLAY PROPERTIES** window by clicking **START, SETTINGS, CONTROL PANEL** and then double-clicking the **DISPLAY** icon.
5. Click the **SETTINGS** tab.
6. Click the **ADVANCED** button.
7. Click the **MONITOR** tab.
8. Click the **PROPERTIES** button.
9. Click the **DRIVER** tab.
10. Open the **UPGRADE DEVICE DRIVER WIZARD** window by clicking on **UPDATE DRIVER** and then Click the **NEXT** button.
11. Select the "Display a list of the known drivers for this device so that I can choose a specific driver" and then Click the **NEXT** button.
12. Insert the Setup CD into the CD drive : and click the **HAVE DISK** button.
13. Click OK.
14. Ensure that the CD drive letter is selected, and then select the 'Drivers' folder.
15. Choose **IBM ThinkVision L150/150p monitor** and Click **OK**. The files will be copied from the CD to your hard disk drive.
16. Close all open windows and remove the CD.
17. Restart the system.
The system will automatically select the maximum refresh rate and corresponding Color Matching Profiles.

Driver Installation for Windows XP

This section must be completed before continuing with the Windows XP Auto Setup on page 15

i On LCD monitors, unlike CRTs, a faster refresh rate does not improve display quality. IBM recommends using either 1024 x 768 at a refresh rate of 60Hz or 640 x 480 at a refresh rate of 60Hz.

To use the Plug and Play feature in Microsoft® Windows® XP files should be loaded from the **IBM Monitor CD**.

1. Turn off the computer and all attached devices.
2. Ensure that the monitor is connected correctly.
3. Turn on the monitor and then the system unit. Allow the system to boot into Windows XP.
4. Open the **DISPLAY PROPERTIES** window by clicking **START, SETTINGS, CONTROL PANEL** and then double-clicking the **DISPLAY** icon.
5. Click the **SETTINGS** tab.
6. Click the **ADVANCED** button.
7. Click the **MONITOR** tab.
8. Click the **PROPERTIES** button.
9. Click the **DRIVER** tab.
10. Open the **Hardware Update Wizard** window by clicking on **UPDATE DRIVER** and then Click the **NEXT** button.
11. Select the "Install from a list or Specific location(Advanced)" and then Click the **NEXT** button.
12. Insert the Setup CD into the CD drive : and click the **HAVE DISK** button.
13. Click OK.
14. Ensure that the CD drive letter is selected, and then select the 'Drivers' folder.
15. Choose **IBM ThinkVision L150/150p monitor and Click OK. The files will be copied from the CD to your hard disk drive.**
16. Close all open windows and remove the CD.
17. Restart the system.
The system will automatically select the maximum refresh rate and corresponding Color Matching Profiles.

Auto Setup

Auto Setup



The Setup Utility included on the installation CD is for displaying dot patterns. They do not replace or modify the display driver.

The Auto Setup instructions require the monitor to be warmed up for 15 minutes. This is not required for normal operation.

By pressing the Auto key, you will have direct access to Auto Adjustment.

Auto setup is not required when using digital input.

When you first use your monitor you must perform Auto Setup. This procedure sets up your monitor to process the video signals from your computer without image discoloration or smearing. After you perform Auto Setup, the settings are stored and used each time you turn on the monitor.

To optimise the displayed image a set-up utility is provided on the CD. Operation of the utility is dependent on the operating system on your computer. For correct operation locate the operating system on your computer from the table below and follow the appropriate instructions. You can choose to run AUTO SETUP for each operating system that you use. This means that if you sometimes use your monitor while running any version of Windows and sometimes also use it from within DOS (not a DOS window), you must run AUTO SETUP for both Windows and DOS. You can run versions of AUTO SETUP in any order.

Operating System	Corresponding Auto Setup procedure
DOS	<i>Auto Setup for DOS on page 14</i>
Windows 95, Windows 98, Windows 2000, Microsoft Windows NT [®] , Windows Me or Windows XP	<i>Auto Setup for Windows 95, Windows 98, Windows NT, Windows 2000, Windows Me or Windows XP on page 15</i>

Before you begin AUTO SETUP for your computer:

1. Make sure the computer's video mode is set in the range of the supported screen resolution shown in the Table on page 23.

You should perform AUTO SETUP for each screen mode you use.



The AUTO SETUP process only applies to the current screen mode. When a new mode is selected, repeat this section to reset the monitor.

Auto Setup for DOS

i If the monitor is in standby mode (STANDBY ON), it may automatically turn off while you are waiting for it to warm up. If this happens, switch off the monitor and switch it on again after a few seconds.

i If you are using PC-DOS/V, change to U.S. mode by typing 'CHEV US' and pressing ENTER at the command prompt.

i The size and diversity of the dot pattern varies with the screen resolution.

To set up the monitor automatically in DOS, do the following:

1. Turn on the monitor first; then turn on the computer.

If the message CHECK SIGNAL CABLE is displayed, or if nothing is displayed, check:

- that the video interface cable is connected properly.
- the correct video adapter card is installed.
- the correct supported display mode is selected for your computer.

2. Wait approximately 15 minutes, until the monitor warms up.
3. Insert the *User's Guide and Installation Files CD* into the computer CD-ROM drive.
4. Display the command prompt screen of the DOS full-screen display.
5. Type d:\ (change the drive letter to match your CD-ROM drive if it is not drive D).
6. Type **TESTPATD** and press ENTER.
7. Select from the screen the number for the color or text mode you want to set up.
8. Select from the screen the number for the video mode you want to set up. You can repeat this process for as many of the color and video modes as you need.
9. When the dot pattern appears, press the Image Setup () button at the bottom of the monitor. This activates the AUTO SETUP procedure, which will optimize the display settings with the provided dot-patterns. The screen will momentarily turn black while auto adjustment proceeds.
10. When finished, the Auto Adjustment menu disappears and the screen returns to a normal display.
11. Press the ESCAPE key to exit the test pattern program.
12. Type **Exit** at the command prompt to return to Windows.

If you use other operating systems, perform the appropriate Auto Setup for those systems using instructions given in "*Auto Setup for Windows 95, Windows 98, Windows NT, Windows 2000, Windows Me or Windows XP* on page 15".

Auto Setup for Windows 95, Windows 98, Windows NT, Windows 2000, Windows Me or Windows XP

To set up the monitor automatically in Windows 95, Windows 98, Windows NT, Windows 2000, Windows Me, or Windows XP, do the following:

i If the monitor is in standby mode (STANDBY ON), it may automatically turn off while you are waiting for it to warm up.

1. Turn on the monitor first; then the computer.
If the message CHECK SIGNAL CABLE is displayed, or if nothing is displayed, check:
 - that the video interface cable is connected properly.
 - the correct video adapter card is installed.
 - the correct supported display mode is selected for your computer.
2. Wait approximately 15 minutes, until the monitor warms up.
3. Drag the icon bar and tool bar, if they are displayed, to the bottom of the screen.
4. Insert the User's Guide and Installation CD into the computer CD-ROM drive.
5. Check the operating system installed on your computer and follow the instructions from the table below.

i The size and diversity of the dot pattern varies with the screen resolution.

Operating system installation steps

Operating System	Step1	Step2	Step3
Windows 95, Windows 98, Windows 2000, Windows NT, Windows Me or Windows XP	Select START	Select RUN	Type D:\TESTPAT (change the drive letter to match your CD-ROM drive if it is not drive D) and press ENTER

6. When the test pattern appears, press the Image Setup () button at the bottom of the monitor. This activates the AUTO SETUP procedure, which will optimize the display settings with the provided test patterns. The screen will momentarily turn black while auto adjustment proceeds.
7. When finished, the Auto Adjustment menu disappears and the screen returns to a normal display.
8. Press the Esc key to return to Windows.











You have completed the monitor setup for Windows. If you are using the DOS operating system, go to **Auto Setup for DOS** on page 14.

Manual Setup

i If the monitor is in standby mode (STANDBY ON), it might automatically turn off while you are waiting for it to warm up.

Manual setup is not required when using digital input.

Normally, you can complete the setup procedure using AUTO SETUP; however, if your screen image is still distorted after you perform AUTO SETUP or the Installation CD does not run on your system, perform MANUAL SETUP.

1. Have your monitor turned on for about 15 minutes, until the monitor warms up.
2. Display the image you most frequently use on the screen then go to windows shut down mode.
3. Press the OSD Enter button  at the bottom of the monitor to display the initial OSD menu.
4. Use the  or  button to select the Image Setup icon  and press the OSD Enter button  to access.
5. Use the  or  button to select Clock and Phase to adjustment.
 - (a) "Clock" (pixel frequency) controls the number of pixels scanned by one horizontal sweep.
If the frequency is not correct, the screen shows vertical stripes and the picture does not have the correct width.
 - (b) "Phase" adjust the phase of the pixel clock signal. With a wrong phase adjustment the picture has horizontal disturbances in light picture.
6. Use a select ( or ) button to manually adjust to correct and execute save go to up menu then press the Exit () button to leave OSD menu.

You have completed monitor setup.

Adjusting Your LCD Monitor

User controls



User control features

- **Direct access controls**
When OSD is not displayed,

Icon	Control	Description
	Image Setup	Activates automatic image adjustment.
	Brightness	Directly accesses to Brightness on the OSD main menu.
	OSD Enter	Displays the OSD main menu.
	Power Switch	Switches the monitor on and off.
	Input Signal	Switches the video input source (Only for L150p)

- **Main OSD menu**
When OSD is displayed,

Icon	Control	Description
	Exit	Exits from menus and sub-menus Exits the OSD.
	Left Arrow	Moves the cursor to highlight icons and other options.
	Right Arrow	Moves the cursor to highlight icons and other options.
	OSD Enter	Enters menus and sub-menus and selects the highlighted option.

i The image is already optimized for many display modes; however the user controls can be used to adjust the image to your liking.

Operation

- Press the OSD Enter button to display the main OSD menu.
- Use the Arrow buttons to move among the icons. Select an icon and press OSD Enter to access that function. If there is a sub-menu, you can move between options using the Arrow buttons, then press OSD Enter \leftarrow to select that function. Use the Arrow buttons to make adjustments. Press the \leftarrow button to save.
- Press the Exit (\rightarrow) button to move backwards through the sub-menus and exit from the OSD.

OSD Lock / Unlock

- This feature allows you to secure the current control settings, so that they cannot be changed, while allowing you to adjust the brightness and contrast. You can unlock the OSD controls at any time using the same procedure
- Push and hold the OSD Enter (\leftarrow) button for 10 seconds to Lock or to Unlock. When unlocked, a "Menu is Unlocked" message will be displayed. When locked, a "Menu is Locked" message will be displayed.

On-screen display (OSD) controls























The settings adjustable with the user controls are viewed through the On-Screen Display (OSD). Press the OSD Enter button () to activate the OSD.









i The LCD monitor needs time to become thermally stable the first time you turn it on each day. Thus, to achieve more accurate adjustments for parameters, allow the LCD monitor to warm up (be On) for at least 15 minutes before making any screen adjustments.







Initial appearance of OSD

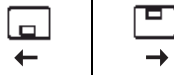

OSD functions

OSD Icon on Main Menu	Submenu	Description	Controls and Adjustments (Analog)		Controls and Adjustments (Digital)
 Brightness/Contrast	 Brightness	Adjusts brightness.	 	 	Same as Analog
	 Contrast	Adjusts contrast.	 	 	Controls Locked
 Image Position	 Horizontal Position	Moves the screen left or right.	 	 	Controls Locked
	 Vertical Position	Moves the screen up or down.	 	 	Controls Locked

OSD Icon on Main Menu	Submenu	Description	Controls and Adjustments (Analog)	Controls and Adjustments (Digital)
 Image Setup	 Automatic	Activates automatic image adjustment.		Controls Locked
	 Manual <ul style="list-style-type: none"> • Clock • Phase 	Use the ← or → button to adjust away the interference. If satisfactory results are not obtained using the Phase adjustment, use the Clock adjustment and then use Phase again.		
 Image Properties	 Color <ul style="list-style-type: none"> 1. Preset Mode <ul style="list-style-type: none"> • 6500K • 7200K • 9300K 2. Custom <ul style="list-style-type: none"> • Red • Green • Blue 	Adjusts intensity of red, green and blue. 6500K adjusts the screen more red. 7200K adjusts the screen to the default color settings. 9300K adjusts the screen more blue. Increases or decreases 'red'. Increases or decreases 'green'. Increases or decreases 'blue'.		Controls Locked
	 Input video signal	Use ← or → to select video signa. (Analog or Digital.) With this function, switch the screen from the analog to the digital mode or vice versa. The condition is that the graphic card used supports this function.	1 - selects D-SUB (Analog) 2 - selects DVI-Digital (Digital)	
 Options	 Information	Shows resolution, refresh rate, and product details. Note: This screen does not allow any changes to the settings.		Same as Analog
	 Language	The language chosen affects only the language of the OSD. It has no effect on any software running on the computer.	Select one of the 5 languages (English, French, Italian, German and Spanish) to use for the OSD.	

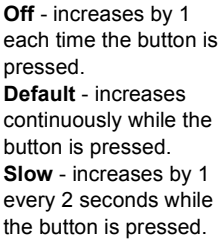
OSD Icon on Main Menu (Continued)	Submenu	Description	Controls and Adjustments (Analog)	Controls and Adjustments (Digital)
 Options	 Menu Position 1. Default 2. Custom <ul style="list-style-type: none"> • Horizontal • Vertical 	Adjusts menu location on the screen. Returns the menu position to the default settings. Changes the horizontal position of OSD. Changes the vertical position of OSD.	 	Same as Analog
	 Factory Reset <ul style="list-style-type: none"> • Cancel • Reset 	Resets monitor to the original settings. Does not make the adjustment. Resets the settings.		
	 Accessibility <ul style="list-style-type: none"> •  Button repeat rate •  Menu time out 	Changes button repeat rate and menu time out setting. Selects ← or → button repeating rate. Sets the length of time the OSD will remain active after the last time a button is pressed.	 Use the ← or → button to select time from 5 to 60 seconds.	

Further Information

Display modes

The display mode the monitor uses is controlled by the computer. Therefore, refer to your computer documentation for details on how to change display modes.

The image size, position and shape might change when the display mode changes. This is normal and the image can be readjusted using AUTO SETUP and the monitor controls.

Unlike CRT monitors, which require a high refresh rate to minimize flicker, TFT technology is inherently flicker-free. If possible, configure your computer for 1024 × 768 addressability at 60Hz vertical refresh rate.

For the display modes listed on the next page, the screen image has been optimized during manufacture.

i For image problems, you may want to run AUTO Setup again before consulting this section. In most cases, AUTO SETUP can fix the problems. See **Auto Setup for DOS** on page 12 for details.

Factory Set Display Modes

Addressability	Refresh Rate
640 × 350	70 Hz
640 × 480	60 Hz
640 × 480	72 Hz
640 × 480	75 Hz
720 × 400	70 Hz
800 × 600	60 Hz
800 × 600	72 Hz
800 × 600	75 Hz
1024 × 768 [†]	60 Hz
1024 x 768	70 Hz
1024 x 768	75 Hz

† Recommended

Note: VESA timings are as detailed in the VESA “Display Monitor Timing Specification”. Version 1.0, Revision 0.8, dated 09/17/98.

Power Management

***i** If your computer has previously been used with a CRT monitor and is currently configured to a display mode outside the range that the Flat Panel monitor can display, you may need to re-attach the CRT monitor temporarily until you have re-configured the computer, preferably to 1024 x 768 at 60Hz.*

To benefit from power management, the monitor must be used in conjunction with a computer that implements the Video Electronics Standards Association (VESA) Display Power Management Signalling (DPMS) Standard.

The power management feature is invoked when the computer recognizes that you have not used your mouse or keyboard for a user-definable period. There are several states as described in the table below.

As an ENERGY STAR® Partner, IBM has determined that this product meets the ENERGY STAR® guidelines for energy efficiency.

For optimal performance, switch off your monitor at the end of each working day, or whenever you expect to leave it unused for long periods during the day.

State	Power Indicator	Screen	Restoring Operation	Compliance
ON	Steady Green	Normal		
Active Off	Blinking green	Blank	Press a key or move the mouse.*	ENERGY STAR®

* There may be a slight delay before the picture reappears.

Product Disposal

The fluorescent lamp in the liquid crystal display contains a small amount of mercury. Dispose of it as required by local ordinances and regulations.

Troubleshooting

If you have a problem setting up or using your monitor, you might be able to solve it yourself. Before calling your retailer or IBM, try the suggested actions that are appropriate to your problem.

Problem	Possible Cause	Suggested Action	Reference
Computer does not boot after the graphics adapter is installed	There is another graphics adapter in the computer	<ul style="list-style-type: none"> ◆ Remove the other graphics adapter plugged into one of the expansion slot. ◆ If the card is built-in to the motherboard, check your system manual for instructions on how to disable the built-in adapter. 	Connecting your Monitor section on page 7 ~ 8
The screen image is garbled or unusable (rolling screen images, overlapping screen images or a blank screen)	The display driver is trying to use a setting your monitor does not support	<ul style="list-style-type: none"> ◆ Select the correct monitor. 	Connecting your Monitor section on page 7 ~ 8
Screen is blank and power indicator is off	No power to monitor	<ul style="list-style-type: none"> ◆ Ensure that the electrical outlet and the monitor are both switched on. ◆ Check that the power cord is firmly plugged into the electrical outlet and the power supply unit. ◆ If the power cord plug has a removable fuse, replace it. ◆ Try another power cord. ◆ Try another electrical outlet. 	Connecting your Monitor section on page 7 ~ 8

Problem	Possible Cause	Suggested Action	Reference
Screen is blank and power indicator is steady green	Brightness and Contrast may be too low	<ul style="list-style-type: none"> ◆ Adjust brightness and contrast. 	User controls section on page 17
Screen is blank and power indicator is blinking green.	The monitor is in the Power Management Standby state	<ul style="list-style-type: none"> ◆ Press any key on the keyboard or move the mouse to restore operation. ◆ Check the Power Management software on your computer 	Power Management section on page 24
	The monitor is not receiving a video signal	<ul style="list-style-type: none"> ◆ Check that the signal cable is firmly connected to the computer. ◆ Check that no pins are bent in the signal cable connector. 	Connecting your Monitor section on page 7 ~ 8
	The monitor is in the Power Management Suspend or Off state	<ul style="list-style-type: none"> ◆ Press any key on the keyboard or move the mouse to restore operation. ◆ Check the Power Management software on your computer. 	Power Management section on page 24
	Display mode of the computer is outside the range of the monitor	<ul style="list-style-type: none"> ◆ Reconfigure the computer to use a supported display mode. 	Further Information section on page 22
Image appears to be smeared	There are noises in the video signal	<ul style="list-style-type: none"> ◆ Select Image Setup menu in the OSD. Then select MANUAL to adjust Phase/Clock settings. 	User Controls section on page 17
Image appears to be discolored	The Color setting may be incorrect	<ul style="list-style-type: none"> ◆ Adjust the Color settings. 	User Controls section on page 17

Problem	Possible Cause	Suggested Action	Reference
A few dots are missing, discolored, or inappropriately lighted.	◆ A small number of missing, discolored, or lighted dots may be present on the screen, which is an intrinsic characteristic of the TFT LCD technology and is not an LCD defect.		

Further Help

If you are unable to correct the problem yourself, you may seek further help as follows:

Call the IBM HelpCenter®.

In the US call 1-800-772-2227

In Canada (Toronto Only) call 416-383-3344

In Canada (all others) call 1-800-565-3344

i If possible, stay by your computer. Your Technical Support Representative may wish to go through the problem with you during the call.

i More help, late-breaking news and details of the latest accessories for these products may be found on the worldwide web at:

<http://www.pc.ibm.com/us/accessories>

In other countries contact your dealer, retailer, or other IBM authorized Servicer.

Before calling, please have available as much of the following information as possible:

1. Model and serial number from the label on your monitor.
2. Purchase receipt.
3. Description of problem.
4. Computer type and model.
5. System configuration (hardware fitted, etc.).
6. System BIOS version number.
7. Operating System and version number.
8. Display driver version number.
9. Video Adapter Type.

Specifications

This color monitor (Type-model 6636-**1) uses a 15-inch TFT LCD

Contents		Model	
		L150	L150p
Dimensions	Height :	370.0 mm (14.57 in.)	H: 439.7 mm (14.25 in) L: 314.7 mm (12.39 in)
	Depth: Width:	214.0 mm (8.43 in.) 363.6 mm (14.31 in.)	237.0 mm (9.33 in) 363.6 mm (14.31 in)
Weight	Unpackaged:	4.8 Kg (10.58 lb)	5.3 Kg (11.69 lb)
	Packaged:	6.3 Kg (13.89 lb)	6.8 Kg (14.99 lb)
Image	Viewable Image Size:	381.0 mm (15.0 in.)	381.0 mm (15.0 in.)
	Maximum Height: Maximum Width: Pixel Pitch:	228.1 mm (8.98 in) 304.1 mm (11.97 in) 0.297 mm (.012 in.) (H) × 0.297 mm (.012 in.) (V)	228.1 mm (8.98 in) 304.1 mm (11.97 in) 0.297 mm (.012 in.) (H) × 0.297 mm (.012 in.) (V)
Power Input	Supply Voltage:	100 - 240 V ac, 60/50 ± 3 Hz	100 - 240 V ac, 60/50 ± 3 Hz
	Supply Current:	1.5 A at 120 V ac	1.5 A at 120 V ac
Power Consumption	Normal Operation:	< 30 W	< 30 W
	DPMS Stand-by: DPMS Suspend: DPMS off:	< 2 W < 2 W < 1 W	< 2 W < 2 W < 1 W
Video Input (Analog)	Input Signal:	Analog Direct Drive, 75 ohm 0.7 V	Analog Direct Drive, 75 ohm 0.7 V
	Horiz. Addressability: Vert. Addressability: Clock Frequency:	1024 pixels (max) 768 lines (max) 80 MHz	1024 pixels (max) 768 lines (max) 80 MHz
Video Input (Digital)	Interface:	N/A	DVI
	Input Signal: Horiz. Addressability: Vert. Addressability: Clock Frequency:		VESA TMDS (Panel Link TM) 1024 pixels (max) 768 lines (max) 80 MHz
Communications	VESA DDC:	2 B	2 B
Supported Display Modes	VESA Standard modes between		
	Horiz. Frequency: Vert. Frequency:	30 kHz - 63 kHz 55 Hz - 75 Hz	30 kHz - 63 kHz 55 Hz - 75 Hz

 Power consumption figures are for the monitor and the power supply combined.

Model		L150	L150p
Contents			
Environment	Temperature: Operating: Storage: Shipping: Humidity: Operating: Storage: Shipping:	10 to 35° C (5 to 95° F) - 20 to 60° C (-4 to 140° F) - 20 to 60° C (-4 to 140° F)	10 to 35° C (5 to 95° F) - 20 to 60° C (-4 to 140° F) - 20 to 60° C (-4 to 140° F)
Lift		N/A	125mm
Swivel		N/A	-150° / +150°
Tilt		- 5° / + 40°	- 0° / + 30°

Service Information

The following parts are for use by IBM service, or IBM authorized dealers, to support the customer warranty. Parts are for service use only.

Model Type 6636-XX1

P/N	Description	Video	Color	MTM	Geography
06P4037	FRU Monitor	Analog	SB	6636-AB1	WW
06P4040	FRU Monitor	Hybrid	SB	6636-HB1	WW
06P4043	FRU Stand	Analog	SB	6636-AX1	WW
06P4045	FRU Video Cable	Analog	Black	6636-XX1	WW
73P2363	FRU Stand Digital	Hybrid	SB	6636-HX1	WW
06P4047	User's Guide CD			6636-XX1	Multilingual
06P4048	Steup Guide			6636-XX1	WW

Notices and Trademarks

This section contains information on notices and trademarks.

Notices

IBM may not offer the products, services, or features discussed in this document in all countries. Consult your local IBM representative for information on the products and services currently available in your area. Any reference to an IBM product, program, or service is not intended to state or imply that only that IBM product, program, or service may be used. Any functionally equivalent product, program, or service that does not infringe any IBM intellectual property right may be used instead. However, it is the user's responsibility to evaluate and verify the operation of any non-IBM product, program, or service.

IBM may have patents or pending patent applications covering subject matter described in this document. The furnishing of this document does not give you any license to these patents. You can send license inquiries, in writing, to:

*IBM Director of Licensing
IBM Corporation
North Castle Drive
Armonk, NY 10504-1785
U.S.A.*

The following paragraph does not apply to the United Kingdom or any country where such provisions are inconsistent with local law: INTERNATIONAL BUSINESS MACHINES CORPORATION PROVIDES THIS PUBLICATION "AS IS" WITHOUT WARRANTY OF ANY KIND, EITHER EXPRESS OR IMPLIED, INCLUDING, BUT NOT LIMITED TO, THE IMPLIED WARRANTIES OF NON-INFRINGEMENT, MERCHANTABILITY OR FITNESS FOR A PARTICULAR PURPOSE. Some states do not allow disclaimer of express or implied warranties in certain transactions, therefore, this statement may not apply to you.

This information could include technical inaccuracies or typographical errors. Changes are periodically made to the information herein; these changes will be incorporated in new editions of the publication. IBM may make improvements and/or changes in the product(s) and/or the program(s) described in this publication at any time without notice.

IBM may use or distribute any of the information you supply in any way it believes appropriate without incurring any obligation to you.

Any references in this publication to non-IBM Web sites are provided for convenience only and do not in any manner serve as an endorsement of those Web sites. The materials at those Web sites are not part of the materials for this IBM product, and use of those Web sites is at your own risk.

Trademarks

The following terms, used in this publication, are trademarks or service marks of the IBM Corporation in the United States, other countries, or both:

HelpCenter IBM

ENERGY STAR[®] is a U.S. Govt. registered trademark.

Microsoft[®] Windows[®], and Windows NT are trademarks of Microsoft Corporation in the United States, other countries, or both.

Other company, product, and service names may be trademarks or service marks of others.

© Copyright International Business Machines Corporation 2003. All rights reserved.

Free Manuals Download Website

<http://myh66.com>

<http://usermanuals.us>

<http://www.somanuals.com>

<http://www.4manuals.cc>

<http://www.manual-lib.com>

<http://www.404manual.com>

<http://www.luxmanual.com>

<http://aubethermostatmanual.com>

Golf course search by state

<http://golfingnear.com>

Email search by domain

<http://emailbydomain.com>

Auto manuals search

<http://auto.somanuals.com>

TV manuals search

<http://tv.somanuals.com>