

Magstar 3494 Tape Library



# Operator Guide



Magstar 3494 Tape Library



# Operator Guide

**Note!**

Before using this information and the product it supports, be sure to read the general information under "Notices" on page 337.

**Ninth Edition (May 1999)**

This edition, GA32-0280-09, is a major revision of GA32-0280-08, which is now obsolete. Significant changes or additions to the text and illustrations are indicated by a vertical line to the left of the change.

The following paragraph does not apply to any country where such provisions are inconsistent with local law.

INTERNATIONAL BUSINESS MACHINES CORPORATION PROVIDES THIS PUBLICATION "AS IS" WITHOUT WARRANTY OF ANY KIND, EITHER EXPRESS OR IMPLIED, INCLUDING, BUT NOT LIMITED TO, THE IMPLIED WARRANTIES OF MERCHANTABILITY OR FITNESS FOR A PARTICULAR PURPOSE. Some states do not allow disclaimer of express or implied warranties in certain transactions; therefore, this statement may not apply to you.

This edition applies to the initial release of the product and to all subsequent releases and modifications until otherwise indicated in new editions. Order publications through your IBM representative or the IBM branch office serving your locality. Publications are not stocked at the address given below.

A readers' comment form is provided at the back of this publication. Either mail the form or fax it to (520) 799-2906. If the form has been removed, address your comments about this book to IBM Corporation, Department 61C, 9000 South Rita Road, Tucson, Arizona 85744-0001, U.S.A.

When you send information to IBM, you grant IBM a nonexclusive right to use or distribute the information in any way it believes appropriate without incurring any obligation to you.

© **Copyright International Business Machines Corporation 1993, 1999. All rights reserved.**

US Government Users Restricted Rights – Use, duplication or disclosure restricted by GSA ADP Schedule Contract with IBM Corp.

---

# Contents

<b>Figures</b> . . . . .	ix
<b>Preface</b> . . . . .	xiii
Organization . . . . .	xiii
Related Information . . . . .	xiv
3490E . . . . .	xiv
3590 . . . . .	xv
AIX . . . . .	xv
AS/400 . . . . .	xv
RISC System/6000 . . . . .	xv
MVS . . . . .	xv
VM . . . . .	xvi
Additional . . . . .	xvi
<b>Summary of Changes</b> . . . . .	xix
<b>Chapter 1. Introduction</b> . . . . .	1
IBM 3494 Tape Libraries . . . . .	2
Functional Components . . . . .	4
Cartridge Input and Output Facilities. . . . .	16
High-Capacity Output Facility . . . . .	16
High-Capacity Input/Output Facility . . . . .	16
Single-Cell Output Facility . . . . .	17
Convenience Input/Output Station Feature . . . . .	17
Cartridge Tape. . . . .	18
Tape Cartridge Requirements . . . . .	19
Cartridge File Protection . . . . .	20
Cartridge System Tape Labels . . . . .	20
Unlabeled Tape Facility . . . . .	22
Cartridge Labeling . . . . .	22
Media-Type Labeling . . . . .	23
Cartridge Storage Cells . . . . .	24
Reserved Cartridge Storage Cells . . . . .	25
Cartridge Storage Capacity . . . . .	25
Library Manager . . . . .	27
User Interface . . . . .	27
Password-Protection . . . . .	27
Database . . . . .	28
High Availability (Model HA1) . . . . .	28
Database Information Available to a Host . . . . .	28
Operational Modes and States. . . . .	29
<b>Chapter 2. Controls and Indicators</b> . . . . .	31
Operator Panel . . . . .	32
Power Controls and Status Indicators . . . . .	32
Motion Controls and Status Indicators . . . . .	32
Convenience Input/Output Station Status Indicators . . . . .	33
Library Manager . . . . .	34
3490 Tape Subsystem Controls for Models C10, C11, C1A, C22, and C2A . . . . .	35
3490 Tape Subsystem Controls for Model F1A . . . . .	36
3590 Model B1A Tape Subsystem Controls . . . . .	37
3494 Model B18 Operator Panel . . . . .	38
Power Controls . . . . .	38

3494 Model B16 Virtual Tape Server Controls . . . . .	39
3494 Model B18 Virtual Tape Server Controls . . . . .	39
<b>Chapter 3. Operational Characteristics . . . . .</b>	<b>41</b>
3490E/3590 Tape Subsystem Operation . . . . .	41
Virtual Tape Server . . . . .	41
Emulation of 3490-Type Tape Drives . . . . .	41
Tape Volume Cache . . . . .	42
Storage Management of the Tape Volume Cache . . . . .	42
Maintaining Data Fragments from Copied Volumes . . . . .	42
Fast Response for Non-specific Mount Requests . . . . .	42
Deletion of VTS Logical Volume . . . . .	43
Scratch Stacked Volumes . . . . .	43
Integration with the 3494 Library . . . . .	44
Logical Library Partitioning . . . . .	44
SCSI Host Attachment . . . . .	44
Operator Interface . . . . .	45
Logical Volume Inventory . . . . .	45
VTS Import/Export Overview . . . . .	45
Local and Remote Power Control . . . . .	45
Operator Involvement . . . . .	46
System Administrator Involvement . . . . .	46
Error Detection and Reporting . . . . .	47
Inventory Update . . . . .	47
Volume Categories . . . . .	48
Physical Volume States . . . . .	52
Logical Volume States . . . . .	52
Physical Volser Validity Checking . . . . .	52
Logical Volser Validity Checking . . . . .	53
Command Priorities in the Queue . . . . .	54
Priority Levels . . . . .	54
Operations . . . . .	55
Host-Initiated Operations . . . . .	55
Export Operations . . . . .	57
Import Operations . . . . .	57
Stand-Alone Operations . . . . .	57
Initial Cartridge Installation . . . . .	58
Cartridge Placement . . . . .	59
Initial Volume Inventory Upload . . . . .	59
Host Operation Control . . . . .	59
Actions to Avoid when Operating a 3494 . . . . .	59
Things You Should Never Do . . . . .	60
Things You Should Try to Avoid Doing . . . . .	60
<b>Chapter 4. Operational Modes and States, and Informational States . . . . .</b>	<b>63</b>
Operational Modes . . . . .	63
Auto Mode . . . . .	63
Pause Mode . . . . .	63
Manual Mode . . . . .	63
Additional Operational Modes in the HA1 Environment . . . . .	64
Home Cell Mode . . . . .	65
Operational States . . . . .	65
Library manager initialization . . . . .	65
Initialization complete . . . . .	66
Online State . . . . .	66
Offline State . . . . .	66

Shutdown pending . . . . .	66
Library Manager Switchover in Progress . . . . .	66
Accessor Switchover in Progress . . . . .	66
Dual Active Accessor Status. . . . .	67
Informational States. . . . .	67
Relationship between Operational Modes and States . . . . .	68
Operational Mode Transitions . . . . .	68
Pause Mode to Auto Mode . . . . .	68
Auto Mode to Pause Mode (No Error) . . . . .	69
Pause Mode to Manual Mode . . . . .	70
Manual Mode to Pause Mode . . . . .	70
Auto Mode to Manual Mode. . . . .	70
Manual Mode to Auto Mode. . . . .	71
Initialization State to Auto, Pause, or Manual Mode . . . . .	71
Auto Mode to Pause Mode (Forced). . . . .	71
Operational State Transitions . . . . .	71
Shutdown Pending State to Shutdown State. . . . .	72
Shutdown State to Library Manager Initialization State . . . . .	72
Library Manager Initialization State to Initialization Complete State . . . . .	72
Offline State to Online State. . . . .	72
Online State to Offline State. . . . .	72
Initialization Complete State to Online or Offline State . . . . .	73
Offline State to Shutdown Pending State . . . . .	73
Informational State Transitions . . . . .	73
<b>Chapter 5. Basic Operating Procedures . . . . .</b>	<b>75</b>
Powering On the 3494. . . . .	75
Powering Off the 3494. . . . .	75
Changing to Pause Mode . . . . .	76
Changing to Auto Mode . . . . .	76
Changing from Local to Remote Power . . . . .	76
Changing from Remote to Local Power . . . . .	76
Inserting Cartridges . . . . .	77
Using Empty Cartridge Cells to Insert Cartridges . . . . .	77
Using the Convenience Input/Output Station Feature to Insert Cartridges . . . . .	78
Using the High-Capacity Input/Output Facility . . . . .	81
Removing Ejected Cartridges . . . . .	81
Removing an Ejected Cartridge from the Single-Cell Output Facility . . . . .	81
Removing Ejected Cartridges from the High-Capacity Output Facility. . . . .	82
Removing Ejected Cartridges from the High-Capacity Input/Output Facility . . . . .	82
Removing Ejected Cartridges from the Convenience Input/Output Station Feature . . . . .	82
<b>Chapter 6. Advanced Operating Procedures . . . . .</b>	<b>85</b>
Using the Library Manager . . . . .	88
Making Library Manager Selections . . . . .	92
Selections with the Keyboard . . . . .	92
Selections with the Pointing Device . . . . .	92
Track Pointer Keyboard . . . . .	93
Using the Help Pull-Down . . . . .	94
Help Search . . . . .	95
Help Action Bar and Function Keys . . . . .	95
Key Functions . . . . .	96
Using the Operator Menu. . . . .	98
Using the Mode Pull-Down . . . . .	99
Auto . . . . .	100

Pause . . . . .	100
Manual . . . . .	101
Online . . . . .	101
Offline . . . . .	103
Service Menu . . . . .	104
Switch Active Library Manager to Standby . . . . .	105
Accessors . . . . .	106
Lockup Library Manager . . . . .	108
Shutdown . . . . .	108
Using the Status Pull-Down . . . . .	109
Operational Status . . . . .	111
Component Availability . . . . .	115
VTS Status . . . . .	118
Performance Statistics . . . . .	119
Accessor Mounts per Hour . . . . .	122
VTS Active Data . . . . .	123
VTS Data Flow . . . . .	125
VTS Mount Hit Data . . . . .	126
VTS Physical Device Mount History . . . . .	128
VTS Logical Mounts Per Hour . . . . .	129
VTS Active Data Distribution . . . . .	130
Using the System Summary . . . . .	131
LAN Status . . . . .	135
Dual Accessor Zones . . . . .	136
Using the Queues Pull-Down . . . . .	137
Using the Database Pull-Down . . . . .	139
Search Database For Volumes . . . . .	139
Find Logical Volume's Home . . . . .	144
List Database Volumes . . . . .	145
Stacked Volume Map . . . . .	150
Using the Commands Pull-Down . . . . .	152
Schedule Cleaning . . . . .	155
Eject a Cleaner Cartridge . . . . .	158
Cleaner Cartridge Masks . . . . .	158
Send Message to Host Consoles . . . . .	159
Promote a Command in the Queue . . . . .	160
Volser Range for Media Types . . . . .	161
Insert VTS Logical Volumes . . . . .	163
Insert VTS Logical Volumes Status . . . . .	165
Eject a VTS Stacked Volume . . . . .	165
Set VTS Category Attributes . . . . .	166
Set VTS Management Policies . . . . .	167
Inventory New Storage or Re-inventory Complete System . . . . .	169
Re-Inventory with Virtual Tape Servers . . . . .	174
Inventory Update . . . . .	176
Stand-Alone Device . . . . .	180
Insert Unlabeled Cartridges . . . . .	184
Add LAN Host . . . . .	185
Delete LAN Host . . . . .	190
Update LAN Host Information . . . . .	191
LM LAN Information . . . . .	198
Operator Intervention . . . . .	199
System Administrator Password . . . . .	200
Managing Import/Export Volumes . . . . .	202
Manage Unassigned Volumes . . . . .	202
Manage Import Volumes . . . . .	204



Manage Insert Volumes . . . . .	205
Manage Export-Hold Volumes . . . . .	206
Cancel Export/Import . . . . .	207
Service Access . . . . .	208
SNMP Options . . . . .	208
Using the Library Manager's SNMP Features . . . . .	209
Trouble Shooting . . . . .	213
Receiving SNMPD Traps on the Monitor Station . . . . .	213
Programming Tools . . . . .	215
OPINT Library Manager SNMP Traps . . . . .	215
UNSOL Library Manager SNMP Traps . . . . .	221
CHCK1 Library Manager SNMP Traps . . . . .	226
TESTM Library Manager SNMP Traps . . . . .	226
Using the Options Pull-Down . . . . .	226
Using Manual Mode. . . . .	227
Starting Manual Mode . . . . .	228
Operating in Manual Mode . . . . .	230
Mounting Cartridges . . . . .	231
Demounting Cartridges . . . . .	232
Inserting Cartridges . . . . .	232
Ejecting Cartridges . . . . .	234
Reviewing Unknown Volume Locations. . . . .	235
Error Processing . . . . .	236
Locating and Identifying Home Cell Locations . . . . .	237
Ending Manual Mode . . . . .	238
Cartridge Removal from the Gripper. . . . .	239
Using the Keyboard Template . . . . .	240
<b>Chapter 7. Remote Library Manager Console Feature . . . . .</b>	<b>241</b>
Installing and Configuring. . . . .	242
Starting DCAF on the Remote Library Manager Console . . . . .	242
Controlling the Tape Library from the Remote Library Manager Console . . . . .	246
Using Keystrokes during a Session from the Remote Library Manager Console . . . . .	246
Using Hot-Key Combinations . . . . .	248
Sending the Alt+Esc Command to the Library Manager. . . . .	248
Sending the Alt+Tab Command to the Library Manager. . . . .	248
Sending the Ctrl+Esc Command to the Library Manager . . . . .	249
Changing the Session State from the Remote Library Manager Console . . . . .	249
Using the Pointing Device during a Session . . . . .	251
Moving Among Multiple Sessions. . . . .	253
Transferring Files. . . . .	253
Library Manager Operations with a Remote Library Manager Console . . . . .	253
Changing the Session State of the Library Manager . . . . .	253
Changing the Password from the Library Manager . . . . .	255
Remote Library Manager Console Problem Analysis and Operational Tips. . . . .	257
<b>Chapter 8. Problem Determination Procedures . . . . .</b>	<b>259</b>
Quick Reference Table to Problem Determination Procedures . . . . .	259
Failure and Exception Condition Reporting . . . . .	260
Library Manager Failure Recovery Procedures . . . . .	261
Library Manager Failure in a DFSMS/MVS Environment . . . . .	261
Start the Library Manager and Host Recovery Procedure (DFSMS/MVS Environment) . . . . .	263
Library Manager Failure in an MVS/BTLS Environment. . . . .	265

Start the Library Manager and Host Recovery Procedure (MVS/BLTS Environment) . . . . .	266
DFSMS System Managed Tape Messages . . . . .	268
Table for DFSMS Library Failure Messages or Exception Conditions . . . . .	269
Information Provided at the Library Manager Console . . . . .	276
Using the System Summary Window . . . . .	277
Using the Component Availability Status Window . . . . .	279
Using the Search Database for Volumes Window . . . . .	279
Using the Whole Queue Window . . . . .	282
Intervention Required Conditions and Actions . . . . .	282
Quick Reference Table to Intervention Required Conditions . . . . .	283
Table for Intervention Conditions of Library Tape Drives . . . . .	284
Table for Intervention Conditions of Other Library Components . . . . .	285
Table for Intervention Conditions of Input/Output Stations . . . . .	286
Table for Intervention Conditions of External Cartridge Labels . . . . .	288
Table for Intervention Conditions of Data Cartridges . . . . .	292
Table for Intervention Conditions of Cleaner Cartridges . . . . .	293
Table for Intervention Conditions of a Library Virtual Tape Server . . . . .	295
Virtual Tape Server Recovery Actions . . . . .	302
<b>Appendix A. Keyboard Template . . . . .</b>	<b>305</b>
<b>Appendix B. Virtual Tape Server Import/Export Advanced Function. . . . .</b>	<b>307</b>
Import and Export List Volumes Format . . . . .	307
Export List Volume . . . . .	307
Import List Volume . . . . .	314
Status Codes in Status File . . . . .	316
Import and Export Messages from Library . . . . .	326
Export Status Messages . . . . .	327
Import Status Messages . . . . .	330
Export/Import List Volumes Failure-Reason Text . . . . .	331
Category Recovery . . . . .	334
Reuse of Exported Stacked Volumes . . . . .	335
<b>Notices . . . . .</b>	<b>337</b>
Trademarks. . . . .	337
Communications Statements . . . . .	338
Federal Commission (FCC) Statement . . . . .	338
Laser Safety and Compliance . . . . .	339
Operator Safety . . . . .	340
<b>Glossary . . . . .</b>	<b>341</b>
<b>Index . . . . .</b>	<b>347</b>
<b>Readers' Comments — We'd Like to Hear from You. . . . .</b>	<b>353</b>

# Figures

1. IBM 3494 Tape Libraries . . . . .	3
2. Control Unit Frame Functional Components, 3490E (Front View) . . . . .	5
3. Control Unit Frame Functional Components, 3590 (Front View) . . . . .	6
4. Control Unit Frame Functional Components (Rear View) . . . . .	7
5. Storage Frame Functional Components (front) . . . . .	8
6. Drive Unit Frame Functional Components (front) . . . . .	9
7. Drive Unit Frame Functional Components (rear) . . . . .	10
8. Model B16 Virtual Tape Server Functional Components (front) . . . . .	11
9. Model B16 Virtual Tape Server Functional Components (rear) . . . . .	12
10. Model B18 Virtual Tape Server (front) . . . . .	13
11. Model B18 Virtual Tape Server Functional Components (rear) . . . . .	14
12. Model HA1, Left Service Bay Functional Components (right front) . . . . .	15
13. Model HA1, Right Service Bay Functional Components (right front) . . . . .	16
14. Control Unit Frame Cartridge Storage Cells . . . . .	17
15. Cartridge System Tape Identification . . . . .	19
16. Cartridge System Tape . . . . .	20
17. Cartridge System Tape Labels . . . . .	21
18. Cartridge Label Position . . . . .	23
19. Cartridge Storage Cell Names . . . . .	24
20. Cartridge Storage Cell Labeling . . . . .	25
21. Control Unit Frame Front Door . . . . .	31
22. Operator Panel without Convenience Input/Output Station Feature . . . . .	33
23. Operator Panel with Convenience Input/Output Station Feature . . . . .	34
24. Library Manager . . . . .	35
25. 3490E Controls and Indicators . . . . .	36
26. 3490E Controls and Indicators for Model F1A . . . . .	37
27. 3590 Model B1A Operator Panel . . . . .	38
28. Model B18 Virtual Tape Server Operator Panel . . . . .	39
29. Active Library Manager. . . . .	64
30. Standby Library Manager . . . . .	65
31. Dual Active Accessor Status — enabling . . . . .	67
32. Dual Active Accessor Status — disabling . . . . .	67
33. Auto Pending Pop-Up Window . . . . .	69
34. Inserting Cartridges in the Convenience Input/Output Station . . . . .	79
35. Optional 30-Cell I/O . . . . .	80
36. Operator Panel Controls . . . . .	89
37. System Menu . . . . .	90
38. Pointing Device . . . . .	93
39. Track Pointer Keyboard . . . . .	94
40. Help Pull-Down Menu . . . . .	94
41. Help Index Pop-Up Window . . . . .	95
42. Operator Menu. . . . .	98
43. System Summary Pop-Up Window . . . . .	98
44. Mode Pull-Down Menu . . . . .	99
45. Initial Mode/State Selection Pop-Up Window . . . . .	102
46. Fast-Ready Category Check Pop-Up Window . . . . .	102
47. Offline Request Pop-Up Window . . . . .	103
48. Mode/State Change Request Pop-Up Window . . . . .	104
49. Service Menu Notice . . . . .	104
50. System Administrator Password Pop-Up Window . . . . .	105
51. Library Switch Over Confirmation Pop-Up Window . . . . .	105
52. Switching Pop-Up Window . . . . .	106
53. Accessor Switch Over Confirmation Pop-Up Window . . . . .	106

54. Switching Pop-Up Window . . . . .	107
55. Dual Active Accessor Status Pop-Up Window — Enabling . . . . .	107
56. Mark Accessor Active Pop-Up Window . . . . .	108
57. Dual Active Accessor Status Pop-Up Window — Disabling. . . . .	108
58. System Administrator Password Pop-Up Window . . . . .	109
59. Shutdown Panel . . . . .	109
60. Status Pull-Down Menu . . . . .	110
61. (Part 1 of 3) Operational Status Pop-Up Window . . . . .	111
62. (Part 2 of 3) Operational Status Pop-Up Window (single accessor systems) . . . . .	113
63. (Part 3 of 3) Operational Status Pop-Up Window (dual accessor systems) . . . . .	114
64. (Part 1 of 3) Component Availability Status Pop-Up Window . . . . .	116
65. (Part 2 of 3) Component Availability Status Pop-Up Window . . . . .	117
66. (Part 3 of 3) Component Availability Status Pop-Up Window . . . . .	117
67. VTS Status Pop-Up Window. . . . .	118
68. (Part 1 of 2) Performance Statistics Pop-Up Window . . . . .	120
69. (Part 2 of 2) Performance Statistics Pop-Up Window . . . . .	121
70. Accessor Mounts per Hour Pop-Up Window . . . . .	122
71. VTS Active Data Pop-Up Window . . . . .	123
72. VTS Data Flow Pop-Up Window . . . . .	125
73. VTS Mount Hit Data Pop-Up Window . . . . .	126
74. VTS Physical Device Mount History Pop-Up Window. . . . .	128
75. VTS Logical Mounts Per Hour Pop-Up Window . . . . .	129
76. VTS Active Data Distribution Pop-Up Window . . . . .	130
77. System Summary Pop-Up Window . . . . .	131
78. LAN Status Pop-Up Window. . . . .	135
79. Dual Accessor Zones Pop-Up Window . . . . .	136
80. Queues Pull-Down Menu . . . . .	137
81. Mount Queue . . . . .	138
82. Database Pull-Down Menu . . . . .	139
83. Search Database for Volumes Pop-Up Window . . . . .	140
84. Status Flags. . . . .	143
85. Find Logical Volume's Home Pop-Up Window . . . . .	144
86. List Database Volume's Pop-Up Window . . . . .	145
87. Stacked Volume Map Pop-Up Window . . . . .	150
88. Commands Pull-Down Menu . . . . .	152
89. Clean Schedule Pop-Up Window . . . . .	157
90. Eject a Cleaner Cartridge Pop-Up Window . . . . .	158
91. Cleaner Cartridge Masks . . . . .	159
92. Host Message Pop-Up Window . . . . .	160
93. Promote Command Pop-Up Window. . . . .	160
94. Volser Ranges Pop-Up Window . . . . .	162
95. Insert VTS Logical Volumes Pop-Up Window . . . . .	164
96. Insert VTS Logical Volumes Status Pop-Up Window . . . . .	165
97. Eject a VTS Stacked Volume Pop-Up Window . . . . .	166
98. Set VTS Category Attributes Pop-Up Window . . . . .	167
99. Set VTS Management Policies Pop-Up Window . . . . .	169
100. Display VTS Export/Import Volumes Window. . . . .	170
101. Save Logical Volumes Window . . . . .	171
102. Set the Volser Range Window . . . . .	171
103. Inventory Cleaner Masks Pop-Up Window. . . . .	172
104. Inventory Status Pop-Up Window . . . . .	173
105. Inventory Status Pop-Up Window (Dual Active Accessor systems) . . . . .	173
106. Service Pull-down Menu . . . . .	175
107. VTS Online/Offline Pop-Up Window . . . . .	176
108. Disable Inventory Update Dialog Box . . . . .	177

109. Enable Inventory Update Dialog Box . . . . .	177
110. Perform Inventory Update Dialog Box . . . . .	178
111. Inventory Update Status Box . . . . .	178
112. Inventory Update Status Box (Dual Active Accessor systems) . . . . .	178
113. Perform Inventory Update (Partial) Window . . . . .	179
114. Setup Stand-Alone Device Pop-Up Window . . . . .	181
115. Reset Stand-Alone Device Pop-Up Window . . . . .	183
116. Stand-Alone Device Status Pop-Up Window . . . . .	183
117. Insert Unlabeled Cartridges Window . . . . .	185
118. Add LAN Host to Library Pop-Up Window (APPC Selected) . . . . .	186
119. Add LAN Host to Library Pop-Up Window (APPC/VTAM Selected). . . . .	188
120. Add LAN Host to Library Pop-Up Window (TCP/IP Selected). . . . .	190
121. Delete LAN Host from Library Pop-Up Window . . . . .	191
122. Update LAN Host Information Pop-Up Window . . . . .	192
123. Change LAN Host Information Pop-Up Window (APPC) . . . . .	193
124. Change LAN Host Information Pop-Up Window (APPC/VTAM) . . . . .	195
125. Change LAN Host Information Pop-Up Window (TCP/IP) . . . . .	197
126. Library LAN Information Pop-Up Window . . . . .	198
127. Operator Intervention Pop-Up Window . . . . .	200
128. System Administrator Password Pop-Up Window . . . . .	201
129. Manage Unassigned Volumes Pop-Up Window . . . . .	202
130. Manage Import Volumes Pop-Up Window . . . . .	204
131. Manage Insert Volumes Pop-Up Window . . . . .	205
132. Manage Export-Hold Volumes Pop-Up Window . . . . .	206
133. Cancel Export/Import Pop-Up Window . . . . .	207
134. SNMP Basic Block Diagram . . . . .	208
135. Select SNMP Trap Types Pop-Up Window . . . . .	210
136. Change SNMP Trap Destinations Pop-Up Window (OS/2 2.11) . . . . .	211
137. SNMP Configuration Pop-Up Window . . . . .	212
138. TESTM SNMP Trap Message Pop-Up Window . . . . .	213
139. Options Pull-Down Menu . . . . .	227
140. Mode Pull-Down Menu . . . . .	228
141. Mode/State Change Request Pop-Up Window . . . . .	228
142. Manual Pending Wait Message. . . . .	229
143. Manual Mode Terminal Pop-Up Window with Action List . . . . .	230
144. Manual Mode Insert Cartridges Screen . . . . .	233
145. Manual Mode Insert Cartridges Pop-Up Window . . . . .	234
146. Manual Mode Review List Screen. . . . .	236
147. Manual Mode Error Processing Screen. . . . .	237
148. Manual Mode Locate Cartridge Home Screen . . . . .	238
149. Cartridge Removal from the Gripper . . . . .	239
150. LAN Attachments . . . . .	241
151. Icon for Distributed Console Access Facility . . . . .	242
152. Distributed Console Access Facility Icon . . . . .	242
153. DCAF Controlling Main Window . . . . .	243
154. DCAF Directory . . . . .	243
155. DCAF Target Password . . . . .	244
156. Initiating the Remote Library Manager Console . . . . .	244
157. Establishing Communication with the Library Manager . . . . .	245
158. Remote Library Manager Console Main Menu . . . . .	245
159. Remote Library Manager Console Window with Keystrokes Pull-Down Menu . . . . .	247
160. Remote Library Manager Console Session Window with Session Pull-Down Menu . . . . .	250
161. Remote Library Manager Console Session Window . . . . .	252
162. Window List . . . . .	254

163. Active Session . . . . .	255
164. Changing Sessions . . . . .	255
165. Session Pull-down Menu . . . . .	256
166. DCAF Password . . . . .	256
167. Library Manager Switching Window . . . . .	264
168. Library Manager Switching Window . . . . .	267
169. Status Flags. . . . .	280
170. Laser Safety Caution Label . . . . .	340

---

## Preface

This book provides information for the new operator and for the experienced operator to use the IBM Magstar 3494 Tape Library. If you are a **new operator**, give special attention to the organization of this book (see "Organization") and read the sections indicated for **new operators**.

Users of this information should be familiar with the 3490E magnetic tape subsystems. IBM recommends that you read the *IBM 3494 Tape Library Introduction and Planning Guide*, GA32-0279.

---

## Organization

The material in this publication is presented as follows:

- "Chapter 1. Introduction" on page 1 contains an introduction and a description of the IBM 3494 Tape Library. This section is required reading if you are a **new operator**.
- "Chapter 2. Controls and Indicators" on page 31 contains a description of the location and function of the controls and indicators found on the 3494. This section is required reading if you are a **new operator**.
- "Chapter 3. Operational Characteristics" on page 41 contains a description of the operational characteristics of the 3494. This section includes information for the experienced operator or system administrator.
- "Chapter 4. Operational Modes and States, and Informational States" on page 63 provides a description of the different modes and states of the 3494. This section includes information for the experienced operator or system administrator.
- "Chapter 5. Basic Operating Procedures" on page 75 provides a description of the tasks performed by using the 3494 operator panel. This section is required reading if you are a **new operator**.  
A quick reference table for basic operating procedures is included at the start of this section.
- "Chapter 6. Advanced Operating Procedures" on page 85 provides detailed information about using the library manager and the tasks that may be performed with the library manager. This section includes information for the experienced operator or system administrator.  
A quick reference table for advanced operating procedures is included at the start of this section.
- "Chapter 7. Remote Library Manager Console Feature" on page 241 provides information on the remote library manager.
- "Chapter 8. Problem Determination Procedures" on page 259 provides information on error reporting and recovery. This section includes information for the experienced operator or system administrator.  
A quick reference table for problem determination procedures is included in this section.
- "Appendix A. Keyboard Template" on page 305 identifies the uses of the library manager function keys.
- "Glossary" on page 341 lists important terms used in this book.

- “Index” on page 347 lists items to which a reader may need to refer.

---

## Related Information

For additional information about the IBM 3494 Tape Library, see:

- *IBM 3494 Tape Library Operator Safety Translations*, GA32-0299
- *IBM 3494 Tape Library Introduction and Planning Guide*, GA32-0279
- *IBM 3494 Tape Library User's Guide: Media Library Device Driver for AS/400* , GC35-0153
- *IBM 3494 Tape Library User's Guide: Library Control Device Driver for VSE/ESA*, GC35-0176
- *IBM Online Library Omnibus Edition Hardware Collection*, SK2T-5843.
- *IBM 3494 Tape Library Operator Training Video Tape*, GV38-0294 (PAL format) or GV38-0293 (NTSC format)
- *IBM 3494 Tape Library Operator's Quick Guide*, GX35-5051
- *IBM Magstar 3494 Tape Libraries: A Practical Guide*, SG24-4632
- *IBM Magstar Virtual Tape Server: Implementation Guide*, SG24-2229
- *Guide to sharing and partitioning IBM Tape Library Dataservers*, SG24-4409

## 3490E

For additional information about the IBM 3490E Magnetic Tape Subsystems, see:

- *Care and Handling of the IBM Magnetic Tape Cartridge*, GA32-0047
- *Tape and Cartridge Requirements for the IBM Magnetic Tape Cartridge Drives*, GA32-0048
- *Tape and Cartridge Requirements for the IBM Enhanced Capacity Magnetic Tape Cartridge Drives*, GA32-0216
- *IBM 3490 Magnetic Tape Subsystem Enhanced Capability Models C10, C11, C1A, C22, and C2A Introduction*, GA32-0217
- *IBM 3490 Magnetic Tape Subsystem Enhanced Capability Models C10, C11, C1A, C22, and C2A Operator's Guide*, GA32-0218
- *IBM 3490 Magnetic Tape Subsystem Enhanced Capability Models C10, C11, C1A, C22, and C2A Hardware Reference*, GA32-0219
- *IBM 3490 Magnetic Tape Subsystem Enhanced Capability Models C10, C11, C1A, C22, and C2A Planning and Migration Guide*, GC35-0219
- *Distributed Console Access Facility: Installation and Configuration Guide*, SH19-4068
- *Distributed Console Access Facility: User's Guide*, SH19-4069
- *IBM 3490E Tape Subsystem Models F01, F1A, F11, and FC0 Installation, Planning and Operator's Guide*, GA32-0378
- *FC 3000 Maintenance Instructions*, GA32-0402



## 3590

- *IBM 3590 High Performance Tape Subsystem Introduction and Planning Guide*, GA32-0329.
- *IBM 3590 High Performance Tape Subsystem Hardware Reference*, GA32-0331
- *IBM 3590 High Performance Tape Subsystem User's Guide*, GA32-0330.
- *IBM 3590 High Performance Tape Subsystem Operator's Training Video Tape*, GV38-0290 (NTSC format) or GV38-0291 (PAL format)
- *IBM 3590 High Performance Tape Subsystem Operator's Quick Guide*, GA32-0354
- *IBM Magstar 3590 Tape Subsystem: Multiplatform Implementation*, SG24-2549

## AIX

For additional information about the AIX subsystems and software, see:

- *AIX/ESA System Planning Guide*, GC23-3061
- *AIX/ESA Diagnosis Guide*, SC23-3079
- *AIX/ESA Device Driver Developer's Guide*, SC23-3085
- *AIX Parallel and ESCON Channel Tape Attachment/6000 Installation and User's Guide*, GA32-0311
- *AIX for RISC System/6000 Installation Guide*, SC23-2341
- *AIX for RISC System/6000 General Concepts and Procedures*, GC23-2202

## AS/400

For additional information about the AS/400 subsystems and software, see:

- *AS/400 Physical Planning Guide and Reference*, GA41-9571
- *IBM Application System/400 Control Language Reference*, SC41-0030
- *IBM Application System/400 Security Concepts and Planning*, SC41-8083
- *AS/400 Automated Tape Library Planning Guide - V3R6 Documentation*, SC41-3309

## RISC System/6000

For additional information about the RISC System/6000 subsystems and software, see:

- *RISC System/6000 Getting Started: Using RISC System/6000*, GC23-2377
- *RISC System/6000 Getting Started: Managing RISC System/6000*, GC23-2378
- *RISC System/6000 Problem Solving Guide*, SC23-2204
- *RISC System/6000 System Overview*, GC23-2406
- *RISC System/6000 Planning for System Installation*, GC23-2407

## MVS

For information about MVS systems and software, see:

- *Basic Tape Library Support User's Guide and Reference*, SC26-7016
- *DFSMS/MVS General Information Library Guide*, GC26-4900
- *DFSMS/MVS Object Access Method Planning, Installation, and Storage Administration Guide for Tape Libraries*, SC26-3051

- *DFSMS/MVS Implementing and Customizing DFSMSShsm* , SH21-1078
- *DFSMS/MVS Planning for Installation* , SC26-4919
- *DFSMS/MVS Object Access Method Application Programmer's Reference* , SC26-4917
- *DFSMS/MVS Guide and Master Index* , GC26-4904
- *JES3 Command Reference* , SC23-0063
- *Multiple Virtual Storage/Enterprise System Architecture Library Guide for System Product* , GC28-1601
- *MVS/ESA Storage Management Library: Storage Management Reader's Guide* , GC26-3122
- *MVS/ESA Planning: Installation and Migration for MVS/ESA System Product Version 4* , GC28-1077
- *MVS/ESA Conversion Notebook for MVS/ESA System Product Version 4* , GC28-1608
- *MVS/ESA System Data Set Definition* , GC28-1628
- *MVS/ESA Command Reference* , GC28-1826

## VM

For information about VM systems and software, see:

- *Virtual Machine/Enterprise System Architecture Library Guide and Master Index* , GC24-5518
- *Virtual Machine/Enterprise System Architecture Library Guide and Master Index for System/370* , GC24-5436
- *Virtual Machine/Enterprise System Architecture General Information* , GC24-5550
- *VM/ESA: DFSMS/VM Installation and Customization* , SC26-4704
- *VM/ESA: DFSMS/VM Removable Media Services User's Guide and Reference* , SC35-0141
- *VM/ESA: DFSMS/VM Messages and Codes* , SC26-4707

## Additional

For additional information, see:

- *Environmental Record Editing and Printing (EREP) Program User's Guide and Reference* , GC28-1378
- *IBM General Information Manual: Installation Manual—Physical Planning* , GC22-7022
- *IBM SCSI Tape Drive and Library Device Drivers Installation and User's Guide* , GC35-0154
- *IBM System/360, System/370, 4300, 9370, and ES/9000 Processors: Input/Output Equipment Installation Manual—Physical Planning* , GC22-7064
- *Resource Access Control Facility (RACF) General Information* , GC28-0722
- *POWERstation and POWERserver System/390 Enterprise Systems Connection Channel Emulator User's Guide and Service Information* , SA23-2722
- *POWERstation and POWERserver S/370 Channel Emulator/A User's Guide and Service Information* , SA23-2696
- *VTAM V4R2 Resource Definition Reference* , SC31-6498
- *VSE/ESA System Control Statements V2R1* , SC33-6613
- *Distributed Console Access Facility: V1R3 Installation Guide* , SH19-4068

- *Distributed Console Access Facility: V1R3.1 Target User's Guide* , SH19-6839
- *Distributed Console Access Facility: V1R3.1 User's Guide* , SH19-4069

You can send us comments about this book electronically:

- IBMLink from US: STARPUBS at SJEVM5
- IBMLink from Canada: STARPUBS at TORIBM
- IBM Mail Exchange: USIB3VVD at IBMMAIL
- Internet: [starpubs@us.ibm.com](mailto:starpubs@us.ibm.com)



---

## Summary of Changes

This book contains the following changes to the previous edition.

- Addition of VTS Import/Export functions
- Addition of SCSI attachment capability to VTS subsystems
- Attachment to Microsoft Windows NT processors

Changes to correct errors or omissions in the previous edition are also included.



---

## Chapter 1. Introduction

The 3494 Tape Library automates the retrieval, storage, and control of Cartridge System Tape, Enhanced Capacity Cartridge System Tape, and High Performance Cartridge Tape. In conjunction with supporting software and 3490E Models C1A, C2A and F1A, 3590 Model B1A, 3590 Model A00 or A50, 3494 Model B16 and B18 Virtual Tape Servers, and Model HA1 High Availability Unit, the 3494 allows cartridges to be mounted and demounted automatically on tape drives.

**Note:** The *3494 Operator Training Video Tape* and the *3494 Operator's Quick Guide* are supplied with accessories.

---

## IBM 3494 Tape Libraries

Figure 1 on page 3 shows three possible configurations of the 3494. The 3494 is available in multiple configurations using one control unit frame and up to fifteen optional frames. The available frame types are:

- The tape library control unit frame, **1** or **3**, includes the operator panel, a tape subsystem (3490E Model CxA or F1A with drives, 3590 Model B1A tape drives, or 3590 Model A00 or A50 Control Unit with drives), a library manager, cartridge storage cells, a cartridge accessor, and if ordered, the Convenience Input/Output Station. One control unit frame is required in every library configuration.
- The optional drive unit frame **4** contains additional cartridge storage and may contain a 3490E Model CxA or F1A tape subsystem, 3590 Model B1A tape drives, or a 3590 Model A00 or A50 Control Unit with drives.
- The optional Model B16 Virtual Tape Server (VTS) frame **5** contains additional cartridge storage and the controller and associated disk storage for the VTS. A drive unit frame **4** that holds the 3590 Model B1A tape drives, managed by the Model B16 VTS, must be located to the left of the Model B16 Virtual Tape Server frame.
- The optional stand-alone 3494 Model B18 Virtual Tape Server frame **8** contains the controller and associated disk storage for the VTS. A drive unit frame **4** that holds the 3590 Model B1A tape drives, managed by the Model B18 VTS, may be located at any position in the library (except frame 1) but must be within a distance of 14 m (46 ft.) from the Model B18.
- The optional frame **6** contains additional cartridge storage only.
- The Optional HA1 Service Bays (left **2** and right **7**) contain a service area for the accessors.



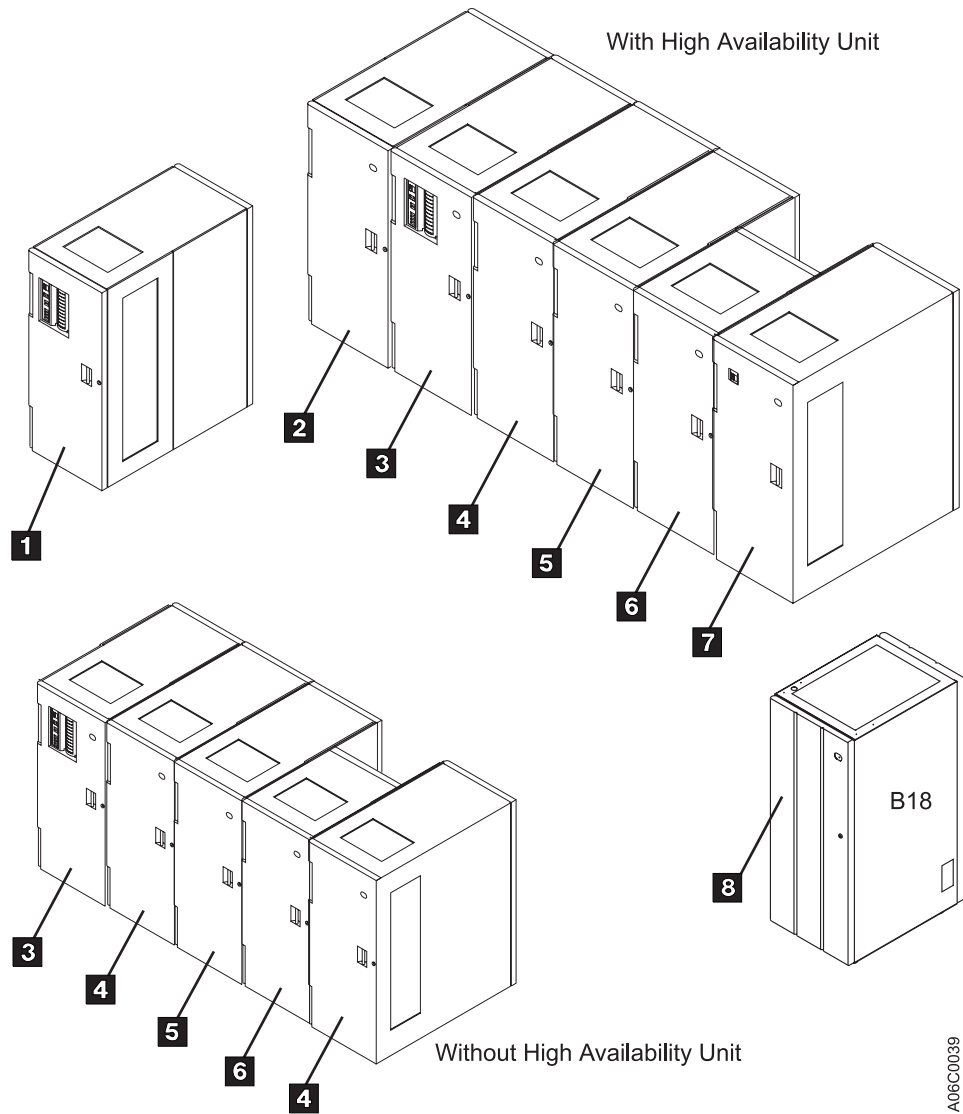

A06C0039

Figure 1. IBM 3494 Tape Libraries

**Note:** For additional 3494 configurations, see *IBM 3494 Tape Library Introduction and Planning Guide, GA32-0279*.

The control unit frame provides full library function without the other optional frames. Adding the optional frames to the control unit frame provides for additional storage and tape drive capabilities. See Table 2 on page 25 for the cartridge capacity of each frame.

---

## Functional Components

Figure 2 on page 5 and Figure 3 on page 6 show the following functional components of the control unit frame, viewable from the front:

**1 Cartridge storage cells**

Are located on the interior side of front doors and on the back walls of the 3494. See **1** in Figure 2 on page 5 or in Figure 3 on page 6.

**2 Magnetic tape subsystem**

The 3494 uses either the 3490E Magnetic Tape Subsystem Model C1A or C2A, Figure 2 on page 5, 3490E Magnetic Tape Subsystem Model F1A, or the 3590 High Performance Magnetic Tape Subsystem Model B1A, Figure 3 on page 6, with or without a 3590 Model A00 or A50 Control Unit.

**3 Rail system**

The cartridge accessor is carried through the library on the rail system. The rail system consists of two horizontal rails, one at the top and one at the bottom.

**4 Convenience Input/Output Station**

The 3494 may have a Convenience Input/Output Station feature installed for inserting or ejecting cartridges without interrupting the normal automated operations.

Two features are available: either the ten-cartridge capacity Convenience Input/Output Station as shown in Figure 2 on page 5 or the 30-cartridge capacity Convenience Input/Output Station (not shown).

**Note:** The Convenience Input/Output Station feature is required for Import/Export operations in the Model B18 VTS with the Advanced Function Feature.

**5 Operator panel**

The basic operating procedures are performed from the operator panel.

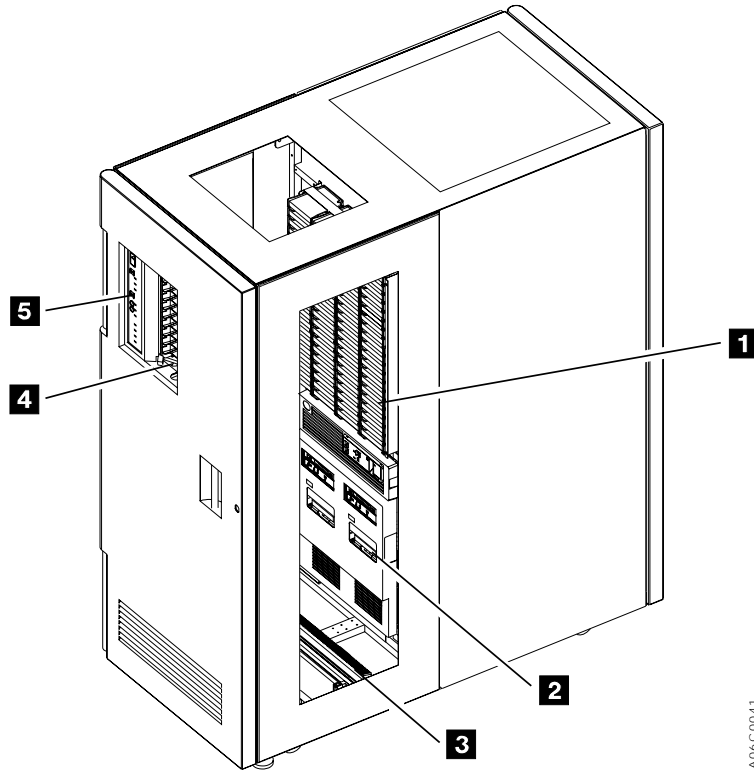

Figure 2. Control Unit Frame Functional Components, 3490E (Front View)

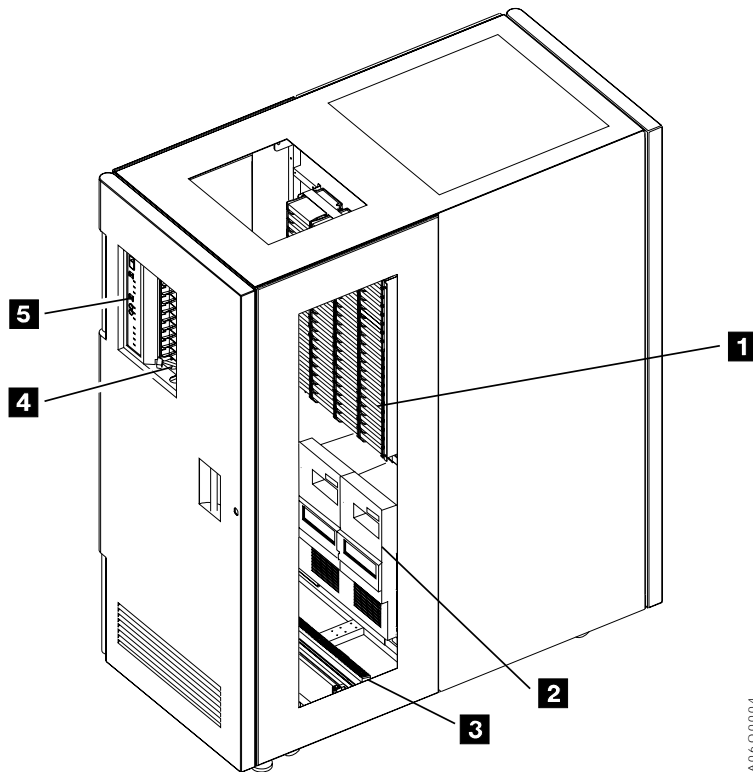

Figure 3. Control Unit Frame Functional Components, 3590 (Front View)

Figure 4 on page 7 shows the following functional components of the control unit frame, viewable from the rear:

**1 Library manager**

Controls all operations in the 3494. Its hardware consists of a controller, display, pointing device, and keyboard. An optional Remote Library Manager Console feature is also available for remote installation on a Local Area Network (LAN) environment. During normal operations, the operator panel controls are used to operate the 3494. The library manager is used for error recovery, operations status, and service.

**2 Cartridge storage cells**

Are located on the interior side of the front doors on the 3494 and on the back interior wall.

**3 Cartridge accessor**

Moves on horizontal and vertical axes, moving cartridges between the storage cells, devices, and input and output facilities. The vision system (barcode reader) on the cartridge accessor identifies cartridges.

**4 Picker**

Is the part of the cartridge accessor that actually picks cartridges. The picker comes standard with one gripper installed or two grippers if the optional Dual Gripper feature is installed.

**5 3590 Model A00 or A50 Control Unit**

is the 3590 Model A00 or A50 Control Unit.

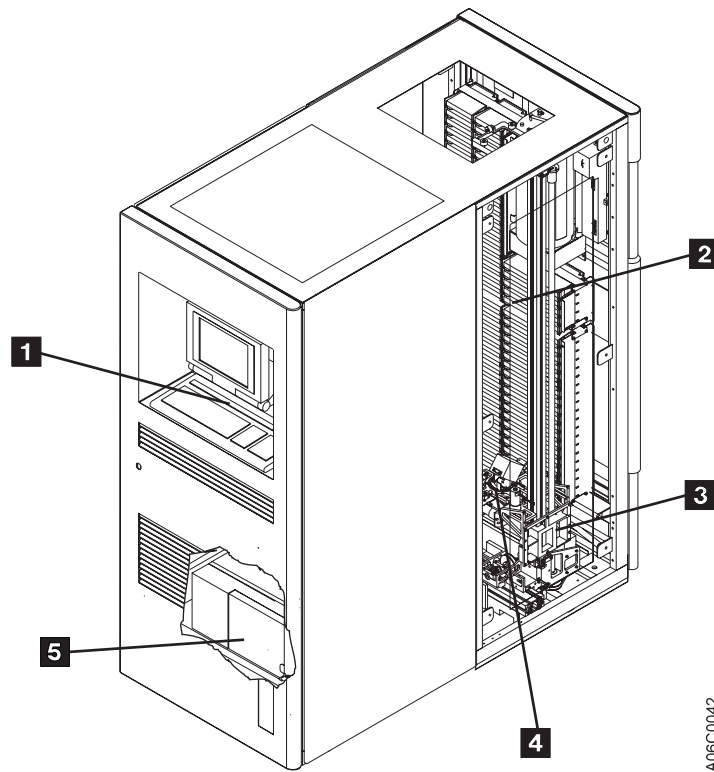

Figure 4. Control Unit Frame Functional Components (Rear View)

Figure 5 on page 8 shows the functional components of the storage frame, viewable from the front:

**1 Cartridge storage cells**

Are located on the interior side of the front door and on the back wall of the frame.

**2 Rail system**

The cartridge accessor is carried through the library on the rail system installed in each frame. The rail system consists of two horizontal rails, one at the top and one at the bottom of the frame.

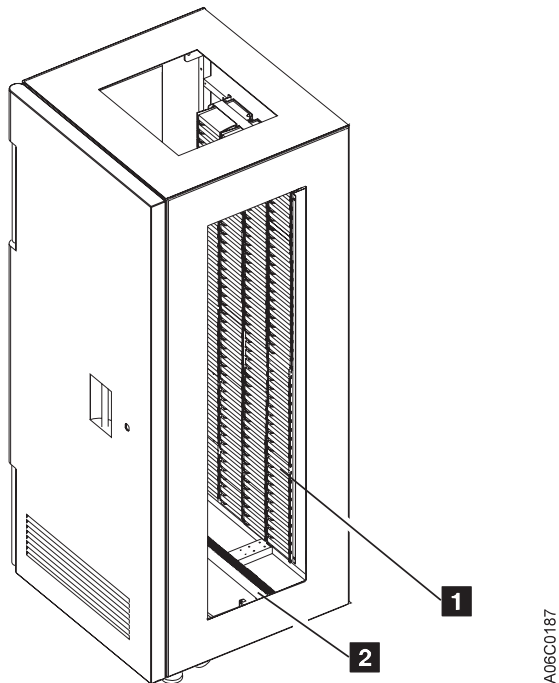

Figure 5. Storage Frame Functional Components (front)

Figure 6 on page 9 shows the functional components of the drive unit frame with four 3590 tape subsystems and a 3590 Model A00 or A50 Control Unit, viewable from the front:

**1 Cartridge storage cells**

Are located on the interior side of the front door and on the back wall of the frame.

**2 Magnetic tape subsystems**

The magnetic tape subsystems that can be installed in a drive frame are the 3490E Magnetic Tape Subsystem Model C1A or C2A (not shown), the 3590 Magnetic Tape Subsystem Model F1A (one or two per frame), or the 3590 High Performance Magnetic Tape Subsystem Model B1A with or without a 3590 Model A00 or A50 Control Unit.

**3 Rail system**

The cartridge accessor is carried through the library on the rail system installed in each frame. The rail system consists of two horizontal rails, one at the top and one at the bottom of the frame.

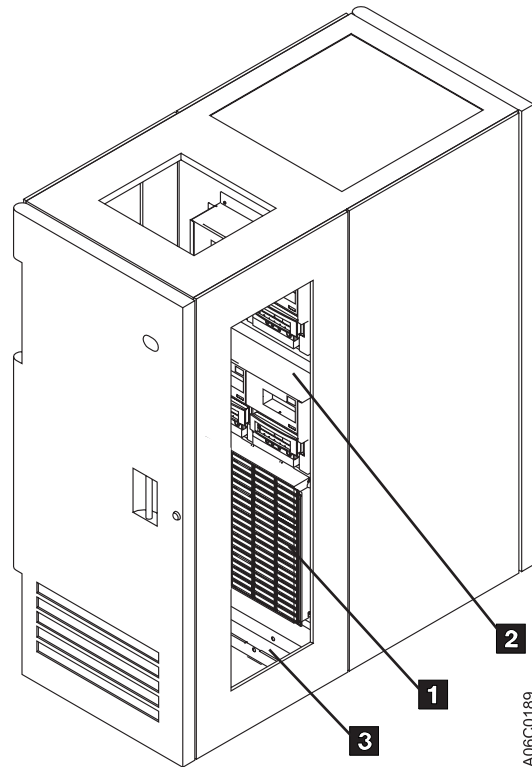

Figure 6. Drive Unit Frame Functional Components (front)

Figure 7 on page 10 shows the functional components of the drive unit frame with four 3590 tape subsystems and a 3590 Model A00 or A50 Control Unit, viewable from the rear (shown with rear door removed):

**1 Cartridge storage cells**

Are located on the interior side of the front door and on the back wall of the frame.

**2 Rail system**

The cartridge accessor is carried through the library on the rail system installed in each frame. The rail system consists of two horizontal rails, one at the top and one at the bottom of the frame.

**3 Power control compartment**

Power to all components in the frame is distributed through the power control compartment.

**4 3590 Model A00 or A50 Control Unit**

The 3590 Model A00 or A50 Control Unit consists of a RISC processor and associated adapter cards.

**5 3590 tape subsystems**

From one to four 3590 magnetic tape subsystems can be installed along with the 3590 Model A00 or A50 Control Unit. From one to six 3590 magnetic tape subsystems can be installed without a Model A00 or A50 Control Unit (not shown).

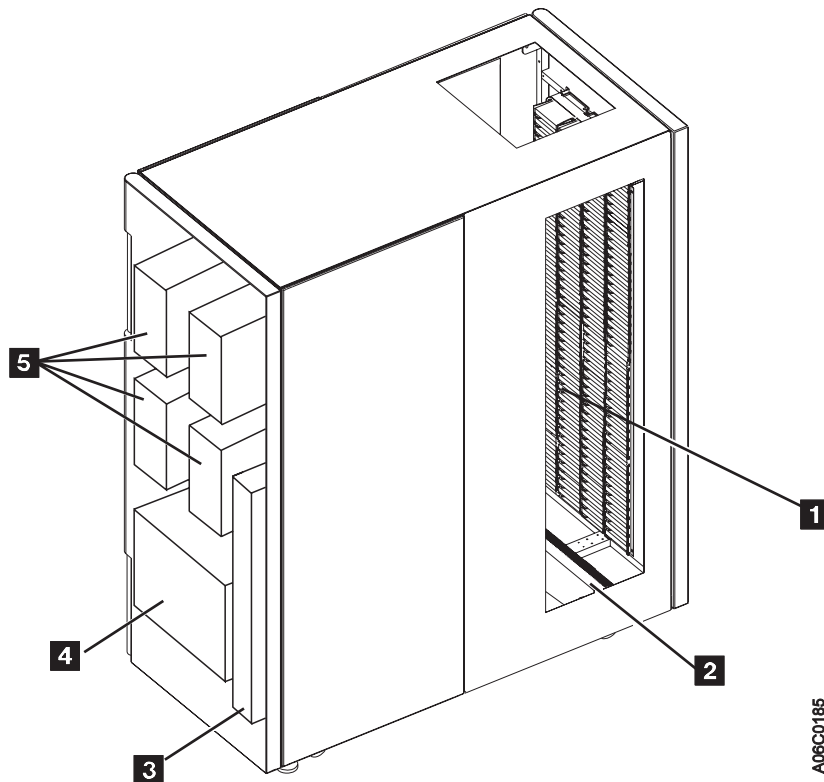

Figure 7. Drive Unit Frame Functional Components (rear)

Figure 8 on page 11 shows the functional components of the Model B16 Virtual Tape Server frame, viewable from the front:

**1 Cartridge storage cells**

Are located on the interior side of the front door and on the back wall of the frame.

**2 Rail system**

The cartridge accessor is carried through the library on the rail system installed in each frame. The rail system consists of two horizontal rails, one at the top and one at the bottom of the frame.



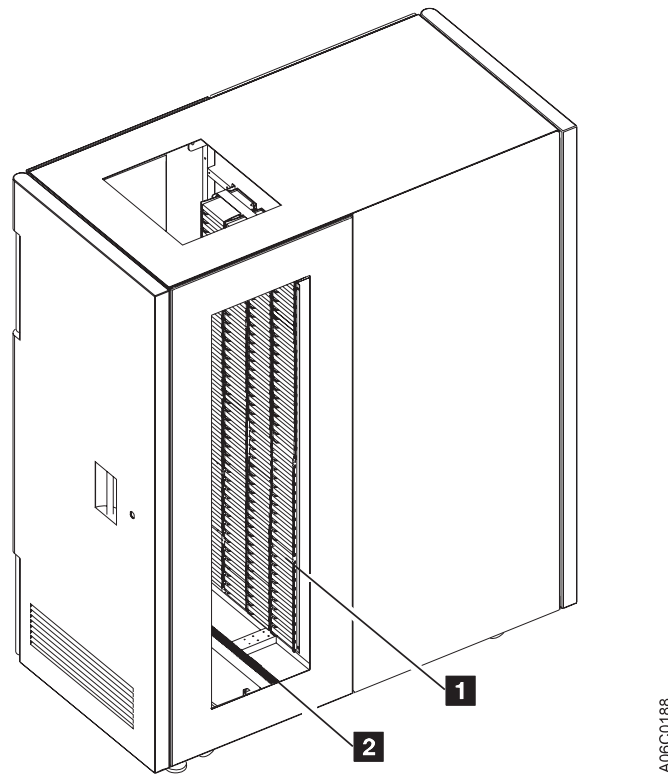

Figure 8. Model B16 Virtual Tape Server Functional Components (front)

Figure 9 on page 12 shows the functional components of the Model B16 Virtual Tape Server frame, viewable from the rear (shown with rear door removed):

**1 Cartridge storage cells**

Are located on the interior side of the front door and on the back wall of the frame.

**2 Rail system**

The cartridge accessor is carried through the library on the rail system installed in each frame. The rail system consists of two horizontal rails, one at the top and one at the bottom of the frame.

**3 Power control compartment**

Power to all components in the frame is distributed through the power control compartment.

**4 Virtual Tape Server controller**

The Virtual Tape Server controller consists of a RISC processor and associated adapter cards.

**5 Disk storage**

Disk storage holds the contents of the Tape Volume Cache and is managed by the Virtual Tape Server controller. Two or four disk storage features are installed in a Virtual Tape Server control unit frame.

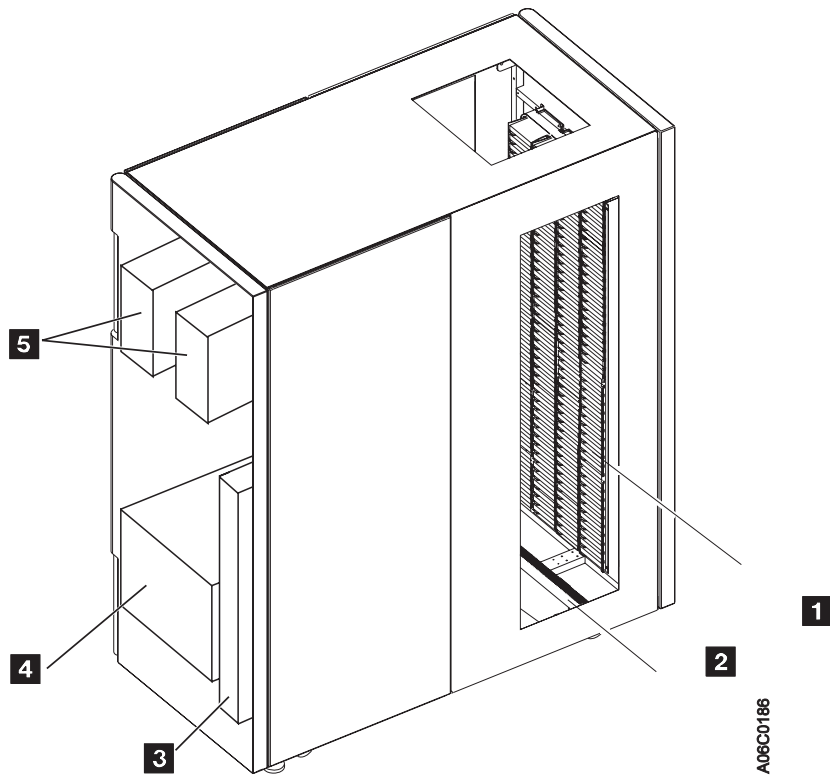

Figure 9. Model B16 Virtual Tape Server Functional Components (rear)

Figure 10 on page 13 shows the Model B18 Virtual Tape Server frame, viewable from the front:

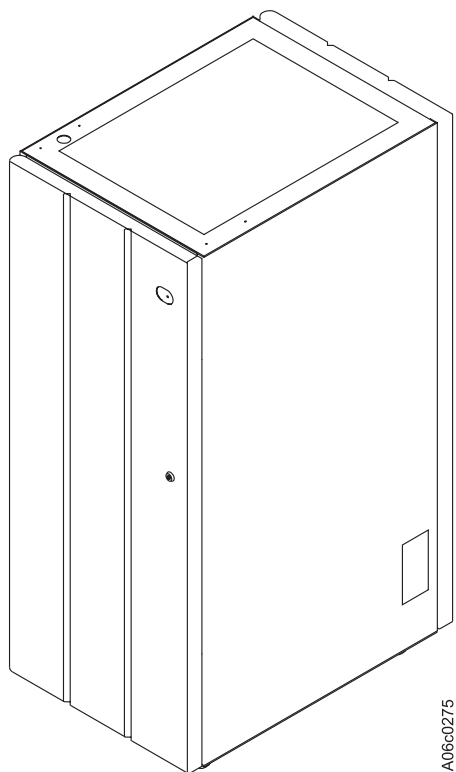

Figure 10. Model B18 Virtual Tape Server (front)

Figure 11 on page 14 shows the functional components of the Model B18 Virtual Tape Server frame, viewable from the rear (shown with rear door removed):

**1 Disk storage**

Disk storage holds the contents of the Tape Volume Cache and is managed by the Virtual Tape Server controller. One to four disk storage features may be installed in a Model B18 VTS.

**2 Virtual Tape Server controller**

The Virtual Tape Server controller consists of a RISC processor and associated adapter cards.

**3 Power control compartment**

Power to all components in the frame is distributed through the power control compartment.

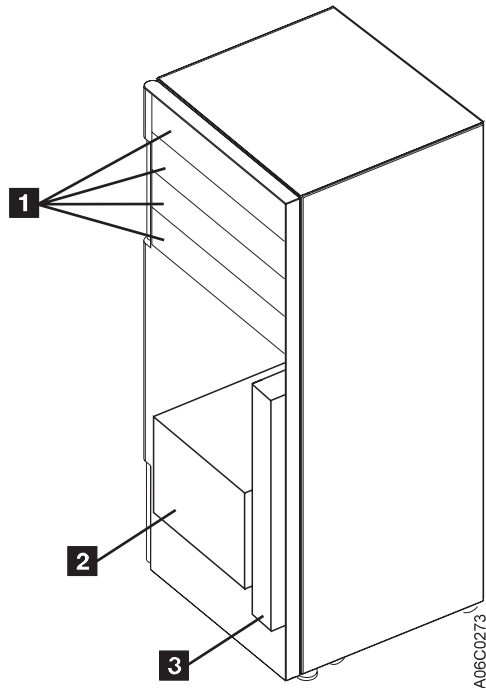

Figure 11. Model B18 Virtual Tape Server Functional Components (rear)

Figure 12 on page 15 shows the following functional components of the Model HA1 Left Service Bay from the right front:

**1 Cartridge storage cells**

Are located on the interior side of the front doors on the 3494 and on the back interior wall but are for service use only.

**2 Barrier door**

Used by service personnel to separate the service bay from the main aisle of the 3494. This allows for concurrent service of the accessor and the associated hardware.

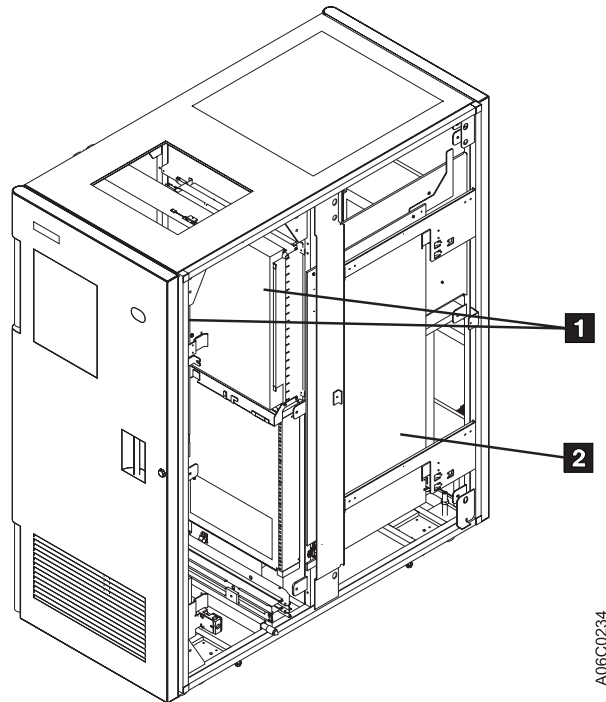

Figure 12. Model HA1, Left Service Bay Functional Components (right front)

Figure 13 on page 16 shows the following functional components of the Model HA1, Right Service Bay from the right front:

**1 Cartridge storage cells**

Are located on the interior side of the front doors on the 3494 and on the back interior wall but are for service use only.

**2 Barrier door**

Used by service personnel to separate the service bay from the main aisle of the 3494. This allows for concurrent service of the accessor and the associated hardware.

**3 Hot standby library manager**

The Hot Standby Library Manager can take control of all operations in the 3494. Its hardware consists of a controller, display, pointing device, and keyboard. An optional Remote Library Manager Console feature is also available for remote installation on a Local Area Network (LAN) environment.

**Hot standby accessor or second active accessor (not visible)**

Moves on horizontal and vertical axes, moving cartridges between the storage cells, devices, and input and output facilities. The vision system (barcode reader) on the cartridge accessor identifies cartridges. This accessor can be controlled by either Library Manager.

**Picker (not visible)**

The part of the cartridge accessor that picks the cartridges. The picker comes standard with one gripper installed or two grippers if the optional Dual Gripper feature is installed.

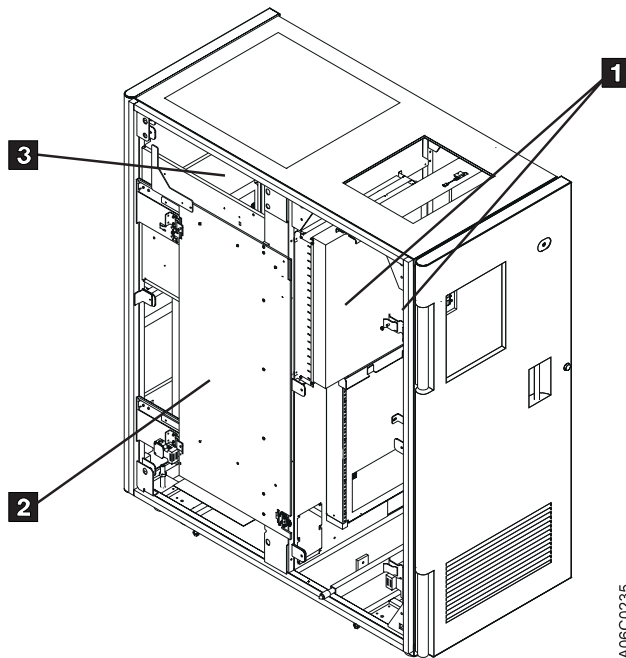

Figure 13. Model HA1, Right Service Bay Functional Components (right front)

## Cartridge Input and Output Facilities

The following four types of input and output facilities are available on the 3494:

- High-capacity output facility
- High-capacity input/output facility
- Single-cell output facility
- Convenience Input/Output Station feature

### High-Capacity Output Facility

The high-capacity output facility, if defined during installation, reserves a section of the cartridge storage area for high-capacity output of cartridges.

#### Library Type

Single Gripper  
Dual Gripper

#### Cartridge Capacity

10, 20, 40, 80, or a full door  
10, 20, 36, 72, or a full door

The cartridge cells are located inside the control unit frame on wall 2, column A, starting with cell 1 (expressed as location 2 A 1) **2** (see Figure 14 on page 17). See “Removing Ejected Cartridges from the High-Capacity Output Facility” on page 82 for operating instructions.

### High-Capacity Input/Output Facility

A High-Capacity Input/Output facility may be defined for the inside wall (drive side walls) so that both inserts (Input) and ejects (Output) can be performed. Storage Unit (SU), B16 or Drive unit (DU) walls, 3 through 31 (odd numbered walls only),

can be configured as High-Capacity Input/Output. An SU, or B16, configured as High-Capacity I/O can contain 100 (upper half) or 200 (whole wall) cells. A DU configured as High-Capacity I/O contains from 50 (six 3590 drives) to 135 (two 3590 drives) and uses all available cells in the wall. Only a single wall can be configured at any time (single High-Capacity input/output facility).

## Single-Cell Output Facility

If a Convenience Input/Output Station is not installed and a high-capacity output facility or high-capacity input/output facility is not defined, a single cell in the door of the control unit frame is provided for output. The location of the single cell **1** as shown in Figure 14 is defined as 2 A 1. If the optional dual gripper feature is installed, the single cell location is 2 A 3. Any empty and unassigned cell can be used for input operations. See “Removing an Ejected Cartridge from the Single-Cell Output Facility” on page 81 for operating instructions.

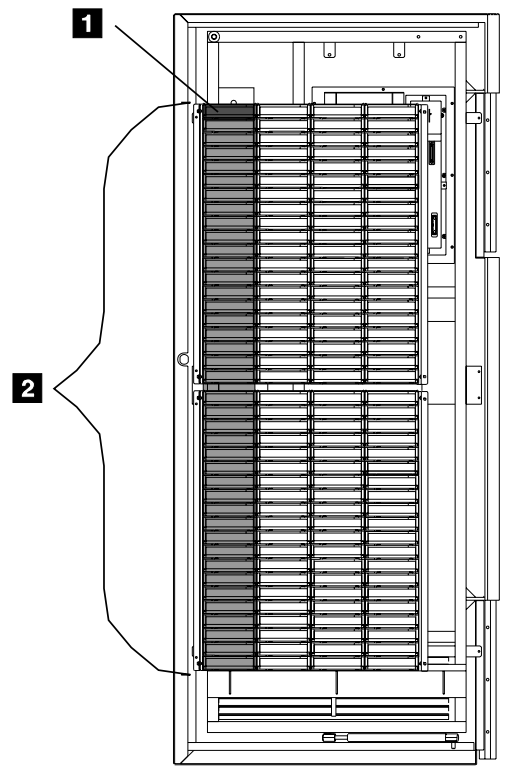

Figure 14. Control Unit Frame Cartridge Storage Cells

## Convenience Input/Output Station Feature

If the Convenience Input/Output Station feature is installed, you can add or remove from ten to 30 cartridges from the library without interrupting the normal operations of the library. See “Using the Convenience Input/Output Station Feature to Insert Cartridges” on page 78 and “Removing Ejected Cartridges from the Convenience Input/Output Station Feature” on page 82 for the operating instructions for this feature.

There are two modes of operation for the Convenience Input/Output Station while in Input mode: **Insert**, and **Import**. If one or more Virtual Tape Servers are Import/Export capable, then the Convenience Input/Output Station will be in **Import** mode.

---

## Cartridge Tape

The 3494 is designed to automate the storage and movement of the Cartridge System Tape, the Enhanced Capacity Cartridge System Tape, and the 3590 High Performance Cartridge Tape.

**Note:** The 3590 High Performance Cartridge Tape can only be used on 3590 High Performance Magnetic Tape Subsystems. The Cartridge System Tape and the Enhanced Capacity Cartridge System Tape can only be used on 3490E Magnetic Tape Subsystems.

The 3494 supports an intermix of the Cartridge System Tape, the Enhanced Capacity Cartridge System Tape, and the High Performance Cartridge Tape depending on the model of tape drive subsystem installed. The Enhanced Capacity Cartridge System Tape is visually distinguished from the Cartridge System Tape by its two-color (gray and white) plastic case. The High Performance Cartridge Tape is visually distinguished from the Enhanced Capacity Cartridge System Tape and the Cartridge System Tape by its black plastic case, blue plastic inserts, and blue leader block.

Figure 15 on page 19 shows the Cartridge System Tape **1**, Enhanced Capacity Cartridge System Tape **2**, and the High Performance Cartridge Tape **3**. Note the blue plastic inserts of the High Performance Cartridge Tape cartridge and the placement of the media-type label (either 1, E, or J).

The vision system identifies the type of cartridge during an inventory or insert operation by reading a separate, media-type label to distinguish between the three types of cartridges. A standard Cartridge System Tape is identified by a media-type label with the character **1**. The Enhanced Capacity Cartridge System Tape is identified with the character **E**. The High Performance Cartridge Tape cartridge is identified with the character **J**. See “Unlabeled Tape Facility” on page 22 for more information.

### Notes:

1. If both 3490 and 3590 drive types are installed in the 3494, all cartridges should have a label in the seventh character position. See Figure 15 on page 19.
2. The media type of the cartridge can be determined in several ways:
  - The most desirable method is for the vision system to read the seventh character on the label.
  - If users have cartridges without the seventh character, they may assign volser ranges (see “Volser Range for Media Types” on page 161) for determining the media type. If the vision system does not successfully read a seventh character, the library manager checks the volser read against the established volser ranges. If the volser is found, the media type that is associated with the range is used.
  - Additionally, a default media type can be set during a teach operation. The default media type is used for the cartridge if the vision system cannot



successfully read a seventh character and there is no volser range that includes this volser. This method is typically used for Cartridge System Tape without the seventh character.

If none of the above methods are successful at assigning a media type, the cartridge is ejected, and an operator intervention is set.

The vision system also identifies the cartridge volser during an inventory or insert operation by reading the external labels on the cartridge. The media-type and volser information is then stored in the database in the library manager.

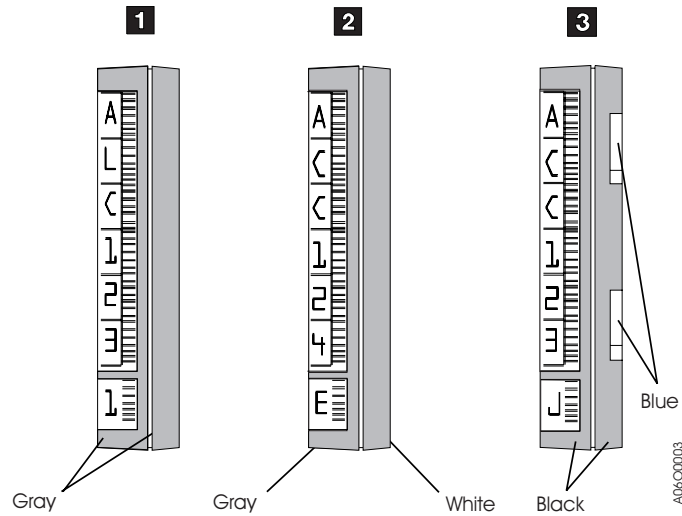

Figure 15. Cartridge System Tape Identification

## Tape Cartridge Requirements

Figure 16 on page 20 shows the cartridge system tape requirements:

- The tape cartridge **1** should have an external label **2** applied.
- The file-protect selector **3** must be set to the correct position for the volume's intended purpose (see "Cartridge File Protection" on page 20).
- The leader block **4** on the tape cartridge must be seated before inserting the cartridge into the library.
- The tape cartridge is inserted into the library cartridge storage cells in the direction **5** shown so that the external label is readable when stored.

**Note:** When inserting the tape cartridges into the Convenience Input/Output Station feature, insert the external label side first in the direction **6**.

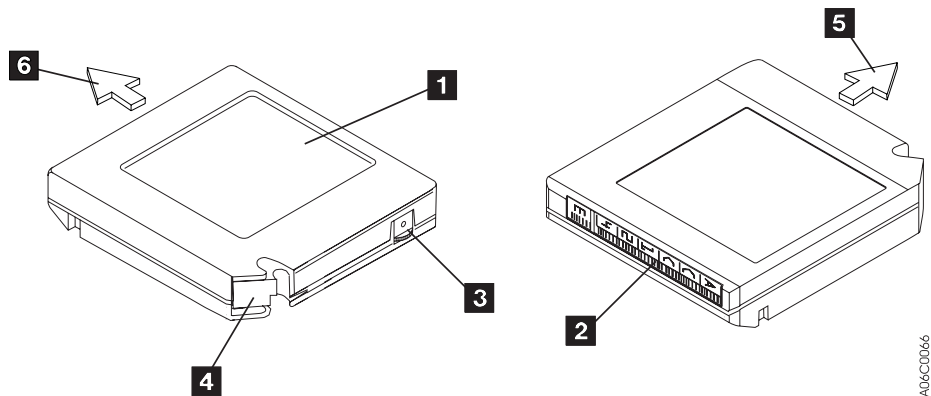

Figure 16. Cartridge System Tape

## Cartridge File Protection

Each tape cartridge includes a file-protect selector **3** (see Figure 16) that, when set to the file-protect position, prevents writing on or erasing data from the tape.

Normally, cartridges used in the 3494 should not be manually file-protected. If required, software can be used to file-protect the cartridges. This allows the host, when appropriate, to identify a cartridge that no longer contains current data and can be a scratch cartridge. Do not file-protect scratch cartridges because new data cannot be written to file-protected cartridges. For additional information, refer to *Care and Handling of the IBM Magnetic Tape Cartridge*

## Cartridge System Tape Labels

Each tape cartridge in the 3494 must have external labels that are operator- and machine-readable. The labels identify the volume serial number (volser) and type of cartridge. Currently supported labels are Tri-Code, available from Wright Line Corporation, Tri-Optic, available from Engineered Data Products, and labels from Information Data Storage.

**Note:** The **only exception** for the label requirement is when using the Unlabeled Tape Operations function. See “Unlabeled Tape Facility” on page 22 for more information.

The volser label contains up to six characters, and the separate media-type label provides a seventh character for media-type identification. A volser can contain one to six characters, with blanks padded on the right for a volser with fewer than six characters. Characters can be uppercase A–Z and numerics 0–9. Each tape cartridge typically has a separate single-character media-type label that identifies the cartridge type. The media-type label character for a Cartridge System Tape is **1**, for an Enhanced Capacity Cartridge System Tape is **E**, and for High Performance Cartridge Tape is **J**.

**Note:** See “Cartridge Tape” on page 18 for the process used to determine the cartridge media type.

The external labels on the cartridges identify the cartridges to the 3494. Host control software in some operating environments requires that internally written labels on volumes correspond to external volsers. IBM recommends that correspondence of external and internal cartridge labels be verified by library control software as part of mount processing. Cleaner cartridges must also have operator and machine-readable external labels to identify each cartridge.

High Performance Cartridge Tapes (HPCT) managed by the VTS are automatically checked for the correct internal volume label and re-labeled if necessary.

Figure 17 shows the possible labeling configurations of the tape cartridges and Table 1 shows how the library handles the different types of labeling configurations.

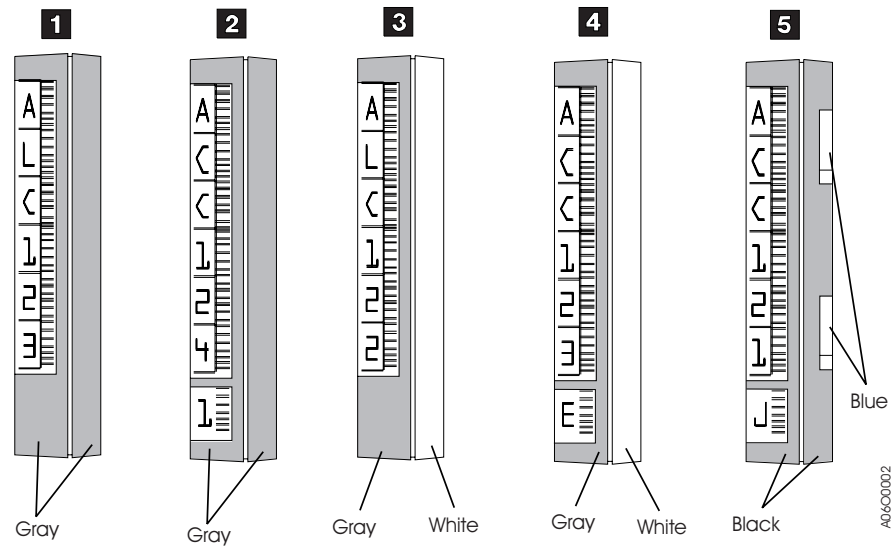

Figure 17. Cartridge System Tape Labels

Table 1. Cartridge Tape Labeling (Media type default set to Cartridge System Tape)

Cartridge Type	Color	Media-Type Label	Handled as:
<b>1</b> Cartridge System Tape	Gray	Not present	Cartridge System Tape(default, see note)
<b>2</b> Cartridge System Tape	Gray	Present (1)	Cartridge System Tape
<b>3</b> Enhanced Capacity Cartridge System Tape	Gray and white	Not present	Cartridge System Tape(default, see note)
<b>4</b> Enhanced Capacity Cartridge System Tape	Gray and white	Present (E)	Enhanced Capacity Cartridge System Tape
<b>5</b> High Performance Cartridge Tape	Black with blue leader block and identification notches	Present (J)	High Performance Cartridge Tape
<b>Note:</b> The default could be Enhanced Capacity Cartridge System Tape or High Performance Cartridge Tape instead of Cartridge System Tape; refer to "Operational Status" on page 111.			

## Unlabeled Tape Facility

**Note:** Do not use this function with cartridges with machine-readable labels.

Unlabeled tape operations are designed to allow the operator to occasionally insert volumes into the 3494 that do not have external machine-readable volser and media-type labels. Once inserted through the unlabeled tape facility, the volumes may be used in the same manner that regular, properly labeled volumes are used, with the exception of any operations that require the external machine-readable label to be read.

It is not recommended that volumes to be managed by the VTS be inserted using this facility. However, in the event the external label on a stacked volume becomes damaged, this facility can be used to re-insert the volume until its external label can be replaced.

To use the unlabeled tape facility, the operator selects the Insert Unlabeled Cartridges command from the Commands pull-down on the library manager. The operator then provides the volser and media-type information requested. The unlabeled tapes are then placed into the Convenience Input/Output Station. The library will then move the cartridges from the Convenience Input/Output Station to their designated cells. The library manager database is updated to indicate the location of the cartridges using the volser and media-type information provided. All hosts are notified that the cartridges have been added to the insert category just as regular, properly labeled volumes are handled.

Inventory update operations only verifies that all unlabeled cartridges are in cells that previously contained unlabeled cartridges.

**Note:** This facility should not be used for a large number of cartridges or for cartridges that are stored in the library for a long time. Refer to "Insert Unlabeled Cartridges" on page 184 for additional information.

## Cartridge Labeling

To apply an external volser cartridge label, do the following:

1. Examine the label before you apply it to the cartridge. Do not use the label if it has voids or smears in the printed characters or bar codes.
2. Remove the label from the label sheet carefully so you do not stretch the label or cause the edges to curl.
3. Line up either end of the label with the lip of the label indentation. Be sure to position the bar-code side of the label toward the inside edge of the indentation. Do not allow the label to roll up or over this lip; the label must be flat within the cartridge indentation surface. Apply the label either from the top or from the bottom. Carefully position the label within the indentation on the end of the cartridge away from the leader block. The machine-readable bar code must face to the right.
4. Apply the label parallel to the long edge of the indentation. Do not pull the label excessively because it will stretch.
5. Smooth out the label so that no wrinkles or bubbles exist on the label. Use light finger pressure to smooth the label and secure it to the cartridge.
6. Verify that the label is smooth and parallel and has no roll-up or roll-over.

The label must be flat to within 0.5 mm (0.2 in.) over the length of the label and have no folds, missing pieces, or smudges. Figure 18 shows the correct position of the label on the cartridge case.

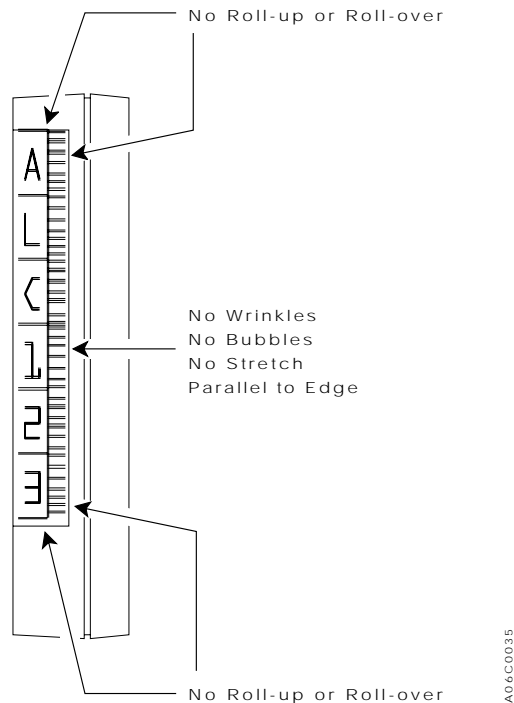

Figure 18. Cartridge Label Position

Do not place a new label over an existing label. Remove an old label by slowly pulling it at a right angle to the cartridge case. Do not reuse a label.

No other labels can be placed on the same surface as the external volser cartridge label. Labels on other surfaces of the cartridge must not interfere with the cartridge accessor's gripper or the tape drives, and should **not** be machine readable as that may interfere with the ability of the vision system to read the volser and the media-type label.

## Media-Type Labeling

Media-type labels are applied in two different ways as follows:

- If the cartridge has no separate area below the volser label (for example, an indented area), place the media-type label in line and just below the volser label.
- If the cartridge has a separate area (for example, an indented area) approximately 2 mm (0.08 in.) below the &vol label, place the media-type label in the separate area.

The label must be flat to within 0.5 mm (0.2 in.) over the length of the label and have no folds, missing pieces, or smudges. The label must not be rotated more than 3° from being parallel with the edges of the cartridge.

---

## Cartridge Storage Cells

The cartridge cell locations are named so the operator can find the cartridges during Manual mode operation. The cell name consists of three values: a wall number, a column letter, and a row number. For example, Figure 19 shows cell location 2 A 1.

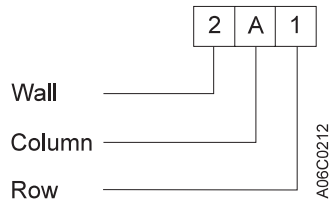

Figure 19. Cartridge Storage Cell Names

Figure 20 on page 25 shows the cartridge storage cell labeling.

### Wall number

The wall numbers **3** that are even-numbered represent the walls on the front doors of the library. The wall numbers that are odd-numbered represent the walls on the rear of the library.

### Column letters

The column letters **1** range from A to E and are labeled from left to right.

**Note:** The control unit frame has only four columns; therefore, the letter range is from A to D.

### Row numbers

The row numbers **2** range from 1 to 20 or from 1 to 40, depending on the frame and the wall. The numbers start with 1 at the top of the frame and end at 40 for the lowest row.

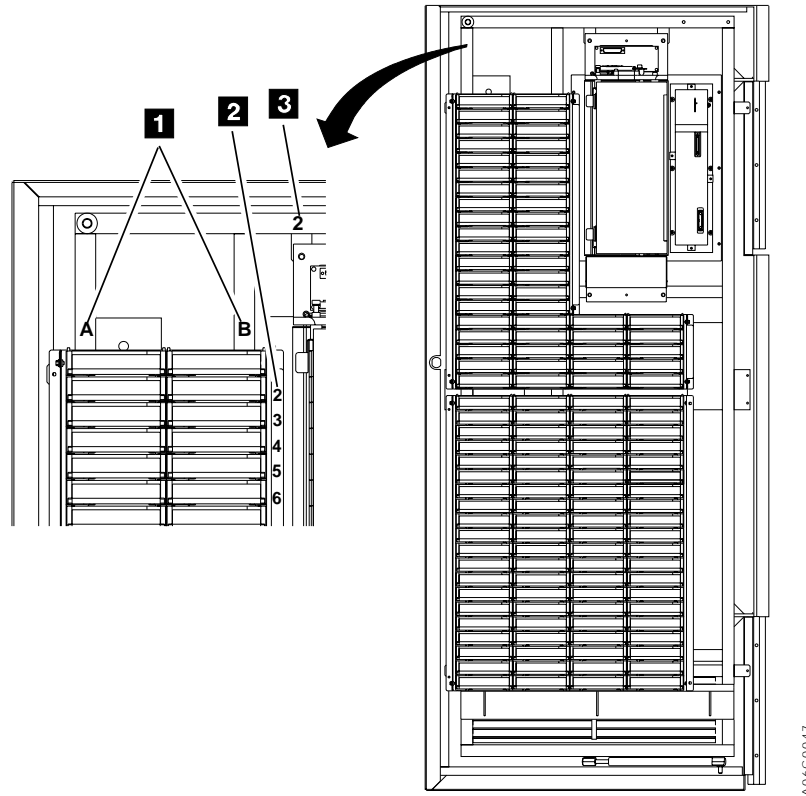

Figure 20. Cartridge Storage Cell Labeling

## Reserved Cartridge Storage Cells

The library reserves certain cells within the library for functions that the operator does not actively control.

In non-high availability models these locations are Error Recovery Cells 1 A 1 (1 A 3 instead of 1 A 1 if the optional Dual Gripper feature is installed) and CE cartridge cell 1 A 20. If both 3490E and 3590 tape subsystems are present, CE cartridge 1 A 19 is also reserved. These are used for error recovery cell and for service cartridges. In high availability models, these locations are Error Recovery Cell 1 A 1 and 1 A 2 or 1 A 3 and 1 A 4 if the Dual Gripper Feature is installed. CE cartridge cells are in the service bays.

## Cartridge Storage Capacity

Table 2 shows the cartridge capacity of each frame.

Table 2. Magstar 3494 Cartridge Capacity

Model or Frame	Without Dual Gripper	With Dual Gripper
Model L10, L12, or L14	240 (see notes 1, 4, 5, and 6)	216 (see notes 2, 4, 5, and 6)
Model S10, FC 5400	400	360

Table 2. Magstar 3494 Cartridge Capacity (continued)

<b>Model or Frame</b>	<b>Without Dual Gripper</b>	<b>With Dual Gripper</b>
Model D10 (without 3490 Model CxA/F1A)	400	360
Model D10, FC 5300 (with 3490 Model CxA/F1A)	300	270
Model D12, FC 5500	400	360
Model D12, FC 5302 (with one or two 3590 Models B1A)	335	305
Model D12, FC 5302, FC 5502 (with three or four 3590 Models B1A)	290	260
Model D12, FC 5302 (with RPQs), FC 5502 (with RPQ) (with five or six 3590 Models B1A)	250	230
Model D14 (without 3590 Model B1A)	400	360
Model D14, FC 5304 (with one or two 3590 Models B1A)	345	305
Model D14, FC 5304 (with RPQ) (with three or four 3590 Models B1A)	305	275
Model B16, or FC 5500	400	360
Model B18	0	0
Model HA1 (service bays)	0	0
<b>Notes:</b>		
<ol style="list-style-type: none"> <li>1. The optional Convenience Input/Output Station feature reduces the cartridge capacity by 30 cartridges (FC 5210) or 80 cartridges (FC 5230).</li> <li>2. With dual grippers installed, the optional Convenience Input/Output Station feature reduces the cartridge capacity by 26 cartridges (FC 5210) or 72 cartridges (FC 5230).</li> <li>3. Selecting the high-capacity input/output station facility reduces the cartridge capacity, depending on the options chosen (see "High-Capacity Input/Output Facility" on page 16).</li> <li>4. One cell is reserved for ejecting cartridges if the optional Convenience Input/Output Station feature is not installed and the high-capacity output facility is not defined.</li> <li>5. A maximum of two cells are reserved for certain service representative functions. When the high availability unit is installed, there are no cells reserved in the L1x unit for service functions.</li> <li>6. One cell is reserved for error-recovery operations for configurations without the high availability unit and two cells are reserved for error-recovery operations for configurations with the high availability unit.</li> </ol>		



---

## Library Manager

The library manager processes all requests and control functions in the library.

## User Interface

The user interface enables the operator to obtain information about the operation of the library and instructs the library manager to perform specific tasks through the use of the library manager console (display, keyboard, and pointing device). Password-protection for the level of authorization is optional. The user interface recognizes the following three authorization levels:

### General operator

A general operator performs the day-to-day basic interactions with the library. This is generally limited to inquiries about the library status or to perform cartridge insert and eject operations. A general operator has a limited level of authorization.

### System administrator

A system administrator is an operator with additional training on the management of not only the library but of the data also. The system administrator typically handles the initial installation of volumes into the library and the problem resolution with volumes during operation. The system administrator has authorization access to all functions of the library, except for those uniquely related to the service and repair of the library.

### Service representative

The service representative has full authorization access to all functions of the library.

## Password-Protection

The following functions of the library manager can be protected by a password if the customer chooses to use password-protection:

- Service menu
- Inventory new storage
- Re-inventory complete system
- Emergency power off (EPO) recovery
- Shutdown
- Keyboard and display lockup
- System administrator to unlock
- Unlock keyboard and display
- Service Access
- Cancel VTS Export/Import

Each time a user enters a part of the application where a password is required, then enters a password, a log entry is made at the library manager. Exiting a protected menu also creates a log entry. See "System Administrator Password" on page 200 for more information.

## Database

The library manager creates and maintains a database that contains the configuration of the library, the physical location information for all the elements of the library serviced by the cartridge accessor, the inventory of the physical cartridge volumes and logical volumes managed by a VTS, and information about their use and current status, and the status of each 3490E/3590 device and virtual device. As operations progress through the library, the database is dynamically updated on the disk drive to reflect the current status of the library.

## High Availability (Model HA1)

If the high availability model is installed, a second library manager is provided in the right-hand service bay. Each library manager contains two hard (disk) drives, a primary and secondary disk. Under normal operation, one library manager is the active library manager and the other library manager is the standby library manager. The active library manager, on its primary disk, creates and maintains the database, which is dynamically updated to reflect the current status of each library. The standby library primary disk contains a back-up of the database, which is also dynamically updated to reflect the current status of the library.

If the active library manager fails, the standby library manager automatically becomes the active library manager and takes control of operations. A new backup database is then created on the active library manager's secondary disk drive. The new active library manager runs in degraded mode until the failing library manager is repaired. This allows continued operation of the 3494.

## Database Information Available to a Host

The library manager maintains information in its database that may be requested through a host. The form of the particular host request is dependent on the host environment. The following information is available through the host:

### **Category inventory data**

Records for 100 volumes in the library for the category specified, starting after the sequence number specified by the request. If fewer than 100 volumes are in the category, all of the remaining records are returned. Each record contains the current status and media-type for a volume in the inventory.

### **Device data**

Information about any particular device within the library. This information includes the device states, volser, and category of the mounted cartridge.

### **Expanded volume data**

More detailed information about the current status and media-type for a specific volume than the volume data information request. It does not provide physical location information for the volume.

### **Inventory volume count**

The number of volumes in the library for either the entire inventory or a specified category.

### **Inventory data**

Records for 100 volumes in the library, starting after the volume specified by the request. If fewer than 100 volumes remain in the library, all of the

remaining records are returned. Each record contains the current status and media-type for a volume in the inventory.

**Library information data**

The current operational status of the library and basic library configuration data with information on installed options.

**Reserved category data**

Information about the categories that have already been reserved within the library.

**Statistical data**

Information about the current workload and performance characteristics of the library.

**Volume data**

Information about the current status and media-type of specified volume.

**Category attribute data**

Information about the category attributes, for example, name.

---

## Operational Modes and States

The 3494 operates in one of the following modes:

- Auto
- Pause
- Manual

The operational states of the 3494 are as follows:

- Online
- Offline

For a detailed description of these operations, see “Chapter 4. Operational Modes and States, and Informational States” on page 63.



## Chapter 2. Controls and Indicators

The controls and the indicators for the 3494 are described in this chapter.

The 3494 is controlled through the use of the operator panel **1** (see Figure 21) on the front of the control unit frame. The Convenience Input/Output Station feature **2** is also on the front of the control unit frame next to the operator panel, if it is installed. The handles **3** for opening the doors on the front of the frames are located next to the door locks **4**. The library manager is in the rear of the control unit frame. The tape subsystem controls are on the front of the drives inside the control unit frame and drive unit frame.

**Note:** Two keys are supplied with the 3494. One key is used by the operators and service personnel to open the front doors on the library. The other key is for use by service personnel to open the doors on the back of the library.

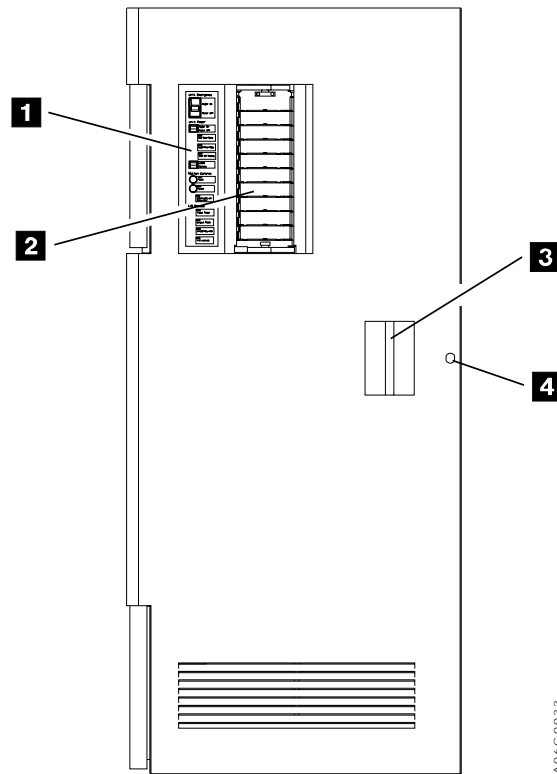

Figure 21. Control Unit Frame Front Door

---

## Operator Panel

The 3494 operator panel is mounted on the front door of the control unit frame. Normal operation of the 3494 is controlled through the use of this operator panel.

## Power Controls and Status Indicators

See Figure 22 on page 33 for the locations of the controls and indicators.

### 1 Unit Emergency switch

The Unit Emergency switch turns off power to the 3494 immediately and should only be used in an emergency. The Unit Emergency switch must be in the on position for the 3494 to be powered on.

**Note:** If the 3494 Library has more than eight frames, or has the optional High Availability Model Service Bays, a second unit emergency switch is located at the right end of the Library. Either switch can be used to immediately turn off power.

**Note:** The 3494 Library Unit Emergency switches do not turn off power to the attached stand-alone Model B18 Virtual Tape Server.

### 2 Unit Power switch

The Unit Power switch turns power on and off to the components inside the 3494. The Unit Power switch is used to power on and off the 3494 under normal conditions. Using the Unit Power switch to turn off power to the 3494 allows the library manager, Virtual Tape Servers, tape control units, and tape drives to shut down in an orderly manner.

### 3 Rack Power Ready LED

The Rack Power Ready light-emitting diode (LED), when lit, indicates the AC power is on in the 3494 control unit.

### 4 System Power Ready LED

The System Power Ready LED, when lit, indicates the AC power is on to the control units and drive units inside the 3494.

### 5 Power Off Pending LED

The Power Off Pending LED, when flashing, indicates the power to the 3494 is being turned off.

### 6 Local Remote power switch

The Local Remote power switch allows the library's power to be controlled by the switches on the operator panel (local) or through an AS/400 host (remote) if the Local Remote Power Feature is installed. The Local Remote switch must be in the local position if the remote power feature is not installed.

**Attention:** Pressing the Local Remote switch to the remote position, if the Local Remote Power feature is not installed, causes the 3494 to power off.

## Motion Controls and Status Indicators

See Figure 22 on page 33 for the locations of the controls and indicators.

### 7 Auto mode switch and status LED

The Auto mode motion control switch allows the operator to place the library into Auto mode. The LED flashes during the mode transition and

remains lit when in Auto mode. If the mode transition cannot be completed, the Intervention Required LED will light.

### 8 Pause mode switch and status LED

The Pause mode motion control switch allows the operator to place the library into Pause mode. The LED flashes during the mode transition and remains lit when in Pause mode. If the mode transition cannot be completed, the Intervention Required LED will light.

### 9 Intervention Required LED

The Intervention Required LED, when lit, indicates operator interventions are required. See “Operator Intervention” on page 199 for instructions to perform operator interventions.

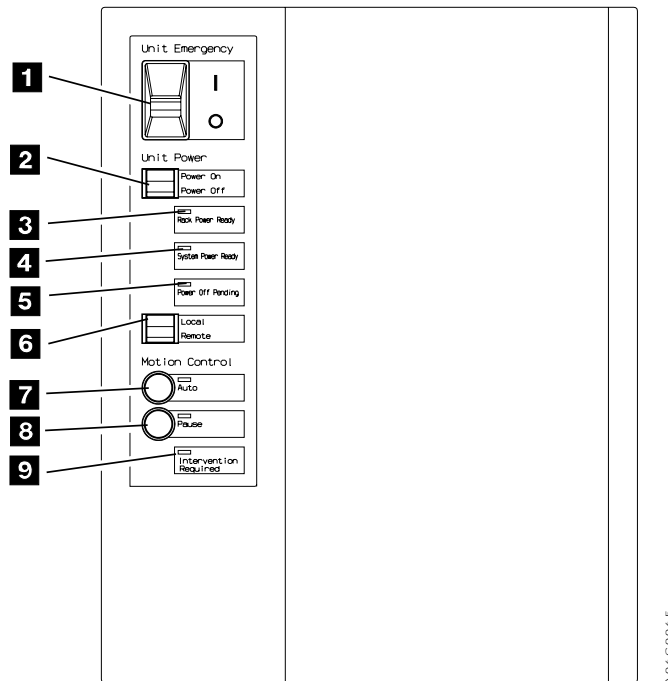

Figure 22. Operator Panel without Convenience Input/Output Station Feature

## Convenience Input/Output Station Status Indicators

If the Convenience Input/Output Station feature is installed on the 3494, four additional status lights are present on the operator panel. See Figure 23 on page 34 for the locations of the controls and the indicators.

### 1 Input Mode

The Input Mode LED, when lit, indicates that cartridges are in the Convenience Input/Output Station and the station is in Input mode.

### 2 Output Mode

The Output Mode LED, when lit, indicates that cartridges are being ejected from the library into the Convenience Input/Output Station.

### 3 Unload Required

The Unload Required LED, when lit, indicates that the Convenience Input/Output Station has ejected cartridges that need to be removed.

#### 4 Input/Output Locked

The I/O Locked LED, when lit, indicates that the Convenience Input/Output Station is locked and being used by the cartridge accessor.

#### 5 Convenience Input/Output Station Operation Tab

The Convenience Input/Output Station operation tab is used to open the Convenience Input/Output Station door when the door is unlocked (when the I/O Locked LED is not lit).

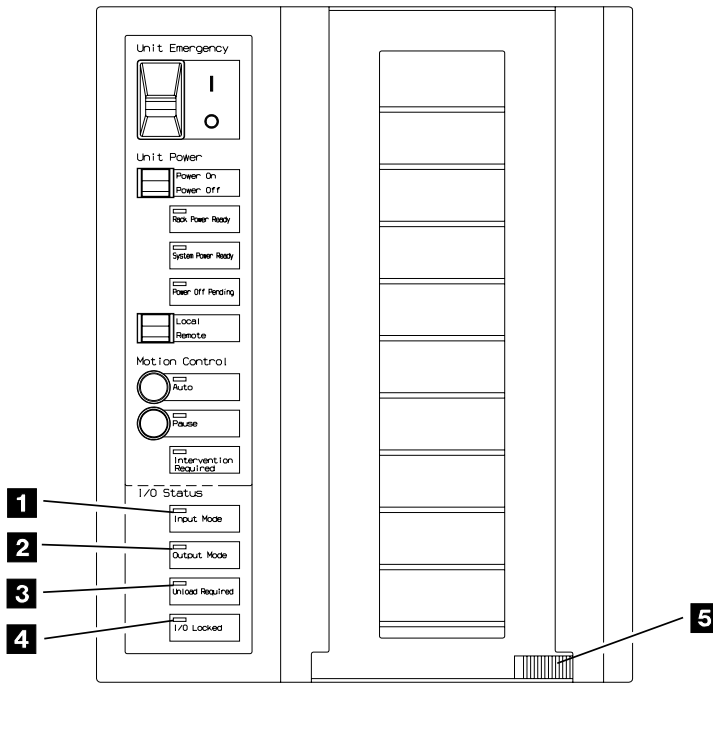

Figure 23. Operator Panel with Convenience Input/Output Station Feature

## Library Manager

The library manager display **1** (see Figure 24 on page 35) and keyboard (with pointing device) **2** are located in the rear of the control unit frame. The library manager is used to perform system administrator activities and advanced operator activities. The brightness and contrast controls for the library manager display are located on the back of the display. An optional Remote Library Manager Console feature is also available for installing in a remote location on a LAN environment.

The library manager display is shut off by the operating system software when there has been no activity by the operator. This “snooze” function is provided to conserve power and increase the reliability of the display hardware. If the library is powered on and the display is off, the operator can press any key on the keyboard to activate the display.

See “Selections with the Pointing Device” on page 92 for a detailed description on using the pointing device. The optional High Availability Model, Service Bay B, is similar in looks and function.



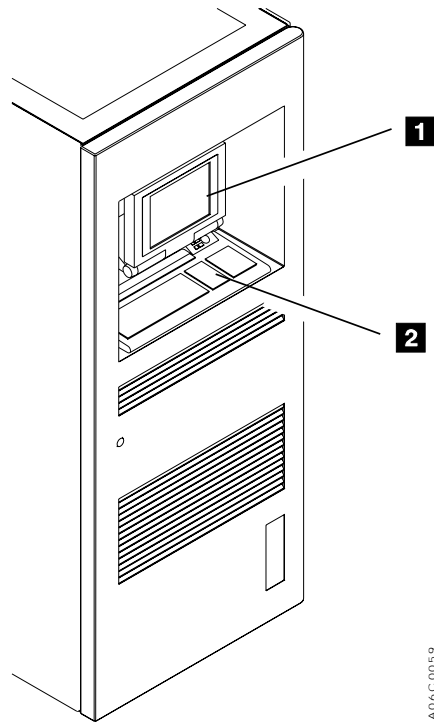

Figure 24. Library Manager

## 3490 Tape Subsystem Controls for Models C10, C11, C1A, C22, and C2A

The 3490E Model CXA control unit operator panel **1** and the 3490E Model CXA drive unit operator panel **2** (see Figure 25 on page 36) are accessible to the operator by opening the front door of the frame containing the tape subsystem to be accessed.

When 3490E subsystems are attached to the 3494, the following 3490E functions change:

### Drive control

The loading and the unloading of volumes are controlled by the library manager. The 3490E subsystem communicates with the library manager to update the database with the drive status and the cartridge location information.

### Message displays

The library manager controls which messages are displayed to prevent the messages from getting out of synchronization with the library manager during Manual mode operations.

### Attention interrupt

The library manager can use the communication path to the 3490E subsystems to send information to the host.

For more information on 3490E controls and indicators, see *IBM 3490 Magnetic Tape Subsystem Enhanced Capability Models C10, C11, C1A, C22, and C2A*

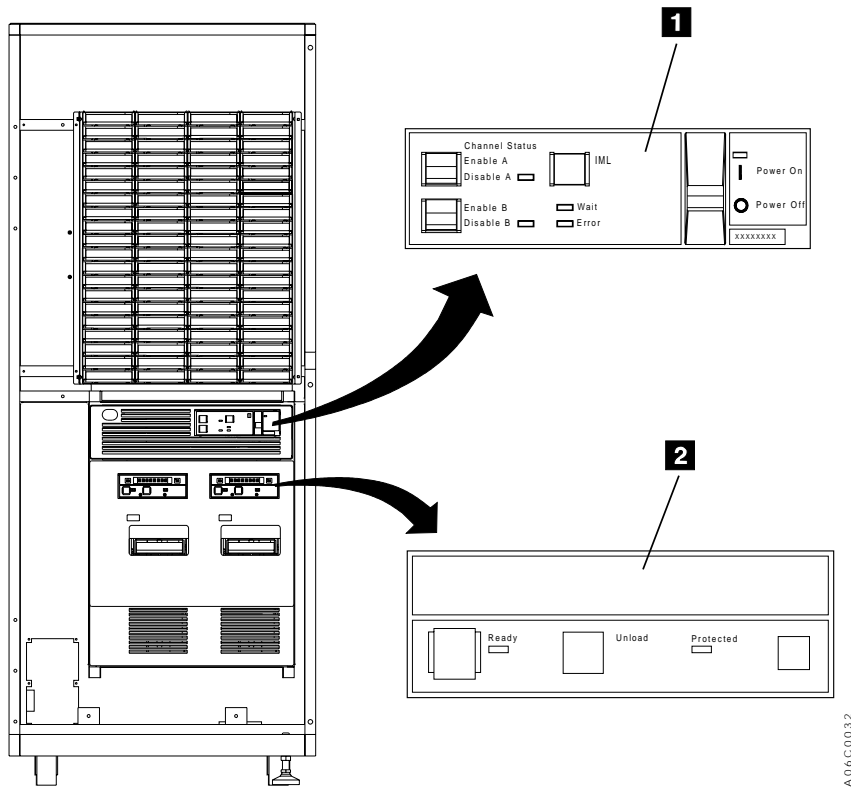

Figure 25. 3490E Controls and Indicators

## 3490 Tape Subsystem Controls for Model F1A

The 3490E Model F1A drive unit operator panel **1** is accessible to the operator by opening the front of the frame containing the tape subsystem to be accessed.

When 3490E subsystems are attached to the 3494, the following 3490E functions change:

### Drive control

The loading and the unloading of volumes are controlled by the library manager. The 3490E subsystem communicates with the library manager to update the database with the drive status and the cartridge location information.

### Message displays

The library manager controls which messages are displayed to prevent the messages from getting out of synchronization with the library manager during Manual mode operations.

### Attention interrupt

The library manager can use the communication path to the 3490E subsystems to send information to the host.

For more information on 3490E controls and indicators, see *IBM 3490E Tape Subsystem Models F00, F01, F1A, and F11 Installation, Planning, and Operator's Guide*.

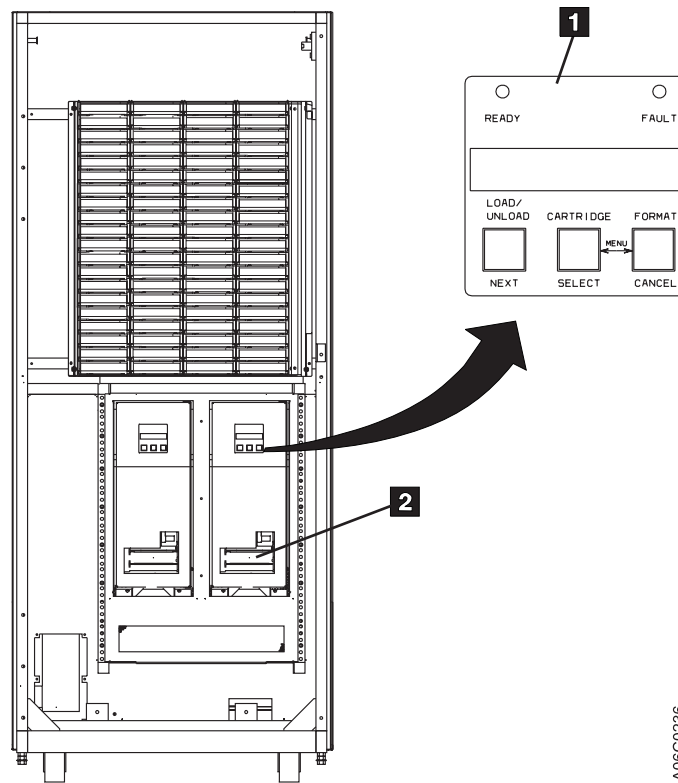

Figure 26. 3490E Controls and Indicators for Model F1A

## 3590 Model B1A Tape Subsystem Controls

The 3590 Model B1A operator panel **1** (see Figure 27 on page 38) is accessible to the operator by opening the front door of the frame containing the tape subsystem to be accessed.

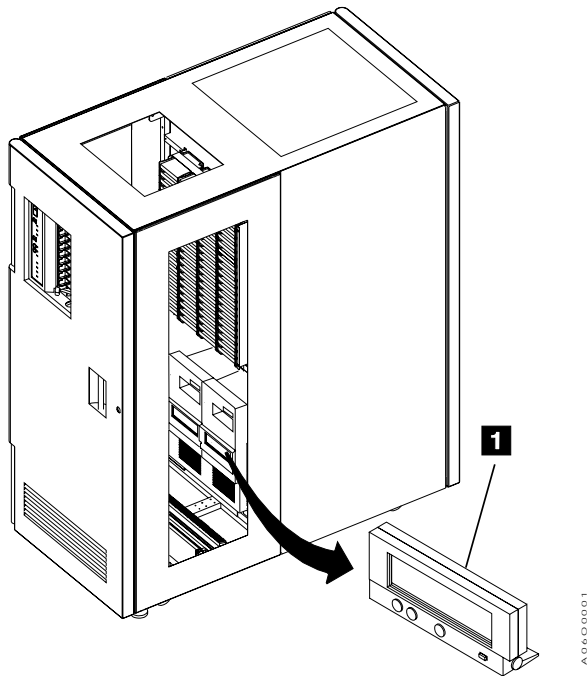

Figure 27. 3590 Model B1A Operator Panel

When 3590 subsystems are attached to the 3494, the following 3590 functions change:

**Drive control**

The loading and unloading of volumes is controlled by the library manager. The 3590 subsystem communicates with the library manager to update the database with the drive status and cartridge location information.

**Message displays**

The library manager controls which messages are displayed to prevent the messages from getting out of synchronization with the library manager during Manual mode operations.

**Attention interrupt**

The library manager can use the communication path to the 3590 Model A00 subsystem to send information to the host.

For more information on 3590 controls and indicators, see *IBM 3590 High Performance Tape Subsystem User's Guide* , GA32-0330.

## 3494 Model B18 Operator Panel

The 3494 Model B18 Virtual Tape Server operator panel is mounted on the rear door of the unit frame.

### Power Controls

Figure 28 on page 39 shows the location of the power control on the Model B18 VTS.

**1 Unit Emergency switch**

The Unit Emergency switch turns off power to the 3494 Model B18

immediately and should only be used in an emergency. Abrupt removal of power in case of emergency may cause loss of customer data. The Unit Emergency switch must be in the on position for the 3494 Model B18 to be powered on by the associated 3494 Library.

**Note:** The 3494 Model B18 Unit Emergency switch will not cause power to be removed from the associated 3494 library.

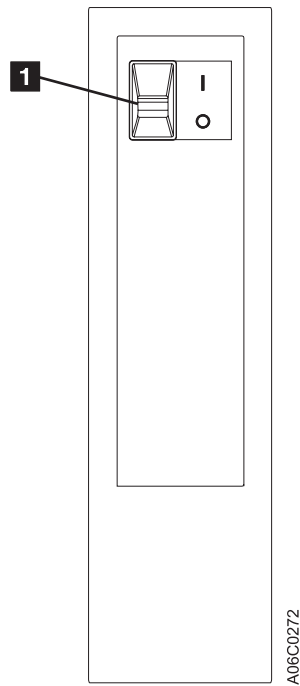

Figure 28. Model B18 Virtual Tape Server Operator Panel

---

## 3494 Model B16 Virtual Tape Server Controls

All control functions for the Model B16 Virtual Tape Server are integrated into the library manager. See “Chapter 6. Advanced Operating Procedures” on page 85.

---

## 3494 Model B18 Virtual Tape Server Controls

All control functions for the Model B18 Virtual Tape Server, other than emergency power control, are integrated into the library manager. For more information, see “Chapter 6. Advanced Operating Procedures” on page 85. Refer to “3494 Model B18 Operator Panel” on page 38 for the Unit Emergency Switch Function.



---

## Chapter 3. Operational Characteristics

The operational characteristics of the 3494 are described in this chapter.

---

### 3490E/3590 Tape Subsystem Operation

The 3494 controls the loading, unloading, and affiliated operation of the tape subsystem in the library. No operator attendance is required unless the library is unable to recover from a subsystem problem.

In addition to existing tape subsystem error recovery, the control unit and the library manager execute additional recovery procedures when the tape drive detects a load, unload, or tension loss failure.

---

### Virtual Tape Server

The IBM Magstar 3494 Model B16 or B18 Virtual Tape Server provides for a higher utilization of 3590 tape technology than enabled by current tape controller concepts. A Virtual Tape Server provides the improvement in utilization without impacting current operating system or independent software vendors. The subsystem combines the random access and high performance characteristics of disk storage with outboard hierarchical storage management and virtual tape drives to provide significant reductions in the number of physical cartridges, tape drives, and automated libraries needed to store the customer tape data. The key concepts for the architecture of the subsystem are:

- Emulation of 32 or 64 3490-type tape drives
- Tape volume cache
- Storage management of the tape volume cache
- Maintaining data fragments from copied volumes
- Fast response for non-specific mount requests

### Emulation of 3490-Type Tape Drives

From a host perspective, the Virtual Tape Server subsystem looks like two or four 3490E control units, each with 16 tape drives. Each emulated drive is called a virtual tape drive. The subsystem handles all 3490 tape commands. Emulating a 3490-type tape drive eliminates the need for host software support of a new type of tape drive in order to utilize the capacity of 3590-type tape drives. There is no direct relationship between a virtual tape drive and a real 3590 tape drive.

Data is written and read as if it is stored on a real Cartridge System Tape or an Enhanced Capacity Cartridge System Tape. However, within the subsystem, data is stored on disks. All tape read and write commands are translated to read and write data records from or to disk storage. Tape marks are stored as special records on the disk storage as well. Volumes residing on disk storage are called virtual volumes.

The amount of data stored on a virtual volume is variable up to a maximum as determined by the media type selected. Two media types are emulated (standard Cartridge System Tape and Enhanced Capacity Cartridge System Tape); they can hold up to 400MB or 800MB of customer data, respectively. The 3494 Model B18

with the ESCON High Performance Option (EHPO) feature emulates storage of up to 2.4 GB (3:1 compression) on the virtual Enhanced Capacity Cartridge System Tape.

All host interactions with data in a Virtual Tape Server subsystem are through virtual volumes and associated virtual tape drives; there is no direct access to the data on a physical cartridge or drive.

## **Tape Volume Cache**

The size of the disk storage is large enough so more virtual volumes can be retained in it than just the ones currently associated with the virtual drives. After an application closes a virtual volume, if it was modified, a copy of it is made by the storage management software in the subsystem onto a physical tape. The virtual volume remains available on the disk storage until the space it occupies is needed to satisfy another mount request. Leaving the virtual volume in the disk storage allows for fast access to it during a subsequent request for the volume. The disk storage, and management of that space to keep volumes available after they are closed, is called the tape volume cache. The performance for mounting of a volume that is in the tape volume cache is quicker than if a real physical volume is mounted. Disk storage, in effect, caches the tape volumes and provides for fast access.

## **Storage Management of the Tape Volume Cache**

Storage management software in the subsystem manages the contents of the tape volume cache. Virtual tape volumes are copied from the tape volume cache to physical tape when the virtual volume has been closed, and they are recalled from tape to the tape volume cache when they are again requested to be mounted. The storage management software stacks multiple migrated files onto a 3590 tape, thereby utilizing its storage capacity.

## **Maintaining Data Fragments from Copied Volumes**

When the cache space occupied by a closed virtual tape volume is needed for other active virtual volumes, the data it represents is not completely removed. A fragment of the data is kept on disk storage. The data fragment includes information about the copied virtual volume so that it can be recalled and it also includes the first several records from the last use of the volume. Normally, the first few records on a tape contain a tape volume label, and enough data records are maintained to contain an IBM standard tape label plus any unique user label records.

## **Fast Response for Non-specific Mount Requests**

When a non-specific mount is requested, the customer application is going to write data from the beginning of tape, overwriting any existing data on the tape. The host can request a non-specific mount in a 3494 by specifying a category instead of a specific volser in the mount request. The library manager then selects the next available volume assigned to the specified category to satisfy the host request. Within a Virtual Tape Server subsystem, the data fragment is used in conjunction with a mount from category request to provide very fast response times for non-specific mounts. Categories used for non-specific mounts are defined through the library manager as "Fast Ready" categories (refer to Figure 98 on page 167). When a mount request specifies a category defined as "Fast Ready", the mount is satisfied by accessing the data fragment in the tape volume cache associated with



the virtual volume selected by the library manager to satisfy the request. No recall of the data from the previous usage of the volume is performed because the fragment contains the label information needed by the host tape management software to validate the use of the volume for a non-specific mount request. The subsystem signals the host that the mount is complete when the fragment is accessed. The result is a very short mount response time because no physical movement or mounting of a cartridge is involved.

If a mount request specifies a category that has not been defined as "Fast Ready", the library has no indication that the application intends to write from the beginning of the volume. It is likely that the selected virtual volume will not be resident in the tape volume cache and will have to be recalled from physical tape.

## Deletion of VTS Logical Volume

Logical volumes in a VTS can only be deleted under the control of the attached hosts. A logical volume can be deleted only if it is in the Insert category or a category with a Fast-Ready attribute set (see "Set VTS Category Attributes" on page 166). When a logical volume is deleted, it is removed from the library's inventory and any data that was associated with the volume is deleted. A logical volume which is in a Fast-Ready category is deleted from a VTS by performing the following steps. (A logical volume which is in the Insert category is deleted from a VTS by performing step 2 only).

1. Assigning the logical volume to a category within the library that has the Fast-Ready attribute assigned. This is accomplished by the tape management system when the data associated with the volume reaches its expiration date and the volume is returned to the scratch pool.
2. Subsequently, assigning the logical volume to an eject category. This can be done by asking that the volume be ejected from the library, using platform-specific library control interfaces; for example, with MVSE/ESA or OS/390, through the tape management interfaces, ISMF panels or MVS operator commands.

**Note:** Once a logical volume has been deleted from the library, data on the volume is deleted and cannot be recovered.

## Scratch Stacked Volumes

It is essential that sufficient scratch stacked volumes be available for use by a VTS for copying a virtual volume when the volume is closed. A warning is provided when the Free Storage Threshold cannot be met with the scratch stacked volumes which are available. See the Set VTS Management Policies Pop-Up Window, shown in Figure 99 on page 169. The number of empty scratch volumes can be determined by using the Search Database for Volumes pop-up window, Figure 83 on page 140, with a Search Criteria of category FF03. The records found will be the count of empty scratch volumes.

The Reclaim Threshold Percentage as entered on the Set VTS Management Policies pop-up window becomes important when the supply of scratch stacked volumes is low. The VTS Space Reclamation Algorithm may impact the VTS performance when it is necessary to reclaim expired space on stacked volumes. A high Reclaim Threshold Percentage requires that more active data be moved (using VTS resources) to free the stacked volume for scratch use. As a general rule, you should try not to go above 30% to 40% as a Reclaim Threshold Percentage. It is better to add additional stacked volumes rather than raise this value. When there

are less than 10 scratch stacked volumes, the Inhibit Reclaim Schedule shown on the Set VTS Management Policies pop-up window, Figure 99 on page 169, will not be in effect and the VTS will proceed to reclaim space on stacked volumes until at least 15 scratch stacked volumes are available. This activity may affect the performance of the host jobs running on the VTS.

## Integration with the 3494 Library

A Virtual Tape Server subsystem must be associated with an IBM library because the physical assets used by the subsystem are managed by the library manager in the library. The physical assets include the 3590 tape drives and the 3590 cartridges used for stacking logical volumes. The library manager provides several other key functions involving a Virtual Tape Server subsystem. These functions include:

- Logical library partitioning
- Operator interface
- Logical volume inventory

## Logical Library Partitioning

To support the product requirement that a Virtual Tape Server subsystem can coexist with current 3490 and native 3590 subsystems in the same library, the library manager partitions the physical library into logical libraries. This must be done because a Virtual Tape Server subsystem presents the image of 3490-type tape drives, and yet cannot read or write a real 3490 cartridge. By placing a Virtual Tape Server subsystem in its own logical library, host software will not be able to attempt to allocate a Virtual Tape Server drive for a real 3490 mount and vice versa.

A logical library can contain **either** of the following:

- A single Virtual Tape Server subsystem
- Current 3490 or native 3590 subsystems

Each logical library will have its own unique library sequence number and will look like a separate physical library to the hosts attached to the subsystems in that partition.

**Note:** Currently, up to two Virtual Tape Servers (only one of which may be a Model B16) are allowed in a physical library.

## SCSI Host Attachment

The SCSI Host Attachment feature provides attachment to RS/6000 systems. The sharing of a VTS among S/390 and RS/6000 systems requires assignment of virtual drive usage in a manner similar to stand-alone tape drives. Because only one host system at a time can use a drive, the drive has to be dedicated to that host during processing.

For a detailed discussion on tape library sharing between S/390 and SCSI hosts, including considerations about drive sharing, volume sharing and related software implementation steps, refer to *Guide to Sharing and Partitioning IBM Tape Library Dataservers*, SG24-4409. The SCSI target addresses are discussed in *IBM 3494 Tape Library Introduction and Planning Guide*, GA32-0279.

## Operator Interface

The library manager console is used to perform the setup, management, and status functions needed to support a Virtual Tape Server subsystem.

## Logical Volume Inventory

The data base in the library manager is expanded to handle the large number of logical volumes that a Virtual Tape Server subsystem uses. There are also new operator functions which allow the addition of logical volumes by specifying a volume serial number range through the library manager console (refer to Figure 95 on page 164).

## VTS Import/Export Overview

### Import/Export Operations

The Import and Export operations provide a way to move logical volumes out of a VTS subsystem to physical cartridges called Exported Stacked Volumes and to return them to the same or move them to another VTS. Lists of volumes for Import or Export are provided to a VTS on logical volumes called the Import List Volume or the Export List Volume, which are resident in the VTS. The Status File on the Import or Export List Volume provides status for each logical volume being processed. See “Appendix B. Virtual Tape Server Import/Export Advanced Function” on page 307 for information about preparing the Import or Export List Volume.

### Import

The Import operation allows logical volumes which are stored on physical Exported Stacked Volumes to become logical volumes within a Virtual Tape Server. A specific volume or all volumes may be imported from Exported Stacked Volumes which have been entered into a library through the Convenience Input/Output Station and have been moved to the Import category by an operator at the Library Manager console. Host console messages provide status on progress and completion of the Import operation.

### Export

The Export operation allows customer data on logical volumes in a Virtual Tape Server to be removed from the VTS onto physical Exported Stacked Volumes. The list of volumes to export and a destination for each volume is provided by the host operator or tape management system. Logical volumes with the same destination are grouped on the same Exported Stacked Volume and this physical volume is then moved into a category which allows an operator at the Library Manager console to eject the cartridge through the Convenience Input/Output Station for storage outside the library or movement to another tape library to be imported into a VTS. Host console messages provide status on progress and success of the Export operation.

---

## Local and Remote Power Control

The local power is controlled by the operator using a switch at the operator control panel. See “Changing from Local to Remote Power” on page 76 and “Changing from Remote to Local Power” on page 76 for operating instructions.

The remote power control, a 3494 feature for AS/400, supports both local and remote power controls. When the library is in local power mode, an operator can activate the power-on and the power-off sequences.

When in remote power mode, each host, through its AS/400 interface, can request that the power-on or power-off sequence be initiated. Any host requesting a power-on sequence will cause the 3494 to power on unless the library is already powered on. Only the last host requesting the library to power off will initiate a power off-sequence.

---

## Operator Involvement

During normal automated operation, no operator attendance is required except to add or to remove cartridges.

Operator assistance is required if an error or exception condition occurs from which the library cannot recover on its own. Depending on the type of error or exception condition experienced, some or all of the library operations are suspended until the problem is corrected. If an error occurs that prevents the movement of cartridges, the library manager suspends performing requests that require cartridge accessor movement. The operator can use the library manager or the remote library manager console (if the optional Remote Library Manager Console feature is installed) to identify the cause of the error. If the operator can correct the error, the library may be placed in Pause mode, and the front doors may be opened to provide operator access. After the problem is resolved, the library may be returned to Auto mode.

If the problem cannot be resolved by the operator, the operator may start Manual mode operations in the library. When in Manual mode, the library manager instructs the operator to perform manual mount and demount operations until the problem is resolved by a service representative. After the problem is resolved, the operator can return the library to Auto mode.

**Note:** When the high availability model is installed, control will automatically switch to the 'hot standby' component and the failed component will be marked unavailable. Concurrent maintenance can be performed to repair the failing unit. Operator involvement is needed only when a second failure occurs before the first failure is repaired.

---

## System Administrator Involvement

Normal daily operations of the library do not require any system administrator involvement. System administrator involvement may be required if an error condition occurs that cannot be resolved by the operator. A system administrator can obtain operational and performance information from the library manager or the remote library manager console (if the optional Remote Library Manager Console feature is installed) at any time.

The system administrator may also use the library manager or remote library manager console to search for cartridges in the library that have problems with their external labels, cartridges that have been misplaced or have other problems that need to be corrected.

**Note:** The tasks performed by a system administrator are typically password-protected to prevent unauthorized personnel from inadvertently or

intentionally damaging the library manager database or other operations. Use of password-protection is optional.

---

## Error Detection and Reporting

When the library is powered on, the library manager, the 3490E/3590 tape subsystems and Virtual Tape Servers perform power-on diagnostics. The library performs real-time error detection, fault isolation, error reporting, and error recovery during normal operation.

In the event of a failure, the information is reported to the attached hosts for logging and possible host recovery actions. When appropriate, host console messages are posted by the library drive support software in the control program to request operator-required actions or to present information for the operator. Refer to "Chapter 7. Remote Library Manager Console Feature" on page 241.

---

## Inventory Update

When inventory update is enabled and a door is opened then closed, an inventory update is performed upon the return to auto mode. This process checks all of the cartridge storage cells in the frames that had doors opened, and depending on the selection made during the teach process, may also check any adjacent frames to the frames that had doors opened.

**Note:** The drive feeds are also inventoried.

During an inventory update, processing of Audit and Eject operations are held until the update has been completed. Selected mounts and demounts are processed, depending on where the cartridge resides. No mounts or demounts are performed on cartridges which reside in a rack that must be verified in the inventory update operation, until the inventory update is complete. The duration of the inventory update is affected by the number of database updates required and the number of mounts and demounts that are done concurrently with the inventory update.

The Disable Inventory Update option is made available to the operator, at the mode selection window, when the library is powered on. This option, if selected, disables the inventory update during a cold start of the library, and speeds up the process of bringing the library Online. Selecting Disable Inventory Update at the mode selection window does not disable Inventory Update during normal operation.

A Disable Inventory Update option is available from the Commands pull-down. This option disables the inventory update process on a cold start of the library, during normal operations, and speeds up the process of changing modes after the doors on the library are opened.

**Note:** The Disable Inventory Update option is not recommended for users who open the library doors to add and to remove cartridges because **no changes in the library inventory are noted until inventory update is performed**. If cartridge inserts and ejects are handled through the Convenience Input/Output Station or High-Capacity Input/Output Facility, then running with Inventory Update disabled will speed operation. When the doors have opened, Partial Inventory Update can be selected from the Commands pull-down; this provides the most customer flexibility.

The Enable Inventory Update option is also available from the Commands pull-down. This option allows the user to enable the inventory update process. Inventory Update would then be done on all doors at initialization and following manual mode and to all doors opened on the transition from pause to auto.

Inventory update determines if any cartridges have been added, removed, or moved, and the library manager updates the cartridge inventory. During inventory update, one of the three following activities takes place:

- If a cartridge is found in its expected location, no update takes place.
- If a cartridge is found that is not in the inventory, the inventory is updated, with volser added to the Insert category.
- If a cartridge in the inventory is not found, it is placed in the manually ejected category.
- If an unlabeled cartridge is found, the cartridge is ejected from the library unless the unlabeled cartridge was inserted by using the Unlabeled Tape facility and the unlabeled cartridge is found in its home cell.

See “Insert Unlabeled Cartridges” on page 184 for information regarding the use of unlabeled cartridges.

---

## Volume Categories

The host can associate volumes into logical groupings in the library. A logical grouping is called a category, which the library manager identifies by a hexadecimal number from 0000 to FFFF. Table 3 shows the assignment of the categories.

The library manager maintains the order in which volumes are added to a category. The volumes chosen from a category are managed by a first-in first-out (FIFO) rule. However, if during the choosing of a volume from a category, the next volume is in use, inaccessible, or misplaced, the volume is skipped and the next available volume is chosen.

**Note:** For logical volumes in a “Fast-Ready” category, an odd/even volser selection algorithm is used to maximize VTS performance.

*Table 3. Volume Categories*

Category (in hex)	Name	Definition
0000	Null	Set when the library command specifies that the category already associated with the volume is to be used or the command does not specify a category. Using the null category does not affect the volume's order within the category to which it is assigned. Logical volumes are also added to the FF00 when they are inserted via the panel. See “Insert VTS Logical Volumes” on page 163
0001 to FEFF	General programming use	Assigned by the host control program.
<b>Note:</b> Categories FF00 to FFFE are reserved for hardware functions.		

Table 3. Volume Categories (continued)

Category (in hex)	Name	Definition
FF00	Insert	Set when a tape volume is added to the inventory. The 3494 reads the external label on the volume, creates an inventory entry for the volume, and assigns the volume to this category. The attached hosts are notified when one or more volumes are assigned to this category. Logical volumes are also added to the FF00 when they are inserted via an operator panel. See "Insert VTS Logical Volumes" on page 163 for more information.
FF01	Virtual Tape Server (VTS) Insert	Set when a stacked tape volume associated with a VTS is added to the inventory. The 3494 reads the external label on the volume, creates an inventory entry for the volume, uses the volser ranges to associate the volume with a VTS, and assigns the volume to this category. The associated VTS is notified when one or more volumes are assigned to this category.
FF03	VTS Scratch	Assigned by the VTS to stacked volumes that are scratch in the VTS.
FF04	VTS Private	Assigned by the VTS to stacked volumes that are private in the VTS.
FF05, FF06	VTS disaster recovery	Used by the VTS during disaster recovery operations.
FF07 to FF0F	—	Reserved
FF10	Convenience eject	Set when the library manager accepts an eject request. The volume becomes eject pending and the 3494 queues the tape volume to be moved to the Convenience Input/Output Station. When the cartridge accessor delivers the volume to the Convenience Input/Output Station, it is deleted from the inventory.  Logical volumes can be ejected if they are in the Insert category or a category defined as "Fast-Ready", and they are not in use. When a logical volume is ejected, it is deleted from the inventory.
FF11	Bulk eject	Set when a library manager accepts an eject request. The volume becomes eject pending and the 3494 queues the tape volume to be moved to the high-capacity output facility. When the cartridge accessor delivers the volume to the output rack, it is deleted from the inventory.  Logical volumes can be ejected if they are in the Insert category or a category defined as "Fast-Ready", and they are not in use. When a logical volume is ejected, it is deleted from the inventory.

Table 3. Volume Categories (continued)

Category (in hex)	Name	Definition
FF12	Export-Pending Category	At the start of export operation processing, the VTS assigns the logical volumes to be exported to this category to remove them from access by attached hosts. If the Library Export operation is cancelled or fails, any logical volumes assigned to this category are reassigned to the category they were in prior to the export operation. When a logical volume is assigned to the export-pending category, the original category information is preserved.
FF13	Exported Category	Once a group of logical volumes to export have been placed on a stacked volume and all processing for that stacked volume is completed, the VTS assigns the logical volumes to this category.
FF14	Import Category	Stacked volumes that contain logical volumes to import into the VTS are assigned to this category. When they are first added to the library through the Convenience Input/Output Station, they are placed in the Unassigned category automatically by the Library Manager. Prior to starting the import operation, the operator must manually move these volumes into the Import category via the <b>Manage Unassigned Volumes</b> panel, shown in Figure 129 on page 202.
FF15	Import-Pending Category	As part of import operation processing, the VTS assigns the logical volumes being imported to this category. If the Library Import operation is cancelled or fails, any logical volumes assigned to this category are deleted from the library inventory.
FF16	Unassigned Category	J type cartridges are assigned to this category when the Convenience Input/Output Station is in the Import Mode. Volumes remain in this category until the operator assigns them to either the Import Category or the Insert Category, or selects to eject them. Volumes are assigned to this category by the Library Manager when they are input via the Convenience Input/Output Station. They are assigned to this category if the library contains one or more VTS subsystems that have Import/Export capability.
FF17	Export Hold Category	Exported stacked volumes are assigned to this category by the VTS. This is a "limbo" category where export volumes are placed when the export operation is completed. The <b>Manage Export Hold Volumes</b> panel, shown in Figure 132 on page 206, is used by the operator to cause volumes in this category to be ejected.
FF18 to FFF5	—	Reserved



Table 3. Volume Categories (continued)

Category (in hex)	Name	Definition
FFF6	Service volume, 3590 only	Set when the library manager detects that a volume has a unique service volser. Volsers that fit the mask CE xxx (where xxx represents any valid volser characters) are service volumes. The imbedded blank makes these labels unique from customer volumes. Normally, service cartridges have volsers with the prefix CE (for example, CE 099). The specific cell location is predefined. The host does not have a record of a volume in the service volume category. The volumes in this category are not reported in inventory data in response to a request from the host.
FFF7	Mount from input station	Volumes to be used in a mount from the input station operation are placed in this category during the operation.
FFF8	—	Reserved
FFF9	Service volume, 3490E only	Set when the library manager detects that a volume has a unique service volser. Volsers that fit the mask CE xxx (where xxx represents any valid volser characters) are service volumes. The imbedded blank makes these labels unique from customer volumes. Normally, service cartridges have volsers with the prefix CE (for example, CE 099). The specific cell location is predefined. The host does not have a record of a volume in the service volume category. The volumes in this category are not reported in inventory data in response to a request from the host.
FFFA	Manually ejected	Assigned to this category if the cartridge that was in the inventory is not found.
FFFB to FFFC	—	Reserved
FFFD	Cleaner volume (3590 use only)	Assigned to this category when the cleaner volumes are identified by the library manager. Cleaner volumes are recognized when their volser matches a mask set up by the operator through the library manager console. (See “Cleaner Volume Masks” on page 172.) The host does not have a record of volumes in the cleaner volume category. Volumes in this category are not reported in inventory data in response to a request from the host. The vision uses the media type label to determine that a cleaner cartridge is a 3590 type.
FFFE	Cleaner volume (3490E use only)	Assigned to this category when the cleaner volumes are identified by the library manager. Cleaner volumes are recognized when their volser matches a mask set up by the operator through the library manager console. (See “Cleaner Volume Masks” on page 172.) The host does not have a record of volumes in the cleaner volume category. Volumes in this category are not reported in inventory data in response to a request from the host. The vision uses the media type label to determine that a cleaner cartridge is a 3490 type.
FFFF	Volser specific	Set by the control program. Any tape mount request to this category must be for a specific volser, not based on the category.

---

## Physical Volume States

A volume is in the inventory if an entry (in the inventory) for the volser is in the database. The following states are associated with a physical volume:

### **Inaccessible**

A volume is in the library manager inventory, but is currently in a location that is not accessible by the cartridge accessor.

### **Misplaced**

A volume is in the inventory, and the library manager determines that it is not in the position indicated by the inventory.

### **Mounted**

A volume is currently mounted on a drive or a mount was accepted for the volume.

### **Unreadable**

The vision system read the external bar-code label on a volume that has a defect in the external label or the volume does not have an external label. This state is not modified if the vision system is not operational.

### **Manual mode**

The volume required movement when the 3494 was in Manual mode. The volume is flagged in the inventory as a Manual mode volume until it is successfully moved or audited in Auto mode or during inventory update.

---

## Logical Volume States

A volume is in the inventory if an entry (in the inventory) for the volser is in the database. The following state is associated with a logical volume:

### **Mounted**

A volume is currently mounted on a drive or a mount was accepted for the volume.

---

## Physical Volser Validity Checking

As a physical cartridge is added to the tape library inventory, the library manager checks the volser to ensure that it is readable, is not already in the inventory, and is not otherwise invalid.

The Convenience Input/Output Station will be in either Import Mode or Insert Mode, depending upon the capabilities of the VTSs in the library and the configuration of the library.

The Convenience Input/Output Station is in Insert Mode when the library does not have a VTS that is capable of Import/Export operations.

The Convenience Input/Output Station is in Import Mode when the library has at least one VTS that is capable of Import/Export operations.

The mode of the Convenience Input/Output Station is stored so that the Library Manager “remembers” the mode across shutdowns. Once the mode is determined, the stored mode is used each time the Library Manager initializes. The mode will change if the configuration changes or the VTS capabilities change.

When the Convenience Input/Output Station is in Import mode, any J-type cartridge (High-Performance Cartridge Tape) is added to the database in the Unassigned category. Using the **Manage Unassigned Volumes** panel, shown in Figure 129 on page 202, the operator can assign the volumes in the Unassigned category to the Import category, assign volumes to the appropriate Insert category and partition based on the volser ranges, or eject a volume.

If any character of the volser cannot be read or any character is invalid (not A–Z or 0–9 or blank), the volser is not added to the inventory and the cartridge is ejected to an Input/Output Station. A volume notification message is sent to all attached hosts indicating that a volume remains in the Input/Output Station with an invalid or unreadable label. If this happens, the operator must determine why the volser is unreadable and correct the label before trying to reinsert the cartridge.

If the cartridge media type cannot be determined by the vision system, and the volser does not fit into an established volser range, and a default media type is not defined, then the cartridge will be ejected from the library to an input/output station.

When a volser is inserted in the Convenience Input/Output Station that is already in the inventory (a possible duplicate volser), an audit is performed.

If the volser is a duplicate, the cartridge is ejected to the Convenience Input/Output Station. If the volser is not a duplicate, the cartridge from the Convenience Input/Output Station is left in the new home cell.

If the *misplaced* or *inaccessible volume* indicators are set in the database, they are reset and a notification is sent to all attached hosts that indicates the volume was found or made accessible again. Also, if the *volume was used during Manual mode* indicator was set, it is reset.

A notification that describes the results of the audit is sent to all attached hosts.

**Note:** A service volume found in the Convenience Input/Output Station causes a validity check because its volser contains an invalid character—an embedded blank. A service volume must, instead, be placed in the cell reserved for it in the Control Unit frame, or be inserted using a special service volume insert process available in Service Mode.

---

## Logical Volser Validity Checking

When logical volumes are inserted into the library (refer to “Insert VTS Logical Volumes” on page 163), the library manager checks the volser range values for validity.

The Insert Logical Volumes function is not performed if the volser range characters are invalid (not A-Z or 0-9), there are fewer than 6 characters, or if the two vsers entered are not the same format. Corresponding characters in each volser must both be either alphabetic or numeric. For example, AAA998 and AAB114 are of the same form, whereas AA9998 and AAB114 are not.

Logical volume vsers must be unique within a physical library. If a volser already exists in the database for any logical library (non-VTS or VTS), the logical volume is not inserted. The Library Manager then attempts to insert the next logical volume.

---

## Command Priorities in the Queue

The library manager manages the operations queue with a set of priority levels. The library manager places operation requests in the queue in priorities from 0 through 9. A command priority of 0 is the highest priority and a command priority of 9 is the lowest priority. The priorities are established so Mount requests take precedence over any other operation, except for operations that must be executed on a priority basis. Therefore, priority level 0 is reserved for internally generated operations, while host requests start with priority level 1.

Higher priority operations are taken from the queue first. Within a priority level, operations are taken first-in first-out (FIFO). (The order may be shuffled if commands get requeued because something, such as an I/O station, may be busy).

---

## Priority Levels

Table 4 shows the priority levels, the operations in each level, and the operations that the operator can promote to priority 2. The highest priority that an operator can promote a queued operation is Level 2.

**Note:** If a priority 3 operation is in the queue for a specified period of time, it is automatically promoted to a priority 2. This prevents priority 3 mounts from being “blocked out” by higher priority operations.

Table 4. Command Queue Priorities

Priority	Operations	Promotable
0	Inventory update	—
1	<ul style="list-style-type: none"><li>• Mount from category</li><li>• Mount from input station operations</li><li>• Mount cleaner cartridge</li><li>• Export</li><li>• Import</li></ul>	—
2	<ul style="list-style-type: none"><li>• Promoted by operator</li><li>• Logical Mount - category or specific</li></ul>	—
3	Mount specific volser	Yes
4	<ul style="list-style-type: none"><li>• Move cartridge from input station</li><li>• Unlabeled tape operations</li><li>• Eject volser</li></ul>	Yes
5	Audit volser	Yes
6	Reserved	—
7	Demount	Yes
8	Reserved	—
9	Offline command	—

For details on Mount Operations, Demount Operations, and Audit Operations, see “Host-Initiated Operations” on page 55.

---

## Operations

The 3494 performs host-initiated and stand-alone operations.

### Host-Initiated Operations

The following are host-initiated operations:

- Mount operations
- Demount operations
- Eject operations
- Audit operations
- Import operations
- Export operations

#### Mount Operations

Host-initiated mount operations result in either a physical or logical mount being performed by the library. Whether the host-initiated mount is physical or logical is determined by the drive address to which the mount is issued. When issued to a drive address within a Virtual Tape Server, the library performs a logical mount operation. For all other drive addresses, a physical mount operation is performed.

The library manager directs the cartridge accessor to move a physical volume from its current location to the specified drive. The following are types of mount operations:

##### **Mount specific**

The specific volser to be mounted is specified in the mount request.

##### **Mount from category**

The volser to be mounted is picked from the specified category in the mount request.

Physical mount operations result in a volume being placed in a drive and loaded by the drive. Physical mounts are performed by the cartridge accessor.

Mounts for logical volumes are performed by the Virtual Tape Server. They may or may not require a physical mount.

Logical mount operations result in a virtual volume being made available to the host through a virtual tape drive. Following are the types of logical mount operations:

##### **Fast-Ready Mount**

The host requested a category mount and the category was designated as a “Fast-Ready” category. This type of mount selects a volser from the specified category and logically mounts it on the virtual tape drive. An odd/even volser selection algorithm is used to maximize VTS performance. No recall of the data from the prior use of the volser from physical tape is performed.

##### **Cache Mount**

The host requested a specific volser and the virtual volume for that volser is resident in the tape volume cache. No recall of data from a physical tape is performed.

## Physical Mount Required

The host requested a specific volser or specified a category that was not designated as a “Fast-Ready” category. The volser needed to satisfy that the mount operation is not resident in the tape volume cache and must be recalled from the physical tape. The library manager directs the cartridge accessor to move the required physical volume to one of the 3590 tape drives managed by the VTS so the recall operation can be performed.

## Demount Operations

The 3494 performs a physical demount operation whenever a volume is unloaded from a physical tape drive. A similar operation occurs for the virtual tape drives within a Virtual Tape Server. When a virtual volume is unloaded from a virtual tape drive, a logical demount operation is performed.

The following are two types of demount operations:

- A demount has been requested and the volume is currently at the tape drive.  
For a physical demount, this operation is used to move a volume from a tape drive to a storage cell. When the volume is placed in the storage cell, the demount is considered complete.  
For a logical demount, this operation updates the status of the virtual volume in the library manager database to indicate that it is no longer mounted. No physical movement of a volume is involved.
- A demount has been requested and the volume has not yet been mounted.  
This operation is used to cancel a mount operation that has not been started. The library recognizes that since a demount request has been received for a mount that has not yet taken place, the host must not really want the mount to take place. Therefore, the demount request and the mount request cancel each other.

## Eject Operations

An eject operation results in a physical cartridge being placed in a cell of an output facility in the library. The type of output facility may be either the Convenience Input/Output Station or the High-Capacity output facility and is specified by the host as part of the eject request. An eject request is considered complete when the specified cartridge is placed in the cell of an output station. On completion, the specified volume is removed from the library manager inventory.

Logical volumes managed by a Virtual Tape Server cannot be ejected from the library unless they are assigned to the Insert category or a category designated as a “Fast-Ready” category. Any host request to eject a logical volume not in the Insert category or a “Fast-Ready” category will fail. An ejected logical volume is removed from the library manager inventory.

## Audit Operations

The purpose of an audit is to ensure (by using the vision system) that the physical cartridge associated with the volser specified in the request is physically in the library where expected. If the volser specified in the request is a physical volume that is in the library manager’s inventory, the audit operation checks the external label of the cartridge in the storage cell specified in the library manager database. It must match what is in the database. If the volume is mounted on a tape drive, the audit is held until the volume is demounted and returned to its storage cell.

If the volser specified is a logical volume in the library manager's inventory, the library manager determines the physical volume the logical volume resides on and performs an audit of that physical volume. The audit operation is successful if the physical volume is found in the expected storage cell or if it is currently mounted on a physical drive in the Virtual Tape Server.

An audit operation for a volser that has been placed in an output facility of the library will fail because the volser is no longer in the library manager's inventory.

Audit operations are queued in the library manager and have a lower execution priority than mounts. An audit operation is complete when validation of the location of the specified volser has been attempted and the host has been notified of the success or failure of the validation.

## Export Operations

The Export operation allows logical volumes within a VTS to be copied to physical Exported Stacked Volumes that can be removed from a library. The logical volumes are deleted from the VTS and are no longer accessible in the VTS. A destination for each logical volume may be specified in order to create one or more Exported Stacked Volumes for a destination. Prior to executing the Export operation, it is necessary to provide a list of logical volumes to be exported as described in "Appendix B. Virtual Tape Server Import/Export Advanced Function" on page 307. Exported Stacked Volumes may be ejected from the Export-Hold category by using the Manage Export-Hold Volumes pop-up window, shown in Figure 132 on page 206.

## Import Operations

The Import operation allows one or more logical volumes from Exported Stacked Volumes to be copied into a VTS. The Exported Stacked Volumes must be inserted into the library by using the Convenience Input/Output Station and a list of logical volumes to be imported must be provided as described in "Appendix B. Virtual Tape Server Import/Export Advanced Function" on page 307. Exported Stacked Volumes remain in the Import category upon completion of the Import operation for further disposition by an operator using the Manage Import Volumes pop-up window, Figure 130 on page 204.

## Stand-Alone Operations

Stand-alone operations may be performed by using stand-alone software when a host cannot send mount commands to the library. Some examples are as follows:

### Stand-alone dump

The host must receive an initial program load (IPL) from tape, and then dump the host memory contents to a separate tape. The tape may then be mounted later under the control of a host.

### Stand-alone restore

The host must receive an IPL with a function to restore the contents of DASD volumes from data stored on the tape volumes. After the DASD volumes are restored, the host system may receive an IPL with restored DASD volumes.

Following are the two types of stand-alone operations:

### Using automatic cartridge loader mode

Although the tape drives in the 3494 do not have automatic cartridge loaders, the 3494 allows for automatic mounting of the next cartridge, of a predefined sequential set, in a specified library tape drive. The 3494 supports the assignment of cartridges to a special category, the assignment of a specified drive for restricted use with the special category, and the ending of the restricted usage of a tape drive.

### Mounting transient tape cartridges

**Note:** The Convenience Input/Output Station feature must be installed to take advantage of this function.

The 3494 Mount from Input Station function supports special usage of the Convenience Input/Output Station for the use of transient tape cartridges that are not part of the 3494 inventory. In this special-use mode, tape cartridges in the Convenience Input/Output Station are sequentially mounted, used (read or written), demounted, and returned to the Convenience Input/Output Station. This function is available as a selection from the Commands pull-down.

See “Stand-Alone Device” on page 180 for more information on stand-alone operations.

---

## Initial Cartridge Installation

Physical cartridges may be loaded into the library after the hardware installation is complete. The loading of physical cartridges can take place prior to the teach operation and the inventory operation. Logical volumes can be inserted after a teach. The following types of cartridges may be loaded:

### Customer volumes

Customer volumes are the initial set of data and scratch volumes to be automated. Any number of cartridges may be added to the library up to the maximum available cartridge storage cells in the library.

### Cleaner volumes

One cleaner volume should be installed in the library for each frame that contains a tape subsystem. The cleaner cartridge type (3490E/3590) depends on whether the tape subsystem uses 3490 or 3590 media. The cleaner cartridges may be placed in any available cell.

**Note:** The external volser must match the mask value that is provided, or the inventory operation will treat the cleaner cartridge as a normal customer volume.

### Service volume

One or two service volumes are installed in the library by the service representative depending on the library configuration.

### Logical Volumes

If a Virtual Tape Server (VTS) is installed, logical volumes are inserted into the library using the “Insert Logical Volumes” panel. Refer to Figure 95 on page 164.



### Stacked Volumes

If a Virtual Tape Server is installed, the 3590 High Performance Cartridge Tapes that it will use to store and manage logical volumes cannot be loaded into the library without first:

- Performing an initial teach of the library.
- Setting up one or more volser ranges that identify the stacked volumes that the Virtual Tape Server will manage. See “Volser Range for Media Types” on page 161 for a description of how to enter the volser ranges.

---

## Cartridge Placement

When you place cartridges into the library, performance will be improved if you adhere to the following guidelines:

- On initial loading of cartridges into the library, cluster cartridges around the tape subsystems they will be used with.
- For Inventory Update Inserts, place cartridges as near as possible to the tape subsystems on which you intend to issue mounts for those volumes.
- 3590 cartridges that will be used as stacked volumes for a particular VTS system should be placed in cells close to those drives associated with the VTS.

---

## Initial Volume Inventory Upload

After the 3494 completes all the initialization operations (including teach and inventory) and enters the Online state for the first time, the host software requests an upload of the volume inventory. The information from the library manager database is uploaded to the attached hosts before host applications can use the 3494.

The process to upload the information requires no operator action.

---

## Host Operation Control

The host operation control of the 3494 is operating-system dependent. Because the 3494 operates under a variety of host operating systems, you must be familiar with the operating system for your library and the required protocol.

For more information about the host operating systems, see the *IBM 3494 Introduction and Planning Guide* and “Related Information” on page xiv.

---

## Actions to Avoid when Operating a 3494

This section gives two lists of actions to avoid when operating a 3494. The first list (Things you should Never do) is the most important, as these actions can result in serious problems. The second list is also important, but these actions are more readily corrected and will result in problems of a less serious nature.

## Things You Should Never Do

This section gives a list of actions that you should **never** perform when operating a 3494. Failure to follow these recommendations will result in serious problems, including severe performance degradation.

- Never remove cartridges from tape drives unless told to do so by the Library Manager. Moving a cartridge can result in it being marked misplaced or inaccessible. The Library Manager will automatically clear the drive while in Automatic mode. Here are some cases where the Library Manager will indicate that the operator should clear the drive:
  - An operator intervention indicates that a tape drive failure has occurred and the cartridge should be removed from the specified drive.
  - A re-inventory of the complete system has been requested. At this time all cartridges should be removed from the drives and placed in empty cells. The re-inventory scans all cells and recreates the inventory database.
  - If the library is being used in Manual Mode and a mount is requested for a drive that has a cartridge in its feed slot, the cartridge should be removed from the drive so the mount can be performed. On returning to Automatic mode, cartridges which are already loaded in the drives or in the feed slot should be left in place.
- Never insert more cartridges into empty cells in the library than there are free cells indicated on the Operational Status panel. This is because cartridges currently loaded on drives must have a cell available when they are unloaded from the drive.
- Never insert cartridges into empty cells or move cartridges around in the library unless the Inventory Update function is enabled. Unless these cells are scanned on returning to Automatic Mode, the Library Manager will not be able to tell which cartridges have been added or moved.
- Never fail to save the logical volumes associated with a VTS during a Re-inventory Complete System unless they truly need to be deleted.
- Never leave Manual Mode until mounts that were started (cartridges that were physically placed in the feed slot of a drive) have been cleared from the Manual Mode panel.
- Never place Exported Stacked Volumes in the High-Capacity Input/Output Facility or into free cells in the library. This would cause them to be inserted as scratch volumes, and the data on them would be permanently lost.
- Never load a drive without being told to do so by the Library Manager (which only occurs in Manual Mode). If you need to load a cartridge without entering it into the library database, use the **Mount From Input Station** function.

## Things You Should Try to Avoid Doing

This section gives a list of actions you should avoid when operating a 3494, but whose consequences are less serious than those in the list above. Failure to follow these recommendations may still cause significant performance degradation.

- Avoid leaving the Convenience Input/Output Station door open. After several minutes this will result in an operator intervention being sent to the host indicating the Convenience Input/Output Station door is open.
- Avoid running with the library completely full. Running with a full library makes it impossible to insert any more cartridges into the library and results in cartridges being left in the I/O stations (Convenience and High-Capacity). It may also hinder

recovery of misplaced or inaccessible cartridges, which would have to be recovered through the error recovery cell one at a time.

- Avoid running large database searches (for instance, searching for all volsers in the library) from the Database pull-down while the library is busy. This can tie up the database and cause performance degradation.
- Avoid opening the enclosure doors without first pausing the accessors.



---

## Chapter 4. Operational Modes and States, and Informational States

The operational modes and states, and informational states of the 3494 are described in this chapter.

The current status of the library manager is defined as follows:

- Operational mode
- Operational state
- Informational state

The operational mode and state information are available through the library manager console, or the remote library manager console if the optional Remote Library Manager Console feature is installed. To view this information, do the following:

- Select **Status** from the Operator pull-down menu
- Select **System summary**

**Note:** If the display appears blank, press any key on the keyboard to activate the display.

---

### Operational Modes

The library operates in one of the following modes:

#### Auto Mode

In this mode, the cartridge accessor is operational. All commands are managed by the library manager under host program control or from the library manager console. The front doors of the library must be closed to operate in Auto mode.

#### Pause Mode

In this mode, the processing of Mount, Demount, Eject, and Audit requests is suspended. The 3494 enters this mode automatically when a failure prevents automatic operation or when instructed from the library manager console or the operator panel. This mode allows the operator to open the front doors on the library to correct an intervention condition or to insert cartridges into the library or remove cartridges from the high-capacity output facility. All Host requests for Mount, Demount, Eject, and Audit operations are queued until the 3494 is returned to Auto mode.

When the operator changes the mode from Auto to Pause, the library manager instructs the cartridge accessor to park. If an error condition occurs, power is immediately removed from the cartridge accessor and any operations in progress are suspended.

#### Manual Mode

In this mode, the cartridge accessor is parked in the home position, if possible, or moved by the operator to gain access to the desired cartridge or drive. The library manager provides instructions to the operator to perform tasks that are normally

performed automatically. This mode allows the operator to perform library tasks, for example, mounting and ejecting, until the 3494 is returned to Auto mode.

## Additional Operational Modes in the HA1 Environment

In a Library with the HA1 feature attached, one library manager is active, and the other is standby. Figure 29 shows the screen for the active Library Manager, and Figure 30 on page 65 shows the screen for the standby Library Manager.

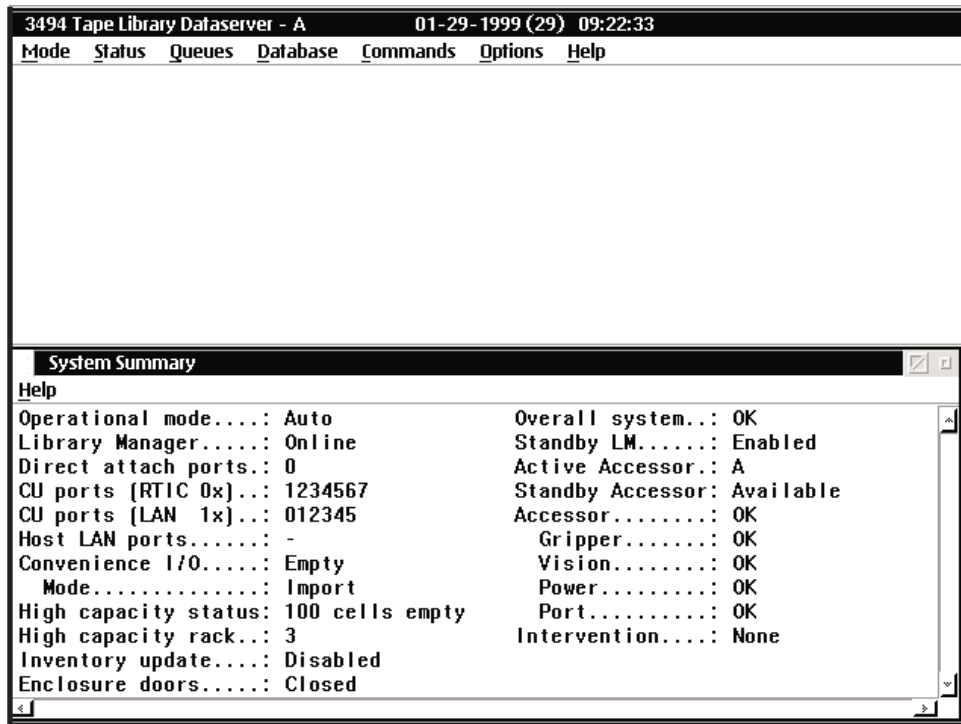

Figure 29. Active Library Manager

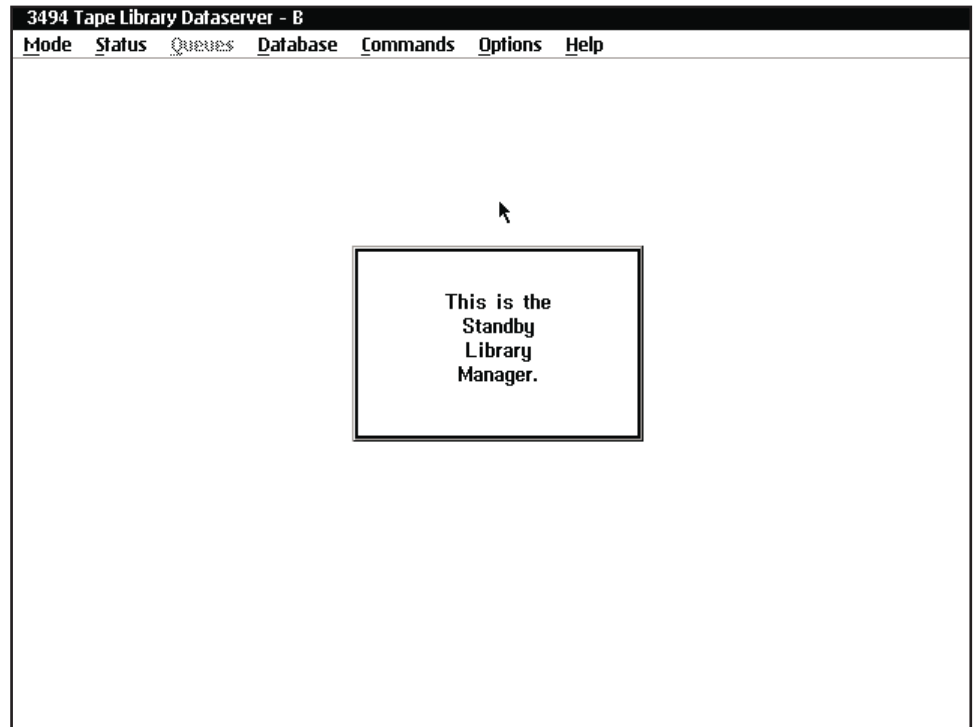

Figure 30. Standby Library Manager

## Home Cell Mode

The library operates in either fixed home cell or floating home cell mode. The home cell mode selection is made by the service representative, during the teach process, as follows:

### Fixed home cell

Fixed home cell mode assigns each physical cartridge to a fixed storage cell location when it enters the library, and it is always returned to the same location after it is used.

### Floating home cell

A physical cartridge is put into a cartridge cell location that optimizes performance.

### Notes:

1. Regardless of the mode specified during installation, the library only operates in fixed home cell mode when in Manual mode.

---

## Operational States

The library operates in one of the following operational states:

### Library manager initialization

The tape library starts the library manager application, power-on and interface verification tests, library manager database verification, and restarts error recovery (if applicable).

## Initialization complete

The tape library starts the library manager application and determines the operational mode and state. The mode and state are based on the availability conditions of the components and whether the 3494 is taught and inventoried. If the 3494 is taught and inventoried, the library manager waits for one of the following conditions:

- An operator instruction to proceed to an operation mode and operational state.
- A time-out interval expires and causes the 3494 to go to the default operational mode and operational state set by the availability conditions of the tape library components.

## Online State

In this state, the library manager accepts and processes host commands.

## Offline State

In this state, the library manager does not accept or process host commands. Commands received before entering the Offline state are processed.

Operations performed while the 3494 is in the Offline state, such as inventory, do not report errors to the host. Messages that may occur during Offline operations are displayed on the library manager console and the remote library manager console if the optional Remote Library Manager Console feature is installed.

## Shutdown pending

The library manager closes and exits the library manager application.

## Library Manager Switchover in Progress

When the high availability model is attached, this condition occurs when the active and standby library managers switch roles. This can occur on a failure or request by the operator. The library manager is in this state until the switchover completes.

**Note:** In case of a Library Manager failure, all attached hosts are notified and the library is taken off line. There is a short delay while the switchover completes and the operator must then vary the library on line. Any tape job that abended (including those that use logical drives of a Virtual Tape Server) must be resubmitted, and failed in-process tape operations must be reissued. Library Manager console operations being performed by the operator, including VTS-related operations, may require a restart.

## Accessor Switchover in Progress

When the high availability model is attached, this condition occurs when the active and standby accessors switch roles. This can occur on a failure or request by the operator. The library is in this state until the switchover completes.



## Dual Active Accessor Status

When the dual active accessors feature is installed, it may be enabled or disabled. Figure 31 shows the pop-up window for the transition into the dual active accessor mode, and Figure 32 shows the pop-up window for the transition out of dual active accessor mode. Each of these windows is shown until the transition is complete.

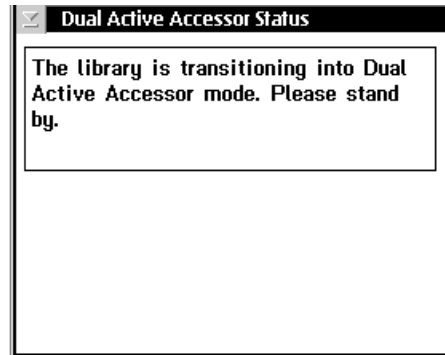

Figure 31. Dual Active Accessor Status — enabling

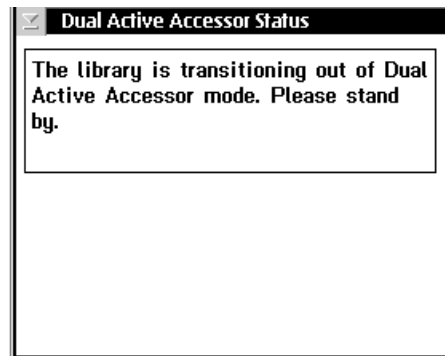

Figure 32. Dual Active Accessor Status — disabling

---

## Informational States

In addition to the operational states, the following informational states further define the state of the 3494 (one or more of which can occur at the same time):

### Degraded operation

Indicates that a component of the library is unavailable (except 3490E/3590 and Virtual Tape Server subsystems). When Model HA1 or the Dual Active Accessors feature is installed, this includes the ability of the standby library manager or the standby accessor to take over in the event of a failure.

### Safety interlocks open

Indicates that an interlock (front door) on the safety circuit is open.

### Vision System non-operational

Indicates that the vision system has failed and is unable to read the external volume labels on the cartridges.

**Intervention required**

Indicates that a condition in the tape library must be corrected by operator intervention.

**Library manager check-1 condition**

Indicates that the library manager has detected an unrecoverable condition that does not allow continued execution of host requests, and will attempt to re-initialize or switch to the standby library manager if the high availability model is installed to correct the problem.

**All storage cells full**

Indicates that all of the customer storage cells in the library have cartridges assigned to them.

**Out of cleaner volumes**

Indicates that a clean operation is required; however, there are no usable cleaner volumes of the right media type in the tape library.

**Note:** This informational state is entered in a mixed tape drive system (3490E/3590), if either type of cleaner cartridge is missing.

**Dual write disabled**

Indicates that the process that keeps the secondary database in sync with the primary database is not running. This is normal if the second hard drive feature that provides a secondary database is not installed.

---

## Relationship between Operational Modes and States

When an operational mode or state change is requested, the library manager must perform some steps before the change is completed. During this transition period, the immediate mode or state of the tape library is *mode* or *state pending*. For example, if the tape library is in the Online state and a request is made to enter the Offline state, the immediate operational state is *Offline Pending*. The System Summary window on the library manager console indicates whether the mode or state is pending. Sometimes the change between the modes and the states occurs quickly, and the pending status is displayed briefly.

---

## Operational Mode Transitions

The library is only in one operational mode at any one time.

When a change in operational mode is requested from the library manager, a pop-up window is displayed that allows the operator to confirm the mode change request.

**Note:** This applies to the active library when the high availability model is installed.

## Pause Mode to Auto Mode

A request to enter Auto mode can be performed by the operator using the operator panel (see “Changing to Auto Mode” on page 76) or by using the library manager. However the request is generated, the status of the 3494 is checked.

When a request to enter Auto mode is started using the library manager, the following actions occur during the change from Pause mode to Auto mode:

1. The library manager checks the status of the interface to the cartridge accessor. If it is not available, a pop-up window is displayed indicating the cartridge accessor interface is unavailable. The operator can cancel the request to Auto mode.
2. The library manager checks the cartridge accessor status. If it is not available because of a previous failure, the accessor is tested to see if it can be made available. If it can be made available, the transition to automatic is attempted. If a hardware problem is detected, the library returns to Pause and a pop-up window indicates the cartridge accessor is unavailable. The operator can cancel the request to Auto mode.
3. The library manager checks the power status of the cartridge accessor. If power is not on, a pop-up window indicates the fault and prompts the operator to ensure all safety interlocks are closed.
4. If the high availability model is installed, the library manager determines which accessor is to be the active accessor based on the previous state. If both are available, the preferred accessor is the local accessor. If both are not available, a pop-up window is displayed. The operator can cancel the request to auto mode.
5. The Pause Mode pop-up window is closed.
6. The Auto LED on the operator panel flashes until the transition is complete and then stays lit. The Auto Pending pop-up window indicates that the library is changing from Pause mode to Auto mode ( Figure 33). **Emergency Motion Off recovery is in progress** will appear in the pop-up window for a short time during this transition. When emergency motion off recovery is complete, the pop-up window closes.

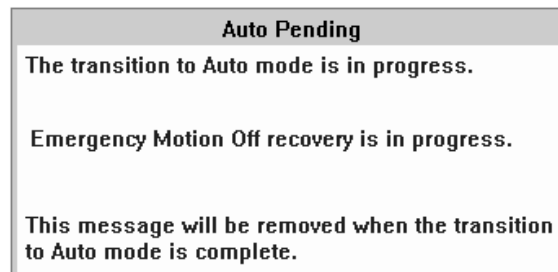

Figure 33. Auto Pending Pop-Up Window

7. The 3494 enters Auto mode.
8. An attention message is sent to all attached hosts indicating that the state of the library has changed.

## Auto Mode to Pause Mode (No Error)

A request to enter Pause mode can be performed by the operator at the operator panel (see “Changing to Pause Mode” on page 76) or by using the library manager. However the request is generated, the status of the 3494 is checked.

When a request to enter Pause mode is started using the library manager, the following actions occur during the change from the Auto mode to the Pause mode:

1. The Pause Pending pop-up window is displayed indicating that the change to Pause mode is in progress and that the cartridge accessor is being parked. The Pause LED on the operator panel flashes until the transition is complete and then stays lit. The border of the Pause Pending pop-up window alternates

between its highlighted and non-highlighted color to provide a visual indication that the 3494 is still in Pause Pending mode. The library manager also beeps five times.

2. The System Summary window is updated to indicate that the operational mode is Pause Pending.
3. The library manager instructs the cartridge accessor to move to its park location after completing the operations in progress.
4. The library manager is notified that the cartridge accessor is in its park location.
5. The library manager removes power from the cartridge accessor.
6. The library manager enters Pause mode and sends an attention message to all attached hosts indicating that the state of the library changed.
7. The Pause Pending window is removed, and the System Summary window indicates that the operational mode is Pause and that power is off.
8. The Pause Mode window is displayed that instructs the operator to wait while the cartridge accessor is being parked. If the cartridge accessor cannot be parked or if the status of its power is unknown, the window includes this information.

## Pause Mode to Manual Mode

A request to enter Manual mode is initiated by an operator using the library manager (see "Using Manual Mode" on page 227). No specific operations are performed by the library manager during the change from Pause to Manual mode. As Manual mode is entered, an attention message is sent to all attached hosts the indicates the state of the library changed to Manual mode.

The operational status is changed to Manual. If the cartridge accessor cannot be parked or if the status of its power is unknown, the pop-up window includes this information.

## Manual Mode to Pause Mode

A request to enter Pause mode must be performed by an operator using the library manager. During the change to Pause mode, the following steps are performed:

1. Operations that were fetched from the operations queue, but not confirmed as executed by the operator, are returned to the operations queue for execution when the library returns to Auto mode.
2. The library manager enters Pause mode and sends an attention message to all attached hosts indicating that the state of the library changed.

## Auto Mode to Manual Mode

When an operator selects Manual mode while the 3494 is in Auto mode, the library performs the operations required to move to Pause mode and then move to Manual mode. All pop-up windows indicate that the 3494 is in Manual Pending even as it is moving through Pause mode. Also, an attention message is only sent when Manual mode is entered, not for the intermediate pause mode. During the change from Auto to Manual mode, the following steps are performed:

1. A Manual Pending pop-up window is displayed indicating that the change to Manual mode is in progress and that the cartridge accessor is being parked.
2. The System Summary window indicating that the operational mode is Manual Pending.

3. The operations necessary to park the cartridge accessor and remove its power are performed (see “Auto Mode to Pause Mode (No Error)” on page 69).
4. The library completes the change to Manual mode (see “Pause Mode to Manual Mode” on page 70).
5. An attention message is sent to all attached hosts indicating that the state of the library changed.

## Manual Mode to Auto Mode

When an operator wants to select Auto mode while the 3494 is in Manual mode, the operator must use the library manager. The library performs the operations to move to Pause mode and then move to Auto mode. All pop-up windows indicate that the 3494 is in Auto Pending as it is moving through Pause mode. In addition, an attention message is only sent when Auto mode is entered, not for the intermediate Pause mode. During the change from Manual to Auto mode, the following steps are performed:

1. The System Summary window indicates that the operational mode is Auto Pending.
2. The 3494 completes the change to Pause mode as described in “Manual Mode to Pause Mode” on page 70.
3. The library completes the change to Auto mode as described in “Pause Mode to Auto Mode” on page 68.
4. An attention message is sent to all attached hosts indicating that the state of the library changed.

## Initialization State to Auto, Pause, or Manual Mode

During the initialization-complete state, the library manager determines which operational mode to enter. The determination is made by examining the database and the state of the cartridge accessor power. When the determination is made, the change to the selected mode occurs. The steps taken during the transition are the same as an operator request when the library is in Pause mode and Offline state.

## Auto Mode to Pause Mode (Forced)

If a severe error or condition is detected, and the error or condition is such that it is not possible to continue automated operation, the library is forced into Pause mode. Power is immediately removed from the cartridge accessor and any operations in progress are stopped. When the library manager enters Pause mode, it sends an attention message to all attached hosts indicating that the state of the library changed. The state-change message and an associated unsolicited unit check indicates the error recovery action (ERA).

The Pause Mode pop-up window directs the operator to open the library. In most cases, the cartridge accessor cannot be parked.

---

## Operational State Transitions

The tape library is only in one operational state at any time.

## Shutdown Pending State to Shutdown State

During this change, the library manager application is removed from memory.

## Shutdown State to Library Manager Initialization State

This change occurs when the library manager controller is powered on or when a severe error occurs.

## Library Manager Initialization State to Initialization Complete State

After the library manager starts the main process of the library manager application, the tape library enters the initialization complete state. No actions are taken during this change.

## Offline State to Online State

The request to enter the Online state can be either operator or library manager initiated. In either case, the following steps are performed during the transition:

1. The database is examined to determine if both the teach and the inventory operations have completed. The tape library cannot enter the Online state unless they have completed.
2. The status of the interfaces to the tape subsystems and host systems is examined to determine whether any interfaces are initialized with the library manager. If at least one of the tape subsystems interfaces is initialized and the associated control unit is Online to the library manager, the tape library enters the Online state and notifies all attached hosts. If no interfaces are initialized, the tape library enters the Online state but does not send a notification.
3. If a VTS is installed, the Library Manager checks for defined "Fast-Ready" categories. If none are found, a message stating that Fast-Ready categories should be defined is displayed for 1 minute or until **OK** is selected. Notify your system administrator if you see this message.

## Online State to Offline State

A request to enter the Offline state is initiated by an operator. After it is requested, the transition must complete before a transition to the Online state can be requested. The following actions are performed during the change to the Offline state:

1. A notification is sent to all attached hosts indicating that the tape library is entering the Offline state. The 3490E/3590 control units, Virtual Tape Servers, and the Library Manager will fail any later host requests for tape library functions.
2. All host requests that were accepted and queued before the request to enter the Offline state are processed. Responses are provided to the requesting host as appropriate.
3. All internal commands queued before the request to enter the Offline state will complete and, if errors are detected, appropriate host notifications are generated.
4. After all queued commands are completed and responses are sent, the tape library enters the Offline state.

**Note:** The change from the Online to the Offline state can take more than ten minutes if a high-capacity output operation was started before the request to

go to the Offline state. This time is needed to move the cartridges to the high-capacity output facility from the storage cells. If a high-capacity operation is in progress, the operator is prompted to cancel the operation. If the operator does not cancel the high-capacity operation, the Offline request is cancelled.

**Note:** Online to Offline State — not allowed if an Export or an Import operation is in progress. A pop-up message will be displayed alerting the operator to do one of the following:

- Wait for the operation to complete.
- Cancel the operation from the host.
- Cancel the operation by selecting “Cancel VTS Export/Import” from the Commands/System Management pulldown.

Figure 48 on page 104 shows the pop-up message with these three options.

## Initialization Complete State to Online or Offline State

During the initialization complete state, the library manager determines which operational state to enter. The determination is made by examining the database. The steps taken during the transition are the same as for an operator request as described in “Offline State to Online State” on page 72 or “Online State to Offline State” on page 72.

## Offline State to Shutdown Pending State

A request to enter the shutdown pending state is made through an operator request. No actions are taken during the change.

---

## Informational State Transitions

One or more information states may be active at any time in the tape library. When an informational state is entered or left, and the tape library is in the Online state, a notification indicating the change is sent to all attached hosts. Most of the states are a condition in the 3494, and no actions are performed during the change into or out of the state.

The following describes any additional steps performed during the change into or out of a state:

### **Degraded**

When a component of the tape library becomes available, the library manager determines whether any other components are unavailable. If all components are now available, the tape library leaves the degraded state.

### **Safety interlock open**

When a safety interlock (front door) is open, the library manager examines the condition of the tape library to determine whether the interlock opening was expected or unexpected. If the opening was unexpected, the tape library is forced into Pause mode.

### **Intervention required**

When a condition requiring intervention is corrected, the library manager determines whether any other intervention requirements exist. If none exist, the tape library leaves the intervention-required state.

**Library manager check-1 condition**

The library manager: detects an unrecoverable condition that does not allow continued execution of host requests, and will attempt to re-initialize to correct the problem.



---

## Chapter 5. Basic Operating Procedures

The basic operating procedures for the 3494 are described in this chapter.

Table 5 shows the basic operating procedures that an operator can perform by using the operator panel on the front of the control unit frame.

*Table 5. Quick Reference to Basic Operating Procedures*

Task	Procedure
Powering on the 3494	"Powering On the 3494".
Powering off the 3494	"Powering Off the 3494".
Changing to Pause mode	"Changing to Pause Mode" on page 76.
Changing to Auto mode	"Changing to Auto Mode" on page 76.
Changing from local to remote power	"Changing from Local to Remote Power" on page 76.
Changing from remote to local power	"Changing from Remote to Local Power" on page 76.
Inserting cartridges	"Inserting Cartridges" on page 77.
Removing ejected cartridges	"Removing Ejected Cartridges" on page 81.

---

### Powering On the 3494

1. Press the Unit Emergency switch (on the operator panel) to the On position (if it is not already in the On position).

**Notes:**

- a. The library must be powered off and remain off for 30 seconds before you attempt to power the library on again. The 30-second wait is needed to allow the 3490E tape subsystem sufficient time to properly initialize.
  - b. If the 3494 Library has more than eight frames, or the high availability model is installed, both unit emergency switches must be set to the On position. The second switch is located at the right-hand end of the Library (when facing the cartridge access doors).
  - c. If the 3494 Model B18 VTS is installed, the unit emergency switch on the Model B18 must be set to the On position.
2. Press the Unit Power switch, on the operator panel, to the On position.

**Notes:**

- a. If the remote power feature is installed and the Local Remote switch is in the Remote position, the Unit Power switch cannot power on the 3494.
  - b. When the Rack Power Ready and Power System Ready LEDs are lit, the power to the library is on.
3. If the library is attached to an AS/400, ensure the media library device driver is initialized.
  4. Ensure all drives are varied Online to the appropriate host.

---

### Powering Off the 3494

1. Ensure all drives are varied Offline to the appropriate host.
2. Press the Unit Power switch, on the operator panel, to the Off position.

**Note:** If the Local/Remote switch is in the Local position, the Unit Power switch can power off the 3494.

3. Observe the Power Off Pending LED on the operator panel. The LED flashes until the 3494 is powered off.

The system can take up to 20 minutes in a library with a VTS to shutdown. When the shutdown completes, the 3494 (including the Model B18, if installed) is powered off.

**Note:** The library may be powered off immediately, in an emergency, by using the Unit Emergency switch on either the operator panel or at the right end of the Library. The second switch, at the right end, is provided if the library has more than eight frames or the high availability model is installed.

**Attention:** Using the Unit Emergency switch for immediate power off can cause database problems or check disk (CHKDSK) problems with the library manager or VTS controller. The 3494 Model B18 Virtual Tape Server will not be powered off by the 3494 Unit Emergency switch, but the associated tape drives will have power removed.

---

## Changing to Pause Mode

1. Press the Pause button on the operator panel.
2. Observe the Pause LED on the operator panel. The LED flashes until the library is in Pause mode. When the library is in Pause mode, the Pause LED stays lit.

**Note:** The Auto LED stays lit until the library enters Pause mode.

---

## Changing to Auto Mode

1. Press the Auto button on the operator panel.
2. Observe the Auto mode LED on the operator panel. The LED flashes until the library is in Auto mode. When the library is in Auto mode, the Auto LED stays lit.

**Note:** The Pause LED stays lit until the library enters Auto mode.

---

## Changing from Local to Remote Power

If the remote power feature is installed, change to remote power by pressing the Local Remote power switch to the Remote position.

If the remote power feature is not installed, the Local Remote power switch must be in the Local position.

**Attention:** Pressing the Local Remote Power switch to the Remote position powers off the 3494 if the remote power feature is not installed.

---

## Changing from Remote to Local Power

If the remote power feature is installed, change to local power by pressing the Local Remote power switch to the Local position.

**Attention:** Pressing the Local Remote Power switch to the Local position powers off the 3494 if the Unit Power switch is in the Off position.

---

## Inserting Cartridges

Cartridges can be inserted into the library in the following ways:

- See “Initial Cartridge Installation” on page 58.
- See “Using Empty Cartridge Cells to Insert Cartridges”.
- See “Using the Convenience Input/Output Station Feature to Insert Cartridges” on page 78.
- See “Using the High-Capacity Input/Output Facility” on page 81.

**Note:** The type of input/output facility available to the operator was defined during the teach process.

**Note:** Make sure that there are enough available cells for the cartridges you are inserting. Use the Operational status panel (Figure 61 on page 111) to check the number of empty storage cells in the library.

Inserting stacked volumes for a Virtual Tape Server (VTS) requires that 1 or more volser ranges have been set up for the VTS before the stacked volumes are inserted. Refer to Figure 94 on page 162.

Inserting logical volumes for a VTS is accomplished using the “Insert Logical Volumes” panel. Refer to Figure 95 on page 164.

## Using Empty Cartridge Cells to Insert Cartridges

**Attention:** Never place Exported Stacked Volumes into free cells, as this will cause the data on them to be overwritten.

1. Place the library in Pause mode by pressing the Pause mode Motion Control switch on the operator panel.
2. When the Pause mode status light is lit, unlock and open the front door on any frame.
3. Insert the cartridges into any empty cartridge storage cells, except error recovery cell locations 1 A 1 (1 A 3 instead of 1 A 1 if the optional Dual Gripper feature is installed), 1 A 20, 1 A 19 (if two service volumes are used) and the high-capacity output facility cells. See “Cartridge Placement” on page 59 for cartridge placement guidelines.

**Note:** The error recovery cell locations for a High Availability, single gripper unit are 1 A 1 and 1 A 2. The error recovery cell locations for a High Availability, dual gripper unit are 1 A 3 and 1 A 4. On all High Availability models, service volumes are stored in the service bays.

**Note:** If there is no convenience I/O station and no High Capacity I/O defined, then cell 2 A 1 is reserved for ejects.

**Note:** The cartridges must be inserted into the cartridge storage cells so that the leader block is on the right and the volser label is visible. See Figure 16 on page 20.

4. Close and lock the front door.
5. Press the Auto mode Motion Control switch on the operator panel.

**Note:** If the inventory update is not **enabled**, select Perform Inventory Update from the Commands pull-down (see “Using the Commands Pull-Down” on page 152) to add the newly inserted cartridges to the library manager database and to send messages to the hosts. Perform Partial may also be selected. The operator is shown which doors were opened and may select or deselect doors to re-inventory. All other library activity is held until the inventory update is completed (approximately 4 minutes per frame being inventoried).

If the high availability model is installed, **do not** insert cartridges into the service bays, as they **cannot** be accessed by the library.

## Using the Convenience Input/Output Station Feature to Insert Cartridges

Cartridges may be inserted into the library by using the Convenience Input/Output Station during normal automatic operation by performing the following steps:

**Note:** The ten-cell I/O station feature is shown in Figure 34 on page 79. Figure 35 on page 80 shows the optional 30 cell I/O. If the 30-cell I/O is installed, the operation remains the same, but there are two operator doors. The upper operator door **1** provides access to the top 10 cells. The lower operator door **2** provides access to the lower 20 cells. (Both doors open together.)

1. Check the status of the Convenience Input/Output Station on the operator panel. If the Output Mode status light and the Unload Required status light are not lit on the operator panel, proceed to step 2.

If the Output Mode status light or the Unload Required status light is lit on the operator panel, open the Convenience Input/Output Station door and remove all the cartridges in the Convenience Input/Output Station.

2. Insert the cartridges **2** (see Figure 34 on page 79) that you want to add to the library into the Convenience Input/Output Station **1** with the cut-off corner (and leader block) to the left and the external label facing to the **inside** of the Convenience Input/Output Station. Shut the Convenience Input/Output Station door.

The Input Mode indicator will light and stay lit until all the cartridges in the Convenience Input/Output Station are stored.

3. Repeat these steps until all of your cartridges are inserted.

### Convenience I/O Mode

The Convenience Input/Output Station will be in either Import Mode or Insert Mode, depending upon the capabilities of the VTSs in the library and the configuration of the library. (See Figure 77 on page 131.) The Convenience Input/Output Station is in Insert Mode when the library does not have a VTS that is capable of Import/Export operations.

The Convenience Input/Output Station is in Import Mode when the library has at least one VTS that is capable of Import/Export operations.

The mode of the Convenience Input/Output Station is stored so that the Library Manager “remembers” the mode across shutdowns. Once the mode is determined, the stored mode is used each time the Library Manager initializes. The mode will change if the configuration changes or the VTS capabilities change. The System

Summary pop-up window (Figure 43 on page 98) shows the **Convenience I/O Mode** of Import or Insert.

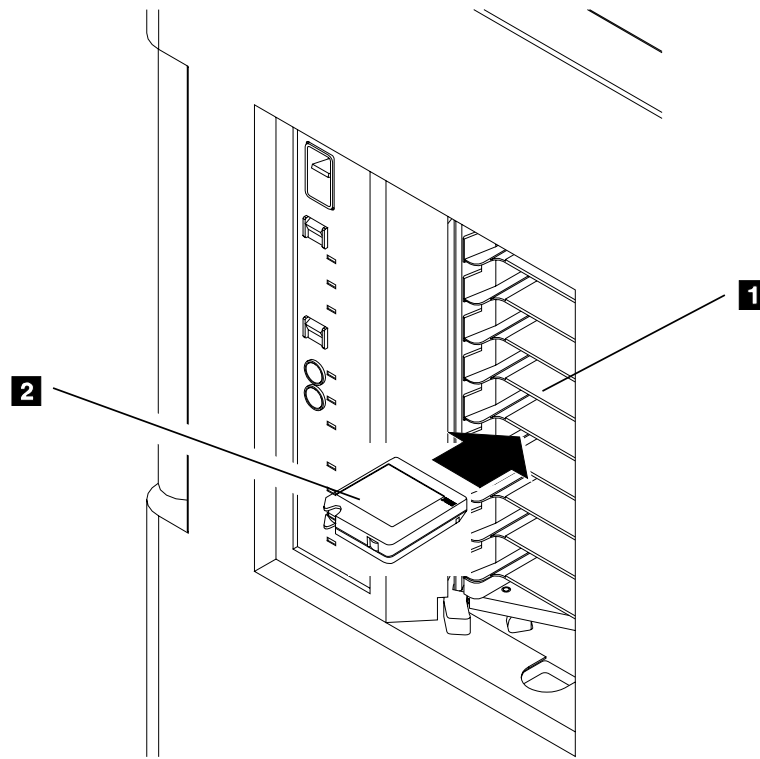

Figure 34. Inserting Cartridges in the Convenience Input/Output Station

### Using the Convenience Input/Output Station Import Mode

When the Convenience Input/Output Station is in Import Mode, any J-type cartridge (High Performance Cartridge Tape) that is inserted into the Convenience Input/Output Station will be added to the Unassigned category of the library. Exported Stacked Volumes are J-type cartridges that contain logical volumes that have been exported from a VTS. In order to import logical volumes, those cartridges that are Exported Stacked Volumes must be moved by an operator into the Import category of the library after having been input into the library. To use the Convenience Input/Output Station in Import mode, an operator must:

1. Input cartridges into the library as described previously for use of the Convenience Input/Output Station.
2. If any of the cartridges are J-type, observe the Manage Unassigned Volumes pop-up window (see Figure 129 on page 202), which will be automatically presented. All J-type cartridges will be displayed in the Unassigned category. CST and ECCST cartridges will have been input in the Insert category of the library and will not be displayed.
3. Exported Stacked Volumes in the Unassigned category that will be used for an Import operation must be moved into the Import category using the Manage Unassigned Volumes pop-up window.
4. J-type cartridges that are being inserted for use as stacked volumes in a VTS must be moved into the Insert category. The Manage Unassigned Volumes pop-up window provides this capability as well as the Volser ranges pushbutton

for validating the ranges that have been defined for physical volumes. J-type cartridges that are not in a VTS range of stacked volumes will be inserted for native 3590 use.

5. J-type cartridges that are intended for native 3590 use must be moved into the Insert category. The Volser ranges pushbutton allows validation of physical stacked volume ranges to insure that native 3590 cartridges will not become VTS stacked volumes
6. The Category Recovery section in “Appendix B. Virtual Tape Server Import/Export Advanced Function” on page 307 provides instructions for recovery from errors made when moving cartridges from the Unassigned category.

**Note:** The Convenience Input/Output Station is used for Exported Stacked Volumes to be Imported, VTS stacked volumes, and J-type 3590 native use volumes. The task of moving volumes from the Unassigned category into the Import or Insert categories can be simplified by scheduling insertion of different volume types at different times.

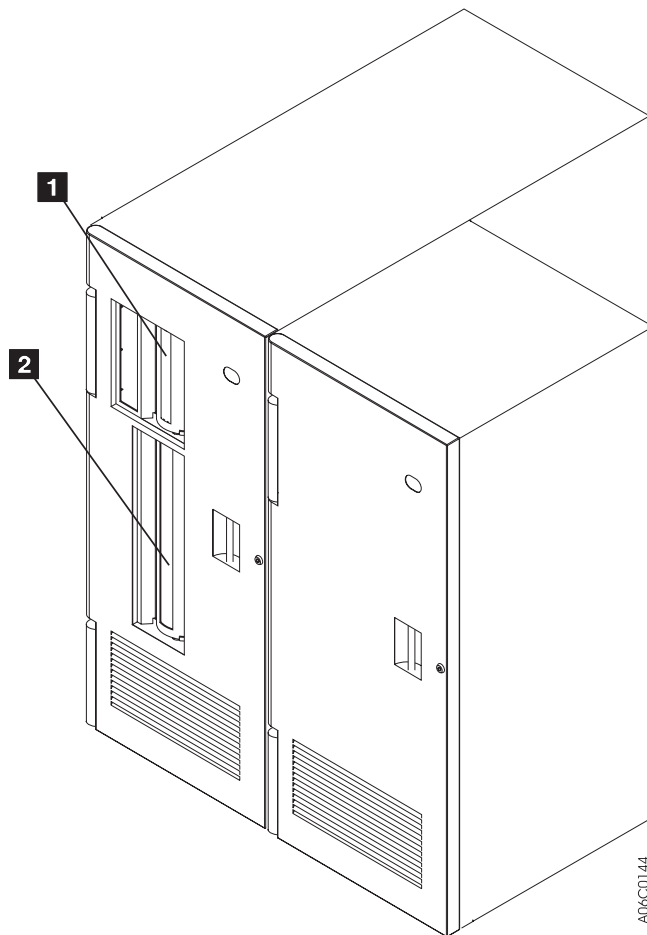

Figure 35. Optional 30-Cell I/O

## Using the High-Capacity Input/Output Facility

**Attention:** Never place Exported Stacked Volumes into the High Capacity Input/Output Facility, as this will cause the data on them to be overwritten.

The defined facility will be scanned on the first transition to Automatic mode even if Inventory Update is disabled or on any transition to Automatic mode if the door associated with the frame containing the facility has been opened. The scan is done in the above cases regardless of the state of Inventory Update (enabled/disabled).

Following the scan of the facility, all library activity is restored (mounts, demounts, conv. I/O). VOLSERS to be inserted are added to the database and the host is notified. Once the category has changed, the VOLSERS may be mounted directly from the high capacity area.

New VOLSERS found in the facility are inserted and those already existing in the facility are left ejected. VOLSERS are inserted from the facility in a top to bottom and right to left sequence (E 01 to A xx). VOLSERS are ejected to the facility in a top to bottom and left to right sequence (A 01 to E xx). The physical movement of the cartridge is scheduled with regular library activity. The operator may change the priority on a particular insert so movement will be completed faster.

Configuring the High-Capacity I/O is done during a teach operation under the **Teach** pull-down in Service mode.

**Note:** There should be enough free cells in the library to hold the cartridges that must be moved when High-Capacity I/O is configured. When the facility is moved to a new location, both the old location rack and the new location rack are scanned.

---

## Removing Ejected Cartridges

You may remove ejected cartridges from the library in the following ways:

- By removing an ejected cartridge from the single-cell output facility
- By removing an ejected cartridge from the High-Capacity Output facility or High-Capacity Input/Output facility
- By removing an ejected cartridge from the Convenience Input/Output Station feature

**Notes:**

1. The type of input/output facility available to the operator was defined during installation of the library.
2. Avoid manually removing cartridges from library cells. Have the host eject them to an input/output facility.

## Removing an Ejected Cartridge from the Single-Cell Output Facility

1. Press the Pause button on the operator panel.
2. Observe the Pause mode LED on the operator panel. The LED flashes until the library is in Pause mode and then stays lit.
3. Unlock and open the control unit frame front door and retrieve the ejected cartridge from the single-cell output facility at location 2 A 1 (or location 2 A 3 if the optional Dual Gripper feature is installed).
4. Shut and lock the control unit frame door.

5. Press the Auto mode button on the operator panel.
6. Observe the Auto mode LED on the operator panel. The LED flashes until the library is in Auto mode and then stays lit.

**Note:** If the high availability model is installed, the output facility still uses cells in the control unit. The cells in the service bays are not available to the library.

## Removing Ejected Cartridges from the High-Capacity Output Facility

1. Press the Pause button on the operator panel.
2. Observe the Pause mode LED on the operator panel. The LED flashes until the library is in Pause mode and then stays lit.
3. Unlock and open the control unit frame front door and retrieve the ejected cartridges from the area defined as the high-capacity facility output area.
4. Shut and lock the control unit frame door.
5. Press the Auto mode button on the operator panel.
6. Observe the Auto mode LED on the operator panel. The LED flashes until the library is in Auto mode and then stays lit.

**Note:** If the high availability model is installed, the output facility still uses cells in the control unit. The cells in the service bays are not available to the library.

## Removing Ejected Cartridges from the High-Capacity Input/Output Facility

1. Press the Pause button on the operator panel.
2. Observe the Pause mode LED on the operator panel. The LED flashes until the library is in Pause mode and then stays lit.
3. Unlock and open the frame door that contains the High-Capacity Input/Output facility and retrieve the ejected cartridges from the area defined as the High-Capacity Input/Output facility.
4. Shut and lock the frame door.
5. Press the Auto mode button on the operator panel.
6. Observe the Auto mode LED on the operator panel. The LED flashes until the library is in Auto mode and then stays lit.

**Note:** If the high availability model is installed, the output facility still uses cells in the control unit. The cells in the service bays are not available to the library.

## Removing Ejected Cartridges from the Convenience Input/Output Station Feature

1. Observe the Output mode LED on the operator panel. If the LED is lit, the Convenience Input/Output Station has ejected cartridges.
2. Open the Convenience Input/Output Station door and remove all the cartridges.
3. Close the Convenience Input/Output Station door.

**Note:** The Convenience Input/Output Station receives ejected cartridges of all types. A mixture of CST, ECCST, and HPCT (I, E, and J-types) should be expected and no order relation exists. J-type cartridges may be any of the following:

- Newly-created Exported Stacked Volumes from the Export-Hold category



- Exported Stacked Volumes that were used in an Import operation from the Import category
- VTS stacked volumes being ejected
- Native 3590 cartridges being ejected by a host

Site operations management of time periods for Export and Import operations can minimize the mix of cartridges in the Convenience Input/Output Station.



## Chapter 6. Advanced Operating Procedures

The advanced operating procedures for the 3494 are described in this chapter.

Table 6 shows the advanced operating procedures an operator can perform by using the library manager at the rear of the library.

*Table 6. Quick Reference to Advanced Operating Procedures*

<b>Task</b>	<b>Reference</b>
Using the library manager	"Using the Library Manager" on page 88.
Making selections with the library manager	"Making Library Manager Selections" on page 92.
Making selections with a keyboard	"Selections with the Keyboard" on page 92.
Making selections with the pointing device	"Selections with the Pointing Device" on page 92.
Using the Help pull-down	"Using the Help Pull-Down" on page 94.
Using the Help search	"Help Search" on page 95.
Using the Help action bar and function keys	"Help Action Bar and Function Keys" on page 95.
Using the Operator menu	"Using the Operator Menu" on page 98.
Using the Mode pull-down	"Using the Mode Pull-Down" on page 99.
Using the Auto selection	"Auto" on page 100.
Using the Pause selection	"Pause" on page 100.
Using the Manual selection	"Manual" on page 101.
Using the Online selection	"Online" on page 101.
Using the Offline selection	"Offline" on page 103.
Using the Service menu selection	"Service Menu" on page 104.
Switching the Active Library to Standby	"Switch Active Library Manager to Standby" on page 105.
Switching the Active Accessor to Standby	"Switch Active Accessor to Standby" on page 106.
Enabling Dual Active Accessors	"Enable Dual Active Accessors" on page 107.
Disabling Dual Active Accessors	"Disable Dual Active Accessors" on page 107.
Using the Shutdown selection	"Shutdown" on page 108.
Using the Status pull-down	"Using the Status Pull-Down" on page 109.
Using the Operational Status selection	"Operational Status" on page 111.
Using the Component availability selection	"Component Availability" on page 115.
Using the VTS Status selection	"Using the Status Pull-Down" on page 109.
Using the Performance Statistics selection	"Performance Statistics" on page 119.
Displaying Accessor Mounts per Hour	Figure 70 on page 122.
Using the VTS Active data selection	"VTS Active Data" on page 123.
Using the VTS Data flow selection	"VTS Data Flow" on page 125.
Using the VTS Mount hit data selection	"VTS Mount Hit Data" on page 126.

Table 6. Quick Reference to Advanced Operating Procedures (continued)

<b>Task</b>	<b>Reference</b>
Using the VTS Physical device mount history selection	"VTS Physical Device Mount History" on page 128.
Using the VTS Logical mounts per hour selection	"VTS Logical Mounts Per Hour" on page 129.
Using the VTS Active Data Distribution selection	"VTS Active Data Distribution" on page 130.
Using the System Summary window	"Using the System Summary" on page 131.
Requesting LAN status	"LAN Status" on page 135.
Displaying the Dual Active Accessor Boundary	"Dual Accessor Zones" on page 136.
Using the Queues pull-down	"Using the Queues Pull-Down" on page 137.
Using the Database pull-down	"Using the Database Pull-Down" on page 139.
Searching the database for volumes	"Search Database For Volumes" on page 139.
Using the Search Entry Field selection	"Search Criteria" on page 140.
Using the Flag selection	141.
Using the Search Results selection	"Search Results" on page 142.
Using the Displaying Search Results selection	"Displaying Search Results" on page 143.
Find a logical volume's home	"Find Logical Volume's Home" on page 144.
Using the List Database Volumes selection	"List Database Volumes" on page 145.
Using the Stacked Volume Map Selection	"Stacked Volume Map" on page 150.
Using the Commands pull-down	"Using the Commands Pull-Down" on page 152.
Scheduling drive cleaning	"Schedule Cleaning" on page 155.
Ejecting a cleaner cartridge	"Eject a Cleaner Cartridge" on page 158.
Changing cleaner masks	"Cleaner Cartridge Masks" on page 158.
Sending a message to a host console	"Send Message to Host Consoles" on page 159.
Promoting a command in the queue	"Promote a Command in the Queue" on page 160.
Setting volser ranges	"Volser Range for Media Types" on page 161.
Inserting logical volumes	"Insert VTS Logical Volumes" on page 163.
Ejecting stacked volumes	"Eject a VTS Stacked Volume" on page 165.
Setting VTS category attributes	"Set VTS Category Attributes" on page 166.
Setting VTS management policies	"Set VTS Management Policies" on page 167.
Manage Unassigned Volumes	"Manage Unassigned Volumes" on page 202.
Manage Import Volumes	"Manage Import Volumes" on page 204.
Manage Insert Volumes	"Manage Insert Volumes" on page 205.
Manage Export-Hold Volumes	"Manage Export-Hold Volumes" on page 206.

Table 6. Quick Reference to Advanced Operating Procedures (continued)

<b>Task</b>	<b>Reference</b>
Cancel Export/Import	"Cancel Export/Import" on page 207.
Inventorying new storage or re-inventorying the complete system	"Inventory New Storage or Re-inventory Complete System" on page 169.
Disabling the inventory update	"Disable Inventory Update" on page 176.
Enabling the inventory update	"Enable Inventory Update" on page 177.
Performing the inventory update (Full)	"Perform Inventory Update (Full)" on page 177.
Performing the inventory update (Partial)	"Perform Inventory Update (Partial)" on page 179.
Setting up a stand-alone device	"Stand-Alone Device" on page 180.
Resetting a stand-alone device	"Reset Stand-Alone Device" on page 182.
Checking the status of a stand-alone device	"Stand-Alone Device Status" on page 183.
Inserting unlabeled cartridges	"Insert Unlabeled Cartridges" on page 184.
Adding a LAN host	"Add LAN Host" on page 185.
Deleting a LAN host.	"Delete LAN Host" on page 190.
Updating LAN host information	"Update LAN Host Information" on page 191.
Requesting LAN host information	"LM LAN Information" on page 198.
Performing operator interventions	"Operator Intervention" on page 199.
Changing the system administrator password	"System Administrator Password" on page 200.
Enable/Disable Service Access	"Service Access" on page 208.
Starting SNMP	"Starting SNMP" on page 212.
Stopping SNMP	"Stopping SNMP" on page 212.
Changing SNMP trap destinations	"Configuring SNMP Trap Destinations" on page 210.
Selecting SNMP trap types	"Selecting SNMP Trap Types" on page 209.
Sending a TESTM trap	"Sending TESTM Messages" on page 213.
Using the Options pull-down	"Using the Options Pull-Down" on page 226.
Using Manual mode	"Using Manual Mode" on page 227.
Starting Manual mode	"Starting Manual Mode" on page 228.
Operating in Manual mode	"Operating in Manual Mode" on page 230.
Mounting cartridges in Manual mode	"Mounting Cartridges" on page 231.
Demounting cartridges in Manual mode	"Demounting Cartridges" on page 232.
Inserting cartridges in Manual mode	"Inserting Cartridges" on page 232.
Ejecting cartridges in Manual mode	"Ejecting Cartridges" on page 234.
Reviewing unknown volume locations in Manual mode	"Reviewing Unknown Volume Locations" on page 235.
Handling error processing in Manual mode	"Error Processing" on page 236.
Locating and identifying home cell locations in Manual mode	Figure 148 on page 238.
Ending Manual mode	"Ending Manual Mode" on page 238.

Table 6. Quick Reference to Advanced Operating Procedures (continued)

Task	Reference
Removing a cartridge from the gripper	"Cartridge Removal from the Gripper" on page 239.
Using the keyboard template	"Using the Keyboard Template" on page 240.
Using the remote library manager console	"Chapter 7. Remote Library Manager Console Feature" on page 241.

---

## Using the Library Manager

The library manager display contains one Operator menu. The Operator menu contains all the functions needed at the operator level. Additional menus and pull-down menus are accessed through the Operator menu.

**Note:** The Service menu item listed on the **Mode** pull-down allows access to functions used by service personnel.

Within the library manager application, the primary visual and interactive components are the windows, icons, free-moving pointing device, and the various controls to select windows, size windows, make selections, and initiate actions. Not all windows contain all the items described. Figure 36 on page 89 shows these key components, and the text describes the uses of these components.

**Note:** The display panels shown are examples and may not be exactly the same as the panels displayed on your library manager display.

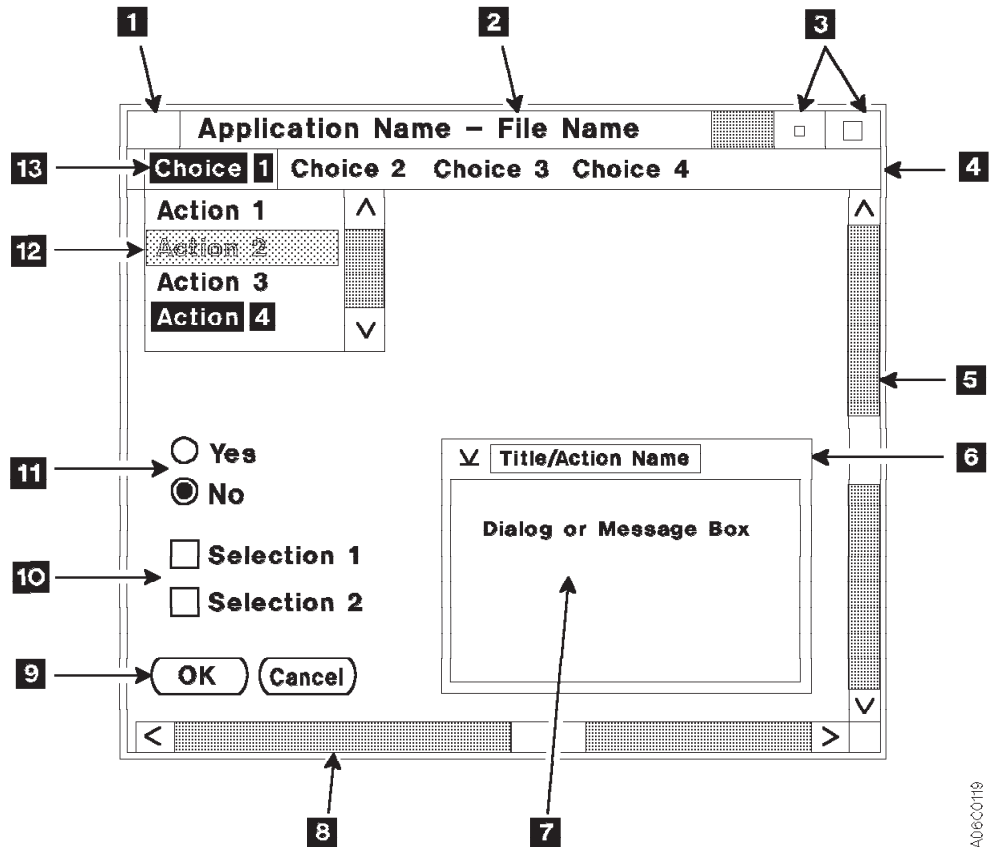

Figure 36. Operator Panel Controls

### 1 System Menu Icon

This horizontal line, when selected with a single click of the pointing device, causes a pull-down window (see Figure 37) with an expanded list of selections to be displayed. Double-clicking on this icon causes the pop-up window that contains the system menu icon to be closed (removed). See “Making Library Manager Selections” on page 92 for explanations of clicking with a pointing device.

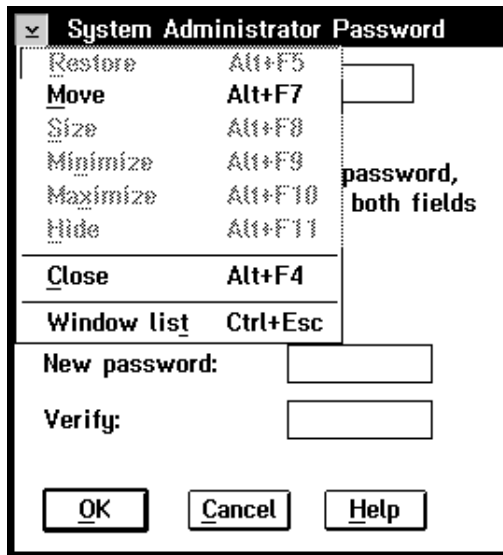

Figure 37. System Menu

## 2 Title Bar

This area, at the top of each window, contains the window title.

**Note:** By clicking on the title bar and holding down the pointing device button, the entire window can be dragged (moved) to a different location on the screen. See “Selections with the Pointing Device” on page 92 for instructions to operate the pointing device.

## 3 Window-Sizing Icons

The window-sizing icons are used as follows:

- To enlarge (maximize) the window to the full size of the screen (large square)
- To restore the window to its original size (small square with brackets)
- To minimize (to an icon) the selected window (small square) and place a predefined icon near the bottom of the screen

To restore the window to the screen, double-click on the icon.

**Note:** The window-sizing icons, for a particular window, may be hidden if one or more additional windows are expanded to cover the desired window. You can close the overlaying windows to gain access to the desired window, or you can click on any part of the desired window.

## 4 Sizeable-Window Border

By using the pointing device, a vertical border can be moved in or out to decrease or increase the width of the window. A horizontal border can be moved up or down to decrease or increase the height of the window.

## 5 Vertical Scroll Bar

The scroll bars are used to move additional, unseen information into view on the screen. By clicking on the up or down scroll bar arrows, current information can be scrolled (moved) vertically off the screen and new information scrolled vertically on to the screen.

The bold (dark colored) portions of the scroll bars show whether, and how much, information is available to be displayed. Typically, these areas are not bold. They are of a lighter color than the slider box. A slider box (the



unshaded part of the scroll bar) shows the position and the size of the visible information in relation to the information that is available. As the window is scrolled, the upper and lower bold bars change size to reflect the amount of information that is available for display in both up and down directions. All available information is visible if no slider box is shown.

#### **6 Non-Sizeable Window Border**

A non-sizeable window border cannot be used to increase or decrease the size of the window.

#### **7 Dialog or Message Box**

Dialog and message boxes are displayed when the application needs additional information, or when information is presented to the operator. Dialog and message boxes can also include radio buttons, check boxes, and push-buttons to allow the operator to respond to an application.

#### **8 Horizontal Scroll Bar**

The scroll bars are used to move additional, unseen information into view on the screen. By clicking on the left or the right scroll bar arrows, current information can be scrolled (moved) horizontally off the screen and new information scrolled horizontally on to the screen. The bold (dark colored) portions of the scroll bars show whether, and how much, information is available to be displayed. Typically, these areas are not bold. They are of a lighter color than the slider box. As the window is scrolled, the left and the right bold bars change size to reflect the amount of information that is available for display in both directions.

#### **9 Push buttons**

Push buttons allow the operator to select a particular action, which occurs immediately. The ellipsis (...) following a menu item indicates that a pop-up window will be opened if that item is selected.

#### **10 Check Boxes**

A check box is a two-part control consisting of a square box and text. Unlike radio buttons, one or more boxes can be selected. To select a check box, place the pointing device on the box and click. The box is marked with an X to show that it was selected. Click on the text again to cancel the choice.

#### **11 Radio Buttons**

Radio buttons allow the operator to choose between two or more possible responses or actions. Only one choice is allowed within any set of radio buttons. If a second choice is made, the first choice is cancelled. The action selected by the radio button typically occurs after all screen selections are made and a push-button is selected to initiate the actions.

#### **12 Pull-Down Menu**

Pull-down menus are an expansion of an action bar item. The pull-down is displayed when the corresponding action bar item is selected. The ellipsis (...) following a menu item indicates that a pop-up window will be opened if that item is selected. A right-pointing triangle (▶) at the right of a selection item indicates that this selection has an associated hidden pull-down that will be displayed if the item is selected.

Click on the desired action to highlight the item. If a line item is reduced in contrast (dimmer) from other items (Action 2 in Figure 36 on page 89), the item is not available for selection.

### **13** Action Bar

The action bar is the primary window containing keywords that, when selected, cause a pull-down window to be displayed.

Click on the desired action to highlight the item. If a line item is dimmed, the item is not available for selection.

---

## Making Library Manager Selections

You can make selections from the action bar of the Operator menu, with choices from the pull-down menus, or by active radio buttons, check boxes, and push-buttons. Although you can use either the keyboard or the pointing device to make your choices, the pointing device is the preferred method for ease of use.

### Selections with the Keyboard

You can use the keyboard to make selections instead of using the pointing device.

1. Activate the Operator (or main) menu action bar by pressing Ctrl+F10.
2. Highlight the item by using one of the following methods:
  - Use the cursor arrow keys to highlight the desired item.
  - Key in the underlined letter of the desired item, which is usually the first letter in the item.
3. Press the Enter key.

The panel for the selected item is then displayed.
4. Return to the Operator menu action bar by pressing the Esc key.
5. Press the Esc key a second time to deactivate the Operator menu action bar.

Figure 38 on page 93 shows the commonly used keys.

**Note:** Some actions prompt for confirmation before actual selection occurs. Confirmation is typically done by pressing the Enter key or selecting an OK or a Yes push button.

### Selections with the Pointing Device

There are two types of keyboard available. One has a trackball pointing device, as shown in Figure 38 on page 93. The other has a red button (trackpoint) in the middle of the keyboard as shown in Figure 39 on page 94.

The pointing devices are used to select items on the display, and actions are taken by using the accompanying buttons.

To select items by using the trackball pointing device, do the following:

1. Rotate the ball **5** to position the pointer on the object.
2. Press and quickly release button **1**. This action selects an object and is referred to as clicking on an object.
3. Press and quickly release button **1** twice to initiate the selected item. This action is referred to as double-clicking on an object.

To select and move an object on the screen, do the following:

1. Rotate the ball **5** to position the pointer on the object.

2. Click on the object using button **2** or **4** to select and lock the pointer on the object.
3. Rotate the ball to move the object. This action is also referred to as dragging an object.
4. Release the object by pressing either button.

**Note:** The object may also be moved by holding down button **1** or button **3** while moving the ball and then releasing the button when the object is positioned as desired.

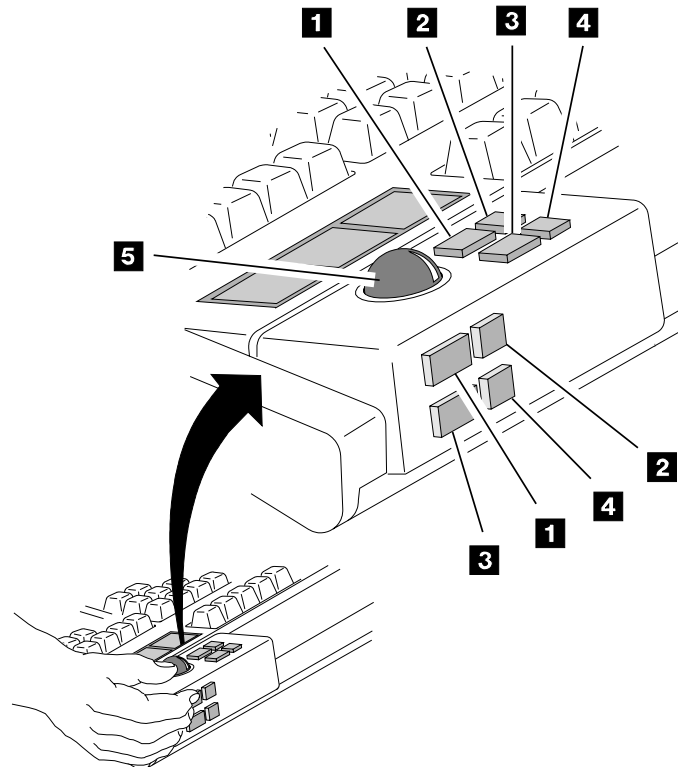
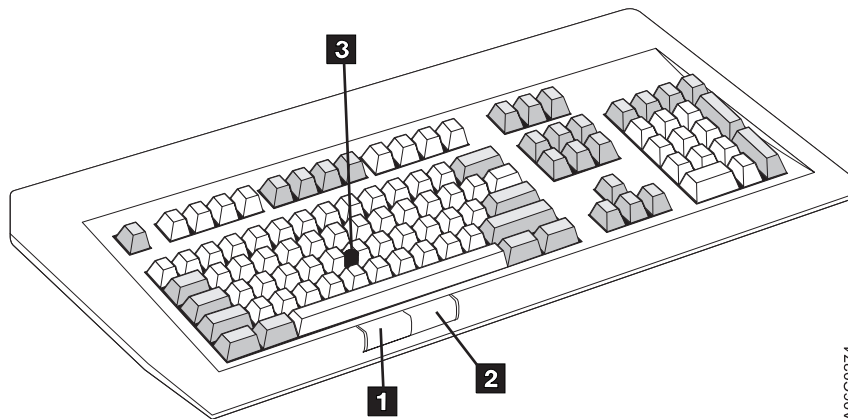

Figure 38. Pointing Device

## Track Pointer Keyboard

To select items using the Track Pointer keyboard, do the following:

1. Gently press the track point (**3** in Figure 39 on page 94) in the direction you desire the pointer to move and position the pointer on the object.
2. Press and quickly release button **1** in Figure 39 on page 94. This action selects an object and is referred to as “clicking on an object”.
3. Press and quickly release button **1** in Figure 39 on page 94 twice to initiate the selected item. This action is referred to as “double-clicking on an object”.



A06C0274

Figure 39. Track Pointer Keyboard

To select and move an object on the screen, do the following:

1. Gently press the trackpoint ( **3** in Figure 39) to position the pointer on the object.
2. Press and hold button **1** in Figure 39 down.
3. Gently press the trackpoint ( **3** in Figure 39) to move the object. This action is also referred to as “dragging an object”.
4. Release the object by releasing button **1** .

**Note:** Button **2** in Figure 39 is not used.

## Using the Help Pull-Down

The help facility provides additional information for using the various items on the panels. To get help for an action bar item, pull-down menu item, or pop-up window, use the pointing device to click on the help action bar item or, from the keyboard, highlight the field or item and press F1. The help panel displayed gives a brief description of the item or field.

A help selection also appears on the action bar of the Operator menu. This selection is made in the same way as any other selection. Figure 40 shows the Help pull-down.

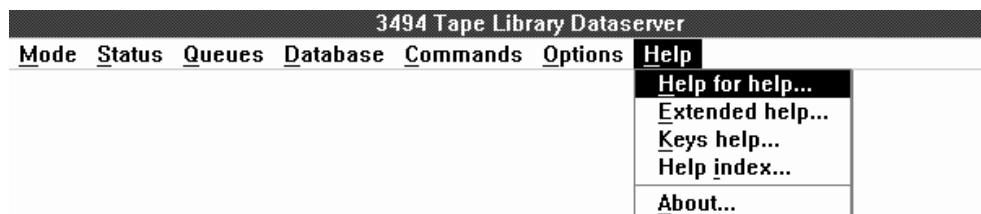

Figure 40. Help Pull-Down Menu

The Help pull-down menu includes the following additional choices:

### Help for help

Explains the content and how to use the other help choices.

### Extended help

Provides general information about the Operator menu. Click on Extended help from the Help pull-down menu (or select and press Enter). You can also press F2 from within a help window.

### Keys help

Displays a list of key assignments available. Click on Keys help from the Help pull-down menu (or select and press Enter). You can also press F9 from within a help window.

### Help index

Provides an alphabetic list of items along with a search capability of all the help information in the application. See Figure 41. You can press F11 or Shift+F1 from within a help window to view this list.

**About** Displays the library manager copyright notice and version, and the operating system version.

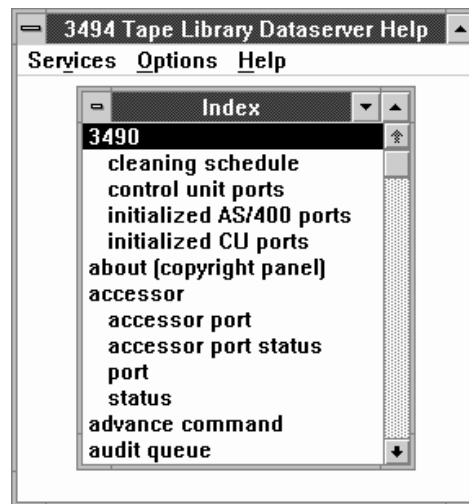

Figure 41. Help Index Pop-Up Window

## Help Search

To search the list of help topics, do the following:

1. Click on **Search** from the **Services** pull-down menu (or select and press Enter).

**Note:** The Services menu is available under any of the Help pull-down panels.

2. Type the word or phrase in the **Search** field (case is ignored).
3. Click on the desired search pattern, for example, the **Index** radio button. On the keyboard, use the tab keys to move between the radio button and the push-button groups, and then highlight the desired search pattern by using the cursor arrow keys.
4. Click on **Search** or select and press Enter.

## Help Action Bar and Function Keys

The following action bar choices are always available:

## Services

Search through the help windows.

## Options

Expand or contract the list of available help windows or display the list of help windows you have viewed during the session.

**Help** Provide help to use the Help facility.

If you select **Contents** from the Options pull-down menu, the contents window appears. This window lists all the available help topics. A plus sign (+) next to a topic indicates that additional entries are available for that topic. Click on the plus sign to see the complete list. If you are using a keyboard, press the Up or Down arrow key to highlight the topic and then press the + key.

Words and phrases that are highlighted indicate that help is available for that topic. Highlighting can be words in reverse text (text with white letters on a black background) or words set off in a different color. To select, move the pointing device arrow to the reverse text topic and double-click. (See "Selections with the Pointing Device" on page 92 for instructions to use the pointing device to make selections.) To make a keyboard selection, tab to the highlighted word and press Enter. (See "Selections with the Keyboard" on page 92 for instructions to use the keyboard to make selections.)

If you want to view a topic, double-click on the topic (or select and press Enter). After selecting a topic, the information for that topic appears in a window. The topic title appears at the top of the window to remind you of the topic being viewed.

To close a help window, press the Esc key. The previous help topic appears if one is available. If not, the previous window appears.

To exit the Help facility without viewing previous help topics, click on **Close** from the system menu pull-down menu, press Ctrl+F4, press Alt+F4, press Esc, or double-click on the system menu icon.

**Note:** When two keys are joined with +, for example, Ctrl+F4, press and hold Ctrl, press F4, and then release F4 and Ctrl.

You can also move the pointing device arrow to the – sign in the upper left-hand corner of the help window and double-click with the pointing device button. (See "Selections with the Pointing Device" on page 92 for instructions to use the pointing device to make selections.)

## Key Functions

The following keys are available for use with the library manager:

- F1** Displays the help window.
- F2** Displays extended help (general help information) from within the currently displayed help window.
- F3** Initiates shutdown procedures.
- F9** Displays a list of keys from within any help window.
- F10** Activates the pop-up window action bar.
- F11 or Shift+F1** Displays the Help index from within any help window.

- Ctrl+F10** Activates the Operator menu action bar.
- Ctrl+PgUp** Displays the text to the left of the window.
- Ctrl+PgDn** Displays the text to the right of the window.
- Alt+F4** Closes the window.
- Alt+F5** Restores the window to its original size.
- Alt+F7** Moves the window.
- Alt+F8** Sizes the window.
- Alt+F9** Minimizes the window on the display.
- Alt+F10** Maximizes (enlarges) the window.
- Alt+Spacebar** Cycles between the application panel and the selected pull-down menu.
- Shift+F10** Displays information about the help facility.
- Shift+Esc** Cycles between the application panel and the selected pull-down menu.
- Shift+Tab** Moves the cursor to the left among a group of choices.
- Tab** Moves the cursor to the right among a group of choices.
- Arrows** Moves the cursor among selectable choices.
- End** Causes the last selectable item in the pull-down menu to be highlighted (ready for selection).
- Esc** Cancels a pull-down menu or a system menu.
- Home** Causes the first selectable item in the pull-down menu to be highlighted (ready for selection).
- PgDn** Scrolls down one window.
- PgUp** Scrolls up one window.
- Underlined letter** Permits simplified keyboard selection by using only a single letter for an action bar or a pull-down menu item.

## Using the Operator Menu

The Operator menu (see Figure 42) is displayed after the following:

- The library manager is powered on.
- The Copyright panel is displayed.
- The Auto mode/Online state process has completed.



Figure 42. Operator Menu

The Operator menu panel consists of a title bar, an action bar, and initially, the System Summary window. See Figure 43.

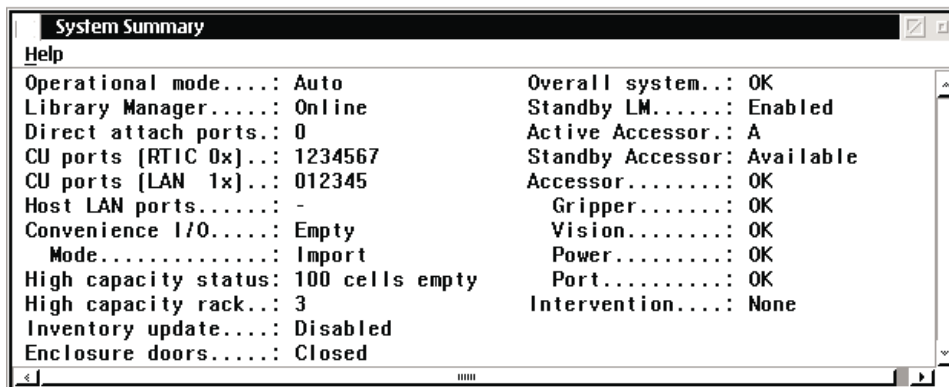

Figure 43. System Summary Pop-Up Window

You can select any of the action items from the Operator menu. When one of the action items is selected, a pull-down menu is displayed with additional information or selections.

### Selection

#### Pull-Down Menu Selections

**Mode** Allows selection of an operational mode and state (see “Using the Mode Pull-Down” on page 99).

#### Status

Displays subsystem status and statistics (see “Using the Status Pull-Down” on page 109).

#### Queues

Displays the contents of the command queues (see “Using the Queues Pull-Down” on page 137).

#### Database

Provides database search procedures for volumes (see “Using the Database Pull-Down” on page 139).

#### Commands

Provides operator commands and allows responses to intervention-required conditions (see “Using the Commands Pull-Down” on page 152).



### Options

Provides various subsystem options (see “Using the Options Pull-Down” on page 226).

### Help

Provides general help (see “Using the Help Pull-Down” on page 94).

See “Key Functions” on page 96 for a listing of the keys associated with the Operator menu.

## Using the Mode Pull-Down

Use the Mode pull-down (see Figure 44) to change the Operating mode of the 3494. The Mode pull-down shows the current Operating mode and state of the 3494 by using check marks next to appropriate line items. When you select a new mode or state, the check marks are moved to the new line items.

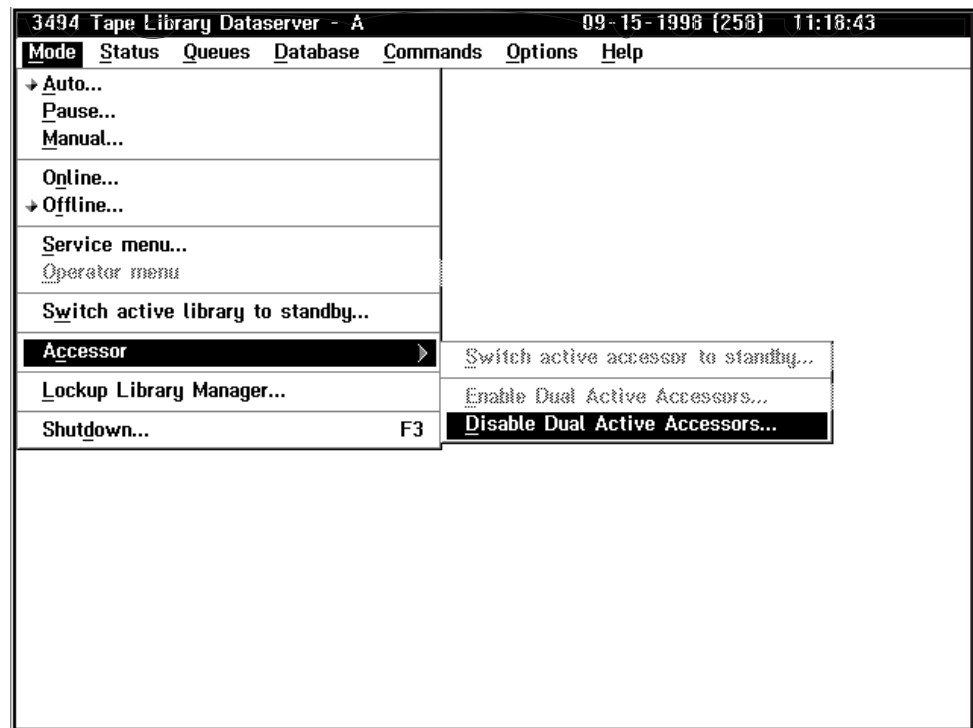

Figure 44. Mode Pull-Down Menu

The Mode pull-down selections are as follows:

**Auto** Selects automated operation. (See “Auto” on page 100.)

**Pause** Pauses cartridge accessor motion. (See “Pause” on page 100.)

### Manual

Places the 3494 in Manual mode. (See “Manual” on page 101.)

### Online

Allows the 3494 to accept host commands. (See “Online” on page 101.)

### Offline

Causes the 3494 to reject host commands. (See “Offline” on page 103.)

### Service menu

Displays the service menu. (See “Service Menu” on page 104.)

**Operator menu**

Causes the operator menu to be displayed when in service mode.

**Switch active library manager to standby**

Allows the operator to manually switch the active library to be the standby library manager.

**Accessors**

Allows the operator to manually switch the active accessor to be the standby accessor, enable dual active accessors, or disable dual active accessors.

**Lockup library manager**

Locks keyboard and display to system administrator password.

**Shutdown**

Causes the 3494 to enter the shutdown process. (See "Shutdown" on page 108.)

## Auto

Select Auto for automated operations. After confirmation of the Auto mode selection, the library manager sends all motion commands to the cartridge accessor controller.

You are prompted to confirm the selection. The confirmation step allows you to explore the list of pull-down items before you confirm the selection.

If you select **Auto** from Pause mode, cartridge accessor motion is again enabled. If selected while in Manual mode, all commands queued for the Manual mode are requeued for the cartridge accessor and the cartridge accessor's motion is enabled. The icon before **Auto** indicates that Auto mode was selected.

When the library manager is powered on and the initialization code executes successfully, Auto mode is started automatically after two minutes if the user does not intervene. The operator or service representative may want to prevent the library manager from automatically going Online and in Auto mode. A pop-up window is displayed (after the IBM logo panel display times out) that allows the user to press the Enter key and continue directly into Auto mode and Online state or select one of the following:

- Auto mode and Offline state
- Pause mode and Online state
- Pause mode and Offline state
- Manual mode and Online state
- Manual mode and Offline state

See Figure 45 on page 102 for the mode selection pop-up window.

**Note:** Auto mode and Online state is the default without user intervention.

## Pause

Select Pause mode for the cartridge accessor to move to its park position in the service area after finishing the operation in progress. Note that several commands may have to complete before the 3494 enters Pause mode. You are then prompted to confirm the selection. The icon before **Pause** indicates that Pause mode was selected.

The library manager continues to accept commands from the host. The commands are either performed (immediate non-motion, non-mount commands) or queued (motion commands) if the 3494 is Online.

The System Summary window contains the operational mode status and displays **Pause Pending** from the time that **Pause** is requested until the time that the cartridge accessor is stopped. When the cartridge accessor is stopped, the System Summary window displays **Pause**.

Use Pause mode when you want to stop all cartridge accessor motion in an orderly manner (usually to open a front door).

To resume cartridge accessor motion, select **Auto** from the Mode pull-down menu.

**Note:** If you are in Pause mode and you want to go to the Offline state, you must go to either Auto mode or Manual mode. From either of these modes (selected from the Pause/Offline Pending pop-up window), you can complete the transition to the Offline state. This process allows the 3494 to handle all pending host commands before going to the Offline state.

## Manual

Use Manual mode when the cartridge accessor is out of service. In Manual mode, the library manager console displays all mount and eject requests. The display also shows the cartridge volser, the tape library drive number, and the location of the cartridge.

When selected, the mode changes from Auto or Pause mode to Manual mode. You are prompted to confirm the selection. The icon before **Manual** indicates that Manual mode was selected. The cartridge accessor is automatically parked in the home position. The library manager then directs motion commands to the Manual mode window instead of to the cartridge accessor.

See "Using Manual Mode" on page 227 for a complete description of the Manual mode operating procedure.

## Online

Selecting Online causes the library manager to send a message to all attached 3490E/3590 and Virtual Tape Servers to indicate that the library manager is Online. If Online is selected and the library manager is already Online, the selection is ignored and no messages are sent to the attached control units. The pop-up window indicates **Online Pending** while the library manager is in the process of going Online.

You are prompted to confirm the selection. The select button in front of **Online** indicates that the Online state was selected.

When the library manager is powered on and after all the initialization code executes successfully, Auto mode and Online state starts automatically after a two-minute delay if the user does not intervene. The operator or service personnel may want to prevent the library manager from automatically going Online and in Auto mode. A pop-up window is displayed (after the IBM logo panel display times out) that allows you to press the Enter key and continue directly into Auto mode and

Online state or to make a selection. Selections that are not possible are disabled (dimmed). See Figure 45.

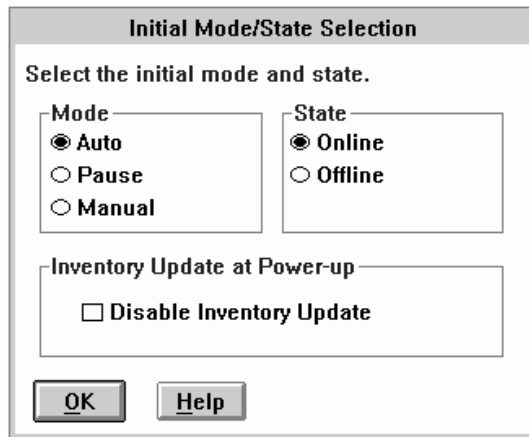

Figure 45. Initial Mode/State Selection Pop-Up Window

While in Online mode, the library manager is capable of receiving, queueing, and executing commands from attached hosts.

Whenever the Library Manager is brought Online, a check for Fast Ready Categories is made. If the library has a VTS installed and there are no Fast Ready Categories defined, a warning message is displayed (see Figure 46). The message simply warns that at least one Fast Ready Category should be defined. The warning message is automatically removed after one minute if the OK button is not selected. If a VTS is not installed or there are Fast Ready Categories defined, no warning message is displayed. See "Set VTS Category Attributes" on page 166 for information on setting Fast Ready Categories.

**Note:** Notify your system administrator if you see this message.

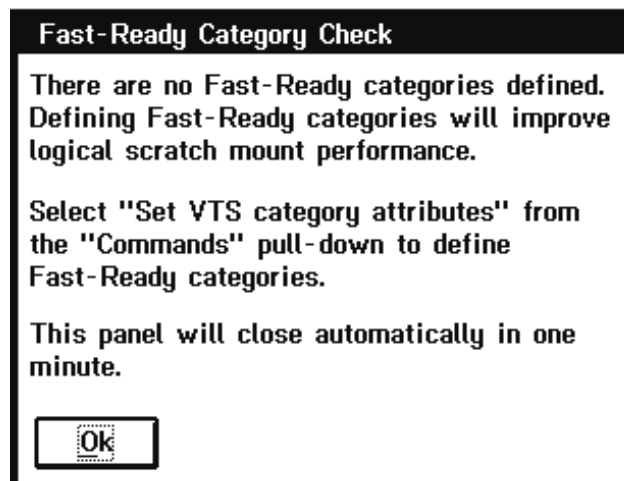

Figure 46. Fast-Ready Category Check Pop-Up Window

## Offline

Select Offline for the cartridge accessor to complete all queued requests. No additional requests are accepted. During the processing of queued requests, the 3494 is in the Offline Pending state. If Offline is selected and the library manager is already Offline, the selection is ignored and no messages are sent to the attached hosts. The pop-up window indicates **Offline Pending** while the library manager is in the process of going Offline.

You are prompted to confirm the selection. The select button in front of **Offline** indicates that the Offline state was selected.

The Offline Request pop-up window (see Figure 47) instructs the operator to vary the library Offline and to resolve any intervention-required conditions.

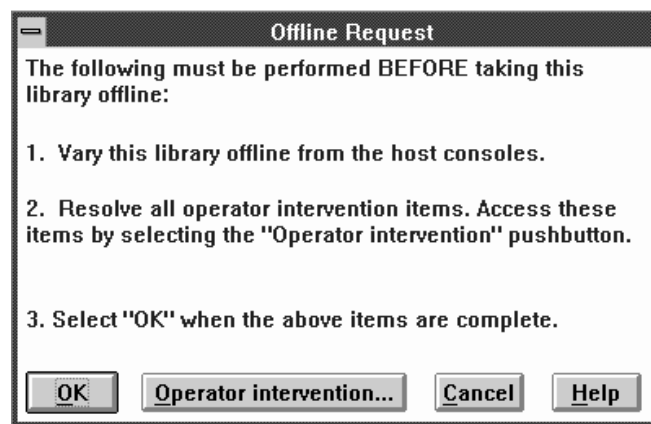

Figure 47. Offline Request Pop-Up Window

The library manager cannot go to the Offline state if an Export or an Import operation is in progress. If the operator attempts to do this, the pop-up message shown in Figure 48 on page 104 will be displayed alerting the operator to do one of the following:

- Wait for the operation to complete.
- Cancel the operation from the host.
- Cancel the operation by selecting "Cancel VTS Export/Import" from the Commands/System Management pulldown.

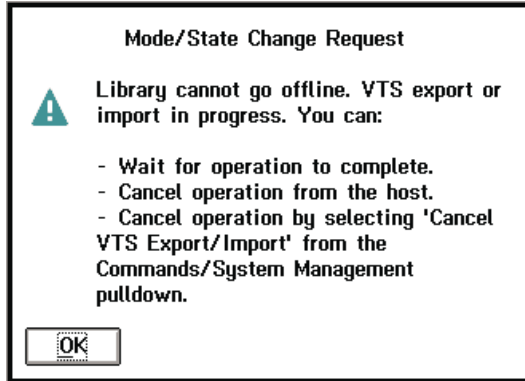

Figure 48. Mode/State Change Request Pop-Up Window

If no intervention-required conditions exist, the instruction is reduced in contrast (dimmer) from other items. The Offline Request pop-up window has the following controls:

**OK** This selection continues the Offline process.

**Operator intervention**

If enabled, this selection takes the operator to the Operator Intervention pop-up window.

**Cancel**

This selection cancels the Offline request and leaves the library in the Online operational state.

**Help**

This selection provides additional information to aid the operator in the Offline process.

A message is sent to all attached hosts that indicates the library manager is going Offline. When the library manager is Offline, maintenance activity can be performed, or the library manager can be powered off after shutdown is selected. See “Shutdown” on page 108.

## Service Menu

The Service menu allows the service representative, or an operator with service level authorization, access to additional service functions. This menu is active only when the Operator menu is displayed.

Typically, Service mode is password-protected. The password-protection option can be selected during installation. Figure 49 shows the service menu notice that is displayed when service mode is accessed and is not password-protected.

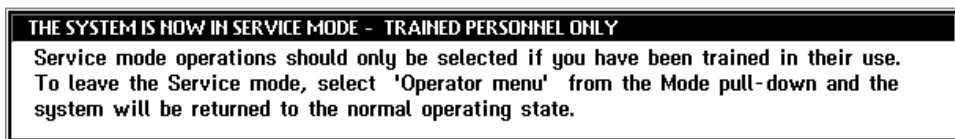

Figure 49. Service Menu Notice

## Switch Active Library Manager to Standby

**Note:** This selection is only available when the high availability model is installed and the standby library manager is enabled.

The switch active library manager to standby option allows the operator to manually switch the active library to become the standby library manager. To process the switch over, the active library manager must be offline and in pause mode. The switch takes approximately five minutes to complete. The library manager may prompt the operator for the administrator password (see Figure 50).



The image shows a dialog box titled "System Administrator Password". It contains a text input field for the "Current password". Below this, there is a message: "If you want to change the password, enter the new password in both fields below." This is followed by two more text input fields, one for "New password" and one for "Verify". At the bottom of the dialog, there are three buttons: "OK", "Cancel", and "Help".

Figure 50. System Administrator Password Pop-Up Window

The library manager then asks for the operator for confirmation before continuing with the switch over (see Figure 51).

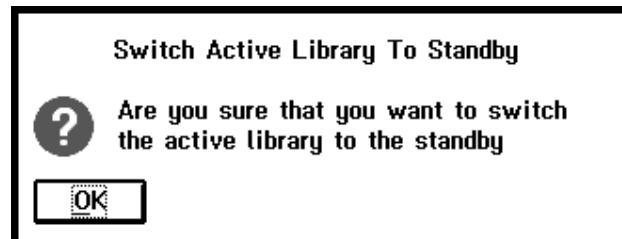

The image shows a confirmation dialog box with a thick black border. The title is "Switch Active Library To Standby". Below the title is a question mark icon in a circle, followed by the text: "Are you sure that you want to switch the active library to the standby". At the bottom of the dialog, there is a single button labeled "OK".

Figure 51. Library Switch Over Confirmation Pop-Up Window

During the switch over, the library manager displays the standby pop-up window (see Figure 52 on page 106).



Figure 52. Switching Pop-Up Window

When the system status screen is displayed, the switch over is complete.

## Accessors

### Switch Active Accessor to Standby

**Note:** This selection is only available when Model HA1 is installed.

The switch active accessor to standby option allows the operator to manually switch the active accessor to become the standby accessor. When selected, the library manager asks the operator for confirmation before continuing with the switchover (see Figure 53).

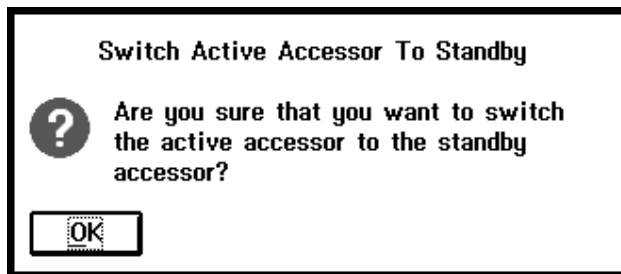

Figure 53. Accessor Switch Over Confirmation Pop-Up Window

During the switch over, the library manager displays the standby pop-up window (see Figure 54 on page 107).





Figure 54. Switching Pop-Up Window

## Enable Dual Active Accessors

**Note:** This selection is only available when the dual active accessors feature is installed.

The enable dual active accessors option allows the operator to manually enable the dual active accessors feature. When selected, the library manager displays the Dual Active Accessor Status Pop-up Window. See Figure 55.

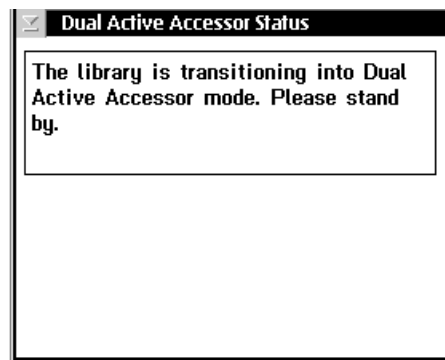

Figure 55. Dual Active Accessor Status Pop-Up Window — Enabling

## Disable Dual Active Accessors

**Note:** This selection is only available when the dual active accessors feature is installed.

The disable dual active accessors option allows the operator to manually disable the dual active accessors feature. When selected, the library manager displays the Mark Accessor Active Pop-Up Window. See Figure 56 on page 108.

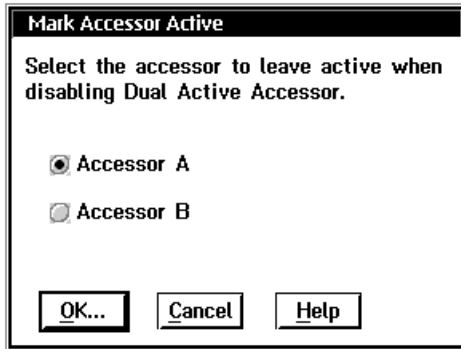

Figure 56. Mark Accessor Active Pop-Up Window

Once you select an accessor to leave active, the library manager displays the Dual Active Accessor Status Pop-Up Window. See Figure 57.

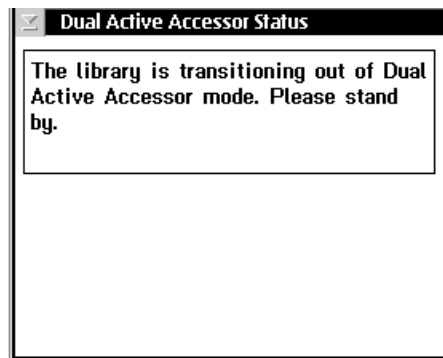

Figure 57. Dual Active Accessor Status Pop-Up Window — Disabling

## Lockup Library Manager

Locks the keyboard and display until the system administrator's password is entered.

## Shutdown

The Shutdown option prepares the library manager for the power-off procedure. If the library manager is currently in the Offline state and Pause mode, the volume database is stopped, files are closed, and the library manager program is ended. The system administrator password is required to initiate the shutdown procedures if the password option is chosen. (See "System Administrator Password" on page 200 for instructions to set the administrator password.)

Select **Shutdown** from the Mode pull-down or press the **F3** key to cause the System Administrator Password pop-up window to appear. See Figure 58 on page 109.

**Note:** This window will only appear if the password option is chosen.



Figure 58. System Administrator Password Pop-Up Window

If you select **Cancel**, the shutdown request is ended and the pop-up window is closed. If you enter a valid password and select **OK**, an **Are you sure?** query is presented. If you select **No**, the shutdown request is ended. If you select **Yes**, the shutdown panel is shown. Figure 59 displays the shutdown panel.

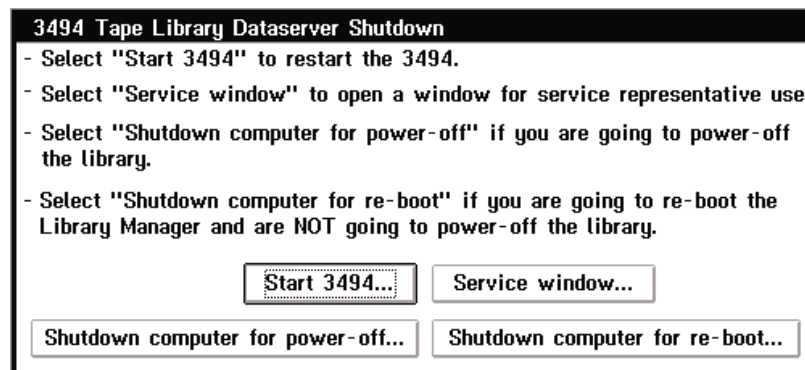

Figure 59. Shutdown Panel

## Using the Status Pull-Down

Use the Status pull-down (see Figure 60 on page 110) to display the status of the 3494.

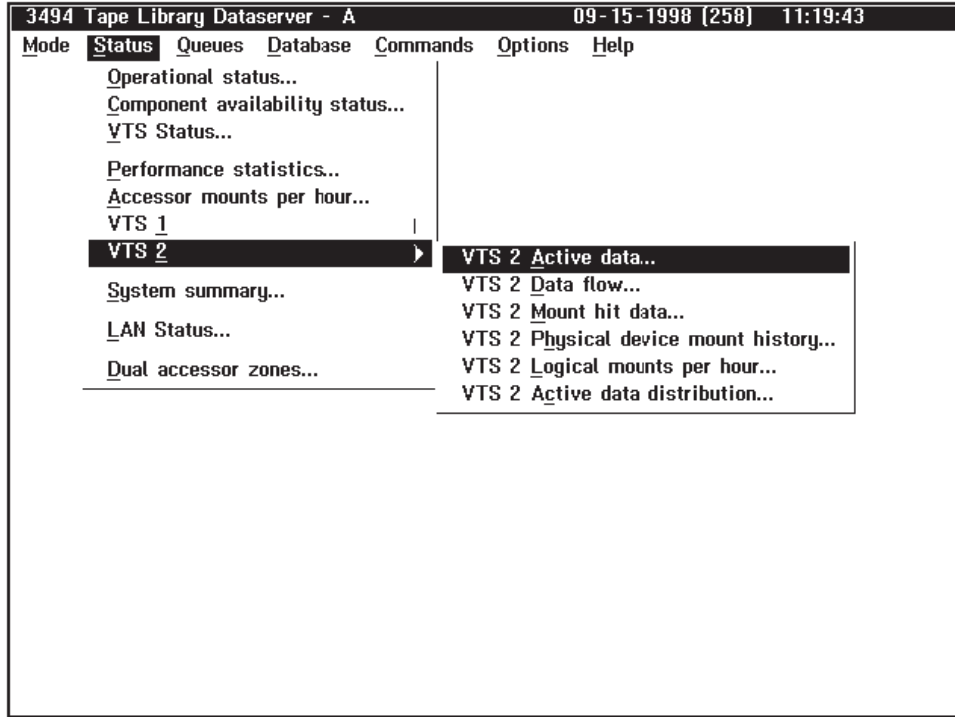

Figure 60. Status Pull-Down Menu

The Status pull-down selections are as follows:

**Operational status**

Displays the status. (See “Operational Status” on page 111.)

**Component availability status**

Displays the status. (See “Component Availability” on page 115.)

**VTS status**

Displays the status of each VTS configured in the library. (See “VTS Status” on page 118.)

**Performance Statistics**

Displays statistics. (See “Performance Statistics” on page 119.)

**Accessor Mounts per Hour**

Displays Mounts per hour for each accessor. (See Figure 70 on page 122.)

**VTS x** Allows selection of the following for each VTS, where x denotes the VTS number:

**VTS Active data**

Displays VTS Active data statistics (See “VTS Active Data” on page 123.)

**VTS Data flow**

Displays VTS Data Flow statistics (See “VTS Data Flow” on page 125.)

**VTS Mount Hit Data**

Displays VTS Mount Hit Data (See “VTS Mount Hit Data” on page 126.)

**VTS Physical device mount history**

Displays VTS Physical device Mount history (See Figure 74 on page 128.)

**VTS Logical Mounts per hour**

Displays VTS Logical Mounts per hour statistics (See "VTS Logical Mounts Per Hour" on page 129.)

**Active Data Distribution**

Displays VTS Active Data Distribution statistics (See Figure 76 on page 130.)

**System summary**

Displays subsystem status. (See "Using the System Summary" on page 131.)

**LAN Status**

Displays LAN status. (See "LAN Status" on page 135.)

**Dual accessor zones**

Displays frames serviced by each accessor. (See Figure 79 on page 136.)

## Operational Status

Figure 61 shows the top half of the Operational Status pop-up window. Figure 62 shows the bottom half of the Operational Status pop-up window for systems that only have a single accessor. Figure 63 on page 114 shows the bottom half of the Operational Status pop-up window for systems that have dual accessors.

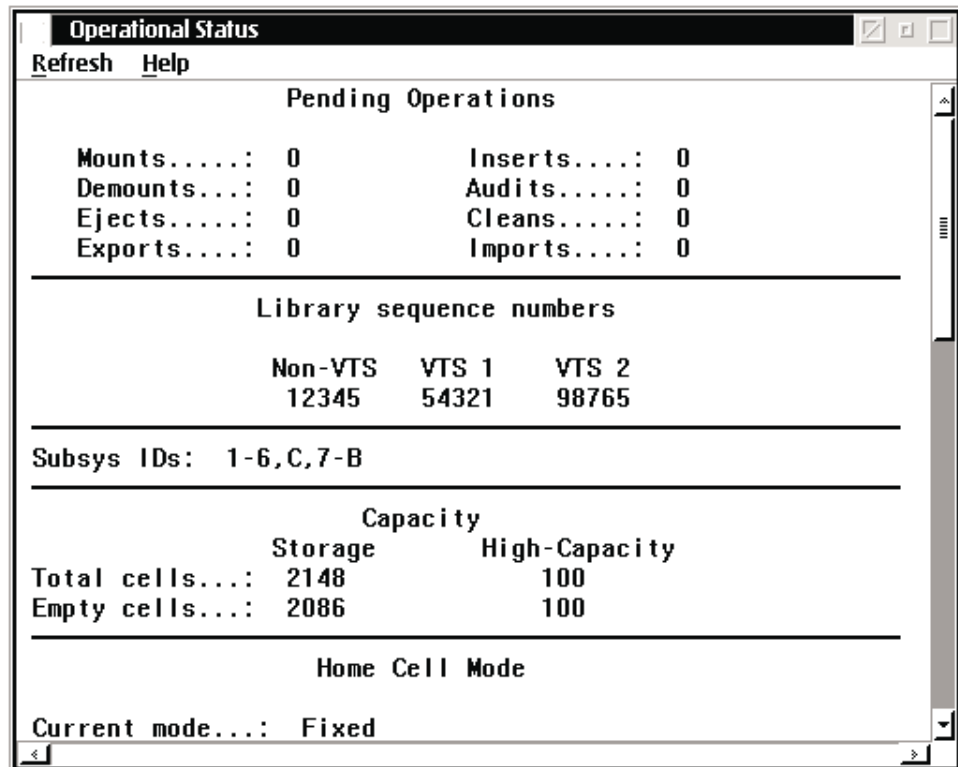

Figure 61. (Part 1 of 3) Operational Status Pop-Up Window

**Pending Operations** shows the number of pending operations for the following requests:

- Mounts and demounts
- Ejects and inserts
- Audits
- Cleans
- Exports
- Imports

When an operation is pending, it is in progress, queued, or blocked. If you need more specific information about a pending operation, select the appropriate queue. (See "Using the Queues Pull-Down" on page 137.)

**Library sequence numbers** shows the unique identification numbers for each logical library within the physical 3494. Numbers are displayed for non-VTS libraries, and for each VTS library which exists in the 3494 tape library. These numbers are assigned at the plant of manufacture and set during the teach operation.

**Tape subsystem IDs** shows the unique identification numbers for the tape subsystems installed in the 3494. The host software uses this information to determine the configuration.

**Capacity** shows the total and empty number of storage cells in the library. It also shows the total and empty number of high-capacity output facility cells.

**Home Cell Mode** shows where the accessor will return a cartridge after processing. In **Fixed** mode, the cartridge will be returned to the cell from which it was originally retrieved. In **Floating** mode, the cartridge will be returned to a cell determined by the library manager.

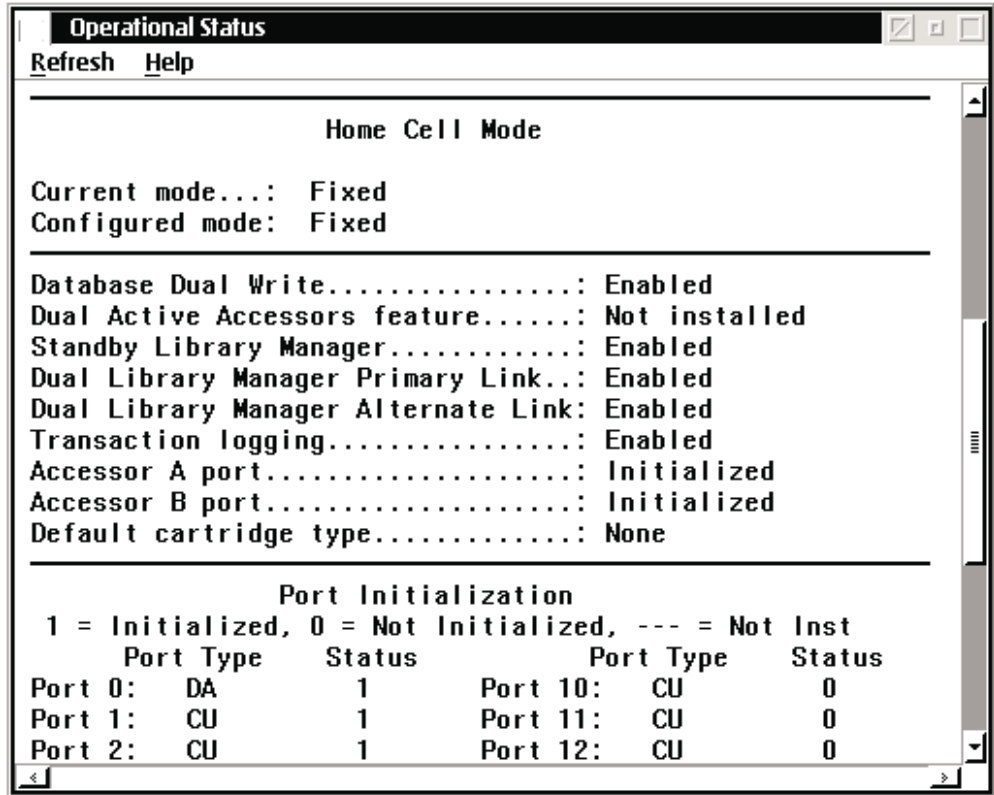

Figure 62. (Part 2 of 3) Operational Status Pop-Up Window (single accessor systems)

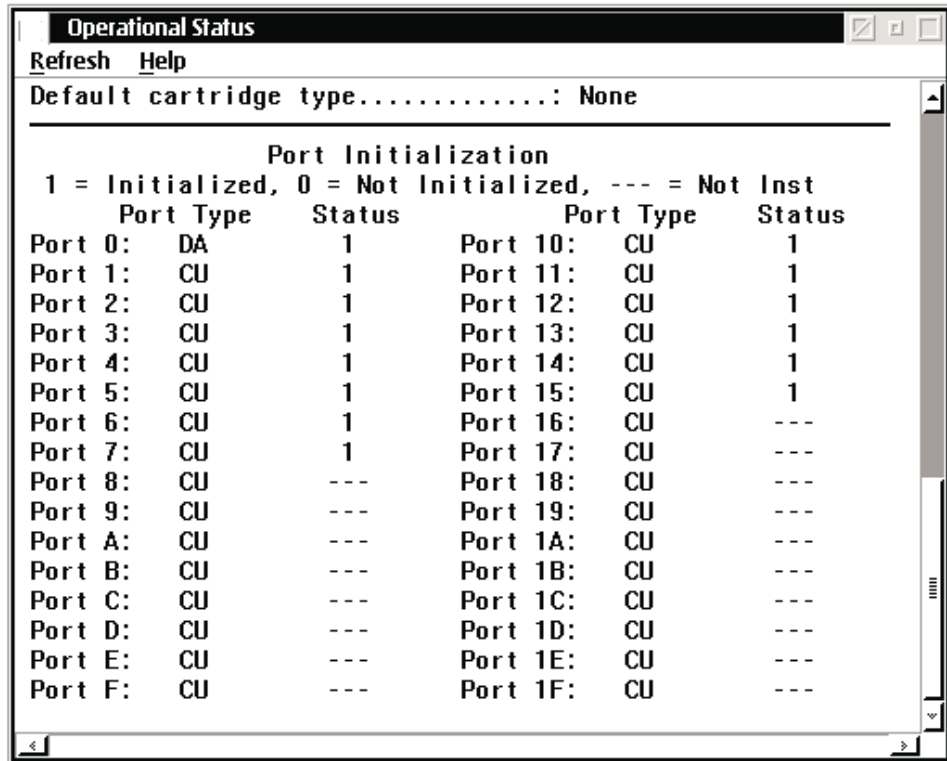

Figure 63. (Part 3 of 3) Operational Status Pop-Up Window (dual accessor systems)

**Database Dual Write** shows whether the database dual-write function is enabled. It indicates **Disabled**, **Enabled**, or **Not installed**.

**Dual Active Accessors Feature** shows the status of the dual active accessors feature. It indicates **Disabled**, **Enabled**, or **Not installed**.

**Standby Library Manager** indicates the status of the standby library manager. It indicates **Enabled**, **Disabled**, **Pending** (waiting for a database copy to complete), or **Code Update** (shut down for a code update by service personnel).

**Dual Library Manager Unit Primary Link** indicates the status of the primary communication path between the two library managers. It indicates **Enabled** or **Disabled** or **Not Installed**.

**Dual Library Manager Alternate Link** indicates the status of the secondary communication path between the two library managers. It indicates **Enabled** or **Disabled** or **Not Installed**.

**Transaction logging** shows the status of transaction logging. It indicates **Disabled** or **Enabled**.

**Accessor A Port or Accessor B Port** shows the status of the accessor port initialization. It indicates **Initialized**, **Not initialized**, **Not installed**, **Not taught** or **Not available**.

**Default Cartridge Type** shows the default cartridge type Options are **1**, **E J**, or **None**.



**Port Initialization** shows status of the tape subsystem control unit ports and direct attach ports. It indicates whether a port is a Direct Attach or Control unit port. It indicates **Initialized**, **Not initialized**, or **Not installed**.

The Operational Status window has the following pull-downs available from its action bar:

**Refresh**

Immediately refreshes or updates the contents of the window. The window is periodically refreshed; however, clicking the pointing device on the selection area of the window causes an immediate update of the window.

**Help** Provides help about the items in the window.

To close the window, select **Close** from the system menu icon (upper-left corner of the window).

## Component Availability

The library manager keeps track of which components are available so that it can make the best use of the available hardware when processing commands. When a component fails, the component is automatically marked unavailable for use. The library manager does not use the component (for example, a 3490E/3590 drive) until it is marked available via the Service menu on the library manager console.

The availability status of all the library components can be displayed on the library manager console. Availability information is kept in the library manager database so that it is not lost if the library manager is shutdown.

Drives can be marked on the library manager as available or unavailable. If a drive is available, it is available to the cartridge accessor. If the drive is marked unavailable, the drive is not available to the cartridge accessor.

**Note:** Device availability or unavailability is independent of the drive status (Online or Offline) with the host.

A drive is marked unavailable when something prevents the cartridge accessor from going to that drive, for example, the drive is being serviced. Even if no host requests are made for the drive, the library manager may try to clean a drive if it is available.

Device availability is not checked when host requests are received and validated because the drive availability can change between the time the command is accepted and the time the request is executed. If a host request is accepted and the required drive is marked as unavailable when it is time to execute the request, the request fails. Conversely, if the required drive is unavailable at request acceptance but is made available before the request executes, the request completes normally.

Figure 64 on page 116, Figure 65 on page 117, and Figure 66 on page 117 show the Component Availability Status windows.

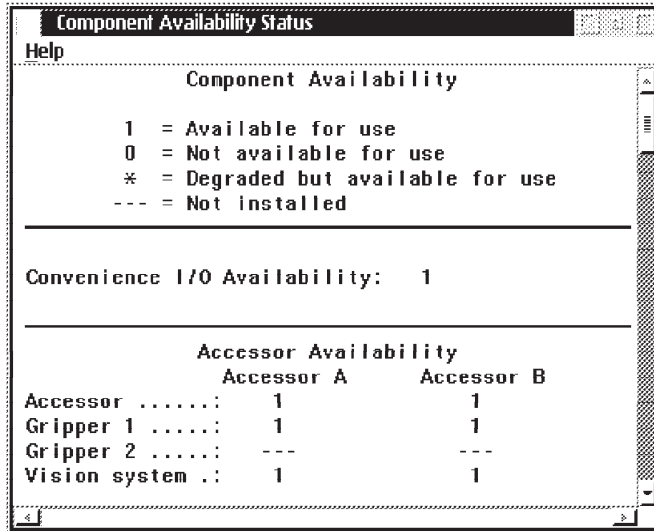

Figure 64. (Part 1 of 3) Component Availability Status Pop-Up Window

#### Convenience Input/Output Station

The station's availability is shown by 1, 0, or — — —, where 1 indicates available, 0 indicates not available, and — — — indicates not installed.

#### Cartridge Accessor

The cartridge accessor's availability is shown by 1, 0, or — — —, where 1 indicates available, 0 indicates not available, and — — — indicates not installed.

#### Grippers

Each gripper's availability is shown by 1, 0, or — — —, where 1 indicates available, 0 indicates not available, and — — — indicates not installed.

#### Vision System

The vision system's availability is shown by 1, 0, or — — —, where 1 indicates available, 0 indicates not available, and — — — indicates not installed.

Component Availability Status									
Help									
Control Unit Port and Device Availability									
Port 2		Port 3		Port 4					
1		1		1					
180	181	280	281						
1	1	1	1						
Port 5	380	381	382	383	384	385	386	387	
1	1	1	1	1	1	1	1	1	
	388	389	38A	38B	38C	38D	38E	38F	
	1	1	1	1	1	1	1	1	

Figure 65. (Part 2 of 3) Component Availability Status Pop-Up Window

Component Availability Status									
Help									
Port 6	390	391	392	393	394	395	396	397	
1	1	1	1	1	1	1	1	1	
	398	399	39A	39B	39C	39D	39E	39F	
	1	1	1	1	1	1	1	1	
Port 7									
1									
480									
1									

Figure 66. (Part 3 of 3) Component Availability Status Pop-Up Window

**Ports** Figure 65, and Figure 66 show part of the tape subsystem pictorial presentation. Subsystem 1 in the figure represents the left-most tape subsystem in the library when you face the front of the library. The control unit (CU) ports associated with that particular control unit are displayed within the box. The port's availability is shown by 1 or 0, where 1 indicates available, and 0 indicates not available.

**Devices**

Figure 65, and Figure 66 show part of the tape subsystem pictorial presentation. A drawing of each tape subsystem is displayed with the drive IDs shown for each drive. If a VTS library is installed, the virtual

subsystems are represented by a figure that looks similar to a 16 drive 3490E tape subsystem. Each subsystem is presented separately in the window. The drive availability is shown by 1, 0, ---, where 1 indicates available, 0 indicates not available, and --- indicates not installed.

The Component Availability Status window has the following pull-down available from its action bar:

**Help** Provides help about the Component Availability Status window.

To close the window, select **Close** from the system menu icon (upper-left corner of the window).

## VTS Status

Figure 67 shows the VTS Status window.

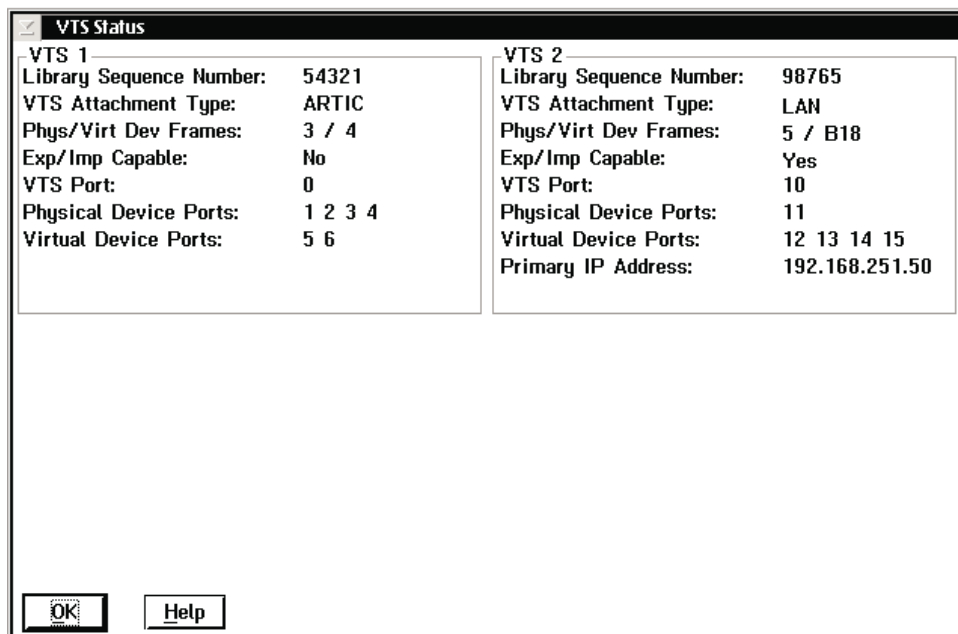

Figure 67. VTS Status Pop-Up Window

This panel displays information about the status of each VTS installed in the library. This window includes the following information for each installed VTS:

### Library Sequence Number

Displays the library sequence number of this VTS. If the VTS has the SCSI Host Attachment Feature, then '(SCSI)' will be displayed following the Library Sequence Number.

### VTS Attachment Type

There are 2 types of VTS connection to the Library Manager: ARTIC or LAN.

### Physical/Virtual Device Frame

The physical device frame is the number of the frame that contains the physical devices used by this VTS. The virtual device frame is the number of the frame that contains the VTS processor. For an ARTIC-attached VTS

this field displays the frame number. For a LAN-attached VTS, "B18" is displayed since the VTS processor is in a rack not attached to the library frames.

**Exp/Imp Capable**

If the VTS is Import/Export capable, this field will be "Yes".

**VTS Port**

This is the Library Manager port used to communicate with the VTS. For an ARTIC-attached VTS this is ARTIC port 0. For a LAN-attached VTS this is the LAN port number which starts at 0x10. If the Library Manager has initialized with the port, the port's number is displayed. If it is not initialized a dash (-) is displayed.

**Physical Device Ports**

These are the Library Manager ports used to communicate with the physical devices associated with the VTS. For an ARTIC-attached VTS there is one port for each physical drive. For a LAN-attached VTS there is only one port used to communicate with all of the VTS physical drives. If the Library Manager has initialized with a port, the port's number is displayed. If it is not initialized a dash (-) is displayed.

**Virtual Device Ports**

These are the Library Manager ports used to communicate with the virtual devices associated with the VTS. There is one port for each virtual subsystem of 16 drives. An ARTIC-attached VTS has 2 virtual subsystems. A LAN-attached VTS can have either 2 or 4 virtual subsystems. If the Library Manager has initialized with a port, the port's number is displayed. If it is not initialized a dash (-) is displayed.

**VTS Primary IP Address**

This is only displayed for a LAN-attached VTS. This is the IP address of the Library Manager which is used by the VTS processor to communicate with the Library Manager.

The VTS Status window has the following buttons:

**OK** Closes the VTS Status window.

**Help** Provides help about the VTS Status window.

## Performance Statistics

Figure 68 on page 120 and Figure 69 on page 121 show the Performance Statistics window.

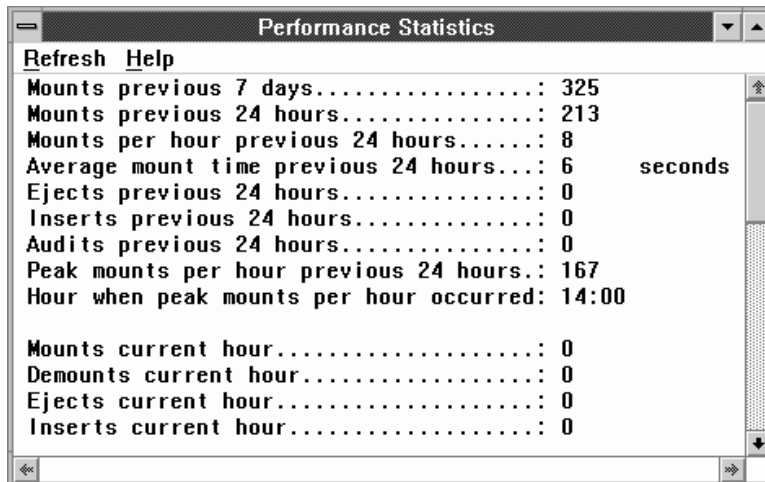

Figure 68. (Part 1 of 2) Performance Statistics Pop-Up Window

The Performance Statistics window displays the following statistics on the 3494:

- The number of mounts for the previous 7 days
- The number of mounts for the previous 24 hours
- The number of mounts per hour for the previous 24 hours
- The average mount time for the previous 24 hours
- The number of ejects for the previous 24 hours
- The number of inserts for the previous 24 hours
- The number of audits for the previous 24 hours
- The peak number of mounts per hour for the previous 24 hours
- The time when peak mounts per hour occurred
- The number of mounts during the last hour
- The number of demounts during the last hour
- The number of ejects during the last hour
- The number of inserts during the last hour
- A graph of the number of mounts per hour for the previous 24 hours

Hourly statistics are calculated on the hour (7:00, 8:00, and so on).

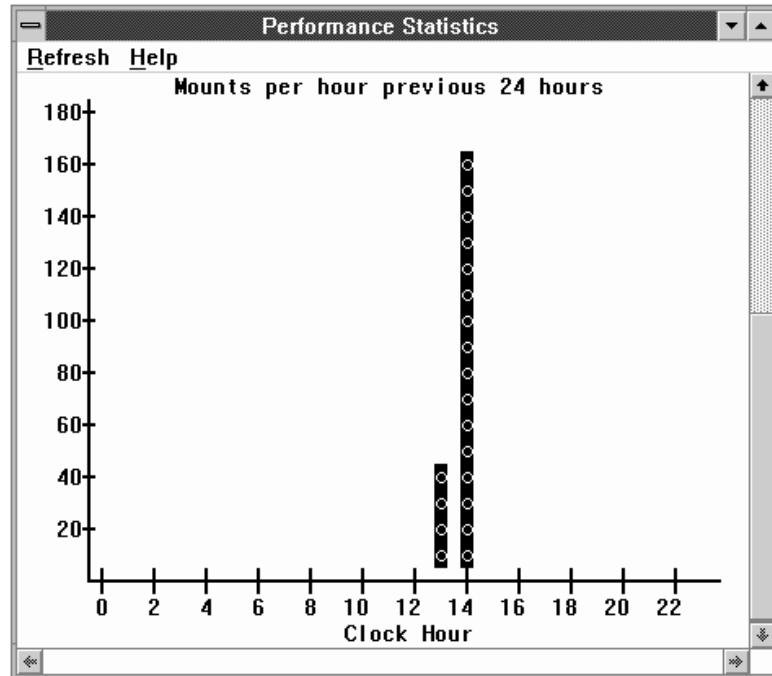

Figure 69. (Part 2 of 2) Performance Statistics Pop-Up Window

The Performance Statistics window has the following pull-downs available from its action bar:

**Refresh**

Refreshes or updates the contents of the window immediately instead of periodically (about every 30 seconds). You can also click the pointing device on the client area of the window.

**Help**

Provides help about the Performance Statistics window.

To close the window, select **Close** from the system menu icon (upper-left corner of the window).

The performance statistics reflect physical activity in the library. Commands involving VTS logical volumes are not part of these statistics.

## Accessor Mounts per Hour

Figure 70 shows the Accessor Mounts per Hour window.

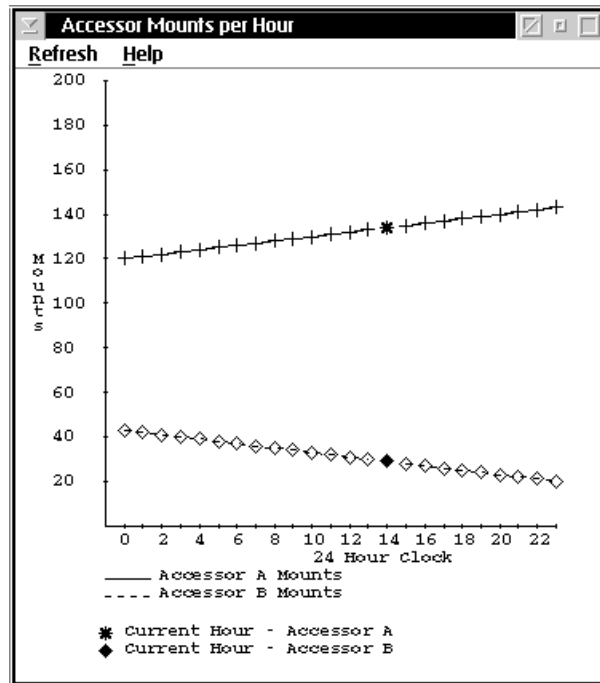

Figure 70. Accessor Mounts per Hour Pop-Up Window

The Accessor Mounts per Hour window displays a graph showing the number of mounts per hour for each accessor. Data is displayed for the previous 24 hours. The current hour's data is designated by an asterisk for Accessor A and a diamond for accessor B.

The Accessor Mounts per Hour window has the following pull-downs available from its action bar:

### Refresh

Refreshes or updates the contents of the window immediately. You can also click the pointing device on the client area of the window.

**Help** Provides help about the Accessor Mounts per Hour window.

To close the window, select **Close** from the system menu icon (upper-left corner of the window).



## VTS Active Data

The Active Data window (Figure 71) displays a graph showing the amount of active data, amount of free storage, maximum active data, and a free storage alarm level for the stacked volumes in a VTS. The data stored on stacked volumes is from the Tape Volume Cache and may be compressed when the VTS has the EHPO feature; therefore, the graphs do not represent actual host data bytes, but the compressed volume sizes as stored in the Tape Volume Cache. A separate graph is available for each VTS in the library. Data is displayed for the previous 29 days as of midnight and for the current day on an hourly snapshot.

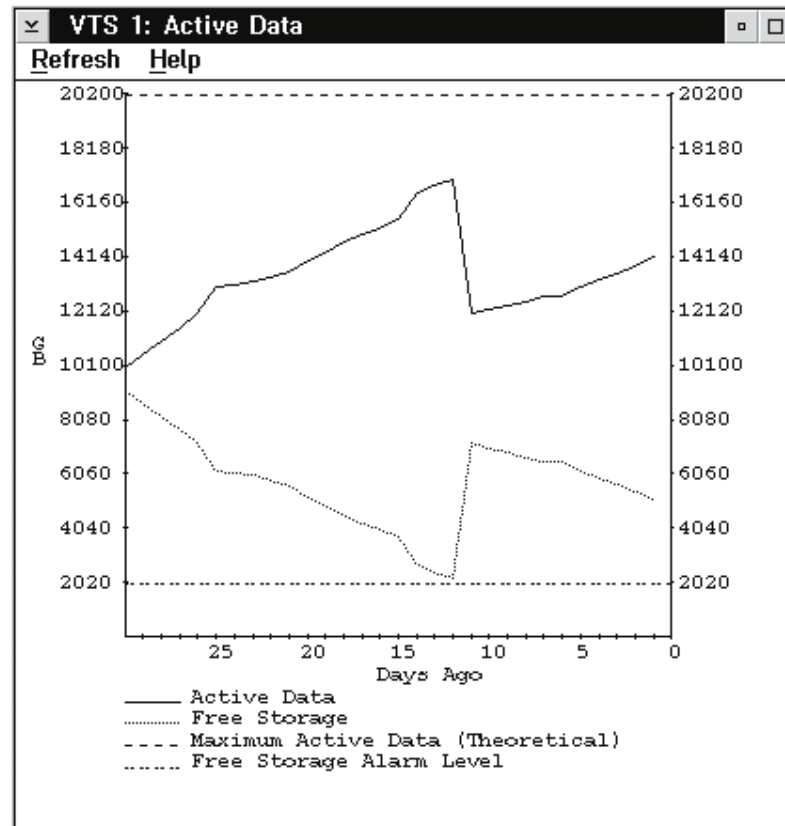

Figure 71. VTS Active Data Pop-Up Window

*Active Data* is the total size, as stored in the Tape Volume Cache, of all active logical volumes that have been copied to stacked volumes. Virtual volumes that exist in the Tape Volume Cache but have not been copied to tape are not included. Invalidated (non-active) copies of logical volumes are also not included in the graph.

*Maximum Active Data* is the total capacity of all stacked volumes that have been inserted in the VTS. For the model B16, the Maximum Active Data is a theoretical value computed by assuming that stacked volumes are filled with a 2:1 compression ratio. The model B18 uses the actual compression ratio achieved for all data copied from the Tape Volume Cache to full stacked volumes to calculate the Maximum Active Data. Because data received from enhanced ESCON host attachments has previously been compressed into the Tape Volume Cache, compression to the stacked volume from the Tape Volume Cache will be approximately 1 to 1 for the B18. Note that invalidated copies of logical volumes reduce the amount of active data you can store on the stacked volumes.

*Free Storage* is the total capacity of all empty stacked volumes in the library calculated by using a compression ratio as described for Maximum Active Data above. Partially filled stacked volumes are not included in this calculation. Free Storage gives an indication of how much data from the Tape Volume Cache can be added to stacked volumes currently in the VTS.

*Free Storage Alarm Level* is a threshold to warn you when to add more stacked volumes to the VTS library. If the number of empty stacked volumes available is less than the number of stacked volumes required to store the amount of Tape Volume Cache data specified by the Free Storage Threshold (GB), the Library Manager signals an intervention required condition to notify the operator to add more stacked volumes. You can modify the alarm threshold on the Library Manager's VTS Management Policies window. See "Set VTS Management Policies" on page 167 for more information.

The VTS Active Data window has the following pull-downs available from its action bar:

**Refresh**

Refreshes or updates the contents of the window immediately. You can also click the pointing device on the client area of the window.

**Help** Provides help about the VTS Active Data window.

To close the window, select **Close** from the system menu icon (upper-left corner of the window).

## VTS Data Flow

Figure 72 shows the VTS Data Flow window.

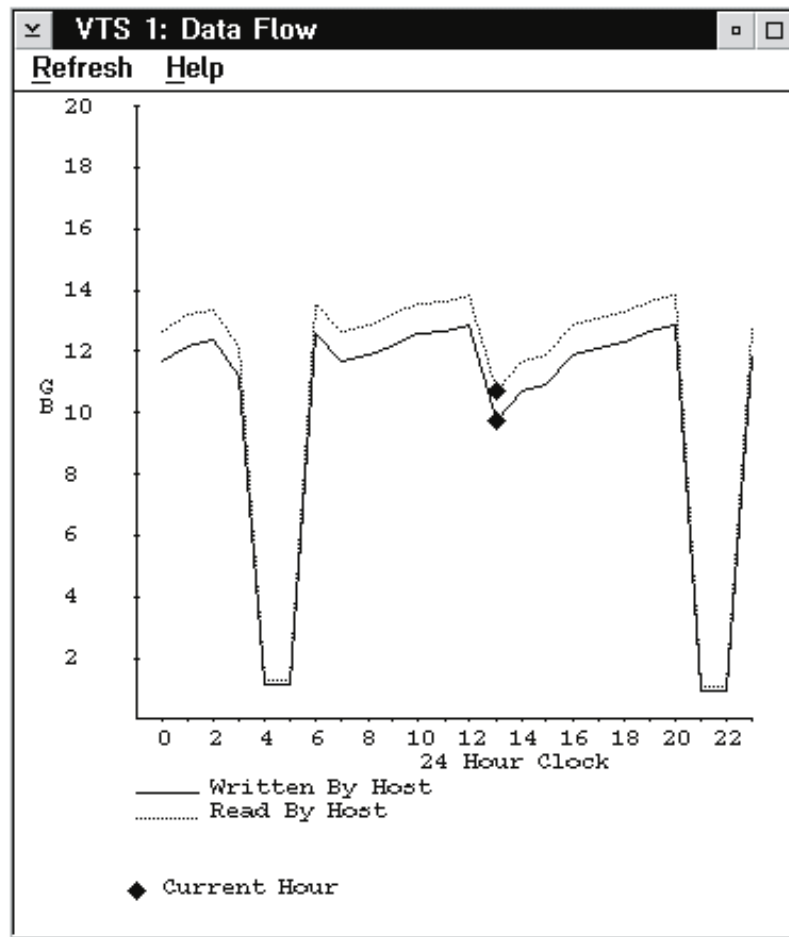

Figure 72. VTS Data Flow Pop-Up Window

The VTS Data Flow window displays a graph showing the amount of data written to and read from the channel. A separate graph is available for each VTS in the Library. Data is displayed for the previous 24 hours. The current hour's data is designated by the diamond shaped marker.

The VTS Data Flow window has the following pull-downs available from its action bar:

### Refresh

Refreshes or updates the contents of the window immediately. You can also click the pointing device on the client area of the window.

**Help** Provides help about the VTS Data Flow window.

To close the window, select **Close** from the system menu icon (upper-left corner of the window).

## VTS Mount Hit Data

Figure 73 shows the VTS Mount Hit Data window.

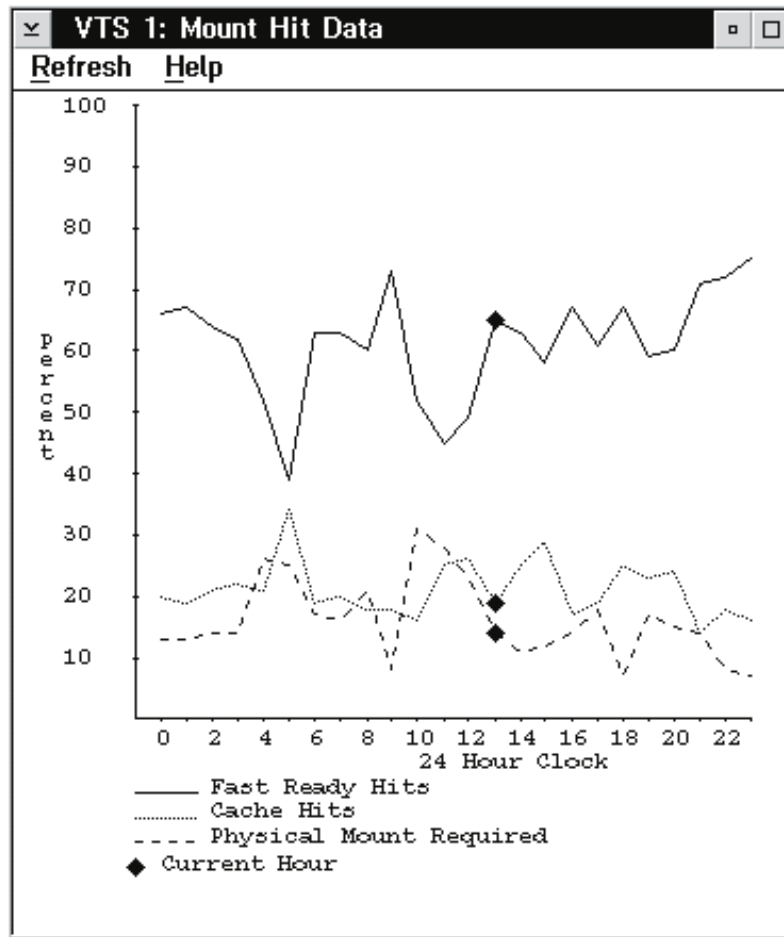

Figure 73. VTS Mount Hit Data Pop-Up Window

The VTS Mount Hit Data window displays a graph showing how logical mounts have been accomplished as a percentage of the total mounts for an hour. The three types are: Fast ready, cache hit, and logical mounts requiring a recall. A separate graph is available for each VTS in the Library. Data is displayed for the previous 24 hours. The current hour's data is designated by the diamond shaped marker.

A Fast Ready Hit is a mount that the host requested where the category of the volser was designated as a "Fast ready" category. This type of mount does not require any recall of data from tape. This is the fastest type of mount.

A Cache Hit is a mount where the volume to be mounted still resides within the VTS cache. This type of mount does not require any recall of data from tape.

A Physical Mount Required means that a stacked volume needed to be mounted and data read from it to satisfy the logical mount request. This is the slowest type of mount.

The graph displays 3 lines, one for each type of mount, as a percentage of the total number of mounts for an hour.

The VTS Mount Hit Data window has the following pull-downs available from its action bar:

**Refresh**

Refreshes or updates the contents of the window immediately. You can also click the pointing device on the client area of the window.

**Help** Provides help about the VTS Mount Hit Data window.

To close the window, select **Close** from the system menu icon (upper-left corner of the window).

## VTS Physical Device Mount History

Figure 74 shows the VTS Physical Device Mount History window.

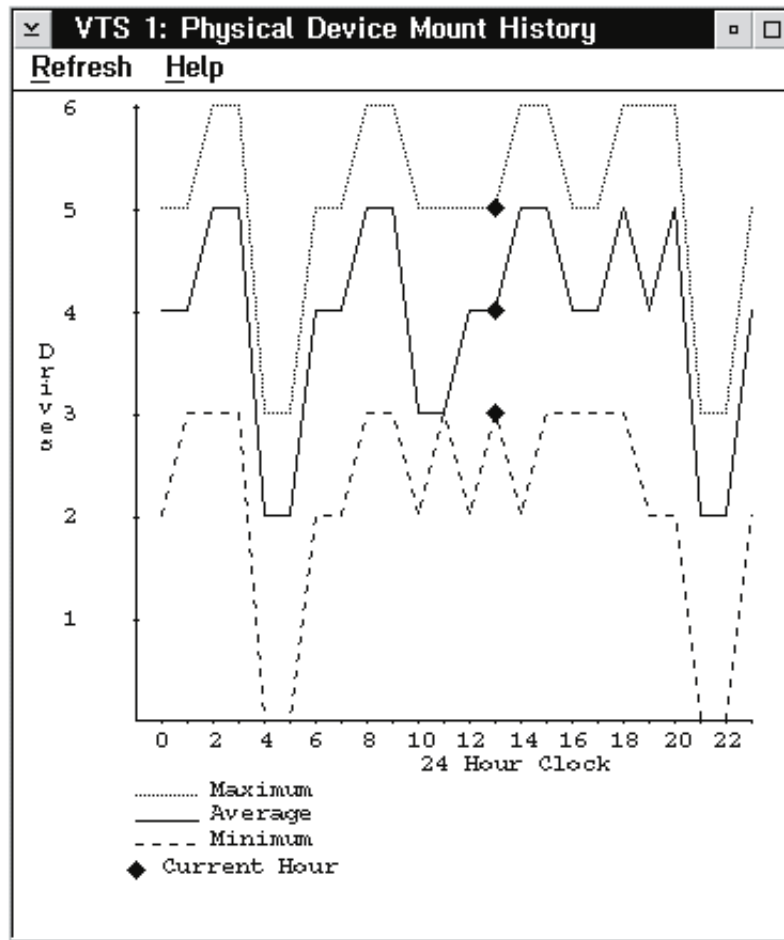

Figure 74. VTS Physical Device Mount History Pop-Up Window

The VTS Physical Device Mount History Data window displays a graph showing the minimum, average, and maximum number of physical drives used at one time to mount stacked volumes. A separate graph is available for each VTS in the Library. Data is displayed for the previous 24 hours. The current hour's data is designated by the diamond shaped marker.

This data can be used to determine if there are a sufficient number of physical drives to handle the mount workload. It can also be used to determine if the mount workload should be shifted such that the mounts requiring a recall (mounting of a stacked volume) be redistributed to other times of the day.

The VTS Physical Device Mount History window has the following pull-downs available from its action bar:

### Refresh

Refreshes or updates the contents of the window immediately. You can also click the pointing device on the client area of the window.

### Help

Provides help about the VTS Physical Device Mount History window.

To close the window, select **Close** from the system menu icon (upper-left corner of the window).

## VTS Logical Mounts Per Hour

Figure 75 shows the VTS Logical Mounts Per Hour window.

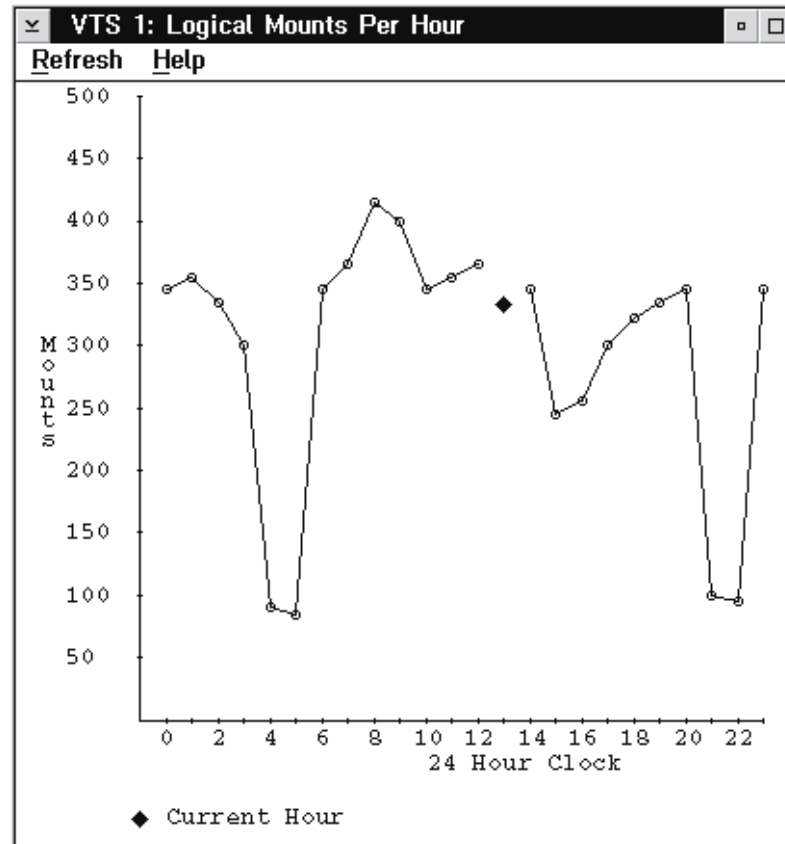

Figure 75. VTS Logical Mounts Per Hour Pop-Up Window

The VTS Logical Mounts Per Hour window displays a graph showing the number of logical mounts per hour. A separate graph is available for each VTS in the Library. Data is displayed for the previous 24 hours. The current hour's data is designated by the diamond shaped marker.

The VTS Logical Mounts Per Hour window has the following pull-downs available from its action bar:

### Refresh

Refreshes or updates the contents of the window immediately. You can also click the pointing device on the client area of the window.

### Help

Provides help about the VTS Logical Mounts Per Hour window.

To close the window, select **Close** from the system menu icon (upper-left corner of the window).

## VTS Active Data Distribution

Figure 76 shows the VTS Active Data Distribution window.

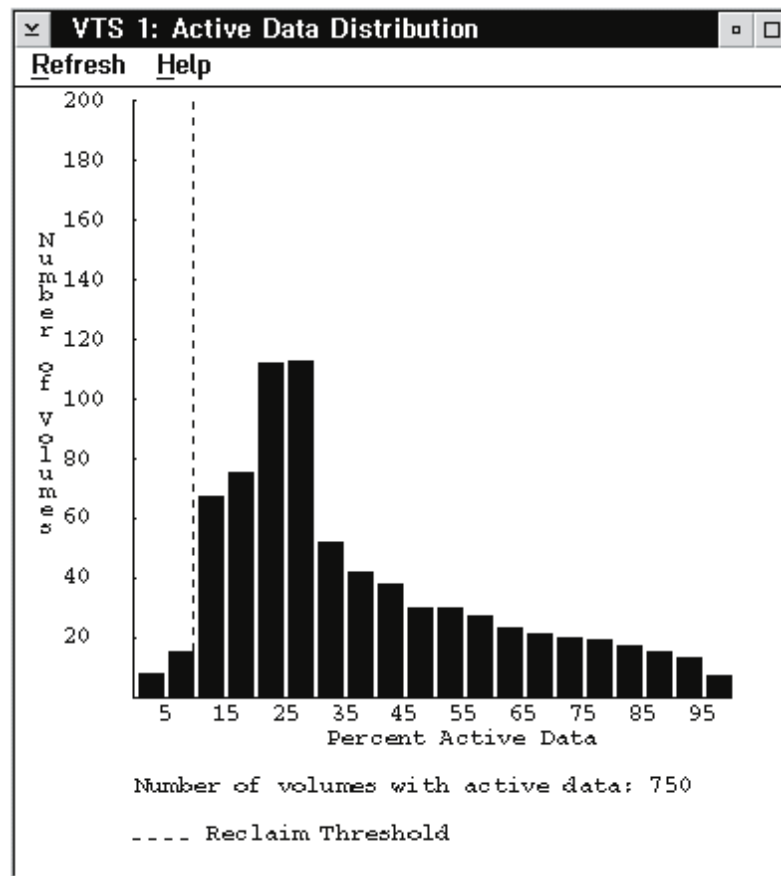

Figure 76. VTS Active Data Distribution Pop-Up Window

The VTS Active Data Distribution window displays a graph showing the distribution of active data on stacked volumes. A separate graph is available for each VTS in the Library. Data is displayed in 5% increments. The first data point shows the number of volumes that contain 0 to 5 percent active data, the second data point shows the number of volumes containing 6 to 10 percent, and so on.

The VTS Active Data Distribution window has the following pull-downs available from its action bar:

### Refresh

Refreshes or updates the contents of the window immediately. You can also click the pointing device on the client area of the window to refresh.

### Help

Provides help about the VTS Active Data Distribution window.

To close the window, select **Close** from the system menu icon (upper-left corner of the window).



## Using the System Summary

The System Summary window (see Figure 77) provides an overview of important 3494 information.

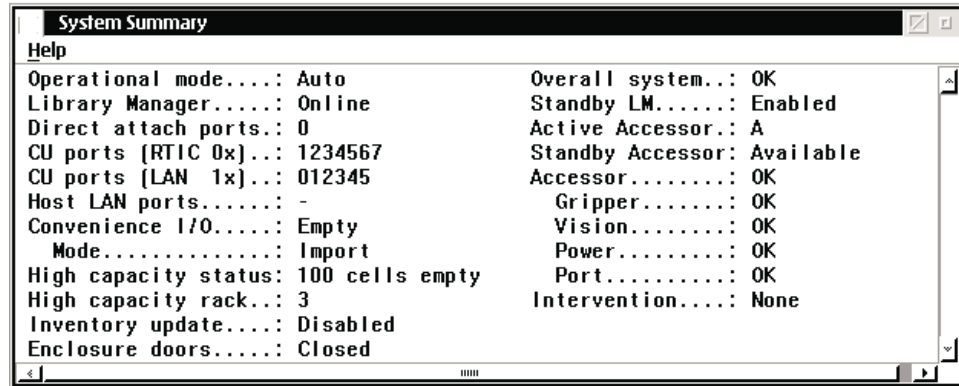

Figure 77. System Summary Pop-Up Window

The System Summary window contains the following:

### Operational mode

Shows whether the subsystem is in Auto, Auto Pending, Pause, Pause Pending, Manual Pending, or Manual mode. See “Using the Mode Pull-Down” on page 99 for an explanation of the operational modes.

### Library Manager

Shows whether the library manager is Online Pending, Online, Offline Pending, or Offline to the attached tape control units. See “Using the Mode Pull-Down” on page 99 for an explanation of the Online and Offline states.

### Direct attach ports

Shows which of the direct attached ports are initialized. Each installed port is shown from left to right (0–3 and/or 8–B). If a port’s number appears, that port is initialized. A ‘-’ shows that the port is not initialized, and a blank shows the port is not installed.

### CU ports (RTIC 0x)

Shows which serial control unit (CU) ports are initialized. Each installed port is shown from left to right (0–F depending on port configuration). If a port’s number appears, that port is initialized. A ‘-’ shows that the port is not initialized, and a blank shows the port is not installed.

### CU ports (LAN 1x)

Shows which LAN attached control ports are initialized.

### Host LAN ports

Shows the total number of initialized LAN attach ports. If no LAN attach ports are initialized, a **Not Initialized** message is displayed. A dash shows that no LAN ports are initialized.

### Convenience I/O

Shows whether the Convenience Input/Output Station is/has:

- Not installed
- Not available
- Empty

- Volumes present
- Opened
- Unknown

#### **Convenience I/O Mode**

Shows the mode setting for the Convenience I/O station. Possible mode settings are:

- Insert
- Import
- Unknown
- none (This field is blank if the Convenience I/O is not installed)

#### **High-Capacity Output or Input/Output Status**

Shows the status of the high-capacity facility. **Not Inventoried** indicates an inventory operation must be performed before the number of empty cartridge storage cells is known. **Empty cells- x** indicates the high-capacity operation is complete and the number of empty cells that remain available in the high-capacity facility. **Failed** indicates the high capacity output operation failed. **Cancelled** indicates the operation was cancelled by an operator. **In Progress** indicates either an Inventory Update that includes the high-capacity rack is in progress or a **high-capacity only** Inventory Update is in progress. **Percent Complete** indicates the progress of the high capacity facility. **Blank** indicates the 3494 has not been taught. **Not Installed** indicates the high-capacity facility was not defined when the 3494 was taught.

#### **High Capacity Rack**

Shows which rack contains either the high capacity output facility or the high capacity input/output facility. Blank indicates the facility is not installed.

#### **Inventory Update**

Shows whether inventory update is installed. If inventory update is installed, its operational status is displayed. **Disabled** indicates inventory update will not be performed. **Not started** indicates an inventory update operation has not been performed since the 3494 was initialized. **Failed** indicates the inventory update operation failed. **Cancelled** indicates the inventory update operation was cancelled by an operator. **In progress** indicates the inventory update operation is in progress. **Percent Complete** indicates the progress of the inventory update. **Completed** indicates the inventory update operation has completed. An inventory update status panel is displayed during the Inventory Update Operation (IUO). Refer to "Perform Inventory Update (Partial)" on page 179. **Blank** indicates the 3494 has not been taught.

#### **Enclosure doors**

Shows the status of the enclosure doors. The window displays **Closed** if the front doors are closed. If any front door is open, the window displays **Open**.

#### **Overall system**

Shows the overall subsystem status. **OK** indicates that the subsystem is functional. **Degraded** indicates that some part of the subsystem failed but the subsystem can function in a degraded manner. Use **Operational status** and **Component availability status** from the Status pull-down for additional information. (See "Operational Status" on page 111.)

#### **Standby LM (Library Manager)**

Shows the status of the standby library manager. **Enabled** indicates the

standby LM is functional. **Disabled** indicates the standby LM is not functional and causes the overall system to report **Degraded**. **Not Installed** indicates the standby LM feature is not installed. **Degraded** indicates the standby LM has lost one of its communication links with the active library manager. **Not Taught** indicates the accessor has not completed a successful teach, thus making it unusable.

#### **Active Accessor**

Shows which accessor is the active accessor. **A** indicates accessor A is active and **B** indicates accessor B is active. **None** indicates that there is currently not an active accessor (both are unavailable). **Both** indicates that both accessors are currently active on a Dual Active Accessors system.

#### **Standby Accessor**

Shows the status of the standby accessor. **Available** indicates that the standby can be used if an accessor switch occurs. **Service Mode** indicates the accessor is unavailable while being serviced. **Not available** indicates the accessor has components marked unavailable that currently make it unusable. **Not installed** indicates that the second accessor is not installed. If the field is blank, it indicates that both accessors are active.

#### **Accessor**

Shows the status of the cartridge accessor. **OK** indicates the accessor is functional. **Failed** indicates that the cartridge accessor failed and cannot function. **Degraded** indicates that some part of the accessor components has failed, but the accessor can still function in a degraded manner.

#### **Gripper**

Shows the status of the gripper. **OK** indicates that the installed gripper on the cartridge accessor is functional. **Degraded** indicates that one of two grippers failed on a cartridge accessor. **Failed** indicates that the gripper failed and the cartridge accessor is unavailable for use. If the high availability model is installed, the gripper status displayed shows the status for both accessors. **OK** indicates that the grippers on both accessors are functional. **Degraded** indicates that one of the grippers has failed on either the standby or active accessor. If dual grippers are installed, **Degraded** indicates that one, two, or three of the grippers have failed. **Failed** indicates that all the grippers have failed.

**Vision** Shows the status of the vision system. **OK** indicates that the vision system on the cartridge accessor is functional. **Failed** indicates that the vision system failed. If the high availability model is installed, the vision system status displayed shows the status for both cartridge accessors. **OK** indicates that both vision systems on the cartridge accessors are functional. **Degraded** indicates that one of the vision systems has failed. **Failed** indicates that all vision systems have failed.

**Power** Shows the power status to the cartridge accessor. **OK** indicates that power is enabled to the cartridge accessor. **Power is Off** indicates that power is disabled to the cartridge accessor. If the high availability model is installed, the power status displayed shows the status for both cartridge accessors. **OK** indicates that power is enabled to both cartridge accessors. **Power is off** indicates that power is disabled to both cartridge accessors. **Degraded** indicates that power is disabled on one of the cartridge accessors. This is OK if power was turned off to one accessor and the system has not yet transitioned to Auto.

**Port** Shows the status of the communication port between the accessor controller and the library manager. **OK** indicates communication on this port

is established and is active. **Not initialized** indicates communication on this port is not established or is lost. **Not installed** indicates installation is not complete. If the high availability model is installed, the port status shows the status for both cartridge accessors. **OK** indicates communication on this port is established and is active for both cartridge accessors. **Not initialized** indicates communication on this port is not established or is lost for both cartridge accessors. **Degraded** indicates communication on this port is established and is active for one of the cartridge accessors.

#### **Intervention**

Shows whether any operator-intervention operations are to be performed. **None** indicates that no intervention-required conditions exist in the library. **Required** indicates that one or more intervention-required conditions exist in the library. See “Operator Intervention” on page 199.

The System Summary window has the following pull-down option available from the action bar:

**Help** Provides help concerning the System Summary window.

To close the window, select **Close** from the system menu icon (upper-left corner of the window).

## LAN Status

The LAN Status pop-up window provides information on the status of the hosts attached to the library system via LAN. Figure 78 shows the LAN Status pop-up window.

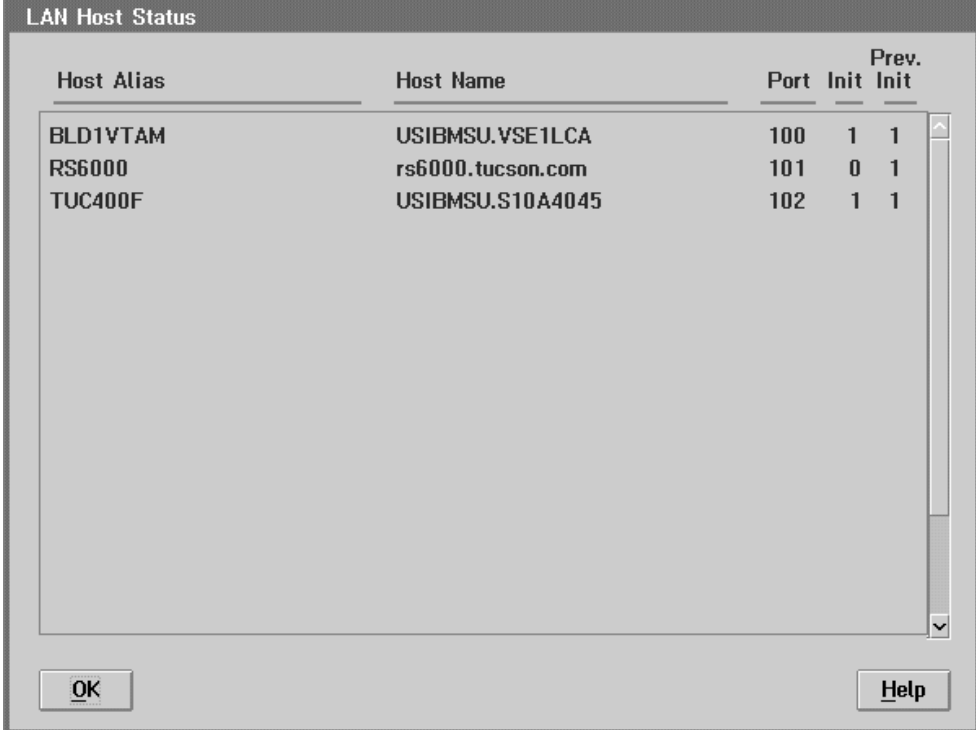

The screenshot shows a window titled "LAN Host Status" with a table containing three rows of host data. The table has five columns: Host Alias, Host Name, Port, Init, and Prev. Init. Below the table are "OK" and "Help" buttons.

Host Alias	Host Name	Port	Init	Prev. Init
BLD1VTAM	USIBMSU.VSE1LCA	100	1	1
RS6000	rs6000.tucson.com	101	0	1
TUC400F	USIBMSU.S10A4045	102	1	1

Figure 78. LAN Status Pop-Up Window

### Host Alias

This field lists the aliases of the LAN attached hosts. The alias for a host is a nickname supplied by the customer for that host. If this field is blank, no alias has been set up for this particular host.

### Host Name

This field lists the names of all the hosts that are (LAN) configured with the library system via LAN.

For TCP/IP hosts, the Host Name is the Hostname defined in the TCP/IP network. In Figure 78, **rs6000.tucson.com** is a TCP/IP Hostname.

For APPC and APPC/VTAM hosts, the Host Name is a combination of the Host Network ID and the Host Location Name. For example, if the Host Network ID is **USIBMSU**, and the Host Location Name is **S10A4045**, then the Host Name is **USIBMSU.S10A4045**.

**Port** The Library Manager assigns a LAN port number to each LAN attached host. The LAN port number is displayed in this field as a hexadecimal number, and is used by service personnel in problem determination.

**Init** This field indicates if the LAN port is initialized.

- 0 indicates the LAN is not initialized.
- 1 indicates the LAN is initialized.

### Previously Initialized

This field indicates if the Library Manager has previously been initialized with this host via LAN.

- 0 in this field indicates the Library Manager has not yet been initialized with this host.
- 1 in this field indicates the Library Manager is initialized or was previously initialized with this host.

The LAN Status panel has the following push-buttons:

**OK** Closes the window.

**Help** Display the help panel.

## Dual Accessor Zones

Figure 79 shows the Dual Accessor Zones window.

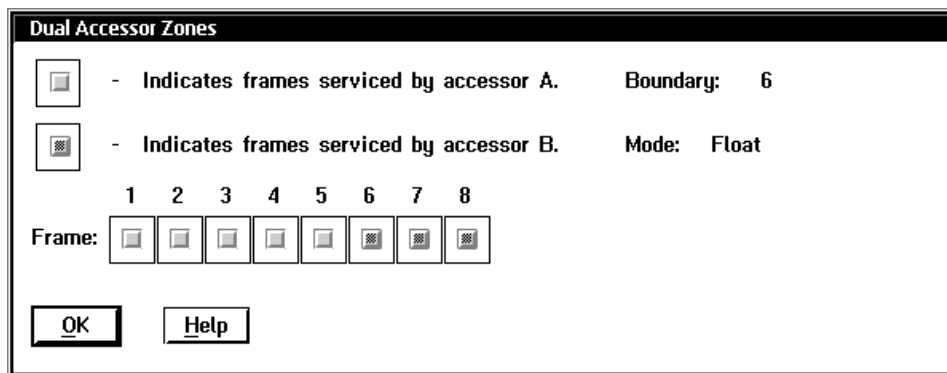

Figure 79. Dual Accessor Zones Pop-Up Window

The Dual Accessor Zones window displays a diagram showing the string of frames that make up the library, and indicators showing which frames are serviced by each accessor. **Boundary** is the frame number of the frame that is currently serving as the zone boundary between Accessor A's work zone and Accessor B's work Zone. **Mode** is the boundary mode (**fixed** or **float**). **Fixed** means the boundary is fixed, and will not change based on activity. **Float** means that the boundary will change automatically based on activity to balance the accessor workload. The default mode is **float**.

The Dual Accessor Zones window has the following push-buttons:

**OK** Closes the Dual Accessor Zones window.

**Help** Provides help about the Dual Accessor Zones window.

To close the window, select the **OK** push-button in the lower left corner of the window.

## Using the Queues Pull-Down

The Queues pull-down (see Figure 80) allows the operator to display the various types of requests that are in progress or waiting to be performed.

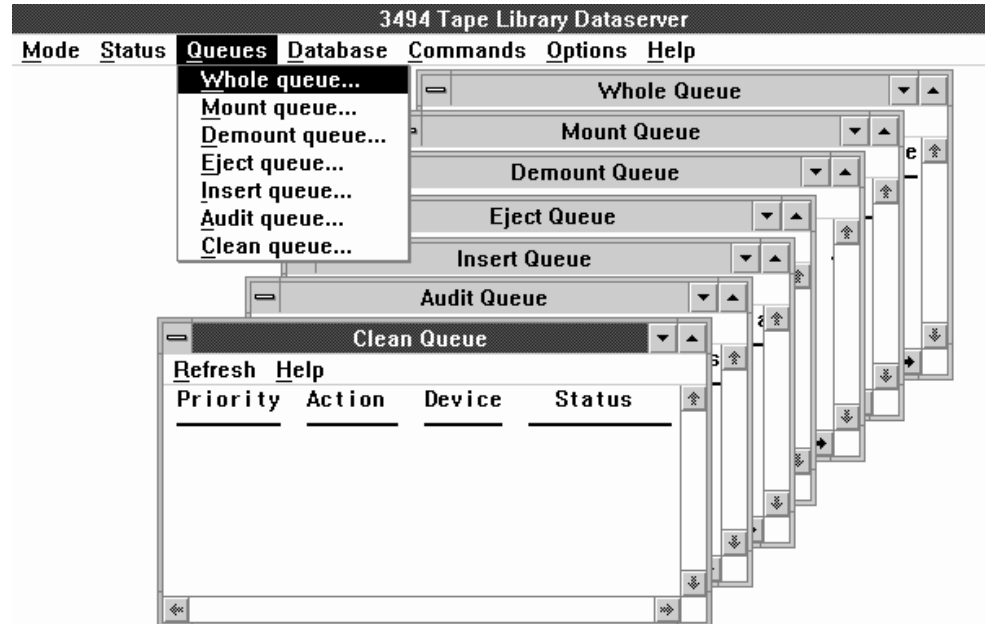

Figure 80. Queues Pull-Down Menu

Select any item from this pull-down to display a moveable, sizeable, scrollable window containing the requested information. In each case, the window has an action-bar option to update the information in the window.

The Queues pull-down selections are as follows:

### **Whole queue**

Displays all the requests in the request queue.

### **Mount queue**

Displays all the mount operations in the request queue.

### **Demount queue**

Displays all the demount operations in the request queue.

### **Eject queue**

Displays all the eject operations in the request queue.

### **Insert queue**

Displays all the insert operations in the request queue.

### **Audit queue**

Displays all the audit operations in the request queue.

### **Clean queue**

Displays all the clean operations in the request queue.

The queue windows, for example, Mount Queue (see Figure 81 on page 138), contain the following information for each operation in the queue:

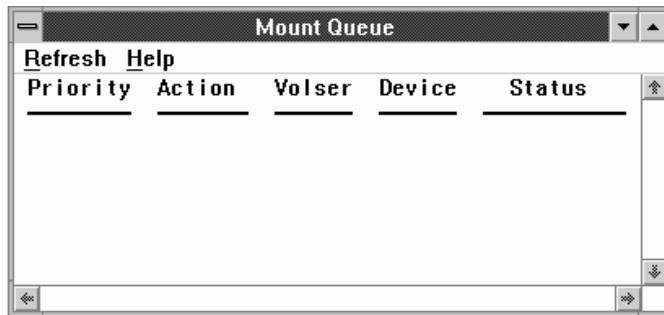

Figure 81. Mount Queue

**Priority**

The priority group in which the operation was placed.

**Action**

The name of the request.

**Volser**

The volser associated with the operation. The field is blank if no volser is identified. The clean queue entry does not require a volser field.

**Device**

The device identifier associated with the operation. The field is blank if no device is identified. The eject, insert, and audit queues do not require a device field.

**Status**

The current status of the operation:

**Queued**

The operation is waiting for action.

**In Progress**

The operation is currently being executed.

**Blocked**

The operation is waiting for another operation to complete execution before the blocked operation can start. No operator action is needed.

Use the Whole Queue window to determine why a library operation is not completing an operation as expected.

Each queue window has the following pull-down menus available from its action bar:

**Refresh**

Refreshes or updates the contents of the window immediately instead of periodically.

**Help**

Displays a help panel with information about the queue windows.

Each window can be closed by selecting **Close** on the system menu icon in the upper-left corner of the window.



---

## Using the Database Pull-Down

Use the Database pull-down (see Figure 82) to view selected volumes based on the specified search criteria.

3494 Tape Library Dataserver				
Mode	Status	Queues	Database	Commands Options Help
			Search database for volumes...	
			List database volumes...	
			Find logical volume's home...	
			Stacked Volume Map...	

Figure 82. Database Pull-Down Menu

The Database pull-down selections are as follows:

### Search database for volumes

Allows a search of the volume database based on search criteria. (See "Search Database For Volumes".)

### Find a logical volume's home

Used to determine which physical volume a logical volume resides on. (See "Find Logical Volume's Home" on page 144.)

### List Database Volumes

Used to output a customized database search to a flat file on a diskette or the C drive. (See "List Database Volumes" on page 145.) The library must be Offline to use this option.

### Stacked Volume Map

Used to output to diskette a map of logical volumes that reside on a stacked volume. (See "Stacked Volume Map" on page 150.)

## Search Database For Volumes

The Search Database for Volumes pop-up window allows a search of the volume database for specific volumes, based on search criteria. The more search criteria used, the more restrictive the search. See Figure 83 on page 140 for a sample window.

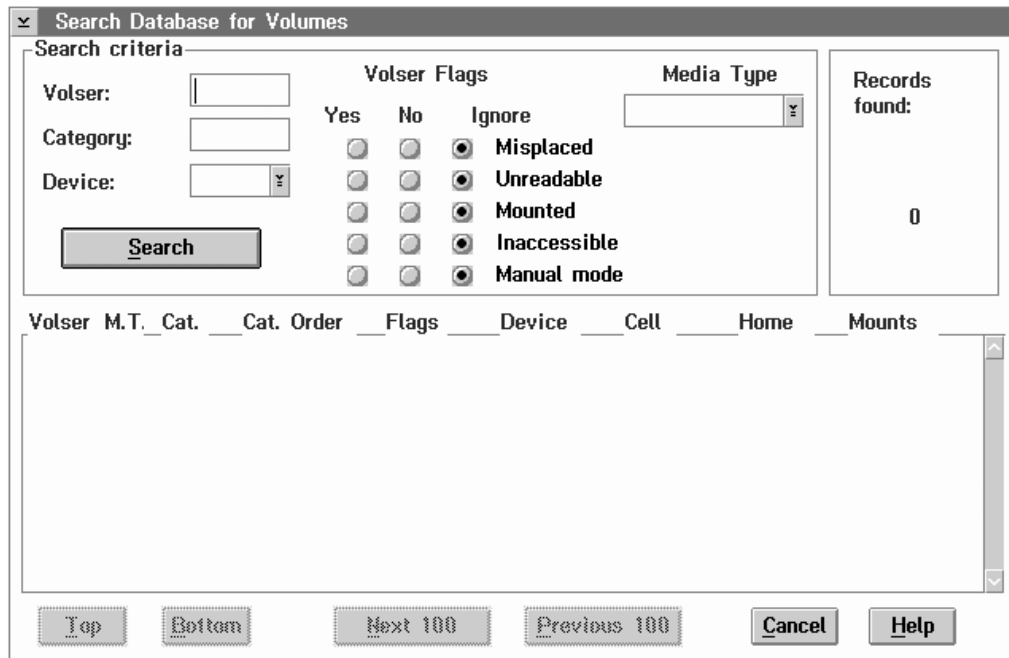

Figure 83. Search Database for Volumes Pop-Up Window

## Search Criteria

The following are selections that can be included in the search criteria:

**Volser** Enter the volser used in the search. The volser consists of one to six alphanumeric characters that match the cartridge label. You can include a wildcard (pattern-matching) character, where ? or \_ indicates one character and \* or % indicates multiple characters.

### Category

Enter the category used in the search. A category is a logical grouping of cartridges for a specific use. The categories are 0000 to FFFF, must contain 4 hexadecimal characters, and cannot contain wildcard characters. The following are predefined categories:

- FF00** Insert
- FF01** VTS Insert
- FF03** VTS Scratch
- FF04** VTS Private
- FF05** VTS Disaster Recovery
- FF06** VTS Disaster Recovery
- FF10** Convenience eject
- FF11** Bulk eject
- FF12** Export-Pending Category
- FF13** Exported Category
- FF14** Import Category

- FF15** Import-Pending Category
- FF16** Unassigned Category
- FF17** Export Hold Category
- FFF6** Service volser (3590)
- FFF9** Service volser (3490E)
- FFFA** Manually ejected
- FFFD** Cleaner volser (3590)
- FFFE** Cleaner volser (3490E)

#### **Device**

Either press Enter or select the device used in the search. A device is represented by a three-digit tape device identifier. Valid device identifiers can be obtained by clicking on the down-facing arrow. Single and multiple character wildcards are valid.

#### **Media Type**

Select the correct media types for the type of tape drives and associated logical library installed in the library.

##### **1 - CST (non-VTS)**

Cartridge System Tape in a non-VTS logical library

##### **E - ECCST (non-VTS)**

Enhanced Capacity Cartridge System Tape in a non-VTS logical library

##### **J - HPCT (non-VTS)**

High Performance Cartridge Tape in a non-VTS logical library

##### **1 - CST (VTS 1)**

Logical Cartridge System Tape in VTS 1 logical library

##### **E - ECCST (VTS 1)**

Logical Enhanced Capacity Cartridge System Tape in VTS 1 logical library

##### **J - HPCT (VTS 1)**

High Performance Cartridge Tape in VTS 1 logical library

##### **1 - CST (VTS 2)**

Logical Cartridge System Tape in VTS 2 logical library

##### **E - ECCST (VTS 2)**

Logical Enhanced Capacity Cartridge System Tape in VTS 2 logical library

##### **J - HPCT (VTS 2)**

High Performance Cartridge Tape in VTS 2 logical library

**?**

Unknown. This is an actual media type that is no longer used. The selection is available for backward compatibility.

#### **Don't Care**

Don't use media type as a search criterion.

#### **Volser Flags**

The following are flag selections that can be included in the search criteria:

**Misplaced**

The cartridge location is unknown. A volser specified in a library request is not in the library where expected.

**Unreadable**

The vision system cannot read the cartridge volser (bar-code label).

**Mounted**

The cartridge is mounted or being mounted on a drive.

**Inaccessible**

The cartridge accessor cannot access the cartridge. A volser specified in a library request is in the library, but cannot be accessed by the cartridge accessor because of a problem with either the cartridge or the cell that contains the cartridge.

**Manual mode**

An operator handled the cartridge during Manual mode processing.

**Search**

Start the search by using the search criteria entered.

The following are possible values for each Volser flag:

**Yes** Search for volumes to which this flag applies.

**No** Search for volumes to which this flag does not apply.

**Ignore**

Search for volumes without regard for this flag.

**Search Results**

The results of the search are displayed in a list. The display list can contain up to 100 records at one time. The vertical scroll bar in the display list can be used to scroll through 100 records. If you find more than 100 records, use the **Next 100** and **Prev 100** push-buttons to display the additional records. Each record contains the following information:

**Volser** The volume serial number of the cartridge.

**M.T.** The media type of the cartridge

- 1** Cartridge System Tape in non-VTS logical library
- E** Enhanced Capacity Cartridge System Tape in non-VTS logical library
- J** High Performance Cartridge Tape in non-VTS logical library
- 1-1** Logical Cartridge System Tape in VTS 1 logical library
- E-1** Logical Enhanced Capacity Cartridge System Tape in VTS 1 logical library
- J-1** Stacked High Performance Cartridge System Tape in VTS 1 logical library
- 1-2** Logical Cartridge System Tape in VTS 2 logical library
- E-2** Logical Enhanced Capacity Cartridge System Tape in VTS 2 logical library
- J-2** Stacked High Performance Cartridge System Tape in VTS 2 logical library

? Unknown

**Cat.** The category represented by four digits that identify the group of volumes or a predefined category.

**Cat. Order**

The position of the cartridge in the category.

**Flags** The status of the flags.

**Note:** For service volumes, the status of the volumes is not reflected in the flags.

Figure 84 shows a summary of the flag values.

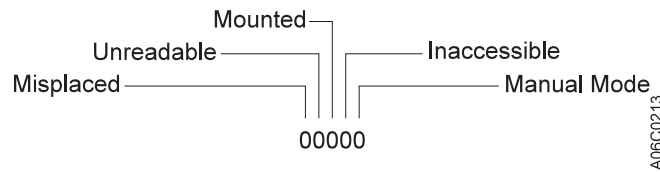

Figure 84. Status Flags

**Device**

The tape device identifier if the cartridge is mounted.

**Cell**

The storage cell that contains the cartridge.

**Home**

The cartridge home cell location.

**Mounts**

The total number of times that the cartridge was mounted.

## Displaying Search Results

The View Database panel contains push-buttons for the following selections:

**Top**

Display the first database records found that match the search criteria.

**Bottom**

Display the last database records found that match the search criteria.

**Next 100**

If you find more than 100 records, display the next 100 records in the list box. If you find fewer than 100 records, this control is disabled.

**Previous 100**

If you find more than 100 records, display the previous 100 records in the display list. If you find fewer than 100 records, this control is disabled.

**Cancel**

Close the View Database pop-up window.

**Help**

Display a help panel with information about the View Database window.

## Find Logical Volume's Home

The Find Logical Volume's Home pop-up window allows you to find which stacked volume a logical volume resides on. See Figure 85 for a sample window.

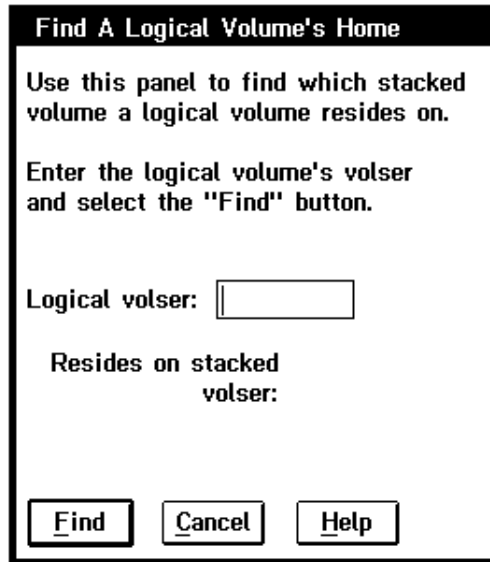

Figure 85. Find Logical Volume's Home Pop-Up Window

Enter the logical volume's Volser in the edit field then select the "Find" button. A message "Search in progress" is displayed while the search is occurring. The appropriate VTS is interrogated for where the logical volume resides.

The stacked volume's Volser is displayed on the panel if the search is successful and the logical volume does reside on a stacked volume.

Messages describing why the search failed are displayed if the search is not successful.

The Find Logical Volume's Home panel contains push-buttons for the following selections:

**Find** Initiates the search for the logical volume's home

**Cancel** Close the Find Logical Volume's Home pop-up window.

**Help** Display a help panel with information about the Find Logical Volume's Home window.

## List Database Volumes

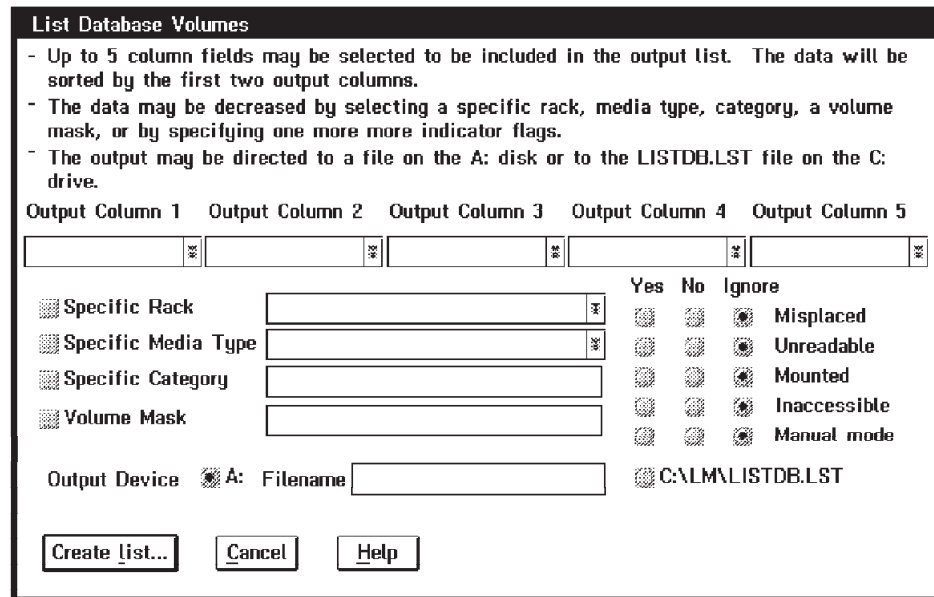

Figure 86. List Database Volume's Pop-Up Window

This panel allows you to create an output file containing a customized listing of selected database columns. The output file is a flat file that can be output to a selectable file name on a diskette or to C:\LM\LISTDB.LST.

The library must be in the **Offline** state for this operation.

During the output process a message, **\*\*\*\* OPERATION IN PROGRESS \*\*\*\*** is displayed.

Specify the list output contents on the output columns using the five **Output column** drop-down list controls. Each drop-down list contains the following selections:

**None** List nothing for this column.

**Volser** List the Volser.

**Cell** List the volume's current rack, column and row.

**Home** List the volume's home rack, column and row.

### Category

List the volume's category in hexadecimal form.

### Category Order

List the volume's category order in decimal form.

### Media Type

List the volume's media type. The media type describes the physical cartridge characteristics as well as which logical library the volume is associated with as follows:

**1** CST, Cartridge System Tape for non-VTS library

- E** ECCST, Enhanced Capacity Cartridge System Tape for non-VTS library
- J** HPCT, High Performance Cartridge Tape for non-VTS library
- 1-1** CST, Logical Cartridge System Tape for VTS 1 library
- E-1** ECCST, Logical Enhanced Capacity Cartridge System Tape for VTS 1 library
- J-1** HPCT, High Performance Cartridge Tape for VTS 1 library
- 1-2** CST, Logical Cartridge System Tape for VTS 2 library
- E-2** ECCST, Logical Enhanced Capacity Cartridge System Tape for VTS 2 library
- J-2** HPCT, High Performance Cartridge Tape for VTS 2 library

**Mount Date**

List the last date the volume was mounted or inserted.

**Mounts**

List the number of times the volume has been mounted.

**Misplaced**

List if the volume is misplaced.

Zero (0) indicates the volume is not misplaced. One (1) indicates the volume is misplaced.

**Unreadable**

List if the volume's label is unreadable.

Zero (0) indicates the volume's label is readable. One (1) indicates the volume's label is unreadable.

**Mounted**

List if the volume is mounted.

Zero (0) indicates the volume is not mounted. One (1) indicates the volume is mounted.

**Inaccessible**

List if the volume is inaccessible.

Zero (0) indicates the volume is accessible. One (1) indicates the volume is inaccessible.

**Manual mode**

List if the volume is was moved during manual mode.

Zero (0) indicates the volume was not moved during manual mode. One (1) indicates the volume was moved during manual mode.

Up to five output columns can be selected to be included in the output list. The data is sorted by the first two output columns. The first column takes precedence over the second column.

The amount of data contained in the list can be decreased by narrowing certain list criteria. One or more of the following can be used to refine the data retrieved:

**Specific Rack**

Select this checkbox if the list output should only include volumes from a particular rack. Use the associated drop-down list to select which rack to limit the output to. The drop-down list contains all of the racks in the library.



### Specific Media Type

Select this checkbox if the list output should only include volumes of a certain media type. Use the associated drop-down list to select which media type to limit the output to. The media type describes the physical characteristics of the cartridge as well as the logical library the volume is associated with. The library sequence number is shown next to each media type (xxxxx). Some or all of the following selections are available based on the number and type of logical libraries:

- 1 - CST (Non-VTS xxxxx)
- E - ECCST (Non-VTS xxxxx)
- J - HPCT (Non-VTS xxxxx)
- 1 - CST (VTS 1 xxxxx)
- E - ECCST (VTS 1 xxxxx)
- J - HPCT (VTS 1 xxxxx)
- 1 - CST (VTS 2 xxxxx)
- E - ECCST (VTS 2 xxxxx)
- J - HPCT (VTS 2 xxxxx)

### Specific Category

Select this checkbox if the list output should only include volumes with a specific category. Use the associated entry field to enter the desired category. The category must be entered as a 4 digit hexadecimal number.

### Volser Mask

Select this checkbox if the list output should only include volumes that match the volser mask. Use the associated entry field to enter the 1 to 6 character volser mask. You can include a wildcard (pattern-matching) character, where ? or \_ indicates one character and \* or % indicates multiple characters.

**Flags** Select the desired flag radio buttons if the list should only include volumes with certain flags set or cleared. Each flag can be set to 1 of 3 possible settings by clicking on the associated radio button.

The flags can be:

- *Yes*

The flag's condition applies to this volume (list volumes that this flag applies to).

- *No*

The flag's condition does not apply to this volume (list volumes that this flag does not apply to).

- *Ignore*

List volumes with the flags set to any value (list volumes without regard to the state of the flag).

The following flags can be selected:

- Misplaced
- Unreadable
- Mounted
- Inaccessible
- Manual Mode

The output listing can be created on the A: diskette drive or on the C: drive. Select the desired radio button. A filename can be entered if the A: drive is selected. The filename can be up to 79 characters long. If the C: drive is selected, the output is sent to C:\LM\LISTDB.LST.

The output listing consists of the following:

- The date and time.
- The selection criteria.
- Column headings describing the contents of each column
- The selected data
- Total number of records listed.

If the output listing spans multiple diskettes, the selection criteria is not repeated.

Various messages can appear during or at the end of the list database operation. Possible messages are:

- **Insert a formatted disk into Drive A: Select OK to begin the operation.**  
Displayed initially when the output listing is being directed to the A: drive.
- **Insert another formatted disk into Drive A: Select OK to begin the operation.**  
Displayed if the output listing is large enough that it spans multiple diskettes.
- **The List Database Volumes operation completed successfully.**  
The output listing has been created and the operation is complete.
- **The List Database Volumes operation failed.**  
The operation failed due to an internal error, try again.
- **The disk is write-protected. Insert another disk into Drive A: Select OK to retry the operation.**  
The diskette is write protected. Insert in a diskette that is not write-protected and try again.
- **The disk in the A: Drive is full. Insert another formatted disk into Drive A: Select OK to begin the operation.**  
Displayed if the A: drive was selected for output and there is not enough room on the diskette to fit the output listing.
- **The disk in the A: Drive is not formatted. Insert another formatted disk into Drive A: Select OK to begin the operation.**  
The diskette is not formatted. Insert a formatted diskette and try again.
- **The operation could not be completed because the C: Drive is full.**  
Displayed if the C: drive was selected for output and there is not enough room on the drive to fit the output listing.
- **A disk error occurred attempting the List Database Volumes operation.**  
The operation failed due to a disk error. Insert another diskette and try again.

Following are examples of using the List Database Volumes function.

- Find all misplaced volumes in rack 3 and display their locations.
  1. Select **Volser** for **Output Column 1**.
  2. Select **Home** for **Output Column 2**.
  3. Check the **Specific Rack** checkbox.
  4. Select rack **3** in the associated drop-down list.
  5. Select the **Yes** radio button associated with **Misplaced**.

6. Select the desired **Output Device** radio button and enter the **Filename** if **A:** is selected.
7. Insert a non-write protected diskette in the A: drive if **A:** was selected.
8. Select the **Create list** button. An Operation In Progress message is displayed during the list operation.
9. A completion message is displayed when the operation is complete.
- Find all volumes starting with BCD in rack 4 and display their locations and category.
  1. Select **Volser** for **Output Column 1**.
  2. Select **Category** for **Output Column 2**.
  3. Select **Home** for **Output Column 3**.
  4. Check the **Specific Rack** checkbox.
  5. Select rack **4** in the associated drop-down list.
  6. Check the **Volser Mask** checkbox.
  7. Enter **BCD\*** in the Volser Mask entry field.
  8. Select the desired **Output Device** radio button and enter the **Filename** if **A:** is selected.
  9. Insert a non-write protected diskette in the A: drive if **A:** was selected.
  10. Select the **Create list** button. An Operation In Progress message is displayed during the list operation.
  11. A completion message is displayed when the operation is complete.

The panel's pushbuttons are:

**Create list**

Initiate the list database volumes operation

**Cancel**

Close the panel.

**Help**

Display this help panel

## Stacked Volume Map

The Stacked Volume Map pop-up window allows you to obtain a map of logical volumes that reside on a stacked volume. This function is only available if a VTS is installed in the library. See Figure 87 for a sample window.

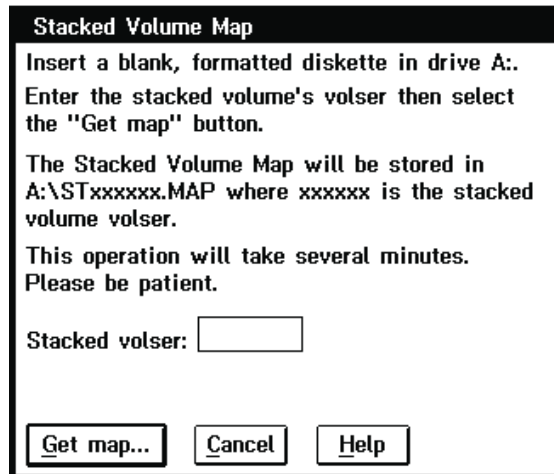

Figure 87. Stacked Volume Map Pop-Up Window

Insert a blank, formatted diskette in drive A. The search will not proceed unless a diskette is in the drive.

Enter the stacked volume's Volser in the edit field then select the "Get map" button. A message "Search in progress" is displayed while the search is occurring. The appropriate VTS is interrogated for the map of the stacked volume.

The logical volumes are retrieved 100 at a time from the appropriate VTS. A message is displayed when the complete map is received successfully.

The stacked volume map will be stored on the A: diskette in a file named **STxxxxxx.MAP** where **xxxxxx** is the stacked volume VOLID.

Messages describing why the search failed are displayed if the search is not successful.

The output file is in the following format:

```
Version: 00001
Time and Date of Map: 13:40:24 04/24/1998
Library Sequence Number: 12345
Customer ID: IBM Global Services
Stacked Volser: BAR010
Number of Logicals: 120
LOG000
LOG010
LOG234
.
.
.
LOG465 SPAN
```

If a logical volume spans 2 stacked volumes, the word **SPAN** appears next to the volser.

Stacked Volume Map panel contains push-buttons for the following selections:

**Get Map**

Initiate the search for logical volumes

**Cancel**

Close the Stacked Volume Map pop-up window.

**Help**

Display a help panel with information about the Stacked Volume Map window.

## Using the Commands Pull-Down

Use the Commands pull-down (see Figure 88) to work with the tape library commands.

3494 Tape Library Dataserver			
Mode	Status	Queues	Database
			<b>Commands</b>
			<b>Options</b>
			<b>Help</b>
			Cleaning →
			Send message to host consoles...
			Promote a command in the queue...
			System management →
			Inventory →
			Stand-alone device... →
			Insert Unlabeled Cartridges...
			LAN options →
			Operator intervention...
			Change system administrator password
			Service access →
			SNMP options →

Figure 88. Commands Pull-Down Menu

The Commands pull-down selections are as follows:

### Cleaning

Allows the selection of the following:

#### Schedule cleaning

Schedule the cleaning of the tape drives based on time or usage. (See "Schedule Cleaning" on page 155.)

#### Eject a cleaner cartridge

Eject a selected cleaner cartridge. (See "Eject a Cleaner Cartridge" on page 158.)

#### Cleaner masks

Change cleaner masks. (See "Cleaner Cartridge Masks" on page 158.)

### Send message to host consoles

Display a pop-up window where you enter a message (70 characters maximum). The message is then sent to all the hosts. (See "Send Message to Host Consoles" on page 159.)

### Promote a command in the queue

Display a pop-up window that allows the user to select one or more requests in the command queue to be promoted. (See "Promote a Command in the Queue" on page 160.)

### System management

Allows the selection of the following:

#### Volser range for media types

This panel allows the entry of up to 50 volser ranges and associated media types. The volser ranges are used to help determine a volser's media type when it is inserted into the library.

(See “Volser Range for Media Types” on page 161.) Volser Ranges are used only for physical volumes.

#### **Insert VTS logical volumes**

This panel allows the insert of logical volumes into a VTS library. (See “Insert VTS Logical Volumes” on page 163.)

#### **Eject a VTS stacked volume**

This panel allows a VTS stacked volume to be ejected from the library. (See “Eject a VTS Stacked Volume” on page 165.)

#### **Set VTS category attributes**

This panel allows the setting of a category to a “Fast Ready” category. (See “Set VTS Category Attributes” on page 166.)

#### **Set VTS management policies**

This panel allows the entry of the “Inhibit Reclaim Schedule”, “Free Storage Alarm Threshold”, and “Reclaim Threshold”. (See “Set VTS Management Policies” on page 167.)

#### **Manage Unassigned Volumes**

This panel allows the operator to move physical volumes (J-type, HPCT) in the Unassigned category to the Import category, Insert category, or to eject the volumes. (See “Manage Unassigned Volumes” on page 202.)

#### **Manage Import Volumes**

This panel allows the operator to move physical volumes (J-type, HPCT) in the Import category to the Insert category, or if desired, eject the volumes from the library. See “Manage Import Volumes” on page 204.)

#### **Manage Insert Volumes**

This panel allows the operator to re-evaluate the physical volumes in the Insert category for 3590 native use or eject the volumes from the library. (See “Manage Insert Volumes” on page 205.)

#### **Manage Export-Hold Volumes**

This panel allows the operator to move Exported Stacked Volumes in the Export-hold category to the Import category or eject the Exported Stacked Volumes from the library. (See “Manage Export-Hold Volumes” on page 206.)

#### **Cancel Export/Import**

This panel allows the operator to send a cancel request for an in-progress Import or Export operation. (See “Cancel Export/Import” on page 207.)

### **Inventory**

Allows the selection of the following:

#### **Inventory new storage**

Start an inventory of any storage components that were not inventoried previously. (See “Inventory New Storage or Re-inventory Complete System” on page 169.) This is typically a system administrator password-protected function.

#### **Re-inventory complete system**

Inventory all storage components. (See “Inventory New Storage or Re-inventory Complete System” on page 169.) This is typically a system administrator password-protected function.

**Disable inventory update**

Disables inventory update allowing doors to be opened and closed without performing inventory update. (See “Disable Inventory Update” on page 176.)

**Enable inventory update**

Enables inventory update to take place whenever the library system is returned to Auto/Online mode after an enclosure door is opened and closed. (See “Enable Inventory Update” on page 177.)

**Perform inventory update (Full)**

Performs an immediate inventory update. This option is only available if the library system is in Auto mode and Online state. (See “Perform Inventory Update (Full)” on page 177.)

**Perform inventory update (Partial)**

Performs inventory on just the frames on which the doors have been opened. This option is only available if the library system is in Auto mode and Online state. (See “Perform Inventory Update (Partial)” on page 179.)

**Stand-alone drive**

Allows the selection of the following:

**Setup stand-alone drive**

Set up special stand-alone library functions. (See “Stand-Alone Device” on page 180.)

**Reset stand-alone drive**

Reset stand-alone drives. (See “Reset Stand-Alone Device” on page 182.)

**Stand-alone drive status**

Provides status for stand-alone drives. (See “Stand-Alone Device Status” on page 183.)

**Insert unlabeled cartridges**

Display the Insert Unlabeled Cartridge pop-up window that allows the operator to insert unlabeled cartridges into the library. (See “Insert Unlabeled Cartridges” on page 184.)

**LAN Options**

Allows the selection of the following:

**Add LAN host**

(See “Add LAN Host” on page 185)

**Delete LAN host**

(See “Delete LAN Host” on page 190)

**Update LAN host information**

(See “Update LAN Host Information” on page 191)

**LM LAN information**

(See “LM LAN Information” on page 198)

**Operator intervention**

Display the intervention-required conditions. You can specify the items where action was taken. (See “Operator Intervention” on page 199.)



**Change system administrator password**

Display a pop-up window that allows the user to change the system administrator's password. (See "System Administrator Password" on page 200.)

**Service Access**

Allows for selection of the following:

**Enable service access**

Provides the ability to access the library managers through a modem connection when installed. (See "Service Access" on page 208.)

**Disable service access**

Prevents the ability to access the library managers through a modem connection if installed. (See "Service Access" on page 208.)

**SNMP Options**

Allows for selection of the following:

**Start SNMP**

Provides the ability to start the SNMP messaging process. (See "SNMP Options" on page 208.)

**Stop SNMP**

Provides the ability to stop the SNMP messaging process. (See "SNMP Options" on page 208.)

**Change SNMP trap destinations**

Provides the ability to add and delete the SNMP trap destinations for SNMP trap messages. (See "SNMP Options" on page 208.)

**Select SNMP trap types**

Provides the ability to select the SNMP trap type of messages to be sent to an SNMP monitoring station. (See "SNMP Options" on page 208.)

**Send TESTM trap**

Provides the ability to send test messages to SNMP monitoring stations. (See "SNMP Options" on page 208.)

## Schedule Cleaning

From the Commands pull-down, the operator can schedule automatic cleaning of the tape drives based on time or usage. Also, the 3490E/3590 control units can request a cleaning based on tape drive performance.

### 3490E or 3590 Device Cleaning

Device cleaning in the library is managed by the library manager. During installation of the 3494 and at any other time, a cleaning schedule can be established by selecting the Commands pull-down from the Operator menu, and then selecting the Schedule Cleaning item. An operator can then specify one of the following cleaning schedules:

**Time of Week**

The tape subsystem drives are cleaned at specific times and days during a week. This sets up a cleaning based on time.

**Usage** The tape subsystem drives are cleaned after a specified number of mounts on a per drive basis.

The operator settings do not affect the cleaning caused by tape drive performance. The tape subsystem control unit examines tape drive performance to determine if a drive must be cleaned. When the tape subsystem control unit determines that a drive must be cleaned, the tape subsystem control unit informs the library manager to place a clean operation in the operations queue.

When the clean operation is executed, the next least-recently used cleaner volume is selected from the appropriate cleaner-volume category and mounted on the drive. When the volume is unloaded after the clean operation, the host systems are notified that a cleaning operation completed.

### **Cleaner Cartridge Replacement at End-of-Life**

Cleaner cartridges are automatically ejected from the library when they are used the maximum number of times specified in the Clean Schedule window.

When the number of mounts of a cleaner cartridge equals the number of allowed uses, that cartridge is automatically ejected and placed in the Convenience Input/Output Station. All attached hosts are notified that a cleaner volume was ejected from the 3494. If the library is out of cleaner cartridges and a drive must be cleaned, all attached hosts are notified the 3494 is out of cleaner volumes. Operator intervention is posted on the library manager console.

A value can be specified for the maximum uses of a cleaner cartridge before it is ejected from the 3494. For 3490E, the default is 200 and the maximum allowed is 500. For 3590, the recommended usage is 100.

Errors related to the handling of a cleaner volume are not reported to the host; they are logged by the library manager.

### **Clean Schedule Panel Controls**

The Clean Schedule pop-up window (see Figure 89 on page 157) allows you to schedule cleaning of the tape drives by either time or usage.

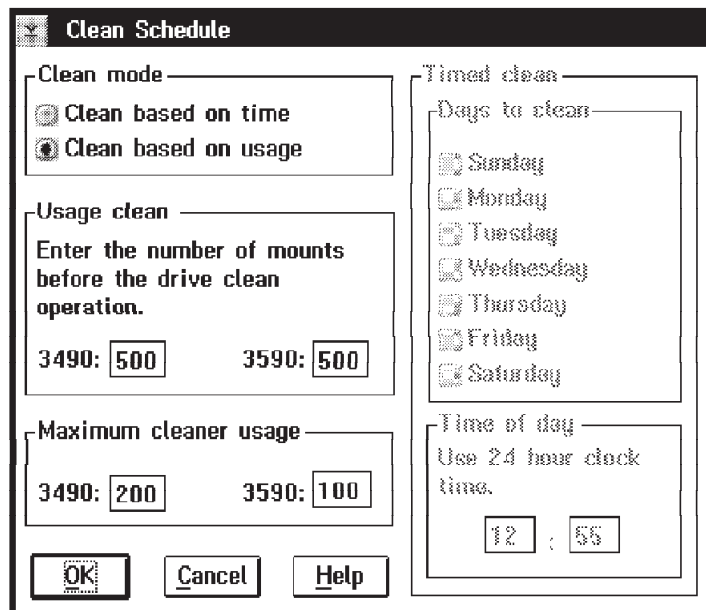

Figure 89. Clean Schedule Pop-Up Window

#### Clean based on time

This radio button selects the **Timed clean** area of the window. Select the **Days to clean** and **Time of day** fields for entering time parameters.

#### Clean based on usage

This radio button selects the **Usage clean** area of the window for entering numbers. Specify drive cleaning in the **Enter the number of mounts before the drive clean operation** field.

The selections are as follows:

#### Usage clean

Specify that tape drives are cleaned after a certain number of mounts on a per-drive basis. The default is 500.

#### Days to clean

Specify the days during a week when cleaning is to be initiated.

#### Time of day

Specify the time of the day when cleaning is to be started. Enter the time of day in the fields provided based on a 24-hour clock, for example, 16:00 is 4:00 p.m.

#### Maximum cleaner usage

For both time and usage based cleans a maximum cleaner usage must be entered. Change the maximum number of times that cleaner volumes are used before they are automatically ejected from the 3494. For 3490E, the default is 200 and the maximum allowed is 500. For 3590, the recommended usage maximum is 100.

**OK** Set the new clean schedule.

#### Cancel

Close the pop-up window without changing the cleaning schedule.

**Help** Display the help information.

The cleaning schedule is stored in the library manager database. When the cleaning schedule is changed, the tape drive's usage-based clean counter is reset to zero.

## Eject a Cleaner Cartridge

The Eject a Cleaner Cartridge pop-up window (see Figure 90) allows the operator to select a cleaner cartridge in the library and then eject the selected cleaner cartridge from the library.

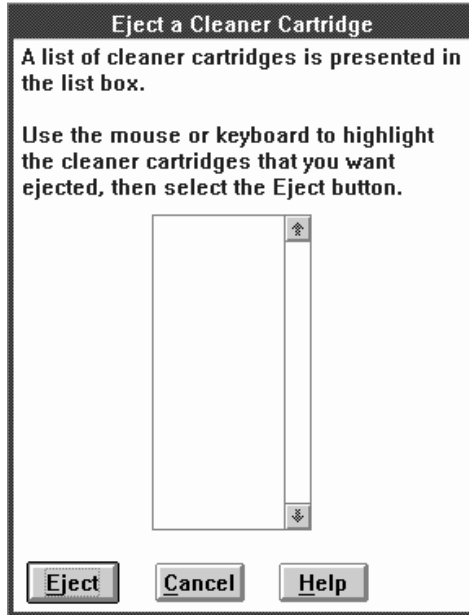

Figure 90. Eject a Cleaner Cartridge Pop-Up Window

A list of cleaner cartridges is presented in the list box.

Use the mouse or keyboard to highlight the cleaner cartridges that are to be ejected, then select the Eject button.

Following are the push-buttons:

**Eject** Ejects the selected cleaner cartridge from the library.

**Cancel**  
Closes the window.

**Help** Provides help concerning the Eject a Cleaner Cartridge window.

## Cleaner Cartridge Masks

The Cleaner Masks pop-up window allows the entry of cleaner masks.

At least one of the masks must be set (for example, CLN\*\*\*). The CLN prefix is not a requirement. Any valid volser can be used. See "Cleaner Volume Masks" on page 172 for additional information.

**Note:** When “Cleaner Cartridge Masks” is selected from the “Commands” pull-down, the following rules apply to the changing of the masks. These rules do not apply when the masks are changed as part of a full inventory operation.

1. A cleaner mask cannot match the volser of any data cartridge in the library. You must either enter a different cleaner mask or eject all data cartridges in the library that match the cleaner mask before using the mask.
2. You cannot delete a cleaner mask when there are cleaner cartridges in the library that match this mask. You must either retain this cleaner mask or eject all cleaner cartridges that match this mask before deleting the mask.

See Figure 91 for information on how to set the cleaner volume masks.

**Cleaner Masks**

Verify cleaner cartridge masks and change if required.

At least one mask must be specified. A mask must contain 6 characters. Use an asterisk [\*] as the wild card character [CLN\*\*\*\*].

Mask 1:	<input type="text" value="CLN****"/>	Mask 6:	<input type="text"/>
Mask 2:	<input type="text"/>	Mask 7:	<input type="text"/>
Mask 3:	<input type="text"/>	Mask 8:	<input type="text"/>
Mask 4:	<input type="text"/>	Mask 9:	<input type="text"/>
Mask 5:	<input type="text"/>	Mask 10:	<input type="text"/>

Figure 91. Cleaner Cartridge Masks

The following are the push-buttons:

**OK** Check masks and save.

**Cancel**

Closes the window without saving any changes.

**Help** Provides help concerning the Cleaner Cartridge Mask window.

## Send Message to Host Consoles

The Host Message pop-up window (see Figure 92 on page 160) allows you to enter up to 70 characters to be sent to all attached hosts. The library manager must be Online for this selection. If not, an error message is displayed that indicates the 3494 must be Online.

The acknowledgment **Message has been sent to all attached hosts** indicates that the broadcast was processed.

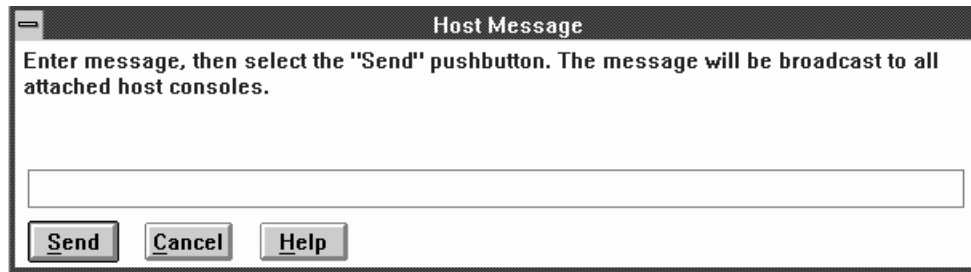

Figure 92. Host Message Pop-Up Window

The following are the push-buttons:

**Send** Sends the message to all attached hosts.

**Cancel**  
Closes the window.

**Help** Provides help concerning the Host Message window.

## Promote a Command in the Queue

When the **Promote a command in the queue** selection is made from the Commands pull-down, the Promote Command pop-up window (see Figure 93) is displayed.

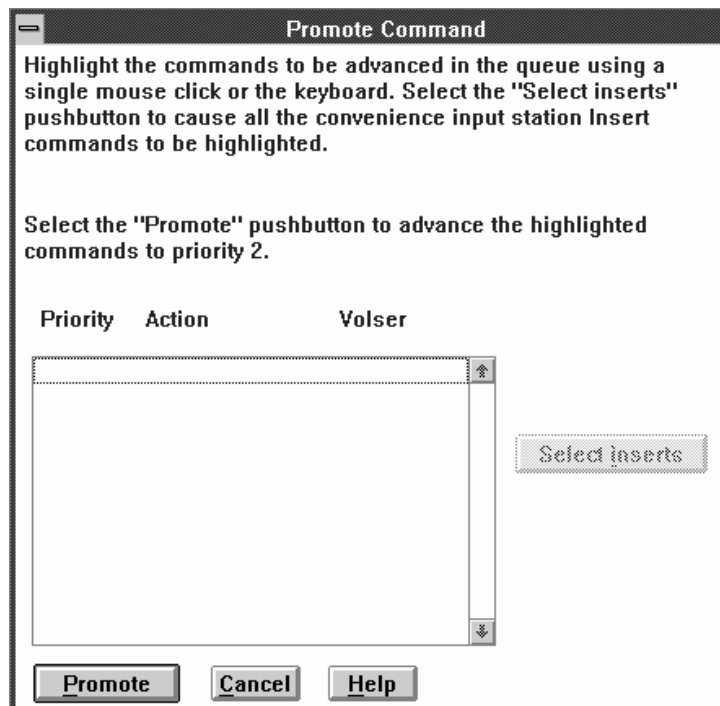

Figure 93. Promote Command Pop-Up Window

The list box in the window shows the commands in the command queue. For each command, the priority and volser, if applicable, are shown. The commands are

shown in priority order with the highest priority command at the top of the list. Commands to be promoted are selected by highlighting. If a command is selected for promotion and the command is already in progress, the command is not promoted. The list box is automatically updated when a command is promoted. The following are the push-buttons:

**Promote**

Promotes all highlighted commands to the top of the priority 2 queue.

**Cancel**

Closes the pop-up window. Any promoted commands stay promoted.

**Help**

Provides additional information about the Promote Commands pop-up window.

**Select Inserts**

Highlights all Insert commands for volumes entered through the Convenience Input/Output Station.

## Volser Range for Media Types

This panel allows the entry of up to 50 volser ranges and associated media types. The volser ranges are used to help determine a physical volume's media type when it is inserted into the library. When a range is added or modified, the system automatically combines overlapping ranges with the same media type and checks for range conflicts.

When a volser range changes, the media types for existing volumes in the library do not change. Volumes inserted subsequently will reflect the new set of ranges and associated media types. A volser range cannot conflict with existing volsers of a different media type.

A volume's media type is determined by using the following rules:

1. The media type returned by the vision system is used as a first choice.
2. If the media type returned is for an HPCT type cartridge and there is more than one logical library in the physical library, the volser ranges are used to determine to which logical library the volume is assigned.
3. The volser ranges are used to determine a volume's media type if it cannot be determined by the vision system. If the volume being inserted appears within one of the ranges, the range's associated media type is used. The search of the ranges is an inclusive search.
4. The system uses the default media type defined during the teach process to determine the media type if the volser does not fall into one of the ranges.
5. The volume is ejected if there is no default media type.

To add a range, enter the two volsers, select a media type and select the **Add/Modify range** button.

To modify a range, double-click the mouse on the range, modify the volsers, select the media type, and select the **Add/Modify range** button.

To delete a range, double-click the mouse on the range, and select the **Delete range** button.

To determine if a volser is in a range, enter the volser in the "From" entry field and select the **Volser in range?** button.

To query the number of volsers in a range, highlight the range in the list box and select the **Total volsers in range** button.

This panel has the following controls:

### Range 1 and 2 entry fields

The volser entry fields can contain up to six alphanumeric characters. The 2 volsers must be entered in the same format. Corresponding characters in each volser must both be either alphabetic or both be numeric. For example, AAA998 and AAB004 are of the same form, whereas AA9998 and AAB004 are not.

The volsers that fall within a range are determined as follows. The volser range is incremented where alphabetic characters are incremented alphabetically and numeric characters are incremented numerically. For example, volser range ABC000 through ABD999 would result in a range of 2000 volsers (ABC000 - ABC999 and ABD000 - ABD999).

### Media type list box

A selectable list of media types. Highlight the desired media type for the range.

### Volser ranges list box

A scrollable list of the volser ranges. Highlighting a range causes the volsers and media type to appear in the entry fields and the media type list box. Highlight a range before selecting the **Delete range** button.

**Volser Ranges**

- To add a range, enter the two volsers, select a media type and select the 'Add/Modify range' button.
- To expand a range, double-click the mouse on the range, modify the volsers, and select the 'Add/Modify range' button.
- To delete a range, double-click the mouse on the range, and select the 'Delete range' button.
- To determine if a volser is in a range, enter the volser in the 'From:' entry field and select the 'Volser in range?' button.
- To query the number of volsers in a range, highlight the range in the list box and select the 'Total volsers in range' button.

From:  To:

Media type

1	-	CST	(Non-VTS 12345)
E	-	ECCST	(Non-VTS 12345)
J	-	HPCT	(Non-VTS 12345)

From To Media type

Figure 94. Volser Ranges Pop-Up Window

The following are the push-buttons:

### Add/Modify range

Add or modify a range. The volsers entered and media type selected are



used to add or modify a range. An error message is displayed if there is a problem with the new or modified range.

**Delete range**

Deletes the highlighted range from the list of ranges. You are prompted to confirm the delete operation. Select **Yes** to perform the range delete. Select **No** to cancel the range delete.

**Volser in range?**

Checks to see if the volser entered in the "From" entry field is in a defined range. If so, the range is highlighted in the list box.

**Total volsers in range**

Computes the number of physical volumes that are within a highlighted range.

**Cancel**

Close the volser range panel. All changes to the ranges are saved.

**Help**

Display this help panel.

## Insert VTS Logical Volumes

The Insert VTS Logical Volumes pop-up window allows the insert of logical volumes into a VTS library. With the Warp 4.0 operating system, up to a total of 150,000 logical volumes can be inserted into the 3494 library (with prior versions of the operating system, up to 50,000 logical volumes can be inserted). For information on determining which operating system you have, see "Using the Help Pull-Down" on page 94 and 95.

Volsers must be unique within a physical library. A logical volume's volser cannot match another logical or physical volume's volser. If a duplicate volser is encountered, the duplicate is not inserted.

**Note:** On High Availability machines, dual write mode is suspended during the insert operation if more than 1000 volumes are being inserted.

To insert logical volumes:

1. Enter a volser or range of volsers to be inserted into the library.
2. Select the cartridge type to be emulated.
3. Select which VTS library the volumes are to be inserted into.
4. Select the **Insert** button.

This panel has the following controls:

**Volser 1 and 2 entry fields**

Volser entry fields must contain six alphanumeric characters. The 2 volsers must be entered in the same format. Corresponding characters in each volser must both be either alphabetic or both be numeric. For example, AAA998 and AAB004 are of the same form, whereas AA9998 and AAB004 are not.

The volser is incremented where alphabetic characters are incremented alphabetically and numeric characters are incremented numerically. For example, volser range ABC000 through ABD999 would result in an insert of 2000 volsers (ABC000 - ABC999 and ABD000 - ABD999).

### Media type radio buttons

These buttons allow the selection of which type of physical cartridge the logical volume will emulate. The selections are Cartridge System Tape (CST) or Enhanced Capacity Cartridge System Tape (ECCST).

### VTS Library Selection

These buttons allow the selection of which VTS library the logical volumes will be inserted into. Buttons are displayed only for the number of VTS libraries installed.

**Insert Logical Volumes**

1. Enter a volser or range of volsers to be inserted into the library.
2. Select the cartridge type to be emulated.
3. Select which VTS library the volumes are to be inserted into.

Volser:  through   Cartridge System Tape  
 Enhanced Capacity Cartridge System Tape

VTS Library

VTS	Library Sequence Number
<input checked="" type="radio"/> VTS 1	67890

Figure 95. Insert VTS Logical Volumes Pop-Up Window

The following are the push-buttons:

**Insert** Initiates the insert operation. The number of volumes that will be inserted is displayed for operator confirmation. Select **Yes** to proceed with the insert or **No** to abort the insert.

A check is made to make sure that the total number of logical volumes for the 3494 library does not exceed the maximum allowable number. If the insert would result in more than the maximum allowable number of logical volumes in the 3494 library, an error message is displayed and the insert is aborted.

When multiple Virtual Tape Server subsystems are in the 3494 Library, logical volumes may be assigned to each VTS subsystem in any quantity, providing the total for all logical volumes does not exceed the maximum allowable for the 3494 Library.

During the insert operation, a status panel (see Figure 95) is displayed, indicating the progress of the insert operation.

### Cancel

Close the insert logical volumes.

### Help

Display the Insert VTS logical volumes help panel.

## Insert VTS Logical Volumes Status

The Insert VTS Logical Volumes Status pop-up window displays the status of the logical insert operation. It displays the range of volsers to be inserted and which volser is currently being inserted. The status is automatically updated every 5 seconds.

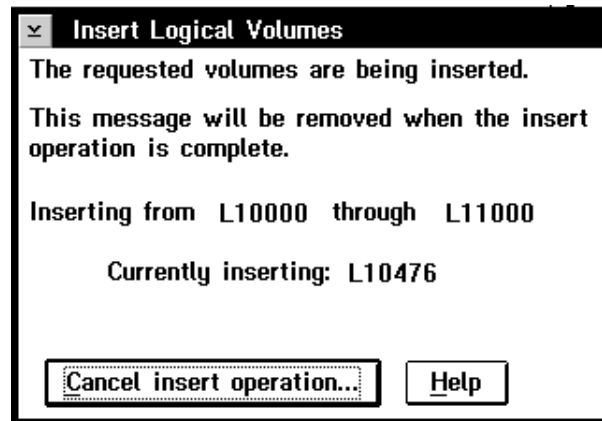

Figure 96. Insert VTS Logical Volumes Status Pop-Up Window

The following are the push-buttons:

### Cancel insert operation

Stop the logical insert operation. You are prompted to confirm the cancellation. Select **Yes** to cancel the insert operation. Select **No** to continue the insert operation. Any logical volumes inserted prior to the cancellation remain inserted.

**Help** Display the Insert VTS Logical Volumes Status help panel.

## Eject a VTS Stacked Volume

The Eject a VTS Stacked Volume pop-up window allows a stacked volume to be ejected from the library. Enter the stacked volume's volser then select the **Eject** button. The list box displays the stacked volumes that are currently in the process of being ejected.

When a stacked volume eject is initiated, a request is sent to the associated VTS to eject the stacked volume. The VTS then copies any active data off of the stacked volume onto other stacked volumes. When all active data has been removed, the VTS initiates the eject of the now empty stacked volume. This process can take a long time.

### Notes:

1. If the Library Manager is busy, the VTS is busy, and the stacked volume being ejected contains many active data files, the eject process may take a VERY long time (up to several hours).
2. Only one eject of a stacked volume can be in-progress for each VTS. If more than one is attempted, an error popup message will result.
3. Exported Stacked Volumes (those in the Unassigned, Import or Export-Hold categories) cannot be ejected using this panel. If this is attempted, an error popup message will result.

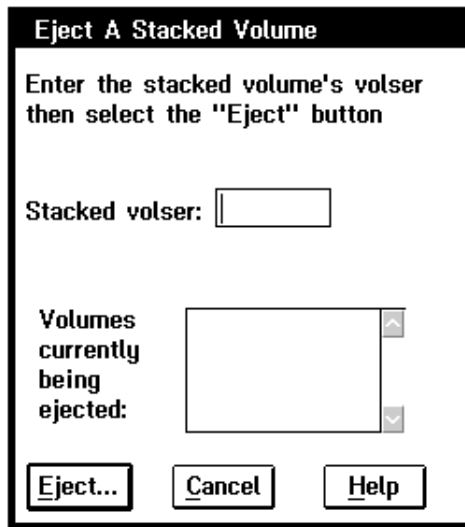

Figure 97. Eject a VTS Stacked Volume Pop-Up Window

The following are the push-buttons:

**Eject** Initiate the stacked volume eject operation. You are prompted to confirm the eject operation. Select **Yes** to continue the eject operation. Select **No** to cancel the eject operation.

**Cancel** Close the panel immediately, changes are saved.

**Help** Display the Eject a VTS Stacked Volume help panel.

## Set VTS Category Attributes

The Set VTS Category Attributes pop-up window allows categories to be defined as "Fast Ready" categories. A Fast Ready category means that any category mounts from this category can be accomplished without recalling data from a stacked volume. This enables quick mount times since a recall is not required to satisfy the mount request.

To define a "Fast Ready" category, enter the 4 digit hexadecimal category number, select the desired VTS, then select the **Add category** button.

To delete a category from the "Fast Ready" category list, highlight the category in the list box then select the **Delete category** button.

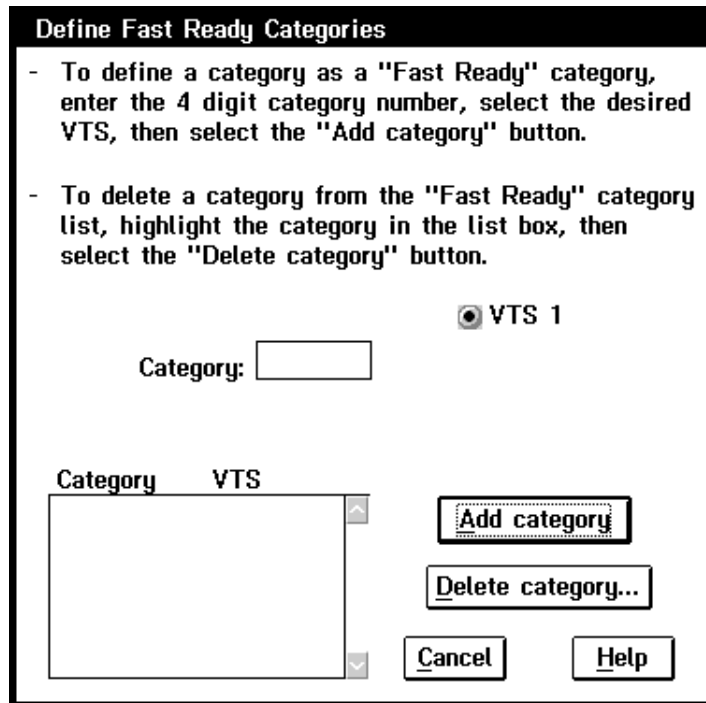

Figure 98. Set VTS Category Attributes Pop-Up Window

Following are the push-buttons:

**Add category**

Adds the entered category to the selected VTS's "Fast Ready" category list.

**Delete category**

Deletes the highlighted category from the associated VTS's "Fast Ready" category list. You are prompted to confirm the delete operation. Select **Yes** to continue the delete operation. Select **No** to cancel the delete operation.

**Cancel**

Close the panel immediately.

**Help**

Display the Set VTS Category Attributes help panel.

## Set VTS Management Policies

The Set VTS Management Policies pop-up window allows the Inhibit Reclaim Schedule, Free Storage Threshold, and Reclaim Threshold to be set.

The "Inhibit Reclaim Schedule" defines when the VTS should not perform reclaim operations. Reclaim operations require physical drives. This means that drives are used for reclaim operations at the same time others are used to recall data to satisfy mount requests. During times of heavy mount activity it may be desirable to make all of the physical drives available for recall operations. If these periods of heavy mount activity are predictable, the "Inhibit Reclaim Schedule" can be used to inhibit reclaim operations for the heavy mount activity periods. Up to 14 entries can be added to the schedule.

If the VTS must perform a reclaim in order to continue operating, the inhibit reclaim schedule is ignored.

Five drop-down lists and a set of check boxes are used to set up an inhibit reclaim entry. The drop-down lists contain the following:

- Day of week  
Sunday through Saturday or Every day. If “Every day” is selected, the “Start time” and “Duration” entered will apply to every day of the week.
- Start Hour and Minute  
The start hour and minute for the inhibit. A 24 hour clock is used where 00 in the hour field means midnight.
- Duration Hours and Minutes  
The number of hours and minutes that the inhibit reclaim should remain in effect. Up to 167 hours and 59 minutes can be specified (7 days minus 1 minute). Specifying the maximum will essentially always inhibit reclaim.
- Check boxes to indicate which VTS to apply the schedule to.

Add an entry to the inhibit reclaim schedule by selecting a day of week, a start time, the duration, then select the **Add** button.

Delete an entry by highlighting it in the list box then selecting the **Delete** button.

The *Free Storage Threshold* is used to provide a warning when the VTS is running low on free storage, the capacity of all the empty stacked volumes in the VTS. A threshold is provided for each VTS installed in the library and is entered in GB. The default value is 100 GB. The VTS Active Data window displays the Free Storage Threshold as the Free Storage Alarm Level. If the free storage drops below the threshold (alarm level), the Library Manager signals an intervention-required condition to notify the operator to add more stacked volumes.

The number of stacked volumes required to store the Free Storage Threshold GB specified on the Set VTS Management Policies window is dependent on the compression of data when writing from the Tape Volume Cache to the stacked volume. The 3494-B18 VTS with enhanced ESCON host attachments provides compression into the Tape Volume Cache; therefore, further compression when writing to the stacked volume is unlikely, and the capacity of a stacked volume will be approximately 10 GB of Tape Volume Cache data. The earlier VTS, 3494-B16, relied on the compression capability of the Magstar 3590 drives to store approximately 20 GB of Tape Volume Cache data, assuming a compression ratio of 2:1.

The Free Storage Threshold of 100 GB requires five empty cartridges for the model B16 VTS; however, with the model B18 VTS, a Free Storage Alarm is sent when only 10 empty stacked volumes are available because the Tape Volume Cache data has already been compressed when received into the Tape Volume Cache. Assuming a compression ratio of 3:1 with the enhanced ESCON host attachments, an alarm at the Free Storage Threshold of 100 GB, representing 10 empty stacked volumes, allows storage of 300 GB of logical volume data.

To get an alarm when the number of empty stacked volumes drops below 50, you would specify a Free Storage Threshold of 500 GB on a model B18 with enhanced ESCON attachments, and of 1000 GB on other VTS models.

The *Reclaim Threshold Percentage* is used to identify when a stacked volume is to be made available for reclamation. Each stacked volume has some amount of active data and some amount of inactive (no longer needed) data. If the percentage of active data is less than the percentage specified in this panel, the stacked

volume is available to go through reclamation. During the reclamation process all of the active data from the original stacked volume is moved to another stacked volume. After all active data is moved from the original stacked volume, its category is set to scratch. This makes it available for reuse.

The Reclaim Threshold Percentage is initially set at 10%. We recommend that you start with this value and slowly raise it by 5% increments, as necessary. As a general rule try not to go above 30% to 40%. It is better to add additional stacked volumes rather than raise this value. The higher this number is, the longer it takes the VTS subsystem to reclaim a stacked volume because more data must be copied from one stacked volume to another stacked volume. The Active Data Distribution bar graph will assist you in setting this number. See "VTS Active Data Distribution" on page 130, for information about displaying the panel.

Figure 99. Set VTS Management Policies Pop-Up Window

The following are the push-buttons:

- Add** Adds an entry to the inhibit reclaim schedule.
- Delete** Deletes an entry from the inhibit reclaim schedule.
- Save** Close the panel and save all the changes made to the inhibit reclaim schedule, reclaim threshold, and free storage threshold.
- Cancel** Close the panel without saving any of the changes.
- Help** Display the Set VTS Management Policies help panel.

## Inventory New Storage or Re-inventory Complete System

These selections are typically system administrator password-protected. The inventory process can only be performed when:

- The library manager is Offline and in Auto mode.
- The teach process is completed.
- The cleaner volume masks are set (see "Cleaner Volume Masks" on page 172).
- The volser ranges are set (see Figure 102 on page 171).

Select a type of inventory as follows:

- Inventory new storage (at subsystem installation time)

**Note:** Selecting inventory new storage causes any cartridges with unreadable external labels to be ejected.

- Re-inventory the complete system (at any time)

**Note:** If Virtual Tape Servers are installed, see “Re-Inventory with Virtual Tape Servers” on page 174.

**Note:** If **Re-inventory Complete System** is selected and there are VTS Import or Export stacked volumes in the Unassigned, Import, or Export-Hold categories, then the panel shown in Figure 100 will be displayed and the operator will not be allowed to continue with the reinventory until the Import/Export volumes are ejected from the library. The reinventory is blocked to prevent the possible destruction of important Exported data. The operator should exit this panel and then select the appropriate panel(s) under the **Commands** pulldown under **System Management** on the LM Operator Panel and eject the indicated volumes. When all the Import/Export volumes are removed from the library, the operator can then select **Reinventory Complete System** and continue.

Figure 100 shows the Display VTS Export/Import Volumes Window.

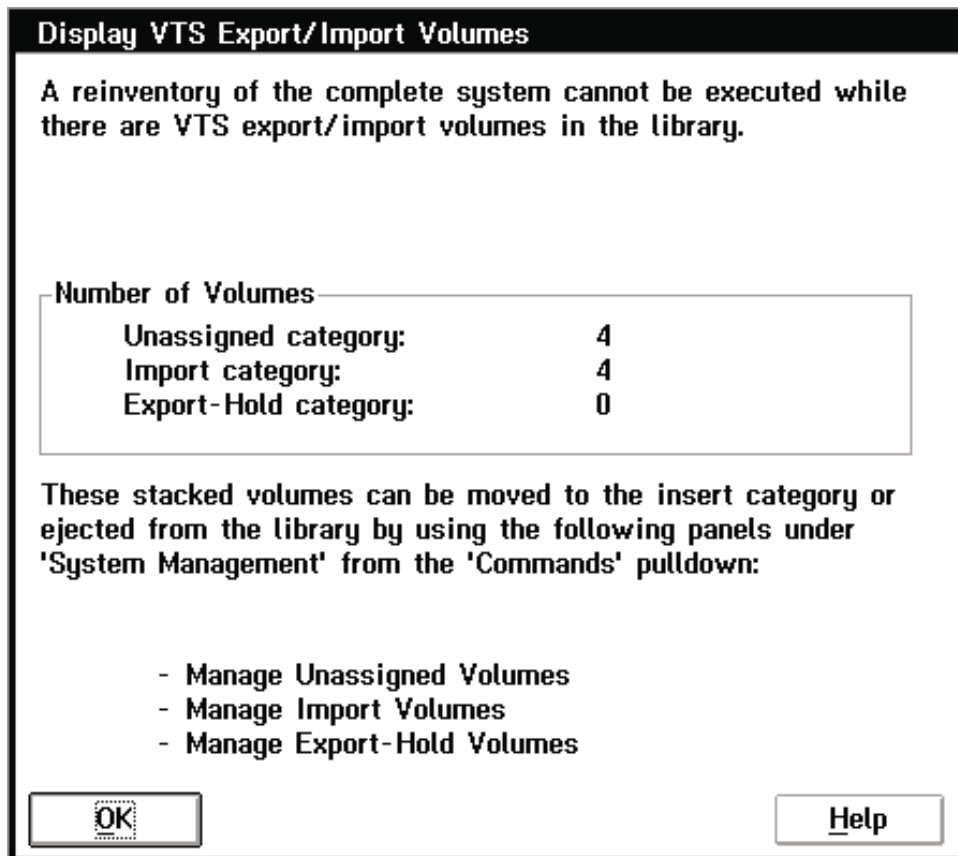

Figure 100. Display VTS Export/Import Volumes Window



## Save Logical Volumes

When a complete inventory is requested and the library contains a VTS, the operator is prompted to save the logical volumes. Answering Yes will save the logical volumes. They will not need to be reinserted after the inventory completes. Answering No will erase all the logical volumes. The logical volumes must be reinserted after the inventory completes.

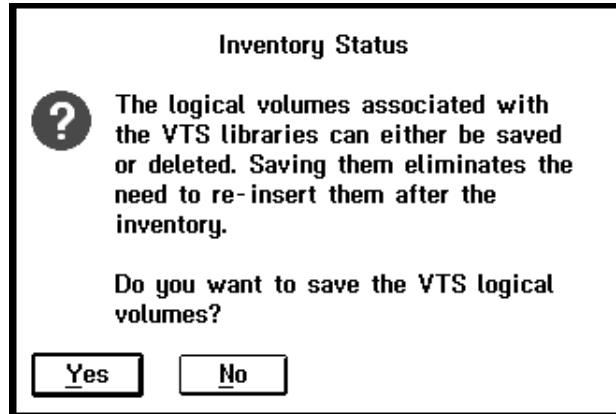

Figure 101. Save Logical Volumes Window

## Set the Volser Range

When selecting a type of inventory, an option is presented to set the volser ranges. See Figure 102 for information on how to set the volser range.

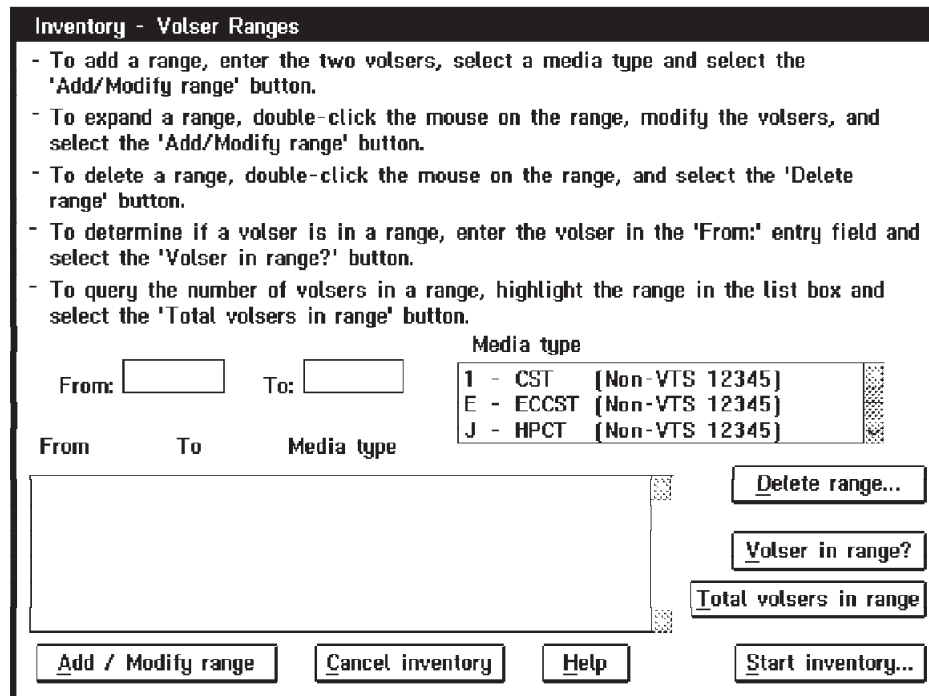

Figure 102. Set the Volser Range Window

This panel is similar to the volser ranges panel selectable from the commands pull down (refer to Figure 94 on page 162). The only difference is the addition of the "Start Inventory" button. Select this button after reviewing/modifying the volser ranges. Selecting the "Start Inventory" button allows the inventory process to continue. Selecting the "Cancel" button cancels the inventory process.

## Cleaner Volume Masks

When selecting a type of inventory, an option is presented to set the cleaner volume masks. At least one of the masks must be set (for example, CLN\*\*\*). The CLN prefix is not a requirement. Any valid volser can be used. See Figure 103 for information on how to set the cleaner volume masks.

The cleaner volume masks are external labels with patterns of characters used to identify which volumes are cleaner cartridges. The cleaner volume masks allow for identification of cleaning cartridges that either are put into the 3494 through an input station or are identified during an inventory operation. When identified, cleaner volumes are assigned to a cleaner volume category.

The pop-up window allows the entry of up to 10 cleaner masks. If this is the first time the masks are presented, the first mask is set to a default value of CLN\*\*\* and the other nine masks are set to blanks. If this is not the first time the masks are presented, whatever was last entered is displayed. The asterisk (\*) can be used in the mask and is interpreted as a wildcard character (any valid character). When the masks are set, any volser labels that match any of the masks are considered cleaner volumes.

**Inventory - Cleaner Masks**

Verify cleaner cartridge masks and change if required.

At least one mask must be specified. A mask must contain 6 characters. Use an asterisk [\*] as the wild card character (CLN\*\*\*).

Mask 1:	<input type="text" value="CLN***"/>	Mask 6:	<input type="text"/>
Mask 2:	<input type="text"/>	Mask 7:	<input type="text"/>
Mask 3:	<input type="text"/>	Mask 8:	<input type="text"/>
Mask 4:	<input type="text"/>	Mask 9:	<input type="text"/>
Mask 5:	<input type="text"/>	Mask 10:	<input type="text"/>

Figure 103. Inventory Cleaner Masks Pop-Up Window

The following are the push-buttons:

### Start inventory

Starts the inventory process.

### Cancel inventory

Cancels the inventory process.

**Help** Provides help for the Inventory Cleaner Masks pop-up window.

## Inventory Status

The Inventory Status pop-up window displays the status information about the inventory operation in progress. It is updated periodically as the operation progresses. See Figure 104.



Figure 104. Inventory Status Pop-Up Window

This pop-up window contains the following messages:

- **Rack XX is being inventoried and Number of racks complete.** This display occurs during the physical inventory operation.
- **Indexing database, please stand by.** This display occurs after the physical inventory operation.
- **Inventory cancel in progress, please stand by.** This display occurs when the inventory is cancelled.

**Note:** If the Dual Active Accessors Feature is installed, information is displayed for both accessors. See Figure 105.

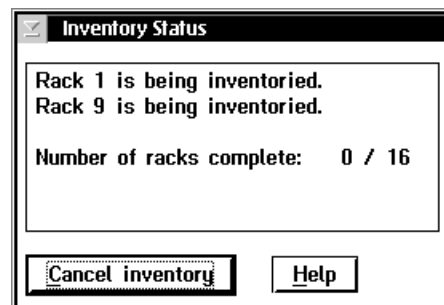

Figure 105. Inventory Status Pop-Up Window (Dual Active Accessor systems)

The following are the push-buttons:

### Cancel inventory

Cancel the inventory in progress. You are prompted to confirm your selection. If you select **Yes**, the inventory is cancelled, the current rack

being inventoried is marked not inventoried, and the window is closed. If you select **No**, the inventory continues. This push-button is disabled (grayed, or reduced contrast) during the indexing database phase.

**Note:** If the inventory is cancelled, select inventory new storage when ready to continue. This selection allows the inventory to continue from the point that the original inventory was cancelled.

**Help** Display information about this pop-up window.

## Re-Inventory with Virtual Tape Servers

Prior to selecting "Re-inventory complete system", VTS stacked volumes which are mounted on the 3590 tape drives which are associated with the VTS must be returned to 3494 Tape Library cartridge storage cells. This is achieved by setting the VTS subsystems to the OFFLINE state before setting the 3494 Tape Library to the OFFLINE state.

To prepare for "Re-inventory complete system":

1. All logical libraries (Virtual Tape Servers and non-VTS logical libraries, if any) must be varied offline at the attaching hosts.
2. Select **Service menu** from the **Mode** pull-down to allow access to additional service functions.
3. From the **Service** pull-down, shown in Figure 106 on page 175, select **VTS Subsystem Management** and **Online/Offline** to display the VTS Online/Offline Panel (Figure 107 on page 176).
4. Set the VTS unit(s) Offline by performing the following steps:
  - a. Select **VTS1-> Offline** and wait for messages indicating Offline initiated successfully and Offline completed successfully. If an error message is displayed, contact your service representative.
  - b. If a second VTS is installed, select **VTS2->Offline** and wait for messages indicating Offline initiated successfully and Offline completed successfully.
  - c. When all VTS units are offline, close the panel by selecting **Cancel** on the **Online/Offline** panel.
5. Place the 3494 Tape Library in the Offline state using the **Mode** pull-down.
6. From the **Commands** pull-down, select **Inventory** and then select **Re-inventory complete system**. When the inventory operation is complete, return the tape library to the **Online** state using the **Mode** pull-down.

**Note:** Be sure to select **Yes** on the Save Logical Volumes Window (see Figure 101 on page 171) when asked if you want to save the VTS logical volumes.

7. From the **Service** pull-down, place all Virtual Tape Servers Online using **VTS Subsystem Management** and **Online/Offline** displays.
8. Select **Operator menu** from the **Mode** pull-down to display only operator action bar items.
9. Attaching hosts may vary libraries online.

Figure 106 on page 175 shows the Service Pull-Down Menu.

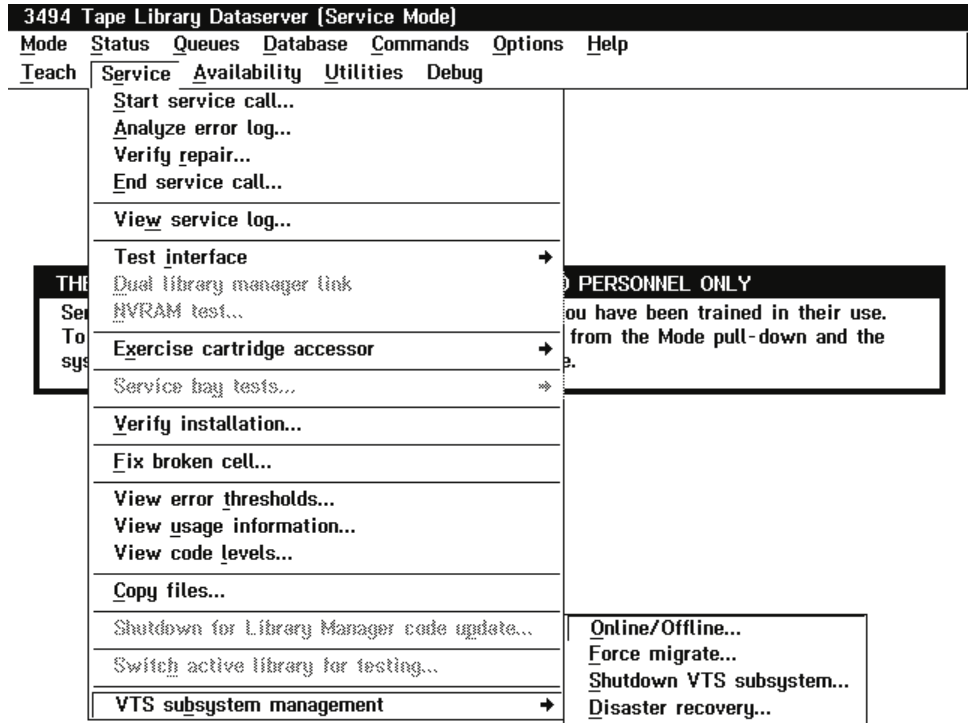

Figure 106. Service Pull-down Menu

Figure 107 on page 176 shows the VTS Online/Offline Pop-Up Window.

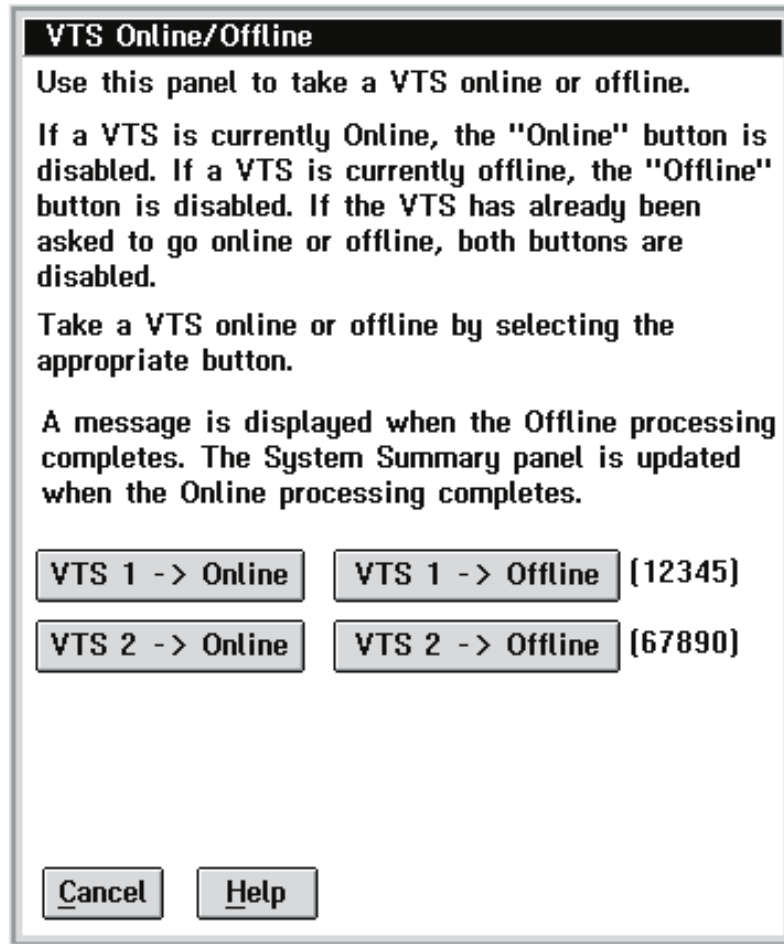

Figure 107. VTS Online/Offline Pop-Up Window

## Inventory Update

The Inventory Update facility allows for the following operations:

- Disable Inventory Update
- Enable Inventory Update
- Perform Inventory Update (Full)
- Perform Inventory Update (Partial)

### Disable Inventory Update

Select Disable Inventory Update to prevent the inventory update from being performed after opening and closing a door.

This selection is remembered across shutdowns. See Figure 108 on page 177 for the Disable Inventory Update dialog box.

**Note:** Cartridges should only be inserted or ejected through an I/O facility while Inventory Update is disabled.

This is typically a system administrator password-protected function. The password-protection option can be selected during installation. (See “System Administrator Password” on page 200.)



Figure 108. Disable Inventory Update Dialog Box

## Enable Inventory Update

Select Enable Inventory Update for an inventory update to be performed after opening and closing a door. Figure 109 shows the Enable Inventory Update dialog box.

This selection is remembered across shutdowns.

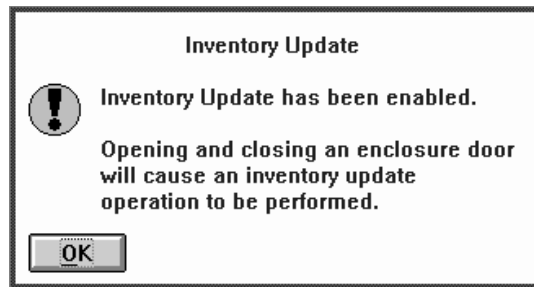

Figure 109. Enable Inventory Update Dialog Box

## Perform Inventory Update (Full)

Select Perform Inventory Update (Full) to perform an inventory update immediately. All frames in the library will be inventoried. Figure 111 shows the Perform Inventory Update status dialog box.

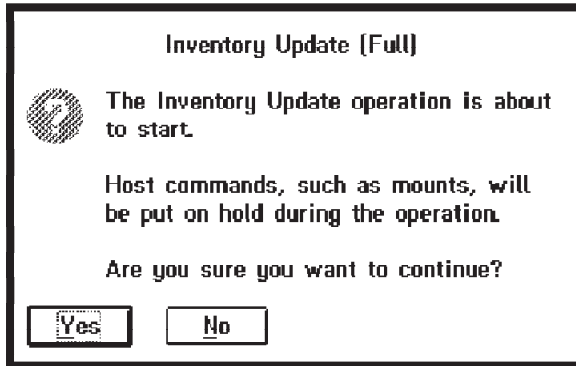

Figure 110. Perform Inventory Update Dialog Box

The Inventory Update Status pop-up window Figure 111 displays the status information about the inventory update operation in progress.

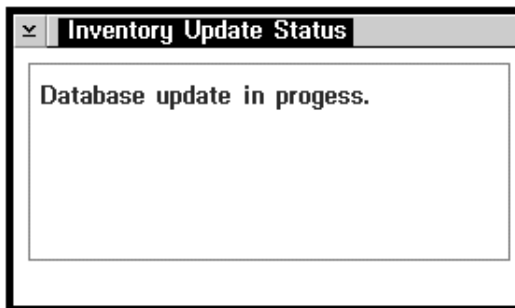

Figure 111. Inventory Update Status Box

The pop-up window contains the following messages:

- **Rack XX is being inventoried** and **Number of racks complete**. This display occurs during the physical inventory operation.
- **Database update in progress**. This display occurs after the physical inventory operation.

**Note:** If the Dual Active Accessors Feature is installed, information is displayed for both accessors. See Figure 112.

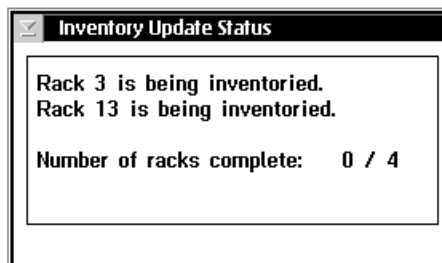

Figure 112. Inventory Update Status Box (Dual Active Accessor systems)



## Perform Inventory Update (Partial)

Only those frames associated with doors that have been opened will be inventoried. If adjacent frame update was enabled during teach, the frames to either side will also be inventoried. If dual active accessors is installed, both accessors are used if racks on both sides of the library are being inventoried; otherwise only one accessor is used.

The panel in Figure 113 is used to select which frames should be scanned during the inventory update operation.

1. A checked checkbox indicates that a frame's door has been opened since the last inventory.
2. An unchecked box indicates that a frame's door has not been opened since the last inventory.
3. The partial inventory update operation will inventory the frames whose checkbox is checked.
4. Check or uncheck the checkboxes to reflect which frames you want inventoried then press the **Perform inventory update...** button.
5. Mounts and demounts are allowed during an inventory update, for cartridges that are in a rack which has already been inventoried or is not involved in the inventory update. However, performing mounts and demounts during an inventory update does affect the duration of the inventory update operation.

This panel's pushbuttons are:

### Perform inventory update

Begin the inventory update operation on the selected frames.

### Cancel

Cancel the frame selection.

**Help** Display this help panel.

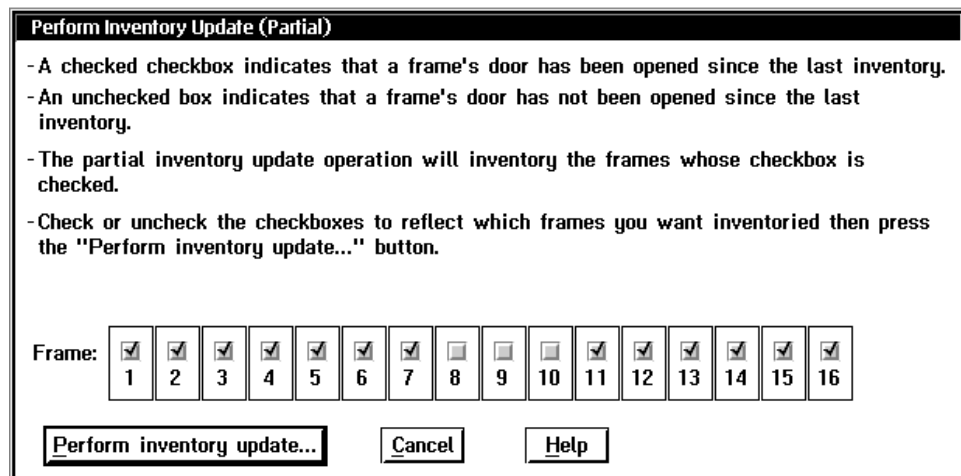

Figure 113. Perform Inventory Update (Partial) Window

## Stand-Alone Device

The stand-alone drive facility allows for the following operations:

- Setup stand-alone drive
- Reset stand-alone drive
- Stand-alone drive status

### Setup Stand-Alone Device

The Setup Stand-Alone Device selection allows a drive to be set up in stand-alone mode. This mode is used to allow a host to run software that, in general, is in complete control of the drive. The software needs to be attached to a tape drive that is physically or virtually inside a library. The software is not aware that the drive is in the library, and it cannot issue commands to mount and demount volumes in that library.

Stand-Alone drive is supported for virtual drives within a Virtual Tape Server with the exception of the "Mount from Input Station" feature.

Stand-Alone drive is not supported for the physical drives associated with a Virtual Tape Server.

To assist the host software, stand-alone mode is used by the library to automatically load and unload one or more specific cartridges into a specific drive, without any host software interaction. The host software allows the operator to specify which cartridge is mounted and demounted into a drive by using the library manager console. Figure 114 on page 181 shows the Setup Stand-Alone Device Pop-Up Window.

**Note:** The drive that is being used in stand-alone mode should be varied off from all hosts except the host that is being used in this special mode. This will prevent unwanted interaction from all hosts except the desired one.

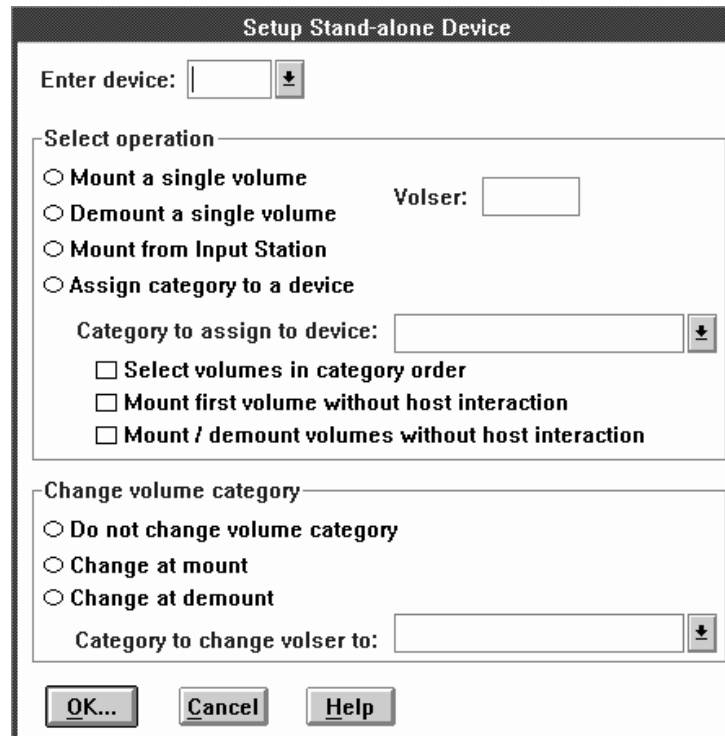

Figure 114. Setup Stand-Alone Device Pop-Up Window

#### Enter device

This drop-down list box lists all the drives in the library, including virtual drives. It excludes physical drives associated with a Virtual Tape Server.

The selectable operations are as follows:

#### Mount a single volume

This operation causes the single volume to be mounted in a requested drive. When this operation is selected, a volser must be entered in the **volser** field and either **Do not change volume category** or **Change at mount** must be selected.

#### Demount a single volume

This operation causes a single volume to be demounted from the requested drive. When this operation is selected, a volser can be entered in the **volser** field or the field can be left blank. If the field is left blank, the volume currently mounted in the drive is demounted. **Do not change volume category** or **Change at demount** must be selected for this operation.

#### Mount from Input Station

This operation mounts non-library cartridges located in the Convenience Input/Output Station directly on the requested drive and then returns them to the Convenience Input/Output Station after unloading.

Mount from Input Station is not supported for virtual drives within a VTS.

#### Assign category to a device

This operation causes a category to be assigned to a drive. When this operation is selected, a **Category to assign to device** must be entered and one of three **Change volume category** options must be selected.

**Note:** If the **Select volumes in category order** is selected, one of the following (mount) options should also be selected or the drive will not be put in stand-alone mode.

**Volser** This entry field is active when either the **Mount a single volume** or **Demount a single volume** is selected. This field must be filled out for the **Mount a single volume** but is optional for the **Demount a single volume** selection.

**Category to assign to device**

This entry field is active when **Assign category to a device** is selected. A valid category must be entered. The drop-down list displays the current user categories and their host-assigned aliases.

**Select volumes in category order**

This option is available if **Assign category to a device** has been selected. Selecting this option causes volumes to be mounted in their category order.

**Mount first volume without host interaction**

This option is available if **Assign category to a device** has been selected. Selecting this option causes the first mount to a device to be performed without host interaction.

**Mount/demount volumes without host interaction**

This option is available if **Assign category to a device** has been selected. Selecting this option causes mounts and demounts to be performed automatically without host interaction.

The following are methods for changing a volume's category:

**Do not change volume category**

This selection leaves the volume category alone during the stand-alone device operation.

**Change at mount**

This selection changes the volume's category when a volume is mounted. If this method is selected, a valid entry must be made into **Category to change volser to:** field.

**Change at demount**

This selection changes the volume's category when the volume is demounted. If this method is selected, a valid entry must be made into the **Category to change volser to:** field.

**Category to change volser to:**

A valid category must be entered in this field. The drop-down list displays the current user categories and their host-assigned aliases.

The following are the push-buttons:

**OK** Requests that a device be set up as stand-alone device. If the information entered is valid, you are prompted to confirm the request.

**Cancel**

Closes this panel without setting up a device as stand-alone.

**Help** Displays help for this panel.

**Reset Stand-Alone Device**

This selection allows a device to be taken out of stand-alone mode. The panel presents a list of devices that are currently in stand-alone mode. The device to be

reset is selected and then the **Reset** button is selected. A message is displayed if there are no devices currently in stand-alone mode. Figure 115 shows the Reset Stand-Alone Device Pop-Up Window.

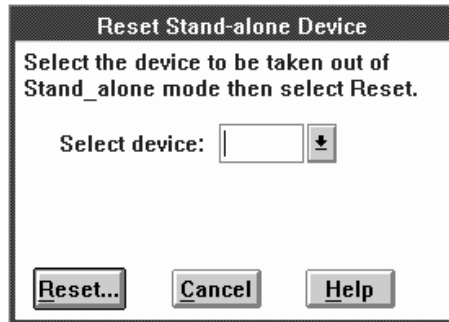

Figure 115. Reset Stand-Alone Device Pop-Up Window

**Reset** Request that a device be taken out of stand-alone mode. If a valid device is entered, you are prompted to confirm your request.

**Cancel**

Closes this panel without resetting a stand-alone device.

**Help**

Displays help for this panel.

## Stand-Alone Device Status

Each device set up as a stand-alone device has a separate status panel. Figure 116 shows the Stand-Alone Device Status Pop-Up Window.

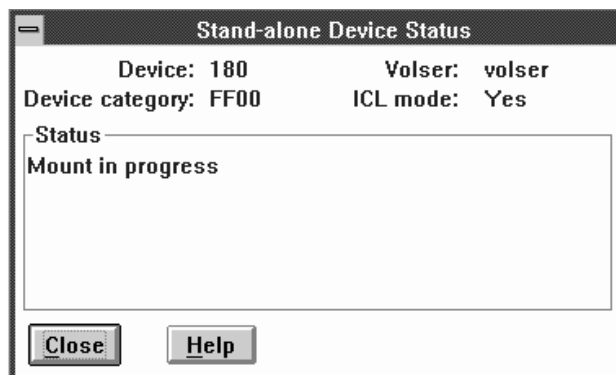

Figure 116. Stand-Alone Device Status Pop-Up Window

**Device**

The device identification of the stand-alone device.

**Device category**

The category associated with the stand-alone device, if any. The device category is displayed as 0 if the device does not have an associated category. The FFF7 category is used for Mount From Input Station.

**Volser**

Displays the volser of the currently mounted volume or the volser of the volume in the process of being mounted.

**ICL mode**

A device is set up to implicitly mount and demount volumes if the **Mount /**

**demount volumes without host interaction** option was selected when the device was set up as a stand-alone device. The ICL mode status is displayed as Yes if this option was selected and displayed as No if the option was not selected.

**Status**

The current status of the device is displayed here.

**Close** This selection removes this window from the display.

**Help** Displays the help for this panel.

## Insert Unlabeled Cartridges

**Note:** Do not use this function with cartridges with machine-readable labels.

The Insert Unlabeled Cartridges operation is designed to allow the operator to insert volumes into the library manager database that do not have an external machine readable label. These volumes may be used in the same manner that regular, properly labelled, volumes are used, except for operations requiring an external machine readable label. To insert unlabeled cartridges, follow these steps:

1. Ensure the Convenience Input/Output Station is empty.
2. Enter the volsers and the cartridge type of all the cartridges to be inserted in the spaces on the Insert Unlabeled Cartridges pop-up window. Figure 117 on page 185 shows the Insert Unlabeled Cartridges pop-up window.

**Note:** If a volume with a machine readable label is inserted with a different volser entered on the pop-up window, problems will occur during a subsequent Inventory or Inventory Update operation.

3. Place the cartridges in the Convenience Input/Output Station in the same sequence as represented on the pop-up window and close the Convenience Input/Output Station door.
4. Select the **OK** button.

Each volser entered is checked to ensure it is a valid number and that no other cartridge in the library has the same number. The validity of the cartridge type is also checked. Valid characters for an unlabeled cartridge volser are alphanumeric characters plus the following special characters: **- # & \$ @**. The cartridges are then inserted into the library. After all the cartridges are inserted into the library, the operation may be repeated.

If the misplaced or inaccessible flags are set for an existing volser in the library, the cartridge is inserted and the flags are cleared.

5. Select **Cancel** to cancel the Insert Unlabeled Cartridges operation.

The Insert Unlabeled Cartridge function can be used to insert empty stacked volumes for a VTS. To be successful, the volser must fall into a stacked volume volser range (see Figure 117 on page 185) and the media type must be a "J". However, it is recommended that the Insert Unlabeled cartridge function **NOT** be used for stacked volumes in normal operations. It should only be used for re-inserting volumes that have a damaged external label.

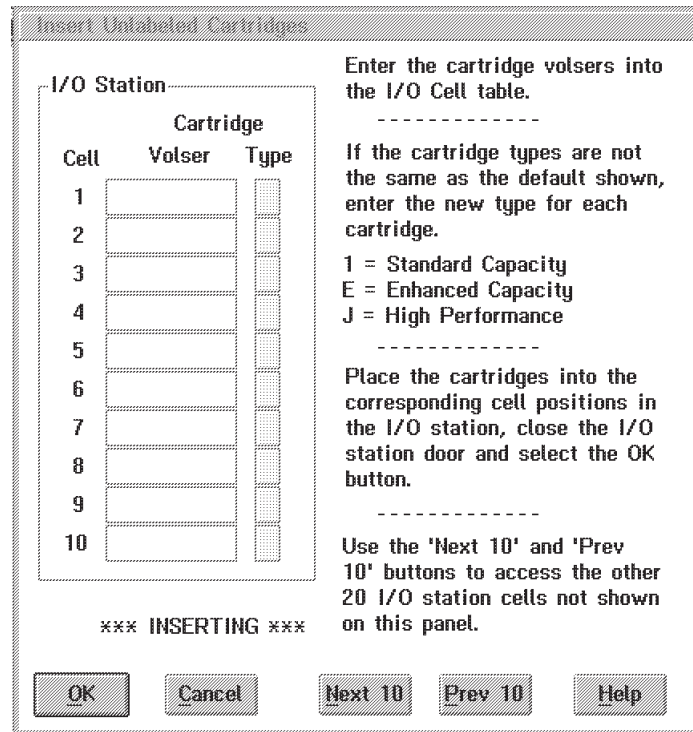

Figure 117. Insert Unlabeled Cartridges Window

The following are the push-buttons:

<b>OK</b>	Perform the Insert Unlabeled Cartridges operation.
<b>Help</b>	Display the help panel
<b>Cancel</b>	Close this panel and cancel the Insert Unlabeled Cartridges operation.
<b>Next 10</b>	Displays the next ten cells when the optional 30 cell I/O is installed.
<b>Previous 10</b>	Displays the previous ten cells when the optional 30 cell I/O is installed.

## Add LAN Host

This panel allows a LAN attached host to be configured for communication with this 3494. Up to 32 LAN host ports can be configured. The information to be entered may be available from a command on the host. For example, on the AS/400, the Display LAN Information (DSPLANMLD) command will provide this information. The person who set up your LAN configuration may also be able to provide this information. Figure 118 on page 186 shows the Add LAN Host to Library pop-up window.

### Communication Protocol

Select the type of communication protocol for use with this host.

Each LAN host has a particular LAN protocol that it uses to communicate with the 3494. Following are some of the hosts and their associated protocols:

**AS/400**  
uses APPC

The following commands on the AS/400 will provide the information needed to fill in the Add LAN Host Screen:

- If the AS/400 operating system is less than version V3R6, use DSPLANMLD, Display LAN Information.
- If the AS/400 operating system is version V3R6 or higher, use DSPLANMLB, Display LAN Media Library Information.

**VSE/ESA**

uses APPC/VTAM

**RISC System/6000**

uses TCP/IP

**SUN** uses TCP/IP

**90765 SP2**

uses TCP/IP

If APPC is selected as the communications protocol, a pop-up window as shown in Figure 118 will appear. This allows a LAN connected host such as an AS/400 to be added to the 3494 configuration. Fill in the following fields:

**Add LAN Host to Library**

Communication Protocol

APPC     APPC/VTAM     TCP/IP

Host Alias (optional)    TUCF400F

Host Transaction Program Name    QMLD/QMLDSTRCC

Host Network ID    US1BMSU

Host Location Name    S10A4045

Host Adapter Address    1000A5E12E75

Ethernet Format

XID (optional)    05D11251

OK    Cancel    Help

Figure 118. Add LAN Host to Library Pop-Up Window (APPC Selected)

**Host Alias**

The alias for a host is a customer supplied nickname for that host. This is an optional field and may be left blank if an alias is not desired. This entry field will only accept alpha-numeric characters and the “.” character.

**Host Transaction Program Name**

Specifies the name of the LAN transaction program that runs on the host to receive data from the Library Manager. For example, on the AS/400, the LAN transaction program name is **QMLD/QMLDSTRCC**. This entry field will only accept alpha-numeric characters and the “/” character. Blank spaces are not valid.



### Host Network ID

Specifies the name of the remote network in which the adjacent control point (the host) resides. This entry field will only accept alpha-numeric characters and the “@”, “#”, and “\$” characters. Blank spaces are not valid.

The Common Programming Interface (CPI) - Communications partner\_LU\_name of the host, consists of the host remote network identifier and the host remote location. For example, if the host partner\_LU\_name is **USIBMSU.S10A4045**, then the Host Network ID is **USIBMSU**.

### Host Location Name

Specifies the remote location name (of the host) to which the 3494 will communicate. This entry field will only accept alpha-numeric characters and the “@”, “#”, and “\$” characters. Blank spaces are not valid.

The Common Programming Interface (CPI) - Communications partner\_LU\_name of the host, consists of the remote network identifier and the remote location. For example, if the host partner\_LU\_name is **USIBMSU.S10A4045**, then the Host Location Name is **S10A4045**.

### Host Adapter Address

Specifies the LAN adapter address of the remote controller (the host). This can be the host adapter card universally administered address (UAA), such as 10005A1E3338, or a locally administered address (LAA), such as 400012345678. Only hexadecimal digits may be entered in this field. Blank spaces are not valid. This entry field will only accept alpha-numeric characters and the “@”, “#”, and “\$” characters. Blank spaces are not valid.

### Ethernet Format Check Box

If the adapter address is in Ethernet Format, check this box.

**XID** (Exchange ID) This is an optional field. If left blank, the XID will be assigned a value of “00000000”. If an XID value is entered, it must be either five or eight hexadecimal bytes. If only five bytes are entered, the prefix “05D” will be used.

**Note:** XID is optional for APPC and APPC/VTAM hosts. Not applicable for TCP/IP hosts.

The following are the push-buttons:

**OK** The information on this window will be used to add a LAN attached host to the library system.

### Cancel

Close this window without adding a host operation.

**Help** Display the help panel.

If APPC/VTAM is selected as the communications protocol, an Add LAN Host to Library pop-up window as shown in Figure 119 on page 188 will appear. This allows a LAN connected host such as VSE/ESA to be added to the 3494 configuration. Fill in the following fields:

**Add LAN Host to Library**

Communication Protocol  
 APPC     APPC/VTAM     TCP/IP

Host Alias (optional)    BLD1VTAM

Host Transaction Program Name    VSE1LCA

Host Network ID    USIBMSU

Host Location Name    VSE1LCA

Host Adapter Address    400011112222  
 Ethernet Format

Physical Unit Name    VSE3174

XID (optional)    78021

OK    Cancel    Help

Figure 119. Add LAN Host to Library Pop-Up Window (APPC/VTAM Selected)

#### Host Alias (optional)

The alias for a host is a customer supplied nickname for that host. This is an optional field and may be left blank if an alias is not desired. This entry field will only accept alpha-numeric characters and the "." character.

#### Host Transaction Program Name

Specifies the name of the LAN transaction program that runs on the host to receive data from the Library Manager. This entry field will only accept alpha-numeric characters and the "/" character. Blank spaces are not valid.

For example, if the host is VSE/ESA, the default transaction program name is **VSE1LCA**.

#### Host Network ID

Specifies the name of the remote network in which the adjacent control point (the host) resides. This entry field will only accept alpha-numeric characters and the "@", "#", and "\$" characters. Blank spaces are not valid.

The Common Programming Interface (CPI) - Communications partner\_LU\_name of the host, consists of the host remote network identifier and the host remote location. For example, if the host partner\_LU\_name is **USIBMSU.VSE1LCA**, then the Host Network ID is **USIBMSU**.

#### Host Location Name

Specifies the remote location name (of the host) to which the 3494 will communicate. This entry field will only accept alpha-numeric characters and the "@", "#", and "\$" characters. Blank spaces are not valid.

The Common Programming Interface (CPI) - Communications partner\_LU\_name of the host, consists of the remote network identifier and the remote location. For example, if the host partner\_LU\_name is **USIBMSU.VSE1LCA**, then the Host Location Name is **VSE1LCA**.

**Host Adapter Address**

Specifies the LAN adapter address of the remote controller (host). This can be the host adapter card universally administered address (UAA), such as 10005A1E3338, or a locally administered address (LAA), such as 400012345678. This entry field will only accept alpha-numeric characters and the "@", "#", and "\$" character. Blank spaces are not valid.

**Ethernet Format Check Box**

If the adapter address is in Ethernet Format, check this box.

**Physical Unit Name**

This is the name of the physical unit the 3494 will communicate with for this host, for example, VSE3174. The physical unit name must be either 8 or fewer characters, or 8 or fewer characters followed by a period (.) and 8 or fewer characters. This field will only accept alpha-numeric characters and the "." character. Blank spaces are not valid.

**XID** (Exchange ID) This is an optional field. If left blank, the XID will be assigned a value of "00000000". If an XID value is entered, it must be either five or eight hexadecimal bytes. If only five bytes are entered, the prefix "05D" will be used.

**Note:** XID is optional for APPC and APPC/VTAM hosts. Not applicable for TCP/IP hosts.

The following are the push-buttons:

**OK** The information on this window is used to add a LAN attached host to the library system.

**Cancel**

Close this window without adding a host operation.

**Help**

Display the help panel.

If TCP/IP is selected as the communications protocol, an Add LAN Host to Library pop-up window as shown in Figure 120 on page 190 will appear. This allows a LAN connected host such as a RISC System/6000 to be added to the 3494 configuration. Fill in the following fields:

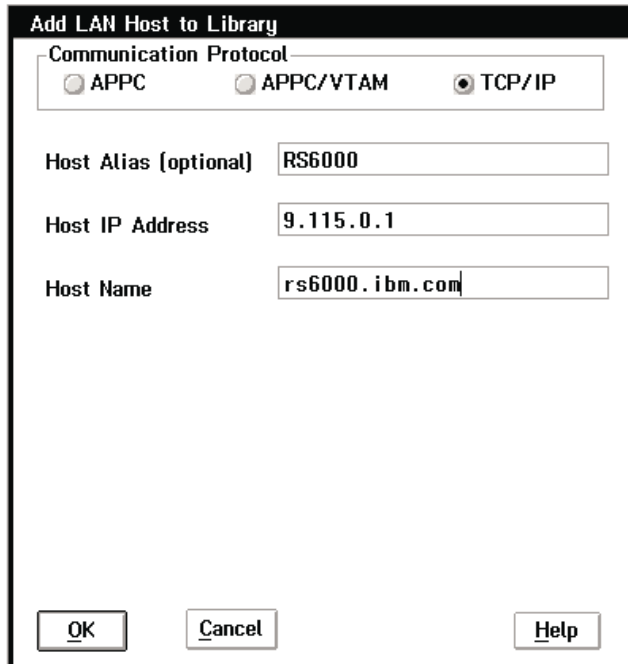

Figure 120. Add LAN Host to Library Pop-Up Window (TCP/IP Selected)

#### Host Alias (optional)

The alias for a host is a customer supplied nickname for that host. This is an optional field and may be left blank if an alias is not desired. This entry field will only accept alpha-numeric characters and the “.”, “-”, and “\_” characters.

#### Host IP Address

The Host IP Address is the unique internet address assigned to the host. This field will only accept digits and the “.”, “-”, and “\_” characters. Blank spaces are not valid. The correct form is xxx.xxx.xxx.xxx where xxx represents a number from 000 to 255.

#### Host Name

The Host Name is the Hostname defined in the TCP/IP network. This field will only accept alpha-numeric characters and the “.”, “-”, and “\_” characters. Blank spaces are not valid.

The following are the push-buttons:

**OK** The information on this window will be used to add a LAN attached host to the library system.

**Cancel** Close this window without adding a host.

**Help** Display the help panel.

## Delete LAN Host

Figure 121 on page 191 shows the Delete Host from Library pop-up window. From this pop-up window, select the LAN-connected host to be deleted from the 3494 configuration. The 3494 will no longer respond to requests from the deleted host.

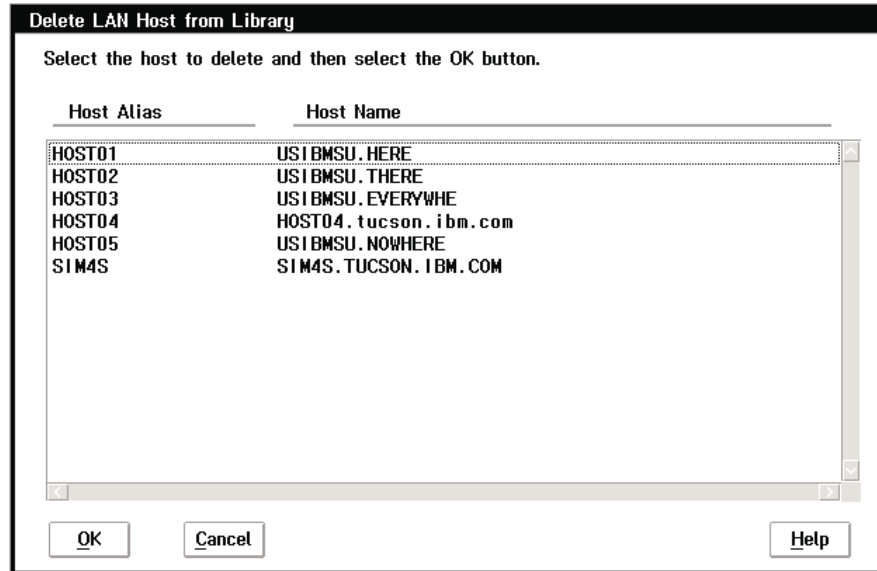

Figure 121. Delete LAN Host from Library Pop-Up Window

### Host Alias (optional)

The alias for a host is a customer supplied nickname for that host. This is an optional field and may be left blank if an alias is not desired.

### Host Name

This field lists the names of all hosts that are configured with the library system via LAN.

For TCP/IP hosts, the Host Name is the Hostname defined in the TCP/IP network. In Figure 121, **rs6000.tucson.com** is a TCP/IP Hostname.

For APPC and APPC/VTAM hosts, the Host Name is a combination of the Host Network ID and the Host Location Name. For example, if the Host Network ID is **USIBMSU**, and the Host Location Name is **S10A4045**, then the Host Name is **USIBMSU.S10A4045**.

This window displays the host names and (if set up) the host aliases of all the hosts that are configured with the library system via LAN. Select the host to be deleted and select the **OK** button.

A caution window will pop up to make sure that you really want to delete this host. Selecting the **Yes** button on this window will delete the host from the library system. The following are the push-buttons:

**OK** Delete the selected host from the library system.

**Cancel** Close this window without deleting a host.

**Help** Display the help panel.

## Update LAN Host Information

Figure 122 on page 192 shows the Update Host Information pop-up window. This pop-up window allows a particular LAN connected host to be selected to update

that hosts 3494 LAN configuration data. After a host is selected, the host information can be updated.

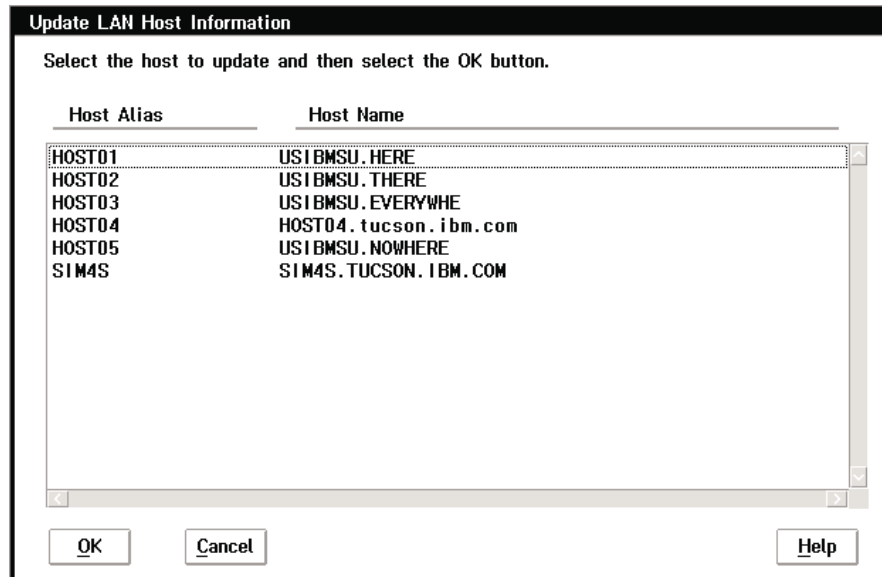

Figure 122. Update LAN Host Information Pop-Up Window

#### Host Alias (optional)

The alias for a host is a customer supplied nickname for that host. This is an optional field and may be left blank if an alias is not desired.

#### Host Name

This field lists the names of all the hosts that are configured with the library system via LAN.

For TCP/IP hosts, the Host Name is the Hostname defined in the TCP/IP network. In Figure 122, **rs6000.tucson.com** is a TCP/IP Hostname.

For APPC and APPC/VTAM hosts, the Host Name is a combination of the Host Network ID and the Host Location Name. For example, if the Host Network ID is **USIBMSU**, and the Host Location Name is **S10A4045**, then the Host Name is **USIBMSU.S10A4045**.

Select the host that requires updating and select the **OK** button. This will display the Change LAN Host Information window showing the current LAN host information. The following are the push-buttons on the Update LAN Host Information pop-up window:

**OK** Close the window and open a new window showing the information for the host selected.

#### Cancel

Close the panel without selecting a host for update.

#### Help

Display the help panel.

Figure 123 on page 193 shows the Change Host Information pop-up window for APPC hosts. Figure 124 on page 195 shows the Change Host Information pop-up window for APPC/VTAM hosts. Figure 125 on page 197 shows the Change Host Information pop-up window for TCP/IP hosts. These pop-up windows allow information about a

LAN host to be changed in the 3494 configuration. When this is done, the 3494 responds to the host with the new configuration data.

The image shows a dialog box titled "Change LAN Host Information". It contains a message: "Make changes to any of the fields shown below and then select the OK button to update the host information with these changes." Below the message are several input fields: "Host Alias (optional)" with the value "HOST01", "Host Transaction Program Name" with "VSE/ESA", "Host Network ID" with "USIBMSU", "Host Location Name" with "HERE", "Host Adapter Address" with "123456789ABC" and a checked "Ethernet Format" checkbox, and "XID (optional)" with "05D12345". At the bottom are "OK", "Cancel", and "Help" buttons.

Figure 123. Change LAN Host Information Pop-Up Window (APPC)

#### Host Alias (optional)

The alias for a host is a customer supplied nickname for that host. This is an optional field and may be left blank if an alias is not desired. This entry field will only accept alpha-numeric characters and the ".", "-", and "\_" characters.

#### Host Transaction Program Name

Specifies the name of the LAN transaction program that runs on the host to receive data from the Library Manager. This entry field will only accept alpha-numeric characters and the "/" character. Blank spaces are not valid.

#### Host Network ID

Specifies the name of the remote network in which the adjacent control point (host) resides. This entry field will only accept alpha-numeric characters and the "@", "#", and "\$" characters. Blank spaces are not valid.

The Common Programming Interface (CPI) - Communications partner\_LU\_name of the host, consists of the host remote network identifier and the host remote location. For example, if the host partner\_LU\_name is **USIBMSU.S10A4045**, then the Host Network ID is **USIBMSU**.

#### Host Location Name

Specifies the remote location name (of the host) to which the 3494 will communicate. This entry field will only accept alpha-numeric characters and the "@", "#", and "\$" characters. Blank spaces are not valid.

The Common Programming Interface (CPI) - Communications partner\_LU\_name of the host, consists of the remote network identifier and the remote location. For example, if the host partner\_LU\_name is **USIBMSU.S10A4045**, then the Host Location Name is **S10A4045**.

**Host Adapter Address**

Specifies the LAN adapter address of the remote controller (host). This can be the host adapter card universally administered address (UAA), such as 10005A1E3338, or a locally administered address (LAA), such as 400012345678. Only hexadecimal digits can be entered. Blank spaces are invalid.

**Ethernet Format Check Box**

If the adapter address is in Ethernet Format, check this box.

**XID (optional)**

(Exchange ID) This is an optional field. If left blank, the XID will be assigned a value of "00000000". If an XID value is entered, it must be either five or eight hexadecimal bytes. If only five bytes are entered, the prefix "05D" will be used.

**Note:** XID is optional for APPC and APPC/VTAM hosts. Not applicable for TCP/IP hosts.

**Note:** If the host is AS/400, the following commands on the AS/400 will provide the information needed to update the Change LAN Host Information screen:

- If the AS/400 operating system is less than version V3R6, use DSPLANMLD, Display LAN Information.
- If the AS/400 operating system is version V3R6, or higher, use DSPLANMLB, Display LAN Media Library Information.

The following are the push-buttons on the Change Host Information pop-up window:

**OK** Update the LAN host information using the changes entered on this window.

**Cancel**

Close the panel without updating the host information.

**Help** Display the help panel.

Figure 124 on page 195 shows the Change Host Information pop-up window for APPC/VTAM hosts. This pop-up window allows information about a LAN host to be changed in the 3494 configuration. When this is done, the 3494 responds to the host with the new configuration data.



**Change LAN Host Information**

Make changes to any of the fields shown below and then select the OK button to update the host information with these changes.

Host Alias (optional)

Host Transaction Program Name

Host Network ID

Host Location Name

Host Adapter Address   
 Ethernet Format

Physical Unit Name

XID (optional)

Figure 124. Change LAN Host Information Pop-Up Window (APPC/VTAM)

#### Host Alias (optional)

The alias for a host is a customer supplied nickname for that host. This is an optional field and may be left blank if an alias is not desired. This entry field will only accept alpha-numeric characters and the “.”, “-”, and “\_” characters.

#### Host Transaction Program Name

Specifies the name of the LAN transaction program that runs on the host to receive data from the Library Manager. This entry field will only accept alpha-numeric characters and the “/” character. Blank spaces are not valid.

#### Host Network ID

Specifies the name of the remote network in which the adjacent control point (host) resides. This entry field will only accept alpha-numeric characters and the “@”, “#”, and “\$” characters. Blank spaces are not valid.

The Common Programming Interface (CPI) - Communications partner\_LU\_name of the host, consists of the host remote network identifier and the host remote location. For example, if the host partner\_LU\_name is **USIBMSU.S10A4045**, then the Host Network ID is **USIBMSU**.

#### Host Location Name

Specifies the remote location name (of the host) to which the 3494 will communicate. This entry field will only accept alpha-numeric characters and the “@”, “#”, and “\$” characters. Blank spaces are not valid.

The Common Programming Interface (CPI) - Communications partner\_LU\_name of the host, consists of the remote network identifier and the remote location. For example, if the host partner\_LU\_name is **USIBMSU.S10A4045**, then the Host Location Name is **S10A4045**.

#### Host Adapter Address

Specifies the LAN adapter address of the remote controller (host). This can be the host adapter card universally administered address (UAA), such as

10005A1E3338, or a locally administered address (LAA), such as 400012345678. Only hexadecimal digits can be entered. Blank spaces are invalid.

**Ethernet Format Check Box**

If the adapter address is in Ethernet Format, check this box.

**XID (optional)**

(Exchange ID) This is an optional field. If left blank, the XID will be assigned a value of "00000000". If an XID value is entered, it must be either five or eight hexadecimal bytes. If only five bytes are entered, the prefix "05D" will be used.

**Note:** XID is optional for APPC and APPC/VTAM hosts. Not applicable for TCP/IP hosts.

**Note:** If the host is AS/400, the following commands on the AS/400 will provide the information needed to update the Change LAN Host Information screen:

- If the AS/400 operating system is less than version V3R6, use DSPLANMLD, Display LAN Information.
- If the AS/400 operating system is version V3R6, or higher, use DSPLANMLB, Display LAN Media Library Information.

The following are the push-buttons on the Change Host Information pop-up window:

**OK** Update the LAN host information using the changes entered on this window.

**Cancel** Close the panel without updating the host information.

**Help** Display the help panel.

Figure 125 on page 197 shows the Change Host Information pop-up window for APPC/VTAM hosts. This pop-up window allows information about a LAN host to be changed in the 3494 configuration. When this is done, the 3494 responds to the host with the new configuration data.

Figure 125. Change LAN Host Information Pop-Up Window (TCP/IP)

#### Host Alias (optional)

The alias for a host is a customer supplied nickname for that host. This is an optional field and may be left blank if an alias is not desired. This entry field will only accept alpha-numeric characters and the “.”, “-”, and “\_” characters.

#### Host IP Address

The Host IP Address is the unique internet address assigned to the host. This field will only accept digits and the “.”, “-”, and “\_” characters. Blank spaces are not valid. The correct form is xxx.xxx.xxx.xxx where xxx represents a number from 000 to 255.

#### Host Name

The Host Name is the Hostname defined in the TCP/IP network. This field will only accept alpha-numeric characters and the “.”, “-”, and “\_” characters. Blank spaces are not valid.

**Note:** If the host is AS/400, the following commands on the AS/400 will provide the information needed to update the Change LAN Host Information screen:

- If the AS/400 operating system is less than version V3R6, use DSPLANMLD, Display LAN Information.
- If the AS/400 operating system is version V3R6, or higher, use DSPLANMLB, Display LAN Media Library Information.

The following are the push-buttons on the Change Host Information pop-up window:

**OK** Update the LAN host information using the changes entered on this window.

**Cancel** Close the panel without updating the host information.

**Help** Display the help panel.

## LM LAN Information

This window supplies the LAN information about the library that is required by the host system for the host and library to communicate. The window shown in Figure 126 displays the following information:

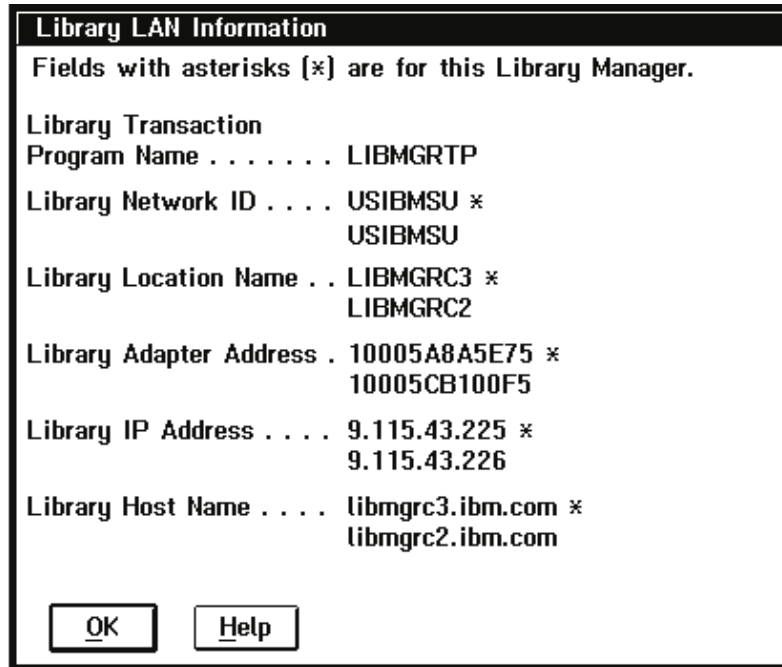

Figure 126. Library LAN Information Pop-Up Window

**Note:** If Model HA1 is installed, information for both library managers is shown. An asterisk (\*) indicates that the item is for the local library manager.

### Library Transaction Program Name

Specifies the name of the LAN transaction program that runs on the Library Manager to receive data from the Host.

### Library Network ID

Specifies the name of the remote network in which the adjacent control point (the Library Manager) resides.

The Common Programming Interface (CPI) - Communications partner\_LU\_name of the host, consists of the Library Manager network identifier and the Library Manager location name. For example, if the Library Manager partner\_LU\_name is **USIBMSU.LIBMGR3**, then the Library Manager Network ID is **USIBMSU**.

### Library Location Name

Specifies the remote location name (of the 3494 Library Manager) to which the Host will communicate.

The Common Programming Interface (CPI) - Communications partner\_LU\_name of the Library Manager, consists of the network identifier and the location name. For example, if the Library Manager partner\_LU\_name is **USIBMSU.LIBMGR3**, then the Library Manager Location Name is **LIBMGRC3**.

**Library Adapter Address**

Specifies the LAN adapter address of the remote controller (the Library Manager). This can be the Library Manager adapter card universally administered address (UAA), such as 10005A8A5E75, or a locally administered address (LAA), such as 40003494001A.

**Library IP Address**

The Library Manager IP Address is the unique internet address assigned to the 3494 Library Manager.

**Library Name**

The Library Name is the Hostname defined in the TCP/IP network for the Library Manager. In Figure 126 on page 198, **libmgrc3.ibm.com** is a TCP/IP Hostname.

The following are the push-buttons:

- OK** Close the information window.
- Help** Display the help panel.

## Operator Intervention

Certain conditions in the 3494, when detected, require short-term operator intervention to resolve. These conditions do not stop the library manager from accepting commands, but can delay the execution of certain queued operations. Refer to “Chapter 7. Remote Library Manager Console Feature” on page 241 for most conditions requiring intervention.

The library manager keeps track of the outstanding intervention-required conditions. These conditions can be displayed on the library manager console and an operator can indicate which conditions have been resolved. Steps are provided to resolve each condition. For instructions on removing a cartridge from the gripper, see “Cartridge Removal from the Gripper” on page 239.

The operator intervention window (see Figure 127 on page 200) displays the list of conditions. If no outstanding conditions exist, the list is blank.

1. Determine what condition to resolve, perform the necessary action, and then reply that the condition was resolved by highlighting the condition and choosing **OK**. You can also choose the **Help** button for the operator actions.

**Notes:**

- a. Certain conditions (for example, library full, Convenience Input/Output Stationfull, and out of cleaner cartridges) are automatically cleared after you resolve the intervention-required condition.
  - b. Certain conditions require the frame door to be opened to resolve.
  - c. You can highlight more than one condition. Choosing **OK** clears all the items you highlighted.
2. Repeat step 1 until all needed conditions are resolved.

When you have replied that all outstanding conditions are resolved, the window is closed. Also, you can close the window and resolve some conditions later by choosing **Cancel**.

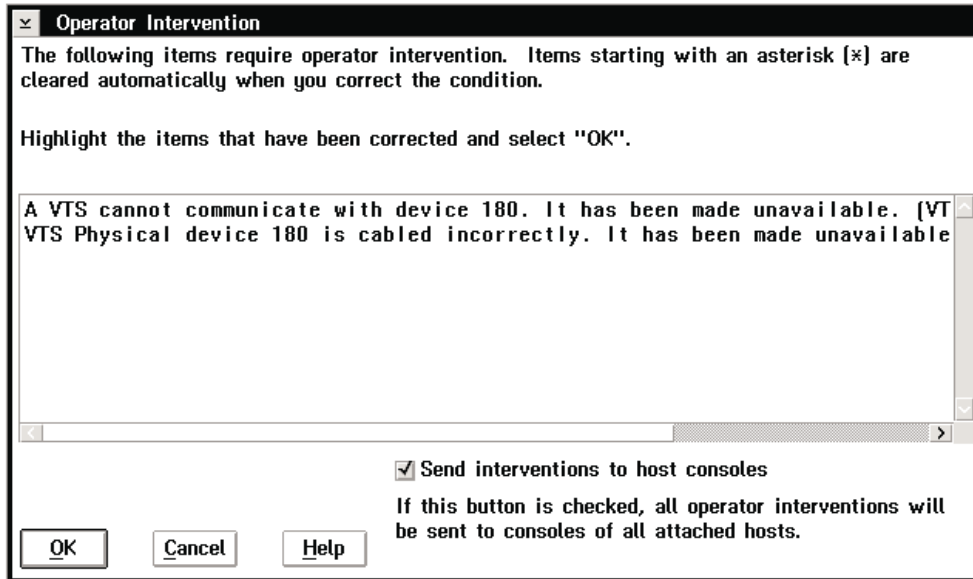

Figure 127. Operator Intervention Pop-Up Window

This window has one checkbox:

**Send interventions to host consoles**

If this button is checked, the first 70 characters of all operator intervention messages will be sent to all attached hosts. If the hosts are configured to display messages, these messages will be displayed on the host console.

The following are the push-buttons:

**OK** Remove the highlighted intervention items from the list. If all the items are cleared, the panel is closed.

**Cancel** Close the panel without removing any highlighted intervention items from the list.

**Help** Display the help panel, which contains a list of operator actions for each intervention condition.

## System Administrator Password

The System Administrator pop-up window (see Figure 128 on page 201) allows the system administrator password, if selected during installation, to be changed. The system administrator password-protects the following functions:

- Access to actions required as part of emergency power off (EPO) recovery during library manager start-up.  
If during initialization the library manager determines that EPO recovery is required, you are informed that either the system administrator or the service representative password is required. When the password is entered, the actions required for EPO recovery are displayed.
- Inventory new storage.
- Re-inventory complete subsystem.
- Shutdown.

- To unlock the keyboard and display when they have been locked from the Lockup Library Manager under the Mode Pull-Down.



Figure 128. System Administrator Password Pop-Up Window

**Current password**

Specifies entry of the current password.

**New password**

Specifies entry of the new password.

**Verify** Specifies re-entry of the new password.

**OK** Updates the password to the new password.

**Cancel**

Closes the pop-up window without changing the password.

**Help**

Provides additional information about the pop-up window.

If you enter the current password correctly, you can access the function.

**Note:** Do not forget the system administrator password. If this is the first time this window is displayed, the **Current password** is the only entry required. This entry becomes the system administrator password for all protected functions. If you cannot remember the password, call your service representative.

You can change the password by entering a new password into the **New password** and **Verify** fields after entering the current password. If the current password is correct and the two new password fields match, you have access to the protected functions and the password is changed. Changing the system administrator password on one protected menu changes the password to all protected menus except for the Service menu. If service mode is active, these functions do not require the system administrator password.

## Managing Import/Export Volumes

This section contains information on managing Import/Export volumes in VTS systems that are Import/Export capable.

### Manage Unassigned Volumes

This panel will be automatically presented when the library is in Import mode and volumes of J-type media have been input into the library via the Convenience Input/Output Station. This panel allows the operator to move Exported Stacked Volumes in the Unassigned category to the Import category. This is an essential step during a VTS import operation. The operator can also move other physical volumes (J-type, HPCT) to the Insert category or eject them from the library. The "Unassigned" volumes are presented in the list box titled "Unassigned".

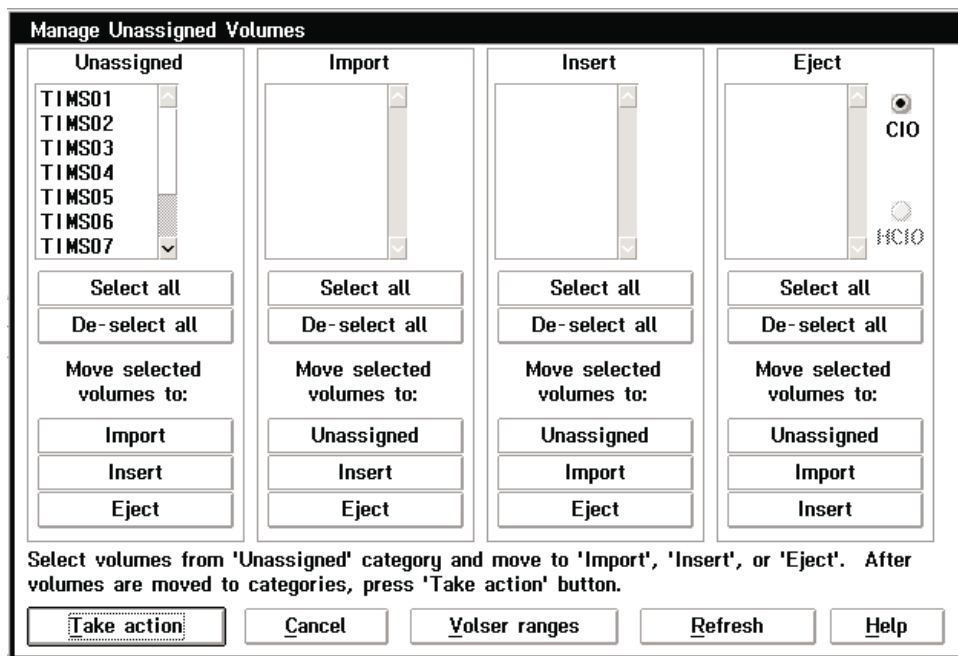

Figure 129. Manage Unassigned Volumes Pop-Up Window

The following are the push-buttons:

#### Select All

Selects all volumes within the current list box.

#### De-select All

De-selects all volumes within the current list box.

#### Import

Moves the selected volumes to the Import category list box.

#### Unassigned

Moves the selected volumes to the Unassigned category list box.

#### Insert

Moves the selected volumes to the Insert category list box.

#### Eject

Moves the selected volumes to the Eject category list box.

#### Take Action

Confirms and activates a request to move volumes to the selected category.



| **Cancel**

| Close the panel without saving any of the changes.

| **Volser Ranges**

| Brings up the Volser Range Panel. See Figure 94 on page 162.

| **Refresh**

| Refreshes the screen.

| **Help**

| Provides additional help for this screen.

## Manage Import Volumes

This panel allows the operator to move physical volumes (J-type) in the Import category to the Insert category, or if desired, eject the volumes from the library.

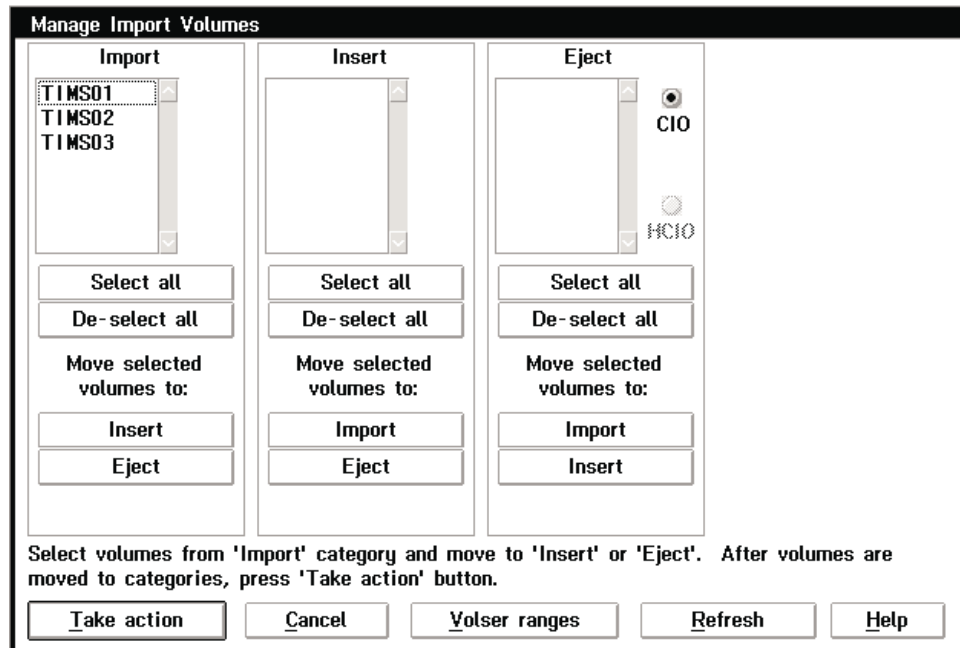

Figure 130. Manage Import Volumes Pop-Up Window

The following are the push-buttons:

**Select All**

Selects all volumes within the current list box.

**De-select All**

De-selects all volumes within the current list box.

**Import**

Moves the selected volumes to the Import category list box.

**Insert** Moves the selected volumes to the Insert category list box.

**Eject** Moves the selected volumes to the Eject category list box.

**Take Action**

Confirms and activates a request to move volumes to the selected category.

**Cancel**

Close the panel without saving any of the changes.

**Volser Ranges**

Brings up the Volser Range Panel. See Figure 94 on page 162.

**Refresh**

Refreshes the screen.

**Help** Provides additional help for this screen.

## Manage Insert Volumes

This panel allows the operator to re-evaluate the physical volumes in the Insert category for 3590 native use. By redefining the volser ranges, the volumes can be moved to the Insert categories for the VTS subsystems. In addition, the operator can eject the volumes from the library.

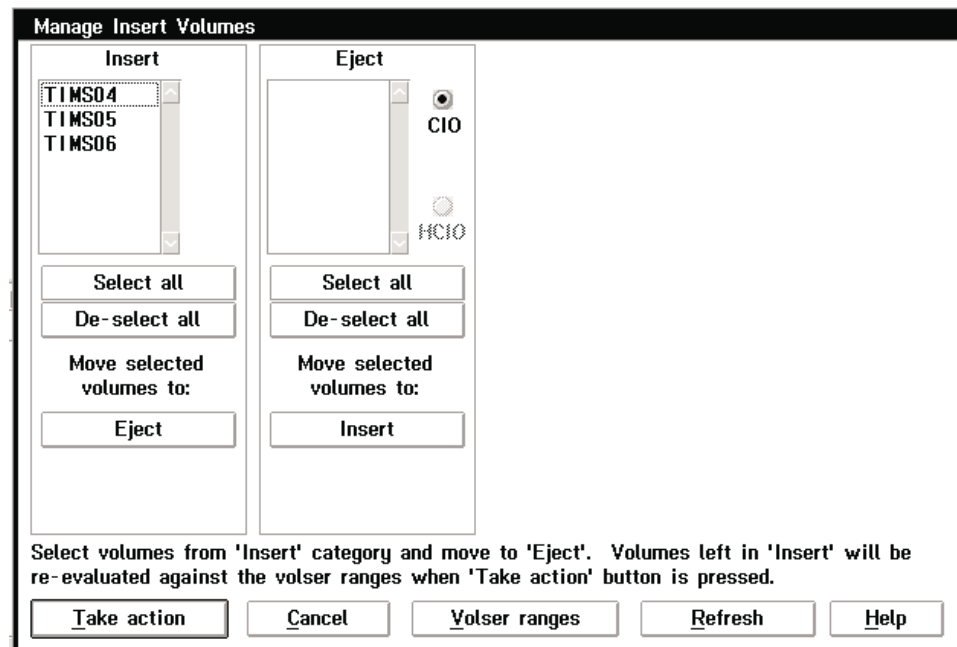

Figure 131. Manage Insert Volumes Pop-Up Window

The following are the push-buttons:

**Select All**

Selects all volumes within the current list box.

**De-select All**

De-selects all volumes within the current list box.

**Insert** Moves the selected volumes to the Insert category list box.

**Eject** Moves the selected volumes to the Eject category list box.

**Take Action**

Confirms and activates a request to move volumes to the selected category.

**Cancel**

Close the panel without saving any of the changes.

**Volser Ranges**

Brings up the Volser Range Panel. See Figure 94 on page 162.

**Refresh**

Refreshes the screen.

**Help**

Provides additional help for this screen.

## Manage Export-Hold Volumes

This panel allows the operator to move Exported Stacked Volumes in the Export-hold category to the Import category. In addition, the operator can eject the Exported Stacked Volumes from the library.

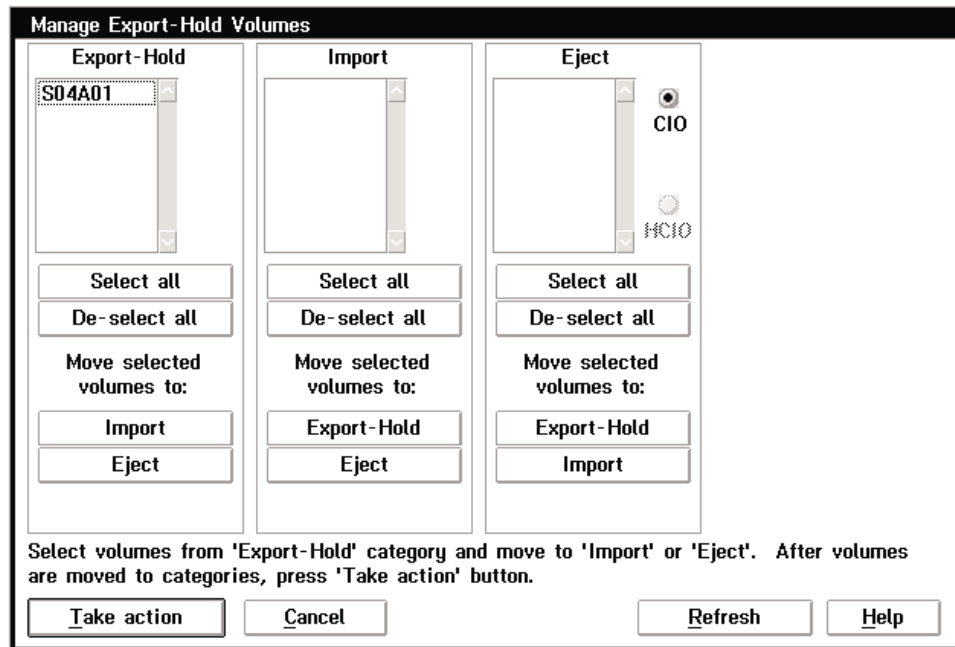

Figure 132. Manage Export-Hold Volumes Pop-Up Window

The following are the push-buttons:

**Select All**

Selects all volumes within the current list box.

**De-select All**

De-selects all volumes within the current list box.

**Import**

Moves the selected volumes to the Import category list box.

**Export-Hold**

Moves the selected volumes to the Export-Hold category list box.

**Eject**

Moves the selected volumes to the Eject category list box.

**Take Action**

Confirms and activates a request to move volumes to the selected category.

**Cancel**

Close the panel without saving any of the changes.

**Refresh**

Refreshes the screen.

**Help**

Provides additional help for this screen.

## Cancel Export/Import

This panel allows the operator to send a cancel request to the VTS for an in-progress Import or Export operation. The in-progress Exports and Imports are presented in the list box. Only one operation can be selected at a time.

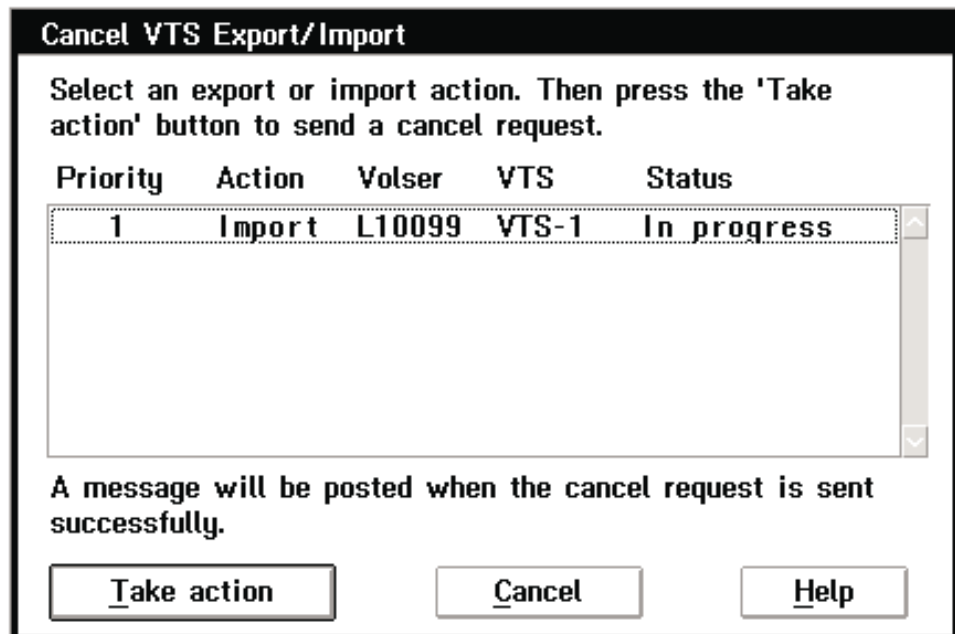

Figure 133. Cancel Export/Import Pop-Up Window

The following are the push-buttons:

**Take Action**

Sends the cancel request for the highlighted import or export operation.

**Cancel**

Exits from the Cancel VTS Export/Import screen. No action is taken.

**Help**

Provides additional help for this screen.

---

## Service Access

### Enable service access

This selection provides the ability to access the library managers through a modem connection, if installed. This will also allow files (log and dump) to be off-loaded from the library manager by service personnel. The library manager may prompt the operator for the administrator password.

### Disable service access

This selection prevents the ability to access the library manager through a modem connection, if installed. The library manager may prompt the operator for the administrator password.

---

## SNMP Options

The 3494 can be attached to many different host systems, with various operating systems that communicate with the library using different types of connections. During operation, the 3494 may encounter situations that the user would want to know about, such as a door being opened (which causes the library to stop). Because there are many different attachment methods, the 3494 provides a standard TCP/IP protocol called Simple Network Management Protocol (SNMP) to send alerts (called SNMP traps) over a TCP/IP LAN network to one or more SNMP monitoring stations. These monitoring stations, along with other customer-supplied software, can be used to alert operations staff of possible problems or operator interventions that occur at the library. Figure 134 shows a basic SNMP block diagram.

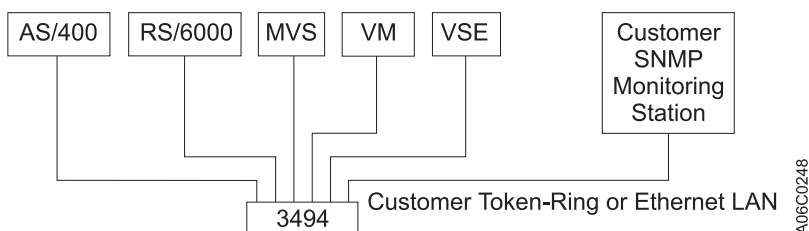

Figure 134. SNMP Basic Block Diagram

With this method, the 3494 can be monitored at one or more locations, along with other equipment (both IBM and non-IBM) that also supports the SNMP protocol. Monitoring is independent of the host system that is controlling the equipment and independent of the location of the 3494s.

The Library Manager now contains limited SNMP (Simple Network Management Protocol) support. This section discusses how to use the Library Manager's SNMP features.

The Library Manager generates SNMP trap messages to inform network monitoring stations that certain events have occurred on the 3494 Tape Dataserver. The Library Manager code does not contain any SNMP Management Information Base (MIB) support.

The Library Manager code offers the ability to monitor the following Library Manager events:

- **OPINT** - Operator Interventions
- **UNSOL** - Unsolicited Attention Messages
- **SERVC** - Service Request Messages (not currently supported)
- **CHCK1** - Library Manager Check1 Conditions
- **TESTM** - Test SNMP Trap Message

#### **OPINT Events**

OPINT events inform the monitoring station of the state of the 3494. They can inform the monitor station that the 3494 has developed problems, and can even request service calls. All OPINT messages are located in the OPINT message table. See Table 7 on page 216.

OPINT traps are the best way to monitor the 3494, and these Library Manager trap types should be selected at all times.

#### **UNSOL Events**

UNSOL events offer additional support to the OPINT messages. They are not as helpful as the OPINT message, but they can be used to track drive availability, volume movement, etc.

In order to receive UNSOL messages, the 3494 must be online, and it must have at least one host. All UNSOL messages are located in the UNSOL message section. See “UNSOL Library Manager SNMP Traps” on page 221.

#### **CHCK1 Events**

CHCK1 events are posted when the Library Manager code encounters problems that require reinitializing the Library Manager.

#### **TESTM Events**

TESTM events are automatically generated by the Library Manager to test the ability to send SNMP trap messages. They are intended to verify the ability to send traps to the monitor station.

## **Using the Library Manager’s SNMP Features**

### **Selecting SNMP Trap Types**

First, select which type of Library Manager trap events need to be monitored. To do this, select **Commands** from the Main Menu, and select **SNMP options**. Then select the **Select SNMP trap types** sub-menu item. A dialog box with all the Library Manager trap types is displayed (See Figure 135 on page 210). Select the Library Manager trap types that need to be monitored. When done, select OK.

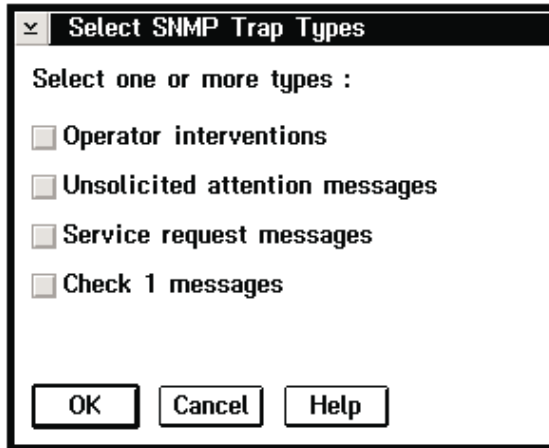

Figure 135. Select SNMP Trap Types Pop-Up Window

## Configuring SNMP Trap Destinations

Once the Library Manager Trap Types have been selected, the Library Manager needs to be configured to send the SNMP traps to the correct monitoring station. To do this, select **SNMP Options** from the **Commands** menu, and then select **Change SNMP trap destinations**.

The Library Manager can be configured to send SNMP traps to a maximum of five different trap destinations.

**Note:** If this is a High Availability 3494, only the active Library Manager needs to be configured. The Library Manager code will automatically configure the standby Library Manager when the standby Library Manager becomes active. Only the Active Library Manager will send trap messages.

The procedure for configuring the SNMP trap destination depends on the OS/2 version (2.11 or 4.0). To determine which version of OS/2 you have, choose **About** from the **Help** menu. (See "Using the Help Pull-Down" on page 94.) Procedures for both versions of OS/2 are shown below.

**OS/2 Version 2.11:** Figure 136 on page 211 shows the OS/2 2.11 version of the Change SNMP Trap Destinations pop-up window.



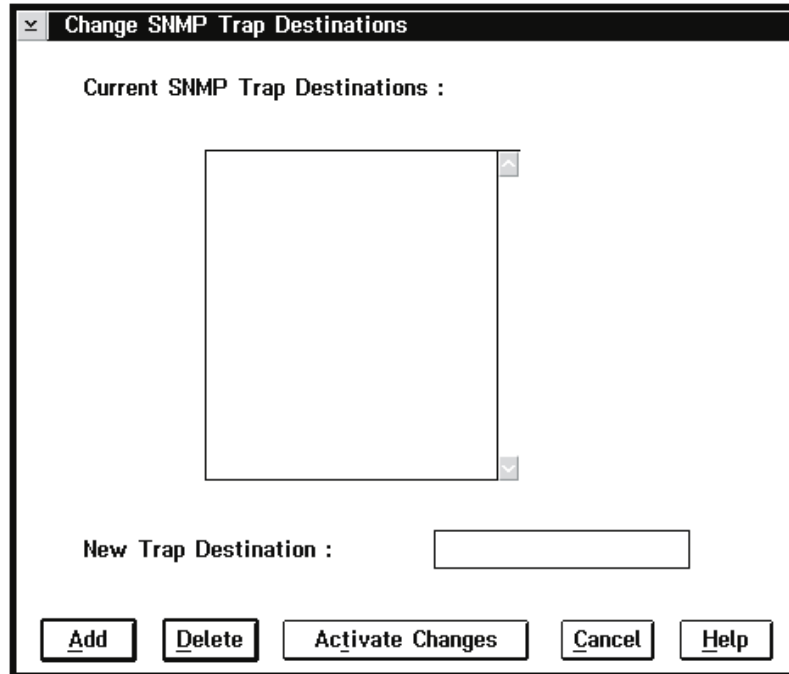

Figure 136. Change SNMP Trap Destinations Pop-Up Window (OS/2 2.11)

*Adding a Destination::*

1. Enter the new SNMP trap destination in the **New Trap Destination** field.
2. Select the **Add** push-button.

*Deleting a Destination::*

1. Highlight the SNMP trap destination that you want to delete in the list box.
2. Select the **Delete** push-button.

The changes are activated when you select the **Activate Changes** button. If the SNMP daemon is running when you select **Activate Changes**, the library manager will kill it and restart the daemon with the new changes.

**OS/2 Version 4.0:** For OS/2 version 4.0, the SNMP HRMCNFIG program is used to configure SNMP trap destinations. If you have OS/2 version 4.0, choosing the **Change SNMP trap destinations** menu item automatically starts this program for you.

Figure 137 on page 212 shows the SNMP Configuration pop-up window.

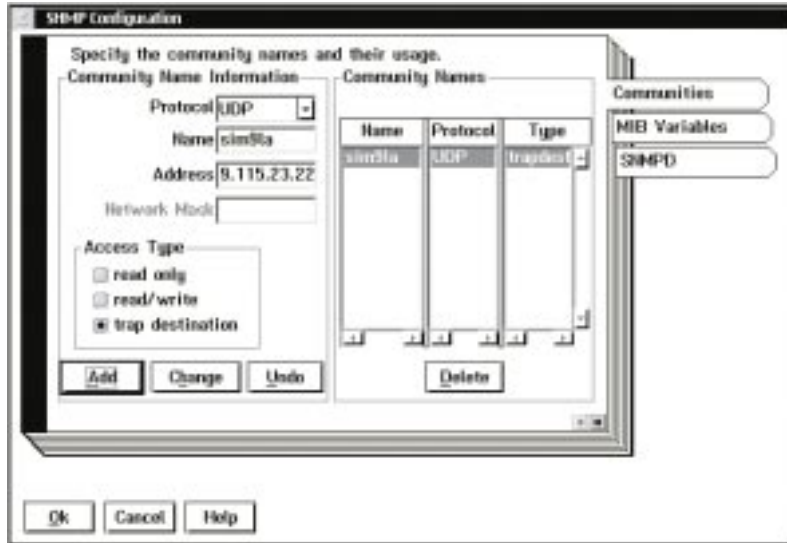

Figure 137. SNMP Configuration Pop-Up Window

#### Adding a Destination::

1. Once the HRMCNFIG program is running, select the **trap destination** radio button. The **Network Mask** input field will then be grayed out. (SNMP trap messages do not need to use this option.)
2. Select **UDP** in the **Protocol** field, enter the monitor station name and address in the appropriate fields, and select **Add**. Do this for each of the monitor stations.
3. Select **OK** when done.

**Note:** HRMCNFIG is an external process to the Library Manager, and therefore, the user must wait until that process has completed before Library Managers SNMP support is enabled. To do this, wait until the **Change SNMP trap destinations** becomes selectable again (ungrayed). Once it has become selectable, all SNMP features can be used.

#### Deleting a Destination::

1. Highlight the SNMP trap destination that you want to delete in the list box.
2. Select the **Delete** push-button.
3. Select **OK** when done.

## Starting SNMP

Once the trap types have been selected and the SNMP trap destinations configured, the Library Manger SNMP support needs to be enabled. To do this, select **Start SNMP** from the **SNMP options** menu.

Selecting this menu item starts the SNMP daemon. To ensure that the daemon is running, use Ctrl + Esc to bring up a window list, and make sure that SNMPD is listed.

## Stopping SNMP

Selecting the **Stop SNMP** sub-menu item under the **SNMP Options** menu item will disable the Library Manager's SNMP features. No Library Manager SNMP traps will be generated if the SNMP daemon is not running.

## Sending TESTM Messages

Once SNMP has been configured, send an SNMP trap to ensure that SNMP is configured correctly. The TESTM trap allows a test message to be sent to the monitor stations which have been set up to receive the SNMP trap messages.

To send a TESTM SNMP trap, select **Send TESTM Trap** from the **SNMP Options** menu. Selecting this menu item creates a dialog box, which allows entry of a string to send to all the monitor stations for which the Library Manager is configured (See Figure 138 ).

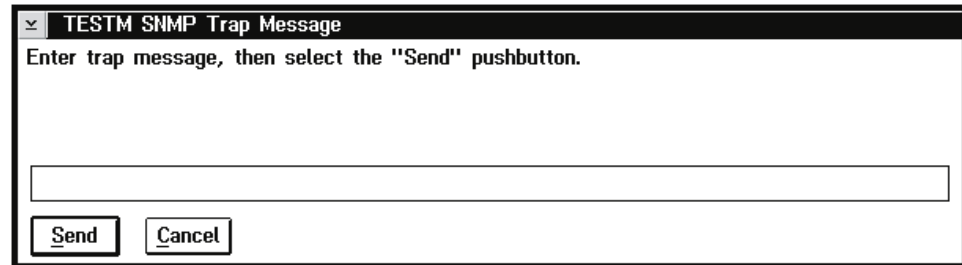

Figure 138. TESTM SNMP Trap Message Pop-Up Window

Most problems sending SNMP messages are related to network configuration. If the monitor station does not receive the trap, check the SNMPD window located on the Library Manager to see if the SNMPD trap message was sent. If the daemon shows the message, make sure that the network path is correct to the monitor station.

## Trouble Shooting

Most problems encountered will be related to the site network or software. The following is a list of things to check on the Library Manager to ensure SNMP is working correctly.

1. Make sure that the SNMPD process is running.
2. Make sure that the monitor station can be “pinged” from a Service Window. If the monitor station cannot be pinged, then there is a network configuration problem which must be corrected. The SNMP trap will never get to the monitoring station unless the network configuration problem is corrected.
3. Generate a TESTM trap message, and check the SNMPD window to see if it was sent. To do this, use Ctrl + Esc to bring up the Window List, and use the mouse or arrow keys to highlight the SNMPD process. You should see the TESTM trap message in the window. If there are any errors, then the daemon is not being started correctly.

## Receiving SNMPD Traps on the Monitor Station

All the Library Manager trap types follow a very similar format. Each Library Manager SNMP trap message generated has the same beginning format. This helps the programmer on the monitor station handle the different Library Manager SNMP trap message types.

Each field in the Library Manager SNMP trap message is space delimited. This allows the programmer to tokenize the incoming Library Manager SNMP trap message.

Most Library Manager SNMP trap messages contain both a set of parameters and a message string. The parameters are intended to aid the programmer in extracting the necessary information from the trap message. The message string is intended for customers who do not have the ability to program the network monitor station software to parse and process the Library Manager SNMP traps. Each Library Manager SNMP contains this message string, which will contain enough information to post to the simplest SNMP monitor program.

The basic format for a Library Manager SNMP Trap Message is as follows:

**3494 [Library Sequence Number] [Library Manager Trap Type] [Trap Number] {Rest of Message}**

**3494** Indicates that this message was generated by a 3494 library.

#### **Library Sequence Number**

This is the Library Sequence Number of the logical Library which generated the message. It gives the programmer the ability to know which 3494 generated the SNMP Trap message. All 3494s have a unique Library Sequence Number.

#### **Library Manager Trap Type**

This will be one of the following:

- OPINT
- UNSOL
- SERVC
- CHCK1
- TESTM

#### **Trap Number**

This will be the trap number of the Library Manager Trap Type. Each Library Manager Trap Type contains a unique set of traps, each with its own format. This field allows the programmer to determine which Library Manager Trap Type message was sent.

#### **Rest of Message**

The content of this part of the Library Manager SNMP trap message is quite flexible. Some Library Manager messages will contain parameters and/or a message string. The Library Manager SNMP trap message parameters are meant to help the monitoring station software gather the related information quickly. The message string is meant for human readability.

Here is an example of a Library Manager SNMP trap message:

```
3494 C2444 OPINT 4 - - - *The Library is full.
```

In this example, the message was generated from a 3494 tape library, with a Library Sequence Number of C2444. The Library Manager Trap Type is OPINT, or an operator intervention. The OPINT trap number is 4, the parameters are all -, and the rest of the trap message informs us that the library is full of cartridges.

### **Outline for Receiving Library Manager SNMP Traps**

1. Make sure that the SNMP trap was generated from a 3494 Tape Dataserver.
2. If the message was generated from a Library Manager, tokenize the incoming SNMP trap, and read which 3494 Tape Dataserver generated the trap message. This can be done by reading the Library Sequence Number.

3. Determine which Library Manager SNMP Trap Type was sent. This will be one of the Library Manager SNMP Trap Types. This is the next field in the space-delimited string.
4. Once it has been determined that the SNMP trap message was generated from a 3494 Tape Dataserver, its identity, and which type of Library Manager SNMP trap message was sent, the message can be tokenized again to remove the message parameters and message string.

**Note:** It is a good idea to program the monitor station to handle conditions such as an unrecognized Library Manager SNMP trap. Additional Library Manager SNMP traps will be added, and documentation will be updated, as they are updated.

## Programming Tools

The Library Manager code contains an aid for the developer to help check the monitors ability to handle all the Library Manager SNMP traps. This program is located in c:\lm\exe.

To use the program, first make sure that SNMP is ENABLED and configured on the Library Manager. The program will not generate any SNMP traps if SNMP is not enabled on the Library Manager.

To start the program, open a service window and type in SNMPTTEST.

If the program does not come to the foreground, use the Ctrl + Esc keys to bring up the Window List. Select the SNMPTTEST program. Use the program to generate the required SNMP traps, and when done, exit the SNMPTTEST program and close the service window.

## OPINT Library Manager SNMP Traps

This section discusses the format of the Library Manager OPINT SNMP traps. Library Manager OPINT SNMP traps are the easiest to program for, since they all follow the same format. The general Library Manager OPINT SNMP trap has the following format:

**3494 [Library Sequence Number] OPINT [OPINT Trap Number] [Parameter A] [Parameter B] [Parameter C] [Actual Library Manager OPINT Trap Message]**

The following is an example of an OPINT Library Manager SNMP Trap:

```
3494 C2444 OPINT 48 180 - - A cartridge containing invalid media has  
been left in the device 180 feed slot. Remove the cartridge.
```

In this example, a cartridge with invalid media type has been left in the feed slot of device 180 on library C2444.

**Note:** Library Manager OPINT SNMP trap messages pad all unused parameters with a dash (—) in order to maintain the space delimited architecture.

**Note:** All Library Manager SNMP trap messages are actually one line of text; however, due to the printing process, some may take up several lines of text in this manual.

Valid values for the OPINT tables parameters are:

- This indicates that the parameter is not used for this Library Manager OPINT messages.

**Gripper**

Valid Gripper values are: 1, which indicates gripper one; and 2, which indicates gripper two.

**Accessor**

Valid Accessor values are: A, which indicates accessor A; and B, which indicates accessor B.

**Note:** Only High Availability 3494s have an accessor B.

**Device**

Valid Device values will be from 0 to 0xFFFF. This parameter will always be reported in hexadecimal.

**Volser** This will be a six character string (example: CNN444).

**Rack Cell**

The Rack Cell parameter has the following format: RackColumnCell. As an example: 1G1 means rack 1, column G and cell 1.

**External**

Same as Volser - Only used in libraries with VTSs.

**Internal**

Same as Volser - Only used in libraries with VTSs.

**VTS** Valid VTS parameters are:

- **VTS\_1**, which indicates VTS 1
- **VTS\_2**, which indicates VTS 2

Certain versions of OS/2 trap if the overall SNMP message is over 132 bytes in length. To prevent this trap, the Library Manager software checks to see if the SNMP trap message is longer than 132 bytes, and inserts a NULL character at the 132 byte limit. Therefore, some Library Manager OPINT SNMP traps will be truncated to prevent this problem.

Table 7 contains the Library Manager OPINT interventions.

Table 7. Operator Intervention Messages and Parameters (OPINT TRAP Type)

OPINT #	Parameter [A]	Parameter [B]	Parameter [C]	Actual Library Manager OPINT Trap Message
1	Gripper	Accessor	—	Gripper Failure on gripper [A], accessor [B]
2	Device	—	—	Index failure on device [A]
3	—	—	—	*The convenience I/O station is full.
4	—	—	—	*The library is full.
5	Volser	—	—	A duplicate volser ([A]) was ejected to the convenience I/O station.
6	Volser	—	—	A duplicate volser ([A]) was left in the convenience I/O station
7	—	—	—	An unreadable volser was left in the convenience I/O station
8	—	—	—	*The library is out of CST/ECCST cleaner cartridges.

Table 7. Operator Intervention Messages and Parameters (OPINT TRAP Type) (continued)

OPINT #	Parameter [A]	Parameter [B]	Parameter [C]	Actual Library Manager OPINT Trap Message
9	Volser	—	—	An unexpected volser ([A]) was found and ejected to the convenience I/O station.
10	—	—	—	*The high-capacity output rack is full.
11	Volser	Rack Cell	—	A duplicate volser ([A]) was left in high-capacity input rack cell [B]
12	Rack Cell	—	—	An unreadable volser was left in high-capacity input rack cell [A]
13	Volser	Rack Cell	—	An invalid volser ([A]) was left in high-capacity input rack cell B
14	Volser	—	—	An invalid volser ([A]) was left in the convenience I/O station
15	Volser	Rack Cell	—	A duplicate volser ([A]) was ejected to high-capacity output rack cell [B]
16	Volser	Rack Cell	—	An unexpected volser ([A]) was ejected to high-capacity output rack cell [B]
17	Device	—	—	Load / unload failure on device [A].
18	Volser	—	—	An unexpected volser ([A]) was left in the convenience I/O station.
19	Volser	Rack Cell	—	An unexpected volser ([A]) was left in high-capacity output rack cell [B]
20	—	—	—	*The convenience I/O station door is open.
21	—	—	—	*The convenience I/O station door is open.
22	Volser	—	—	Volser ([A]) could not be put away. It was ejected to the convenience I/O station.
23	Volser	Rack Cell	—	Volser ([A]) could not be put away. It was ejected to the high-capacity output rack cell [B].
24	—	—	—	The convenience I/O station should be empty but is not. Visually check the station.
25	Gripper	Accessor	—	A cartridge could not be released from gripper [A] accessor [B].
26	Volser	—	—	A cartridge has been dropped. ([A])
27	—	—	—	Environmental alert - Smoke has been detected in the enclosure.
28	—	—	—	An emergency stop has occurred.
29	Volser	—	—	Damaged volser ([A]) ejected to the convenience I/O station.
30	Volser	Rack Cell	—	Damaged volser ([A]) ejected to high-capacity output facility cell: [B]
31	Device	—	—	Device [A] is not ready.
34	Device	—	—	A mislabeled cleaner cartridge has been left in device [A] feed slot. Remove the cartridge.
35	Device	—	—	A recoverable error occurred on device [A]. A service call may be needed if the error persists.

Table 7. Operator Intervention Messages and Parameters (OPINT TRAP Type) (continued)

OPINT #	Parameter [A]	Parameter [B]	Parameter [C]	Actual Library Manager OPINT Trap Message
36	—	—	—	A mislabeled cleaner cartridge has been ejected to the convenience output station.
37	—	—	—	A mislabeled cleaner cartridge has been ejected to the high-capacity output station.
38	Rack Cell	—	—	A cartridge or cartridge label located at cell [A] is upside_down.
39	Rack Cell	—	—	A duplicate Volser has been found at cell [A].
40	Rack Cell	—	—	The cartridge label located at cell [A] is unreadable.
41	Rack Cell	—	—	The cartridge label located at cell [A] is invalid.
42	—	—	—	The system has failed. A service call is required.
43	—	—	—	*The accessor or gripper configuration has changed. The library must be re-taught.
44	—	—	—	*The top two I/O station cells are inaccessible. Move cartridges to cell 3.
45	Volser	Rack Cell	—	Volser ([A]) cannot be removed from cell: [B]
46	Volser	Rack Cell	—	Volser ([A]) cannot be removed from high-capacity station cell: [B]
47	Device	—	—	Device [A] has failed. A service call is required.
48	Device	—	—	A cartridge containing invalid media has been left in device [A] feed slot. Remove the cartridge.
49	Volser	—	—	An invalid media volser ([A]) has been ejected to the convenience I/O station.
50	Volser	—	—	An invalid media volser ([A]) has been ejected to the high-capacity output station.
51	—	—	—	*The library is out of HPCT cleaner cartridges.
52	Volser	—	—	A volser ([A]) with an unknown media type has been ejected to the convenience I/O station.
53	Volser	Rack Cell	—	A volser (A) with an unknown media type has been ejected to high-capacity output facility cell: [B]
54	Volser	—	—	Volser (A) cannot be removed from convenience I/O station.
55	VTS Number	—	—	Free storage threshold has been crossed for VTS [A].
56	Volser	—	—	A volser (A) with an unknown media type has been left in to the convenience input station.



Table 7. Operator Intervention Messages and Parameters (OPINT TRAP Type) (continued)

OPINT #	Parameter [A]	Parameter [B]	Parameter [C]	Actual Library Manager OPINT Trap Message
57	Volser	—	—	A volser (A) with an unknown media type has been left in to the high-capacity input station.
58	Volser	—	—	An invalid volser (A) has been ejected to the convenience I/O station
59	Rack Cell	—	—	The cartridge label located at cell [A] has an unknown media type.
60	Volser	—	—	During an Inventory Update operation, volser [A] was ejected to the convenience I/O station because there were no free cells.
61	Volser	—	—	During an Inventory Update operation, volser [A] was ejected to the high capacity station because there were no free cells.
62	Accessor	—	—	Power failure on accessor [A]. A service call is required.
63	Accessor	—	—	Accessor [A] has failed. A service call is required.
64	—	—	—	Dual Write has failed. A service call is required.
65	Volser	Slot	Rack Cell	An Error occurred for cartridge [A] during insert from CIO slot [B] to cell [C].
67	Volser	—	—	Eject failed for volser [A]. This operation was initiated by the Library Manager..
68	—	—	—	A Library Manager switch has completed. This switch was initiated by the operator.
69	—	—	—	A Library Manager switch has completed. This switch was due to an error.
70	—	—	—	This message may appear as any of the following: <ol style="list-style-type: none"> <li>1. A hard drive has failed. Call service</li> <li>2. Primary hard drive has failed on LM-A. Call service.</li> <li>3. Primary hard drive has failed on LM-B. Call service.</li> <li>4. Mirror hard drive has failed on LM-A. Call service.</li> <li>5. Mirror hard drive has failed on LM-B. Call service.</li> </ol>
71	—	—	—	This message may appear as any of the following: <ol style="list-style-type: none"> <li>1. Hard drive is disabled. Call service</li> <li>2. Hard drive is disabled on LM-A. Call service.</li> <li>3. Hard drive is disabled on LM-B. Call service.</li> </ol>
100	Volser	VTS	—	A damaged stacked volume [A] has been ejected.

Table 7. Operator Intervention Messages and Parameters (OPINT TRAP Type) (continued)

OPINT #	Parameter [A]	Parameter [B]	Parameter [C]	Actual Library Manager OPINT Trap Message
101	VTS	—	—	*A VTS is out of stacked volumes.
102	External	Internal	—	A stacked volume has a label mismatch and has been ejected. Internal: [B], External: [A]
103	VTS	—	—	A permanent, non-recoverable Tape Volume Cache error has occurred.
104	Volser	VTS	—	An orphaned logical volume [A] has been found. Call service.
105	VTS	—	—	A VTS has a CHECK1 failure.
107	Stacked	Logical	—	Logical volume [B] was not fully recovered from damaged stacked volume [A].
108	Cache	VTS	—	The Tape Volume Cache is degraded. (%04x)
109	Volser	VTS	—	Database restore from volume [A] failed. Attempting to restore from next most recent.
110	Volser	VTS	—	Insert of logical volume [A] failed during disaster recovery.
111	Volser	VTS	—	Damaged volume [A] ejected during disaster recovery. Could not be read on 2 drives.
112	Device	VTS	—	Device [A] has been made unavailable by a VTS.
113	VTS	—	—	A VTS does not have enough available physical drives to continue operation.
114	Volser	VTS	—	A VTS attempted unsuccessfully to eject a stacked volume ([A]) during disaster recovery.
115	Volser	VTS	—	A VTS attempted unsuccessfully to eject a damaged stacked volume [A].
116	Device	VTS	—	VTS Physical device [A] is cabled incorrectly. It has been made unavailable.
117	Device	VTS	—	A VTS cannot communicate with device [A]. It has been made unavailable.
118	Physical	Logical	VTS	Mount of logical volume [B] failed because physical volume [A] is not in the library.
120	Physical	Logical	VTS	Mount of logical volume [B] failed because physical volume [A] is misplaced.
121	Physical	Logical	VTS	Mount of logical volume [B] failed because physical volume [A] is inaccessible.
122	Physical	Logical	VTS	Mount of logical volume [B] located on physical volume [A] failed.
123	VTS	Accessor or Volser	—	Stacked volume [A] is in Read-Only status with a reason code of [B]. (VTS z)
124	Volser	Error Code	VTS	Stacked Volume [A] is unavailable with a reason code of [B].
125	Error Code	VTS	—	VTS Controller degraded. Error Code [A]. Call service.

Table 7. Operator Intervention Messages and Parameters (OPINT TRAP Type) (continued)

OPINT #	Parameter [A]	Parameter [B]	Parameter [C]	Actual Library Manager OPINT Trap Message
126	Device	—	—	VTS requested that device [A] be made unavailable but a mount/demount is in progress.

## UNSOL Library Manager SNMP Traps

This section discusses the format of the Library Manager UNSOL messages. Unlike the Library Manager OPINT SNMP traps, the UNSOL SNMP trap messages are all different, and require special programming to handle them.

There are seven supported Library Manager UNSOL SNMP trap messages:

1. X10 - Category State Change
2. X11 - Library Manager Operator Message
3. X12 - Library I/O Station State Change
4. X13 - Operational State Change
5. X14 - Volume Exception
6. X15 - Device Availability Changed
7. X16 - Device Category Change Notification

**Note:** X represents the hexadecimal value.

### Category State Change SNMP Trap

This message indicates that the Library Manager has added one or more cartridges into the insert category. The format for the Category State Change Library Manager SNMP Trap message is:

```
3494 [Library Sequence Number] UNSOL 10 [Parameter A]
*Volumes added to category: [Parameter A]
```

#### Parameter A

This parameter will be the category in which volumes are added.

#### Library Sequence Number

This will be the unique Library Sequence Number of the library generating the SNMP trap message.

### Library Manager Operator Message SNMP Traps

The content is a message from the Library Manager operator console to all hosts connected to the 3494 Tape Dataserver. The basic format is:

```
3494 [Library Sequence Number] UNSOL 11 *{Message from operator }
```

#### Library Sequence Number

Unique Library Sequence Number of the 3494 Tape Dataserver that generated the SNMP trap message.

#### Message from operator

This is the string that the operator on the Library Manager typed in.

Example:

```
3494 C2444 UNSOL 11 *The 3494 Tape Dataserver is being taken offline.
```

Here the message was generated by the C2444 3494 Tape Dataserver, and the operator entered "The 3494 Tape Dataserver is being taken offline."

## Library I/O Station State Change SNMP Traps

The Library I/O Station State Change message format is as follows:

```
3494 [Library Sequence Number] UNSOL 12 [Param A] [Param B] [Param C] [Param D]
[Param E] [Param F] [Param G] [Param H] *I/O Station
```

### Library Sequence Number

The unique Library Sequence Number of the library that generated the SNMP trap message.

### Param A

It will be one of the following:

1. **IE** - indicating "All Convenience Input Stations Empty"
2. —

### Param B

It will be one of the following:

1. **IO** - indicating "Open Input Door"
2. —

### Param C

It will be one of the following:

1. **OE** - indicating "All Convenience Output Stations Empty"
2. —

### Param D

It will be one of the following:

1. **OF** - indicating "All Convenience Output Station Full"
2. —

### Param E

It will be one of the following:

1. **II** - indicating "3494 I/O Station in Input Mode"
2. —

### Param F

It will be one of the following:

1. **BA** - indicating "Bulk I/O Allowed"
2. —

### Param G

It will be one of the following:

1. **BF** - indicating "Bulk Output Station Full"
2. —

### Param H

It will be one of the following:

1. **OO** - indicating "Open Output Door"
2. —

Example:

```
3494 C2444 UNSOL 12 IE IO - - II - BF - *I/O Station
```

## Operational State Change SNMP Traps

The Operational State Change message format is as follows:

```
3494 [Library Sequence Number] UNSOL 13 [Mode] [State] [Degraded] [Safety Enclosure Interlock Open] [Vision System Non-Operational] [Intervention Required] [Check1] [Storage Cells Full] [Out of Cleaners] [Dual Write Disabled] [Smoke Detected] [Manual Mode] *Operational State Change
```

### Library Sequence Number

Unique Library Sequence Number of the 3494 Tape Dataserver that generated the SNMP trap message.

**Mode** It will be one of the following:

- AUTO
- PAUSE
- MANUAL

**State** It will be one of the following:

- ONLINE
- OFFLINE

### Degraded

It will be one of the following:

- —
- DEGRAD

### Safety Enclosure Interlock Open

It will be one of the following:

- —
- SO

### Vision System Non-Operational

It will be one of the following:

- —
- VN

### Intervention Required

It will be one of the following:

- —
- IR

### Check1

It will be one of the following:

- —
- C1

### All Storage Cells Full

It will be one of the following:

- —
- SF

### Out of Cleaners

It will be one of the following:

- —
- OC

**Dual Write Disabled**

It will be one of the following:

- —
- DD

**Smoke Detected**

It will be one of the following:

- —
- SM

**Manual Mode**

It will be one of the following:

- —
- MM

Example:

```
3494 C2444 UNSOL 13 AUTO ONLINE - - VN - - - - - *Operational State Change
```

This message indicates that vision is non-operational.

**Volume Exception SNMP Traps**

The Volume Exception message format is as follows:

```
3494 [Library Sequence Number] UNSOL 14 [Exception Code] [Volser]  
[Category] [ERA] [Message]
```

**Library Sequence Number**

Unique Library Sequence Number of the 3494 Tape Dataserver that generated the SNMP trap message.

**Exception Code**

It will be one of the following:

- 0x01
- 0x02
- 0x03
- 0x04
- 0x05
- 0x06
- 0x07
- 0x08
- 0x09

**Volser** This will be a six character string.

**Category**

Category effected by the volume exception.

**ERA** Additional information, not yet supported.

**Message**

The message will be one of the following:

- \*Misplaced Volume Found
- \*Volume Misplaced
- \*Duplicate VOLSER Ejected

- \*Duplicate VOLSER in Input Station
- \*Unreadable VOLSER left in Input Station
- \*Unexpected Volume Ejected
- \*Volume Inaccessible
- \*Inaccessible Volumes Restored
- \*Cleaner Volume Ejected
- \*UNKNOWN VOLUME EXCEPTION

Example:

```
3494 C2444 UNSOL 14 1 CNN444 FF01 20 *Misplaced Volume Found
```

## Device Availability Changed SNMP Traps

The Device Availability Changed message format is as follows:

```
3494 [Library Sequence Number] UNSOL 15 [Device] [Availability] [Modifier]
[First Errorcode] [Message String]
```

### Library Sequence Number

Unique Library Sequence Number of the 3494 Tape Dataserver that generated the SNMP trap message.

### Device

Device that is either going available/unavailable.

### Availability

This will be one of the following:

- A - Device becoming available
- U - Device going unavailable

### Modifier

Additional information, not currently supported.

### First Errorcode

Additional information, not currently supported.

### Message String

This will be one of the following:

- \*Device [Device] has been made available by the Library
- \*Device [Device] has been made unavailable by the Library

Example:

```
3494 C2444 UNSOL 15 180 A 20 6E84 *Device 180 has been made available by
the Library.
```

## Device Category Change Notification SNMP Traps

The Device Category Change Notification message format is as follows:

```
3494 [Library Sequence Number] UNSOL 16 [Device] [Category] [Parameters]
*Device Category Change
```

### Library Sequence Number

Unique Library Sequence Number of the 3494 Tape Dataserver that generated the SNMP trap message.

### Device

Device reporting the change.

**Category**

Category change has been made to.

**Parameters**

Additional information, not currently supported.

**Example:**

```
3494 C2444 UNSOL 16 180 FF01 20 *Device Category Change
```

## CHCK1 Library Manager SNMP Traps

This section discusses the format of the Library Managers CHCK1 messages. All CHCK1 Library Manager SNMP Traps have the same format.

The format for CHCK1 Library Manager SNMP Traps is as follows:

```
3494 [Library Sequence Number] CHCK1 [Errorcode] [Modifier] *A CHECK1 with  
errorcode: [Errorcode], and modifier: [Modifier], has occurred on [Library  
Sequence Number]
```

**Example:**

```
3494 C2444 CHCK1 BDDD 230 *A CHECK1 with errorcode: BDDD, and modifier:  
230, has occurred on C2444
```

**Note:** All Library Manager SNMP trap messages are actually one line of text; some have been split in order to fit on the pages of this document.

In this example, a BDDD CHECK1, with modifier 230, occurred on C2444 3494 Tape Dataserver.

**Errorcode**

The errorcode will be a hexadecimal value between 0 and 0xFFFF

**Modifier**

The modifier is used by the CHECK1 for additional information about the condition. Valid values are 0 to 64K.

## TESTM Library Manager SNMP Traps

This section discusses the TESTM Library Manager SNMP trap messages. All Library Manager TESTM SNMP trap messages have the same format.

The format is as follows:

```
3494 [Library Sequence Number] TESTM *{User Message}
```

**Example:**

```
3494 C2444 TESTM *THIS IS A TEST, 5/26/98 - 10:30 am
```

In this example, the user entered the string "THIS IS A TEST, 5/26/98 - 10:30 am". The asterisk character (\*) is automatically inserted in the Library Manager TESTM message. It is intended to aid the monitor station programmer.

---

## Using the Options Pull-Down

Figure 139 on page 227 shows the Options pull-down.



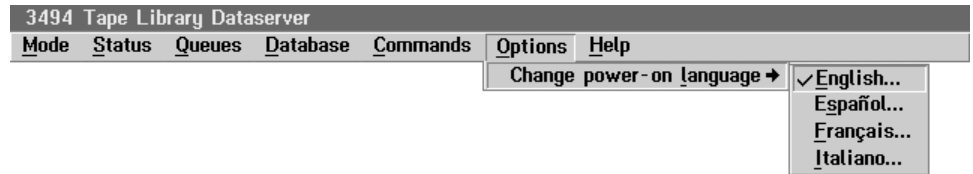

Figure 139. Options Pull-Down Menu

The Options pull-down selections are as follows:

**Clean desktop**

Removes any visible or minimized window from the screen. See “Using the Operator Menu” on page 98 for the screen now displayed. Also repositions all windows to their home positions.

**Change power-on language**

Displays a list of supported languages, which are selectable. The current language is indicated by a check mark. If a language is selected, the user is requested to confirm the selection. The new language becomes active when the library manager is shutdown and restarted.

## Using Manual Mode

Manual mode can be used as follows:

- A problem in the 3494 prevents automated operations.
- The service representative is performing scheduled maintenance activities.

The library manager allows the selection of Manual mode from the Mode pull-down of the Operator menu. (See “Manual Mode” in “Using the Mode Pull-Down” on page 99.)

When in Manual mode, the operator follows the instructions on the library manager display and confirms as necessary when the instructions are completed. Mount and demount requests issued to the virtual drives in a Virtual Tape server continue to be processed by the library automatically and are not included in the actions displayed for operator processing. If, in order to satisfy a mount to a virtual drive, a logical volume needs to be recalled from a physical volume, the resulting mount for that physical volume is included in the actions to be performed under manual mode.

Typical actions include physical cartridge mounts, demounts, and ejects (removing cartridges from the library). A sample screen with pending actions is shown in Figure 143 on page 230.

The library manager recognizes when a requested physical cartridge is successfully mounted in the requested drive and automatically removes the mount request from the list. Instructions to eject a cartridge are manually removed from the list when you use the keyboard to confirm (respond) that the action is completed or has an error.

A limited number of processed instructions can be viewed on the library manager display to correct any mistakes. See Figure 146 on page 236.

See “Cartridge Storage Cells” on page 24 for a description of the **From** and **To** locations used to find a cartridge for a mount.

**Note:** The display panels shown are examples and may not be exactly the same as the panels displayed on your library manager display.

## Starting Manual Mode

To select Manual mode, perform the following procedures:

1. Select **Mode** (see Figure 140) from the action bar on the Operator Menu at the library manager. See “Using the Mode Pull-Down” on page 99.
2. Verify that the 3494 is Online. If Offline, choose **Online** and confirm the selection. See “Online” on page 101.
3. Select **Manual** from the Mode pull-down. See “Manual” on page 101.

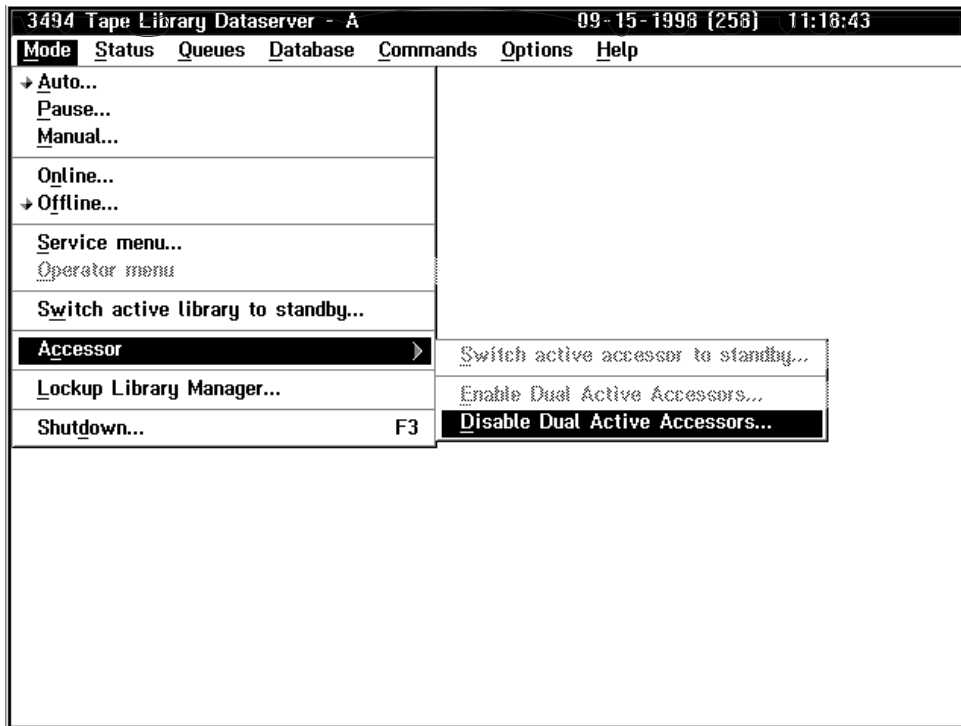

Figure 140. Mode Pull-Down Menu

4. Select the **Yes** push-button (see Figure 141) to start the change to Manual mode.

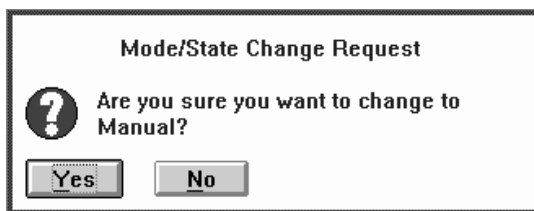
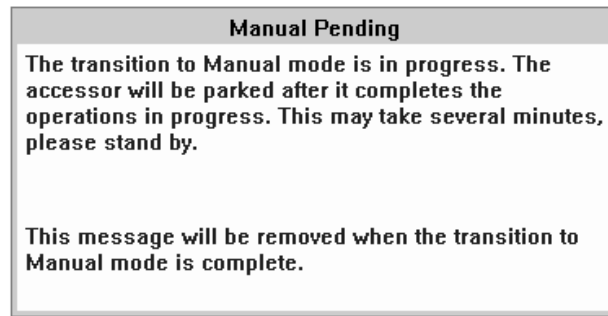

Figure 141. Mode/State Change Request Pop-Up Window

During the change to Manual mode, a wait period allows the library manager, if possible, to process all operations in progress, park the cartridge accessor and

remove power from the cartridge accessor. Figure 142 shows the wait message.



*Figure 142. Manual Pending Wait Message*

When the transition to Manual mode is complete, the Manual Mode Terminal pop-up window with the Action List screen (see Figure 143 on page 230) appears.

## Operating in Manual Mode

Figure 143 shows the Manual Mode Terminal pop-up window with the Action List screen.

Action List				
Select an action. Press Enter to confirm action completion (except Mounts).				
Action	VOLSER	From	To	
<b>Mount</b>	<b>WCC007</b>	<b>Rack 12 B 11</b>	<b>Device 3F1</b>	
Mount	WSB392	Rack 7 C 5	Device 3F0	
Mount	TFW001	Device 201	Device 3F1	
Mount	SCR023	Rack 12 E 6	Device 3F0	
Mount	WR0112	Rack 3 J 13	Device 201	
Mount	TGB041	Rack 4 F 3?	Device 200	
Mount	ECR223	Rack 10 D 13	Device 3F1	
Mount	SFC607	Rack 9 F 2	Device 3E1	
Mount	FGG641	Rack 11 C 10	Device 200	
Eject	ERV399	Rack 13 F 11		

More actions are waiting.  
Press the Refresh key (F9) to update the list.  
F1=Help F3=HideScreen F4=Error F5=Insert F6=Review F9=Refresh F10=Locate

Figure 143. Manual Mode Terminal Pop-Up Window with Action List

### Legend:

#### Action

The operator task. See the following procedures for details.

#### VOLSER

The cartridge volume serial number.

**From** The place where you should find the cartridge specified in VOLSER.

**To** The place where you should put the cartridge.

#### Device

The 3490E/3590 tape drive.

**Rack** The physical storage address that can contain one cartridge.

**?** The cartridge may not be in the location specified. See Note 2.b on page 232.

The Action List screen presents tasks to perform. Perform the actions in the sequence listed (see Figure 143). Read the following Mount, Demount, Insert, and Eject procedures for how to perform each action.

The following are the function keys of the Action List screen:

**F1** Displays instructions for performing Manual mode tasks.

**F3** Hides this pop-up window (Manual Mode Terminal). The Manual Mode Terminal pop-up window is hidden but can be retrieved by selecting the Mode pull-down and then selecting Manual mode.

- F4** Indicates that an action cannot be completed. It displays the Error Processing screen that contains a list of possible error choices. See Figure 147 on page 237.
- F5** Allows you to manually add volumes to the tape library. It displays the Insert Cartridges screen that contains prompts for cartridge insertion. See Figure 144 on page 233.
- F6** Displays up to the last 20 commands processed in Manual mode. This can be used to verify or to correct a possible error when returning a cartridge to its storage cell.
- F7** Displays information above the visible area of the screen.
- F8** Displays information below the visible area of the screen.
- F9** Updates the Action List screen with additional host requests.
- F10** TBD Displays the Locate Cartridge Home screen, which allows you to find a volser's home cell. See Figure 148 on page 238.

In addition, the following keys are used:

**Arrows**

Highlights the action to be performed. You can use the up or down arrows.

**Enter** Sends confirmation to the library manager that the highlighted action (eject) was completed.

Choose the action. Instructions include the following:

**Mount** Specifies the cartridge volser to be retrieved from a specific storage cell and loaded in a specific tape drive.

**Eject** Specifies the cartridge volser to be removed from the library.

**Note:** If the drive's feed slot already contains a cartridge, perform "Demounting Cartridges" on page 232.

## Mounting Cartridges

Mount requests from the host are displayed on the 3490E message display or on the 3590 operator panel and on the Action List screen. The two mount procedures are "Using the Drive Message Display", which is the most efficient, and "Using the Action List Screen" on page 232.

**Attention:** Do not attempt to insert a 3590 High Performance Cartridge Tape into a 3490E. Do not attempt to insert a 3490E Enhanced Capacity Cartridge System Tape into a 3590.

### Using the Drive Message Display

Do not use the library manager for this procedure.

1. Read the 3490E/3590 message display for the volume serial number of the cartridge and the cell location of the volume. The drive message display alternates between the two messages.
2. Get the cartridge from the specified cell location.
3. Mount the cartridge on the specified drive. If the drive's feed slot already contains a cartridge, perform the "Demounting Cartridges" on page 232.

## Using the Action List Screen

Use the library manager for this procedure.

1. Select mounts in the order shown on the Action List screen. See Figure 143 on page 230 .

The mounts are listed in order of priority with the highest priority at the top.

**Note:** Mounts are automatically confirmed and removed from the Action List screen when a successful mount is done.

2. Get the specified volume at its **From** storage cell location. See “Cartridge Storage Cells” on page 24 if you are not familiar with the numbering of components.

**Notes:**

- a. If the **From** location is a drive, remove the cartridge from the drive.
  - b. If the **From** location is followed by ?, the cartridge has already been used in Manual mode. If the cartridge is not in the indicated **From** location, look in the output facility where you are storing demounted cartridges, for example, the cartridge cart or the high-capacity output facility.
3. Place the volume in specified **To** drive. The message display on the drive indicates the volser of the requested volume alternating with the cell location of the cartridge.

**Note:** If the drive already contains a cartridge, perform “Demounting Cartridges”.

## Demounting Cartridges

**Note:** Do not place demounted cartridges in the high-capacity output facility. If the High-Capacity I/O Facility is defined, it can be used to store the demounted cartridges.

When you are performing a mount and the drive contains a cartridge, do the following:

1. Remove the cartridge from the drive.
2. Perform one of the following procedures with the cartridge:
  - Place the cartridges in a secure location, such as a cartridge cart. You will put these cartridges in the library when the 3494 is returned to Auto mode through an I/O station.
  - For an extended period of Manual mode, you may choose to use the Figure 148 on page 238 to put the cartridges in their home cells.
  - Place the cartridge in any unoccupied cartridge cell in the library, **except in the high-capacity output cells**. Make sure that the inventory update is enabled.

## Inserting Cartridges

An insert action is initiated when a cartridge must be added to the 3494. One or more cartridges may be in the Convenience Input/Output Station or you may be handed a cartridge to be added into the library.

1. Press the Insert key (F5) on the Action List screen of the library manager. See Figure 143 on page 230.

- On the Insert Cartridges screen (see Figure 144), enter the volser of the cartridge to be inserted. The cartridge volser is the set of up to six alphanumeric characters on the label attached to the end of the cartridge.

**Note:** Use the left and right arrow key to move the cursor within a field. Use the Tab key to move between fields.

- Type the character (I,E or J) that corresponds to the cartridge type.

**Note:**

- Cartridge System Tape (single-tone case) is type 1.
- Enhanced Capacity Cartridge System Tape (two-tone case) is type E.
- High Performance Cartridge Tape (black with blue tabs) is type J.

- Type the character (0, 1, or 2) that corresponds to the library to associate the cartridge with. The selections are:

- 0. Non-VTS Library
- 1. VTS 1
- 2. VTS 2

The associated library sequence number is displayed next to each selection.

**Note:** Only J type media can be inserted into a Virtual Tape Server logical library.

The function keys for the pop-up window are:

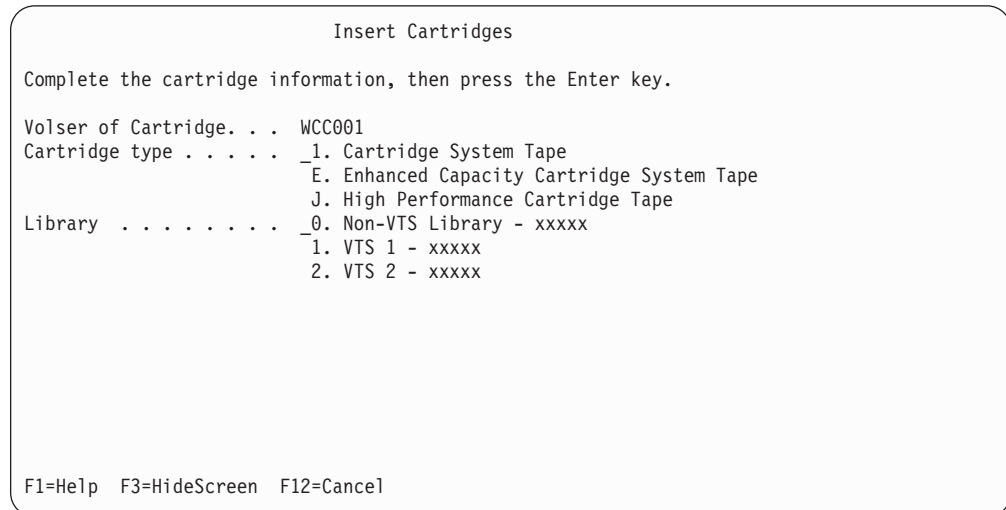

Figure 144. Manual Mode Insert Cartridges Screen

- F1** Display the help information for this screen.
- F3** Hides this pop-up window (Manual Mode Terminal). The Manual Mode Terminal pop-up window is hidden but can be retrieved by selecting the Mode pull-down and then selecting Manual mode.
- F12** Close this screen and return to the Action List screen.
- Arrows** Move the cursor by pressing the right or left arrow key.
- Enter** Confirm entries in a field or confirm the insertion of a cartridge.

5. Press the Enter key. A pop-up screen is displayed with the **Home Cell** rack storage location for the inserted cartridge. See Figure 145.
6. Place the cartridge in the designated rack storage cell.
 

**Note:** If the cartridge cannot be put in the specified storage cell, press the Error key (F4) to request a new storage cell location.
7. Press the Enter key to confirm that the insert action is complete. The Insert Cartridges screen is displayed again.
8. If you have another cartridge to insert, repeat steps 2 on page 233 through 7 on page 234 for the next cartridge. If there are no more cartridges to insert, press the Cancel key (F12) to return to the Action List screen.

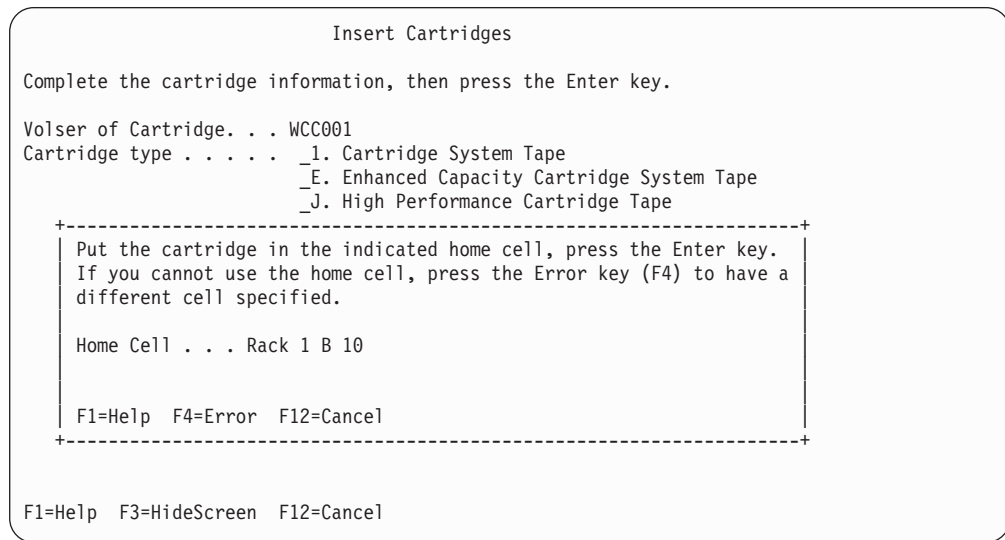

Figure 145. Manual Mode Insert Cartridges Pop-Up Window

The function keys for the pop-up window are:

- F1** Display help information about this pop-up window.
- F4** Specify another home cell location because the cartridge cannot be inserted in the specified location.
- F12** Close the pop-up window and return to the Insert Cartridges screen.
- Enter** Send confirmation to the host program that verifies that the cartridge is inserted in the specified location. Also, display the Insert Cartridges screen for the next insert.

**Note:** When you return to the Manual Mode Action List, Figure 143 on page 230 and if you've inserted J-type media in an Import/Export capable Library, the Manage Unassigned Volumes panel will automatically be presented. The Manage Unassigned Volumes panel is shown in Figure 129 on page 202.

## Ejecting Cartridges

Use the following procedure to remove a cartridge from the 3494:

1. From the Action List screen, determine the drive (device) or storage cell **From** location containing the cartridge to be ejected. See Figure 143 on page 230.



2. Go to the drive or storage cell and remove the cartridge. Verify that the cartridge volser matches the volser specified on the action list.

**Notes:**

- a. If the **From** location is a drive, remove the cartridge from the drive.
  - b. If the **From** location is followed by ?, the cartridge has already been used in Manual mode. If the cartridge is not present in the indicated **From** location, look in the location where you are storing demounted cartridges, for example, the high-capacity output area.
3. Remove the cartridge from the enclosure or place it in a safe location. Be sure to remove all ejected cartridges from the enclosure when Manual mode operations are completed.
  4. Confirm that the eject is complete as follows:
    - a. Highlight the action item to be confirmed on the Action List screen of the library manager.

To highlight an item, use the up and down arrow keys to move the highlight bar to the desired action item.
    - b. Confirm the highlighted action item by pressing the Enter key.

**Note:** Be sure to confirm each ejected cartridge after completing the eject task. Eject actions remain on the Action List screen until they are manually confirmed.

5. Press the Refresh key (F9) to update the list.

## Reviewing Unknown Volume Locations

Use this procedure if you are not sure where a volume should go. You can display the volser **From** location and **To** location of the last 20 completed actions. Use this information to verify the accuracy of a completed action item.

1. Press the Review key (F6) on the Action List screen of the library manager. See Figure 143 on page 230.
2. Return to the Action List screen by pressing F12.

If the volume was not listed on the Review List screen (see Figure 146 on page 236), use the Locate Cartridge Home screen to find a storage cell in which to put the volume. See Figure 148 on page 238.

Review List					
Action	VOLSER	From	To		
Mount	GKT333	Rack 2 B 40	Device 200	Confirmed	
Eject	SRJ485	Rack 1 A 7		Confirmed	
Mount	EPF371	Device 200	Device 3E1	Confirmed	
Mount	SDR495	Rack 7 A 6	Device 201	ERROR (see Note)	

F1=Help F3=HideScreen F12=Cancel

Figure 146. Manual Mode Review List Screen

**Note:** The ERROR indication is caused by the operator pressing F4 on the Action List screen.

You can only view this screen. You perform the tasks (actions) from the Action List screen.

## Error Processing

Use the following procedure to describe the problem to the host system if you cannot complete a mount or eject action:

1. Highlight the action item that you cannot complete on the Action List screen. Use the up or down arrow keys to highlight the questioned action.
2. Press the Error key (F4) on the Action List screen of the library manager.
3. Select the error description that best fits the problem. Use the up or down arrow keys to highlight the error description. See Figure 147 on page 237.
4. Press the Enter key to send the error description to the host processor.

**Note:** Press the Cancel key (F12) to replace the Error Processing screen with the Action List screen. No error message is sent.

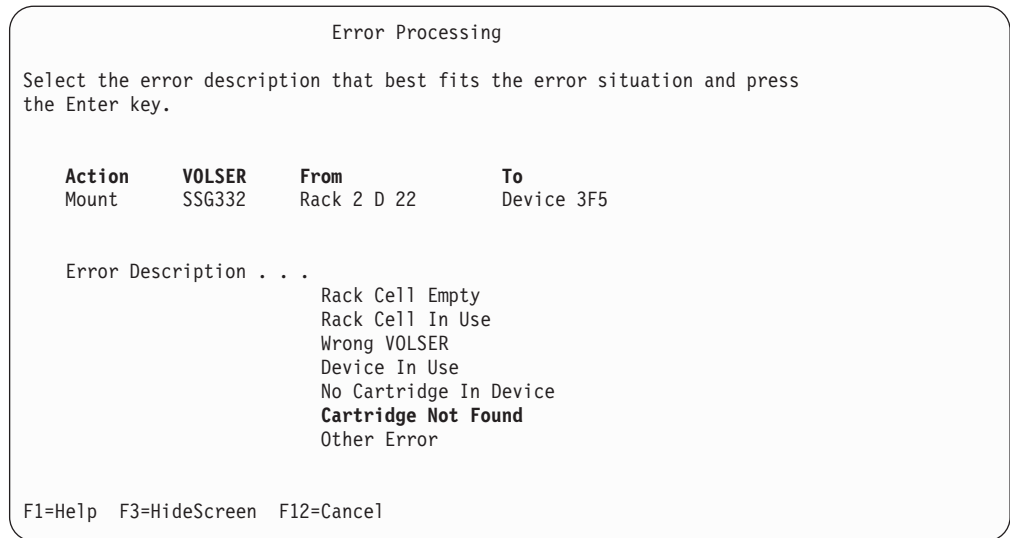

Figure 147. Manual Mode Error Processing Screen

## Locating and Identifying Home Cell Locations

Use the following procedure to locate and identify the home cell locations:

- Determine the home cell in which to place a misplaced or inaccessible volume.
  - Determine the home cell so you can find a volume.
1. Press the Locate key (F10) on the Action List screen of the library manager. See Figure 143 on page 230.
  2. Enter the volume to find its home cell and then press the Enter key. The home cell for the volume is displayed on the Locate Cartridge Home screen. See Figure 148 on page 238.
  3. If you place the volume in the home cell or verify that the volume is already in the home cell, press the Enter key; otherwise, press the Cancel key (F12).
  4. Return to the Action List screen by pressing the Cancel key (F12).

**Note:** The Locate function works only for physical volumes. Logical volumes do not have a home cell.

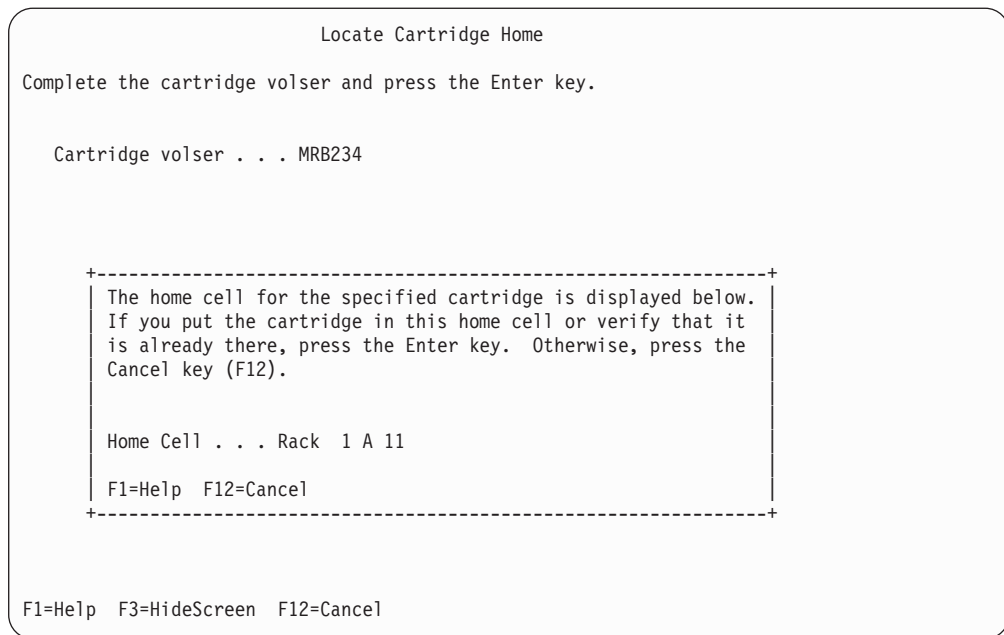

Figure 148. Manual Mode Locate Cartridge Home Screen

## Ending Manual Mode

To end the Manual mode, do the following steps:

1. Leave cartridges in the drives. They will be automatically moved by the library when it returns to Auto mode.
2. Close the front doors on the library.
3. Make sure any mounts that were started have been removed from the manual mode display.
4. Press the Ctrl key and the Esc key at the same time to produce the task list.
5. Select the Library Manager selection on the task list with the pointing device.
6. Select **Mode** from the action bar on the Operator Menu.
7. Verify that the library is Online. If the library is Offline, choose **Online** and confirm the selection.
8. Enable Inventory Update if it is disabled so that the Inventory Update can re-establish current location on all volsers.
9. Select **Auto** from the Mode pull-down. The mode change request pop-up window is displayed to ask if you want to change the operating mode. Select yes to change to Auto mode.

An Auto Pending message indicates the transition to Auto mode is in progress. The 3494 returns to Auto mode after Manual mode.

When the transition to Auto mode is made, an inventory update is performed. The inventory update must complete before the Auto activity resumes.

---

## Cartridge Removal from the Gripper

Some operator intervention conditions require the operator to remove the cartridge from the gripper. Figure 149 shows the picker and the gripper assembly. Remove the cartridge from the gripper by doing the following:

1. Press the Pause button on the operator control panel if the library is not already in Pause mode.
2. Open the front door on the library in front of the cartridge accessor.
3. Rotate the picker **1** so the picker is pointing toward the right side of the machine, paralleling the rails **3**.
4. Push the reach assembly **5** out so it is fully extended.
5. Press the top **2** of the gripper assembly to release the cartridge **4**.
6. Push the reach assembly **5** in so it is fully retracted.
7. Close the front door.
8. Press the Auto button on the operator control panel to return the library to Auto mode.

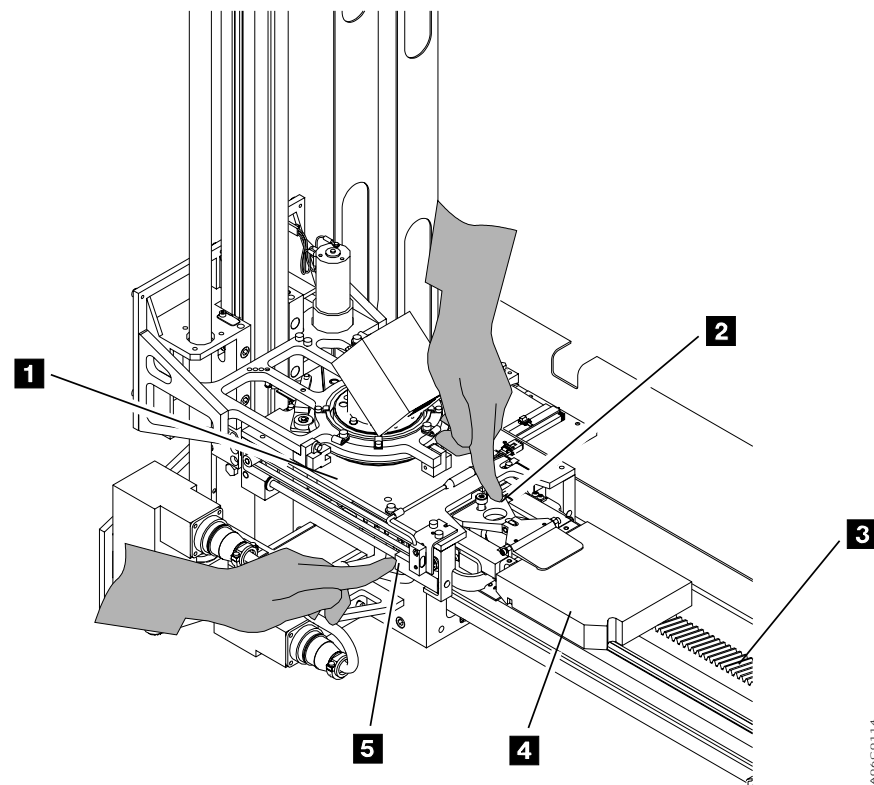

Figure 149. Cartridge Removal from the Gripper

---

## Using the Keyboard Template

“Appendix A. Keyboard Template” on page 305 illustrates the function keys on the library manager keyboard which are used during normal activity. That template can be copied or removed and then folded to create a triangular bar shape with the illustration of the keys showing on one face. The template can then be placed in a convenient location for quick access to the correct key for a specific function.

## Chapter 7. Remote Library Manager Console Feature

When the Remote Library Manager Console feature is installed, an operator can control or monitor operations for libraries from a remote location. The remote library manager console (controlling workstation) is connected to the library manager (controlling workstation) through a local area network (LAN). The customer orders either the Token Ring LAN Attachment feature or the Ethernet LAN Attachment feature when the Remote Library Manager Console feature is ordered. Figure 150 shows an example of the Token Ring LAN and the Ethernet LAN.

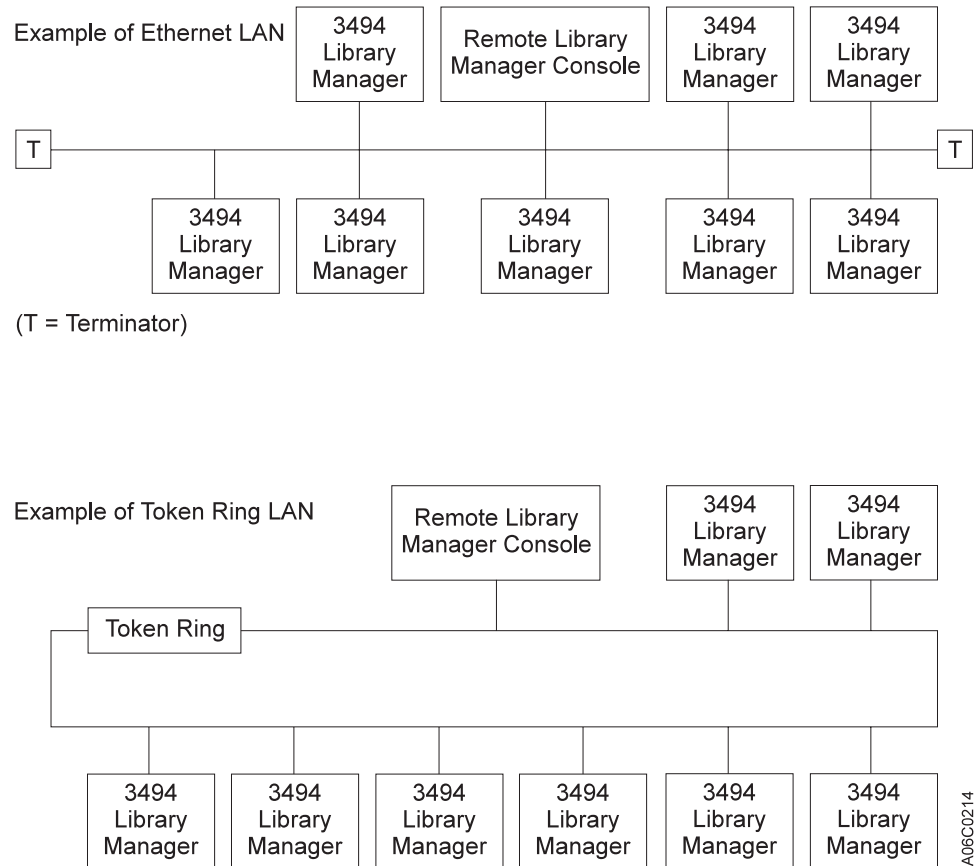

Figure 150. LAN Attachments

The Distributed Console Access Facility (DCAF) product is installed on the library manager and the remote library manager console when the Remote Library Manager Console feature is installed. If this topic does not describe a task you want to perform, refer to *Distributed Console Access Facility: Installation Guide* SH19-4068, and *Distributed Console Access Facility: V1R3.1 Target User's Guide*, SH19-6839. If the task is similar to one in a referenced document, use the description presented here.

This topic is intended for system planners, system programmers, LAN administrators, and operators. Some users are expected to be familiar with operating system and text editor.

---

## Installing and Configuring

The Remote Library Manager Console feature can use one of two communication protocols to establish communications between the remote (controlling workstation) console and the 3494 (target workstation) library manager. To establish communications between the remote library manager console and the 3494, the *communications protocol* and *LAN adapter protocol* support must be properly configured. Configuration is handled by the installation program, which is on the Remote Library Manager Console feature disk. Review the Remote Library Manager Console feature installation instructions to understand the following:

- How the remote library manager console and 3494 library communications are integrated
- How the names and addresses are used to configure the communications protocol

---

## Starting DCAF on the Remote Library Manager Console

Starting DCAF on the remote library manager console automatically causes DCAF to start on the library manager. To start the remote library manager console program, do the following steps:

1. Start the Communications Protocol on the remote (controlling workstation) console.
2. Choose the **Distributed Console Access Facility** group. (See Figure 151.)



Figure 151. Icon for Distributed Console Access Facility

3. Choose **DCAF Controller** (See Figure 152.)



Figure 152. Distributed Console Access Facility Icon

After the IBM logo is displayed, the controlling main window appears. (See Figure 153 on page 243.)



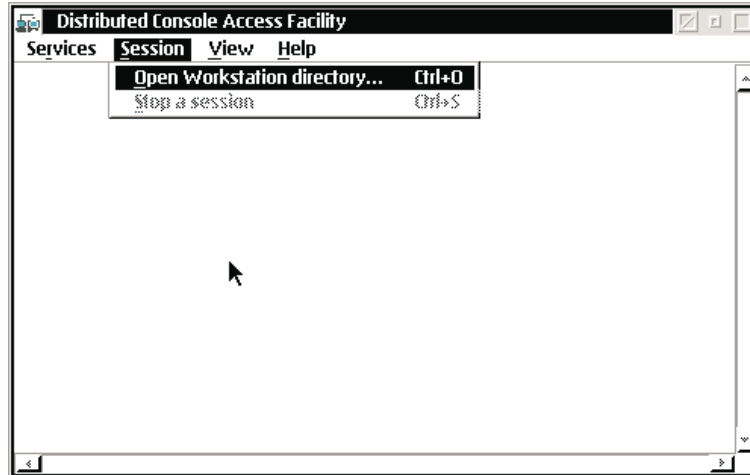

Figure 153. DCAF Controlling Main Window

4. Workstations must be added. See 8 on page 246. Choose **Open Workstation Directory** from the Session pull-down.  
The DCAF directory window appears. (See Figure 154.) It lists the link records of the target workstations that are directly connected through the Communication Protocol.

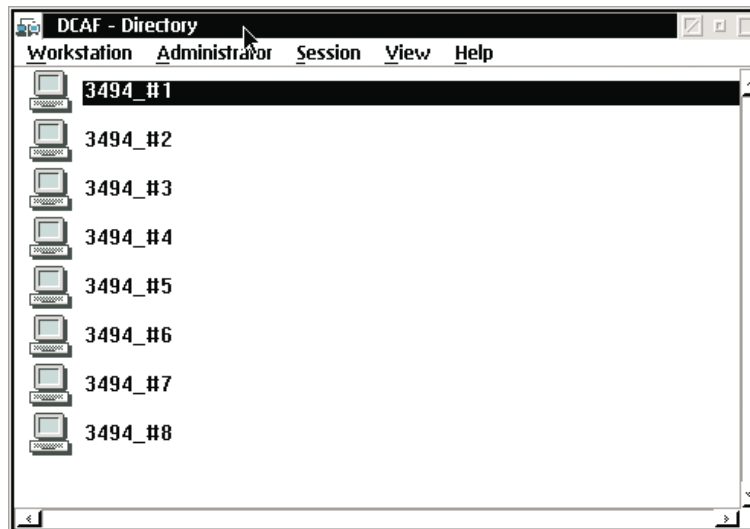

Figure 154. DCAF Directory

5. Select the workstation name by either of the following:
  - a. Positioning the pointing device cursor on the required link (for example, 3494 #1) and double clicking with the left pointing device button.
  - b. Using the up or down arrow key to select a link record and pressing the Enter key.

The DCAF target password window appears. See Figure 155 on page 244.

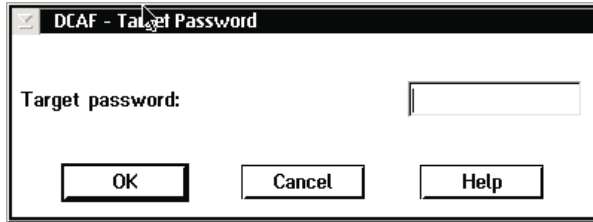

Figure 155. DCAF Target Password

6. Type in the target password (the default is *Impsword*) to start the session.  
As you type the password, the cursor moves and an asterisk (\*) is displayed in place of the character. The following are password guidelines:
  - One to eight characters
  - Uppercase or lowercase letters A–Z
  - Digits 0–9
  - Embedded blanks (blanks after the last character are ignored)
7. Press the **OK** push button or click on OK with the left pointing device button.  
When the remote library manager console Distributed Console Access Facility is starting, it displays its status (Figure 156).

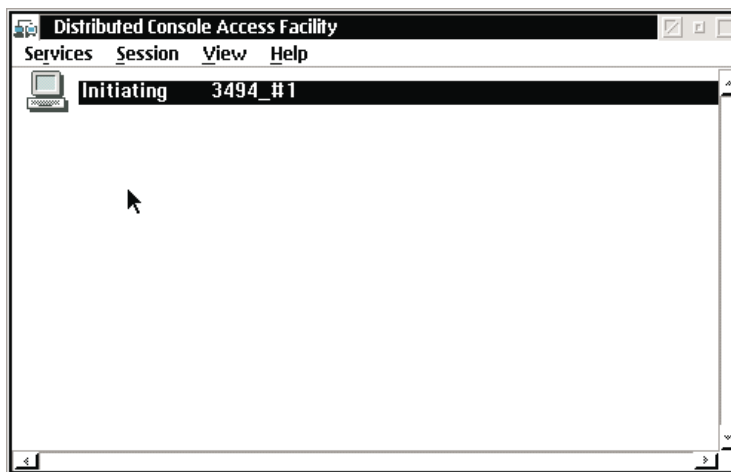

Figure 156. Initiating the Remote Library Manager Console

The advanced program-to-program communications (APPC) or TCPIP indicating **Started** appears momentarily on the library manager display (Figure 157 on page 245).

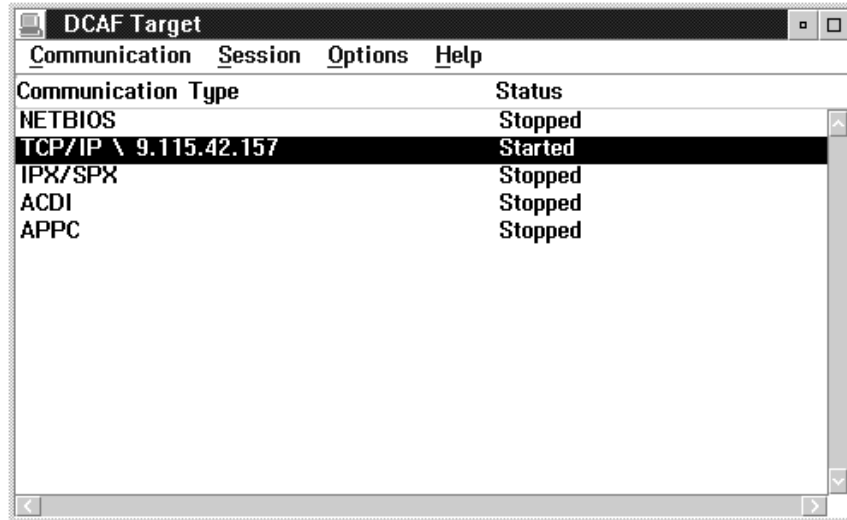

Figure 157. Establishing Communication with the Library Manager

After the initiation of the library manager is completed, the Main Menu appears on the remote library manager console (Figure 158). In this case, the selected library manager is paused and the Whole Queue is displayed when the remote library manager console is started. You can size this window to full screen by placing the pointing device cursor in the right box of the title bar and clicking once with the left pointing device button.

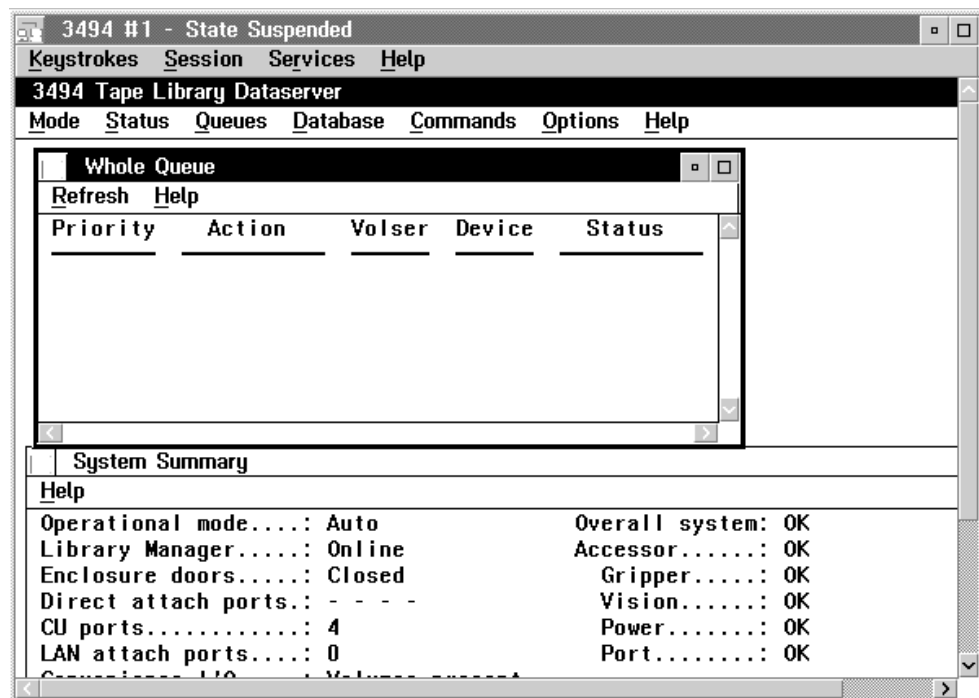

Figure 158. Remote Library Manager Console Main Menu

You can now use the pointing device cursor and buttons to select options on the selected 3494, just as if you were at that 3494.

From the remote library manager console, you can also choose from the following options:

**Keystrokes**

See "Using Keystrokes during a Session from the Remote Library Manager Console".

**Session**

See "Changing the Session State from the Remote Library Manager Console" on page 249.

**Services**

See "Transferring Files" on page 253.

**Help**

Use this push button to receive information about the item that the cursor is on or about the entire window.

8. To start a session with another 3494, do the following:
  - a. Press Ctrl+Esc to view the task list on the remote (controlling workstation) console.
  - b. Under **DCAF Controller**, select **Distributed Console Access Facility**.
  - c. Repeat step 4 on page 243 (**Open Workstation Directory** from the Services pull-down) through step 7 on page 244.

---

## Controlling the Tape Library from the Remote Library Manager Console

The remote library manager console operator can control one or more tape libraries from a remote library manager console when **Active** is selected from the Session pull-down. The remote library manager console displays the target library manager screen of each selected library in the network. The operator displays the screens by switching between library managers or by displaying them simultaneously via windows by using the remote library manager console task list.

## Using Keystrokes during a Session from the Remote Library Manager Console

The keystrokes mode, displayed on the title bar of the remote library manager console session window, determines whether the remote library manager console's keyboard input and pointing device movements affect the remote library manager console or the 3494 library manager. The remote library manager console starts with *state active* and *keystrokes remote* displayed in the title bar. See Figure 159 on page 247.

The remote library manager console operator can change keystroke modes during an active session.

### Keystrokes Remote Mode on the Remote Library Manager Console

All the keyboard input on the remote library manager console, except the remote library manager console operating-system hot-keys, affects the library manager. Operating-system hot-key combinations always affect the remote library manager

console only. Alt+Esc, Alt+Tab, and Ctrl+Esc are the hot-key combinations. For example, Ctrl+Esc causes the remote library manager console's task list to appear on the remote library manager console.

Pointing Device movements inside the library manager screen on the remote library manager console are sent to the library manager. If you move the pointing device outside the library manager screen, the pointing device movements are processed on the remote library manager console. For example, if you choose an action from a pull-down in a library manager screen, the action is processed on the library manager. If you choose an action from a pull-down on a remote library manager console window, the action is processed on the remote library manager console.

You can send operating-system hot-key combinations to the library manager from the Keystrokes pull-down. See Figure 159.

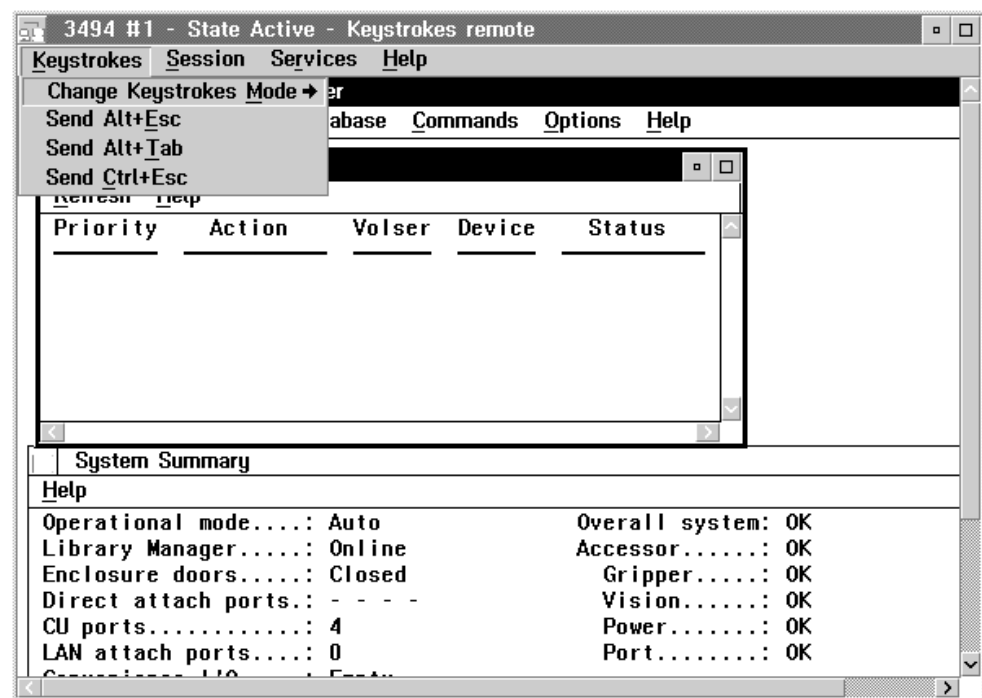

Figure 159. Remote Library Manager Console Window with Keystrokes Pull-Down Menu

Figure 159 shows the remote library manager console window with a view of the library manager's display during an active session. The remote library manager console user is working in *keystrokes remote* mode.

## Keystrokes Local Mode on the Remote Library Manager Console

All the keyboard input and pointing device movements affect the remote library manager console only. All keystrokes on the remote console are processed by the remote library manager console.

Only shortcut keys from the Keystrokes pull-down affect the library manager. These shortcut keys simulate operating-system hot-key combinations, which are Alt+Esc, Alt+Tab, and Ctrl+Esc. Table 8 on page 248 shows the effect of the shortcut keys.

Table 8. Shortcut Keys for the Library Manager

Keys	Result
Ctrl+E	Simulates the Alt+Esc key combination on the library manager, which causes the library manager to show the windows and full-screen sessions in an ordered rotation.
Ctrl+U	Simulates the Alt+Tab key combination on the library manager, which causes the library manager to show the system menus for the windows and full-screen sessions in an ordered rotation.
Ctrl+C	Simulates the Ctrl+Esc key combination on the library manager, which causes the library manager to display its task list.

## Changing Keystrokes Mode

To change keystrokes mode on the remote library manager console, do one of the following:

- Press the controlling hot-key combination (default Alt+T) to switch between *keystrokes local* and *keystrokes remote* mode or
- Move the pointing device into the Keystrokes menu and choose **Keystrokes remote** or **Keystrokes local** from Change Keystrokes Mode.

## Using Hot-Key Combinations

To view the task list on the remote library manager console, press **Ctrl+Esc**.

To view the task list on the library manager, choose **Send Ctrl+Esc** from the Keystrokes pull-down on the remote library manager console.

## Sending the Alt+Esc Command to the Library Manager

To send the Alt+Esc command to the library manager, do the following:

- Choose **Send Alt+Esc** from the Keystrokes pull-down on the remote library manager console session window (Figure 159 on page 247).
- Press the **Ctrl+E** shortcut key if the remote library manager console is in keystrokes local mode.

Sending the Alt+Esc command lets you see the library manager's full screen or window sessions in an ordered rotation. If you go through the rotation to a full screen session, you are immediately in the full screen session of the library manager.

## Sending the Alt+Tab Command to the Library Manager

To send the Alt+Tab command to the library manager, do the following:

- Choose **Send Alt+Tab** from the Keystrokes pull-down on the remote library manager console session window (see Figure 159 on page 247).
- Press the **Ctrl+U** shortcut key if the remote library manager console is in keystrokes local mode.

Sending the Alt+Tab command lets you see the system menu for the library manager's full screen or window sessions in an ordered rotation. Sending this command causes the library manager's system menu for the next window to be displayed.

## Sending the Ctrl+Esc Command to the Library Manager

To send the Ctrl+Esc command to the library manager during an active session, do the following:

- Choose **Send Ctrl+Esc** from the Keystrokes pull-down on the remote library manager console session window (see Figure 159 on page 247).
- Press the Ctrl+C shortcut key if the remote library manager console is in keystrokes local mode.

Sending the Ctrl+Esc command lets you display the task list on the library manager. After you display the task list, you can choose a task from the list.

## Changing the Session State from the Remote Library Manager Console

The session state is the current state of the session between the remote library manager console and the library manager workstations. Both workstation users can change the session. While the remote library manager console is changing the session state, the library manager cannot alter that session. If both users try to change the state at the same time, the library manager takes precedence.

A status indicator of the session appears in the title bar of the session window or, when the session interface is minimized, under the remote library manager console icon.

Figure 160 on page 250 shows the remote library manager console window in the library manager's display during an active session. The remote library manager console is in keystrokes remote mode.

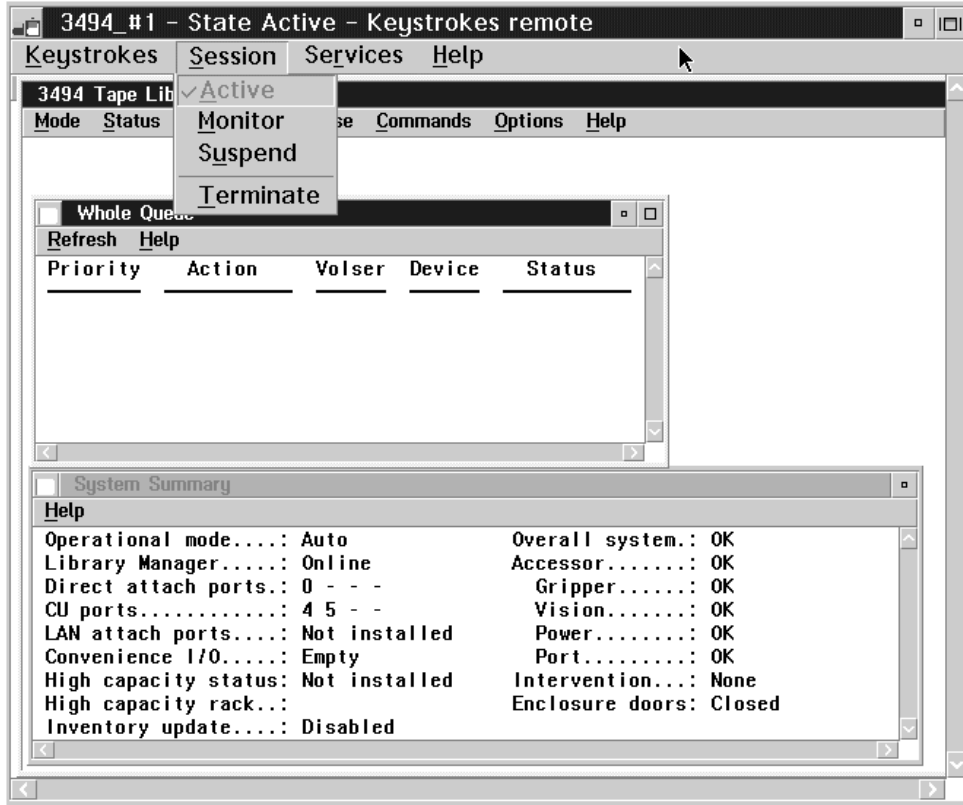

Figure 160. Remote Library Manager Console Session Window with Session Pull-Down Menu

The link record name (3494 #1), the current session state (active), and the keystrokes mode (remote) are displayed on the title bar of the remote library manager console window. See Table 9 on page 251 for a description of the session states.

To change the session state, do the following:

- Choose the Session pull-down and the action to change the session state.
- Press one of the following shortcut keys associated with the action to change the session if the remote library manager console is in keystrokes local mode:

**Active** Ctrl+A

**Monitor**  
Ctrl+M

**Suspend**  
Ctrl+S

**Terminate**  
Ctrl+T



Table 9. Session States

Session State	Description
Active	A DCAF session is established. The controlling workstation (remote library manager console) controls the keyboard and monitors the display of the target workstation (library manager). The library manager keyboard is locked; the keystrokes and pointing device commands entered on the library manager are not processed. The library manager user can regain control by pressing the hot-key combination to change the session state.
Busy	A DCAF session is established. The library manager user pressed the hot-key combination and regained control. The remote library manager console user must wait until the library manager user puts the DCAF session in another state.
Initiating	The remote library manager console is starting a DCAF session with the library manager.
Monitor	A DCAF session is established. The remote library manager console monitors (watches) the activity of the library manager. The remote library manager console user sees the library manager display, but the library manager user is in control of the keyboard and pointing device input. The library manager user can press the hot-key combination to change the session state.
Suspend	The DCAF session in progress is suspended (stopped temporarily). The remote library manager console does not monitor the library manager and does not have control of the keyboard and pointing device. Either console user can resume the session.
Terminate	The DCAF session is terminating (ending).

## Using the Pointing Device during a Session

Figure 161 on page 252 shows the library manager's display during an active session. The operational status from the library manager was selected with the pointing device by the remote library manager console user. The remote library manager console is in keystrokes remote mode.

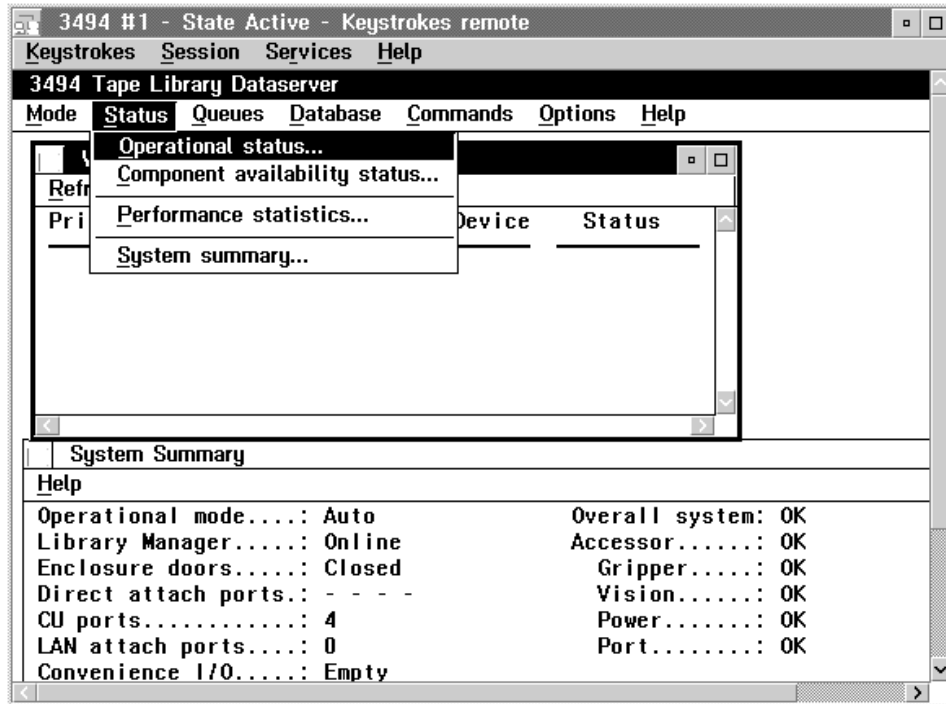

Figure 161. Remote Library Manager Console Session Window

During an active session, the pointing device is useful for making selections from the remote library manager console menu bar or for performing operations on the library manager display. The keystrokes mode (local or remote) is for the remote library manager console keyboard only and has no effect on the pointing device.

The remote library manager console pointing device determines the position of the pointing device of the library manager. The remote library manager console pointing device can move the library manager pointing device if the following conditions are true:

- The remote library manager console session window is the active window where the remote library manager console user is giving pointing device commands.
- The remote library manager console pointing device position is within the remote library manager console session window.

**Note:** The pointing device displayed on the remote library manager console may not be the same as on the library manager because of differences in the display drivers.

Excessive movement of the pointing device during the active state in the remote library manager console window can cause the operation to run slowly because the pointing device movement sends information across the network.

**Note:** If you perform an operation that is not allowed on the remote library manager console, the library manager console beeps once.

When the remote library manager console is in the active state, the library manager pointing device is disabled. During the monitoring, busy, or suspended states, the pointing device for the remote library manager console and the library manager function independently.

## Moving Among Multiple Sessions

Moving among multiple remote library manager console sessions follows the general conventions for moving around the windows.

The remote library manager console main window displays each library manager session. The current sessions are listed by the appropriate link record name. To change to a different session, do the following:

- Choose the new session from the remote library manager console main window.
- Go to the task list and switch to the new session.

You can minimize or maximize the remote library manager console session windows and arrange them on the remote library manager console. To return to the remote library manager console main window, go to the task list and switch to the Distributed Console Access Facility (remote library manager console main window).

---

## Transferring Files

You can use the file-transfer utility to transfer files from the library manager to the remote library manager console. Transferring files to the library manager is not allowed. Only the remote library manager console can initiate a file transfer. The remote library manager console can be in the monitoring state or the active state.

To transfer files from the library manager, do the following:

1. Choose **Start file transfer** from the Services pull-down on the remote library manager console. The File Transfer Utility window appears.
2. Type the *path* and the *file name* of the source file. If the path is not specified, the drive and directory where the DCAF is installed is used.
3. Type the *path* and the *file name* of the destination file. If the file name is not specified, the same name as the source file is used.
4. Mark the Overwrite check box if you want to replace a destination file that already exists.
5. Press the Receive push button for the remote library manager console to receive the file from the library manager.

A window appears that shows what percent of the file has transferred. To interrupt the file transfer, press the Stop push button.

---

## Library Manager Operations with a Remote Library Manager Console

You can change the session state and the password from the library manager.

### Changing the Session State of the Library Manager

After a session is established between the remote library manager console and the library manager, the remote library manager console controls the library manager keyboard and monitors the library manager display. The keyboard and pointing device on the library manager are locked.

To regain control at the library manager, the session state must be changed. To change the session state do one of the following:

- The remote library manager console operator can change the session state as follows:

- Terminate the session. All remote operations stop until a new session is established.
- Suspend the session. Control returns to the library manager.
- Monitor the session. The remote library manager console can monitor the display on the library manager, but the keyboard on the library manager is active.
- The library manager operator can change the session state by using the hot-key combination at the library manager keyboard as follows:
  1. Press **Alt+T** on the library manager console. The DCAF Target window appears, and shows that the target is busy. See Figure 164 on page 255.
  2. Click once with the pointing device in the minimize box in the upper right corner of the target window. The library manager keyboard is now operational.

**Attention:** Do not close this window. If you **CLOSE** this window instead of **MINIMIZING** it, remote console access to the library manager will be disabled until the library manager is rebooted.

- If you want to return control to the remote library manager console or want to allow the remote library manager console to monitor operations, change the session state as follows:
  - The remote library manager console operator can stop and restart the connection at the remote library manager console.
  - The library manager operator can restart the session as follows:
    1. Press **Ctrl+Esc** to display the task list.
    2. Select **DCAF Target** with the pointing device. See Figure 162.

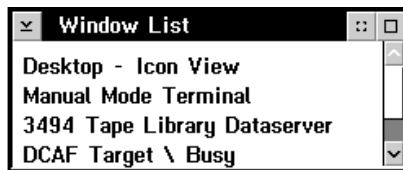

Figure 162. Window List

3. From the DCAF target window, select the session window and select **Active** or **Monitor**. See Figure 163 on page 255.

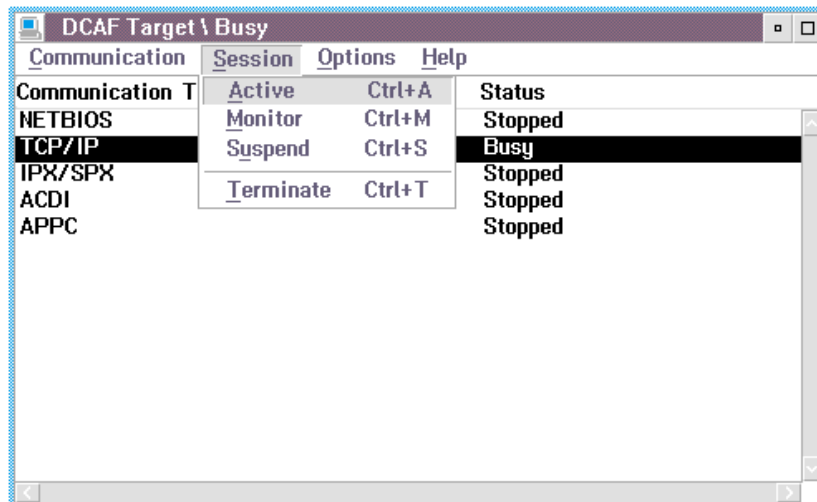

Figure 163. Active Session

## Changing the Password from the Library Manager

The remote library manager console logon password can be changed *only* from the library manager during a session. To change the password, do the following steps:

1. If you have an active session, take control at the library manager by pressing Alt+T and the DCAF Target window will appear. See Figure 164.

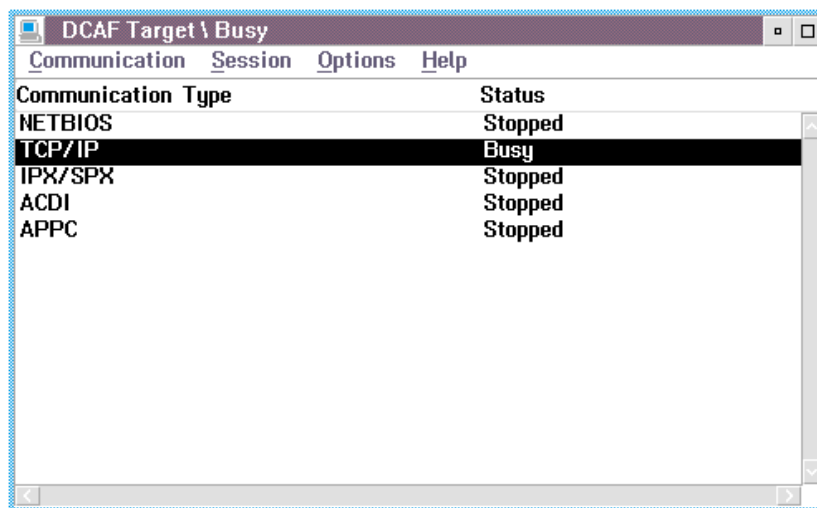

Figure 164. Changing Sessions

2. From the Options menu, select **Password** from the DCAF Target window (Figure 165 on page 256).

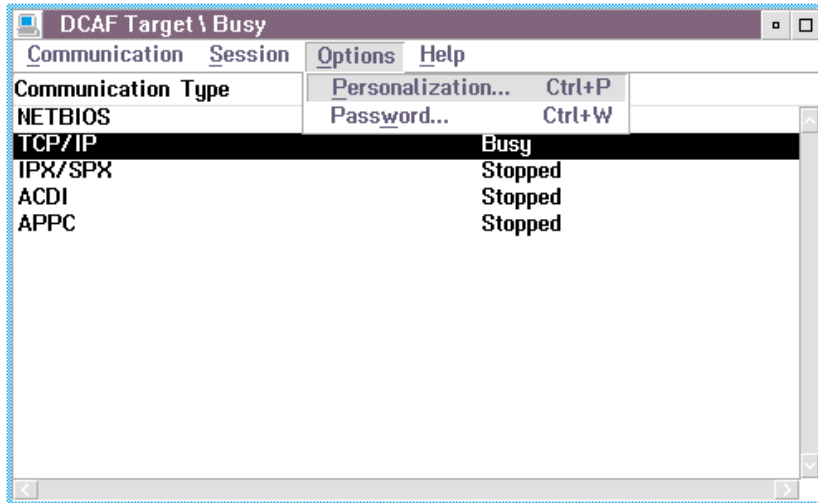

Figure 165. Session Pull-down Menu

3. Click on the **Enable password** check box ( Figure 166).
4. Type the current password. (The default password is *Impsword*.)

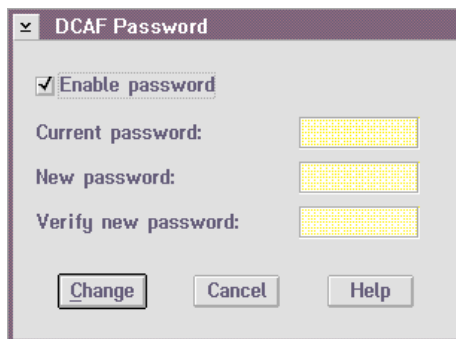

Figure 166. DCAF Password

5. Type the new password. The following are the password guidelines:
  - One to eight characters
  - Uppercase or lowercase letters A–Z
  - Digits 0–9
  - Embedded blanks (blanks after the last character are ignored)
6. Type the new password again after **Verify new password**.
7. Click on the **Change** push button. A message confirming the password change appears.

**Note:** Give the password to the remote library manager console operator.

---

## Remote Library Manager Console Problem Analysis and Operational Tips

Table 10 shows the fault symptoms and describes possible solutions to problems with the remote library manager console functions.

Table 10. Fault Symptoms

Symptom	Description and Possible Solution
The library manager keyboard is locked.	When a session is active, the library manager keyboard is locked. In this case, use the Alt+T hot-key combination to regain control at the library manager.
EQN0516 or EQN0524 error	Ensure that the communications manager is started. If the session state takes too long because of network traffic, you may receive this error on the remote library manager console. Close the warning window for this error and retry the connection.
The pointing device button commands to the library manager are ignored.	As you move a window with the pointing device from the remote library manager console, if you drag a window (of the library manager) so high that its top goes out of the visible region on the remote (controlling) console, you are moving the pointing device out of the DCAF session. Therefore, the pointing device button actions are not sent to the library manager until the pointing device is moved back into the active session window at the library manager. When you move back into the active session, the window on the library manager appears to move with the pointing device and not drop, even though the pointing device button has been released. Click the pointing device button again to drop the window where you want the window to drop.
The library manager console beeps.	If you perform an operation that is not allowed on the remote library manager console, the library manager console beeps once.





## Chapter 8. Problem Determination Procedures

This chapter describes how to determine when a problem has occurred in the library and the actions necessary to resolve the problem.

See Table 11 for quick reference to particular conditions.

### Quick Reference Table to Problem Determination Procedures

Table 11. Quick Reference to Problem Determination procedures

Conditions	Reference
Library Manager failures in a DFSMS/MVS environment (includes HA1 Switchovers)	"Library Manager Failure in a DFSMS/MVS Environment" on page 261
Library Manager failures in an MVS/BTLS environment (includes HA1 Switchovers)	"Library Manager Failure in an MVS/BTLS Environment" on page 265
Reported via a host console message	"DFSMS System Managed Tape Messages" on page 268
Intervention Required on Library Manager System Summary or SNMP OPINT trap message	"Intervention Required Conditions and Actions" on page 282
Disruption of services or physical damage to a site with a Virtual Tape Server.	"Virtual Tape Server Recovery Actions" on page 302
Import/Export List Volume status codes in the status file	"Appendix B. Virtual Tape Server Import/Export Advanced Function" on page 307

When a problem occurs in the library or associated tape subsystems, completion of one or more library operations may not be possible. This topic provides information on how to identify problems, what is their significance to continuing operations in the library, and what actions to take for recovery.

Several symptoms indicate that a problem occurred with the library and/or associated tape subsystems. These symptoms are in the following general categories:

1. One or more jobs that require volumes in the library are not progressing or completing as expected. The possible causes are:
  - The workload demand on the library exceeds its capability. For example, the number of requests to mount volumes on drives in a library received in a period exceeds the number the library can process during that period. The result is that the requests stay in the library manager queue for a longer period before being performed. Although this is not a problem with the library, if this is occurring on a regular basis, workload balancing must be addressed.
  - A failure of a component in the library is causing degraded performance. Library operations are performed, but are slower to complete because of the failure. For example, when one of the two grippers fails, all operations continue with the other gripper, but take longer to complete than when both grippers are functional. Service is required to correct the problem.
  - The library or attached tape subsystems detected a failure or exception condition that is preventing one or more library operations from completing. The library reports the condition to the host for operator or service

representative handling. See “Failure and Exception Condition Reporting” for the conditions and required actions.

2. Console messages concerning the library are being generated.
  - A failure or exception condition occurred while the library is performing one or more requested operations. The library reports the condition to the host which generates a host console message to inform the operator that a problem exists with the library. See “Failure and Exception Condition Reporting” for the conditions and required actions.
  - The library manager console provides information about many of the failure and exception conditions reported to the host. Although the host console messages are the primary source for problem determination, the information at the library manager is useful during operator and service representative problem resolution. See “Information Provided at the Library Manager Console” on page 276 for the information and required actions.
3. A service representative has requested time on the library to correct a problem. In addition to possible host console messages, failures and exception conditions caused by hardware failures in the library or associated tape subsystems are logged in the error recording dataset on the host. MVS hosts, for example, log errors in file SYS1.LOGREC. A service representative reviews the datasets as part of normal diagnosis. Also, when errors that are recovered internally by the library exceed a threshold, the condition is also logged for action by the service representative.

The primary indication that a problem has occurred is a host console message. The following topic describes what actions to take based on specific console messages.

---

## Failure and Exception Condition Reporting

Failures or exception conditions detected by the library are reported to the attached hosts for operator action. Most failures or exception conditions are also logged at the host for later use by a service representative. Failures or exception conditions fall into one of three categories:

1. A failure or exception condition is detected in a request from a host to perform a library function.

The requested function is rejected and the reason is reported back to the host immediately.
2. Some library function requests, such as mounting a cartridge, are queued within the library manager for subsequent execution. A failure or exception condition can be detected during the execution of a queued library function request.

The host that requested the library function is notified that a failure or exception condition was detected during the execution of the request. The notification also includes the reason for the failure or exception condition.
3. A failure or exception condition is detected that is independent of any specific requested library function.

All hosts attached to the library are notified of the failure or exception condition.

When a failure or exception condition is reported to the host, the result is dependent on the host's operating system. For an MVS host, the reported condition results in a console message. “DFSMS System Managed Tape Messages” on page 268 describes the console message generated by the MVS operating system under the DFSMS System Managed Tape environment as a result of a library

reported failure or exception condition. Refer to the following documentation for the messages provided and their format for other operating systems and environments.

- MVS Basic Tape Library Support (BTLS) - User's Guide and Reference SC26-7016
- VM
- OS/400
- AIX

For several of the conditions, one of the actions that can be specified is to choose the Operator Intervention pull-down. See "Operator Intervention" on page 199 for the actions to take for each intervention condition.

---

## Library Manager Failure Recovery Procedures

### Notes:

1. This procedure is designed for the recovery of DFSMS/MVS or MVS/BTLS host sessions. If you are using any other host platform, contact your software provider before continuing with this procedure.
2. These procedures apply to both single library manager and HA1 (dual library manager) configurations. In a dual library manager configuration, these procedures apply to the activation of the standby library manager when the active library manager fails.
3. Host actions may include varying the library online after a short delay for the conditions that restart the library manager. Host tape operations or short jobs may have to be resubmitted and operator actions from the Library Manager console may require restart.

When a failure occurs in the library manager from either a CHECK-1 or a processor exception, or when the library manager experiences certain hardware failures, perform the following procedures to recover host operations. These recovery procedures allow recovery from many different scenarios. These steps must be followed in the exact sequence to achieve a complete recovery.

Throughout the recovery procedures, the operator is directed to perform certain actions at either the library manager or at the host operating console. It may be helpful to have two people perform the various tasks involved in this procedure due to locations of the library.

For recovery procedures of DFSMS/MVS, see "Library Manager Failure in a DFSMS/MVS Environment". For recovery procedures of MVS/BTLS, see "Library Manager Failure in an MVS/BTLS Environment" on page 265.

## Library Manager Failure in a DFSMS/MVS Environment

The following failure conditions cause the operator to initiate this procedure:

- Library manager CHECK-1 condition
- Library manager hardware failure
- Library manager processor exception software error

When the active library manager fails in a dual library manager environment, it may or may not display a message. The standby library manager displays a message stating that a switch over is being made, which can take approximately 10 minutes to complete.

**Note:** Some library manager recovery operations may take longer than expected to complete. Allow sufficient time for the library manager to complete its switch over recovery procedures. Seek assistance **before** interrupting the library manager recovery operation.

## Library Manager Screens (DFSMS/MVS Environment)

A library manager failure causes the library manager console to display certain messages. If the failure has not affected the display and the display is powered on, the library manager may have one or more of the following symptoms.

### **Single Library Manager Configuration::**

- 'Severe execution error' dialog box
- System hang with non-responsive library manager keyboard or mouse

**Note:** If this occurs, press **Alt-t** to make sure the keyboard and display are not being controlled from the remote console.

- Mode changes which show **Pending** for an excessive length of time
- Error recovery in progress

### **Dual Library Manager Configuration::**

- 'Switching to active library manager' dialog box displayed
- 'Severe execution error' dialog box
- System hang with non-responsive library manager keyboard or mouse

**Note:** If this occurs, press **Alt-t** to make sure the keyboard and display are not being controlled from the remote console.

- Mode changes which show **Pending** for an excessive length of time
- Error recovery in progress

To manually restart a library manager, go to "Library Manager Action – Library Manager Recovery Begins (DFSMS/MVS Environment)" on page 263.

## Host Messages (DFSMS/MVS Environment)

When the library manager fails, the host operator may or may not see one or more of the following messages displayed on the host console:

- Library manager CHECK-1 condition
- Library manager equipment check
- Library path check
- Library manager offline
- Library manager switchover in progress

The library manager operator and the host operator should actively communicate with each other to reduce the amount of down time and ensure the accuracy of this procedure.

## Start the Library Manager and Host Recovery Procedure (DFSMS/MVS Environment)

Follow each step of the following procedure without deviation.

### Library Manager Action – Library Manager Recovery Begins (DFSMS/MVS Environment)

**Single Library Manager Configuration:** For a single library manager configuration, do the following:

- Contact host operations and inform them what has occurred at the library manager.
  - If a CHECK-1 or a processor exception occurred, the library manager automatically attempts to restart itself.

**Note:** If, after 30 minutes, there is no change on the System Status screen and messages, do a manual restart. **Do not power off the library manager.** Press the CTL+ALT+DEL key sequence to restart the library manager.

This procedure may need to be repeated. If, after the second attempt to recover the library manager, there is no response, call your next level of support.

- If the failure is anything other than a CHECK-1, restart the library manager manually by doing the following:
  - Perform the CTL+ALT+DEL key sequence to restart the library manager.
- While waiting for the library manager to initialize and enter the Auto/Online mode, go to “Library Manager Action – The Library Manager Recovers (DFSMS/MVS Environment)”.

**Note:** This action takes approximately 20 minutes.

**Dual Library Manager Configuration:** For a dual library manager configuration, no library manager corrective action is needed. The standby library manager automatically begins switching control from the active library manager.

If the active library manager is not responding and the standby library manager does not indicate it is switching to active after 5 minutes (see Figure 167 on page 264), perform the above steps for a single library manager on the one that failed.

While waiting for the library manager to initialize and go to AUTO/ONLINE mode, go to “Library Manager Action – The Library Manager Recovers (DFSMS/MVS Environment)”.

### Library Manager Action – The Library Manager Recovers (DFSMS/MVS Environment)

**Single Library Manager Configuration:** For a single library manager configuration, do the following:

1. Wait for the library manager to be reinitialized and enter Auto/Online mode. This process may take up to 20 minutes to reinitialize.
2. If the failure occurred while inserting cartridges into the high-capacity I/O facility, do not remove the cartridges. Leave the cartridges in place and the operation

will restart automatically. Cartridges inserted in the Convenience I/O station that remain in the station will need to be removed from the station and then re-inserted after the library manager re-initializes.

3. If the library manager reflects Auto/Online status, it has recovered. Contact the service representative for a recoverable library manager error. Continue with "DFSMS Host Action".

**or**

4. If the library manager does not display Auto/Online status **and** more than 30 minutes have elapsed since the re-initialization began, contact the service representative for a non-recoverable library manager error.
5. When the repair action is completed and the library is available to be varied online, continue with "DFSMS Host Action".

**Dual Library Manager Configuration:** For a dual library manager configuration do the following:

1. Wait until the switch over completes and the standby library manager has become the active library manager. The switch over takes approximately 10 minutes. See Figure 167.



Figure 167. Library Manager Switching Window

2. Contact the service representative to repair the failed library manager. The failed library manager may recover from the failure and become available as the standby library manager after the database is synchronized.
3. If the failure occurred while inserting cartridges into the high-capacity I/O facility, do not remove the cartridges. Leave the cartridges in place and the operation will restart automatically. Cartridges inserted in the Convenience I/O station that remain in the station will need to be removed from the station and then re-inserted after the library manager re-initializes.
4. Notify the host operator that the switch over is complete.
5. Continue with "DFSMS Host Action".

## DFSMS Host Action

If the library manager has been varied offline because of the failure, when the library manager is in the Auto/Online Mode, perform the following actions at the host:

1. Return DFSMS host control of the library to online status by issuing the following command:

**VARY SMS, LIB(libname<sup>1</sup>), ONLINE**

---

1. Where libname is the name of the library.

2. Confirm that the appropriate drives are online and available by issuing the following command:  
**LIBRARY DISPDRV, libname<sup>1</sup>**  
 For any drive that is not online, issue the following command:  
**VARY xxx, ONLINE**
3. If the system environment includes JES-3, the library tape drives must be in normal status. Use of the JES-3 VARY commands for the GLOBAL and all LOCAL processors may be appropriate.
4. If the system environment includes LEGENT Multiple Image Manager (MIM), the library tape drives must be in normal status. Use the MIM vary commands on each applicable host.
5. If the system environment includes a different product such as ADSM or EPIC, use the appropriate commands to ensure normal library and tape drive status.
6. Any pending jobs waiting for a response to an outstanding **WTOR (CBR4196D)** message may be retried by responding to the host request with an R (Retry).
7. If the CHECK-1 occurred while doing cartridge ejects, verify if the last 3 volsers placed in either the high-capacity I/O facility or the Convenience I/O station are still present in the DFSMS database. If the volsers are present in the DFSMS database, the volsers must be inserted through an input station, then the DFSMS command to eject the volsers needs to be reissued.

This completes the DFSMS recovery procedure. The library subsystem should now be ready for submission of tape jobs.

**Note:** Any tape job that abended will need to be resubmitted.

## Library Manager Failure in an MVS/BTLS Environment

The following failure conditions cause the operator to initiate this procedure:

- Library manager CHECK-1 condition
- Library manager hardware failure
- Library manager processor exception software error

When the active library manager fails in a dual library manager system, it may or may not display a message. The standby library manager displays a message stating that a switch over is being made, which can take up to 10 minutes to complete.

**Note:** Some library manager recovery operations may take longer than expected to complete. Allow sufficient time for the library manager to complete its switch over procedures. Seek assistance **before** interrupting the library manager recovery operation.

### Host Messages (MVS/BLTS Environment)

When the library manager fails, **BTLS ERA=70 Library Manager Equipment Check** may appear on the host console for single library managers or dual library managers unable to switch over. For dual library managers that are capable of switching, **BTLS ERA=74 Library Informational Data** may appear on the host console.

## Library Manager Screens (MVS/BLTS Environment)

A library manager failure causes the library manager console to display certain messages. If the failure has not affected the display and the display is powered on, the library manager may display one or more of the following screen messages:

### **Single Library Manager Configuration:**

- 'Severe execution error' dialog box
- System hang with non-responsive library manager keyboard or mouse

**Note:** If this occurs, press **Alt-t** to make sure the keyboard and display are not being controlled from the remote console.

- Mode changes which show **Pending** for an excessive length of time
- Error recovery in progress

### **Dual Library Manager Configuration:**

- Switching to active library manager dialog box displayed
- 'Severe execution error' dialog box
- System hang with non-responsive library manager keyboard or mouse

**Note:** If this occurs, press ALT+T to make sure the keyboard and display are not being controlled from the remote console.

To manually restart a library manager, go to "Library Manager Action – Library Manager Recovery Begins (MVS/BLTS Environment)".

## Start the Library Manager and Host Recovery Procedure (MVS/BLTS Environment)

Follow each step of the following procedure without deviation.

### **Library Manager Action – Library Manager Recovery Begins (MVS/BLTS Environment)**

**Single Library Manager Configuration:** For a single library manager configuration, do the following:

1. Contact host operations and inform them what has occurred at the library manager.
2. If a BTLT ERA=70 Library Manager Equipment Check occurred, the library manager automatically attempts to restart itself.

The library manager should begin initial program load (IPL) in about 5 minutes and may take up to 20 minutes to complete and become active. If, after 5 minutes, there is no change in the System Status messages, or an "Error recovery in progress" message is not displayed, do a manual restart. **Do not power off the library manager.** Press the CTL+ALT+DEL key sequence to restart the library manager.

This procedure may need to be repeated. If the library manager fails to begin IPL in 5 minutes, after the second attempt to recover call your next level of support.

3. If the failure did not cause the Library Manager to automatically restart, perform the CTL+ALT+DEL key sequence to restart the library manager.



While waiting up to 20 minutes for the library manager to initialize and enter the Auto/Online mode, go to "Library Manager Action – The Library Manager Recovers (MVS/BLTS Environment)".

**Dual Library Manager Configuration:** For a dual library manager configuration no library manager corrective action is needed. The standby library manager automatically begins switching control from the active library manager which will take approximately 10 minutes to complete. See Figure 168.

If the active library manager is not responding and the standby library manager does not indicate it is switching to active after 5 minutes (see Figure 167 on page 264), perform the above steps for a single library manager on the one that failed.



Figure 168. Library Manager Switching Window

While waiting for the library manager to initialize and go to AUTO/ONLINE mode, go to "Library Manager Action – The Library Manager Recovers (MVS/BLTS Environment)".

### Library Manager Action – The Library Manager Recovers (MVS/BLTS Environment)

**Single Library Manager Configuration:** For a single library manager, do the following:

1. Wait for the library manager to be reinitialized and enter Auto/Online mode. This may take up to 20 minutes to reinitialize.
2. If the failure occurred while inserting cartridges into the high-capacity I/O facility, do not remove the cartridges. Leave the cartridges in place and the operation will restart automatically. Cartridges inserted in the Convenience I/O station that remain in the station will need to be removed from the station and then re-inserted after the library manager re-initializes.
3. If the library manager reflects Auto/Online status, it has recovered. Contact the service representative for a recoverable library manager error. Continue with "BTLS Host Action" on page 268.
4. If the library manager does not reflect Auto/Online status **and** more than 30 minutes has elapsed since the re-initialization began, then contact the service representative for a non-recoverable library manager error.
5. When the repair action is completed and the library is available to be varied online, continue with "BTLS Host Action" on page 268.

**Dual Library Manager Configuration:** For a dual library manager, do the following:

1. Wait until the switch over completes and the standby library manager has become the active library manager. The switch over takes approximately 10

minutes. The standby library manager is the active library manager when its System Status displays Auto/Online mode.

2. Contact the service representative to repair the failed library manager.  
The failed library manager may recover from the failure and become available as the standby library manager after the database is synchronized.
3. If the failure occurred while inserting cartridges into the high-capacity I/O facility, do not remove the cartridges. Leave the cartridges in place and the operation will restart automatically. Cartridges inserted in the Convenience I/O station that remain in the station will need to be removed from the station and then re-inserted after the library manager re-initializes.
4. Continue with "BTLS Host Action".

## BTLS Host Action

When the library manager is in the Auto/Online Mode, do the following BTLS host actions:

1. Display the unit status by issuing the following command for each tape drive in the library:  
**D U,, xxx<sup>2</sup>**
2. Redrive the mount for each tape drive showing **MTP** (mount pending) by issuing either of the following commands:
  - From TSO terminals, issue the TSO library mount command.  
**LIBRARY MOUNT UNIT(unit)[VOLSER(volser)]**  
or
  - Submit JCL to perform a library mount. See *Basic Tape Library Support User's Guide and Reference* for commands.
3. Submit tape jobs.
4. Resubmit any tape jobs that abended.

This process completes the MVS/BTLS recovery procedure.

---

## DFSMS System Managed Tape Messages

When a failure or exception condition is reported to a host system operating under the DFSMS System Managed Tape environment, the following messages are generated. For each message, a brief description about the cause of the condition is described along with appropriate recovery actions.

Also refer to *MVS/ESA System Messages, Volume 2, GC28-1481* for additional CBRxxxx messages generated as a result of error or exception conditions detected with the DFSMS System Managed Tape environment software.

In the messages, *library-name* is the name defined by the installation for a particular library.

---

2. Where xxx is the device address.

## Table for DFSMS Library Failure Messages or Exception Conditions

Table 12. DFSMS Messages Based on Library Failure or Exception Conditions

Resulting Console Message	Action
<p><b>CBR3711I Unexpected ERA code</b> <i>ERA-code</i> <b>from library</b> <i>library-name</i>.</p> <p>An error has been detected during processing in tape library <i>library-name</i>. The library returned a unit check with error recovery action code <i>ERA-code</i>, which is an unexpected or inappropriate response to the library request.</p> <p>It is likely that the microcode in the library and the software are not at the correct level.</p>	Contact your service representative.
<p><b>CBR3712I Unexpected completion code, CC=cc, from library</b> <i>library-name</i>.</p> <p>An error has been detected during processing in tape library <i>library-name</i>. An unexpected or inappropriate completion code <i>cc</i> has been received from the library.</p> <p>It is likely that the microcode in the library and the software are not at the correct level.</p>	Contact your service representative.
<p><b>CBR3721I Library</b> <i>library-name</i> <b>in manual mode.</b></p> <p>Library <i>library-name</i> is in manual mode and cannot complete or accept library audit requests. Any pending audit requests queued within the library when it was placed in manual mode are failed resulting in this message. Any subsequent audit requests issued to the library will also fail and result in this message.</p>	When the library has returned to auto mode, resubmit the audit requests.
<p><b>CBR3722I Library</b> <i>library-name</i> <b>equipment check.</b></p> <p>A library hardware failure has been detected by the library or one of the associated tape subsystems. The failing library component must be repaired before library requests can be completed successfully.</p>	Contact your service representative.
<p><b>CBR3724I Volume</b> <i>volser</i> <b>does not exist in library</b> <i>library-name</i>.</p> <p>Volume <i>volser</i> does not reside in library <i>library-name</i>. It is possible that the volume has been ejected from the library by another host system.</p>	<ol style="list-style-type: none"> <li>1. Use the ISMF mountable tape volume list function to examine the current state of the volume under DFSMS.</li> <li>2. Determine where the volume is and re-enter it into the library's input station.</li> </ol>
<p><b>CBR3725I Library</b> <i>library-name</i> <b>command reject for volume</b> <i>volser</i>. <b>Library error code=</b><i>error-code</i>.</p> <p>A request for a library operation with volume <i>volser</i> has been rejected by library <i>library-name</i>. The error code indicates the reason for the rejection, but is included for diagnostic purposes only.</p> <p>It is likely that the microcode in the library and the software are not at the correct level.</p>	Contact your system administrator.

Table 12. DFSMS Messages Based on Library Failure or Exception Conditions (continued)

Resulting Console Message	Action
<p><b>CBR3726I Function incompatible error code <i>error-code</i> from library <i>library-name</i> for volume <i>volser</i>.</b></p> <p>A request for a library operation with volume <i>volser</i> cannot be processed by the library because the request is incompatible with the configuration or set of installed features of the library.</p> <p>If <i>error-code</i>=6, an attempt was made to eject a logical volume from a Virtual Tape Server.</p> <p>If <i>error code</i> = 7 or 8, a command for an Import or Export was issued to a VTS partition that is not capable of Export/Import.</p> <p>It is also possible that the microcode in the library and the software are not at the correct level.</p>	<p>Contact your system administrator.</p>
<p><b>CBR3727I Control Unit and Library Manager incompatible in library <i>library-name</i>, error code <i>error-code</i>.</b></p> <p>During processing of a library request in library <i>library-name</i>, it was determined that the tape control unit and the library manager are at incompatible software levels. Error code <i>error-code</i> indicates the nature of the incompatibility.</p>	<ol style="list-style-type: none"> <li>1. If another tape subsystem is in the library, vary the drives associated with the failed subsystem offline and resubmit the request or job.</li> <li>2. Contact your service representative.</li> </ol>
<p><b>CBR3728I Volume <i>volser</i> in use in library <i>library-name</i>. {Already mounted Mount pending Eject in progress Eject pending Export in progress}.</b></p> <p>A request for a library operation with volume <i>volser</i> cannot be processed by the library because the volume is already in use in the library. One of the following situations is present:</p> <ul style="list-style-type: none"> <li>• The volume is already mounted on another drive.</li> <li>• A mount request for the volume is pending.</li> <li>• The volume is currently being ejected from the library.</li> <li>• An eject request is pending.</li> <li>• The volume is being exported.</li> </ul>	<ol style="list-style-type: none"> <li>1. Determine why the volume is already in use.</li> <li>2. Resubmit the library request when the volume is no longer in use.</li> </ol>
<p><b>CBR3729I Library Manager for library <i>library-name</i> offline.</b></p> <p>A library request was issued to Library <i>library-name</i>, but the library manager is offline. Possible causes are:</p> <ul style="list-style-type: none"> <li>• The library manager is powered off.</li> <li>• The library manager is still in the process of initialization.</li> <li>• The library manager mode is set to offline.</li> </ul>	<ol style="list-style-type: none"> <li>1. Check that the library manager is powered on and operator menu is active.</li> <li>2. Check the <b>Library manager</b> field of the System Summary window. It should indicate <b>Online</b>.</li> <li>3. If it does not indicate <b>Online</b>, use the Mode pull-down and place the library in the Online state. If the library will not go to the online state, call your service representative.</li> <li>4. Vary the library online at the host console.</li> <li>5. Resubmit the request or job.</li> </ol>

Table 12. DFSMS Messages Based on Library Failure or Exception Conditions (continued)

Resulting Console Message	Action
<p><b>CBR3750I Message from library <i>library-name</i>: message.</b></p> <p>The operator at library <i>library-name</i> has sent message <i>message</i> to all connected hosts.</p> <p>Messages can be automatically sent from a VTS subsystem that is performing Export or Import Operations to post operation progress.</p> <p>If enabled at the library (see Figure 127 on page 200), text messages will also be surfaced for operator interventions that occur at the library. See Table 7 on page 216 for complete text associated with each numbered intervention message.</p>	<p>Handle Operator Intervention as required.</p>
<p><b>CBR3751E Device <i>device-number</i> in library <i>library-name</i> is unavailable.</b></p> <p>Device <i>device-number</i> in library <i>library-name</i> is no longer available. Either the state of the device has been changed through the library manager console, or the library detected a device failure.</p> <p>The device is varied offline to prevent it from being allocated.</p>	<ol style="list-style-type: none"> <li>1. If the device was made unavailable through the library manager console, make it available again through the library manager console.</li> <li>2. If the device was made unavailable due to a failure detected by the library, there will also be an intervention-required condition set for the device. Contact your service representative.</li> </ol>
<p><b>CBR3752I Device <i>device-number</i> in library <i>library-name</i> is now available.</b></p> <p>Device <i>device-number</i> in library <i>library-name</i>, which was previously unavailable, is now available. The device was made available through the library manager console.</p>	<p>Vary the device online from the host system console to make it available for allocation.</p>
<p><b>CBR3753E All convenience output stations in library <i>library-name</i> are full.</b></p> <p>All storage cells in the convenience output station in library <i>library-name</i> are occupied by ejected cartridges. No more cartridges can be ejected to a convenience output station until some of the already-ejected cartridges have been removed. The library will continue to accept and queue eject requests.</p> <p>This message is retained on the console until the convenience output station is no longer full.</p>	<p>Remove one or more cartridges from the convenience output station. There is also an intervention-required condition set for this condition. It is automatically cleared when the convenience output station is no longer full.</p>
<p><b>CBR3754E High capacity output station in library <i>library-name</i> is full.</b></p> <p>All storage cells in the high capacity output station in library <i>library-name</i> are occupied by ejected cartridges. No more cartridges can be ejected to the high capacity output station until some of the already-ejected cartridges have been removed. The library will continue to accept and queue eject requests.</p> <p>This message is retained on the console until the high capacity output station is no longer full.</p>	<p>Remove one or more cartridges from the high capacity output station. There is also an intervention-required condition set for this condition. It is automatically cleared when the high capacity output station is no longer full.</p>

Table 12. DFSMS Messages Based on Library Failure or Exception Conditions (continued)

Resulting Console Message	Action
<p><b>CBR3755E {Input Output} door open in library <i>library-name</i>.</b></p> <p>One of the following situations has been detected in library <i>library-name</i>:</p> <ul style="list-style-type: none"> <li>• The station door has been open for more than 5 minutes.</li> <li>• An eject operation cannot be completed because the door is open.</li> </ul> <p>This message is retained on the console until the open door has been closed.</p>	<p>Go to the library and close the station door. There is also an intervention-required condition set for this condition. It is automatically cleared when the station door is closed.</p>
<p><b>CBR3757E Library <i>library-name</i> in {paused/manual mode} operational state.</b></p> <p>Library <i>library-name</i> is not running in auto (normal) mode. The operational state (mode) is one of the following:</p> <p><b>Paused</b> All mechanical motion in the library has stopped. Paused mode is entered automatically when a failure in the library prevents further automated operation, or entered by a command from the library manager operator console. The library manager continues to accept orders from the host, but queues them for execution after pause mode changes to auto or manual mode.</p> <p><b>Manual mode</b> All mechanical motion within the library has stopped. Manual mode is entered by command from the library manager operator console. The library manager continues to accept orders from the host and instructs the operator to manually perform the functions that are normally done automatically, such as volume fetch and mounting.</p> <p>This message is retained on the console until the library has returned to the automated operational state.</p>	<ol style="list-style-type: none"> <li>1. The library may no longer be in auto mode because of an operational requirement such as high-capacity I/O or service.</li> <li>2. If no operation or service was planned for the library that would have caused the change in mode, go to the library and determine why it is no longer in auto mode.</li> <li>3. If there are intervention-required conditions at the library, perform them and then return the library to auto mode.</li> <li>4. If a repair action is required, contact your service representative.</li> </ol>
<p><b>CBR3758E Library <i>library-name</i> operation degraded.</b></p> <p>One or more components of library <i>library-name</i> have failed or otherwise become unavailable for use. The library is continuing to function, but performance may be degraded. If this message is accompanied by the <b>CBR3760E Library <i>library-name</i> vision system not operational</b> message, audit and eject requests cannot be performed and volumes cannot be added to the library.</p> <p>This message is retained on the console until all library facilities have become fully operational.</p>	<ol style="list-style-type: none"> <li>1. Contact your service representative.</li> <li>2. There also may be one or more intervention-required conditions at the library to perform.</li> </ol>

Table 12. DFSMS Messages Based on Library Failure or Exception Conditions (continued)

Resulting Console Message	Action
<p><b>CBR3759E Library <i>library-name</i> safety enclosure interlock open.</b></p> <p>One of the enclosure doors to the library <i>library-name</i> is open. The library is in pause mode.</p> <p>This message is retained on the console until the safety interlocks are closed.</p>	<ol style="list-style-type: none"> <li>1. If an operator is performing an operation that involves entering the enclosure, no action is necessary.</li> <li>2. If someone could be entering the enclosure without authorization, contact your site security. Intervention at the library is required to return the library to auto mode.</li> </ol>
<p><b>CBR3760E Library <i>library-name</i> vision system not operational.</b></p> <p>Key components of the vision system of library <i>library-name</i> have failed. The library cannot read the external labels on cartridges. Processing of audit or eject requests cannot be performed. Also, volumes cannot be added to the library because their external labels cannot be read. Other requests continue to be accepted and performed.</p> <p>This message is retained on the console until the vision system is operational again.</p>	<ol style="list-style-type: none"> <li>1. Contact your service representative to repair the library vision system.</li> <li>2. Resubmit audit or eject requests when the vision system is operational.</li> </ol>
<p><b>CBR3761E Library <i>library-name</i> library manager offline.</b></p> <p>Library <i>library-name</i> started the process of going offline as the result of an operator at the library manager requesting the library move to the offline state. All requests that have already been accepted by the library manager are completed normally. No other requests are accepted.</p>	<ol style="list-style-type: none"> <li>1. Determine why the library manager was placed in the offline state.</li> <li>2. If a repair action is required, contact your service representative.</li> </ol>
<p><b>CBR3762E Library <i>library-name</i> intervention required.</b></p> <p>One or more conditions in library <i>library-name</i> requires operator intervention to resolve. Library function requests continue to be accepted and executed, if possible. If this message is accompanied by <b>CBR3757E Library <i>library-name</i> in paused mode operational state</b>, the intervention condition caused automated operations to be stopped.</p> <p>This message is retained on the console until all intervention-required conditions have been cleared.</p>	<ol style="list-style-type: none"> <li>1. Go to the library and follow the instruction for the intervention-required condition specified on the library manager operator console. See “Intervention Required Conditions and Actions” on page 282 for the intervention-required conditions.</li> <li>2. After all conditions are resolved, return the library to auto mode, if required.</li> </ol>
<p><b>CBR3763E Library <i>library-name</i> library manager check 1 condition.</b></p> <p>The library manager detected a severe failure condition in library <i>library-name</i>. All requests that were accepted by the library manager are lost.</p>	<ol style="list-style-type: none"> <li>1. Go to the library and see if the library manager is trying to recover. If it is, the library manager console is displaying an initialization message. If it is not, it is displaying an execution or fatal error message.</li> <li>2. If the library manager recovers, resubmit all outstanding library requests or jobs.</li> <li>3. If it does not recover, contact your service representative.</li> </ol>

Table 12. DFSMS Messages Based on Library Failure or Exception Conditions (continued)

Resulting Console Message	Action
<p><b>CBR3764E Library <i>library-name</i> all storage cells full.</b></p> <p>All storage cells in library <i>library-name</i> are occupied by, or reserved for, cartridges that are already in the library. No more cartridges can be added to the library. Cartridges in the input station of the library cannot be added to the library.</p> <p>This message is retained on the console until the library has available storage cells.</p>	<p>Cartridges must be ejected before any can be added to the library. There is also an intervention-required condition set for this condition. It is automatically cleared when the library is no longer full.</p>
<p><b>CBR3765E No cleaner volumes available in library <i>library-name</i>.</b></p> <p>The library manager in library <i>library-name</i> must perform a clean operation on one of the drives in the library, but no compatible cleaner volumes are available in the library.</p> <p>This message is retained on the console until the library has at least one appropriate cleaner volume.</p>	<ol style="list-style-type: none"> <li>1. Choose <b>Operator intervention</b> from the Commands pull-down on the library manager console.</li> <li>2. Find the intervention-required condition that identifies which type of cleaner cartridge the library requires.</li> <li>3. Place one or more compatible cleaner volumes, with bar-code labels that match the cleaner masks into the convenience input station.</li> </ol>
<p><b>CBR3766E Dual write disabled in library <i>library-name</i>.</b></p> <p>The library manager in library <i>library-name</i> is not updating the secondary database for the library manager inventory. This can be the result of a hardware failure. Operations continue with the primary database.</p>	<p>Contact your service representative.</p>
<p><b>CBR3769I Misplaced volume <i>volser</i> found in library <i>library-name</i>.</b></p> <p>Library <i>library-name</i> found volume <i>volser</i>, which had previously been reported as misplaced. The library manager updated the inventory to reflect the new location of the volume.</p>	<p>Resubmit the library request or job that failed because the volume was misplaced.</p>
<p><b>CBR3770I Volume <i>volser</i> misplaced in library <i>library-name</i>.</b></p> <p>During the execution of a library operation with volume <i>volser</i> in library <i>library-name</i>, the volume cannot be found at the location recorded in the library manager inventory.</p>	<ol style="list-style-type: none"> <li>1. Go to the library and find the volume record in the database. (Choose <b>Search database for volumes</b> from the Database pull-down.)</li> <li>2. Place the library in pause mode.</li> <li>3. Enter the library and find the home cell the volume should have been in and search for it in the surrounding cells. If the database shows the volume in a device, check that device. If you find the volume, leave the library and place the volume in the convenience input station.</li> <li>4. Place the library in auto mode.</li> <li>5. Resubmit the library request or job after the input station is inventoried.</li> </ol>
<p><b>CBR3771I Duplicate volume <i>volser</i> ejected from library <i>library-name</i>.</b></p> <p>A volume was found in a library cell whose <i>volser</i> <i>volser</i> is a duplicate of one already in library <i>library-name</i>. The location recorded in the library manager inventory for this <i>volser</i> already contains a volume with the same <i>volser</i>; this volume was ejected from the library to a convenience output station.</p>	<ol style="list-style-type: none"> <li>1. Remove the ejected volume from the output station.</li> <li>2. Determine why the volume has a duplicate label.</li> <li>3. Clear the item from the Intervention Required pop-up window. See Table 19 on page 288 for details.</li> </ol>



Table 12. DFSMS Messages Based on Library Failure or Exception Conditions (continued)

Resulting Console Message	Action
<p><b>CBR3772I Duplicate volume <i>volser</i> left in input station in library <i>library-name</i>.</b></p> <p>An attempt was made to enter volume <i>volser</i> into library <i>library-name</i>. The <i>volser</i> is already recorded in the library manager inventory, and the location assigned in the inventory contains a volume with the <i>volser</i>. The entered volume remains in the input station.</p>	<ol style="list-style-type: none"> <li>1. Remove the volume from the input station.</li> <li>2. Determine why the volume has a duplicate label.</li> <li>3. Clear the item from the Intervention Required pop-up window. See Table 19 on page 288 for details.</li> </ol>
<p><b>CBR3773I Cartridge with unreadable or invalid external label left in input station in library <i>library-name</i>.</b></p> <p>An attempt was made to enter a cartridge into library <i>library-name</i>. The external label on the cartridge is missing, unreadable, or contains an invalid character. The cartridge remains in the input station.</p>	<ol style="list-style-type: none"> <li>1. Remove the cartridge from the input station and correct the problem with the external label, then re-enter the cartridge into the library.</li> <li>2. Clear the item from the Intervention Required pop-up window. See Table 19 on page 288 for details.</li> </ol>
<p><b>CBR3774I Unexpected volume <i>volser</i> ejected from library <i>library-name</i>.</b></p> <p>Volume <i>volser</i> is in an unexpected location in library <i>library-name</i>. Either no entry exists for the <i>volser</i> in the library manager inventory or the cartridge external label is missing or unreadable. The cartridge was ejected from the library to a convenience output station.</p>	<ol style="list-style-type: none"> <li>1. Remove the ejected cartridge from the output station.</li> <li>2. Determine if the label is missing or damaged and replace it if necessary.</li> <li>3. Determine which library the volume belongs in using interactive storage management facility (ISMF) tape volume list application and place the volume in the convenience input station of that library.</li> <li>4. Clear the item from the Intervention Required pop-up window. See Table 19 on page 288 for details.</li> </ol>
<p><b>CBR3776I Volume <i>volser</i> inaccessible in library <i>library-name</i>.</b></p> <p>During the execution of a library operation, library <i>library-name</i> has indicated that volume <i>volser</i> is inaccessible. The volume cannot be retrieved using normal library automated function; manual intervention is needed.</p>	<ol style="list-style-type: none"> <li>1. Go to the library and if an intervention-required indication is displayed, determine whether it is for the inaccessible volume by viewing the intervention conditions. If it is the inaccessible volume, follow the instructions for the inaccessible condition.</li> <li>2. If the intervention-required indication is not displayed or the inaccessible volume is not one of the conditions listed, find the volume record in the database. (Choose <b>Search database for volumes</b> from the Database pull-down.)</li> <li>3. Place the library in pause mode.</li> <li>4. Enter the library and find the home cell the volume should have been in and search for it in the surrounding cells. If the database shows the volume in a device, check that device. If the volume is stuck in the device, call a service representative to remove the volume. If the volume is found, and after leaving the library, place it in the convenience input station.</li> <li>5. Place the library in auto mode.</li> <li>6. Resubmit the library request or job after the input station is inventoried.</li> </ol>
<p><b>CBR3777I Volume <i>volser</i> now accessible in library <i>library-name</i>.</b></p> <p>Volume <i>volser</i>, which was previously reported as inaccessible, is retrieved and is now accessible for automated operations in library <i>library-name</i>.</p>	<p>Resubmit the library request or job that failed because the volume was inaccessible.</p>

Table 12. DFSMS Messages Based on Library Failure or Exception Conditions (continued)

Resulting Console Message	Action
<p><b>CBR3778I Cleaner volume ejected from library</b> <i>library-name</i>.</p> <p>A cleaner volume exceeded its maximum usage count and was ejected from library <i>library-name</i>.</p>	<ol style="list-style-type: none"> <li>1. Remove the cartridge from the convenience output station.</li> <li>2. Place a new cleaner cartridge of the same type, with a bar-code label that matches one of the cleaner masks, in the convenience input station.</li> </ol>
<p><b>CBR3779I Damaged volume volser ejected from library</b> <i>library-name</i>.</p> <p>Damaged volume <i>volser</i> has been ejected from library <i>library-name</i>. The cartridge has been physically damaged such that it cannot be loaded on a tape device; either the leader block is missing or the tape medium has become detached from the leader block.</p>	<ol style="list-style-type: none"> <li>1. Remove the cartridge from the output station and repair or replace it.</li> <li>2. Clear the item from the Intervention Required pop-up window. See Table 20 on page 292 for details.</li> </ol>
<p><b>CBR3781I No {MEDIA1 MEDIA2 MEDIA3} scratch volumes available in library</b> <i>library-name</i>.</p> <p>A library operation requires a scratch volume of the indicated media type and there are none available in the library.</p>	<p>Either add volumes of the appropriate media type to the library or perform a scratch cycle through your tape management system to convert volumes to scratch in the library.</p>
<p><b>CBR3782I Volume</b> <i>volser</i> <b>in library</b> <i>library-name</i> <b>external label missing or unreadable.</b></p> <p>The external cartridge label for volume <i>volser</i> in library <i>library-name</i> is missing or cannot be correctly read by the library vision system. The library cannot perform volume verification. Mount, demount, and eject requests are completed without verification.</p>	<ol style="list-style-type: none"> <li>1. Issue a library request to eject the volume from the library and apply a new cartridge external label, if it has not already been ejected.</li> <li>2. Place the cartridge in the convenience input station.</li> <li>3. Clear the item from the Intervention Required pop-up window. See "Operator Intervention" on page 199 for details.</li> </ol>
<p><b>CBR3783I Library</b> <i>library-name</i> <b>is switching between the primary and secondary library manager. The switchover may be the result of a library manager detected unrecoverable error or an operator request initiated through the library manager.</b></p> <p>In an HA1 library, this indicates that the standby library manager is in the process of switching to active.</p>	<p>Refer to "Library Manager Failure in a DFSMS/MVS Environment" on page 261 for recovery procedures. CBR3784I will indicate when the switchover has completed.</p>
<p><b>CBR3784I The Library manager switchover in library</b> <i>library-name</i> <b>has completed.</b></p> <p>In an HA1 library, this indicates that a failure on the active library manager has resulted in a switchover to the standby library manager. This message indicates that the switchover has been completed.</p>	<p>Any outstanding mount requests (CBR4196D) can be responded to and any new requests to the library can be submitted. Refer to "Start the Library Manager and Host Recovery Procedure (DFSMS/MVS Environment)" on page 263 to recover from inserts or ejects that may have been in progress at the time of the failure.</p>

## Information Provided at the Library Manager Console

The library manager console provides information about many of the failure and exception conditions reported to the host. It also provides overall status about the operation of the library. This section shows several windows you can use for problem determination. See "Using the Library Manager" on page 88 for details about the windows. The windows are described in the order to follow when you are determining the source of the problem.

**Operator Note:** The primary aids for problem determination should be the messages posted on the host console. Use the information at the library manager console only as additional information to aid in finding the fault.

## Using the System Summary Window

The System Summary window (see Figure 43 on page 98) provides an overall view of the status of the library. If the System Summary window is not displayed on the console, use the Status pull-down and choose **System summary**. Table 13 summarizes the key fields and what action to take.

### Table for System Summary Window Problem Determination

Table 13. Problem Determination with the System Summary Window

Field Name	Action
<p><b>Cannot Display System Summary</b></p> <p>If the System Summary window cannot be displayed, a failure has occurred in the library manager.</p>	Contact your service representative.
<p><b>Operational Mode</b></p> <p><b>Auto</b> should be indicated showing normal operation. <b>Pause</b> shows that the library has stopped performing automated operations.</p>	<ol style="list-style-type: none"> <li>1. Determine why the mode is not Auto.</li> <li>2. Check the <b>Enclosure doors</b>, <b>Overall system</b>, and <b>Intervention</b> fields.</li> <li>3. Ensure that the front doors are closed.</li> <li>4. Place the library in Auto mode.</li> </ol>
<p><b>Library Manager</b></p> <p><b>Online</b> should be indicated showing normal operation. <b>Offline</b> shows that the library manager is not communicating with any of the associated 3490E/3590 subsystems in the library.</p>	<ol style="list-style-type: none"> <li>1. Determine why the library manager is Offline.</li> <li>2. Place the library manager in the Online state.</li> </ol>
<p><b>Enclosure doors</b></p> <p><b>Closed</b> should be indicated showing normal operation. <b>Open</b> indicates that one or more doors are open and that automated operations are paused.</p>	<ol style="list-style-type: none"> <li>1. Ensure that the front doors are closed.</li> <li>2. Return the library to Auto mode.</li> <li>3. If the library cannot be set to Auto mode, contact your service representative.</li> </ol>
<p><b>Direct attached ports</b></p> <p>A hexadecimal number, 0–3 and 8–B, should be displayed for each installed and initialized port. If a dash is displayed, that port is not initialized.</p>	<ol style="list-style-type: none"> <li>1. Ensure that the host is powered on and operating.</li> <li>2. Ensure that the any device driver program on the host is initialized.</li> <li>3. Contact your service representative.</li> </ol>
<p><b>CU ports</b></p> <p>A hexadecimal number, 0–F (depending on the port configuration), should be displayed for each 3490E/3590 control unit port. If a dash is displayed, that port is not initialized. No communication between the library manager and the 3490E/3590 control unit occurs. If the port to a 3490E/3590 subsystem is not initialized, automated operations for the drives in that subsystem cannot be performed.</p>	<ol style="list-style-type: none"> <li>1. Ensure that all 3490E/3590 subsystems in the library are powered on. Perform the power-on procedure for the 3490E/3590 subsystems.</li> <li>2. Check the Error indicator on the 3490E/3590 control unit setup panel. If illuminated, that control unit has a serious fault; contact your service representative to repair the control unit.</li> <li>3. Contact your service representative.</li> </ol>

Table 13. Problem Determination with the System Summary Window (continued)

Field Name	Action
<p><b>LAN Attach Ports</b></p> <p>A decimal count of the number of LAN attached hosts that are currently initialized with the 3494. If no hosts are initialized with the 3494, this shows as a dash. For example, if there are three hosts initialized with the 3494, this number is <b>3</b>. If one host goes down, this number will change to <b>2</b> when the 3494 tries to communicate with that host.</p>	<p>The number in this field is not, by itself, an indication of failure. If there seems to be a problem communicating with a host, choose <b>Status</b> and then select <b>LAN Status</b> to view the status of all LAN attached hosts. Select the host in question from the list of hosts and note the last two columns of the screen. If the host is currently initialized, the column labeled <b>Init</b> contains a <b>1</b>.</p> <p>If a host was initialized and something happened to cause the host to appear to go down (to the 3494), the column labeled <b>Init</b> will be a <b>0</b>, since the 3494 is not currently initialized with that host, and the column labeled <b>Prev Init</b> will be a <b>1</b>, since that host was initialized at one time with the 3494. This field is only accurate since the last time the 3494 Library Manager was started.</p>
<p><b>Convenience I/O</b></p> <p><b>Empty</b> or <b>Volumes</b> present should be indicated. <b>Unknown</b> shows the system has not been taught or the Convenience Input/Output Station has been made unavailable.</p>	<p>Contact your service representative to teach the system or make the Convenience Input/Output Station available.</p>
<p><b>Convenience I/O Mode</b></p> <p><b>Insert</b> or <b>Import</b> should be indicated. <b>Unknown</b> implies that an error has occurred while attempting to determine the mode.</p>	<p>Contact your service representative to teach the system or make the Convenience Input/Output Station available.</p>
<p><b>High-Capacity Status</b></p> <p><b>Failed</b> shows the high-capacity operation has failed to complete.</p>	<p>Contact your service representative.</p>
<p><b>Inventory Update</b></p> <p><b>Failed</b> shows the inventory update operation has failed to complete.</p>	<p>Contact your service representative.</p>
<p><b>Overall System</b></p> <p><b>OK</b> should be indicated. <b>Degraded</b> shows that a component in the library has failed but the library continued to operate. <b>Failed</b> shows that a component has failed and operations cannot continue.</p>	<p>Contact your service representative if <b>Failed</b> is indicated. If <b>Degraded</b> persists, also contact your service representative.</p>
<p><b>Accessor</b></p> <p><b>OK</b> should be indicated. <b>Failed</b> shows that the accessor (or both accessors if Model HA1 is installed) has failed or has been made unavailable and operations cannot be completed. <b>Degraded</b> shows that one accessor in an HA1 system has failed or been made unavailable.</p>	<ol style="list-style-type: none"> <li>1. Attempt to return library to Auto Mode.</li> <li>2. If problem persists, contact your service representative.</li> </ol>
<p><b>Gripper</b></p> <p><b>OK</b> should be indicated. <b>Failed</b> shows that the gripper (or both grippers if Model HA1 is installed) has failed or has been made unavailable and operations cannot be completed. <b>Degraded</b> shows that at least one gripper in an HA1 system has failed or been made unavailable.</p>	<p>Contact your service representative.</p>

Table 13. Problem Determination with the System Summary Window (continued)

Field Name	Action
<p><b>Vision</b></p> <p><b>OK</b> should be indicated. <b>Failed</b> shows that the vision system (or both vision systems if Model HA1 is installed) has failed or has been made unavailable and operations cannot be completed. <b>Degraded</b> shows that one vision system in an HA1 system has failed or been made unavailable.</p>	<p>Contact your service representative.</p>
<p><b>Power</b></p> <p><b>OK</b> should be indicated. <b>Power is off</b> shows that power to the cartridge accessor (or both accessors in an HA1 system) was removed and must be restored before automated operations can resume. <b>Degraded</b> shows that the power to one of the accessors in an HA1 system was removed. <b>Unknown</b> shows that the library manager cannot determine the state of the power.</p>	<ol style="list-style-type: none"> <li>1. If <b>Unknown</b> is indicated, power off the 3494 and then power it on.</li> <li>2. Ensure that all of the safety interlocks are closed.</li> <li>3. Place the library back in Auto mode.</li> </ol>
<p><b>Port</b></p> <p><b>OK</b> should be indicated. <b>Not initialized</b> shows that communications with the accessor controller has not been established. Automated operations cannot be performed without communication between the library manager and the accessor controller. <b>Degraded</b> shows that communications with one of the accessors in an HA1 system has not been established.</p>	<ol style="list-style-type: none"> <li>1. Attempt to return library to Auto Mode.</li> <li>2. If the port field does not change to <b>OK</b>, contact your service representative.</li> </ol>
<p><b>Intervention</b></p> <p><b>None</b> should be indicated. <b>Required</b> shows that the operator must resolve one or more conditions. Depending on the condition, some or all automated operations may be suspended.</p>	<ol style="list-style-type: none"> <li>1. Choose <b>Operator intervention</b> from the Commands pull-down. See "Intervention Required Conditions and Actions" on page 282 for resolving these conditions.</li> <li>2. After all the conditions are resolved, return the library to the Auto mode, if required.</li> </ol>

## Using the Component Availability Status Window

The Component Availability Status window (see Figure 64 on page 116) provides the availability status of each component in the library. If a component is available, it can be used to perform library operations. If a component is unavailable, it cannot be used to perform library operations. To show the window, choose **Component availability status** from the Status pull-down.

The three major groupings of components in this window are the Convenience Input/Output Stations, the accessor and its associated components, and the 3490E/3590 subsystems. All components should indicate 1, which shows that the component is available. If any component indicates 0 (not available) or an asterisk (\*) (degraded), contact your service representative so that it can be repaired and made available.

## Using the Search Database for Volumes Window

Use the Search Database for Volumes window (see Figure 83 on page 140) to determine if the library contains volumes for which some action must be taken. To

show the window, choose **Search database for volumes** from the Database pull-down. You can also use this window to find volumes reported in a host console message.

For each volume in the library, flags in the database indicate status or an exception condition. Figure 169 shows a summary of the volume status.

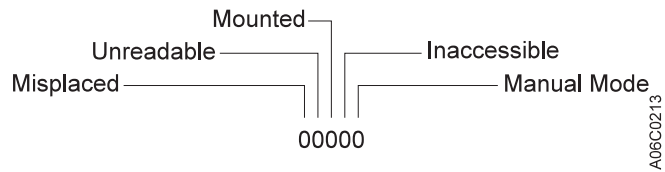

*Figure 169. Status Flags*

Table 14 on page 281 lists the problem scenarios for which the Search Database for Volumes window can be helpful in problem resolution.

## Table for Problem Determination using the Search Database for Volumes Window

Table 14. Problem Determination with the Search Database for Volumes Window

Problem Scenario	Action
<p><b>Specific Inaccessible Volume</b></p> <p>A host console message indicates that an operation failed because the volume is inaccessible.</p> <p>An Import/Export operation produced a Status File record with a Status Code 16 Stacked Volume Access Failure</p>	<ol style="list-style-type: none"> <li>1. Enter the volser in the field provided and then select the <b>Search</b> button.</li> <li>2. The database record for the volume is shown. The inaccessible flag should be set (the fourth position of the flags field set to 1).</li> <li>3. Place the library in Pause mode.</li> <li>4. Enter the library and find the volume using the cell positions indicated in the database record. Check both the cell and home positions. If the cell position indicated is a device, check that device.</li> <li>5. If the volume is stuck in a device, call your service representative.</li> <li>6. If you can remove the volume, place it in the Convenience Input/Output Station.</li> <li>7. Check the volumes on either side of the cell to ensure that they are fully seated in their cells. If a volume is not seated, the gripper cannot get the volume to the left of the unseated volume.</li> <li>8. Return the library to Auto mode.</li> <li>9. Resubmit the library request or job after the inventory update is complete.</li> </ol>
<p><b>Specific Misplaced Volume</b></p> <p>A host console message indicates that an operation failed because the volume is misplaced.</p> <p>An Import/Export operation produced a Status File record with a Status Code 16 Stacked Volume Access Failure</p>	<ol style="list-style-type: none"> <li>1. Enter the volser in the field provided and select the <b>Search</b> button. The database record for the cartridge is shown. The misplaced flag should be set (the first position of the flags field set to 1).</li> <li>2. If the Manual mode flag (fifth position of the flag field) is also set, check if the volume was taken out of the library.</li> <li>3. Place the library in Pause mode.</li> <li>4. Open the front doors on the library and find the location where the volume was last known to be (indicated in the database record for the cell and home location).</li> <li>5. Look for the volser in the surrounding cells. If the cell location indicated is a device, check that device.</li> <li>6. If the volume is stuck in a device, call your service representative.</li> <li>7. If you find the volume, place it in the Convenience Input/Output Station.</li> <li>8. Return the library to Auto mode.</li> <li>9. Resubmit the library request or job after the inventory update is complete.</li> </ol>

Table 14. Problem Determination with the Search Database for Volumes Window (continued)

Problem Scenario	Action
<p><b>Locating other Misplaced Volumes</b></p> <p>Search the database to check if the library contains any other misplaced volumes.</p>	<ol style="list-style-type: none"> <li>1. Leave the volser field blank, select the <b>Yes</b> button for the <b>Misplaced volser</b> flag, and then choose the <b>Search</b> button. The database records, if any, for the cartridges that are misplaced are shown.</li> <li>2. Perform the "Specific Misplaced Volume" procedure. See Table 14 on page 281.</li> </ol>
<p><b>Locating other Inaccessible Volumes</b></p> <p>Search the database to check if the library contains any other inaccessible volumes.</p>	<ol style="list-style-type: none"> <li>1. Leave the volser field blank, choose the <b>Yes</b> button for the <b>Inaccessible volser</b> flag, and then choose the <b>Search</b> button. The database records, if any, for the inaccessible cartridges are shown.</li> <li>2. Perform the "Specific Inaccessible Volume" procedure. See Table 14 on page 281.</li> </ol>
<p><b>Locating Misplaced Volumes in other Libraries</b></p> <p>If an operation on one library failed because the volume was misplaced, and you cannot find the volume in that library, check the inventories of the other libraries to see if it was put in another library by mistake.</p>	<ol style="list-style-type: none"> <li>1. At each library in the installation, enter the volser of the misplaced volume in the field provided and choose the <b>Search</b> button.</li> <li>2. If a database record is found for the volser, eject it from that library and place it in the Convenience Input/Output Station of the library with the original error.</li> </ol>

## Using the Whole Queue Window

When trying to determine why a particular library operation is not completing as expected, the Whole Queue window (see Figure 80 on page 137) can be used to determine what, if anything, needs to be done. This is particularly useful in the absence of any host console messages. Choose **Whole queue** from the Queues pull-down. Each library operation in the queue has status that is one of the following:

### Queued

The operation has not yet started. Other operations are in the queue that have a higher priority or were placed in the queue first. If you do not want to wait for the operation to progress through the queue, select *Promote a command in the queue* from the Commands pull-down and promote the operation.

### In-Progress

The operation is being performed. No operator action is needed.

### Blocked

The operation is waiting for another operation to complete before it can be started. When the blocking operation completes, the status of the operation changes to in-progress. No operator action is needed.

---

## Intervention Required Conditions and Actions

When the library manager determines that an error or exception condition has occurred within the library that requires operator assistance to correct, it performs the following actions:

1. Adds the condition detected to the list of outstanding operator intervention required conditions maintained by the library manager.



2. If not previously in the Intervention Required state, places the library in that state and notifies all attached hosts of the state change. The System Summary window is updated to indicate intervention is required.

The notification that the library is in the Intervention Required state will generate the following console message for libraries managed under DFSMS/MVS System Managed Tape environment: **CBR3762E, Library *library-name* intervention required**

The message will stay on the console as long as the library is in the intervention required state.

3. If "Send Interventions to Host Consoles" is enabled on the Operator Intervention screen (under the Commands Menu), a broadcast message of the operator intervention text will be sent to all attached hosts.

For Libraries managed under DFSMS/MVS system managed tape environment, this will result in the following message being displayed at the host console: **CBR3750I Message from Library *library-name*: *message***. Intervention text will be truncated at 70 characters. See Table 7 on page 216 for complete text string based on intervention number.

For other operating systems, consult the associated supporting software publications to determine operator notification methods.

To determine the cause of an intervention required condition and the steps required for its resolution, the operator selects the **Operator Intervention** item from the **Commands** pull-down menu on the library manager console. Each condition is listed separately and also indicates the date and time that the condition occurred.

The operator intervention conditions are described in the following set of tables. Similar conditions are grouped together in each table to make it easier to find a specific condition. The following table provides a summary of the grouped conditions:

## Quick Reference Table to Intervention Required Conditions

Table 15. Quick Reference to Intervention Required Conditions

Condition Type	Table Location
Conditions relating to tape devices in the library	Table 16 on page 284
Conditions relating to other library components	Table 17 on page 285
Conditions relating to input/output stations or facilities	Table 18 on page 286
Conditions relating to external cartridge labels	Table 19 on page 288
Conditions relating to data cartridges	Table 20 on page 292
Conditions relating to cleaner cartridges	Table 21 on page 293
Conditions relating to a Virtual Tape Server in the library	Table 22 on page 295

## Table for Intervention Conditions of Library Tape Drives

Table 16. Intervention Required Conditions relating to tape drives in the library

Intervention Required Condition	Resolution Actions
<p><b>Message</b></p> <p><b>Load / unload failure on device xxx. Empty the feed slot.</b></p> <p><b>Probable Cause</b></p> <p>Tape device xxx has failed to load or unload a tape cartridge. The automatic recovery process was not able to unload the cartridge from the device and put it away. The device and/or cartridge may be defective.</p>	<ol style="list-style-type: none"> <li>1. Place the library system in pause mode.</li> <li>2. Open the enclosure.</li> <li>3. If the cartridge is accessible, remove it.</li> <li>4. If the cartridge is in a CST/ECCST type device (model C1A or C2A), make the device not ready by pressing the <b>Ready</b> button, press the <b>Unload</b> button to unload the cartridge, remove the cartridge, then make the device ready by pressing the <b>Ready</b> button.</li> <li>5. If the cartridge is in a CST/ECCST type device (model F1A), press the <b>Load/Unload</b> button to unload the cartridge, then remove the cartridge.</li> <li>6. If the cartridge is in a HPCT/EHPCT type device, select <b>Unload</b> from the <b>Options Menu</b> and press <b>Enter</b> then remove the cartridge.</li> <li>7. If the cartridge is damaged, repair it (for example, re-attach the leader block). If it cannot be repaired, it should be re-inserted and an eject should be issued from the host.</li> <li>8. Place the cartridge in the convenience I/O station.</li> <li>9. Close the enclosure.</li> <li>10. Place the library system in auto mode.</li> <li>11. A service call may be needed if the error persists.</li> </ol>
<p><b>Message</b></p> <p><b>Device xxx is not ready.</b></p> <p><b>Probable Cause</b></p> <p>During a prior operator intervention or service action at a 3490 type tape device, device xxx was left in the not ready state.</p>	<ol style="list-style-type: none"> <li>1. Place the library system in pause mode.</li> <li>2. Open the enclosure.</li> <li>3. If the cartridge is in a CST/ECCST type device (model C1A or C2A), make the device not ready by pressing the <b>Ready</b> button, press the <b>Unload</b> button to unload the cartridge, remove the cartridge, then make the device ready by pressing the <b>Ready</b> button. If the drive does not become ready, call your service representative.</li> <li>4. If the cartridge is in a CST/ECCST type device (model F1A), Press the <b>Load/Unload</b> button to unload the cartridge, then remove the cartridge.</li> <li>5. If the cartridge is in a HPCT/EHPCT type device, select the <b>Unload</b> from the <b>Options Menu</b> and press <b>Enter</b>, then remove the cartridge If a check code appears on the message display, record the code and report it to your service representative.</li> <li>6. Place the cartridge in the error recovery cell. The error recovery cell is cell 1A1 (cell 1A3 if dual grippers are installed in the library).</li> <li>7. Close the enclosure.</li> <li>8. Place the library system in auto mode.</li> </ol>

Table 16. Intervention Required Conditions relating to tape drives in the library (continued)

Intervention Required Condition	Resolution Actions
<p><b>Message</b></p> <p><b>Device xxx has failed. A service call is needed.</b></p> <p><b>Probable Cause</b></p> <p>A load or unload failure was detected on tape device xxx and the automatic recovery process was not able to successfully complete the operation. The device is no longer available for use and requires service.</p>	<p>Although the intervention message can be cleared from the list of actions, the device failure will remain. Further attempts to use the device will re-display the intervention required message.</p>

## Table for Intervention Conditions of Other Library Components

Table 17. Intervention Required Conditions relating to other library components

Intervention Required Condition	Resolution Actions
<p><b>Message</b></p> <p><b>A cartridge could not be released from gripper x.</b></p> <p><b>Probable Cause</b></p> <p>The cartridge in gripper x remained in the gripper after an attempt was made to put it in a cell or device. This may be because of a damaged cartridge, alignment of the library or a failing gripper. The gripper remains available for use after the cartridge is removed.</p>	<ol style="list-style-type: none"> <li>1. Place the library system in pause mode.</li> <li>2. Open the appropriate enclosure door.</li> <li>3. Remove the cartridge from the indicated gripper.</li> <li>4. Place the cartridge in the error recovery cell. The error recovery cell is cell 1A1. (Cell 1A3 if dual grippers are installed in the library.)</li> <li>5. Close the enclosure door.</li> <li>6. Place the library system in auto mode.</li> </ol>
<p><b>Message</b></p> <p><b>Gripper failure on gripper x.</b></p> <p><b>Probable Cause</b></p> <p>Gripper x has repeatedly failed to release a cartridge. Service is required.</p>	<ol style="list-style-type: none"> <li>1. Place the library system in pause mode.</li> <li>2. Open the appropriate enclosure door.</li> <li>3. Remove the cartridge from the indicated gripper.</li> <li>4. Place the cartridge in the error recovery cell. The error recovery cell is cell 1A1. (Cell 1A3 if dual grippers are installed in the library.)</li> <li>5. Close the enclosure door.</li> <li>6. Place the library system in auto mode.</li> <li>7. Call your service representative.</li> </ol>
<p><b>Message</b></p> <p><b>The gripper configuration has changed. The library must be re-taught.</b></p> <p><b>Probable Cause</b></p> <p>The second gripper has either been installed or removed from the library, but the library has not been re-taught. Damage to the library can result if the library is not re-taught.</p>	<ol style="list-style-type: none"> <li>1. Call your service representative.</li> <li>2. The library system must be put in service mode and re-taught to show the current gripper configuration.</li> <li>3. This condition cannot be cleared by selecting it from the list of actions. Instead, this condition is cleared automatically by the library system when it is re-taught.</li> </ol>
<p><b>Message</b></p> <p><b>An emergency stop has occurred.</b></p> <p><b>Probable Cause</b></p> <p>If an enclosure door is opened while the library is in Auto mode, an emergency stop is performed.</p>	<ol style="list-style-type: none"> <li>1. Determine what caused the stop. The usual cause is an open enclosure door, check the System Summary window item <b>Enclosure Doors</b> to see if one or more doors are open.</li> <li>2. Close the enclosure door(s).</li> <li>3. Place the library system in Auto mode.</li> </ol>

Table 17. Intervention Required Conditions relating to other library components (continued)

Intervention Required Condition	Resolution Actions
<p><b>Message</b></p> <p><b>The library is full.</b></p> <p><b>Probable Cause</b></p> <p>An attempt was made to insert cartridges into the library and there are no available cells in the library other than the convenience I/O station or the high-capacity facility.</p>	<ol style="list-style-type: none"> <li>1. Cartridges must be ejected from the library before more cartridges can be inserted into the library system.</li> <li>2. This condition cannot be cleared by selecting it from the list of actions. Instead, this condition is cleared automatically by the library system when space becomes available in the library.</li> </ol>
<p><b>Message</b></p> <p><b>The system has failed. A service call is required.</b></p> <p><b>Probable Cause</b></p> <p>A major failure in of the systems in the library has occurred.</p>	<p>Call your service representative.</p>

## Table for Intervention Conditions of Input/Output Stations

Table 18. Intervention Required Conditions relating to Input/Output Stations or facilities

Intervention Required Condition	Resolution Actions
<p><b>Message</b></p> <p><b>The convenience I/O station is full.</b></p> <p><b>Probable Cause</b></p> <p>All of the cells of the convenience I/O station are full and at least one additional cartridge is queued to be ejected to the convenience I/O station.</p>	<ol style="list-style-type: none"> <li>1. Remove all cartridges from the convenience I/O station.</li> <li>2. This condition cannot be cleared by selecting it from the list of actions. Instead, this condition is cleared automatically by the library system when space becomes available in the convenience I/O station.</li> </ol>
<p><b>Message</b></p> <p><b>The high-capacity facility is full.</b></p> <p><b>Probable Cause</b></p> <p>All of the cells of the high-capacity facility are full and at least one additional cartridge is queued to be ejected to the high-capacity facility.</p>	<ol style="list-style-type: none"> <li>1. Place the library system in pause mode.</li> <li>2. Open the appropriate enclosure door.</li> <li>3. Remove all cartridges from the high-capacity facility.</li> <li>4. Close the enclosure door.</li> <li>5. Place the library system in auto mode.</li> <li>6. This condition cannot be cleared by selecting it from the list of actions. Instead, this condition is cleared automatically when empty cells are found during inventory update.</li> </ol>
<p><b>Message</b></p> <p><b>The convenience I/O station door is open.</b></p> <p><b>Probable Cause</b></p> <p>The convenience I/O station door has been left in the open position for greater than 5 minutes or there is an eject operation queued for the convenience I/O station and the door is open.</p>	<ol style="list-style-type: none"> <li>1. Close the convenience I/O station door.</li> <li>2. This condition cannot be cleared by selecting it from the list of actions. Instead, this condition is cleared automatically by the library system when the convenience I/O station door is closed.</li> </ol>

Table 18. Intervention Required Conditions relating to Input/Output Stations or facilities (continued)

Intervention Required Condition	Resolution Actions
<p><b>Message</b></p> <p><b>The convenience I/O station should be empty but is not, visually check the station.</b></p> <p><b>Probable Cause</b></p> <p>When the convenience I/O station insert operation completed, the cartridge present sensor indicated that cartridges were still present when none should have been. This can be caused by a cartridge without a label in the station or by debris obscuring the cartridge present sensor.</p>	<ol style="list-style-type: none"> <li>1. Remove any cartridges from the convenience I/O station and inspect their label.</li> <li>2. Remove any debris that may be obscuring the cartridge present sensor.</li> <li>3. Verify that the System Summary panel displays the convenience I/O station status as Empty.</li> </ol>
<p><b>Message</b></p> <p><b>Volser (xxxxxx) cannot be removed from the convenience I/O station.</b></p> <p><b>Probable Cause</b></p> <p>The cartridge accessor tried several times to remove cartridge xxxxxx from the convenience I/O station but failed. This could be due to a problem with the cartridge, the I/O station, the gripper or the alignment of the library.</p>	<ol style="list-style-type: none"> <li>1. Remove the cartridge from the convenience I/O station.</li> <li>2. Inspect the cartridge and cell for damage.</li> <li>3. Place the cartridge in the convenience I/O station.</li> </ol>
<p><b>Message</b></p> <p><b>Volser (xxxxxx) cannot be removed from the high-capacity facility cell: yyyy.</b></p> <p><b>Probable Cause</b></p> <p>The cartridge accessor tried several times to remove cartridge xxxxxx from the high capacity facility but failed. This could be due to a problem with the cartridge, the cell, the gripper or the alignment of the library. The cartridge is in high capacity facility cell yyyy.</p>	<ol style="list-style-type: none"> <li>1. Place the library system in pause mode.</li> <li>2. Open the appropriate enclosure door.</li> <li>3. Remove the cartridge from the high-capacity facility cell.</li> <li>4. Inspect the cartridge and cell for damage.</li> <li>5. Close the enclosure door.</li> <li>6. Place the library system in auto mode.</li> <li>7. Place the cartridge in the convenience I/O station.</li> </ol>
<p><b>Message</b></p> <p><b>The top two I/O station cells are inaccessible. Move cartridges to cell 3 or below.</b></p> <p><b>Probable Cause</b></p> <p>In a library that is configured with dual grippers, gripper 1 had failed and cartridges were placed in the top two cells of the I/O station. The top two cells of the convenience I/O station are no longer usable until gripper 1 is repaired.</p>	<ol style="list-style-type: none"> <li>1. Open the Convenience I/O station.</li> <li>2. Remove the cartridges from the top two cells of the I/O station.</li> <li>3. Replace the cartridges in the I/O station using cell 3 or below.</li> <li>4. Close the Convenience I/O station.</li> <li>5. This condition cannot be cleared by selecting it from the list of actions. Instead, this condition is cleared automatically by the library system when the cartridges are removed from the top two Convenience I/O station cells and the I/O station is closed.</li> </ol>

## Table for Intervention Conditions of External Cartridge Labels

Table 19. Intervention Required Conditions relating to external cartridge labels

Intervention Required Condition	Resolution Actions
<p><b>Message</b></p> <p><b>A duplicate volser (xxxxxx) was ejected to the convenience I/O station.</b></p> <p><b>Probable Cause</b></p> <p>During an inventory or inventory update operation, a cartridge was found whose external volume serial number, xxxxxx, is the same as that of another cartridge in the library. The volume was placed in the convenience I/O station. The library does not support more than one cartridge with the same volume serial number.</p>	<ol style="list-style-type: none"> <li>1. Remove the cartridge from the convenience I/O station.</li> <li>2. Determine why the cartridge is a duplicate and take corrective action.</li> </ol>
<p><b>Message</b></p> <p><b>A duplicate volser (xxxxxx) was ejected to high-capacity facility cell: yyyy.</b></p> <p><b>Probable Cause</b></p> <p>During an inventory or inventory update operation, a cartridge was found whose external volume serial number, xxxxxx, is the same as that of another cartridge in the library. The convenience I/O station is either not installed, is full or is unavailable. The volume was placed in high-capacity facility cell, yyyy. The library does not support more than one cartridge with the same volume serial number.</p>	<ol style="list-style-type: none"> <li>1. Place the library system in pause mode.</li> <li>2. Open the appropriate enclosure door.</li> <li>3. Remove the cartridge from the high-capacity facility.</li> <li>4. Determine why the cartridge is a duplicate and take corrective action.</li> <li>5. Close the enclosure door.</li> <li>6. Place the library system in auto mode.</li> </ol>
<p><b>Message</b></p> <p><b>A duplicate volser (xxxxxx) was left in the convenience I/O station.</b></p> <p><b>Probable Cause</b></p> <p>During an insert operation, a cartridge was found whose external volume serial number, xxxxxx, is the same as that of another cartridge in the library. The library does not support more than one cartridge with the same volume serial number.</p>	<ol style="list-style-type: none"> <li>1. Remove the cartridge from the convenience I/O station.</li> <li>2. Determine why the cartridge is a duplicate and take corrective action.</li> </ol>
<p><b>Message</b></p> <p><b>A duplicate volser (xxxxxx) was left in high-capacity facility cell: yyyy.</b></p> <p><b>Probable Cause</b></p> <p>During an insert operation, a cartridge was found in high-capacity facility cell, yyyy, whose external volume serial number, xxxxxx, is the same as that of another cartridge in the library. The library does not support more than one cartridge with the same volume serial number.</p>	<ol style="list-style-type: none"> <li>1. Place the library system in pause mode.</li> <li>2. Open the appropriate enclosure door.</li> <li>3. Remove the cartridge from the high-capacity facility.</li> <li>4. Determine why the cartridge is a duplicate and take corrective action.</li> <li>5. Close the enclosure door.</li> <li>6. Place the library system in auto mode.</li> </ol>

Table 19. Intervention Required Conditions relating to external cartridge labels (continued)

Intervention Required Condition	Resolution Actions
<p><b>Message</b></p> <p><b>An unreadable volser was left in the convenience I/O station.</b></p> <p><b>Probable Cause</b></p> <p>During an insert operation, the vision system was not able to read the external volume serial number label on the cartridge. The label may not have been installed incorrectly, is damaged or is not one of the supported label types.</p>	<ol style="list-style-type: none"> <li>1. Remove the cartridge from the convenience I/O station.</li> <li>2. Replace the unreadable label with a readable label.</li> <li>3. Place the cartridge in the convenience I/O station.</li> </ol>
<p><b>Message</b></p> <p><b>An unreadable volser was left in high-capacity facility cell: yyyy.</b></p> <p><b>Probable Cause</b></p> <p>During an insert operation for the high-capacity facility, the vision system was not able to read the external volume serial number label on the cartridge. The problem cartridge is left in cell, yyyy. The label may not have been installed incorrectly, is damaged or is not one of the supported label types.</p>	<ol style="list-style-type: none"> <li>1. Place the library system in pause mode.</li> <li>2. Open the appropriate enclosure door.</li> <li>3. Remove the cartridge from the high-capacity facility.</li> <li>4. Close the enclosure door.</li> <li>5. Place the library system in auto mode.</li> <li>6. Replace the unreadable label with a readable label.</li> <li>7. Place the cartridge in the convenience I/O station.</li> </ol>
<p><b>Message</b></p> <p><b>An invalid volser (xxxxxx) was left in the convenience I/O station.</b></p> <p><b>Probable Cause</b></p> <p>During an insert operation, the vision system read the external volume serial number label on the cartridge and it contained one or more invalid characters. The label must not contain leading or imbedded blanks or characters other than upper-case A through Z and the numbers 0 through 9.</p>	<ol style="list-style-type: none"> <li>1. Remove the cartridge from the convenience I/O station.</li> <li>2. Determine why the cartridge is invalid and take corrective action. Invalid volsers contain leading or imbedded blanks or invalid characters. Valid characters are A through Z and 0 through 9.</li> </ol>
<p><b>Message</b></p> <p><b>An invalid volser (xxxxxx) was left in high-capacity facility cell: yyyy.</b></p> <p><b>Probable Cause</b></p> <p>During an insert operation with the high-capacity facility, the vision system read the external volume serial number label on the cartridge and it contained one or more invalid characters. The label must not contain leading or imbedded blanks or characters other than upper-case A through Z and the numbers 0 through 9. The problem cartridge is left in cell, yyyy.</p>	<ol style="list-style-type: none"> <li>1. Place the library system in pause mode.</li> <li>2. Open the appropriate enclosure door.</li> <li>3. Remove the cartridge from the high-capacity facility.</li> <li>4. Close the enclosure door.</li> <li>5. Place the library system in auto mode.</li> <li>6. Determine why the cartridge is invalid and take corrective action. Invalid volsers contain leading or imbedded blanks or invalid characters. Valid characters are A through Z and 0 through 9.</li> </ol>

Table 19. Intervention Required Conditions relating to external cartridge labels (continued)

Intervention Required Condition	Resolution Actions
<p><b>Message</b></p> <p><b>An unexpected volser (xxxxxx) was found and ejected to the convenience I/O station.</b></p> <p><b>Probable Cause</b></p> <p>During a library operation other than inventory or inventory update, a cartridge was found whose external volume serial number xxxxxx indicates a volser that is not in the library manager's database. It is likely that the cartridge was added to the library when one of the doors was open and an inventory operation was not performed or inventory update has been disabled.</p>	<ol style="list-style-type: none"> <li>1. Remove the cartridge from the convenience I/O station.</li> <li>2. Determine where the cartridge belongs and take corrective action.</li> </ol>
<p><b>Message</b></p> <p><b>An unexpected volser (xxxxxx) was found and ejected to high-capacity facility cell: yyyy.</b></p> <p><b>Probable Cause</b></p> <p>During a library operation other than inventory or inventory update, a cartridge was found whose external volume serial number xxxxxx indicates a volser that is not in the library manager's database and the convenience I/O station is not installed, is full or is not available. It is likely that the cartridge was added to the library when one of the doors was open and an inventory operation was not performed or inventory update has been disabled. The problem cartridge was placed in rack cell, yyyy.</p>	<ol style="list-style-type: none"> <li>1. Place the library system in pause mode.</li> <li>2. Open the appropriate enclosure door.</li> <li>3. Remove the cartridge from the high-capacity facility.</li> <li>4. Close the enclosure door.</li> <li>5. Place the library system in auto mode.</li> <li>6. Determine where the cartridge belongs and take corrective action.</li> </ol>
<p><b>Message</b></p> <p><b>A cartridge or cartridge label located at cell yyyy is upside-down.</b></p> <p><b>Probable Cause</b></p> <p>During an inventory or inventory update operation, the vision system could not read the external volume serial number label because the cartridge or the label was upside-down in the cell. Most likely the cartridge was placed in the library upside-down. The cartridge is in cell yyyy.</p>	<ol style="list-style-type: none"> <li>1. Place the library system in pause mode.</li> <li>2. Open the appropriate enclosure door.</li> <li>3. Remove the cartridge from the cell.</li> <li>4. If the cartridge label is installed upside-down, remove the label and replace it (or a new label) the correct way up on the cartridge.</li> <li>5. Replace the cartridge in the same cell. Ensure that it is the correct way up. (It will not insert fully into the cell if it is upside-down).</li> <li>6. Close the enclosure door.</li> <li>7. Place the library system in auto mode.</li> </ol>
<p><b>Message</b></p> <p><b>A volser (xxxxxx) with an unknown media type has been ejected to the convenience I/O station.</b></p> <p><b>Probable Cause</b></p> <p>During an inventory or inventory update operation, the media type of a cartridge could not be determined by the vision system, the volser did not fit into an established media type range and a default media-type was not defined for the library.</p>	<ol style="list-style-type: none"> <li>1. Remove the cartridge from the convenience I/O station.</li> <li>2. If no seventh character is present; either add one, or modify the volser ranges to include this volser. See "Volser Range for Media Types" on page 161 on how to modify the volser ranges.</li> <li>3. Inspect the cartridge's seventh character. Install a readable seventh character representing the media type. See "Cartridge System Tape Labels" on page 20 for the procedure.</li> <li>4. Place the cartridge in the convenience I/O station.</li> </ol>



Table 19. Intervention Required Conditions relating to external cartridge labels (continued)

Intervention Required Condition	Resolution Actions
<p><b>Message</b></p> <p><b>A volser (xxxxxx) with an unknown media type has been ejected to high-capacity facility cell: yyyy.</b></p> <p><b>Probable Cause</b></p> <p>During an inventory or inventory update operation, the media type of a cartridge could not be determined by the vision system, the volser did not fit into an established media type range and a default media-type was not defined for the library. In addition, the convenience I/O station is either not installed, is full or is unavailable. The cartridge is in H.C.F. cell yyyy.</p>	<ol style="list-style-type: none"> <li>1. Place the library system in pause mode.</li> <li>2. Open the appropriate enclosure door.</li> <li>3. Remove the cartridge from the high-capacity facility.</li> <li>4. Close the enclosure door.</li> <li>5. Place the library system in auto mode.</li> <li>6. If no seventh character is present; either add one, or modify the volser ranges to include this volser. See "Volser Range for Media Types" on page 161 on how to modify the volser ranges.</li> <li>7. Inspect the cartridge's seventh character. Install a readable seventh character representing the media type. See "Cartridge System Tape Labels" on page 20 for the procedure.</li> <li>8. Place the cartridge in the convenience I/O station.</li> </ol>
<p><b>Message</b></p> <p><b>An invalid media volser (xxxxxx) has been ejected to the convenience I/O station.</b></p> <p><b>Probable Cause</b></p> <p>During an inventory or inventory update operation, the media type label of a cartridge has a media type character that is not supported by the library. Supported media type characters are 1, E, J and K.</p>	<ol style="list-style-type: none"> <li>1. Remove the cartridge from the convenience I/O station.</li> <li>2. Inspect the cartridge's seventh character. Install the correct seventh character representing the media type. See "Cartridge System Tape Labels" on page 20 for the procedure.</li> <li>3. Place the cartridge in the convenience I/O station.</li> </ol>
<p><b>Message</b></p> <p><b>An invalid media volser (xxxxxx) has been ejected to the high-capacity facility.</b></p> <p><b>Probable Cause</b></p> <p>During an inventory or inventory update operation, the media type label of a cartridge has a media type character that is not supported by the library. Supported media type characters are 1, E, J and K. In addition, the convenience I/O station is either not installed, is full or is unavailable.</p>	<ol style="list-style-type: none"> <li>1. Place the library system in pause mode.</li> <li>2. Open the appropriate enclosure door.</li> <li>3. Remove the cartridge from the high-capacity facility.</li> <li>4. Close the enclosure door.</li> <li>5. Place the library system in auto mode.</li> <li>6. Inspect the cartridge's seventh character. Install the correct seventh character representing the media type. See "Cartridge System Tape Labels" on page 20 for the procedure.</li> <li>7. Place the cartridge in the convenience I/O station.</li> </ol>

Table 19. Intervention Required Conditions relating to external cartridge labels (continued)

Intervention Required Condition	Resolution Actions
<p><b>Message</b></p> <p><b>A cartridge containing invalid media has been left in device xxx feed slot.</b></p> <p><b>Probable Cause</b></p> <p>During a mount operation, tape device xxx determined that the cartridge is not of a compatible media type but was not able to unload the cartridge. It is likely that the cartridge has a missing or damaged media type label or the media type label is incorrect for the cartridge's media type.</p>	<ol style="list-style-type: none"> <li>1. Place the library system in pause mode.</li> <li>2. Open the appropriate enclosure door.</li> <li>3. If the cartridge is accessible, remove it.</li> <li>4. If the cartridge is in a 3490 device, make the device not ready by pressing the <b>Ready</b> switch, press the <b>Unload</b> switch to unload the cartridge, remove the cartridge, then make the device ready by pressing the <b>Ready</b> switch.</li> <li>5. If the cartridge is in a 3590 device, select <b>Unload</b> from the Options Menu and press Enter. Remove the cartridge.</li> <li>6. If unable to remove cartridge, call your service representative.</li> <li>7. Close the enclosure door.</li> <li>8. Place the library system in auto mode.</li> <li>9. Inspect the cartridge's seventh character. Install the correct seventh character representing the media type. See "Cartridge System Tape Labels" on page 20 for the procedure.</li> <li>10. Place the cartridge in the convenience I/O station.</li> </ol>

## Table for Intervention Conditions of Data Cartridges

Table 20. Intervention Required Conditions relating to data cartridges

Intervention Required Condition	Resolution Actions
<p><b>Message</b></p> <p><b>Damaged volser (xxxxxx) ejected to the convenience I/O station.</b></p> <p><b>Probable Cause</b></p> <p>During a cartridge load operation on a tape device, the device determined that the cartridge does not have a leader block or that the tape media has a break in it. The library accessor was able to remove the cartridge from the device.</p>	<ol style="list-style-type: none"> <li>1. Remove the cartridge from the convenience I/O station.</li> <li>2. Inspect the cartridge for damage. If the leader block is detached from the tape, replace the leader block. See the tape drive Operator's Guide for the procedure.</li> <li>3. Place the cartridge in the convenience I/O station.</li> </ol>
<p><b>Message</b></p> <p><b>Damaged volser (xxxxxx) ejected to high-capacity facility cell: yyyy.</b></p> <p><b>Probable Cause</b></p> <p>During a cartridge load operation on a tape device, the device determined that the cartridge does not have a leader block or that the tape media has a break in it. The library accessor was able to remove the cartridge from the device. In addition, the convenience I/O station is either not installed, is full or is unavailable. The cartridge is in H.C.F. cell yyyy.</p>	<ol style="list-style-type: none"> <li>1. Place the library system in pause mode.</li> <li>2. Open the appropriate enclosure door.</li> <li>3. Remove the cartridge from the high-capacity facility.</li> <li>4. Close the enclosure door.</li> <li>5. Place the library system in auto mode.</li> <li>6. Inspect the cartridge for damage. If the leader block is detached from the tape, replace the leader block. See the tape drive Operator's Guide for the procedure.</li> <li>7. Place the cartridge in the convenience I/O station.</li> </ol>

Table 20. Intervention Required Conditions relating to data cartridges (continued)

Intervention Required Condition	Resolution Actions
<p><b>Message</b></p> <p><b>Volser (xxxxxx) could not be put away. It was ejected to the convenience I/O station.</b></p> <p><b>Probable Cause</b></p> <p>During a demount operation, the accessor was not able to place the cartridge into its home cell and there are no other available storage cells in the library. The cartridge may be damaged or something is blocking its home cell. If something is blocking its home cell it is likely to be a cartridge without an external volume serial number label.</p>	<ol style="list-style-type: none"> <li>1. Remove the cartridge from the convenience I/O station.</li> <li>2. Place the library system in pause mode.</li> <li>3. Open the appropriate enclosure door.</li> <li>4. Inspect the cartridge's home cell for damage or blockage.</li> <li>5. Close the enclosure door.</li> <li>6. Place the library system in auto mode.</li> <li>7. Inspect the cartridge for damage.</li> <li>8. Place the cartridge in the convenience I/O station.</li> </ol>
<p><b>Message</b></p> <p><b>Volser (xxxxxx) could not be put away. It was ejected to high-capacity facility cell: yyyy.</b></p> <p><b>Probable Cause</b></p> <p>During a demount operation, the accessor was not able to place the cartridge into its home cell and there are no other available storage cells in the library. In addition, the convenience I/O station is either not installed, is full or is unavailable. The cartridge may be damaged or something is blocking its home cell. If something is blocking its home cell it is likely to be a cartridge without an external volume serial number label. The cartridge is in H.C.F. cell yyyy.</p>	<ol style="list-style-type: none"> <li>1. Place the library system in pause mode.</li> <li>2. Open the appropriate enclosure door.</li> <li>3. Remove the cartridge from the high-capacity facility.</li> <li>4. Inspect the cartridge's home cell for damage or blockage.</li> <li>5. Close the enclosure door.</li> <li>6. Place the library system in auto mode.</li> <li>7. Inspect the cartridge for damage.</li> <li>8. Place the cartridge in the convenience I/O station.</li> </ol>
<p><b>Message</b></p> <p><b>Volser (xxxxxx) cannot be removed from cell: yyyy.</b></p> <p><b>Probable Cause</b></p> <p>The accessor was not able to remove the cartridge from its home cell. The cartridge or its home cell may be damaged or something is blocking its home cell. The library could also be out of alignment or the gripper is failing. The cartridge is in cell yyyy.</p>	<ol style="list-style-type: none"> <li>1. Place the library system in pause mode.</li> <li>2. Open the appropriate enclosure door.</li> <li>3. Remove the cartridge from the indicated cell.</li> <li>4. Inspect the cell for damage.</li> <li>5. Close the enclosure door.</li> <li>6. Place the library system in auto mode.</li> <li>7. Inspect the cartridge for damage.</li> <li>8. Place the cartridge in the convenience I/O station.</li> </ol>

## Table for Intervention Conditions of Cleaner Cartridges

Table 21. Intervention Required Conditions relating to cleaner cartridges

Intervention Required Condition	Resolution Actions
<p><b>Message</b></p> <p><b>The library is out of CST/ECCST cleaner cartridges.</b></p> <p><b>Probable Cause</b></p> <p>A clean operation for a 3490 type tape device needs to be performed, but there are no available compatible cleaner cartridges in the library. Either no cleaner cartridges have been added to the library, or they have all been used and have been ejected.</p>	<ol style="list-style-type: none"> <li>1. Place 3490 type cleaning cartridges in the convenience I/O station.</li> <li>2. This condition cannot be cleared by selecting it from the list of actions. Instead, this condition is cleared automatically by the library system when a cleaning cartridges, of the appropriate type, are inserted by the operator.</li> </ol>

Table 21. Intervention Required Conditions relating to cleaner cartridges (continued)

Intervention Required Condition	Resolution Actions
<p><b>Message</b></p> <p><b>The library is out of HPCT cleaner cartridges.</b></p> <p><b>Probable Cause</b></p> <p>A clean operation for a 3590 type tape device needs to be performed, but there are no available compatible cleaner cartridges in the library. Either no cleaner cartridges have been added to the library, or they have all been used and have been ejected.</p>	<ol style="list-style-type: none"> <li>1. Place 3590 type cleaning cartridges in the convenience I/O station.</li> <li>2. This condition cannot be cleared by selecting it from the list of actions. Instead, this condition is cleared automatically by the library system when a cleaning cartridges, of the appropriate type, are inserted by the operator.</li> </ol>
<p><b>Message</b></p> <p><b>A mislabeled cleaner cartridge has been ejected to the convenience I/O station.</b></p> <p><b>Probable Cause</b></p> <p>An attempt was made to a clean a tape device but the cartridge was determined to be a data cartridge, not a cleaner cartridge. Either the cartridge was mistakenly labeled with an external volsers that falls within the range of volsers designated for cleaner volumes in the library or the ranges set in the library conflict with ranges already in use for data cartridges.</p>	<ol style="list-style-type: none"> <li>1. Remove the cartridge from the convenience output station.</li> <li>2. Check if the volsers on the cartridge is included in the range(s) of volsers defined for cleaner cartridges using the Cleaner Masks item from the Commands pull-down on the library manager console.</li> <li>3. Correct either the cleaner masks or relabel the cartridge.</li> </ol>
<p><b>Message</b></p> <p><b>A mislabeled cleaner cartridge has been ejected to the high-capacity facility cell: yyyy.</b></p> <p><b>Probable Cause</b></p> <p>An attempt was made to a clean a tape device but the cartridge was determined to be a data cartridge, not a cleaner cartridge. The convenience I/O station was either not installed, is full or is unavailable. Either the cartridge was mistakenly labeled with an external volsers that falls within the range of volsers designated for cleaner volumes in the library or the ranges set in the library conflict with ranges already in use for data cartridges. The cartridge is in H.F.C. cell yyyy.</p>	<ol style="list-style-type: none"> <li>1. Place the library system in pause mode.</li> <li>2. Open the appropriate enclosure door.</li> <li>3. Remove the cartridge from the high-capacity facility.</li> <li>4. Close the enclosure door.</li> <li>5. Place the library system in auto mode.</li> <li>6. Check if the volsers on the cartridge is included in the range(s) of volsers defined for cleaner cartridges using the Cleaner Masks item from the Commands pull-down on the library manager console.</li> <li>7. Correct either the cleaner masks or relabel the cartridge.</li> </ol>

Table 21. Intervention Required Conditions relating to cleaner cartridges (continued)

Intervention Required Condition	Resolution Actions
<p><b>Message</b></p> <p><b>A mislabeled cleaner cartridge has been left in device xxx feed slot. Remove the cartridge.</b></p> <p><b>Probable Cause</b></p> <p>During a clean operation, tape device xxx determined that the cleaner cartridge is not compatible with the device but was not able to unload the cartridge. It is likely that the cartridge has a missing or damaged media type label or the media type label is incorrect for the cartridge media type.</p>	<ol style="list-style-type: none"> <li>1. Place the library system in pause mode.</li> <li>2. Open the appropriate enclosure door.</li> <li>3. If the cartridge is accessible, remove it.</li> <li>4. If the cartridge is in a 3490 device, make the device not ready by pressing the <b>Ready</b> switch, press the <b>Unload</b> switch to unload the cartridge, remove the cartridge, then make the device ready by pressing the <b>Ready</b> switch.</li> <li>5. If the cartridge is in a 3590 device, select <b>Unload</b> from the Options Menu and press Enter. Remove the cartridge.</li> <li>6. If unable to remove cartridge, call your service representative.</li> <li>7. Close the enclosure door.</li> <li>8. Place the library system in auto mode.</li> <li>9. Inspect the cartridge's seventh character. Install the correct seventh character representing the media type. See the tape drive Operator's Guide for the procedure.</li> <li>10. Place the cartridge in the convenience I/O station.</li> </ol>

## Table for Intervention Conditions of a Library Virtual Tape Server

Table 22. Intervention Required Conditions relating to a Virtual Tape Server in the Library

Intervention Required Condition	Resolution Actions
<p><b>Message</b></p> <p><b>Logical volume xxxxxx was not fully recovered from damaged stacked volume yyyyyy. (VTS z)</b></p> <p><b>Probable Cause</b></p> <p>During the attempted movement of logical volume xxxxxx from a damaged stacked volume which is in Read-only mode, a permanent read error was encountered. The error was not recoverable. The data associated with the logical volume was not recovered, and was not moved to another stacked volume.</p>	<ol style="list-style-type: none"> <li>1. Notify your system administrator.</li> </ol>

Table 22. Intervention Required Conditions relating to a Virtual Tape Server in the Library (continued)

Intervention Required Condition	Resolution Actions
<p><b>Message</b></p> <p><b>A damaged stacked volume xxxxxx has been ejected to the convenience I/O station. (VTS z)</b></p> <p><b>Probable Cause</b></p> <p>During a prior operation with the stacked volume, the Virtual Tape Server controller encountered an unrecoverable error indicating that the media of the volume may be damaged. During that operation, customer data was not fully recovered, resulting in job termination. The stacked volume was placed in read-only mode to limit use to recall of other logical volumes only.</p> <p>On an hourly basis, the Virtual Tape Server controller determines whether there are any stacked volumes in read-only mode and starts a process that moves the valid logical volumes to other stacked volumes and then ejects the damaged stacked volume from the library. See messages <i>Logical volume xxxxxx was not fully recovered from damaged stacked volume yyyyyy. (VTS z)</i> above for logical volumes not recovered and not moved to other stacked volumes.</p>	<ol style="list-style-type: none"> <li>1. Remove the cartridge from the convenience I/O station.</li> <li>2. Notify your system administrator.</li> <li>3. If the cartridge is still within a warranty period, and damaged logical volumes are no longer needed, return it to your supplier.</li> <li>4. If damaged logical volumes must be recovered, call your service representative.</li> </ol>
<p><b>Message</b></p> <p><b>A Virtual Tape Server is out of stacked volumes. (VTS z)</b></p> <p><b>Probable Cause</b></p> <p>There are two ways this condition is determined:</p> <ul style="list-style-type: none"> <li>• Once an hour the Virtual Tape Server checks if there are empty stacked volumes. During that check Virtual Tape Server z did not have any empty stacked volumes.</li> <li>• An operation that requires an empty stacked volume needs to be performed and Virtual Tape Server z does not have an empty stacked volume. The operations that need empty stacked volumes are copying data from the Tape Volume Cache or reclamation of unusable space on stacked volumes.</li> </ul>	<ol style="list-style-type: none"> <li>1. Insert one or more 3590 cartridges that have volume serial numbers within the range of stacked volumes defined for Virtual Tape Server z. <b>Note:</b> When the VTS is out of stacked volumes, logical mount requests will be queued, but not performed. Queued logical mounts are performed once a stacked volume has been inserted.</li> </ol>

Table 22. Intervention Required Conditions relating to a Virtual Tape Server in the Library (continued)

Intervention Required Condition	Resolution Actions
<p><b>Message</b></p> <p><b>A stacked volume has a label mismatch and has been ejected to the convenience I/O station. Internal: xxxxxx, External: yyyyyy</b></p> <p><b>Probable Cause</b></p> <p>During validation that the correct stacked volume was mounted, the volume serial number read from the media did not match what was expected. The volume is ejected to the convenience I/O station.</p> <p>This is likely caused by human intervention in the library that involved moving physical cartridges between storage cells and, when the library was returned to auto mode, inventory update was disabled. Without performing inventory update, the library has no way of updating its database to know where cartridges have been moved.</p>	<ol style="list-style-type: none"> <li>1. Remove the cartridge from the convenience I/O station.</li> <li>2. If human intervention in the library is the cause, perform an inventory update operation.</li> <li>3. If human intervention is not the cause, check the external label of the cartridge for damage and relabel if necessary.</li> <li>4. Place the cartridge in the convenience I/O station.</li> </ol>
<p><b>Message</b></p> <p><b>Orphaned logical volume xxxxxx found.</b></p> <p><b>Probable Cause</b></p> <p>During a check of the Virtual Tape Server database, a reference to logical volume xxxxxx was found, but there is no record of its physical location. This could be the result of a hardware or internal software problem. Any data associated with the logical volume is lost.</p>	<ol style="list-style-type: none"> <li>1. Notify your system administrator.</li> <li>2. If this intervention occurs multiple times, call your service representative.</li> </ol>
<p><b>Message</b></p> <p><b>The Tape Volume Cache is degraded (Error Code xxxx). (VTS z)</b></p> <p><b>Probable Cause</b></p> <p>A disk drive in one of the Tape Volume Cache storage capacity features of Virtual Tape Server z has failed. Operations with the Virtual Tape Server continue, but performance degradation may be experienced. Service is required.</p>	<ol style="list-style-type: none"> <li>1. Record the error code and contact your service representative.</li> </ol>
<p><b>Message</b></p> <p><b>A permanent, non-recoverable Tape Volume Cache error has occurred. (VTS z)</b></p> <p><b>Probable Cause</b></p> <p>During the initialization of the Virtual Tape Server z, unrecoverable errors were detected with the Tape Volume Cache. The Virtual Tape Server is unusable. Service is required.</p>	<ol style="list-style-type: none"> <li>1. Contact your service representative.</li> </ol>

Table 22. Intervention Required Conditions relating to a Virtual Tape Server in the Library (continued)

Intervention Required Condition	Resolution Actions
<p><b>Message</b></p> <p><b>Virtual Tape System z has a CHECK1 (xxxx) failure.</b></p> <p><b>Probable Cause</b></p> <p>An error was detected in Virtual Tape Server z that cannot be recovered. The error could be a result of hardware or internal software problems. The Virtual Tape Server Controller will automatically restart itself. Any host jobs using virtual volumes and devices are abended and any data that has not been written to the Tape Volume Cache is lost.</p>	<ol style="list-style-type: none"> <li>1. Record the error code and contact your service representative.</li> <li>2. The Virtual Tape Server will restart itself.</li> <li>3. Restart all active host jobs.</li> </ol>
<p><b>Message</b></p> <p><b>Free storage threshold has been crossed. (VTS z)</b></p> <p><b>Probable Cause</b></p> <p>The available free space in Virtual Tape Server z has fallen below the threshold set through the Set VTS Management Policies panel on the library manager.</p>	<ol style="list-style-type: none"> <li>1. Insert more 3590 cartridges into the library. Make sure their volume serial numbers are within the range of stacked volumes defined for Virtual Tape Server reporting the condition.</li> <li>2. The VTS Active Data panel for Virtual Tape Server will be updated to reflect any newly added stacked volumes on the hour.</li> </ol>
<p><b>Message</b></p> <p><b>During the disaster recovery process, a stacked volume xxxxxx and has been ejected. (VTS z)</b></p> <p><b>Probable Cause</b></p> <p>During the disaster recovery process, Virtual Tape Server z could not read the recovery information on stacked volume xxxxxx. Error recovery was unsuccessful. The media may have been damaged during the disaster. The cartridge is placed in the convenience I/O station.</p>	<ol style="list-style-type: none"> <li>1. Remove the cartridges from the I/O station.</li> <li>2. If possible, repair the cartridge and place in the convenience I/O station.</li> </ol>
<p><b>Message</b></p> <p><b>Database restore from stacked volume xxxxxx failed, attempting restore from next most recent. (VTS z)</b></p> <p><b>Probable Cause</b></p> <p>During the disaster recovery process, Virtual Tape Server z could not successfully recover the database from stacked volume xxxxxx. Error recovery was unsuccessful. The media may have been damaged during the disaster.</p>	<ol style="list-style-type: none"> <li>1. Notify your System Administrator.</li> </ol>
<p><b>Message</b></p> <p><b>Insert of logical volume xxxxxx failed during disaster recovery. (VTS z)</b></p> <p><b>Probable Cause</b></p> <p>During the disaster recovery process, logical volume xxxxxx could not be added to the library manager inventory. It may be because the volser is already in the inventory or the library is already at the logical volume limit or the volser conflicts with a physical volume's volser that is already in the library.</p>	<ol style="list-style-type: none"> <li>1. Notify your system administrator.</li> </ol>



Table 22. Intervention Required Conditions relating to a Virtual Tape Server in the Library (continued)

Intervention Required Condition	Resolution Actions
<p><b>Message</b></p> <p><b>Device xxx made unavailable by a VTS. (VTS z)</b></p> <p><b>Probable Cause</b></p> <p>During an operation with device xxx, the Virtual Tape Server Controller determined that the device is not operating correctly and requires service. It is likely that the device has excessive read or write errors.</p>	<p>1. Contact your service representative.</p>
<p><b>Message</b></p> <p><b>A VTS does not have enough available physical drives to continue operation. (VTS z)</b></p> <p><b>Probable Cause</b></p> <p>Physical drives associated with VTS z have become unavailable either due to a drive failure or service representative action. A VTS requires a minimum of two available physical drives for operation.</p>	<p>1. Contact your service representative.</p>
<p><b>Message</b></p> <p><b>A VTS attempted unsuccessfully to eject a stacked volume (xxxxxx) during disaster recovery. (VTS z)</b></p> <p><b>Probable Cause</b></p> <p>During processing of a physical volume during disaster recovery, the VTS subsystem determined that the physical volume was damaged and attempted to place the volume in the I/O station, but the attempt failed. The likely reason is that the cartridge has physical damage as a result of the disaster and it interferes with the cell in the I/O station.</p>	<p>1. Contact your service representative.</p>
<p><b>Message</b></p> <p><b>A VTS attempted unsuccessfully to eject a damaged stacked volume (xxxxxx). (VTS z)</b></p> <p><b>Probable Cause</b></p> <p>During the last usage of a physical volume, the VTS subsystem determined that the volume was physically damaged. As part of a recovery process, an attempt was made to eject the physical volume which failed. The likely reason is that the cartridge has physical damage as a result of the disaster and it interferes with the cell in the I/O station.</p>	<p>1. Contact your service representative.</p>

Table 22. Intervention Required Conditions relating to a Virtual Tape Server in the Library (continued)

Intervention Required Condition	Resolution Actions
<p><b>Message</b></p> <p><b>VTS Physical device xxx is cabled incorrectly. It has been made unavailable. (VTS z)</b></p> <p><b>Probable Cause</b></p> <p>During the installation of drive xxx, the interface cables between the drive and the library manager were incorrectly installed.</p>	<p>1. Contact your service representative.</p>
<p><b>Message</b></p> <p><b>A VTS cannot communicate with device xxx. It has been made unavailable. (VTS z)</b></p> <p><b>Probable Cause</b></p> <p>Drive xxx has either been powered-off or has a failure that does not allow it to respond to requests from the VTS.</p>	<p>1. Contact your service representative.</p>
<p><b>Message</b></p> <p><b>Mount of logical volume xxxxxx failed because physical volume yyyyyy is misplaced. (rc=rrrr) (VTS z)</b></p> <p><b>Probable Cause</b></p> <p>To satisfy a logical volume mount request, the logical volume must be recalled from a physical volume. The mount of the physical volume failed because it was not found in the physical storage cell indicated in the library manager inventory.</p>	<p>1. Refer to “Using the Search Database for Volumes Window” on page 279, and follow the instructions in the “Specific Misplaced Volume” scenario using the physical volume volser for your search.</p>
<p><b>Message</b></p> <p><b>Mount of logical volume xxxxxx failed because physical volume yyyyyy is inaccessible. (rc=rrrr) (VTS z)</b></p> <p><b>Probable Cause</b></p> <p>To satisfy a logical volume mount request, the logical volume must be recalled from a physical volume. The mount of the physical volume failed because it is not accessible by the robotics of the library. The two most likely reasons for the volume to be inaccessible are that the volume is loaded in a drive that has failed or is in a gripper that has failed.</p>	<p>1. Refer to “Using the Search Database for Volumes Window” on page 279, and follow the instructions in the “Specific Inaccessible Volume” scenario using the physical volume volser for your search.</p>

Table 22. Intervention Required Conditions relating to a Virtual Tape Server in the Library (continued)

Intervention Required Condition	Resolution Actions
<p><b>Message</b></p> <p><b>Mount of logical volume xxxxxx failed because physical volume yyyyyy is not in the library. (rc=rrrr) (VTS z)</b></p> <p><b>Probable Cause</b></p> <p>To satisfy a logical volume mount request, the logical volume must be recalled from a physical volume. At the time the logical volume mount request was processed, the physical volume required could not be found in the library manager inventory.</p>	<ol style="list-style-type: none"> <li>1. Contact your service representative.</li> <li>2. Locate the physical volume and insert it into the library.</li> </ol>
<p><b>Message</b></p> <p><b>Mount of logical volume xxxxxx located on physical volume yyyyyy failed. (rc=rrrr) (VTS z)</b></p> <p><b>Probable Cause</b></p> <p>To satisfy a logical volume mount request, the logical volume must be recalled from a physical volume. The mount of the physical volume could not be completed and the VTS subsystem could not determine the exact reason for the failure.</p>	<ol style="list-style-type: none"> <li>1. Contact your System Administrator</li> <li>2. For Dual Library Manager systems containing a VTS, this intervention may be the result of a Library Manager switchover. When a Library Manager switchover occurs, queued or in-progress logical mounts are not completed. This results in the VTS asking the Library Manager to post this intervention. If this is the case, clear the intervention and re-drive the mount from the host.</li> </ol>
<p><b>Message</b></p> <p><b>Stacked volume xxxxxx is in Read-Only status with a reason code of yyyyy. (VTS z)</b></p> <p><b>Probable Cause</b></p> <p>During a prior read or write operation with the volume (recall of a logical volume, copying of a virtual volume, or routine reclamation of a stacked volume), a permanent media error was detected by the VTS, or an excessive number of temporary media errors have occurred. The volume is placed in read-only status to prevent further writing of customer data. Customer data already on the volume remains accessible.</p>	<ol style="list-style-type: none"> <li>1. This Intervention Required notification will be given for the first volume to be placed in read-only status within a 24 hour period. Your service representative should only be contacted after your system administrator has been notified as described in messages <i>Logical volume xxxxxx was not fully recovered from damaged stacked volume yyyyyy. (VTS z)</i> and <i>A damaged stacked volume xxxxxx has been ejected to the convenience I/O station. (VTS z)</i>, and it is necessary to recover a damaged logical volume.</li> </ol>
<p><b>Message</b></p> <p><b>Stacked Volume xxxxxx is unavailable with a reason code of yyyyy. (VTS z)</b></p> <p><b>Probable Cause</b></p> <p>During the reclamation process, a stacked volume was made unavailable. The volume will subsequently be placed in read-only status.</p>	<ol style="list-style-type: none"> <li>1. This message should be considered informational since the subsequent processing of read-only status volumes may result in transparent recovery. Your service representative should be contacted only when recovery of a logical volume is necessary after having received the message <i>Logical volume xxxxxx was not fully recovered from damaged stacked volume yyyyyy. (VTZ z)</i>.</li> </ol>

Table 22. Intervention Required Conditions relating to a Virtual Tape Server in the Library (continued)

Intervention Required Condition	Resolution Actions
<p><b>Message</b></p> <p><b>VTS Controller degraded. Error code yyyyy. Call service. (VTS z)</b></p> <p><b>Probable Cause</b></p> <p>A VTS redundant component has failed. Operation of the VTS is continuing.</p>	<p>1. Contact your service representative.</p>
<p><b>Message</b></p> <p><b>VTS requested that device xxx be made unavailable but a mount/demount is in progress. (VTS z)</b></p> <p><b>Probable Cause</b></p> <p>The VTS determined that device xxx should be made unavailable; however, the Library Manager found that a mount or demount was in process and could not mark the device as unavailable.</p>	<p>1. Contact your service representative.</p>

## Virtual Tape Server Recovery Actions

In the event a Virtual Tape Server is not usable either due to interruption of utility or communication services to the site or through significant physical damage to the site and/or the Virtual Tape Server itself, access to the data managed by the Virtual Tape Server is restored through automated processes designed into the product. The recovery process assumes that the only available elements for recovery are the stacked volumes themselves and further assumes that only a subset of them are undamaged after the event.

Although the recovery process is initiated by a service representative, there are some customer related actions that are necessary before the recovery can begin. The customer related actions are:

- If the 3494 and Virtual Tape Server are still functional, ask the service representative to perform a Force Migrate operation through the library manager service panel. This will ensure that all data has been moved from the Tape Volume Cache to a stacked volume.
- Remove the undamaged 3590 stacked volumes from the 3494 Tape Library that is no longer usable.
- Take the volumes to another 3494 location which has an empty Virtual Tape Server.
- Inform the service representative that the recovery process can begin.

There are two key functions designed into the Virtual Tape Server system to support recovery.

- Automatic Virtual Tape Server database backup  
The Virtual Tape Server controller maintains a database of information about the location and status of logical volumes on the stacked volumes it manages. When a stacked volume has been filled with logical volumes, a backup of the entire database is placed at the end of the filled stacked volume. The database contains a time and date stamp that identifies when the backup was performed.
- Automatic database recovery

When a restore of the database is required, the library manager, in conjunction with the Virtual Tape Server controller performs the following steps when initiated by a service representative:

1. Each available stacked volume in the library is mounted and the time and date stamp of the database backup is read. This step finds the most current database for the stacked volumes in the library.
2. The stacked volume with the most current database is again mounted and the database in the Virtual Tape Server controller is restored.
3. The Virtual Tape Server then provides information to the library manager to rebuild its inventory records for each logical volume found in the database.

Once the recovery process has completed, the operator varies the library online at the recovery site host and the library manager inventory of logical volumes is uploaded to the host to synchronize the host catalogs (DFSMS and applicable tape management systems).

At the completion of the recovery process, the Virtual Tape Server and the 3494 library manager will contain database and inventory records and status information for the logical volumes as found in the most recent database backup on the undamaged stacked volumes. Depending on the following conditions, some customer data and logical volumes may not have been recovered:

- The stacked volumes containing the latest database backups were destroyed.  
Any changes to the location or status of logical volumes since the last found database backup are lost. Some logical volume records may be lost. It is possible, however, that the database will contain the location of the previous use of logical volumes and that data is accessible to the host.
- One or more stacked volumes found in the restored database were destroyed during the event.  
Although the Virtual Tape Server database and the library manager inventory will have a record of the logical volumes that resided on the missing stacked volumes, the data is lost.
- A virtual volume had not been closed at the time of the event.  
The Virtual Tape Server database will not have a record of the virtual volume's location on a stacked volume and the data is lost.
- Logical volumes were written to a stacked volume between the time the last database backup was made and the event.  
The Virtual Tape Server database will not have a record of the new logical volume locations on the stacked volume and the data is lost. It is possible, however, that the database will contain the location of the previous use of the logical volume and that data is accessible to the host.



---

## Appendix A. Keyboard Template

The keyboard template on page 305 shows the function keys commonly used on the library manager during normal application activity.

The next template can be copied or removed and then folded to create a triangular bar shape with the illustration of the keys showing on one face. The template can then be placed in a convenient location for quick access to the correct key for a specific function.

<b>Commonly used keys:</b>											
<b>Arrows</b>	<b>Home</b>	<b>End</b>	<b>Esc</b>	<b>PgUp</b>	<b>PgDn</b>	<b>Ctrl + PgUp</b>	<b>Ctrl + PgDn</b>	<b>Underlined letter</b>	<b>Shift + Esc</b> or <b>Alt + Space</b>		
Move among the choices.	Go to the first choice in a pull-down menu.	Go to the last choice in a pull-down menu.	Cancel the last help window.	Scroll up one window.	Scroll down one window.	Display the text to the left of the window.	Display the text to the right of the window.	Select that choice on the action bar or pull-down menu.	Go to and from the pull-down menu.		
<b>Function keys:</b>											
<b>F1</b>	<b>F2</b>	<b>F3</b>	<b>Alt + F4</b>	<b>Alt + F5</b>	<b>F6</b>	<b>Alt + F7</b>	<b>Alt + F8</b>	<b>F9</b>	<b>Ctrl + F10</b>	<b>F11</b>	<b>F12</b>
Get the help window.	Get extended help from within any help window.	Perform shutdown.	Close the help window.	Restore the window.		Move the window.	Size the window.	List keys from within any help window.	Activate main menu action bar. <b>Shift + F10</b> Get help for help.	Go to help index from within any help window.	

A06C0009



---

## Appendix B. Virtual Tape Server Import/Export Advanced Function

---

### Import and Export List Volumes Format

Lists of volumes for Export or Import are provided to a Virtual Tape Server on logical volumes called the Export List Volume or the Import List Volume, which are resident in the VTS. The following figures define the requirements of the format for the Export List Volume and Import List Volume. There are fields, records or files of the two formats which are similar; therefore, only one figure for these similar areas is shown. For example, the Import List Volume figures refer to a HDR1 figure which is in the Export List Volume section.

Sample JCL for preparing the Export List Volume and Import List Volume is available in the *Object Access Method Planning, Installation, and Storage Administration Guide for Tape Libraries*, SC26-3051, and also in the Redbook *Enhanced IBM Magstar Virtual Tape Server: Implementation Guide*, SG24-2229.

The Export List Volume is an IBM Standard Labeled tape volume which is selected from the logical volumes in the VTS. Three files are written to the volume. The first file contains logical volume - destination pair records and is called the Export List file. The second file has a minimum of one record and is reserved for future use. The third file is the Export Status file and is initially written by the host without any data records. Upon the completion of the Export operation, the VTS will write status file records for each of the logical volumes listed in the Export List file indicating the processing results.

The Import List Volume is an IBM Standard Labeled tape volume which is selected from the logical volumes in the VTS. Two files are written to the volume. The first file contains records specifying the Exported Stacked Volumes and logical volume to Import or to Import all logical volumes. The second file is the Import Status file and is initially written by the host without any data records. Upon the completion of the Import operation, the VTS will write status file records indicating the results for each of the logical volumes listed specifically and the logical volumes contained on an Exported Stacked Volume listed when all logical volumes were to be imported.

---

### Export List Volume

Due to the size of a monolithic, detailed format description for the export list volume, the format is described in hierarchical form in the tables below. Start with Table 23 on page 308, then proceed as directed to the portion(s) of interest.

All character fields within the volume are in EBCDIC. Field contents specified in quotes are EBCDIC characters. The volume must be written with compaction turned off.

No space is reserved in the records of the list and status files. Expansion for later versions can be accomplished by redefining the file identifier records and data records for the files. Such changes would be reflected in the Record Length entry in the HDR2 and EOF2 records.

Table 23. Export List Volume

Volume Contents	Description
Volume Label	See Table 24
Export List File	See Table 25
Reserved File	See Table 28 on page 310
Export Status File	See Table 29 on page 310
Tape Mark	

Table 24. VOL1

Bytes	Description	Use
0–2	Label Identifier	Contains "VOL"
3	Label Number	Contains "1"
4–9	Volume Serial Number	The six character logical volume serial number of the Export List Volume or Import List Volume.
10	Reserved	Retained, Not checked
11–20	VTOC Pointer	Retained, Not checked
21–34	Reserved	Retained, Not checked
35–36	Tape Recording Technique	Retained, Not checked
37–40	Reserved	Retained, Not checked
41–50	Owner Name and Address Code	Retained, Not checked
51–79	Reserved	Retained, Not checked

Table 25. Export List File

Length	Name	Description
80	Data Set Header 1	Table 32 on page 312
80	Data Set Header 2	Table 33 on page 312
	Tape Mark	
80	Export List File Identifier	Table 26 on page 309
N*80	Export List File Records	Table 27 on page 309
	Tape Mark	
80	End of File 1	Table 34 on page 313
80	End of File 2	Table 35 on page 313
	Tape Mark	

Table 26. Export List File Identifier

Bytes	Name	Description
0–10	Title Text	“EXPORT LIST”
11	Delimiter	Blank character
12–13	Version	“01”
14	Blank	Blank character
15–30	User Field	This 16 byte field is not checked or used by the control unit
31–79	Retained, Not checked	This field is not checked or used by the control unit

The format of the Export List File record is designed to allow for ease of use. It is expected that a customer may manually input the needed information and the format needs to be tolerant of the location of the fields in the record. Each list file record contains up to two fields separated by a delimiter. The fields, “volser” and “destination” must appear in that order, separated by a field delimiter. If the record is not equal to 80 bytes, the record is not processed and a Status File record is written with a status code of X'24'. The first 13 bytes or less of data from the record as read is provided in the Status File record. If only one field is found in the record, it is assumed that a blank destination is desired.

Table 27. Export List File Record

Name	Description
Volser	The volume serial number of a logical volume to be exported. The VTS will use six characters to identify the volser, starting with the first non-blank character and continuing until six non-blank characters have been found. Valid characters are A-Z, 0-9. The search for six non-blank characters continues until a blank or delimiter comma character is found. Note: If the volser found is not six characters, or contains non-valid characters, a Status File record is written with a Status Code of X'1E' and with the first 13 bytes of the list record.
Field Delimiter	Comma character required if a non-blank destination is specified.
Destination	The destination for the logical volume. The control unit will use up to sixteen characters, starting with the first non-blank character after the field delimiter and continuing through byte 71, for the destination name. Embedded blanks are allowed in the destination name. Any characters in the record after the destination field are ignored. No validity checking is performed on the name found. A blank destination is also valid; however, all characters after the Volser or delimiter comma and throughout byte 71 must be blank.
User Field	Bytes 72-79 of the 80 byte record are not used or checked by the VTS. This field may contain line numbers for volume lists.

Table 28. Reserved File

Length	Name	Description
80	Data Set Header 1	Table 32 on page 312
80	Data Set Header 2	Table 33 on page 312
	Tape Mark	
recl	Reserved File Identifier	recl>=1. This record must be present; however, neither its length nor contents are checked or used by the control unit. Note: The minimum record length written to tape is 18 bytes.
N*recl	Reserved File Records	N is a variable number of file records. N=0 is valid, recl>=1, records not checked or used by the control unit. Note: The minimum record length written to tape is 18 bytes.
	Tape Mark	
80	End of File 1	Table 34 on page 313
80	End of File 2	Table 35 on page 313
	Tape Mark	

Table 29. Export Status File

Length	Name	Description
80	Data Set Header 1	Table 32 on page 312
80	Data Set Header 2	Table 33 on page 312
	Tape Mark	
80	Export Status File Identifier	Table 30
N*80	Export Status File Records	N=0 is valid. N is a variable number of file records. See Table 31 on page 311.
	Tape Mark	
80	End of File 1	Table 34 on page 313
80	End of File 2	Table 35 on page 313
	Tape Mark	

Table 30. Export Status File Identifier

Bytes	Name	Description
0–12	Title Text	"EXPORT STATUS"
13	Field Delimiter	Blank character
14–15	Version	"01"
16	Blank	Blank character
17–32	User Field	This 16 byte field is not checked or used by the control unit
33–79	Retained, Not checked	This field is not checked or used by the control unit

Table 31. Export and Import Status File Record

Bytes	Name	Description
For Status Codes other than 01, 1E, 24 or 25, the bytes 0-12 are defined as follows:		
0-5	Logical Volser	For export, this field contains the volume serial number of the logical volume specified in the export list file. For import, this field contains the volume serial number of the logical volume explicitly specified in the import list file or, if only the Exported Stacked Volume to import is specified, a logical volume on the Exported Stacked Volume. When there is a cause for no logical volumes to have been imported from the Exported Stacked Volume given in bytes 7-12, the status file record for the Exported Stacked Volume will have blanks in this field.
6	Field Delimiter	Comma character
7-12	Physical Volser	For a successful export (status code = 00), this field contains the volume serial number of the Exported Stacked Volume onto which the logical volume was copied. If the export was unsuccessful, this field contains all blanks. For import status, this field contains the Exported Stacked Volume specified in the import list file. This field is right-justified and padded with blanks.
For Status Code 01, 1E, 24 or 25, the bytes 0-12 are defined as follows:		
0-12	List File Record data.	When a status code of 01, 1E or 24 is indicated, the Export or Import List File record could not be processed. The first 13 bytes of the list file record are provided here to aid in problem determination.
13	Field Delimiter	Comma character
14-15	Status Code	This field contains a two character status code number. See "Status Codes in Status File" on page 316 for more information.
16	Field Delimiter	Comma character
17	Exception Indicator	If the export or import was successful, this field contains the blank character. If the export or import was unsuccessful, this field contains the asterisk character.
18-77	Destination/Status Text	For a successful export (status code = 00), this field contains up to a 16 character destination name as specified in the export list file. If the destination was given as all blanks, this field will contain 16 question mark characters (??...?). For a successful import (status code = 00), this field is all blanks. For an unsuccessful export or import (status code \= 00), this field contains status text indicating the reason the export or import was not successful. This field is left-justified and padded with blanks. See "Status Codes in Status File" on page 316 for more information.
78-79	Reserved	

Table 32. HDR1

Bytes	Description	Use
0-2	Label Identifier	Contains "HDR"
3	Label Number	Contains "1"
4-20	Data Set Identifier	Retained, Not checked
21-26	Data Set Serial Number	Retained, Not checked
27-30	Volume Sequence Number	Retained, Not checked
31-34	Data Set Sequence Number	Retained, Not checked
35-38	Generation Number	Retained, Not checked
39-40	Version Number	Retained, Not checked
41-46	Creation Date	Retained, Not checked
47-52	Expiration Date	Retained, Not checked
53	Data Set Security	Retained, Not checked
54-59	Block Count	Must be "000000"
60-72	System Code	Retained, Not checked
73-79	Reserved	Retained, Not checked

Table 33. HDR2

Bytes	Description	Use
0-2	Label Identifier	Contains "HDR"
3	Label Number	Contains "2"
4	Record Format	Retained, Not checked
5-9	Block Length	Must be equal to the Record Length for the Export List File, Import List File and Status File. Retained, not checked for the Reserved file.
10-14	Record Length	Must be 80 bytes for the Export List File, Import List File and Status file. Retained, not checked for the Reserved file.
15	Tape Density	Retained, Not checked
16	Data Set Position	Retained, Not checked
17-33	Job/Job Step Identification	Retained, Not checked
34-35	Tape Recording Technique	Retained, Not checked
36	Control Character	Retained, Not checked
37	Reserved	Retained, Not checked
38	Block Attribute	Must be "000000"
39-46	Reserved	Retained, Not checked
47	Checkpoint Data Set Identifier	Retained, Not checked
48-79	Reserved	Retained, Not checked

Table 34. EOF1

Bytes	Description	Use
0–2	Label Identifier	Contains “EOF”
3	Label Number	Contains “1”
4–20	Data Set Identifier	Retained, Not checked
21–26	Data Set Serial Number	Retained, Not checked
27–30	Volume Sequence Number	Retained, Not checked
31–34	Data Set Sequence Number	Retained, Not checked
35–38	Generation Number	Retained, Not checked
39–40	Version Number	Retained, Not checked
41–46	Creation Date	Retained, Not checked
47–52	Expiration Date	Retained, Not checked
53	Data Set Security	Retained, Not checked
54–59	Block Count	6 EBCDIC character representation of the decimal number of blocks in the associated file, left padded with zeros. <b>Note:</b> This field is updated by the VTS if it modifies the associated file.
60–72	System Code	Retained, Not checked
73–79	Reserved	Retained, Not checked

Table 35. EOF2

Bytes	Description	Use
0–2	Label Identifier	Contains “EOF”
3	Label Number	Contains “2”
4	Record Format	Retained, Not checked
5–9	Block Length	Must be equal to the Record Length for the Export List File, Import List File and Status File. Retained, not checked for the Reserved file.
10–14	Record Length	Must be 80 bytes for the Export List File, Import List File and Status file. Retained, not checked for the Reserved file.
15	Tape Density	Retained, Not checked
16	Data Set Position	Retained, Not checked
17–33	Job/Job Step Identification	Retained, Not checked
34–35	Tape Recording Technique	Retained, Not checked
36	Control Character	Retained, Not checked
37	Reserved	Retained, Not checked
38	Block Attribute	Retained, Not checked
39–46	Reserved	Retained, Not checked
47	Checkpoint Data Set Identifier	Retained, Not checked
48–79	Reserved	Retained, Not checked

## Import List Volume

Just as with the Export List volume, the Import List volume format is described in hierarchical form in the tables below. Start with Table 36, then proceed as directed to the portion(s) of interest. All character fields within the volume are in EBCDIC. Field contents specified in quotes are EBCDIC characters. The volume must be written with compaction turned off.

Table 36. Import List Volume

Volume Contents	Description
Volume Label	See Table 24 on page 308
Import List File	See Table 37
Import Status File	See Table 40 on page 316
Tape Mark	

Table 37. Import List File

Length	Name	Description
80	Data Set Header 1	Table 32 on page 312
80	Data Set Header 2	Table 33 on page 312
	Tape Mark	
80	Import List File Identifier	Table 38
N*80	Import List File Records	Table 39 on page 315. N>0, N<=50K. N is a variable number of file records.
	Tape Mark	
80	End of File 1	Table 34 on page 313
80	End of File 2	Table 35 on page 313
	Tape Mark	

Table 38. Import List File Identifier

Bytes	Name	Description
0–10	Title Text	"IMPORT LIST"
11	Field Delimiter	Blank character
12–13	Version	"01"
14	Blank	Blank character
15–30	User Field	This 16 byte field is not checked or used by the control unit
31–79	Retained, Not checked	This field is not checked or used by the control unit

The format of the Import List File record is designed to allow for ease of use. It is expected that a customer may manually input the needed information and the format needs to be tolerant of the location of the fields in the record. Each list file record contains up to three fields separated by delimiters. The fields "physical volser", "logical volser", and "Import Option" must appear in that order, separated by a field delimiter. If the record is not equal to 80 bytes, the record is not processed and a Status File record is written with a status code of X'24'. The first 13 bytes or less of data from the record as read is provided in the Status File record. If only



one field is found in the record, it is assumed to be the “physical volser”. If the logical volser is not specified and an import option is specified, both delimiter characters are required.

Table 39. Import List File Record

Name	Description
Volser	The volume serial number of a Exported Stacked Volume to be imported. The VTS will use up to six characters to identify the volser, starting with the first non-blank character and continuing until a blank character has been found or the field delimiter character is found. Valid characters are A-Z, 0-9, and embedded blanks are not allowed. Note: If the volser specified is less than six characters, when used by the VTS it is padded on the right to form a six character field. If the volser is greater than six characters, the volume will not be imported and a Status File record is written with a Status Code of 01 and with the first 13 bytes of the list record.
Field Delimiter	Comma character required if a logical volser or import option is specified.
Logical Volser	The volume serial number of a logical volume to be imported. The VTS will use six characters to identify the volser, starting with the first non-blank character after the delimiter comma and continuing until six contiguous non-blank characters have been found. Valid characters are A-Z, 0-9. The search for six contiguous non-blank characters continues until a blank or delimiter comma character is found. This field may be all blanks or not contain any characters between the field delimiters, in which case all logical volumes on the specified Exported Stacked Volume will be imported. <b>Note:</b> Note: If the Volser found is not six characters, or contains non-valid characters, a Status File record is written with a Status Code of X'1E' and with the first 13 bytes of the list record.
Field Delimiter	Comma character required if an import option other than blank is specified.
Import Option	This field contains blanks or a keyword that defines how the logical volume is to be imported and begins with the first non-blank character found after the second Field Delimiter comma and continues through byte 71 of the record. <ul style="list-style-type: none"> <li>• If the Field Delimiter comma is not present, only blanks are allowed and if the comma is present and only blanks are found, then the data contents of the logical volume or contents of all logical volumes (if only the physical volser was specified) is copied into the VTS subsystem and fragment file entries and library manager inventory records are created.</li> <li>• If the first non-blank characters found are “SCRATCH”, the data contents is not copied and a fragment file and library manager inventory records are created. The “SCRATCH” option should be used when the data is known to have been expired and will not be accessed after the logical volume is imported.</li> <li>• If the first non-blank characters found are “INITIALIZE”, only library manager inventory records are created. The “INITIALIZE” option should be used when the logical volume is to be reinitialized and any prior data discarded.</li> </ul> <b>Note:</b> Characters found in the Import Option field after the keywords of “SCRATCH” or “INITIALIZE” will be ignored. <b>Note:</b> If other than all blanks (with or without the second Field Delimiter comma), “SCRATCH” or “INITIALIZE” with characters to be ignored are found prior to byte 72, the volume is not imported and a Status File record is written with a Status Code of 25 and with the first 13 bytes of the list record..
User Field	Bytes 72-79 of the 80 byte record are not used or checked by the VTS. This field may contain line numbers for volume lists.

Table 40. Import Status File

Length	Name	Description
80	Data Set Header 1	Table 32 on page 312
80	Data Set Header 2	Table 33 on page 312
	Tape Mark	
80	Import Status File Identifier	Table 41
N*80	Import Status File Records	N=0 is valid. N is a variable number of file records. See Table 31 on page 311.
	Tape Mark	
80	End of File 1	Table 34 on page 313
80	End of File 2	Table 35 on page 313
	Tape Mark	

Table 41. Import Status File Identifier

Bytes	Name	Description
0–12	Title Text	“IMPORT STATUS”
13	Field Delimiter	Blank character
14–15	Version	“01”
16	Blank	Blank character
17–32	User Field	This 16 byte field is not checked or used by the control unit
33–79	Retained, Not checked	This field is not checked or used by the control unit

## Status Codes in Status File

After the completion of an Export or Import operation, the customer can determine the completion status of each logical volume that was specified for the operation by examining the Status File records. The following table describes the status codes, the probable cause and the recommended actions for the customer to take.

Table 42. Status Codes and Status Text

Operation Status	Resolution Actions
<p><b>Status Code</b> 00</p> <p><b>Status Text</b> For an Export, contains the destination name, for Import contains all blanks</p> <p><b>Probable Cause</b> The volume was successfully imported or exported.</p>	None needed.

Table 42. Status Codes and Status Text (continued)

Operation Status	Resolution Actions
<p><b>Status Code</b> 01</p> <p><b>Status Text</b> 'Invalid record format, record NNNNN'</p> <p><b>Probable Cause</b> The volume could not be exported or imported because the format of the list file record was invalid.</p>	<ol style="list-style-type: none"> <li>1. Examine the first thirteen bytes of the status record. They contain the input from the list file decimal record number NNNNN as read.</li> <li>2. Correct the input record and retry the operation. Determine why the operation was canceled and retry it.</li> </ol>
<p><b>Status Code</b> 02</p> <p><b>Status Text</b> 'Canceled - Host request'</p> <p><b>Probable Cause</b> The volume could not be exported or imported because the operation was canceled by the host prior to processing the volume.</p>	<p>Determine why the operation was canceled and retry it.</p>
<p><b>Status Code</b> 03</p> <p><b>Status Text</b> 'Canceled - Library request'</p> <p><b>Probable Cause</b> The volume could not be exported or imported because the operation was canceled, prior to processing the volume, by the operator through the Library Manager console.</p>	<p>Determine why the operation was canceled and retry it.</p>
<p><b>Status Code</b> 05</p> <p><b>Status Text</b> Logical volume not in VTS</p> <p><b>Probable Cause</b> The logical volume specified in the export list is not resident in the Virtual Tape Server subsystem in which the export operation was performed.</p>	<p>This can be a normal status if the list file contains records for more than one VTS or library. If that is not the case, determine why the logical volume is not in the VTS subsystem in which the operation was performed.</p>

Table 42. Status Codes and Status Text (continued)

Operation Status	Resolution Actions
<p><b>Status Code</b> 06</p> <p><b>Status Text</b> Exported Stacked Volume not in the Library</p> <p><b>Probable Cause</b> The Exported Stacked Volume specified in the import list (either with a specific logical volume or for import of all logical volumes) is not in the library in which the import operation was performed.</p>	<ol style="list-style-type: none"> <li>1. Locate the Exported Stacked Volume needed and insert it into the library.</li> <li>2. Retry the import operation.</li> </ol>
<p><b>Status Code</b> 07</p> <p><b>Status Text</b> Logical volume not found on Exported Stacked Volume</p> <p><b>Probable Cause</b> The logical volume specified in the import list is not resident on the Exported Stacked Volume specified.</p>	<ol style="list-style-type: none"> <li>1. Use the tape management system or the TCDB records to verify that the logical volume is on the Exported Stacked Volume specified.</li> <li>2. Correct any errors and retry the import operation.</li> </ol>
<p><b>Status Code</b> 08</p> <p><b>Status Text</b> Exported Stacked Volume not in Import category</p> <p><b>Probable Cause</b> Processing for the Exported Stacked Volume not allowed. The Exported Stacked Volume specified in the import list is in the library, but is not assigned to the Import category.</p>	<ol style="list-style-type: none"> <li>1. Use the tape management system or TCDB to check that the specified volume is an Exported Stacked Volume.</li> <li>2. If the volume is an Exported Stacked Volume and is in the Unassigned category, move the volume to the Import category.</li> <li>3. If the Exported Stacked Volume is found in the Insert category, the volume must be moved to the Eject category and when ejected, it must be reinserted into the Convenience I/O station and moved into the Import category.</li> <li>4. Retry the import operation.</li> <li>5. If the volume is not found to be an Exported Stacked Volume, check the source for the Import List Volume contents.</li> </ol>
<p><b>Status Code</b> 09</p> <p><b>Status Text</b> Logical volume in-use</p> <p><b>Probable Cause</b> The logical volume could not be exported because the volume specified in the export list was mounted or queued to be mounted when the list was processed as part of the export operation.</p>	<p>Retry the export of the volume when it is no longer being used.</p>

Table 42. Status Codes and Status Text (continued)

Operation Status	Resolution Actions
<p><b>Status Code</b> 10</p> <p><b>Status Text</b> Terminated by library error</p> <p><b>Probable Cause</b> The volume could not be exported or imported because the operation was terminated by a non-recoverable (check1) error detected by the Library Manager prior to processing the volume.</p>	<p>Call an IBM Service Representative.</p>
<p><b>Status Code</b> 11</p> <p><b>Status Text</b> Terminated by VTS error XXXX</p> <p><b>Probable Cause</b> The volume could not be exported or imported because the operation was terminated by a non-recoverable error detected by the Virtual Tape Server subsystem prior to processing the volume.</p>	<p>Call an IBM Service Representative. Error XXXX indicates the functional area within the VTS which encountered the non-recoverable error.</p>
<p><b>Status Code</b> 12</p> <p><b>Status Text</b> Duplicate volume in list</p> <p><b>Probable Cause</b> For Export, the Export list has more than one entry of a logical volume to be exported. The logical volume will not be exported for the destinations provided. A Status File record with Status Code = 12 will be written for each of the logical volumes in the Export list which are the same. For Import, the Import list has more than one entry of an Exported Stacked Volume with the same or conflicting Logical Volser field values; such as, blanks, the Logical Volser, or blanks and a Logical Volser. Status File records for each Import list record will be written with status code = 12 and no import processing will occur for any records which are the same or conflicting.</p>	<p>Determine why more than one Export or Import List file record specifies the same volume.</p>

Table 42. Status Codes and Status Text (continued)

Operation Status	Resolution Actions
<p><b>Status Code</b> 13</p> <p><b>Status Text</b> Duplicate volume in library</p> <p><b>Probable Cause</b> The logical volume could not be imported because it already resides in the library inventory. The library inventory includes logical volumes in all VTS subsystems within the same physical library and all physical volumes in the library.</p>	<p>Determine why the specified volume is a duplicate in the library.</p>
<p><b>Status Code</b> 14</p> <p><b>Status Text</b> Duplicate volume in Enterprise</p> <p><b>Probable Cause</b> The logical volume could not be imported because the attached hosts determined that it already resides in another library.</p>	<p>Determine why the specified volume is a duplicate in the enterprise.</p>
<p><b>Status Code</b> 15</p> <p><b>Status Text</b> Library full</p> <p><b>Probable Cause</b> The logical volume could not be imported because the library has reached the maximum number of logical volumes it can support.</p>	<ol style="list-style-type: none"> <li>1. Export or delete enough logical volumes from the library to provide room for the needed imported volumes.</li> <li>2. Retry the import operation.</li> </ol>
<p><b>Status Code</b> 16</p> <p><b>Status Text</b> Stacked Volume access failure</p> <p><b>Probable Cause</b></p> <p>For Export, the logical volume could not be exported because the VTS stacked volume containing the logical volume could not be accessed.</p> <p>For Import, a logical volume or all logical volumes on the Exported Stacked Volume specified in the Import List file could not be imported because the Exported Stacked Volume could not be accessed.</p>	<ol style="list-style-type: none"> <li>1. Refer to Figure 83 on page 140. For the volser indicated, if the Status Flags are Inaccessible or Misplaced, follow instructions in "Table for Problem Determination using the Search Database for Volumes Window" on page 281.</li> <li>2. If the volser Status Flags are other than Inaccessible or Misplaced, call an IBM Service Representative.</li> </ol>

Table 42. Status Codes and Status Text (continued)

Operation Status	Resolution Actions
<p><b>Status Code</b> 17</p> <p><b>Status Text</b> Logical volume Copy failure</p> <p><b>Probable Cause</b> During an export operation, the logical volume could not be exported because a permanent error was encountered when copying the volume from the source stacked volume to the Exported Stacked Volume. During an import operation, the logical volume could not be imported because a permanent error was encountered when copying the volume from the source Exported Stacked Volume to a stacked volume.</p>	<p>Suspected media failure, call an IBM Service Representative.</p>
<p><b>Status Code</b> 18</p> <p><b>Status Text</b> No Data Associated With Logical Volume</p> <p><b>Probable Cause</b> The logical volume could not be exported because there is no data associated with the volume on a stacked volume in the VTS subsystem. The most likely reason is that the logical volume has never been used in the VTS prior to it being specified for export.</p>	<p>Check the logical volume's record in the tape management system to determine if the volume contains active data or not. If it does not, use the logical volume deletion function to remove the volume from the library. If it does show that the volume contains active data, call for service.</p>
<p><b>Status Code</b> 19</p> <p><b>Status Text</b> Logical Volume Copy/Fragment Failure</p> <p><b>Probable Cause</b> The logical volume could not be exported because it is currently resident in the Tape Volume Cache and attempts to copy it to a stacked volume and create its Fragment failed.</p>	<p>Call an IBM Service Representative.</p>
<p><b>Status Code</b> 1A</p> <p><b>Status Text</b> Logical Volume TVC State Unknown</p> <p><b>Probable Cause</b> The logical volume could not be exported because its state in the Tape Volume Cache could not be determined.</p>	<p>Call an IBM Service Representative.</p>

Table 42. Status Codes and Status Text (continued)

Operation Status	Resolution Actions
<p><b>Status Code</b> 1B</p> <p><b>Status Text</b> Logical Volume Processing Error XXXX</p> <p><b>Probable Cause</b> The logical volume could not be exported or imported because an internal VTS error XXXX was encountered. Internal or host time-out occurrences also result in Export/Import Status file records with this Status Code for all logical volumes which were not successfully processed.</p>	<p>Call an IBM Service Representative. Error XXXX indicates the functional area within the VTS which detected the internal error.</p>
<p><b>Status Code</b> 1C</p> <p><b>Status Text</b> Fragment File Not Readable</p> <p><b>Probable Cause</b>  For Export, the logical volume could not be exported because its fragment file in the Tape Volume Cache could not be read.  For Import, the logical volume could not be imported because its fragment information could not be read from the Exported Stacked Volume.</p>	<p>Call an IBM Service Representative.</p>
<p><b>Status Code</b> 1D</p> <p><b>Status Text</b> Unable to Write Fragment File</p> <p><b>Probable Cause</b> The logical volume could not be exported because its fragment file could not be written to the Exported Stacked Volume.</p>	<p>Call an IBM Service Representative.</p>
<p><b>Status Code</b> X'1E'</p> <p><b>Status Text</b> Invalid Logical Volume, record NNNNN</p> <p><b>Probable Cause</b> The Volser of the logical volume is not six characters or contains characters which are not valid.</p>	<ol style="list-style-type: none"> <li>1. Examine the first thirteen bytes of the status record. They contain the input from the list file decimal record number NNNNN as read.</li> <li>2. Correct the input record and retry the operation.</li> </ol>



Table 42. Status Codes and Status Text (continued)

Operation Status	Resolution Actions
<p><b>Status Code</b> 1F</p> <p><b>Status Text</b> Logical Volume Recall Failed</p> <p><b>Probable Cause</b> The fragment file for a logical volume being exported did not contain the logical volume's tape label records so the VTS subsystem attempted to perform a recall of the logical volume. The recall failed so the logical volume was not exported.</p>	<ol style="list-style-type: none"> <li>1. Check intervention required messages on the library manager console for the reason why the recall failed.</li> <li>2. Correct the reason and retry the export operation.</li> </ol>
<p><b>Status Code</b> 20</p> <p><b>Status Text</b> Library Manager Error</p> <p><b>Probable Cause</b> The logical volume could not be exported because of a library manager reported error during export processing.</p>	<p>Call an IBM Service Representative.</p>
<p><b>Status Code</b> 21</p> <p><b>Status Text</b> Terminated - out of scratch</p> <p><b>Probable Cause</b> The logical volume could not be exported or imported because the operation was terminated after waiting 60 minutes for a scratch stacked volume to be made available to the VTS.</p>	<ol style="list-style-type: none"> <li>1. Add physical volumes to the VTS.</li> <li>2. Retry the operation.</li> </ol>
<p><b>Status Code</b> 22</p> <p><b>Status Text</b> Terminated - waiting for host response</p> <p><b>Probable Cause</b> The logical volume could not be exported because the export operation was terminated due to inactivity for 60 continuous minutes while processing the volumes assigned to the exported category. It is likely there are no operational hosts attached to the VTS.</p>	<ol style="list-style-type: none"> <li>1. Determine why the hosts attached to the VTS are not responding to the request to process exported volumes.</li> <li>2. Retry the operation.</li> </ol>

Table 42. Status Codes and Status Text (continued)

Operation Status	Resolution Actions
<p><b>Status Code</b> 23</p> <p><b>Status Text</b> Logical volume left in Insert category</p> <p><b>Probable Cause</b> The Import operation was canceled from the Library Manager console and there is no host attached to the VTS that can process logical volumes assigned to the Insert category, or the Import operation was terminated because the host had been inactive for 60 continuous minutes while processing volumes assigned to the Insert category.</p>	<p>None required.</p>
<p><b>Status Code</b> X'24'</p> <p><b>Status Text</b> List File Record Incorrect Length, record NNNNN</p> <p><b>Probable Cause</b> The List File record is not 80 characters.</p>	<ol style="list-style-type: none"> <li>1. Examine the first thirteen bytes of the status record. They contain the input from the list file decimal record number NNNNN as read.</li> <li>2. Correct the input record and retry the operation.</li> </ol>
<p><b>Status Code</b> 25</p> <p><b>Status Text</b> Import Option Invalid, record NNNNN</p> <p><b>Probable Cause</b> The Import Option field of the record NNNNN was not all blanks, SCRATCH or INITIALIZE.</p>	<ol style="list-style-type: none"> <li>1. Examine the first thirteen bytes of the status record. They contain the input from the list file decimal record number NNNNN as read.</li> <li>2. Correct the input record and retry the operation.</li> </ol>
<p><b>Status Code</b> 26</p> <p><b>Status Text</b> Terminated, fewer than four drives available</p> <p><b>Probable Cause</b> The volume could not be exported or imported because the operation was terminated when fewer than four 3590 drives became available to the VTS.</p>	<p>Call an IBM Service Representative.</p>
<p><b>Status Code</b> 27</p> <p><b>Status Text</b> Volume is not a logical volume</p> <p><b>Probable Cause</b> The Library Manager detected that the volume in the Export List is not a logical volume.</p>	<ol style="list-style-type: none"> <li>1. Examine the first thirteen bytes of the status record. They contain the input from the list file decimal record number NNNNN as read.</li> <li>2. Correct the input record and retry the operation.</li> </ol>

Table 42. Status Codes and Status Text (continued)

Operation Status	Resolution Actions
<p><b>Status Code</b> 28</p> <p><b>Status Text</b> Exported Stacked Volume processing error</p> <p><b>Probable Cause</b> On Import, the file on the Exported Stacked Volume containing the list of logical volumes stored on the Exported Stacked Volume could not be read without error.</p>	<p>Suspected media failure, call an IBM Service Representative.</p>
<p><b>Status Code</b> 29</p> <p><b>Status Text</b> Orphaned logical volume</p> <p><b>Probable Cause</b> On Export, the VTS storage management code does not recognize the logical volume volser; therefore, the logical volume cannot be exported.</p>	<p>Call an IBM Service Representative.</p>
<p><b>Status Code</b> 30</p> <p><b>Status Text</b> Logical volume assigned to insert category</p> <p><b>Probable Cause</b> For Export, the logical volume is currently assigned to the insert category. Volumes in the insert category have not been accepted by a host and cannot be exported.</p>	<ol style="list-style-type: none"> <li>1. Check host systems attached to the VTS to insure that they are processing volumes in the insert category.</li> <li>2. If the check above indicates that there is at least one host which is processing volumes in the insert category, determine why the specific volume has not been processed.</li> </ol>
<p><b>Status Code</b> 31</p> <p><b>Status Text</b> Exported Stacked Volume unload failure</p> <p><b>Probable Cause</b> For Import, the Exported Stacked Volume volser found in the Physical Volume field of the Status File record was used for importing logical volumes and could not be demounted from the tape drive and may not have been returned to the Import category.</p>	<p>Call an IBM Service Representative.</p>

Table 42. Status Codes and Status Text (continued)

Operation Status	Resolution Actions
<p><b>Status Code</b> 32</p> <p><b>Status Text</b> Invalid container volume</p> <p><b>Probable Cause</b> For Export, a cancel issued by an operator from the Library Manager console or a termination due to host inactivity may have resulted in a 'container volume' being shown in the tape management system database for logical volumes which have not been exported from the VTS.</p>	<p>For each logical volume having this Status Code, the tape management system database must be searched and corrected if a 'container volume' is shown.</p> <p>For DFSMSrmm, the following steps may be taken:</p> <ol style="list-style-type: none"> <li>Using the volser of the first volume in the Status File with Status Code X'32', perform a RMM LISTVOLUME and determine if a container volume is shown. If none is found, proceed with RMM LISTVOLUME for all volumes with Status Code X'32' until a container is identified.</li> <li>If RMM LISTVOLUME has been performed for all logical volumes with Status Code X'32' and a container volume has not been found, then further action is not necessary.</li> <li>For those logical volumes with Status Code X'32' which are found to have a container volume, <b>it is necessary to change the container volume to blanks.</b></li> <li>Using the volser identified as the container volume, search for volumes associated with the container volume and build RMM CHANGEVOLUME commands for each volume. Use the command: RMM SEARCHVOLUME VOLUME(*) OWNER(*) LIMIT(*) CONTAINER(container_volser) CLIST('RMM CV', 'CONTAINER(" ") FORCE')</li> <li>Run the CLIST created in step 4 to perform the change to a blank container volume for all volumes found with the identified container volume.</li> </ol> <p><b>Alternatively</b>, each logical volume with Status Code X'32' which has a container volume may be changed to a blank container without building a CLIST. After using RMM LISTVOLUME to find logical volumes with a container volume, user the command: RMM CHANGEVOLUME volser CONTAINER(' ') FORCE</p> <p><b>Note:</b> Tape management systems other than DFSMSrmm must facilitate a function to search and change the container volume field to blanks for logical volumes with a Status Code X'32' in the Status File upon completion of the Export operation.</p>

## Import and Export Messages from Library

During processing of an Export or Import operation, the VTS subsystem generates status messages that indicate the progress of the operation. The message is broadcast to all hosts attached to the VTS subsystem. On MVS hosts, the message results in a console message being written in the following format:

```
CBR3750I MESSAGE FROM LIBRARY <library-name>: 70 EBCDIC character message
```

The 70 character message contains the status message as defined below:

### Bytes 0–4

Unique Message Code The unique message code is further defined as a

single alpha character followed by four numeric characters. The alpha character indicates which element/function in the VTS/Library generated the message. The numeric characters are a sequential number for a specific element/function. The element/function codes are defined as:

**E** Export

**I** Import

**Byte 5:**

Blank character

**Bytes 6–69**

Status Message Text

## Export Status Messages

Table 43. Export Status Messages

Message Code	Message Text
E0001	<p>EXPORT PROCESSING STARTED FOR DESTINATION XXXXXXXXXXXXXXXXXXXX</p> <p>This message is generated when the VTS begins processing the logical volumes for a specific destination. The 'XX...X' field is replaced with the destination name from the export list file. The destination name is left justified and padded with blanks if the destination name is less than 16 characters. If the destination name in the export list file is all blanks, a destination name of 16 question mark characters ('??...?') is used.</p> <p>Action: None, status only.</p>
E0002	<p>EXPORTED LOGICAL VOLUMES ON YYYYYY READY FOR HOST PROCESSING</p> <p>This message is generated when all of the logical volumes on an exported stacked volume YYYYYY have been placed in the exported category and are ready for the host to process.</p> <p>Action: None, status only.</p>
E0003	<p>EXPORT PROCESSING COMPLETED FOR DESTINATION XXXXXXXXXXXXXXXXXXXX</p> <p>This message is generated when the VTS has completed processing the logical volumes for a specific destination (including the host purging of the exported logical volume from the library manager inventory). The 'XX...X' field is replaced with the destination name from the export list file. The destination name is left justified and padded with blanks if the destination name is less than 16 characters. If the destination name in the export list file is all blanks, a destination name of 16 question mark characters ('??...?') is used.</p> <p>Action: None, status only.</p>
E0004	<p>STACKED VOLUME YYYYYY FOR DEST XXXXXXXXXXXXXXXXXXXX IN EXPORT-HOLD</p> <p>This message is generated when the library has placed Exported Stacked Volume 'YYYYYY' in the Export-Hold category. The 'XXX...X' field is replaced with the destination name from the export list file. The destination name is left justified and padded with blanks if the destination name is less than 16 characters. If the destination name in the export list file is all blanks, a destination name of 16 question mark characters ('???...?') is used.</p> <p>Action: Operator may now use the Library Manager console pop-up window, Manage Export-Hold Volumes, to move the Exported Stacked Volume to the Eject category or to the Import category. Volumes in the Eject category will be ejected to the Convenience I/O station by the Library Manager.</p>

Table 43. Export Status Messages (continued)

Message Code	Message Text
E0005	<p>ALL EXPORT PROCESSING HAS COMPLETED</p> <p>This message is generated when the VTS completes an export operation.</p> <p>Action: None, status only.</p>
E0006	<p>Reserved</p> <p>Action:</p>
E0007	<p>Reserved</p> <p>Action:</p>
E0008	<p>Reserved</p> <p>Action:</p>
E0009	<p>Reserved</p> <p>Action:</p>
E0010	<p>EXPORT PROCESSING WAITING FOR HOST RESPONSE</p> <p>This message is generated every 10 minutes when there is no host activity to complete the processing of the logical volumes in the exported category.</p> <p>Action: None, status only.</p>
E0011	<p>EXPORT PROCESSING TERMINATED WAITING FOR HOST RESPONSE</p> <p>This message is generated when the VTS has terminated the export operation because host processing of the logical volumes in the exported category has been inactive for a period of 60 continuous minutes.</p> <p>Action: Perform analysis of the Status File on the Export List volume and reissue the Export operation.</p>
E0012	<p>FRAGMENTS FOR STACKED VOLUME XXXXXX NOT DELETED</p> <p>There has been a VTS failure to successfully delete all of the fragments for logical volumes which were exported successfully otherwise.</p> <p>Action: Call service.</p>
E0013	<p>EXPORT PROCESSING SUSPENDED, WAITING FOR SCRATCH VOLUME</p> <p>This message is generated every five minutes when the VTS needs a scratch stacked volume to continue export processing and there are none available.</p> <p>Action: None, status only.</p>
E0014	<p>EXPORT PROCESSING RESUMED, SCRATCH VOLUME MADE AVAILABLE</p> <p>This message is generated when, after the export operation was suspended because no scratch stacked volumes were available, scratch stacked volumes are again available and the export operation can continue.</p> <p>Action: None, status only.</p>

Table 43. Export Status Messages (continued)

Message Code	Message Text
E0015	<p>EXPORT PROCESSING TERMINATED, WAITING FOR SCRATCH VOLUME</p> <p>This message is generated when the VTS has terminated the export operation because scratch stacked volumes were not made available to the VTS within 60 minutes of the VTS readiness to copy logical volumes to an Exported Stacked Volume.</p> <p>Action: Operator should make more VTS stacked volumes available, perform analysis of the Status File on the Export List volume, and reissue the Export operation.</p>
E0016	<p>COPYING LOGICAL EXPORT VOLUMES FROM CACHE TO STACKED VOLUMES</p> <p>This message is generated when the VTS begins, and every 10 minutes during, the process of copying and /or fragmenting logical volumes which are still in the Tape Volume Cache and must be on a stacked volume before proceeding to copy them to an Exported Stacked Volume.</p> <p>Action: None, status only.</p>
E0017	<p>COMPLETED COPY OF LOGICAL EXPORT VOLUMES TO STACKED VOLUMES</p> <p>This message is generated when the VTS has completed the copy of logical volumes to VTS stacked volumes, allowing the continuing process of copying to the Exported Stacked Volumes.</p> <p>Action: None, status only.</p>
E0018	<p>EXPORT TERMINATED, EXCESSIVE TIME FOR COPY TO STACKED VOLUMES</p> <p>The Export process has been terminated because the logical volumes could not be copied to VTS stacked volumes and/or fragmented within a 10 hour period from beginning the Export operation.</p> <p>Action: Perform analysis of the Status File on the Export List volume and reissue the Export operation.</p>
E0019	<p>Reserved</p> <p>Action:</p>
E0020	<p>Reserved</p> <p>Action:</p>
E0021	<p>Reserved</p> <p>Action:</p>
E0022	<p>EXPORT RECOVERY STARTED</p> <p>The Export operation has been interrupted by a VTS error or a power off condition for which recovery is being attempted.</p> <p>Action: None, status only.</p>
E0023	<p>EXPORT RECOVERY COMPLETED</p> <p>The recovery attempt for interruption of an Export operation has been completed.</p> <p>Action: Perform analysis of the Status File on the Export List volume and reissue the Export operation, if necessary.</p>

## Import Status Messages

Table 44. Import Status Messages

Message Code	Message Text
I0001	<p>IMPORT PROCESSING STARTED FOR EXPORTED STACKED VOLUME YYYYYY</p> <p>This message is generated when the VTS has started processing Exported Stacked Volume YYYYYY.</p> <p>Action: None, status only.</p>
I0002	<p>IMPORTED LOGICAL VOLUMES FROM YYYYYY READY FOR HOST PROCESSING</p> <p>This message is generated when all of the logical volumes on an Exported Stacked Volume YYYYYY have been placed in the insert category and are ready for the host to process.</p> <p>Action: None, status only.</p>
I0003	<p>PROCESSING ON VOLUME YYYYYY HAS COMPLETED</p> <p>This message is generated when the VTS completes import processing of the Exported Stacked Volume whose volser is YYYYYY.</p> <p>Action: None, status only.</p>
I0004	<p>ALL IMPORT PROCESSING HAS COMPLETED</p> <p>This message is generated when the VTS completes an import operation.</p> <p>Action: None, status only.</p>
I0005	Reserved
I0006	Reserved
I0007	Reserved
I0008	Reserved
I0009	<p>IMPORT PROCESSING WAITING FOR HOST RESPONSE</p> <p>This message is generated every 10 minutes when there is no host activity to complete the processing of the logical volumes placed in the insert category during an import operation.</p> <p>Action: None, status only.</p>
I0010	<p>IMPORT PROCESSING TERMINATED WAITING FOR HOST RESPONSE</p> <p>This message is generated when the VTS has terminated the Import operation because host processing of the logical volumes in the Insert category has been inactive for a period of 60 continuous minutes.</p> <p>Action: Perform analysis of the Status List file on the Export List volume and reissue the Import operation.</p>
I0011	<p>Reserved</p> <p>Action:</p>
I0012	<p>IMPORT PROCESSING SUSPENDED, WAITING FOR SCRATCH VOLUME</p> <p>This message is generated every five minutes when the VTS needs a scratch stacked volume to continue import processing and there are none available.</p> <p>Action: None, status only.</p>



Table 44. Import Status Messages (continued)

Message Code	Message Text
I0013	<p>IMPORT PROCESSING RESUMED, SCRATCH VOLUME MADE AVAILABLE</p> <p>This message is generated when, after the import operation was suspended because no scratch stacked volumes were available, scratch stacked volumes are again available and the import operation can continue.</p> <p>Action: None, status only.</p>
I0014	<p>IMPORT PROCESSING TERMINATED, WAITING FOR SCRATCH VOLUME</p> <p>This message is generated when the VTS has terminated the import operation because scratch stacked volumes were not made available to the VTS within 60 minutes of the VTS need for a scratch volume on which to copy imported logical volumes.</p> <p>Action: Operator should make more VTS stacked volumes available, perform analysis of the Status File on the Export List volume, and reissue the Import operation.</p>
I0015	<p>IMPORT RECOVERY STARTED</p> <p>The Import operation has been interrupted by a VTS error or a power off condition for which recovery is being attempted.</p> <p>Action: None, status only.</p>
I0016	<p>IMPORT RECOVERY COMPLETED</p> <p>The recovery attempt for interruption of an Import operation has been completed.</p> <p>Action: Perform analysis of the Status File on the Export List volume and reissue the Import operation, if necessary.</p>

## Export/Import List Volumes Failure-Reason Text

If the VTS subsystem was unable to process the Export or Import list volume, the host generates message CBR3858I. The reason the list volume could not be processed is included as a text string. The following table defines the failure-reasons returned, the probable cause and the recommended actions for the customer to take.

In the table below, the symbols <VOLSER>, <File>, <Record>, and <Field> will be replaced in the message text as appropriate to describe the location of the error found:

- <VOLSER>, the logical Volser which was provided in the Export or Import operation.
- <File>, Export List File, Import List File, Reserved File or Status File.
- <Record>, within a HDR1, HDR2, EOF1 EOF2, Identifier or Record.
- <Field>, within a Label Identifier, Block Count, Record Length, Block Count, Title Text or Version.

Table 45. Export-Import List Volumes Failure Reason Text

Failure-Reason Text — Probable cause.	Recommended Action
<p><b>Volume &lt;VOLSER&gt; has not been written</b></p> <p>The Export or Import operation specified a Export/Import List Volume which has not been created (written).</p>	<p>Operator should check for the correct identity of the Import/Export List Volume and, if necessary, execute the JCL which prepares a logical volume as the Import/Export List Volume.</p>

Table 45. Export-Import List Volumes Failure Reason Text (continued)

<b>Failure-Reason Text — Probable cause.</b>	<b>Recommended Action</b>
<b>Volume &lt;VOLSER&gt; could not be opened</b> VTS failure.	Call your IBM Service Representative.
<b>Volume &lt;VOLSER&gt; could not be rewound</b> VTS failure.	Call your IBM Service Representative.
<b>Volume &lt;VOLSER&gt; could not be closed</b> VTS failure.	Call your IBM Service Representative.
<b>Volume &lt;VOLSER&gt; , unable to locate Export List Records</b> No records were found in the Export List file on the Volser specified.	Check source data used for preparation of the Import List Volume or Export List Volume.
<b>Volume &lt;VOLSER&gt; unable to locate Import List Records</b> No records were found in the Import List file on the Volser specified.	Check source data used for preparation of the Import List Volume or Export List Volume.
<b>Volume Label, read error</b> Volume Label record could not be read successfully.	Call your IBM Service Representative.
<b>Volume Label , compacted</b> Volume Label record was compacted data.	Check JCL which prepared the Import/Export List Volume.
<b>Volume Label, error converting Label Identifier</b> The EBCDIC field did not convert to ASCII correctly.	Check JCL which prepared the Import/Export List Volume.
<b>Volume Label, incorrect Label Identifier</b> The characters 'VOL1' were not found in the Label Identifier and Label Number fields of the Volume Label.	Check JCL which prepared the Import/Export List Volume.
<b>Volume Label, error converting Volser</b> The EBCDIC field did not convert to ASCII correctly.	Check JCL which prepared the Import/Export List Volume.
<b>Volume Label, Volser Mismatch</b> The Volser found in the Volume Label does not match the Volser specified in the Export/Import operation.	Call your IBM Service Representative.
<b>Volume Label, found tape mark instead</b> Tape Mark was found which is not in the correct format sequence.	Check JCL which prepared the Import/Export List Volume.
<b>Volume Label, unexpected End of Tape</b> The End of Tape was reached unexpectedly when attempting to read the Volume Label.	Check JCL which prepared the Import/Export List Volume.
<b>Volume Label, record is not 80 bytes</b> The Volume Label record is not 80 bytes.	Check JCL which prepared the Import/Export List Volume.
<b>&lt;File&gt; &lt;record&gt;, read error</b> When attempting to read the indicated Record from the Tape Volume Cache, a read error occurred.	Call your IBM Service Representative.

Table 45. Export-Import List Volumes Failure Reason Text (continued)

<b>Failure-Reason Text — Probable cause.</b>	<b>Recommended Action</b>
<p><b>&lt;File&gt; &lt;Record&gt;, found tape mark instead</b></p> <p>A tape mark was read instead of the File and Record indicated.</p>	Check JCL which prepared the Import/Export List Volume.
<p><b>&lt;File&gt; &lt;Record&gt;, unexpected End of Tape</b></p> <p>The End of Tape was reached on the tape volume unexpectedly.</p>	Check JCL which prepared the Import/Export List Volume.
<p><b>&lt;File&gt; &lt;Record&gt;, compacted</b></p> <p>The Record in the File indicated was compacted.</p>	Check JCL which prepared the Import/Export List Volume.
<p><b>&lt;File&gt; &lt;Record&gt;, error converting &lt;Field&gt;</b></p> <p>The EBCDIC Field in the File and Record indicated did not convert to ASCII correctly.</p>	Check JCL which prepared the Import/Export List Volume.
<p><b>&lt;File&gt; &lt;Record&gt;, incorrect &lt;Field&gt;</b></p> <p>The Field indicated in the File and Record indicated did not have the correct contents.</p>	Check JCL which prepared the Import/Export List Volume.
<p><b>&lt;File&gt; &lt;Record&gt;, invalid Record Length</b></p> <p>The Record Length field of the HDR2 or EOF2 record in the File indicated is not equal to 80 characters.</p>	Check JCL which prepared the Import/Export List Volume.
<p><b>&lt;File&gt; &lt;Record&gt;, Block and Record Length mismatch</b></p> <p>The Block Length and Record Length fields of HDR2 or EOF2 are not equal in the File and Record indicated</p>	Check JCL which prepared the Import/Export List Volume.
<p><b>&lt;File&gt; &lt;Record&gt;, record is not 80 bytes</b></p> <p>The length of the HDR1, HDR2, EOF1 or EOF2 record is not equal to 80 bytes in the File and Record indicated.</p>	Check JCL which prepared the Import/Export List Volume.
<p><b>&lt;File&gt;, missing a tape mark</b></p> <p>For the File indicated, a tape mark was not found as expected in the format.</p>	Check JCL which prepared the Import/Export List Volume.
<p><b>&lt;File&gt;, internal processing error MMMM</b></p> <p>VTS error. MMMM is a decimal number which indicates the internal functional area encountering the error.</p>	Call your IBM Service Representative.
<p><b>&lt;File&gt;, more than max allowed records</b></p> <p>For the Export List File or Import List File as indicated, there are more than 50K records.</p>	Check source data used for preparation of the Import/Export List Volume.
<p><b>&lt;File&gt;, number of records=0</b></p> <p>For the Export List File or Import List File as indicated, the number of records was found to be 0.</p>	Check source data used for preparation of the Import/Export List Volume.
<p><b>Reserved File, Identifier not found</b></p> <p>The Identifier record for the Reserved File was not found.</p>	Check JCL which prepared the Import/Export List Volume.

## Category Recovery

Errors may be made when placing cartridges in the Convenience I/O Station and moving them into other categories from the Unassigned Category when the Advanced Function feature is installed on at least one VTS in a Library. The error scenarios and recovery actions are described below:

Table 46. Category Recovery Error Scenarios

Error Scenario	Recovery Actions
<p><b>Error Scenario</b> An Exported Stacked Volume with logical volumes which have not been imported has been assigned to the Insert category and the volume serial number falls within a range defined for VTS stacked volumes.</p> <p><b>Resultant Library Action</b> The library/VTS subsystem will add the volume as a scratch stacked volume. <b>Note:</b> Data on a volume will be overwritten when the volume gets selected for use by the VTS subsystem.</p>	<ul style="list-style-type: none"> <li>Eject the volume through the library manager console using the Eject a Stacked Volume function.</li> <li>If the Exported Stacked Volume is needed for an Import operation, reinsert the volume into the Convenience I/O station and use the Manage Unassigned Volumes pop-up window to assign the volume to the Import category.</li> </ul>
<p><b>Error Scenario</b> An Exported Stacked Volume with logical volumes which have not been imported has been assigned to the Insert category and the volume serial number does not fall within a range defined for VTS stacked volumes.</p> <p><b>Resultant Library Action</b> The library will assign the volume to the Insert category for 3590 native use and notify all attached hosts. <b>Note:</b> Data on a volume will be overwritten when the volume gets selected for use by a host.</p>	<ul style="list-style-type: none"> <li>Eject the volumes from the library through host console command, ISMF or tape management system command.</li> <li>If the Exported Stacked Volume is needed for an Import operation, reinsert the volume into the Convenience I/O station and use the Manage Insert Volumes pop-up window to assign the volume to the Import category.</li> </ul>
<p><b>Error Scenario</b> An Exported Stacked Volume has been assigned to the Import category and has not been required for the Import operation.</p> <p><b>Resultant Library Action</b> Volume remains in the Import category</p>	<p>Use the Manage VTS Import Volumes pop-up window to eject the volume.</p>
<p><b>Error Scenario</b> An HPCT volume (not an Exported Stacked Volume) which is needed as a scratch stacked volume or native 3590 volume has been assigned to the Import category.</p> <p><b>Resultant Library Action</b> The volume remains in the Import category until operator action is taken.</p>	<p>Use the Manage VTS Import Volumes pop-up window to move the volume to the Insert category defined by Volser ranges or eject the volume if it is not desired in the library.</p>

---

## Reuse of Exported Stacked Volumes

Once all of the logical volumes on an Exported Stacked Volume have been imported into a VTS subsystem, the Exported Stacked Volume can be re-used for any 3590 application. No cleanup or special processing is required; however, the Exported Stacked Volumes remain in the Import category until operator action is taken. It is up to the customer to determine when all of the logical volumes on an Exported Stacked Volume have been imported or are no longer needed and that the physical volume can be re-used as a stacked volume in a VTS or for native use on a 3590 subsystem. This would normally be determined by using the tape management system to check that there are no logical volumes contained on a physical volume previously used as an Exported Stacked Volume. For example, the **RMM SEARCHVOLUME** command can be used to make this determination as follows:

```
RMM SV CONTAINER(xxxxxx)
```

where **xxxxxx** is the volsers of the Exported Stacked Volume in question.

If no volumes are returned, all of the logical volumes on the Exported Stacked Volume have been imported and the volume may be re-used.

Reuse of the physical volumes is accomplished with operator action by using a library manager console **Manage Import Volumes** pop-up window to move the Exported Stacked Volumes out of the Import category. (See Figure 130 on page 204.) Once they are moved out of the Import category, one of the following will happen:

- The volumes are moved into the Insert category if they are to be used as scratch stacked volumes in a VTS within the current physical library. The volsers of the physical volumes must fall in the range assigned for stacked volumes in the library partition the volumes are to go into. If they are not in a range assigned for stacked volumes, the volumes are entered into the library for native 3590 usage as the default.
- The volumes are moved into the Insert category if they are to be used as native 3590 cartridges. The volsers of the physical volumes must fall in the range assigned for native 3590 use. If they are not in a range assigned for 3590 native use, the volumes are entered into the library for native 3590 usage as the default.
- Otherwise, the volumes are ejected for other use or later disposition. Exported Stacked Volumes may be placed in the Convenience I/O station at any time, they will be moved into the library in the Unassigned category, and the Manage Unassigned Volumes pop-up window may then be used by the operator to change the category to Import or Insert, or to eject the volume.



## Notices

References in this publication to IBM programs or services do not imply that IBM intends to make these available in all countries in which IBM operates. Any reference to an IBM product, program, or service is not intended to state or imply that only IBM's product, program, or service may be used. Any functionally equivalent product, program, or service that does not infringe any of IBM's intellectual property rights may be used instead of the IBM product, program, or service. Evaluation and verification of operation in conjunction with other products, except those expressly designed by IBM, is the user's responsibility.

This document contains general information, as well as requirements, for use on IBM and third-party products. IBM makes no warranty, express or implied, as to its completeness or accuracy, and the data contained herein is current only as of the date of publication. It assumes that the user understands the relationship among any affected systems, machines, programs, and media.

IBM or third parties may have patents or pending patent applications covering subject matter described in this document, including appearance design patents or applications. The furnishing of this document does not constitute or imply a grant of any license under any patents, patent applications, trademarks, copyright, or other rights of IBM or of any third party, or any right to refer to IBM in any advertising or other promotional or marketing activities. IBM assumes no responsibility for any infringement of patents or other rights that may result from use of this document or from the manufacture, use, lease, or sale of apparatus described herein.

Licenses under IBM's utility patents are available on reasonable and non-discriminatory terms and conditions. IBM does not grant licenses under its appearance design patents. Inquiries relative to licensing should be directed in writing to the IBM Director of Licensing, IBM Corporation, North Castle Drive, Armonk, New York 10504-1785, U.S.A.

---

## Trademarks

The following terms are trademarks of the IBM Corporation in the United States or other countries or both:

AS/400	AIX	AIX/ESA	Application System/400
Communications Manager	Current	DFSMSHsm	DFSMS/MVS
DFSMS/VM	ES/9000	ESCON	IBM
Magstar	MVS/ESA	MVS/XA	PAL
OS/400	POWERserver	POWERstation	RACF
RISC System 6000	SP2	System/360	System/370
VSE/ESA	VM/ESA	VTAM	400

The following terms are trademarks of other companies:

Ethernet	Xerox
Tri-Code	Wright Line Corporation
Tri-Optic	Engineered Data Products Corporation

---

## Communications Statements

### Federal Commission (FCC) Statement

This equipment has been tested and found to comply with the limits for a Class A digital device, pursuant to Part 15 of the FCC Rules. These limits are designed to provide reasonable protection against harmful interference when the equipment is operated in a commercial environment. This equipment generates, uses, and can radiate radio frequency energy, and if not installed and used in accordance with the instruction manual, may cause harmful interference to radio communications. Operation of this equipment in a residential area is likely to cause harmful interference, in which case the user will be required to correct the interference at his own expense.

Properly shielded, grounded and terminated cables and connectors must be used in order to meet FCC emission limits. IBM is not responsible for any radio or television interference caused by using other than recommended cables and connectors or by unauthorized changes or modifications to this equipment. Unauthorized changes or modifications could void the user's authority to operate the equipment.

This device complies with Part 15 of the FCC Rules. Operation is subject to the following two conditions: (1) this device may not cause harmful interference, and (2) this device must accept any interference received, including interference that may cause undesired operation.

### Industry Canada Compliance Statement

This digital apparatus does not exceed the Class A limits for radio noise emissions from digital apparatus as set out in the interference-causing equipment standard entitled: "Digital Apparatus," ICES-003 of Industry Canada.

### Avis de Conformité aux Normes d'Industrie Canada

Cet appareil numérique respecte les limites de bruits radioélectriques applicables aux appareils numériques de Classe A prescrites dans la norme sur le matériel brouilleur: "Appareils numériques," NMB-003 édictée par Industrie Canada.

### European Union (EU) Electromagnetic Compatibility Directive

This product is in conformity with the protection requirements of EU Council Directive 89/336/EEC on the approximation of the laws of the Member States relating to electromagnetic compatibility. IBM cannot accept responsibility for any failure to satisfy the protection requirements resulting from a non-recommended modification of the product, including the fitting of non-IBM option cards.

### Germany Electromagnetic Compatibility Directive

Dieses Gerät ist berechtigt in Übereinstimmung mit dem deutschen EMVG vom 9.Nov.92 das EG-Konformitätszeichen zu führen. Der AuBteller der Konformitätserklärung ist die IBM.

Dieses Gerät erfüllt die Bedingungen der EN 55022 Klasse A. Für diese Klasse von Geräten gilt folgende Bestimmung nach dem EMVG: Geräte dürfen an Orten, Für die sie nicht ausreichend entstört sind, nur mit besonderer Genehmigung des Bundesministers für Post und Telekommunikation oder des Bundesamtes für Post



und Telekommunikation betrieben werden. Die Genehmigung wird erteilt, wenn keine elektromagnetischen Störungen zu erwarten sind. (Auszug aus dem EMVG vom 9.Nov.92, Para.3, Abs.4)

### **Hinweis:**

Dieses Genehmigungsverfahren ist von der Deutschen Bundespost noch nicht veröffentlicht worden.

### **Japan Voluntary Control Council Information**

この装置は、情報処理装置等電波障害自主規制協議会（VCCI）の基準に基づく第一種情報技術装置です。この装置を家庭環境で使用すると電波妨害を引き起こすことがあります。この場合には使用者が適切な対策を講ずるよう要求されることがあります。

### **Taiwan Class A Statement**

警告使用者：  
這是甲類B 資訊產品，在居住的環境中使用時，可能會造成射頻干擾，在這種情況下，使用者會被要求採取某些適當的對策。

### **New Zealand, Australia (from AS/NZ 3548:1995)**

**Attention:** This is a Class A product. In a domestic environment this product may cause radio interference, in which case the user may be required to take adequate measures.

### **Canada**

This Class A digital apparatus meets all requirements of the Canadian Interference-Causing Equipment Regulations.

Cet appareil numérique de la classe A respecte toutes les exigences du Règlement sur le matériel brouilleur du Canada.

## **Laser Safety and Compliance**

The 3494 is a Class II Laser Product. It is important for the operator to be aware of the laser caution label. See Figure 170 on page 340 for an example of the label.

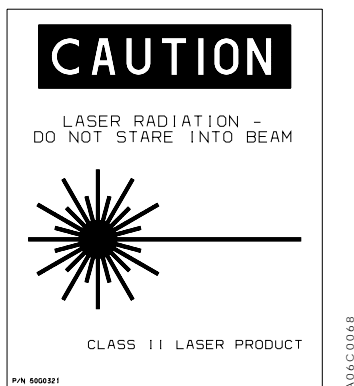

Figure 170. Laser Safety Caution Label

This product complies with the performance standards set by the U.S. Food and Drug Administration for a Class II Laser Product. This product belongs to a class of laser products that requires precautions be taken to avoid prolonged viewing of the laser beam. Under normal working conditions, you must not come in direct contact with the laser beam. This classification was accomplished by providing the necessary protective housings and scanning safeguards to ensure that laser radiation is inaccessible during operation or is within Class II limits. These products have been reviewed by external safety agencies and have obtained approvals to the latest standards as they apply to this product type.

## Operator Safety

The operator should remember the importance of safe operation when performing any of the tasks in this book. The operator should know the location and how to use the switches and controls on the IBM 3494 Tape Library.

### Safety Characteristics

The front doors on the library should not be opened during normal operation because of the moving components within the library. The doors have key locks to prevent the doors from being opened inadvertently. The 3494 includes integral safety control circuits that detect whether the doors are open or closed.

When a door is detected to be open, the power is removed from the cartridge accessor and the picker slowly descends. All host systems attached to the tape subsystems or through the RS-232 interfaces associated with the library are notified of the condition. This gives the operator a warning of a safety exposure and a warning of potential unauthorized access to the cartridges stored in the library.

---

## Glossary

This glossary defines the special terms, abbreviations, and acronyms used in this publication. If you do not find the term you are looking for, refer to the index or to *IBM Dictionary of Computing*, ZC20-1699.

## Numerics

**3490E.** Term used to mean a 3490E tape subsystem.

**3494.** See *Tape Library Dataserver*.

## A

**APPC.** Advanced Program-to-Program Communication. A form of LAN communication protocol.

**action bar.** In the library manager application, the area at the top of the primary window that contains keywords that give users access to actions available in that window. After users select a choice in the action bar, a pull-down extension is displayed.

**active accessor.** Accessor currently being used to move cartridges within the unit.

**active library manager.** Library manager controlling library operation.

**active window.** In the library manager, the window that is in current use and which receives keyboard input.

**advanced program-to-program communication (APPC).** A form of LAN communication protocol.

**auto mode.** An operating mode, whereby, the attached host systems directs the operation of the tape library without operator interaction.

**automatic cartridge loader (ACL).** A device that allows multiple cartridges to be loaded from a tape drive without operator intervention.

**available.** The term used to indicate that a component is available for use by the library manager. Components in the tape library (cartridge accessor, gripper, Convenience Input/Output Station, tape drives) are either available or unavailable for use. Compare with *Online*.

## B

**bar code.** A code representing characters by sets of parallel bars of varying thickness and separation.

**bar-code reader.** See *vision system*.

**barrier door.** Used, by service personnel, to separate the service bay from the main aisle of the 3494. This allows for concurrent service to the accessor and the associate hardware.

## C

**cartridge.** Term used to refer to either the IBM Cartridge System Tape or the IBM Enhanced Capacity Cartridge System Tape.

**cartridge accessor.** The physical mechanisms, within the tape library that identify, retrieve, and move tape cartridges. It consists of a bar-code reader and picker mechanism.

**cartridge automation.** The process where the tape library automatically performs actions for inserting, ejecting, mounting, demounting, loading, and unloading of tape cartridges.

**Cartridge System Tape.** The base tape cartridge media that is used with 3480 or 3490 Magnetic Tape Subsystems.

**category.** A grouping of volumes that have a common attribute, such as volumes to eject, volumes newly added to the library, and volumes to clean devices.

**caution notice.** A special note in text that calls attention to a situation that is potentially hazardous to people because of some existing situation. See also *Danger notice*.

**cell.** See *storage cell*.

**check box.** On the library manager screen, a control that consists of a displayed square box and selectable text. It acts like a switch.

**click.** With the library manager, the act of pressing a button on a pointing device while holding the pointing device pointer on the selected text. See also *double-click*.

**client area.** The area in the center of a window that contains the main information of the window.

**code.** The term used to refer to the internal programs that comprise the library manager application.

**command.** A control signal that initiates an action or the beginning of a sequence of actions.

**component.** A part of a functional unit; for example, the gripper mechanism is a component of the cartridge accessor.

**control program.** The program in the host system that schedules and supervises the execution of application programs.

**convenience input.** The term used when loading small numbers of tape cartridges into the tape library using the convenience input station.

**convenience input/output station.** The part of the tape library used to load and unload small numbers of cartridges into the tape library.

## D

**DCAF.** Distributed Console Access Facility. A LAN communication program.

**Danger notice.** A special note in text that calls attention to a situation that is potentially lethal or extremely hazardous to people. See also *Caution notice*.

**database.** A collection of data that can be accessed by a data processing system for a specific purpose.

**demount.** A host command to unload a cartridge from a tape drive.

**dialog box.** With the library manager, a moveable window, fixed in size, that requests information from the user.

**diskette.** A thin, flexible magnetic disk and a protective jacket, in which the disk is permanently enclosed. See also *hard disk*.

**Distributed Console Access Facility (DCAF).** A LAN communication program.

**double-click.** With the library manager, the act of pressing a pointing device button twice within a time limit while holding the pointing device pointer on the selected item. See also *click*.

**drop-down list.** A drop-down list only displays one item until the user takes an action to display the other objects or choices.

**dual active accessors (DAA).** The dual active accessors feature consists of two cartridge accessors and microcode which enables them to be active at the same time. Under normal operation, both accessors are active when this feature is installed.

**dual library manager.** The dual library manager consists of two library managers. Under normal operation, one library manager is the active library manager and the other library manager is the standby library manger.

**dump.** To record data, at a particular instant, for the purpose of safeguarding or analyzing.

## E

**EPO.** See *Emergency Power Off*.

**eject.** The operation of moving a cartridge to an output station in the tape library.

**Emergency Power Off (EPO).** A switch that removes all power from the equipment in the IBM 3494 Tape Library but does not affect power to lighting circuits.

**enable.** To provide the means or opportunity. The modification of system, control unit, or device action through the change of a software module or a hardware switch (circuit jumper) position.

**Enhanced Capacity Cartridge System Tape.** Cartridge system tape with increased capacity that can be used with 3490E enhanced capability models only. Visually identified by a two-tone cartridge case.

**Ethernet.** A local area network (LAN) that allows multiple stations to access a data transmission without prior coordination.

**Export.** The VTS Export operation allows logical volumes to be moved from a VTS to another VTS. The destination VTS can be in the same tape library or in a different tape library.

**Exported Stacked Volume.** A physical volume managed by a VTS that contains logical volumes that can be removed from the VTS.

## F

**file protected.** Pertaining to a tape volume from which data can be read only. Data cannot be written on or erased from the tape.

**frame.** (1) A housing for machine or device elements. (2) The hardware support structure, covers, and all parts mounted therein that are packaged as one entity for shipping.

## G

**grripper.** A part attached to the picker mechanism of the cartridge accessor that loads or unloads cartridges from storage cells and the Convenience Input/Output Station.

## H

**hard disk.** A rigid, non-removable disk residing in the library manager.

**high availability unit.** A second library manager and a second accessor.

**high-capacity output facility.** The part of the tape library used to unload large numbers of cartridges from the tape library.

**high-capacity input/output (I/O) facility.** The part of the tape library used to load/unload large numbers of cartridges from the tape library.

**home cell.** A fixed location that is assigned to a cartridge when it is first inserted into the library.

**home position.** A position the cartridge accessor goes to when entering Pause mode. Home position is located at the far left side of the control unit frame.

**host system.** A data-processing system that is used to prepare programs and the operating environments for use on another computer or controller.

## I

**IPL.** Initial program load.

**icon.** A pictorial representation of an object or a selection choice. Icons can represent objects that users want to work on or actions that users want to perform. See *system menu icon*.

**Import.** The VTS Import operation allows logical volumes to be moved to a VTS from another VTS. The source VTS can be in the same tape library or in a different tape library.

**improved data recording capability (IDRC).** A data recording mode that can increase the effective cartridge data capacity and the effective data rate if invoked.

**initial program load (IPL).** The initialization procedure that causes an operating system to commence operation.

**insert.** The operation of adding cartridges to the tape library. See also *eject*.

**internet protocol (IP).** A form of LAN communications protocol.

**inventory.** The operation of identifying the location of each tape cartridge contained in the tape library.

**invoke.** To start a command, procedure or program. The request for a feature or function to be utilized in future processing activities through the use of software or hardware commands.

## L

**light-emitting diode (LED).** (1) A semiconductor chip that gives off visible or infrared light when activated. (2) A light that signals a change in status or the presence of a certain predefined condition.

**library manager.** The controller for the IBM 3494 Tape Library. It manages the location of tape cartridges, monitors performance, issues commands to the hardware, displays status, and performs other functions. It communicates with host systems through the Library Attachment Facility in each 3490E Subsystem and provides operator and service panel functions.

**load.** (1) The process, performed by an operator or by the cartridge accessor, of placing a cartridge into a location within the tape library for later use or retrieval. (2) The term used when describing the action of the tape transport when it removes the leader block from a cartridge and threads the media through the internal tape path.

**local area network (LAN).** A computer network located on a user's premises within a limited geographical area. Communications within a LAN are not subject to external regulations; however, communications across a LAN boundary may be subject to regulation.

**logical library.** A logical library represents a set of tape volumes and tape drives that are a subset of all tape volumes and drives in a 3494 library. Each logical library within a 3494 library has a unique library sequence number identifying the logical library.

**logical volume.** A logical volume is a customer data volume which is stored on a stacked volume. A logical volume is not directly accessible by a host program. The volume serial number of the logical volume is not externally visible to a human or machine.

## M

**magazine.** A container residing in a storage frame. Each container consists of storage cells for holding tape cartridges.

**manual mode.** A mode of operation, where the operator, under the direction of the library manager, manually locates and moves cartridges to and from tape drives and storage cells. This mode allows data to be retrieved when normal tape library operations are interrupted by unexpected conditions.

**menu.** A panel containing a list of functions available for selection.

**mount.** A host command to load a cartridge into a tape unit.

**mount from input station.** A function available through the Commands pull-down on the library manager. It allows transient cartridges outside the library to be mounted on devices within the library and is used to support stand-alone programs that do not require the support of a full operating system.

## O

**OK.** With the library manager, a standard push button that causes the application to accept any changed information and close the dialog box.

**offline.** Pertaining to the operation of a unit when not under the direct control of a host system. Compare with *unavailable*. Contrast with *Online*.

**online.** Pertaining to the operation of a unit when under the direct control of a host system. Compare with *available*. Contrast with *Offline*.

## P

**panel.** (1) A control area on a machine that allows user interaction with the machine. (2) The information that is displayed on a screen.

**park.** An operation the cartridge accessor performs when entering Pause mode. The cartridge accessor moves to the home position and the picker lowers. See also *home position*.

**pause mode.** An operating mode, where by, all host requests that require movement of cartridges are queued until the tape library is returned to Auto mode. The cartridge accessor is parked and the library doors may be opened.

**picker.** The picker provides a mounting platform for the gripper and the bar-code reader.

**pop-up window.** On the library manager, a selectable window, in which users provide information that is required by an application so it can continue a user's request.

**primary window.** The window on the library manager screen in which the main dialog between users and the library manager takes place.

**pull-down.** An extension of the action bar that displays a list of choices available for a selected choice in the action bar. When an action bar selection is made the pull-down appears. Additional pop-up windows can appear from pull-down choices.

**push button.** On the library manager screen, a shaded rectangle, containing text and used in pop-up windows to initiate actions. Selecting a push button causes an action to take place immediately.

## R

**rack.** See *wall*.

**radio button.** On the library manager screen, a control that consists of a circle and text. Radio buttons are combined to show users a fixed set of choices that are

mutually exclusive. Clicking on a radio button causes that choice to be selected and all others in its group to be de-selected.

**remote library manager console.** The remote library manager console permits the 3494 library manager attachment to a customer-supplied local area network.

## S

**screen.** The viewing area of a workstation's display.

**secondary window.** A window, on the library manager, that is movable and sizeable and is always associated with a primary window.

**selection list.** On the library manager screen, a control that contains choices from which users can select one choice.

**service bays.** Frames attached to either end of the library to allow for storage and containment of the hot standby library controller and accessor.

**setup.** The preparation of a computing system to perform a job or job step.

**shortcut key.** A combination of keys that a user can press to perform an action that is available from a menu. For example, Ctrl+C causes the library manager to display the task list.

**Stacked Volume.** A stacked volume is a physical volume which is exclusively managed by a Virtual Tape Server and contains one or more logical volumes. It is not a customer accessible volume.

**standby accessor.** The accessor not currently being used to move cartridges when the high availability unit is installed.

**standby library manager.** The standby Library Manager can take control of all operations in the 3494. Its hardware consists of a controller, display, pointing device, and a keyboard. This feature is available with the high availability unit.

**storage.** (1) A device into which recorded information can be entered, retained, and processed, and from which it can be retrieved. (2) The action of placing data into a storage device. (3) A facility in which data can be retained.

**storage cell.** A location in the tape library where a cartridge can be loaded or unloaded. This includes the storage cells in a storage frame and the convenience input/output station.

**system menu.** On the library manager screen, the pull-down in the top left-hand corner of a window that allows users to restore, close, move, size, minimize, and maximize the window. The system menu is referenced by the system menu icon.

**system menu icon.** The term for the symbol found in the top left-hand corner of some windows that is used to control the presence and appearance of those windows. See *system menu*.

## T

**TCP.** Transmission control protocol. A form of LAN communications protocol.

**TCP.** Telecommunications Carrier Products. A form of LAN communications protocol.

**tape drive.** A device that is used for moving magnetic tape and includes the mechanisms for writing and reading data to and from tape. See also *tape unit* and *transport*.

**tape library.** A term used to refer to the customer's collection of tapes. Within the IBM 3494 Tape Library, this simply means the set of cartridges contained within the enclosure.

**tape library dataserwer.** An automated tape library consisting of mechanical components, cartridge storage frames, IBM tape subsystems, and controlling hardware and software. The tape library dataserwer performs tape cartridge mounts and demounts without operator intervention.

**tape management software.** A program that controls the scratch status of tape volumes.

**tape unit.** A device that contains tape drives and their associated power supplies and electronics.

**tape volume cache.** The Tape Volume Cache is a major component of a Virtual Tape Server and is a combination of RAID DASD, RAM buffering and internal licensed code that stores and manages virtual volumes.

**teach.** The process that allows the library manager, using the cartridge accessor, to *learn* the exact physical locations of each major unit within the tape library.

**telecommunications carrier products (TCP).** A form of LAN communications protocol.

**title bar.** The area at the top of each window that contains the window title and system-menu icon. When appropriate, it also contains the minimize, maximize, and restore icons.

**token-ring network.** A local area network (LAN) that uses ring topology, where tokens are passed from node to node. A node that is ready to send can capture a token and insert data for transmission.

**transient cartridges.** Cartridges that reside in a customer's library that are not stored within the confines of the automated tape library and are not recorded as part of the automated library's inventory.

**transient mount.** See *mount from input station*.

**transmission control protocol (TCP).** A form of LAN communications protocol.

**transport.** The mechanism inside a tape drive that moves tape media. It is comprised of loading, threading and guiding mechanisms and motors.

## U

**unavailable.** A term used to indicate that a component in the tape library (for example, the cartridge accessor) is unavailable for use by the library manager. Compare with *Offline*. Contrast with *available*.

**unit.** (1) An entity capable of accomplishing a specific purpose; for example, a 3490E tape drive. (2) An individual piece of the tape library that can be added or deleted from a tape library configuration, for example, 3490E control unit, 3490E tape unit, storage frame, or Convenience Input/Output Station.

**unit emergency power off (UEPO).** The 3494 switch that, when operated in an emergency, cause the 3494 to be disconnected from the ac power source.

**unit power off (UPO).** A switch that removes all power from a specific units of the tape library.

**unload.** To remove cartridges from a 3490E drive.

## V

**VTAM.** Virtual Telecommunications Access Method. A form of LAN communication protocol.

**VTS.** A Virtual Tape Server is comprised of a Virtual Tape Server controller, 3590 tape devices and the 3494 Tape Library. Together they manage the utilization of the cartridge storage capacity and performance capabilities of the 3590 tape technology transparently to host software and applications.

**virtual tape drive.** A virtual tape drive is a representation of the functionality of a 3490E class tape drive as viewed by the host control program. The data from/to the drive is directed to the Tape Volume Cache and all drive related commands are emulated through the internal licensed code in the Virtual Tape Server controller.

**virtual tape server (VTS).** A Virtual Tape Server is comprised of a Virtual Tape Server controller, 3590 tape devices and the 3494 Tape Library. Together they manage the utilization of the cartridge storage capacity and performance capabilities of the 3590 tape technology transparently to host software and applications.

**virtual volume.** A virtual volume is a customer accessible volume that exists in the Tape Volume Cache

of a Virtual Tape Server. When a virtual volume is copied from the Tape Volume Cache to a stacked volume it becomes a logical volume. When a logical volume is recalled from a stacked volume to the Tape Volume Cache it becomes a virtual volume.

**virtual telecommunications access method (VTAM).**

Virtual Telecommunications Access Method. A form of LAN communication protocol.

**vision system.** A Class II laser bar-code reader used to identify tape cartridge labels and other features in the 3494.

**volser.** Volume serial identifier. The physical label on the cartridge. Also, the same or different identifier encoded on the magnetic tape.

**volume.** See *cartridge*.

## W

**wall.** Walls located inside the library house the cartridge storage cells. The walls on the front doors of the library are labeled with even numbers and the walls on the rear of the library are labeled with odd numbers.



# Index

## Numerics

30 cell I/O 78, 80  
3490E  
    emulation of the tape drive 41  
3494  
    CHECK-1 condition state 261  
3590 1, 37

## A

accessors 106  
accessors, disable dual active 107  
accessors, enable dual active 107  
administrator, system password 200  
advanced operating procedures 85, 259  
Auto mode, changing to 76  
auto selection 100

## B

basic operating procedures 75, 85

## C

Cancel Export/Import 207  
cartridge.  
    3494 tape library 25  
    cell location 24  
    convenience input/output station 17  
    dismounting 232  
    ejecting 234  
    file protection 20  
    high-capacity output facility 16  
    initial installation  
        cleaner volumes 58  
        customer volumes 58  
        service volume 58  
    input facility 16  
    inserting 77, 232  
    labeling 22, 23  
    labels 20  
    mounting 231  
    output facility 16  
    removing ejected 81  
    requirements 19  
    reserved storage cells 25  
    single-cell output facility 17  
    storage capacity 25  
    storage cells 24  
    system tape  
        description 18  
        requirements 19  
    transient 58, 181  
cartridge placement guidelines 59  
category  
    mount from 55  
    volume 48  
cell location 24

changing  
    modes  
        auto 100  
        manual 101  
        pause 100  
        password 200  
characteristics  
    operational 41  
    safety 340  
CHECK-1 condition 261  
clean schedule panel controls 156  
cleaner  
    cartridge  
        eject 158  
        end-of-life 156  
        volume masks 172  
cleaning selection, schedule 155  
command  
    priorities 54  
    promote in the queue selection 160  
commands pull-down 152  
component availability selection 115  
console, remote library manager  
    changing sessions 249  
    configuring 242  
    distributed console access facility 241, 242  
    feature 46, 241  
    hot-keys 248  
    installing 242  
    keystrokes 246, 247  
    library manager operations  
        changing password 255  
        changing session states 253  
        moving among sessions 253  
        problem analysis 257  
        tips 257  
    transferring files 253  
control unit frame 2  
controls  
    description 31  
    host control 59  
    library manager 34, 88  
    operator panel 32, 38  
convenience input/output station 2, 4

## D

database  
    information 28  
    pull-down 139  
database volumes, list 145  
dismounting cartridges 232  
DFSMS messages 268  
DFSMS/MVS environment, library manager failure 261  
disable dual active accessors 107  
disable inventory update 47, 153  
displaying  
    drive message, using 231

displaying (*continued*)  
  search results selection 143  
distributed console access facility 241, 242  
drive unit frame 2  
dual active accessors, disable 107  
dual active accessors, enable 107  
dual-write status 274

## E

eject stacked 153, 166  
ejected cartridges, removing 81, 234  
enable dual active accessors 107  
error  
  processing 236  
error detection and reporting. 47

## F

facilities  
  cartridge input and output 16  
  convenience input/output station 17  
  high-capacity output 16  
  single-cell output 17  
fixed home cell mode 65  
floating home cell mode 65  
frames  
  control unit 2  
  drive unit 2  
  storage unit 2  
functional components 4, 6

## H

help  
  action bar and function keys 95, 98  
  pull-down, using 94  
  search 95  
high-capacity output facility 16  
High Performance Cartridge Tape 1  
home cell mode  
  fixed 65  
  floating 65  
  locating and identifying locations 237  
host  
  consoles selection, send message 159  
  operation control 59  
hot-keys 246, 247

## I

identifying home cell locations 237  
indicators  
  convenience input/output station 33  
  description 31  
  motion controls 32  
  operator panel 32, 38  
  status 32, 38  
  tape subsystem 35, 37  
informational state transitions 73  
informational states 67

initial  
  cartridge installation 58  
  volume inventory upload 59  
insert logical 153, 164  
insert logical status 165  
inserting cartridges  
  in Auto mode 77  
  in Manual mode 232  
initial installation  
  cleaner volumes 58  
  customer volumes 58  
  service volumes 58  
  unlabeled 184  
intervention, operator 199  
introduction 1  
inventory  
  new storage 169  
  status 173  
  update 47  
inventory update 47

## K

keyboard  
  selecting with 92  
  template  
    diagram 305, 314  
    using 240  
keystrokes 246, 247

## L

label, cartridge 20  
library manager  
  component availability status window 279  
  database information 28, 29  
  display location 34  
  information provided at console 276  
  keyboard location 34  
  making selections  
    description 92  
    keyboard 92  
    pointing device 92  
  messages, action based 277, 281  
  operator  
    menu, using 98  
    panel controls 89  
  password-protection 27  
  search database for volumes window 279  
  system summary window, using 277  
  user interface  
    general operator 27  
    service representative 27  
    system administrator 27  
  using 88  
  whole queue window, using 282  
library manager failure, DFSMS/MVS environment 261  
library manager failure, MVS/BTLS environment 265  
library manager recovery procedures 261  
List database volumes 145  
local area network 6, 47, 241  
locating home cell locations 237

location, cartridge cell 24

## M

Manage Export-Hold Volumes 206

Manage Import Volumes 204, 205

Manage Unassigned Volumes 202

Manual mode

ending 238

operating in 230

selection 101

starting 228

using 227

media

3494 tape library 25

cell location 24

convenience input/output station 17

demounting 232

ejecting 234

file protection 20

high-capacity output facility 16

initial installation

cleaner volumes 58

customer volumes 58

service volume 58

input facility 16

inserting 77, 232

labeling 22, 23

labels 20

mounting 231

output facility 16

removing ejected 81

requirements 19

reserved storage cells 25

single-cell output facility 17

storage capacity 25

storage cells 24

system tape

description 18

requirements 19

transient 58, 181

messages, host console 268

modes

changing 32, 68, 99

fixed home cell 65

floating home cell 65

pull-down 99

relationship between modes and states 68

mount from input station 58, 181

mounting cartridges 231

MVS/BLTS environment, library manager failure 265

## N

notices 337

## O

Offline selection 103

Online selection 101

operating procedures

advanced 85, 259

operating procedures (*continued*)

basic 75, 85

Manual mode 230

operational

characteristics 41

informational 67

informational transitions 73, 75

mode transitions 68, 71

modes 63

safety 340

state transitions 71, 73

states 65

status selection 111

tips 257

operations

audit 56

demount 56

host control 59

mount 55

operator

actions 199

intervention 199

involvement 46

menu, using library manager 98

panel 32, 38

pop-up window 200

procedures 75, 85

safety 340

options pull-down 226

output facility

high-capacity 16

single-cell 17

## P

password

protection 27

system administrator 200

Pause mode, changing to 76

Pause selection 100

performance statistics selection 119

placement, cartridge 59

pointing device, selecting with 92

power

controls 32, 38

local 32, 45

local to remote, changing from 76

remote 32, 45

remote to local, changing from 76

unit emergency power 32, 38, 75

unit power switch 32, 75

powering on or off the 3494 75

preface 1

priority levels 54

problem determination

search database for volumes window 279

system summary window, using 277

tips 257

problem determination procedures 259

problem determination procedures 259

- pull-downs
  - commands selection 152
  - database 139
  - help 94
  - menu selections 98
  - mode 99
  - options 226
  - queues 137
  - status selection 109

## Q

- queues pull-down 137

## R

- recovery procedures 261
  - DFSMS/MVS environment 261
  - dual library manager 261
  - MVS/BTLS environment 265
  - single library manager 261
- reinventy complete system selection 169
- remote library manager console
  - changing sessions 249
  - configuring 242
  - distributed console access facility 241, 242
  - feature 46, 241
  - hot-keys 248
  - installing 242
  - keystrokes 246, 247
  - library manager operations
    - changing password 255
    - changing session states 253
  - moving among sessions 253
  - problem analysis 257
  - tips 257
  - transferring files 253
- removing ejected cartridges 81
- reserved storage cells 25

## S

- safety
  - characteristics 340
  - laser 339
  - operator 339
- search
  - entry field selection 140
  - results selection 142
- service selection 104
- shutdown selection 108
- single-cell output facility 17
- snmp 208
- stand-alone device
  - operations 57
  - reset 182
  - setup 180
  - status 183
- states
  - 3494 CHECK-1 condition 261
  - informational 67

- states (*continued*)
  - operational 65
  - relationship between modes and states 68
  - volume 52
- status pull-down 109
- storage
  - cartridge capacity 25
  - cartridge cells 24
  - reserved cartridge cells 25
  - unit frame 2
- Switch Active Accessor to Standby 106
- switch active library manager to standby 105
- system
  - administrator
    - involvement 46
    - password 200
  - summary
    - pop-up window 98
    - problem determination window 277
    - selection 131

## T

- tape
  - 3494 tape library 25
  - cell location 24
  - convenience input/output station 17
  - demounting 232
  - ejecting 234
  - file protection 20
  - high-capacity output facility 16
  - initial installation
    - cleaner volumes 58
    - customer volumes 58
    - service volume 58
  - input facility 16
  - inserting 77, 232
  - labeling 22, 23
  - labels 20
  - mounting 231
  - output facility 16
  - removing ejected 81
  - requirements 19
  - reserved storage cells 25
  - single-cell output facility 17
  - storage capacity 25
  - storage cells 24
  - system tape
    - description 18
    - requirements 19
    - transient 58, 181
- tape subsystem, 3490E 1, 35
- tape subsystem, 3590 1, 37
- tape subsystem controls 35, 37
- tips
  - operational 257
  - problem determination 257
- trademarks 337
- transient cartridges 58, 181
- transitions
  - informational 73, 75

transitions *(continued)*  
mode 68, 71  
operational state 71, 73

## U

unlabeled cartridges 20, 22, 184

## V

volser ranges 153, 162  
volser validity checking 52  
volume  
categories 48  
cleaner masks 158, 172  
initial inventory upload 59  
reviewing unknown locations 235  
states 52  
VTS category attributes 153, 167  
VTS management policies 153, 169

## W

whole queue window, using 279  
write, dual 274



---

# Readers' Comments — We'd Like to Hear from You

Magstar 3494 Tape Library  
Operator Guide

Publication No. GA32-0280-09

Overall, how satisfied are you with the information in this book?

	Very Satisfied	Satisfied	Neutral	Dissatisfied	Very Dissatisfied
Overall satisfaction	<input type="checkbox"/>	<input type="checkbox"/>	<input type="checkbox"/>	<input type="checkbox"/>	<input type="checkbox"/>

How satisfied are you that the information in this book is:

	Very Satisfied	Satisfied	Neutral	Dissatisfied	Very Dissatisfied
Accurate	<input type="checkbox"/>	<input type="checkbox"/>	<input type="checkbox"/>	<input type="checkbox"/>	<input type="checkbox"/>
Complete	<input type="checkbox"/>	<input type="checkbox"/>	<input type="checkbox"/>	<input type="checkbox"/>	<input type="checkbox"/>
Easy to find	<input type="checkbox"/>	<input type="checkbox"/>	<input type="checkbox"/>	<input type="checkbox"/>	<input type="checkbox"/>
Easy to understand	<input type="checkbox"/>	<input type="checkbox"/>	<input type="checkbox"/>	<input type="checkbox"/>	<input type="checkbox"/>
Well organized	<input type="checkbox"/>	<input type="checkbox"/>	<input type="checkbox"/>	<input type="checkbox"/>	<input type="checkbox"/>
Applicable to your tasks	<input type="checkbox"/>	<input type="checkbox"/>	<input type="checkbox"/>	<input type="checkbox"/>	<input type="checkbox"/>

Please tell us how we can improve this book:

Thank you for your responses. May we contact you?  Yes  No

When you send comments to IBM, you grant IBM a nonexclusive right to use or distribute your comments in any way it believes appropriate without incurring any obligation to you.

\_\_\_\_\_  
Name

\_\_\_\_\_  
Address

\_\_\_\_\_  
Company or Organization

\_\_\_\_\_  
Phone No.



Fold and Tape

Please do not staple

Fold and Tape



NO POSTAGE  
NECESSARY  
IF MAILED IN THE  
UNITED STATES

# BUSINESS REPLY MAIL

FIRST-CLASS MAIL PERMIT NO. 40 ARMONK, NEW YORK

POSTAGE WILL BE PAID BY ADDRESSEE

International Business Machines Corporation  
Information Development  
Department GZW  
9000 South Rita Road  
Tucson, AZ 85775-4401



Fold and Tape

Please do not staple

Fold and Tape







Printed in the United States of America  
on recycled paper containing 10%  
recovered post-consumer fiber.

GA32-0280-09



## Free Manuals Download Website

<http://myh66.com>

<http://usermanuals.us>

<http://www.somanuals.com>

<http://www.4manuals.cc>

<http://www.manual-lib.com>

<http://www.404manual.com>

<http://www.luxmanual.com>

<http://aubethermostatmanual.com>

Golf course search by state

<http://golfingnear.com>

Email search by domain

<http://emailbydomain.com>

Auto manuals search

<http://auto.somanuals.com>

TV manuals search

<http://tv.somanuals.com>