

NEC

User's Manual

PG-FP3

Flash Memory Programmer

Document No. U13502EJ2V0UM00 (2nd edition)

Date Published July 1999 J CP(K)

© NEC Corporation 1998

Printed in Japan

[MEMO]

SUMMARY OF CONTENTS

CHAPTER 1	GENERAL	17
CHAPTER 2	CONFIGURATION.....	19
CHAPTER 3	STARTING AND STOPPING	27
CHAPTER 4	BASIC OPERATING PROCEDURE.....	37
CHAPTER 5	COMMAND REFERENCE.....	45
CHAPTER 6	STAND-ALONE FUNCTION	67
CHAPTER 7	HARDWARE SPECIFICATIONS.....	69
CHAPTER 8	ERROR MESSAGES AND REMEDIAL ACTIONS	87
APPENDIX A	NOTES ON DESIGNING A TARGET	91
★ APPENDIX B	REVISION HISTORY	93

EEPROM is a trademark of NEC Corporation.

PC/AT is a trademark of International Business Machines Corporation.

Windows and Windows NT are either registered trademarks or trademarks of Microsoft Corporation in the United States and/or other countries.

Pentium is a trademark of Intel Corporation in the United States.

- **The information in this document is subject to change without notice. Before using this document, please confirm that this is the latest version.**
- No part of this document may be copied or reproduced in any form or by any means without the prior written consent of NEC Corporation. NEC Corporation assumes no responsibility for any errors which may appear in this document.
- NEC Corporation does not assume any liability for infringement of patents, copyrights or other intellectual property rights of third parties by or arising from use of a device described herein or any other liability arising from use of such device. No license, either express, implied or otherwise, is granted under any patents, copyrights or other intellectual property rights of NEC Corporation or of others.
- Descriptions of circuits, software, and other related information in this document are provided for illustrative purposes in semiconductor product operation and application examples. The incorporation of these circuits, software, and information in the design of the customer's equipment shall be done under the full responsibility of the customer. NEC Corporation assumes no responsibility for any losses incurred by the customer or third parties arising from the use of these circuits, software, and information.

M7A 98.8

Regional Information

Some information contained in this document may vary from country to country. Before using any NEC product in your application, please contact the NEC office in your country to obtain a list of authorized representatives and distributors. They will verify:

- Device availability
- Ordering information
- Product release schedule
- Availability of related technical literature
- Development environment specifications (for example, specifications for third-party tools and components, host computers, power plugs, AC supply voltages, and so forth)
- Network requirements

In addition, trademarks, registered trademarks, export restrictions, and other legal issues may also vary from country to country.

NEC Electronics Inc. (U.S.)

Santa Clara, California
Tel: 408-588-6000
800-366-9782
Fax: 408-588-6130
800-729-9288

NEC Electronics (Germany) GmbH

Duesseldorf, Germany
Tel: 0211-65 03 02
Fax: 0211-65 03 490

NEC Electronics (UK) Ltd.

Milton Keynes, UK
Tel: 01908-691-133
Fax: 01908-670-290

NEC Electronics Italiana s.r.l.

Milano, Italy
Tel: 02-66 75 41
Fax: 02-66 75 42 99

NEC Electronics (Germany) GmbH

Benelux Office
Eindhoven, The Netherlands
Tel: 040-2445845
Fax: 040-2444580

NEC Electronics (France) S.A.

Velizy-Villacoublay, France
Tel: 01-30-67 58 00
Fax: 01-30-67 58 99

NEC Electronics (France) S.A.

Spain Office
Madrid, Spain
Tel: 91-504-2787
Fax: 91-504-2860

NEC Electronics (Germany) GmbH

Scandinavia Office
Taebby, Sweden
Tel: 08-63 80 820
Fax: 08-63 80 388

NEC Electronics Hong Kong Ltd.

Hong Kong
Tel: 2886-9318
Fax: 2886-9022/9044

NEC Electronics Hong Kong Ltd.

Seoul Branch
Seoul, Korea
Tel: 02-528-0303
Fax: 02-528-4411

NEC Electronics Singapore Pte. Ltd.

United Square, Singapore 1130
Tel: 65-253-8311
Fax: 65-250-3583

NEC Electronics Taiwan Ltd.

Taipei, Taiwan
Tel: 02-2719-2377
Fax: 02-2719-5951

NEC do Brasil S.A.

Electron Devices Division
Rodovia Presidente Dutra, Km 214
07210-902-Guarulhos-SP Brasil
Tel: 55-11-6465-6810
Fax: 55-11-6465-6829

J99.1

Major Revisions in This Edition

Page	Description
p.18	The setting of the baud rate and the capacity for downloading the user program in Table 1-1 have been changed.
p.19	Figure 2-1 has been changed.
p.20	Figure 2-2 has been changed.
p.20	The description of EXPANSION CONNECTOR has been deleted from Section 2.2 .
p.28	A description in Section 3.1 has been changed.
p.30	A description in Section 3.2 has been changed.
p.36	A description has been added to "Option setting" in Section 3.3 .
p.46	A description has been added to Section 5.1.2 .
p.50	A description in Section 5.2.2 has been changed.
p.58	A description in Section 5.3.2 has been changed.
p.59	A description in Section 5.3.3 has been changed.
p.61	A description in Section 5.3.4 has been changed.
p.62	A description in Section 5.3.5 has been changed and Caution has been added to Section 5.3.5 .
p.62	A description in Section 5.3.6 has been changed.
p.65	A description in Section 5.4.3 has been changed.
p.72	A description in "Supported ROM specifications" in Section 7.2 has been changed.
p.73	A description has been deleted from Section 7.3 .
p.77	The setting of the baud rate in Table 7-4 has been changed.
p.91	Figure A-1 has been changed.
p.92	Figure A-2 has been changed.
p.93	Appendix B has been added.
p.41 in the first edition	Section 5.3.2 has been deleted.
p.46 in the first edition	Section 5.3.7 has been deleted.
p.53 in the first edition	Section 5.4.6 has been deleted.
p.75 in the first edition	Section 7.5 has been deleted.

The mark ★ shows major revised points.

[MEMO]

PREFACE

Readers of This Manual This manual is intended for user engineers who use the PG-FP3 to design and develop systems with an NEC microcontroller with flash memory.

Purpose The PG-FP3 enables programs in the NEC microcontroller with flash memory to be erased, written, or verified with the microcontroller mounted on a user-designed printed circuit board through simple operations on a Windows™ screen.

This manual contains the basic PG-FP3 specifications and explains how to use the PG-FP3.

Organization This manual contains the following chapters:

General, Configuration, Starting and Stopping, Basic Operating Procedure, Command Reference, Stand-alone Function, Hardware Specifications, and Error Messages and Remedial Actions

How to Read This Manual To understand the basic specifications and operation of the PG-FP3, read this manual in the order given in the table of contents. Be sure to read **Chapter 3**, which contains important information on operating the PG-FP3.

It is assumed that the readers of this manual have a basic knowledge of electricity, logic circuits, and microcontrollers. It is also assumed that, especially in the description of applications, they have sufficient knowledge of Windows. For information on using Windows 95 and Windows NT™ and for the related terminology, refer to the appropriate Windows manual.

Legend

Note	: Explanation of the item so marked
Caution	: Important information
Remark	: Supplementary explanation
Numeric notation	: Binary xxxx or xxxxB
	Decimal xxxx
	Hexadecimal.... 0xxxxH or xxxxH

Terminology

PG-FP3	Flash memory programmer
FLASHPRO3	Windows application name of PG-FP3
Target	NEC microcontroller with flash memory or user board on which such a microcontroller is mounted
Printer interface (IEEE 1284) ...	Parallel interface specified by IEEE 1284-1994. Used by the PG-FP3 as one of the host interfaces.
FA adapter	Adapter board used to write programs to an NEC microcontroller with flash memory ^{Note}

Note The FA adapter board is a product of Naito Densai Machida Mfg. Co., Ltd.
<Telephone number>
Naito Densai Machida Mfg. Co., Ltd.: 044-822-3813

CONTENTS

CHAPTER 1 GENERAL	17
CHAPTER 2 CONFIGURATION.....	19
2.1 PRODUCT ORGANIZATION	19
2.2 NAMES AND FUNCTIONS OF PARTS.....	20
2.3 CONNECTIONS OF PARTS.....	22
CHAPTER 3 STARTING AND STOPPING	27
3.1 INSTALLING THE APPLICATION.....	27
3.2 STARTING THE APPLICATION.....	30
3.3 INITIALIZATION AND NOTES ON CORRECT USE	33
3.4 TERMINATING THE APPLICATION	36
CHAPTER 4 BASIC OPERATING PROCEDURE	37
CHAPTER 5 COMMAND REFERENCE.....	45
5.1 File.....	45
5.1.1 Load File.....	45
5.1.2 Save File.....	46
5.1.3 Load Type.....	47
5.1.4 Save Type	48
5.1.5 Exit.....	48
5.2 Setting.....	49
5.2.1 Device.....	49
5.2.2 Type.....	50
5.2.3 Voltage	54
5.2.4 Option	55
5.2.5 Reset	55
5.2.6 Connection Port.....	56
5.3 Procedure.....	57
5.3.1 Download HEX	57
★ 5.3.2 Erase	58
★ 5.3.3 Program.....	59
★ 5.3.4 Verify	61
★ 5.3.5 E.P.V.	62
★ 5.3.6 Chip set/Block set/Area set	62
5.4 Other.....	64
5.4.1 Signature	64
5.4.2 Status	64
★ 5.4.3 Dump HEX.....	65
5.4.4 Supply Status	66
5.4.5 PROM Load.....	66
5.5 Help.....	66

CHAPTER 6 STAND-ALONE FUNCTION	67
6.1 FUNCTION	67
6.2 OPERATION	68
CHAPTER 7 HARDWARE SPECIFICATIONS.....	69
7.1 PRODUCT CONFIGURATION AND OPERATING ENVIRONMENT.....	69
7.2 MASTER ROM SOCKET SPECIFICATIONS	70
★ 7.3 HOST INTERFACE	73
7.3.1 Printer Interface Specifications	73
7.3.2 RS-232C Interface Specifications	77
7.4 TARGET INTERFACE SPECIFICATIONS	80
7.4.1 Interface Specifications.....	81
7.4.2 Equivalent Circuit and Load Condition.....	84
CHAPTER 8 ERROR MESSAGES AND REMEDIAL ACTIONS	87
APPENDIX A NOTES ON DESIGNING A TARGET	91
APPENDIX B REVISION HISTORY.....	93

LIST OF FIGURES

Figure No.	Title	Page
2-1.	PG-FP3 System Organization	19
2-2.	PG-FP3 Parts and Names	20
3-1.	FLASHPRO3 Screens	32
3-2.	Parameter File Setting Dialog Box.....	33
3-3.	TYPE Setting Dialog Box (When the Parameter File Is Loaded).....	34
3-4.	TYPE Setting Dialog Box (When the Parameter File Is Not Loaded)	34
4-1.	Communication Error Dialog Box	38
5-1.	File Format Select Dialog Box	46
5-2.	Mode Screens.....	63
5-3.	Editor Screen.....	65
7-1.	Pin Configuration (Top View).....	72
7-2.	Communication Error Dialog Box	77
A-1.	Interface Circuit Example for a UART.....	91
A-2.	Interface Circuit Example for SIO	92

LIST OF TABLES

Table No.	Title	Page
1-1.	Function Specifications	18
2-1.	Items in the PG-FP3 Shipping Carton.....	19
7-1.	Product Configuration and Operating Environment	69
7-2.	Pin List	72
7-3.	Printer Interface Specifications	73
7-4.	RS-232C Interface Specifications	77
7-5.	Withstand Voltage of Each Interface Signal.....	80

LIST OF PHOTOGRAPHS

Photo No.	Title	Page
2-1.	Connections (Host, PG-FP3, and Target).....	22
2-2.	Connecting the Printer Interface Cable (I/F SELECT Switch Set to PRINTER I/F Position)	23
2-3.	Connecting RS-232C (I/F SELECT Switch Set to RS-232C Position).....	23
2-4.	Connecting the AC Adapter	24
2-5.	Connecting Target Cable to PG-FP3 <1>.....	24
2-6.	Connecting Target Cable to User Target.....	25
2-7.	Connecting Target Cable to PG-FP3 <2>.....	25
2-8.	Connecting Target Cable to FA Adapter.....	26
2-9.	Directly Connecting FA Adapter to PG-FP3	26
3-1.	Starting the PG-FP3	30
4-1.	Connection of Host, PG-FP3, and Target.....	37
6-1.	Selecting the Command Mode	68
7-1.	Mounting the Master ROM.....	70
7-2.	Mounting the PROM in the Master ROM Socket	71
7-3.	Executing the [PROM Load] Command.....	71

[MEMO]

CHAPTER 1 GENERAL

The PG-FP3 is a tool for erasing, writing, and verifying programs for an NEC single-chip microcontroller with flash memory on a user board or FA adapter board.

◆ Features

- Supports all NEC microcontrollers with flash memory (as of February 1999)
- Easy to use in stand-alone mode (with PG-FP3 only) or on Windows 95 or Windows NT using a dedicated application (PG-FP3)
- Compact, portable design the size of a sheet of A5 paper
- Has a printer interface (parallel interface) in addition to the standard RS-232C interface. Downloads user programs quickly.
- Supports high-capacity microcontrollers^{Note} that are expected to be available in the future as well as flash memory of 2 Mbytes

Note Support of microcontrollers developed in the future may require PG-FP3 firmware and application upgrades.

◆ Function specifications

Table 1-1. Function Specifications

Item	Specification
★ Host interface	RS-232C: D-SUB 25-pin, 9600, 19200, 38400, or 57600 bps Printer interface ^{Note 1} : Half-pitch 36-pin conforming to IEEE 1284-1994 (Supports compatible mode and ECP mode.) The interface can be selected with the I/F SELECT switch.
Target interface ^{Note 2}	Connector: D-SUB 9-pin (receptacle) Level conversion: Within target V _{DD} input range (1.8 to 5.5 V) Protection function: Overvoltage input protection circuit (guaranteed range: 15 V max.) Supported interface: 3-wire, 3-wire + handshake (Max. SCK: 2.0 MHz) Pseudo 3-wire (Max. SCK: 2.0 MHz) UART (Max. bps: 76800 bps) IIC (Max. SCK: 50 kHz)
Supply voltage ^{Note 3}	Target V _{PP} supply voltage: 2.7 to 10.3 V, max.: 200 mA Target V _{DD} supply voltage: 1.8 to 6.0 V, max.: 200 mA Whether power is supplied from the PG-FP3 or from the user target can be selected with the TARGET V _{DD} switch. An overcurrent protection circuit is provided for both V _{PP} and V _{DD} .
Supply voltage input	Target V _{DD} supply voltage input: 1.8 to 5.5 V, current consumption: 100 mA max.
CPU clock supply	A 16-, 8-, 4-, or 2-MHz clock can be selected as the target CPU clock. The on-board target clock can be also used depending on the application settings. (PG-FP3-side interface: CMOS level output)
★ Master ROM	A PROM (CMOS, 32-pin) to which the user program is written can be inserted in the master ROM socket to allow the user program to be downloaded (max.: 500 kbytes).
Stand-alone	Programming with only the PG-FP3. Functions such as E.P.V., ERASE, PROGRAM, VERIFY, and LOAD can be selected and executed with the MODE Key.

Notes 1. Only supported for Windows 95.

2. The maximum communication rate of the interface varies depending on the device used and the environment.

3. V_{DD} is supplied to the target system to supply power to the device to which a program is to be written. The power is not enough to operate the target system of the user. Use the power supply on the target for on-board program writing.

CHAPTER 2 CONFIGURATION

2.1 PRODUCT ORGANIZATION

The system configuration of the PG-FP3 is illustrated below.

★

Figure 2-1. PG-FP3 System Organization

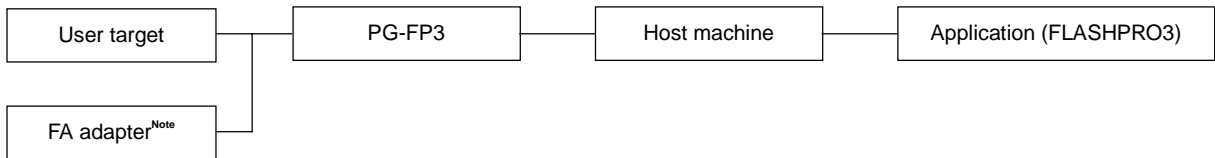

Note The FA adapter is a product of Naito Densai Machida Mfg. Co., Ltd.

The PG-FP3 shipping carton contains the following items:

Table 2-1. Items in the PG-FP3 Shipping Carton

Item	Qty	Remarks
PG-FP3	1	PG-FP3
Floppy disk	1	Application software
AC adapter	1	Power supply
Printer cable	2	One for a PC-9800 and one for PC/AT™ or compatible machine
Target cable	2	Type 1 (IC clip) and Type 2 (connector)
User's Manual	1	This manual
Packing list	1	Packing list for this product
Warranty	1	

The PG-FP3 is shipped with the above accessories. Make sure that all accessories have been provided by checking the contents of the box against the above table when you unpack the box. If any part or accessory is missing or is damaged, notify NEC.

To use RS-232C as the host interface, you will need a commercially available RS-232C straight cable.

2.2 NAMES AND FUNCTIONS OF PARTS

Parts and their names are illustrated below.

★

Figure 2-2. PG-FP3 Parts and Names

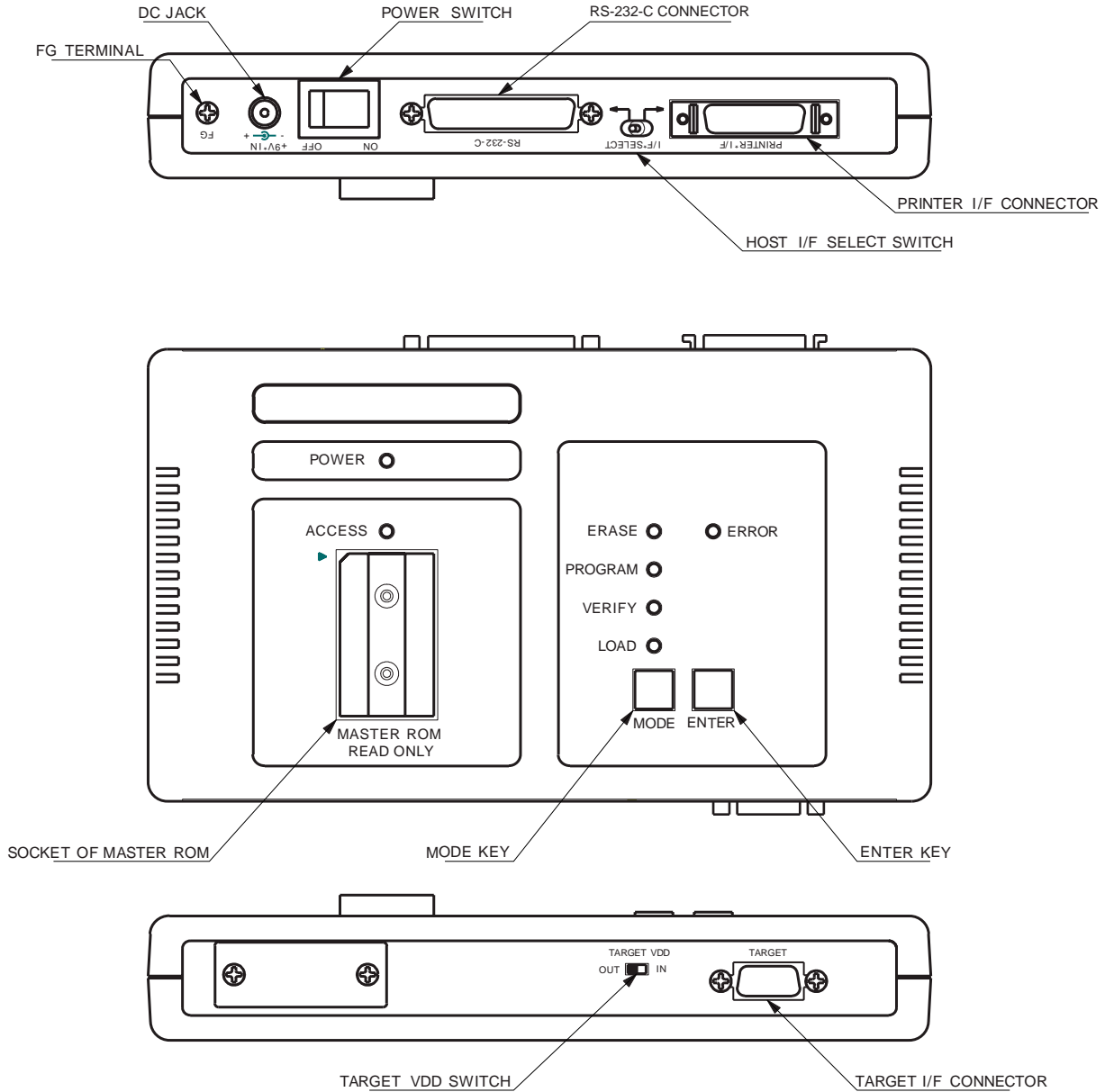

The following explains the functions of the PG-FP3 parts:

- **FG TERMINAL**
 The FG terminal is a ground terminal on the PG-FP3. If necessary, ground the terminal using the FG cable supplied as an accessory.

- **DC JACK**
This is the power supply input jack of the PG-FP3. To supply power to the PG-FP3, use the AC adapter supplied as an accessory.
- **POWER SWITCH**
This switch turns power to the PG-FP3 on or off. Before turning power on, make sure that all required parts are connected correctly.
- **RS-232C CONNECTOR**
This connector is used when RS-232C is used as the host interface. Use a commercially available 25-pin straight cable to connect the host machine and the PG-FP3.
- **PRINTER I/F CONNECTOR**
This connector is used when the printer interface cable supplied as an accessory is used as the host interface. Connect the host machine and the PG-FP3 with the printer cable. Use only the supplied cable. Another cable may cause the PG-FP3 to malfunction or to be damaged.
- **HOST I/F SELECT SWITCH**
This switch selects whether an RS-232C or the printer interface cable is used as the interface with the host machine. Select an interface before turning on power to the PG-FP3. The selected interface cannot be changed after power has been turned on.
- **SOCKET OF MASTER ROM**
The master ROM socket is used when a user program is downloaded to the PG-FP3 from a source other than the host machine. A commercially available EPROM can be used as the master ROM. The user program can be downloaded from an application or in stand-alone mode.
- **MODE KEY**
This key is used to select a command mode when the PG-FP3 is used in stand-alone mode. Each time this key is pressed, the command mode changes.
- **ENTER KEY**
This key is used to execute a command selected by the mode key when the PG-FP3 is in stand-alone mode. Select the command to be executed with the mode key, and press the ENTER key once to execute the command.
- **TARGET V_{DD} SWITCH**
This switch selects whether V_{DD} is supplied from the PG-FP3 or from the target board. Usually, V_{DD} is supplied from the target board.
Supply V_{DD} from the PG-FP3 (TARGET V_{DD}: OUT) only when a writing adapter, such as the FA adapter^{Note}, is used.
- **TARGET I/F CONNECTOR**
This connector connects the PG-FP3 and the target board. Use the target interface cable supplied as an accessory to make the connection.

Note The FA adapter is a product of Naito Densai Machida Mfg. Co., Ltd.

2.3 CONNECTIONS OF PARTS

This section explains how to connect the various parts of the PG-FP3.

The PG-FP3 can be used in two ways. It can be connected to a host machine and controlled by application software or it can be used in stand-alone mode without being connected to a host machine. When using the PG-FP3 without being connected to the host machine (i.e., in stand-alone mode), you may skip the description on connection with the host machine.

Photo 2-1. Connections (Host, PG-FP3, and Target)

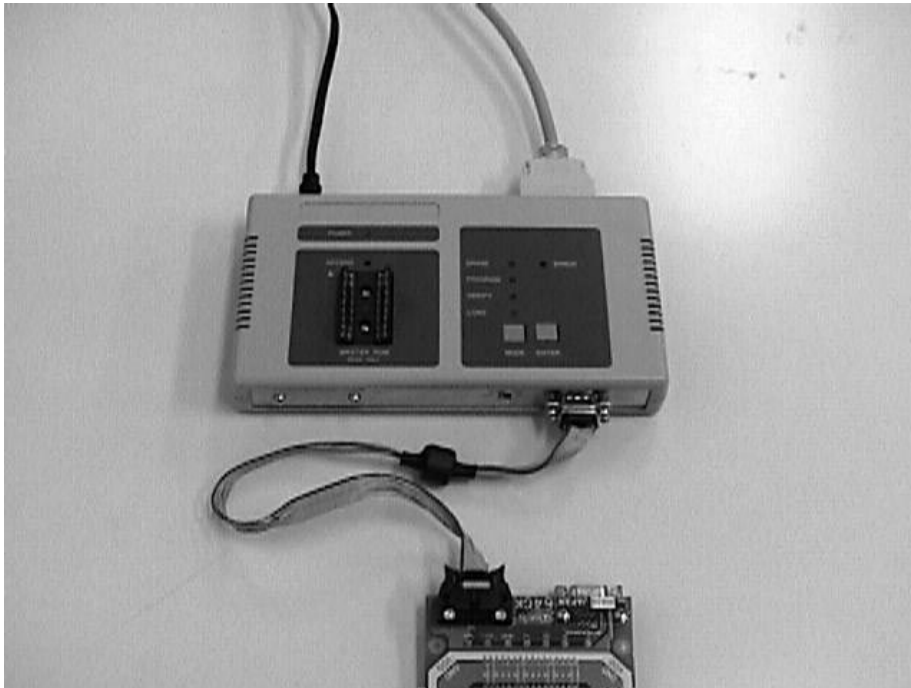

Remark When the PG-FP3 is used in stand-alone mode, interfacing with the target must be specified in advance. To do so, select the device to be used and the communication mode using the application software on the host machine. The setting information is recorded in the PG-FP3. In stand-alone mode, the PG-FP3 interfaces with the target based on this information.

[Connecting a host machine]

Connection of the host interface cable is illustrated below. Select the host interface before turning on power to the PG-FP3. The selected host interface cannot be changed after power has been turned on.

- Connecting the printer interface cable

Set the interface select switch to the printer interface position. Connect the host machine with the printer interface cable supplied as an accessory. Use the appropriate interface cable for the type of host machine (PC-9800 or PC/AT).

The printer interface cable cannot be used unless the host machine supports bidirectional parallel communication. Before using this cable, therefore, confirm that the host machine supports bidirectional communication, compatible mode, and ECP mode.

Photo 2-2. Connecting the Printer Interface Cable (I/F SELECT Switch Set to PRINTER I/F Position)

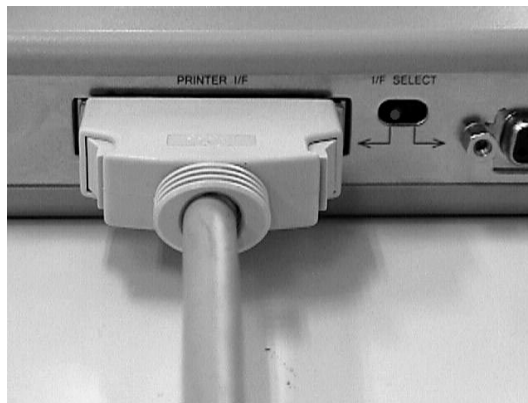

- Connecting the RS-232C interface

Set the interface select switch to the RS-232C position, and connect the appropriate RS-232C straight cable to the RS-232C connector.

Photo 2-3. Connecting RS-232C (I/F SELECT Switch Set to RS-232C Position)

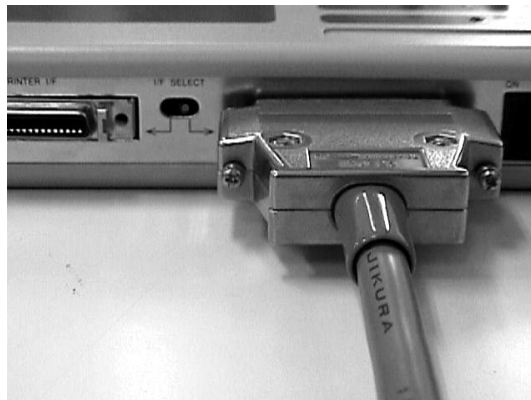

[Connecting the power supply]

With the power switch off, connect the AC adapter supplied as an accessory to the DC jack.

Photo 2-4. Connecting the AC Adapter**[Connecting the target]**

Use the target cable supplied as an accessory to connect the target. Whether you use a Type 1 or Type 2 cable depends on the specifications of the target. If the FA adapter^{Note} is used, either use a Type 2 cable, or directly connect the target to the PG-FP3.

Note The FA adapter is a product of Naito Densai Machida Mfg. Co., Ltd.

- When using a user target

Confirm that the target V_{DD} switch is set to the IN position and then connect one end of the target cable to the PG-FP3.

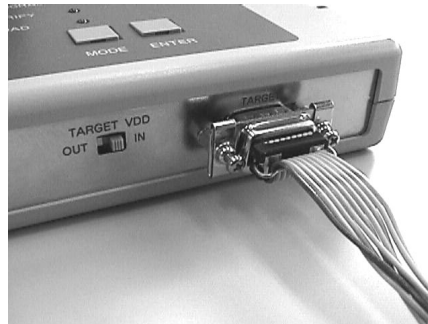
Photo 2-5. Connecting Target Cable to PG-FP3 <1>

Connect the other end of the target cable to the user target (in the example below, an IC clip is used).

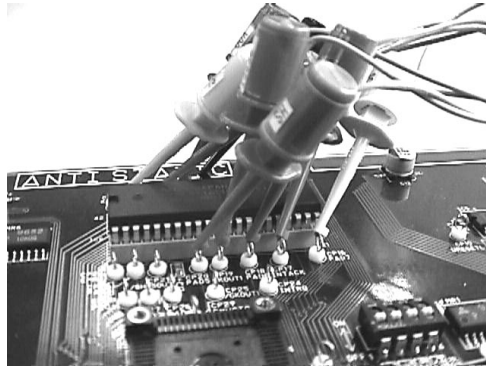
Photo 2-6. Connecting Target Cable to User Target

For the details of interface signal connections, see **Section 7.4** and the manual for the device.

- When using the FA adapter
Make sure that the target V_{DD} select switch is set to the OUT position. Connect one end of the Type 2 cable to the PG-FP3, and the other end of the cable to the mating connector of the FA adapter. Alternatively, directly connect the D-SUB connector of the FA adapter to the target interface connector of the PG-FP3. The FA adapter has a D-SUB connector and a connector supporting the Type 2 cable. Connect the FA adapter in either of the ways described above. For the wiring of the FA adapter, refer to the FA adapter manual or the manual for the device.

Photo 2-7. Connecting Target Cable to PG-FP3 <2>

Photo 2-8. Connecting Target Cable to FA Adapter



The following is an example of directly connecting the FA adapter to the PG-FP3:

Photo 2-9. Directly Connecting FA Adapter to PG-FP3

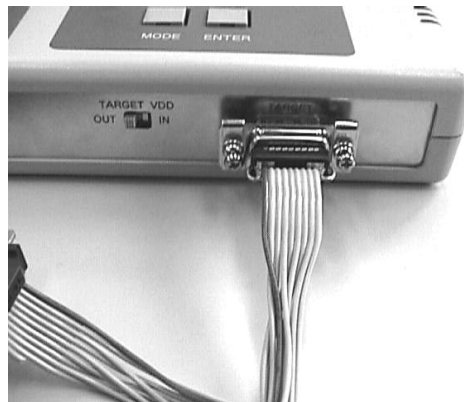
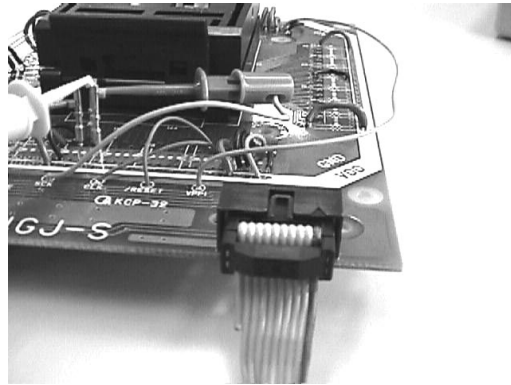
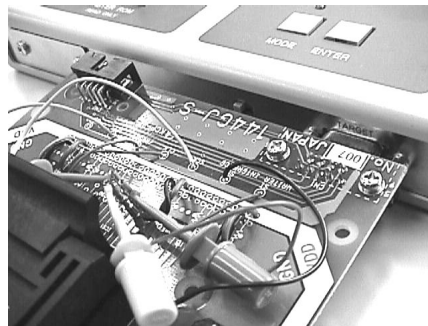

CHAPTER 3 STARTING AND STOPPING

This chapter explains how to install, start, and terminate the application. It also contains information on initialization and on use of the application. Be sure to read this chapter, since it provides very important information about using the PG-FP3. Unless the information in this chapter is not understood and followed, the PG-FP3 may not operate correctly.

3.1 INSTALLING THE APPLICATION

This section explains how to install the application program.

Caution Because the program file is stored in compressed form on the floppy disk, it cannot be used simply by copying the files on the disk to the hard disk. Be sure to install the program correctly by using the setup program.

- Starting the host machine

Turn on power to the personal computer, and start Windows 95 or Windows NT.

Host machine: PC-9801 or PC-9821

IBM PC/AT compatible

CPU: Pentium™ (100 MHz or higher is recommended.)

RAM: 32 Mbytes or more is recommended.

- Starting the setup program

Select [Run] from the Start menu.

Enter the name of the drive for which [SETUP DISK] has been set and the file name SETUP.EXE in the [Open] text box in the [Run] dialog box.

Example When Disk 1 inserted in drive B

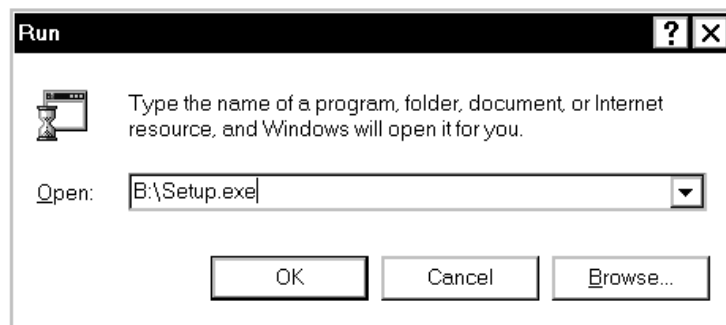

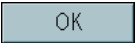
After entering the drive name and file name, click the  button.

★ • Starting installation

When SETUP.EXE starts, follow the instructions by the setup program until the setting screen for the installation directory is displayed. To stop installation partway, click the [Cancel] button.

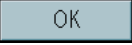
Specify the installation directory in [Destination Directory] in the Choose Destination Location screen. Then, click the  button.

Example Specifying the [Program Files\Flashpro3] path of drive C

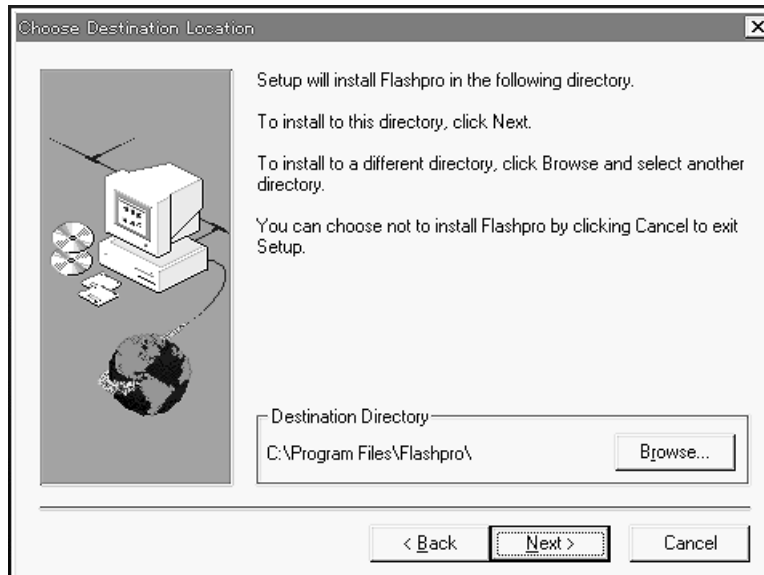

To start the installation, click the [Next] button. When the installation ends, a confirmation message appears as shown below. Click the [OK] button.



Now, the installation is completed. An English help file is installed as standard. To use a Japanese help file, copy the flashpro.hlp file from Disk 2 into the installation directory. Note that the English help file is overwritten.

- Uninstalling the program

To uninstall the PG-FP3 application, execute [Add/Remove Programs] in [Control Panel], and select [FLASHPRO3].

Uninstallation will start, and the files copied during installation will be deleted.

Caution Uninstallation erases all installed components. If FLASHPRO3 is required after uninstallation, reinstall it.

- Installing the parameter file

The PG-FP3 loads information about the target device as a parameter file and makes the necessary settings for interfacing.

Caution The PG-FP3 will not operate correctly unless the parameter file of the device to which programs are to be written has been installed. Be sure to obtain and install the parameter file when using PG-FP3.

Using Explorer or a similar means, copy the parameter file (XXXXXXX.PRC) to the same location where FLASHPRO3 has been installed. Unless the file is copied to the same location, FLASHPRO3 will not correctly recognize the parameter file.

3.2 STARTING THE APPLICATION

This section explains how to start the application program.

- Connection of each unit and applying power
For connection of each unit, see **Section 2.3**.
- ★ After completing connections, turn on power to the PG-FP3. When the PG-FP3 is operating normally, the POWER LED lights, the LED on the side of the MODE key blinks, and then the Erase, Program, and Verify LED indicators light.

Photo 3-1. Starting the PG-FP3



If any of the LEDs mentioned above does not light, the PG-FP3 has probably malfunctioned. If this occurs, notify NEC.

- Starting FLASHPRO3
Either select FLASHPRO3 from the Start menu or, if a shortcut has been created, double-click the shortcut to start FLASHPRO3. If FLASHPRO3 starts correctly, the following screen is displayed.

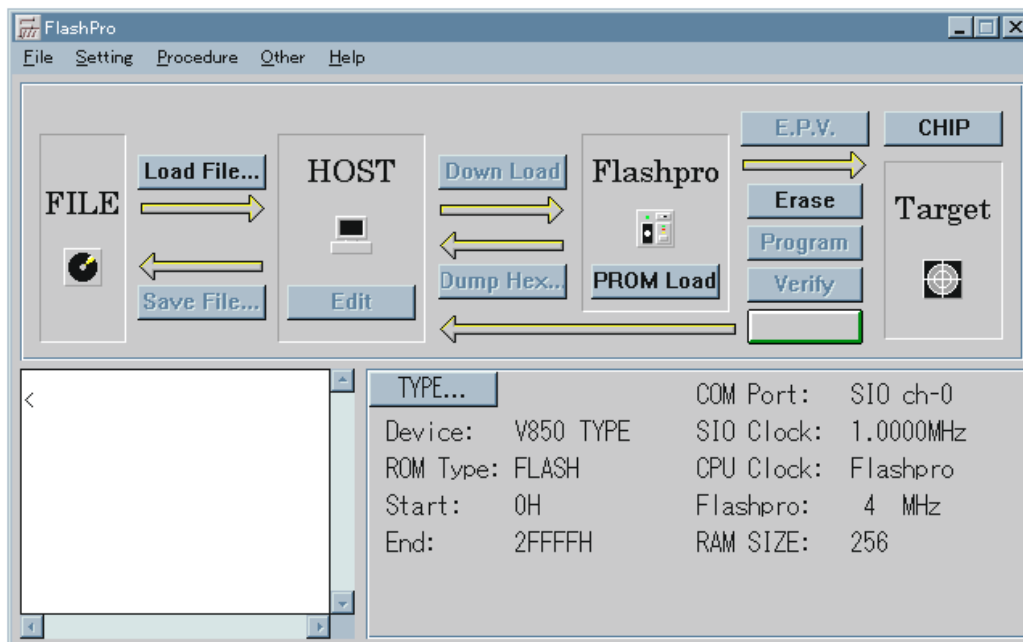

- If FLASHPRO3 does not start correctly

FLASHPRO3 will not start correctly if the communication settings are wrong or if installation has not been performed correctly.

When FLASHPRO3 starts, connection with the PG-FP3 is checked. If communication is not being performed normally, the following dialog is displayed.

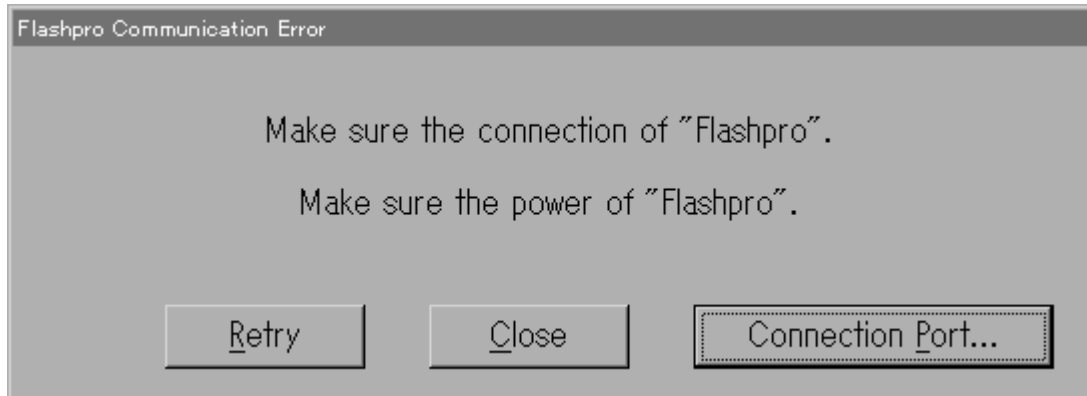

This dialog is displayed because:

1. The cables are not correctly connected.
Correctly connect the cables. Especially, connect the RS-232C cable correctly because it is a straight cable.
2. The selected interface is wrong.
Check to see if the setting of the I/F SELECT switch matches the interface used.
3. Setting of Connection Port is wrong.
If the setting of the Port is different from the Port actually being used for the host, set the correct port.
4. A wrong communication rate is set.
The PG-FP3 operates at a communication (baud) rate of 9600 bps on starting if the RS-232C interface is selected. If a wrong baud rate is set, correct the setting.
There is also a possibility that the communication settings for the RS-232C port are wrong. Also check the RS-232C port. The correct communication setting is Data: 8 bits, Stop bit: 2 bits, Parity: None, Flow control: None.
5. Other cases
If all the above are okay but FLASHPRO3 will still not start, either FLASHPRO3 is not correctly installed or the PG-FP3 is damaged. If FLASHPRO3 will not start after it is installed again, notify NEC.

- FLASHPRO3 screen

The FLASHPRO3 screen consists of three subscreens. The operation screen contains command execution buttons in the form of a flowchart so that you can perform a series of operations by referring to the flowchart. The log window screen shows the command flow between the FLASHPRO3 and PG-FP3, the status, and the progress of command execution. The TYPE screen displays the current TYPE settings, allowing you to check the current settings without having to open the TYPE setting window.

Figure 3-1. FLASHPRO3 Screens

(a) Operation Screen

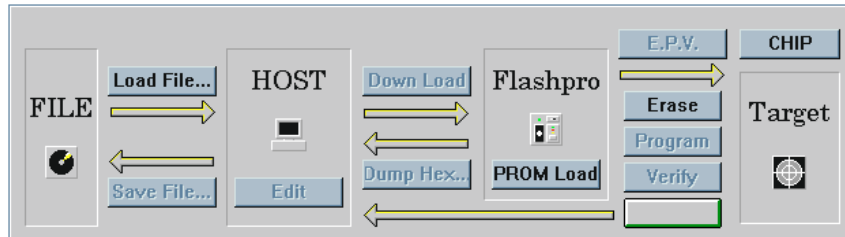

(b) Log Window Screen

```

NP24 *** SETTING DATA ***
a)DEVICE TYPE: V85X TYPE
b)ROM TYPE: FLASH
c)START ADDRESS: 000000H
d)END ADDRESS: 02FFFFH
e)RAM SIZE: 000256
f)Multiple Rate: 05.00
g)SELECT PORT: SIO0
h)SIO CLOCK: 01000000 Hz
i)Flashpro CLK: 004000 KHz
    
```

(c) TYPE Screen

TYPE...	COM Port:	SIO ch-0
Device: V850 TYPE	SIO Clock:	1.0000MHz
ROM Type: FLASH	CPU Clock:	Flashpro
Start: 0H	Flashpro:	4 MHz
End: 2FFFFH	RAM SIZE:	256

3.3 INITIALIZATION AND NOTES ON CORRECT USE

Before a target can be accessed with FLASHPRO3, several settings must be performed for FLASHPRO3. If these settings are not done correctly, communication may not be executed correctly or the target may be damaged.

- Loading parameter file

The parameter file is loaded with the [Setting..Device] command. If the file is not loaded when FLASHPRO3 starts, settings for the target will not be correctly performed. Consequently, communication may fail or the target may be damaged.

Figure 3-2. Parameter File Setting Dialog Box

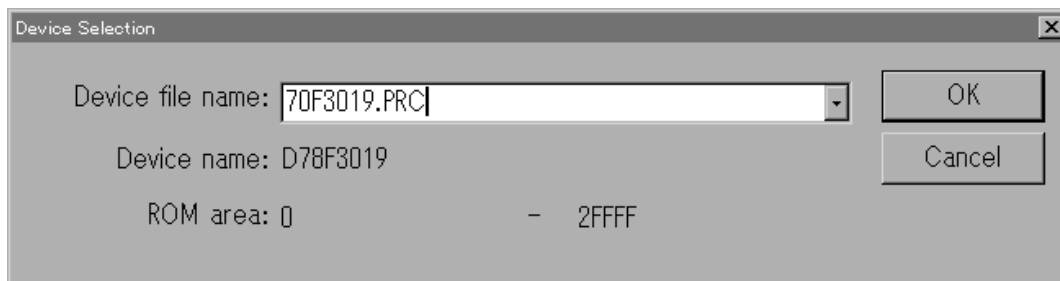

When this dialog box is opened, enter the parameter file name in response to Device file name:. Alternatively, click the button to the right of the text box to display a list of parameter files. Select one and click the [OK] button. The selected parameter file will be loaded.

- TYPE setting

The TYPE setting dialog box is used to set information necessary for communication with the target. Default information is set when the parameter file is loaded. To change the default setting, either execute the [Setting..Type] command, or click the [TYPE] button on the screen.

The TYPE setting dialog box below is displayed.

Figure 3-3. TYPE Setting Dialog Box (When the Parameter File Is Loaded)

The dialog box is titled "TYPE" and contains the following settings:

- DEVICE TYPE:**
 - 78K(1) TYPE
 - 75XL TYPE
 - 61FX TYPE
 - 78K(2) TYPE
 - V850 TYPE
- ROM TYPE:**
 - FLASH
- START ADDRESS:** 0 H
- END ADDRESS:** 2FFFF H
- COMM PORT:** SIO ch-0 (3 wired, sync.)
- SIO CLOCK:** 1.0000MHz (Range) 100-2.0000M(Hz)
- RAM SIZE:** 256 (Range) 1-256
- CPU CLOCK:**
 - On target board
 - In Flashpro
- Flashpro clock:** 4 MHz
- Multiple Rate:** 05.00
- Block/Area...:** Block: 0, Block Number: 0 - 1

If the device definition file has not been loaded, the TYPE setting dialog box below is displayed. In this case, load the file, and then perform TYPE setting.

Figure 3-4. TYPE Setting Dialog Box (When the Parameter File Is Not Loaded)

The dialog box is titled "TYPE" and contains the following settings:

- DEVICE TYPE:**
 - 78K(1) TYPE
 - 75XL TYPE
 - 61FX TYPE
 - 78K(2) TYPE
 - V850 TYPE
- ROM TYPE:**
 - FLASH
- START ADDRESS:** (Empty) H
- END ADDRESS:** (Empty) H
- COMM PORT:** SIO ch-0 (3 wired, sync.)
- SIO CLOCK:** 1.0000MHz (Range) 100-2.0000M(Hz)
- RAM SIZE:** 256 (Range) 1-256
- CPU CLOCK:**
 - On target board
 - In Flashpro
- Flashpro clock:** 4 MHz
- Multiple Rate:** 05.00
- Block/Area...:** Block: 0, Block Number: 0 - 0

In the TYPE setting dialog box, device-specific information is automatically set when the parameter file has been loaded, and the text box is grayed out. The parameters that can be changed by the user in this dialog box are as follows:

1. COMM PORT

Selects the communication mode with the target. The communication modes that can be selected depend on the device. For details, refer to the manual for the device.

The communication rate can be also changed. The communication rate also depends on the function and the device operating clock. For details, refer to the manual for the device.

2. ROM TYPE

Usually, only FLASH is set. If the device used has an on-chip EEPROM™, however, the internal data of the EEPROM can be read to the PG-FP3 by selecting EEPROM.

3. CPU CLOCK

Selects the CPU operating clock. When the FA adapter is used, select In Flashpro to choose a clock from Flashpro Clock. When the user target board is used, select On target board and enter the clock frequency of the target board in the text box.

Some devices have a multiply circuit. In this case, enter a multiple for Multiple Rate.

- Voltage setting

Set the operating voltage of the target. When the [Setting..Voltage] command is executed, the following dialog box opens.

This dialog box is used to set the operating voltage of the target and the V_{PP} voltage. If the parameter file has been loaded, the default voltages are set automatically. Because some devices allow you to select an operating voltage, set the voltage according to target conditions.

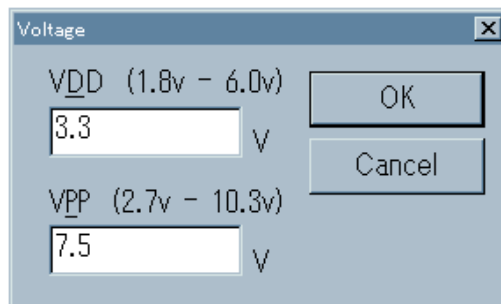

- Option setting

The Options dialog box is used for detailed setting of the target and is displayed when the [Setting..Option] command is executed.

This dialog box is used to set the erase time, write time, and convergence time. These parameters are automatically set to the default values when the parameter file is loaded.

- ★ The new values become valid only when the check box is checked before the [Setting..Option] command is executed.

Do not change these parameter settings unless it is necessary. Changing any of these parameters may damage the device.

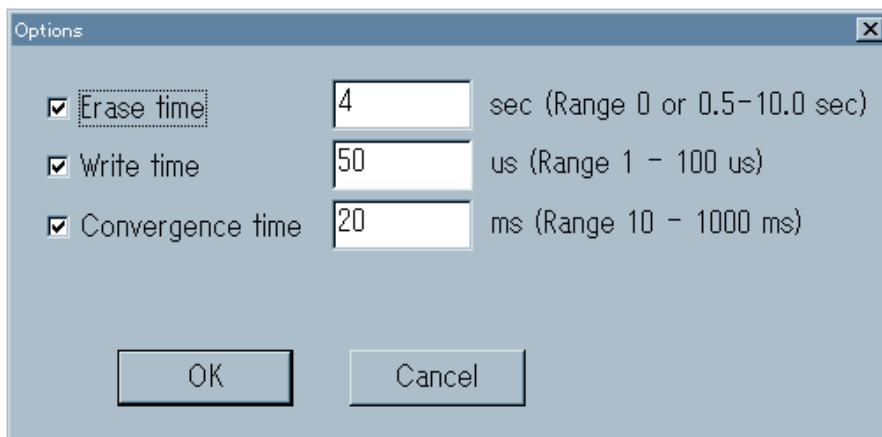

Because the above settings are necessary for correct interfacing with the target, be sure to perform them when starting FLASHPRO3. The information set is recorded in the PG-FP3 and is used to interface with the target when the PG-FP3 is used in stand-alone mode. Any setting that is changed can be saved with the [File..Type Save] command. To perform setting again, use the [File..Load] command.

Caution Load the parameter file each time FLASHPRO3 is started, even though the file was loaded the previous time FLASHPRO3 was used. The PG-FP3 updates its settings to prevent a wrong target from being selected by reloading the parameter file each time FLASHPRO3 has been started. This is done because the target may be damaged if it is accessed with wrong setting of the parameter file.

3.4 TERMINATING THE APPLICATION

To terminate the application, execute the [File..Exit] command.

After terminating the application, turn off power to the PG-FP3.

Caution The target may be damaged if power to the PG-FP3 is turned off or if the target is disconnected while a command is being executed. To end operation of the PG-FP3 while a command is being executed, execute the [Procedure..Cancel] command to cancel the current processing, then terminate the application and turn off power to the PG-FP3.

CHAPTER 4 BASIC OPERATING PROCEDURE

This chapter explains the basic operating procedure, using as an example the μ PD78F4216 used as the target. Specifically, this chapter discusses how to start the system and how to write a program to the target by executing the E.P.V. command. For the other commands and their usage, see **Chapter 5**.

[Operating conditions in this example]

The operating conditions for the example used in this chapter are as follows:

HOST I/F : PRINTER I/F
Target : μ PD78F4216 (with FA adapter)
Interface : UART 9600 bps
Clock In Flashpro 16 MHz
Mode CHIP
V_{DD} 5.0 V
V_{PP} 10.0 V
Command : E.P.V.

(1) Starting the system

- Connect the PG-FP3 and host.
Confirm that the interface select switch is set to the printer interface position.
- Connect the PG-FP3 and target (FA adapter).
Confirm that the target V_{DD} switch is set to the OUT position.

Photo 4-1. Connection of Host, PG-FP3, and Target

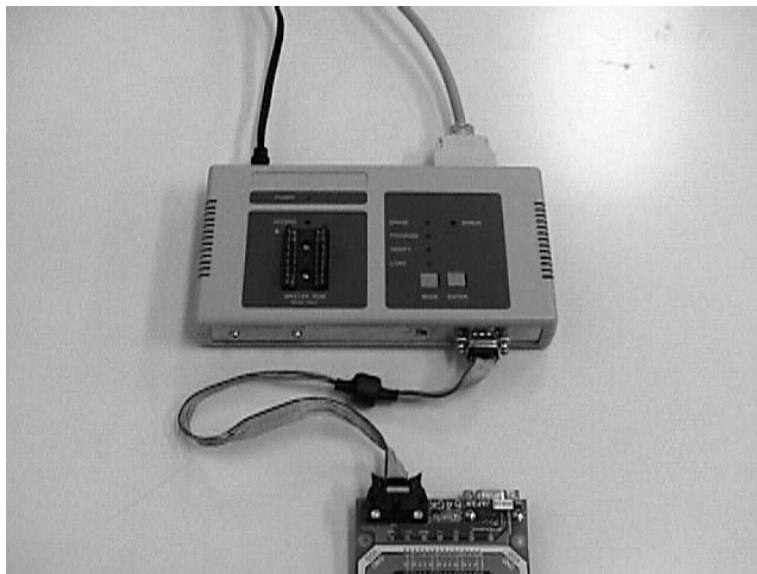

- Turn on power to the PG-FP3.
Confirm that the LED on the PG-FP3 is blinking.
- Start FLASHPRO3.
If the communication error dialog box opens at this time, check the [Connection Port] setting and change if necessary.
The example below assumes that the PG-FP3 is connected to LPT1.

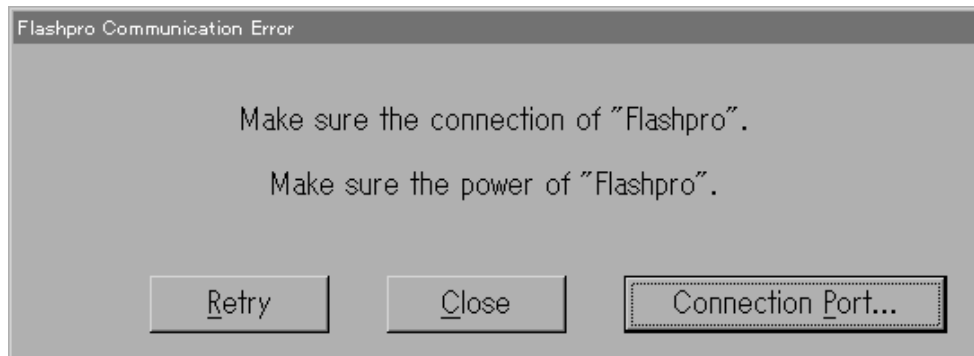
Figure 4-1. Communication Error Dialog Box

Open the setting dialog box by clicking [Connection Port].
Change the setting for Connection Port from COM1 to LPT1.

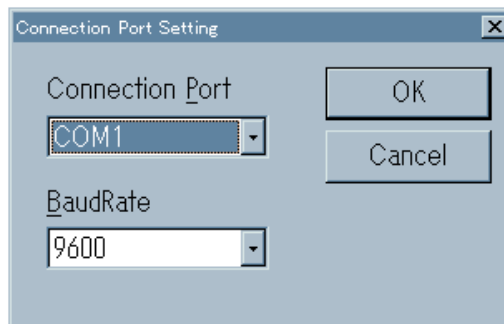

After changing the setting, click the [OK] button.
The error dialog box will be displayed again. Execute [Retry] for reconnection.

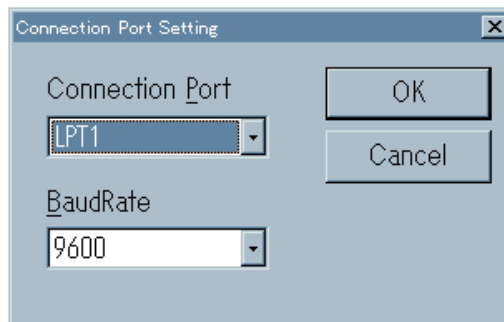

When FLASHPRO3 has been started correctly, the following screen is displayed.

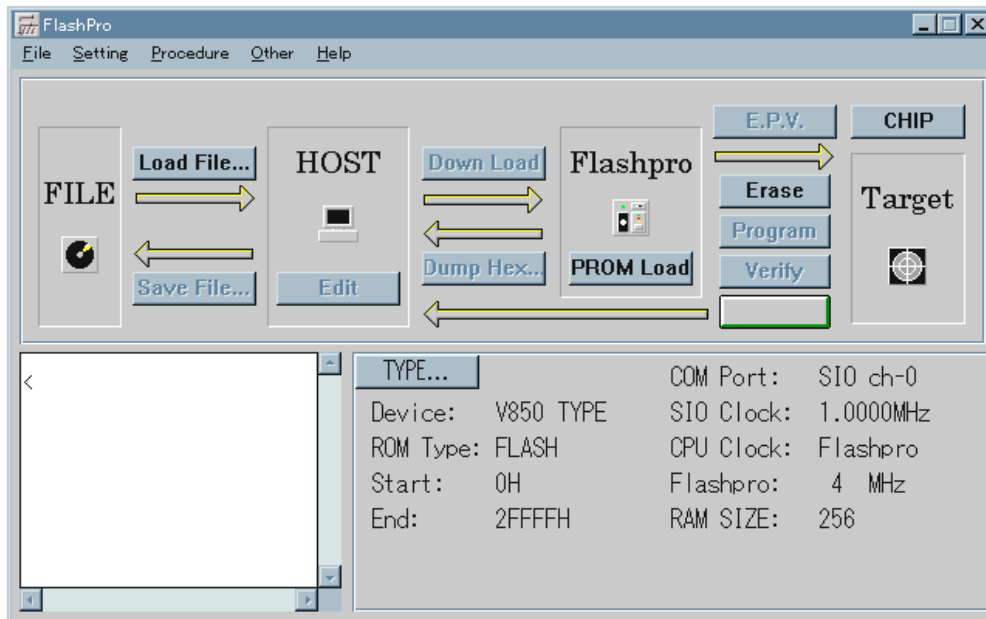

(2) Loading the parameter file

Select [Device] from the [Setting] pull-down menu. The dialog box for loading a parameter file will open. Enter 78F4216.PRC in the box for Device file name: and click the [OK] button.

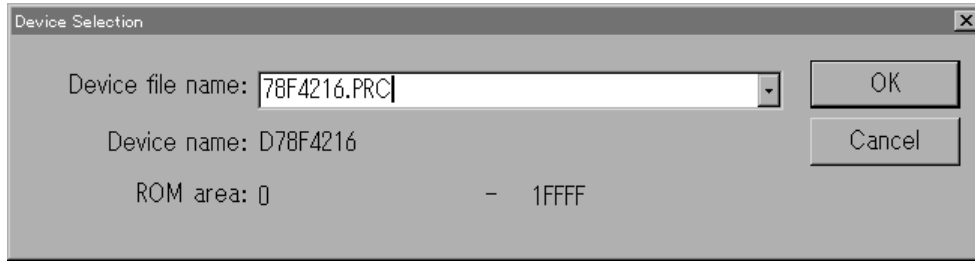

When the parameter file is read, the PG-FP3 is reset for synchronization, then the parameters are read. Consequently, immediately after the parameter file is loaded, the initial status is restored, and the CHIP mode is selected.

The Dump HEX command, Program command, Verify command, and E.P.V. command are dimmed. Those commands are disabled until a user program is downloaded.

The screen appearing immediately after the parameter file is loaded is as shown below:

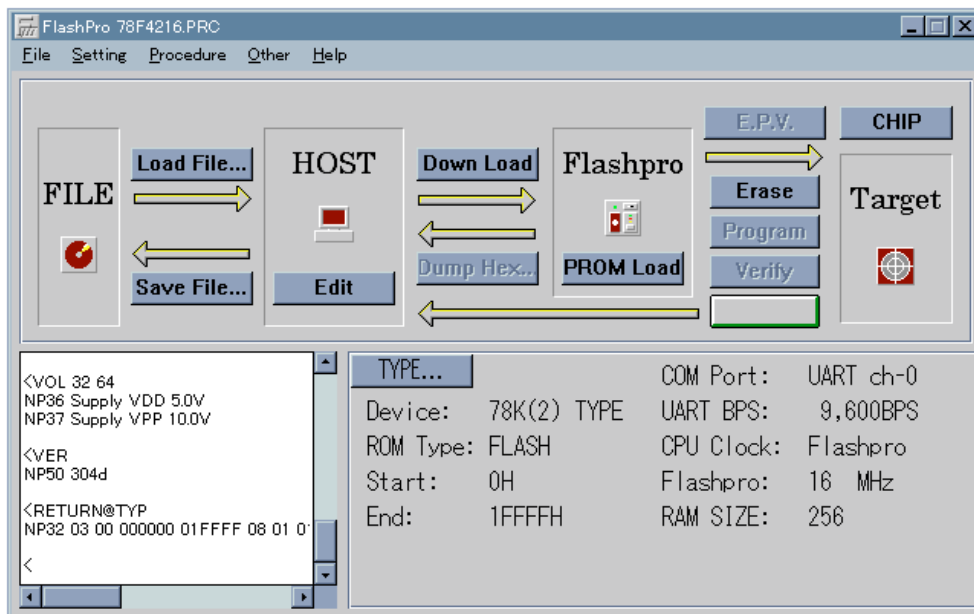

(3) TYPE setting

Open the TYPE setting window by selecting [Type] from the [Setting] pull-down menu, or by clicking the **TYPE...** button on the operation screen.

When the window is open, set COMM Port to UART CH-0, and UART bps to 9600 bps. Then click the [OK] button to accept TYPE setting.

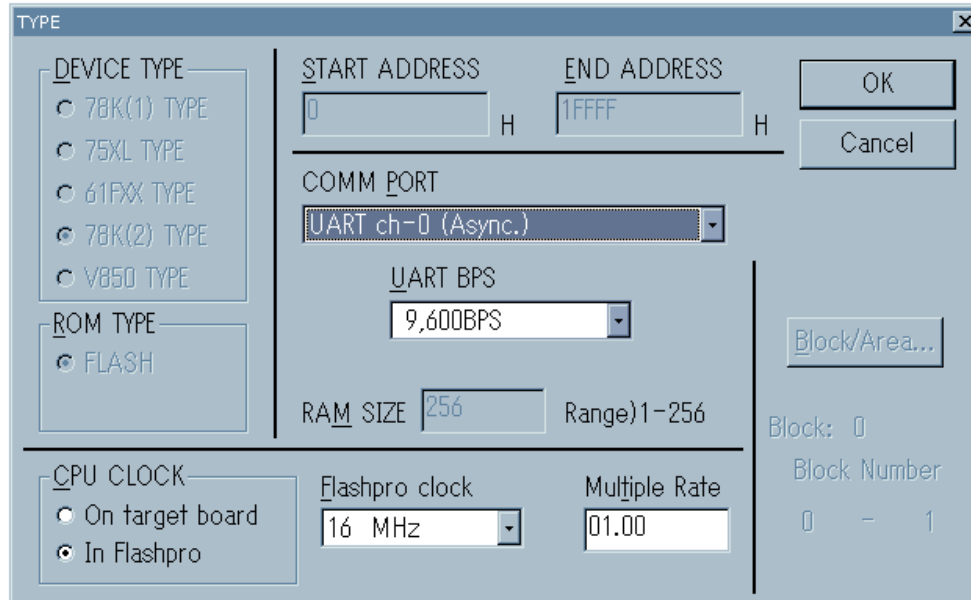

When TYPE setting has been performed, the FLASHPRO3 screen is displayed as follows:

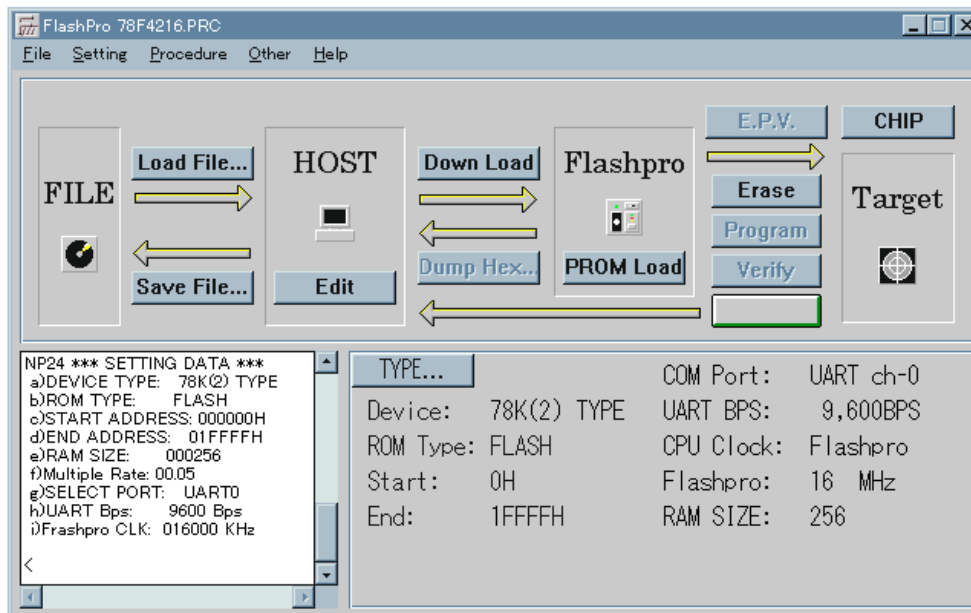

(4) Downloading a user program

Open the dialog box by either selecting [Load File] from the [File] pull-down menu or clicking the **Load File...** button on the operation screen. Select a HEX file to be downloaded, and load the file into FLASHPRO3. When the file has been loaded, the FLASHPRO3 screen is displayed as follows:

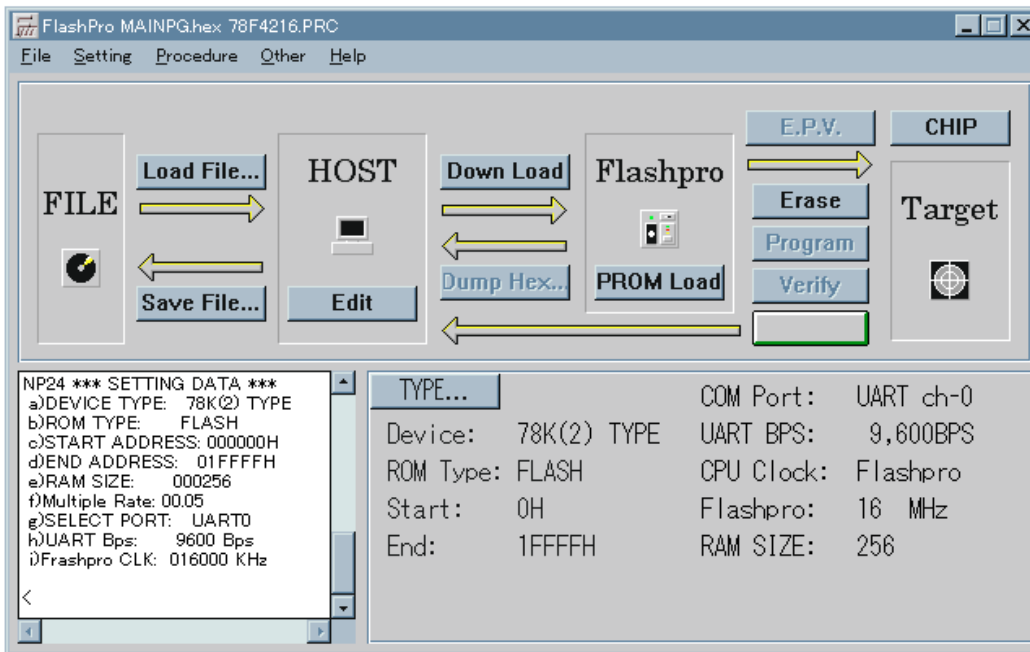

Next, download the file to the PG-FP3 by either selecting [Download HEX] from the [Procedure] pull-down menu or clicking the **Down Load** button on the operation screen. After the file has been downloaded, the FLASHPRO3 screen is displayed as follows:

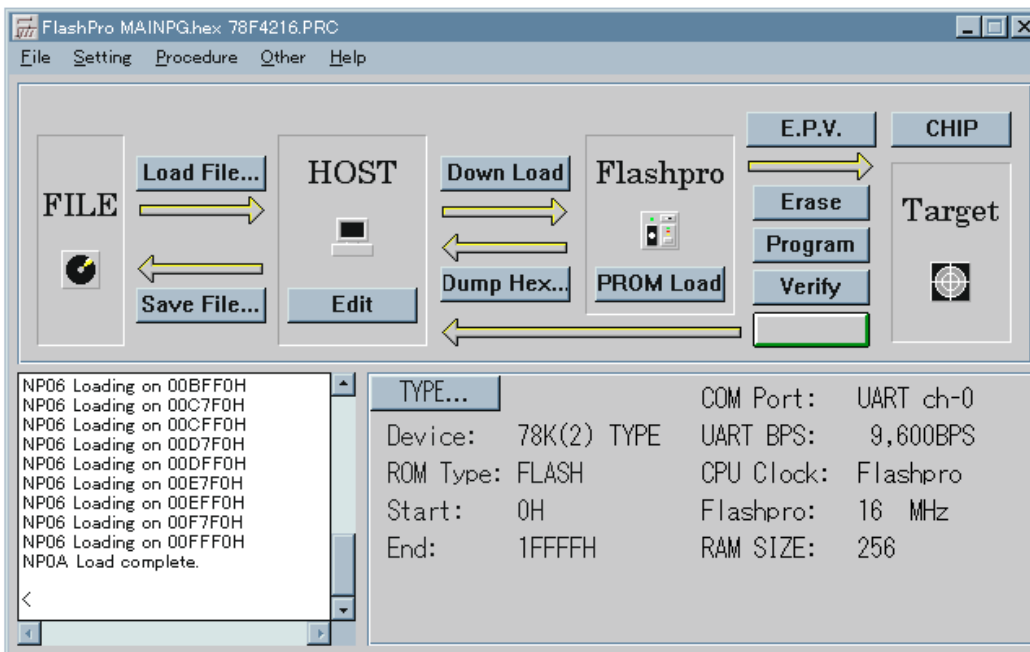

(5) Executing the E.P.V. command

The E.P.V. command can be executed by selecting [E.P.V.] from the [Procedure] pull-down menu, or by clicking the **E.P.V.** button on the operation screen.

While the E.P.V. command is executed, the progress of execution is displayed in the log window, and a PG-FP3 LED blinks.

Lighting of LEDs The Erase, Program, and Verify LEDs light, and the LED for the phase under execution blinks.

Erase O ← Blinks while the program is being erased

Program O ← Blinks during programming

Verify O ← Blinks while the program is being verified

Normal completion of the E.P.V. processing is indicated by the message Verify OK!, which is displayed in the log window.

(6) Verify check

Next, the program is verified independently. This is done by comparing the data stored in the PG-FP3 with the data of the target.

Verification can be executed by either selecting [Verify] from the [Procedure] pull-down menu or clicking the **Verify** button on the operation screen. While verification continues, its progress is displayed in the log window. In addition, the Verify LED on the PG-FP3 blinks, indicating that the command is being executed. If verification is completed normally, the message Verify OK! is displayed in the log window.

(7) Terminating the system

To terminate FLASHPRO3, select [Exit] from the [File] pull-down menu. After terminating FLASHPRO3, turn off power to the PG-FP3.

This completes the series of operations.

[MEMO]

CHAPTER 5 COMMAND REFERENCE

This chapter explains each command. A command can be selected from the pull-down menu on the menu bar or by clicking the corresponding button on the screen.

5.1 File

When [File] is clicked, the pull-down menu shown below is displayed. This menu lists mostly the commands that are used to manipulate files.

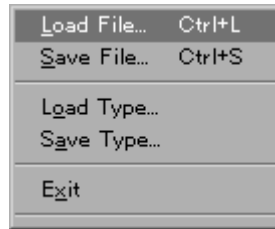

5.1.1 Load File

The [Load File] command loads the user program into FLASHPRO3. The loaded program can be displayed and edited with the [Edit] command. Execute the [Load File] command by selecting it from the pull-down menu or by pressing the **Load File...** button on the screen. When this command has been executed, the window below opens. Select the file to be loaded, and click the [Open] button.

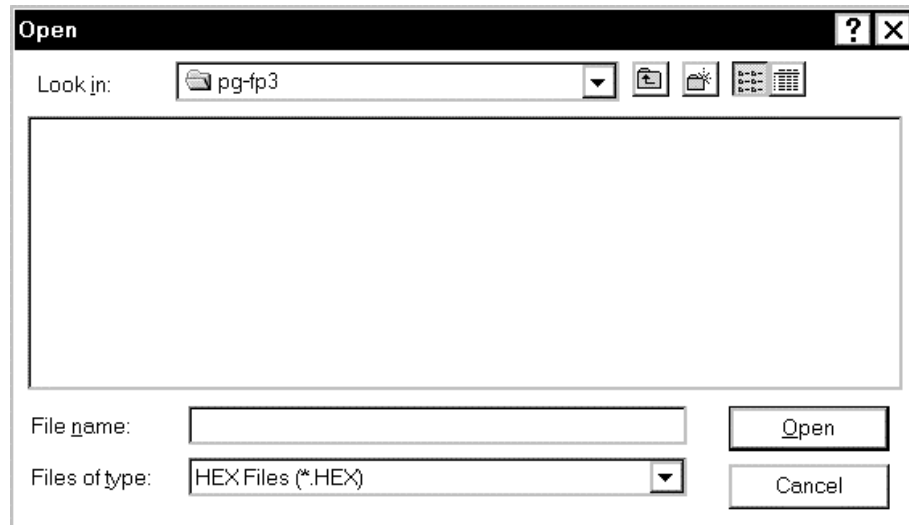

Two types of files can be loaded: Intel expansion HEX and Motorola S format files. An Intel expansion HEX file is recognized as xxxxxx.HEX. A Motorola S format file is recognized as xxxxxx.PRO.

5.1.2 Save File

The [Save File] command saves the user program loaded into FLASHPRO3 or uploaded from the PG-FP3 to a file.

Execute this command by selecting it from the pull-down menu or by pressing the **Save File...** button. When this command has been executed, the window below opens. Enter the name of the file to be saved, and click the [Save] button.

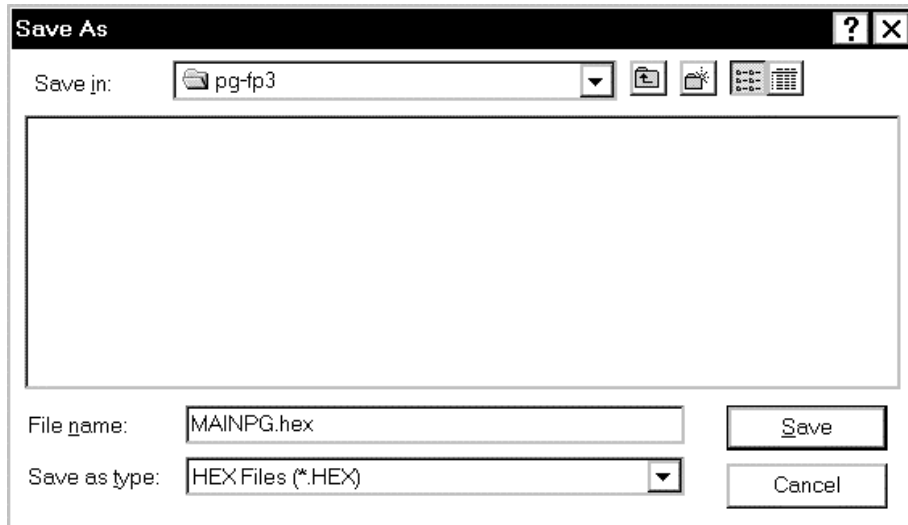

Two types of files can be saved: Intel expansion HEX and Motorola S format files. An Intel expansion HEX file is recognized as xxxxxx.HEX. A Motorola S format file is recognized as xxxxxx.PRO. For selection of a file format, the following dialog box is displayed when the [Save File] command has been executed. Click the button corresponding to the type of file to be saved.

- ★ The file format cannot be converted in the file format select dialog box.

Figure 5-1. File Format Select Dialog Box

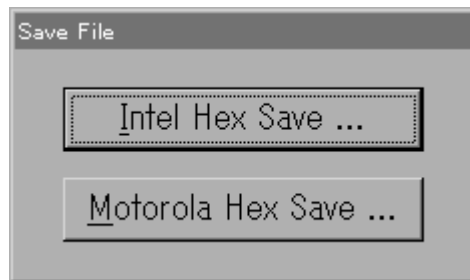

5.1.3 Load Type

The [Load Type] command reloads the file (xxxxxx.TYP) in which the information set with [Setting] has been saved when resetting is required. When the Type File is loaded again, the previously used environment is restored.

Execute the [Load Type] command by clicking [Load Type] on the [File] pull-down menu. When this command has been executed, the window below opens. Select the Type File to be loaded, and click the [Open] button.

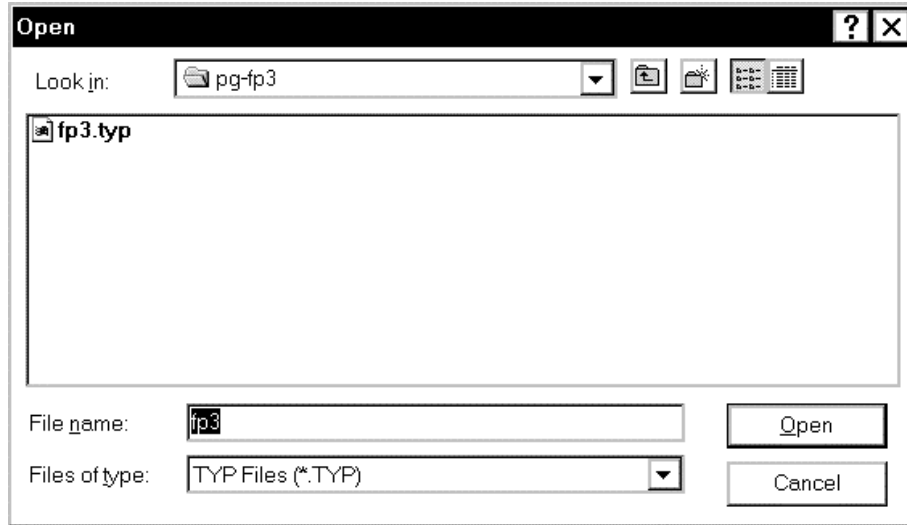

The following information is reset when Type File is reloaded:

- Parameter definition information
- TYPE setting information
- Voltage setting information
- Option setting information

5.1.4 Save Type

The [Save Type] command saves information set with [Setting] to a file (xxxxxx.TYP), so that the information can be reloaded when resetting is required. When Type File is saved, the previously used environment can be restored at any time.

Execute the [Save Type] command by clicking [Save Type] on the [File] pull-down menu. When this command has been executed, the window below opens. Enter the name of the file to be saved and click the [Save] button.

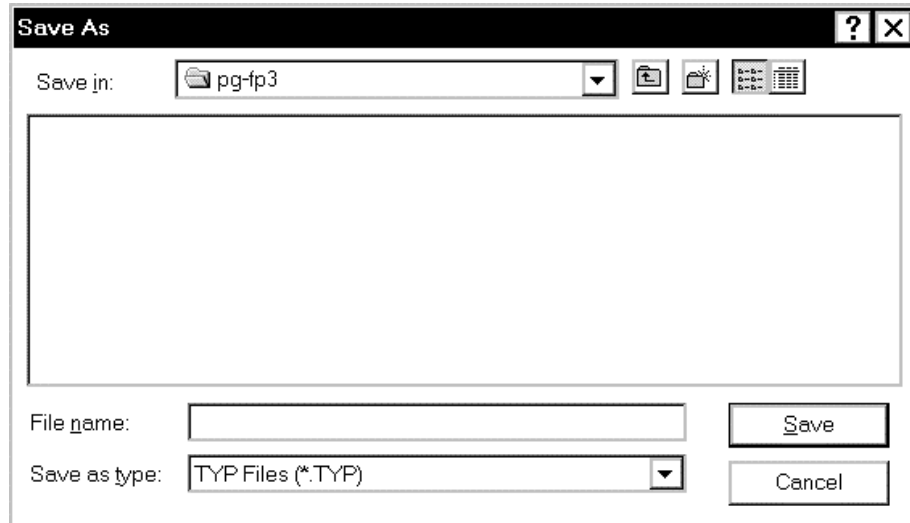

The following information is saved when Type File is saved:

- Parameter definition information
- TYPE setting information
- Voltage setting information
- Option setting information

5.1.5 Exit

The [Exit] command terminates FLASHPRO3. Execute this command by clicking [Exit] on the [File] pull-down menu. You can also terminate FLASHPRO3 by clicking the [x] button on the right of the task bar.

5.2 Setting

When [Setting] is clicked, the pull-down menu shown below is displayed. This menu lists the commands that are used to set the FLASHPRO3 operating environment (such as setting of the target interface).



5.2.1 Device

The [Device] command loads information such as information specific to the target device and communication settings into FLASHPRO3 and the PG-FP3. The information on each target device is supplied to the user in the form of a parameter file (xxxxxx.PRC). Loading this file automatically sets each parameter. Execute this command by clicking [Device] on the [Setting] pull-down menu.

When this command is executed, the dialog box below opens. Enter the name of the parameter file for the target to be used, or select an appropriate parameter file by clicking the button to the right of the text box, and then click the [OK] button. This completes the setting of the parameters.

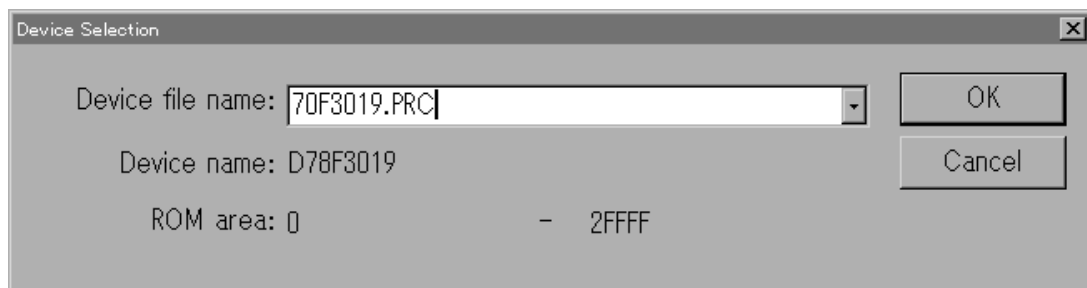

- Remarks**
1. The information in the parameter file sets information important for interfacing with the target. On starting FLASHPRO3, therefore, be sure to load the parameter file with [Device].
 2. The parameter file will not be recognized unless it is installed in the same directory as FLASHPRO3. Install the file correctly by seeing **Section 3.1**.
 3. If Type information is saved with [Save Type], parameter definition information is also set by loading Type File with [Load Type]. It is therefore not necessary to load the parameter file again with [Device].

5.2.2 Type

The [Type] command sets the mode of communication with the target and operating clock. Because the communication mode and operating clock differ depending on the device used, refer to the manual for the device for details. Execute the [Type] command by clicking [Type] on the [Setting] pull-down menu or by clicking the **TYPE...** button on the screen.

When this command is executed, the TYPE setting window below opens. After the parameter file has been loaded, the default values for the information specific to the device is grayed out, and the appropriate default values for the device are automatically set for the other items. To change a default value, change the contents of the corresponding item and click the [OK] button. The setting will be changed.

The following describes each parameter in the figure above.

- Selecting the device type (DEVICE TYPE)
The device type is determined by the information in the parameter file.
- Selecting the internal ROM format for the target microcontroller (FLASH, EEPROM)
A ROM type cannot be selected for a microcontroller that does not have EEPROM in the parameter definition information. If a ROM type can be selected, select either of the following ROM types:
 - FLASH FLASH memory
 - EEPROM EEPROM
- ★ When FLASH memory is used, the memory cannot be correctly written to unless it has been erased.
The erase command cannot be executed when an EEPROM is used.
- Entering the start address (START ADDRESS)
The start address is determined by the parameter definition information. It is automatically set in the Block and Area modes.

- Entering the end address (END ADDRESS)

The end address is determined by the parameter definition information. It is automatically set in the Block and Area modes.

Remark The end address range that can be specified with the PG-FP3 is 2 Mbytes (1FFFFFFH). This is a hardware specification.

- Selective input of serial port (COMM PORT)

Select the mode of communication between the PG-FP3 and target device from the modes listed below.

Some of the following communication modes cannot be used with some devices. Select one of the communication modes listed in the manual for the device. The channel number of some devices starts with ch-1. In this case, ch-0 is equivalent to ch-1 of the device.

Parameter on screen	Description
• SIO ch-0	SIO (3-wire clocked communication port) channel 0
• SIO ch-1	SIO (3-wire clocked communication port) channel 1
• SIO ch-2	SIO (3-wire clocked communication port) channel 2
• SIO ch-3 + handshake	SIO (3-wire clocked communication port with handshaking)
• I ² C ch-0	I ² C channel 0
• I ² C ch-1	I ² C channel 1
• I ² C ch-2	I ² C channel 2
• I ² C ch-3	I ² C channel 3
• UART ch-0 (Async.)	UART (asynchronous communication port) channel 0
• UART ch-1 (Async.)	UART (asynchronous communication port) channel 1
• UART ch-2 (Async.)	UART (asynchronous communication port) channel 2
• UART ch-3 (Async.)	UART (asynchronous communication port) channel 3
• Port A (Pseudo-3 wired)	Port (pseudo 3-wire) A
• Port B (Pseudo-3 wired)	Port (pseudo 3-wire) B
• Port C (Pseudo-3 wired)	Port (pseudo 3-wire) C

- Entering a communication rate for the UART (UART BPS)

Select a communication rate from the following if UART is selected for the serial port.

- 4800 bps
- 9600 bps
- 19200 bps
- 31250 bps
- 38400 bps
- 76800 bps

Caution If the target CPU clock is slow, use a slow communication rate. If the communication rate is too fast, communication may not be performed correctly (for details, refer to the target device specifications).

- Entering a clock frequency in 3-wire or pseudo 3-wire mode (SIO CLOCK)
If 3-wire or pseudo 3-wire mode is selected with the serial port, enter a communication rate as a decimal number. The valid range for communication rates is from 100 Hz to 2.0000 MHz. Be sure to enter the unit also. Up to six digits can be entered.

Example 100 Hz = 0.1 kHz = 0.0001 MHz
1 MHz = 1000 kHz (1000000 Hz is not recognized because it has 7 digits.)

Caution Generally, high-speed communication cannot be performed in pseudo 3-wire mode. Check the operation at several hundred Hz and then increase the communication frequency within the range at which correct operation can be performed. The reason is that it takes a long time to write or verify programs at a low communication rate.

Some devices do not operate even at the communication rates that can be set for the PG-FP3. Check the specifications of the device.

- Entering a slave address for IIC (SIO CLOCK)
If IIC is selected for the serial port, enter a slave address as a hexadecimal number. The valid range is 8 to 77H. Do not, however, enter the unit. This slave address can take any value within the range, but must not overlap with the slave address of other devices on IIC.
- Entering RAM SIZE
This value sets the packet size for communication with the target device and is determined by the parameter definition information.
- Entering the CPU clock source (CPU CLOCK)
Selects whether the clock for the target microcontroller is supplied from the PG-FP3.
 - On target board Uses the clock of the target system.
The clock is not supplied from the PG-FP3. Open the CLK pin of the target connector.
 - In Flashpro Supplies the clock of the PG-FP3 to the target.
Connect the CLK pin of the target connector to the CLK pin of the target microcontroller.
For details of connection, refer to the manual for the device.
- Entering the clock frequency of the target system (Target board clock)
If [On target board] has been selected when a CPU clock source is being entered, enter a frequency as a decimal number. The valid range is 1 to 99.999 MHz. Be sure to enter the unit also. Although up to six digits can be entered, only the first three digits are used.

Example 4.19 MHz = 4190 kHz (4190000 Hz is not recognized because it has seven digits.)
If entered, 3.14159 MHz is recognized as 3.14 MHz.

- Selecting a transmission clock frequency from the PG-FP3 (Flashpro clock)
If [In Flashpro] has been selected when a CPU clock source is being entered, select the clock the PG-FP3 transmits from the frequencies listed below. Different devices provide different operating frequency ranges for the target microcontroller. Select the correct frequency by referring to the manual for the device.
 - 16.0 MHz
 - 8.0 MHz
 - 4.0 MHz
 - 2.0 MHz

Caution When the set frequency is changed, execute the [Other-Status] command to check the contents displayed in the log window.

- Setting a multiple for the operating clock (Multiple Rate)
If the target has a multiplier circuit and operation will be performed in multiple mode, enter a multiple. Usually, this parameter is set to 01.00. To operate in multiple mode, enter a multiple.

Example To operate in ×5 mode Enter 05.00.

- BLOCK range setting
In block mode, set a range of blocks. In this mode, the [Block/Area] button at the right of the TYPE setting screen becomes active. When this button is clicked, the dialog box shown below opens. Enter the block range to be used and click the [OK] button. The block range will be set.

Block: Number of device blocks
 (automatically set)
Block Number: Selected blocks
 (set by user)

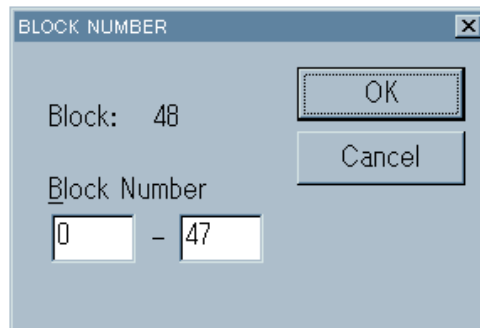

For example, if the block range is specified as 0 to 2 for erasure, Block 0, Block 1, and Block 2 are erased. To specify only one block, enter the same value as the start block and end block.

Caution To set a block, you must set **BLOCK** mode by clicking the **CHIP/BLOCK/AREA** button in the **FLASHPRO3** window or by executing [set block].
For information on changing the mode, see Section 5.3.6.

- AREA setting range

In area mode, set an area range. In this mode, the [Block/Area] button at the right of the TYPE setting screen becomes active. When this button is clicked, the dialog box below opens. Enter the area range to be used and click the [OK] button. The area range will be set.

Area: Number of device areas
 (automatically set)

Area Number: Selected areas
 (set by user)

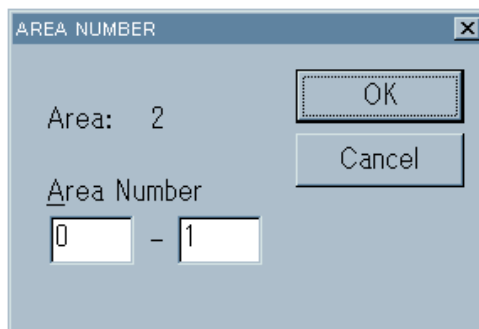

For example, if the area range is specified as 0 to 2 for erasure, Area 0, Area 1, and Area 2 are erased. To specify only one area, enter the same value as the start area and end area.

Caution To set an area, you must set AREA mode by clicking the CHIP/BLOCK/AREA button in the FLASHPRO3 window or by executing [set Area].
For information on changing the mode, see Section 5.3.6.

5.2.3 Voltage

[Voltage] sets the voltage at which the target operates. V_{DD} and V_{PP} voltages differ depending on the device. The V_{DD} and V_{PP} voltages are automatically set by loading the parameter file. However, some devices have two supply voltages, and in this case, the default voltage is automatically set. Change this voltage value, if necessary, depending on the operating conditions. For information on changing the voltage value, refer to the manual for the device.

When [Voltage...] is selected from [Setting...] on the menu bar, the dialog box below opens. Enter a voltage and click the [OK] button. The entered voltage will be set.

Setting range

V_{DD} voltage 1.8 to 6.0 V

V_{PP} voltage 2.7 to 10.3 V

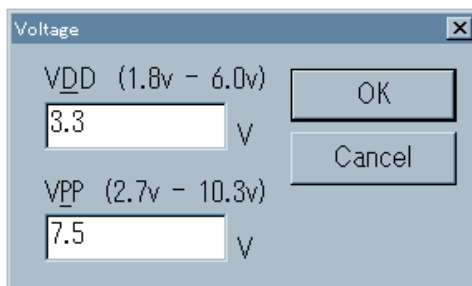

5.2.4 Option

[Option] sets detailed conditions for each device, such as erase time, write time, and convergence time. These conditions are set to the default values when the parameter file is loaded. Unless otherwise specified, use the default values. If incorrect values are specified, the service life of the device may be shortened or the device may be damaged.

Click [Options...] on the [Setting] pull-down menu. The dialog box below will open. Change the parameter setting in this dialog box and click the [OK] button. The setting will be changed.

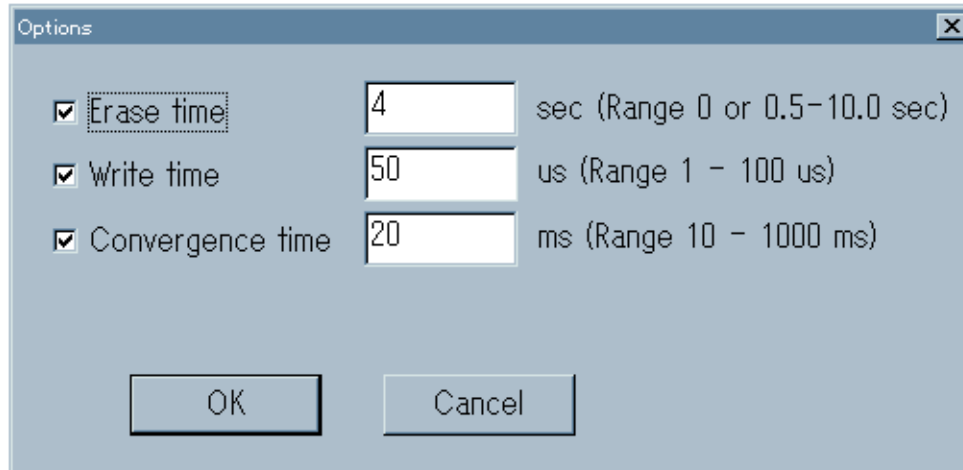

- Erase time: Sets the erase time for the device.
If 0 second is set, erasure processing is not performed.
- Write time: Sets the write time for the device.
- Convergence time: Sets the time of the function that prevents excessive erasing of the device.

5.2.5 Reset

[Reset] restarts the PG-FP3 system. The PG-FP3 must be restarted if you want to check the firmware version, or if the system has failed.

Execute this command by selecting [Reset] from the [Setting] pull-down menu. If the PG-FP3 is restarted correctly, an LED on the PG-FP3 blinks and then LEDs Erase, Program, and Verify light. The firmware version is then displayed in the log window at the lower left of the screen.

5.2.6 Connection Port

The [Connection Port] command sets a port for communication with the PG-FP3. This command is used to change the baud rate or communication port of the host when RS-232C is used.

Click [Connection Port] on the [Setting] pull-down menu to execute this command. When the command is executed, the following dialog box opens, allowing you to set a communication port.

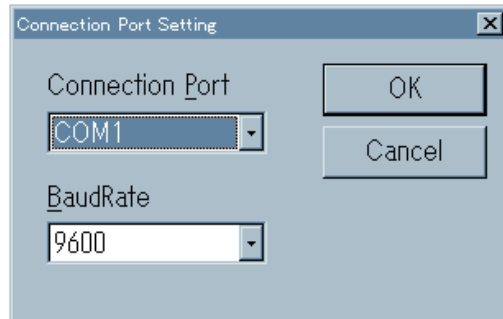

If the printer interface was selected when the PG-FP3 started, the communication port setting must be LPTx. A box for setting a baud rate is displayed in the dialog box, but a setting in this box is ignored.

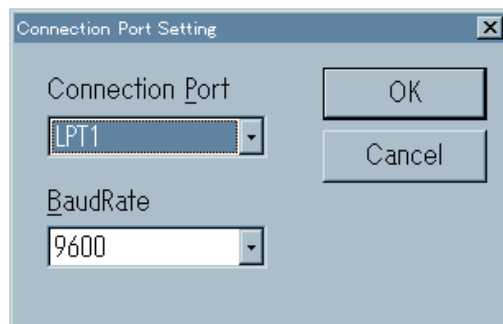

If a wrong port was specified when FLASHPRO3 started, the error dialog box below is displayed. If this dialog box is displayed, check the communication setting, and correct as necessary.

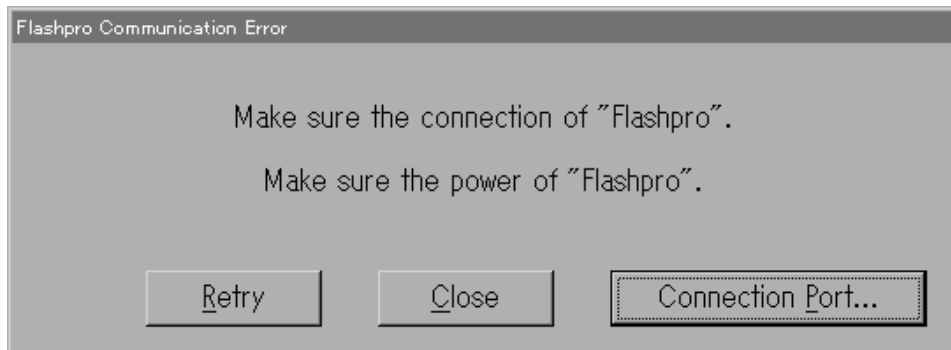

When [Connection Port...] in the dialog box is clicked, a dialog box for port setting opens.

5.3 Procedure

When [Procedure] is clicked, the pull-down menu shown below is displayed. This menu lists commands that manipulate the target by erasing, programming, or verifying the target.

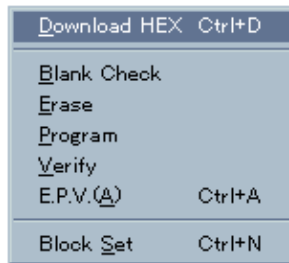

5.3.1 Download HEX

[Download HEX] downloads the user program loaded into FLASHPRO3 with [Load File] to the PG-FP3. The progress of downloading is displayed in the log window. While downloading is in progress, the Load LED of the PG-FP3 blinks.

Execute this command by selecting [Download HEX] from the [Procedure] pull-down menu or by clicking the **Down Load** button on the operation screen.

When the user program has been completely downloaded, the buttons such as [Program] and [Verify], which could not be executed at startup, become active and are ready to be executed.

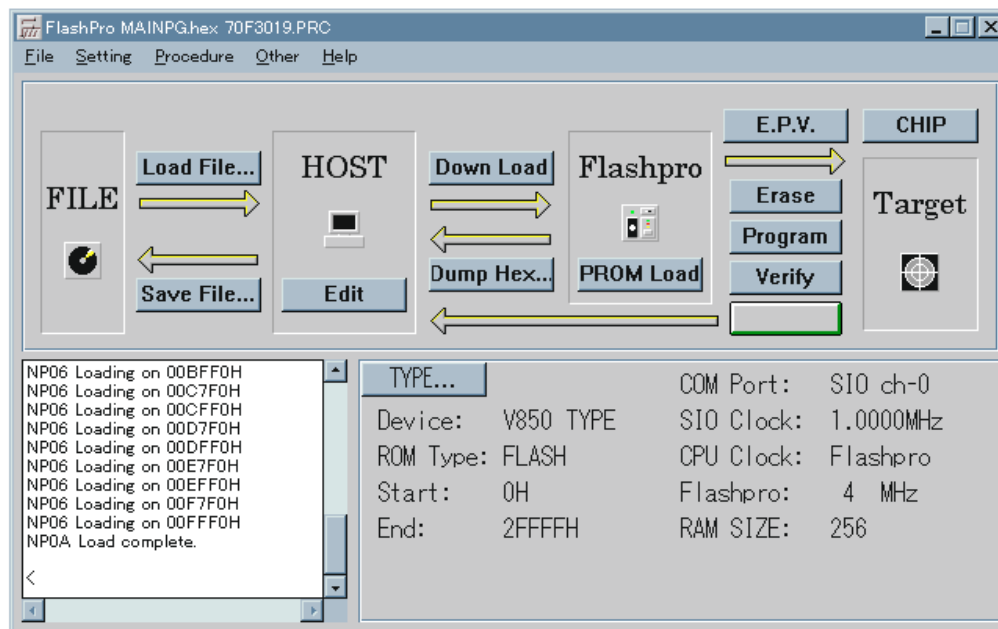

★ 5.3.2 Erase

[Erase] erases the flash memory. Use this command to keep the device with the flash memory erased. To program the flash memory erased by this command, use the [Program] command. A device that has been just delivered to you is blank and can be programmed without having to be erased.

Execute this command by selecting [Erase] from the [Procedure] pull-down menu or by clicking the  button on the operation screen.

While the device is being erased, the progress of erasure is displayed in the log window, and the Erase LED of the PG-FP3 blinks.

Caution The typical erase time is set by the device definition information. Do not change the value set as the erase time except in special circumstances, since the device may be damaged if it is changed. If the target device is erased repeatedly, further erasing may become difficult, and a longer erase time may be required.

During erasure, the following messages are displayed in the log window (they are displayed every second if there is a wait time of second or longer).

```
NP18 Erase setting xxS
NP1E Erase setting OK
NP30 ROM Erasing now... xxS
```

- If erasure is completed normally

```
NP0E ROM Erase... OK.
```

In Block mode, this message is displayed.

```
NP1C ROM Erase... OK. BLOCK x
```

In Area mode, this message is displayed.

```
NP1C ROM Erase... OK AREA x
```

- If erasure is not successful

```
ER13 ROM Erase... Failed.
```

In Block mode, this message is displayed.

```
ER1C ROM Erase.. Failed. BLOCK x
```

In Area mode, this message is displayed.

```
ER5C ROM Erase... Failed. AREA
```

★ **5.3.3 Program**

The [Program] command writes the data sent from the writer into the flash memory. Then, the command verifies whether the write level is secured. Use this command when writing a delivered device for the first time or when writing a microcontroller kept with its flash memory erased. To execute [Program], be sure to download the user program to the PG-FP3. Unless a program is downloaded, the [Program] command cannot be executed.

Execute this command by selecting [Program] from the [Procedure] pull-down menu or by clicking the  button on the operation screen.

While a program is being written, the progress is displayed in the log window, and the Program LED on the PG-FP3 blinks.

Caution The address range in which a program can be written differs depending on the currently set mode (Chip, Block, or Area) and the setting conditions.

While a program is being written, the following messages are displayed in the log window.

```
NP17 Programming 10%
NP17 Programming 20%
      :
NP17 Programming 100%
```

Caution If the write time is too short, this message may not be displayed.

- If the result of writing is OK, the following message is displayed.

```
NP12 Program..OK.
```

- If an error occurs during writing, this message is displayed (the error message displayed depends on the condition).

```
ER14 Program.. Failed at xxxxxH
ER15 Cannot Program
```

When the device has been correctly written to, the data is verified.

The verification is made in either of the following two methods. The PG-FP3 automatically executes the verification in the method that matches the target device.

- <1> Re-sends the written data from the PG-FP3 and verifies the data written in the flash memory against the re-sent data.

```
NP13 Verifying 010 %
NP13 Verifying 020 %
NP13 Verifying 030 %
NP13 Verifying 040 %
NP13 Verifying 050 %
NP13 Verifying 060 %
NP13 Verifying 070 %
NP13 Verifying 080 %
NP13 Verifying 090 %
NP13 Verifying 100 %
NP14 Verify..OK
```

- <2> Reads the data programmed in the flash memory, changing the read level, and verifies the data.

```
NP13 Verifying 01s
NP13 Verifying 02s
NP13 Verifying 03s
      :
NP14 Verify..OK
```

If the result of verification is OK, the program has been written correctly.

★ **5.3.4 Verify**

The [Verify] command sends the written data from the PG-FP3 and verifies the data written in the flash memory against the sent data.

This command does not check the write level. Use this command to check whether data communication between the PG-FP3 and the microcontroller with flash memory has been normally performed.

Execute this command by selecting [Verify] from the [Procedure] pull-down menu or by clicking the  button on the operation screen.

All the data loaded into the memory of the PG-FP3 is verified against the data of the target device. If an area is specified, the data is verified in area units.

This command is usually used to check to see if data has been correctly written after programming.

While verification is being executed, the progress is displayed in the log window, and the Verify LED on the PG-FP3 blinks.

The following messages are displayed in the log window during verification.

```
NP13 Verifying 10%
NP13 Verifying 20%
      :
NP13 Verifying 100%
```

Caution If the verify time is too short, the above message may not be displayed.

- If the result of verification is OK

```
NP14 Verify... OK.
```

In Block mode, this message is displayed.

```
NP1D Verify... OK. BLOCK x
```

In Area mode, this message is displayed.

```
NP1D Verify... OK. AREA x
```

- If verification fails

```
ER16 Verify.. Failed at xxxxxxH
ER17 Verify error.
```

In Block mode, this message is displayed.

```
ER16 Verify.. Failed at xxxxxxH
ER1D Verify error. BLOCK x
```

In Area mode, this message is displayed.

```
ER16 Verify... Failed at xxxxxxH
ER5D Verify error.. AREA x
```

(The error message displayed depends on the condition.)

★ 5.3.5 E.P.V.

The [E.P.V.] command makes a blank check. If the result is OK, the [Program] command is executed. If the check finds an error, the [Erase] command and [Program] command are executed in that order.

When writing a delivered device for a second or subsequent time, use this command.

If the user does not know whether the device has been erased, use this command to write the device.

Execute this command by selecting [E.P.V.] from the [Procedure] pull-down menu or by clicking the  button on the operation screen.

While the command is being executed, the progress is displayed in the log window. At the same time, the Erase, Program, and Verify LEDs on the PG-FP3 light and the LED corresponding the command currently being executed blinks.

The display in the log window is the same as that for each individual command.

The address range during command execution depends on the currently set mode (Chip, Block, or Area) and the range setting condition. In CHIP mode, all space on the target is erased, programmed, or verified. In BLOCK and AREA modes, only the specified address range is erased, programmed, or verified. When executing [E.P.V.] in a mode other than CHIP, therefore, you must specify an address range.

Caution Avoid using this command for the device erased by the [Erase] command. The blank check level of the [E.P.V.] command is the same as that of the [Erase] command. Even if the device has been erased, the blank check by this command would detect an error, owing to voltage fluctuations in operation. If this occurs, the device would be erased again.

★ 5.3.6 Chip set/Block set/Area set

[Chip set/Block set/Area set] selects an operating mode. The display for the command changes depending on the condition of the current mode.

Some devices do not have segment modes such as BLOCK and AREA, or only have one or the other of the modes. Any mode not available to the device is not displayed.

The following explanation assumes that a device with all of the modes (CHIP, BLOCK, and AREA) is being used. Execution of a command is always started in CHIP mode, and the mode changes as follows each time a command has been executed.

CHIP → BLOCK → AREA → CHIP ...

At the same time, the command display and the button display on the operation screen change.

Before executing the Chip set/Block set/Area set command, load the parameter file. Before executing the command, check that the target device is connected. When the command is executed, the application addresses the device according to the parameter file information and device signature information.

If the parameter file is not loaded or if the target device is not connected, correct addressing may not be performed, resulting in a malfunction.



Execute this command to change the mode by selecting [Chip set/Block set/Area set] from the [Procedure] pull-down menu or by clicking the , , or  button on the operation screen.

Figure 5-2. Mode Screens

(a) Block Mode Screen



(b) Area Mode Screen

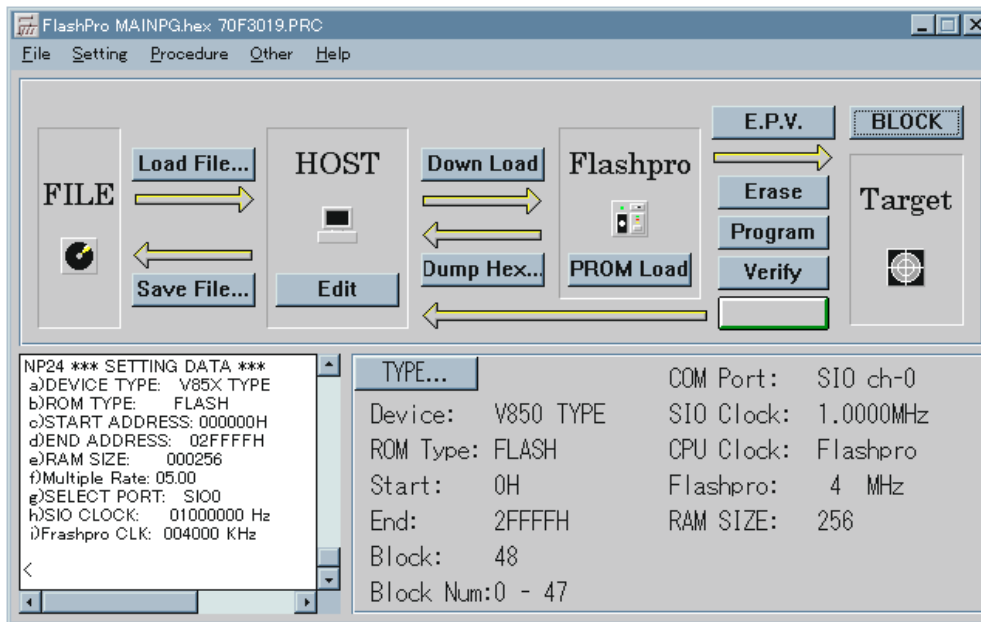
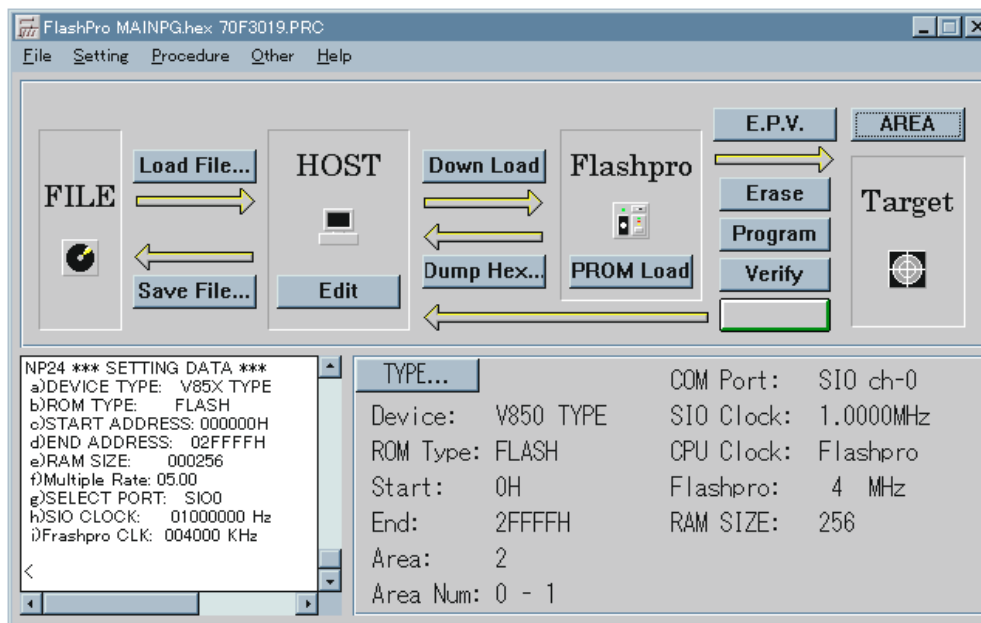

5.4 Other

When [Other] is clicked, the pull-down menu shown below is displayed. This menu mostly lists ancillary function commands.

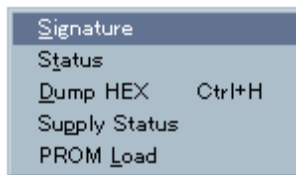

5.4.1 Signature

The [Signature] command reads the signature information of the target device.

Execute this command by selecting [Signature] from the [Other] pull-down menu. When it is executed, the signature information is displayed in the log window as shown at the right.

The figure shown below shows an example of executing a μ PD75F4264 command.

```
NP26 *** SIGNATURE ***  
  
Vendor code = 10H  
ID code     = 7FH  
Electrical Inf. = 41H  
Last Address = 000FFFH  
Device name  = D75F4264  
NP2D Signature END
```

5.4.2 Status

[Status] displays the TYPE information currently set for the PG-FP3 in the log window. This command is used to check if the current PG-FP3 settings are correct or if the current settings are set for the PG-FP3.

Execute this command by selecting [Status] from the [Other] pull-down menu.

The following information is displayed in the log window:

- Device Type
- ROM Type
- Start Address
- End Address
- RAM Size
- Multiple Rate
- Select Port
- SIO Clock/UART bps
- Flashpro Clock/Target Clock

★ 5.4.3 Dump HEX

[Dump HEX] uploads the user program stored on the PG-FP3 to FLASHPRO3 (host side). The uploaded data can be checked by using the [Edit] command.

Execute this command by selecting [Dump HEX] from the [Other] pull-down menu or by clicking the **Dump Hex...** button on the operation screen. When this command is executed, the following dialog box opens, and the addresses to which the program is to be uploaded can be specified.

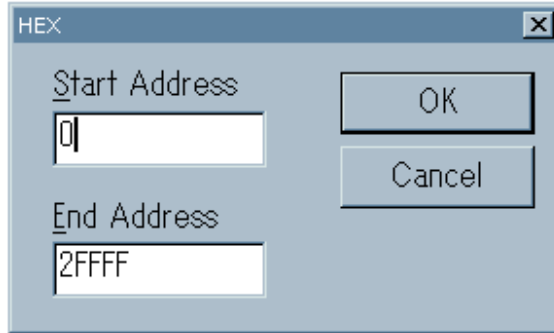

- About [Edit]

[Edit] is used to check the data loaded into or uploaded to FLASHPRO3. The displayed data can be also edited.

Execute this command by clicking the **Edit** button on the operation screen.

When the command is executed, the following window opens and data can be listed or edited.

Figure 5-3. Editor Screen

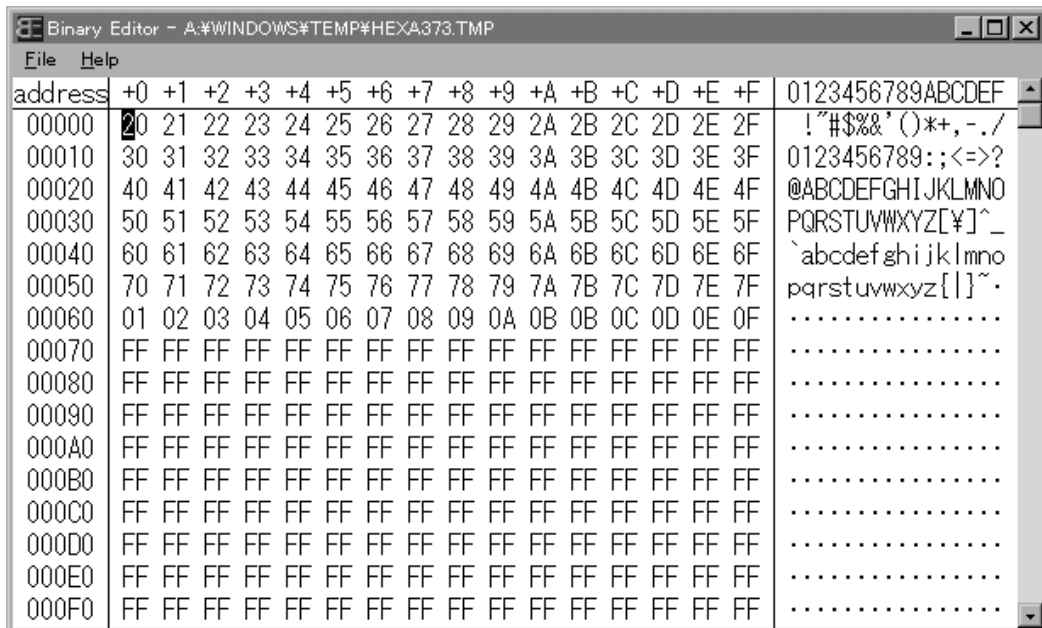

5.4.4 Supply Status

The [Supply Status] command checks the status of the target power supply (V_{DD}). When this command is executed, the status of the target is displayed in the log window.

Execute this command by selecting [Supply Status] from the [Other] pull-down menu.

Use this command to check the status of the target when the target power supply is used, as when data is written on-board.

5.4.5 PROM Load

[PROM Load] downloads data from the master ROM mounted in the master ROM socket of the PG-FP3. Usually, the master ROM is a function that allows you to download the user program when only the PG-FP3 is used. However, data can be also downloaded by using the master ROM from FLASHPRO3.

Execute this command by selecting [PROM Load] from the [Other] pull-down menu or by clicking the **PROM Load** button on the operation screen.

It is assumed that a general EPROM is used as the master ROM. For details on the master ROM socket, see **Section 7.3**. The master ROM command reads the signature of the mounted ROM before the master ROM is downloaded in order to check if the ROM is usable or if the ROM is correctly mounted. If the ROM on the master ROM socket is not supported by the PG-FP3, the dialog box below is displayed. If this happens, replace the ROM with the one supported by the PG-FP3.

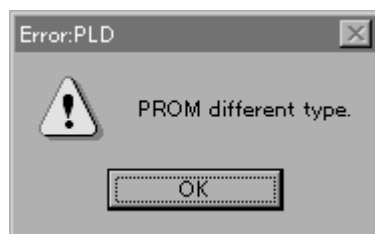

While the master ROM is being accessed, the ACCESS LED lights. Do not remove the ROM while this LED is lit.

5.5 Help

When [Help] is clicked, the pull-down menu shown below is displayed. This menu lists the commands that open the help file or check the version of FLASHPRO3.

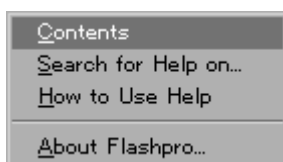

The functions of these commands are as follows:

- Contents..... Displays the table of contents of the help file.
- Search for Help on keyword ... Searches for information based on a keyword.
- How to Use Help Displays information of using the help file.
- About Flashpro3..... Displays the version information for FLASHPRO3.

CHAPTER 6 STAND-ALONE FUNCTION

The stand-alone function erases, programs, or verifies data with the PG-FP3 alone, without the use of a host. This function is used on a production line when the application system is mass-produced, or used to upgrade a customer's version.

6.1 FUNCTION

The commands that can be executed in stand-alone mode are as follows:

- Program command
- Erase command
- Verify command
- E.P.V. command
- PROM Load command

These commands are selected with the PG-FP3 MODE KEY. The command currently selected can be identified by an LED on the PG-FP3. Execute the selected command by pressing the ENTER key. The command is set in the command mode specified by [E.P.V.] when the PG-FP3 is started. The command mode changes as follows each time the MODE key has been pressed:

E.P.V. → Erase → Program → Verify → PROM Load → E.P.V. ...

While a command is being executed, the LED corresponding to the command blinks.

Caution Loading the parameter file and setting the TYPE in stand-alone mode must be performed in advance by the host via FLASHPRO3. The information set using FLASHPRO3 is used as the target setting information recorded in the PG-FP3 in stand-alone mode.

6.2 OPERATION

The PG-FP3 can execute the E.P.V., ERASE, PROGRAM, VERIFY, and PROM Load commands in the stand-alone mode. For processing and using the commands, see **Chapter 5**.

In standalone mode, it is not necessary to connect to a host. However, a parameter file must be loaded from the host and TYPE setting must be performed by the host in advance.

- Selecting the command mode

When power is turned on, E.P.V. mode is set. The mode changes as follows each time the MODE key is pressed:

E.P.V. → ERASE → PROGRAM → VERIFY → LOAD → E.P.V. ...

Photo 6-1. Selecting the Command Mode

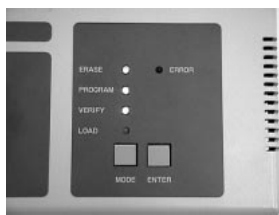

E.P.V. command mode

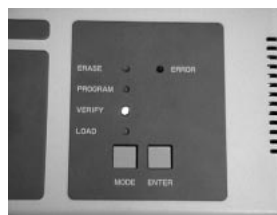

VERIFY command mode

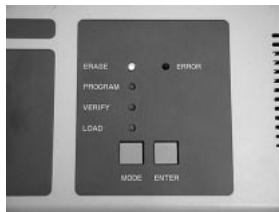

ERASE command mode

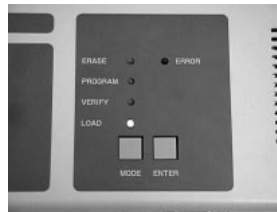

PROM LOAD command mode

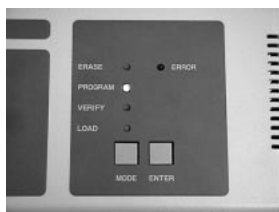

PROGRAM command mode

- Executing a command

To execute the currently selected command, press the ENTER key. While the command is being executed, an LED indicating the mode blinks.

CHAPTER 7 HARDWARE SPECIFICATIONS

7.1 PRODUCT CONFIGURATION AND OPERATING ENVIRONMENT

Table 7-1. Product Configuration and Operating Environment

Item	Specification
Power supply ^{Note}	9.0 V, 2.0 A (AC adapter input, plug: 5.5 DIA, center: "+")
Power consumption	Maximum value: Approx. 15 W
Dimensions	205 × 117 × 32 mm (excluding projections)
Weight	470 g (main unit only)
Operating environment	Temperature: 0°C to +40°C Humidity: 35% to 85% (without condensation)
Storage environment	Temperature: -5°C to +45°C Humidity: 10% to 90% (without condensation)

Note Do not use any power supply other than the AC adapter supplied as an accessory.

7.2 MASTER ROM SOCKET SPECIFICATIONS

- Usage

Mount the master ROM, which downloads the user program, in the 32-pin socket on the top of the PG-FP3.

Photo 7-1. Mounting the Master ROM



Mount the PROM to which a program has been written in the master ROM socket and execute from the FLASHPRO3 the command that downloads data from the master ROM. The data can be also downloaded from the master ROM by pressing the MODE key on the PG-FP3 to set LOAD MODE (the LOAD LED lights) and then pressing the ENTER key.

[Operation from the FLASHPRO3]

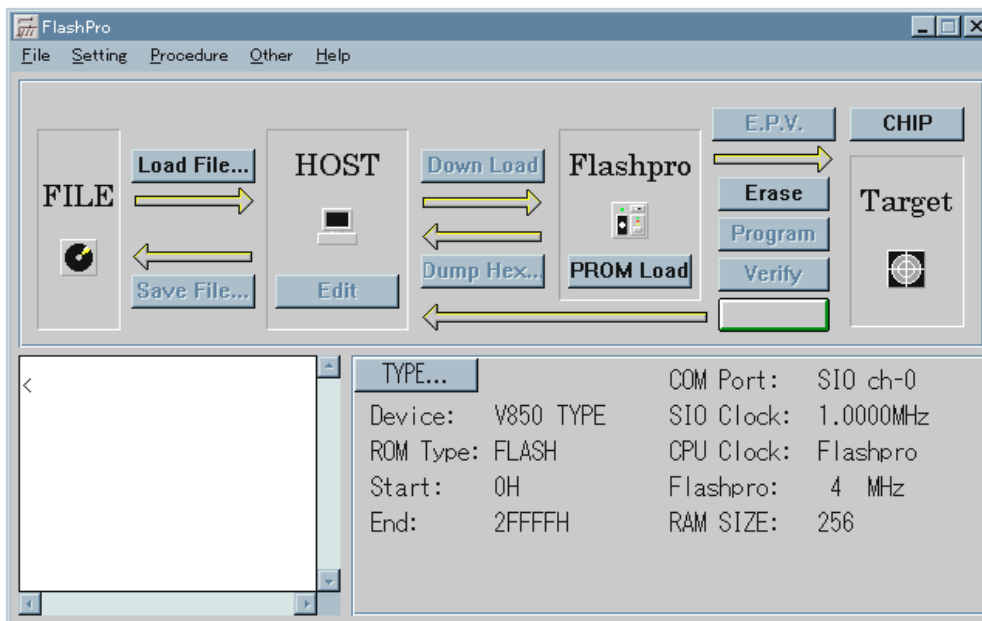

Either click the [PROM Load] button on the screen, or execute the [PROM Load] command from [Procedure].

[Operation from PG-FP3]

Mount the PROM in the master ROM socket of the PG-FP3.

Photo 7-2. Mounting the PROM in the Master ROM Socket

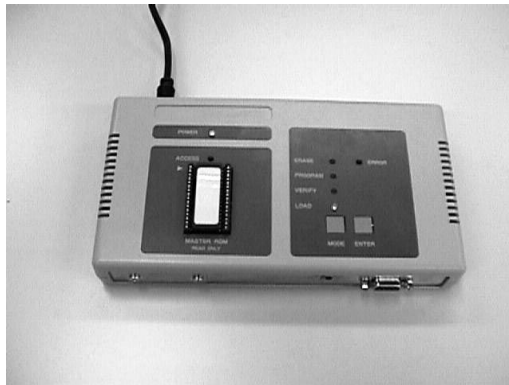

Press the MODE key. Make sure that only the Load LED lights (Load mode). In Load mode, press the ENTER key. The [PROM Load] command will be executed.

Photo 7-3. Executing the [PROM Load] Command

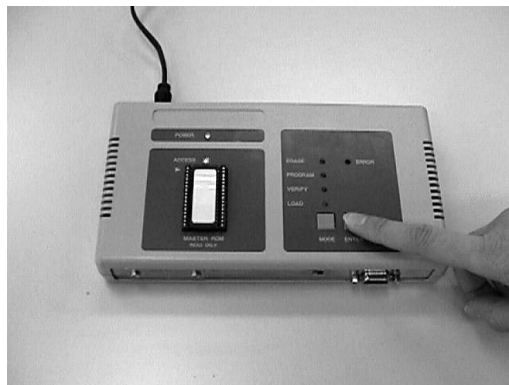

While the master ROM is being accessed, the ACCESS LED lights. Do not remove the PROM from the master ROM while this LED is lit; otherwise, the PG-FP3 and PROM may be damaged.

If an error message is displayed while the [PROM Load] command is being executed, read the message, and take corrective measures by seeing **Chapter 8**. Only the ERROR LED lights if the PG-FP3 is used in stand-alone mode. Check for any damage, and check the mounting direction and the type of the PROM in the case. For a usable PROM, see "Supported ROM specifications" on the next page.

★ • Supported ROM specifications

Only an EPROM with 32 or fewer pins and the pin configuration shown below can be used as the master ROM. When the master ROM is accessed, the signature of the PROM is read to check whether the PROM is supported. If the signature cannot be correctly read, replace the PROM with a compatible PROM of another make.

An attempt to download a program from the master ROM socket by using a product other than a PROM and a jig may damage the ROM socket. Never make such an attempt.

The following is pin configuration.

Figure 7-1. Pin Configuration (Top View)

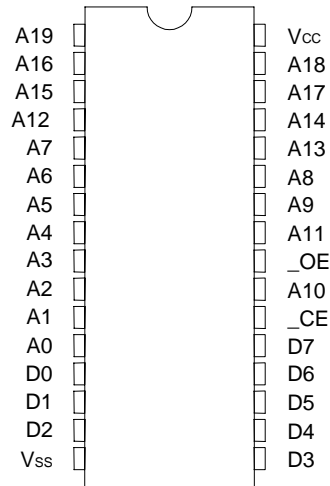

Table 7-2. Pin List

Pin	Signal name	Pin	Signal name	Pin	Signal name	Pin	Signal name
1	A19 ^{Note}	9	A3	17	D3	25	A11
2	A16	10	A2	18	D4	26	A9
3	A15	11	A1	19	D5	27	A8
4	A12	12	A0	20	D6	28	A13
5	A7	13	D0	21	D7	29	A14
6	A6	14	D1	22	_CE	30	A17
7	A5	15	D2	23	A10	31	A18 ^{Note}
8	A4	16	V _{ss} (GND)	24	_OE	32	V _{cc}

Note The pin list shown in Table 7-2 is for a 1-Mbyte model. A19 and A18 of the 512-Kbyte and 256-Kbyte models are NC.

★ **7.3 HOST INTERFACE**

There are two types of host interfaces: the RS-232C interface and the printer interface.

Select either using the I/F SELECT switch. When the PG-FP3 is started, the software identifies the switch setting. Note that once an interface has been selected, it cannot be changed until power is turned off and then back on again.

7.3.1 Printer Interface Specifications

The printer interface uses the parallel port provided on most personal computers as standard. Some parallel ports, however, do not support bidirectional communication and ECP mode. To find out whether a port supports bidirectional communication and ECP mode, consult the manufacturer of the personal computer. The printer interface specifications, which conform to IEEE 1284-1994, are as follows:

Table 7-3. Printer Interface Specifications

Item	Specification	
Interface connector	Half-pitch 36-pin (receptacle) standard: 10236-52A2JL, manufacturer: 3M	
Operating mode	Compatible mode, ECP mode supported ^{Note}	
Electrical characteristics	Data signal	74LS24× or equivalent Pull-up resistor: 1.2 k Ω , damping resistor: 33 Ω
	Input control signal	74LS24× or equivalent Pull-up resistor: 1.2 k Ω
	Output control signal	74LS24× or equivalent Damping resistor: 33 Ω

If communication settings are not correctly performed, the Connection Port error dialog box may open. If this happens, check if the Connection Port setting is correct.

The specifications of the interface connector and specifications of the interface cable are given on the next page.

Note Be sure to use a host computer that supports ECP mode.

[Pin layout]

Pin	IN/OUT	Compatible mode	ECP mode
1	OUT	Busy	PeriphAck
2	OUT	Select	Xflag
3	OUT	Nack	PeriphClk
4	OUT	Nfault	nPeriphRequest
5	OUT	PError	nAckReverse
6	IN/OUT	Data 1 (Least Significant Bit)	
7	IN/OUT	Data 2	
8	IN/OUT	Data 3	
9	IN/OUT	Data 4	
10	IN/OUT	Data 5	
11	IN/OUT	Data 6	
12	IN/OUT	Data 7	
13	IN/OUT	Data 8 (Most Significant Bit)	
14	IN	Ninit	nReverseRequest
15	IN	Nstobe	HostClk
16	IN	NselectIn	IEEE1284 active
17	IN	NautoFd	HostAck
18	IN	Host Logic High	
19	–	Signal Ground (Busy)	
20	–	Signal Ground (Select)	
21	–	Signal Ground (nAck)	
22	–	Signal Ground (nFault)	
23	–	Signal Ground (PError)	
24	–	Signal Ground (Data1)	
25	–	Signal Ground (Data2)	
26	–	Signal Ground (Data3)	
27	–	Signal Ground (Data4)	
28	–	Signal Ground (Data5)	
29	–	Signal Ground (Data6)	
30	–	Signal Ground (Data7)	
31	–	Signal Ground (Data8)	
32	–	Signal Ground (nInit)	
33	–	Signal Ground (nStrobe)	
34	–	Signal Ground (nSelectIn)	
35	–	Signal Ground (nAutoFd)	
36	OUT	Peripheral Logic High	

[Cable specifications]

Item	Specification	Connection		Recommended cable	
PC/AT or compatible machine, PC98-NX cable	PG-FP3 side connector : Half-pitch 36-pin (plug)	D-SUB Plug 25-pin	Half pitch Plug 36-pin	Accessory IEEE1284 cable PC/AT	
	Host side connector : D-SUB 25-pin (plug)	1 --- 15	2 --- 6		
	3 --- 7	4 --- 8	5 --- 9		6 --- 10
	7 --- 11	8 --- 12	9 --- 13		10 --- 3
	11 --- 1	12 --- 5	13 --- 2		14 --- 17
	15 --- 4	16 --- 14	17 --- 16		18 --- 33
	19 --- 24, 25	20 --- 26, 27	21 --- 28, 29		22 --- 30, 31
	23 --- 19, 22	24 --- 20, 21, 23	25 --- 32, 34, 35		Short --- 18, 36

Item	Specification	Connection		Recommended cable	
PC-9800 cable	PG-FP3 side connector	Plug 36-pin	Plug 36-pin	Accessory IEEE1284 cable PC-98	
	: Half-pitch 36-pin (plug)	1	---		1
	Host side connector	2	---		2
	: Half-pitch 36-pin (plug)	3	---		3
		4	---		4
		5	---		5
		6	---		6
		7	---		7
		8	---		8
		9	---		9
		10	---		10
		11	---		11
		12	---		12
		13	---		13
		14	---		14
		15	---		15
		16	---		16
		17	---		17
		18	---		18
		19	---		19
		20	---		20
		21	---		21
		22	---		22
		23	---		23
		24	---		24
		25	---		25
		26	---		26
		27	---		27
		28	---		28
		29	---		29
		30	---		30
		31	---		31
		32	---		32
		33	---		33
		34	---		34
		35	---		35
	36	---	36		

7.3.2 RS-232C Interface Specifications

The specifications of the RS-232C interface are as follows:

Table 7-4. RS-232C Interface Specifications

Item	Specification
Interface connector	D-SUB 25-pin (receptacle) standard: RDEF-9S-LNA, manufacturer: Hirose
Connection	Connected to host with straight cable
Baud rate	9600, 19200, 38400, or 57600 bps
Communication settings	Data: 8 bits Stop bit: 2 bits Parity bit: None Flow control: None

If the RS-232C interface is selected when the PG-FP3 starts, the default baud rate of 9600 bps is set. Unless the baud rate of the application is also 9600 bps on startup, the PG-FP3 cannot connect to the host, possibly causing the Connection Port error dialog box to open. If this happens, correct the setting.

Figure 7-2. Communication Error Dialog Box

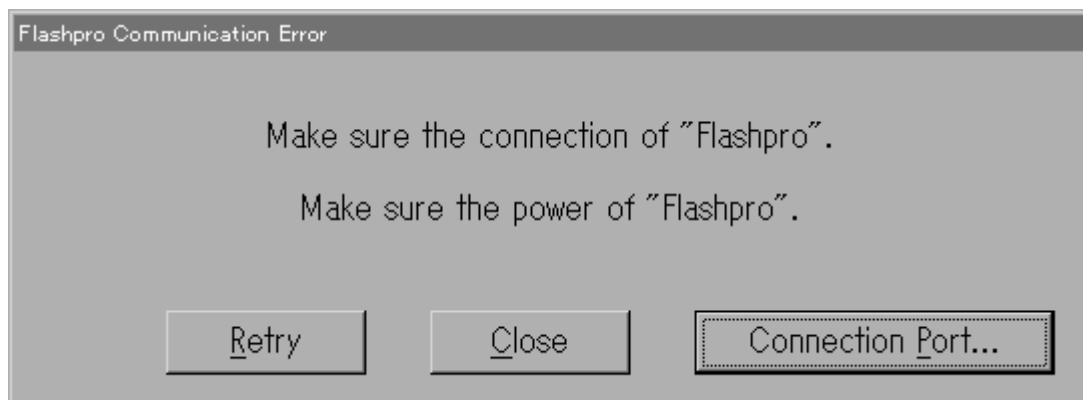

If communication is not performed correctly, the Connection Port and communication settings are probably wrong. Check the settings. For information on performing communication settings, refer to the Windows manual.

The interface connector specifications and interface cable specifications are given on the next page.

[Pin layout]

Pin	Signal name	IN/OUT	Specification
1	GND	–	Common signal line
2	RxD	IN	Serial data input
3	TxD	OUT	Serial data output
4	CS	IN	Data control signal input
5	RS	OUT	Data control signal output
6	DSR	OUT	Data control signal output (not used)
7	GND	–	Common signal line
8	DCD	OUT	Data control signal output (not used)
9	NC	–	
10	NC	–	
11	NC	–	
12	NC	–	
13	NC	–	
14	NC	–	
15	NC	–	
16	NC	–	
17	NC	–	
18	NC	–	
19	NC	–	
20	DTR	IN	Data control signal input (not used)
21	NC	–	
22	NC	–	
23	NC	–	
24	NC	–	
25	NC	–	

[Cable specifications]

Item	Specification	Connection	
PC/AT or compatible machine, PC98-NX cable	PG-FP3 side connector : D-SUB 25-pin (plug) Host side connector : D-SUB 9-pin (receptacle) Connection : Straight	D-SUB 25-pin 2 3 4 5 6 7 8 20 22	D-SUB 9-pin 3 2 7 8 6 5 1 4 9
PC-9800 cable	PG-FP3 side connector : D-SUB 25-pin (plug) Host side connector : D-SUB 25-pin (plug) Connection : Straight	D-SUB 25-pin 1 2 3 4 5 6 7 8 20 22	D-SUB 9-pin 1 2 3 4 5 6 7 8 20 22

7.4 TARGET INTERFACE SPECIFICATIONS

The target interface has signals such as GND, SI, SO, SCK, CLK, _RESET, V_{DD}, V_{PP}, and HS. These signals are used to connect the target. For the information on the required signal lines, refer to the user's manual for each device.

The PG-FP3 comes with two types of cables that can be used to connect the target. Use of these cables is recommended.

The target interface is provided with a protection circuit that protects the PG-FP3 from damage due to input of an overvoltage from an external source. This protection circuit disconnects from the target a signal line that may cause damage if a signal line with a voltage higher than the rated voltage is connected to the interface by mistake. The circuit also informs the user of the abnormal condition. If an abnormal condition is detected, check whether the interface is correctly connected and whether the target is normal. The overvoltage level each signal line of the interface can withstand is shown below. If a voltage exceeding this level is applied to a signal line, the PG-FP3 may be damaged.

Table 7-5. Withstand Voltage of Each Interface Signal

Signal name	Specification
SI, SO, SCK, CLK _RESET, V _{DD}	Normal maximum level: 5.0 V Voltage level when an abnormal condition is detected: 6.0 to 15.0 V
V _{PP}	Normal maximum voltage level: 10.0 V Voltage level when an abnormal condition is detected: 11.0 to 15.0 V

7.4.1 Interface Specifications

Use the target interface connector to interface with the target.

Bear in mind the following points when connecting the target and designing the target board.

- Supply voltage and operating clock of target

Basically, supply the power and operating clock to the microcontroller from the target board when programming its flash memory. Power can be also supplied from the PG-FP3, but **a current high enough to operate the entire target cannot be supplied**. In addition, the frequency of the clock that can be supplied from the PG-FP3 is limited to 16, 8, 4, and 2 MHz.

When supplying power and a clock from the PG-FP3, use a dedicated writing adapter such as the FA adapter^{Note}. The level of each interface signal is converted in the PG-FP3 at the operating voltage (V_{DD}). Therefore, even when the power supply (V_{DD}) on the user target is used, connect the V_{DD} line to the target. With a device using two supply voltages and requiring interface signals of different levels, output either of the voltage levels from the PG-FP3, and convert the level of the signal with the different signal level on the target.

- Signal conflict

If an output from another device is connected to the serial interface pin and reset pin, a signal conflict or malfunction may occur. If this occurs, either isolate the connection with the other device, or make the output from the other device high impedance. Exercise care so that the target is not inadvertently reset during programming.

- Connection of serial port

When programming flash memory using a UART or SIO, match the input/output of the SI and SO signals when connecting the SI (RxD) and SO (TxD) signals of the PG-FP3 to the SI (RxD) and SO (TxD) of the target.

PG-FP3 side		Microcontroller side
SI (RxD)	← →	SO (TxD)
SO (TxD)	← →	SI (RxD)

When interfacing with IIC, the SI pin of the PG-FP3 serves as a SD (serial data) line. Therefore, connect the SCK and SI pin.

Note The FA adapter is a product of Naito Densai Machida Mfg. Co., Ltd.

- PG-FP3 pins not wired

Keep in mind the following points:

- Open the CLK signal of the PG-FP3 to supply a clock to the microcontroller from the target.
- Open the SCK signal when using a UART.
- Open the SO signal when using IIC.
- Open the HS signal when **not using** SIO + handshaking.

The pin configuration of the target interface connector and specifications of the interface cable are given below.

[Pin configuration]

Pin	Signal name	IN/OUT	Specification
1	GND	–	Common signal
2	SI (Rx/D)	IN/OUT	Serial data I/O (3-wire, UART, IIC)
3	SO (Tx/D)	OUT	Serial data output (3-wire, UART)
4	SCK	OUT	Serial clock output in 3-wire, IIC mode
5	CLK	OUT	Clock output to target (Select 16, 8, 4, or 2 MHz.)
6	_RESET	OUT	RESET signal output to target (Low: RESET ON)
7	V _{DD}	IN/OUT	V _{DD} input/output to target (Select I/O with select switch.)
8	V _{PP}	OUT	V _{PP} output to target
9	HS	OUT	Handshaking signal output of 3-wire + handshaking communication

[Cable specifications]

Two types of target interface cables (IC clip type (TYPE 1) and connector type (TYPE 2)) are supplied. Use the appropriate cable for the situation.

If the supplied cables cannot be used because of the specifications of the target and the user prepares a cable, keep the cable length to within 40 cm and use materials with frequency characteristics equivalent to those of the supplied cables.

Note, however, that an error may occur during communication and operation may not be performed correctly if a cable other than those supplied is used because communication rate is too high for the communication setting.

The following are the specifications for each cable.

Item	Specification	Connection	Remarks
TYPE 1	PG-FP3 side connector: D-SUB 9-pin (plug) Standard: FDE-9P (05) Manufacturer: Hirose Target side connector: IC clip (9 pcs)	D-SUB Plug 9-pin 1 --- GND (black) 2 --- SI (yellow) 3 --- SO (blue) 4 --- SCK (white) 5 --- CLK (green) 6 --- _RESET (green) 7 --- V _{DD} (red) 8 --- V _{PP} (green) 9 --- HS (green)	
TYPE 2	PG-FP3 side connector: D-SUB 9-pin (plug) Standard: FDE-9P (05) Manufacturer: Hirose Target side connector: FAS connector 10-pin (receptacle) Standard: FAS-1001-2101 Manufacturer: Yamaichi Electric	D-SUB Plug 9-pin 1 --- 1 2 --- 2 3 --- 3 4 --- 4 5 --- 5 6 --- 6 7 --- 7 8 --- 8 9 --- 9 10 (Open)	<p>(When viewed from socket)</p> <p>Pin configuration of FAS connector</p>

7.4.2 Equivalent Circuit and Load Condition

The interface equivalent circuit between the PG-FP3 and the target and the load condition that must be satisfied by the target are as follows:

- SI I/O pin

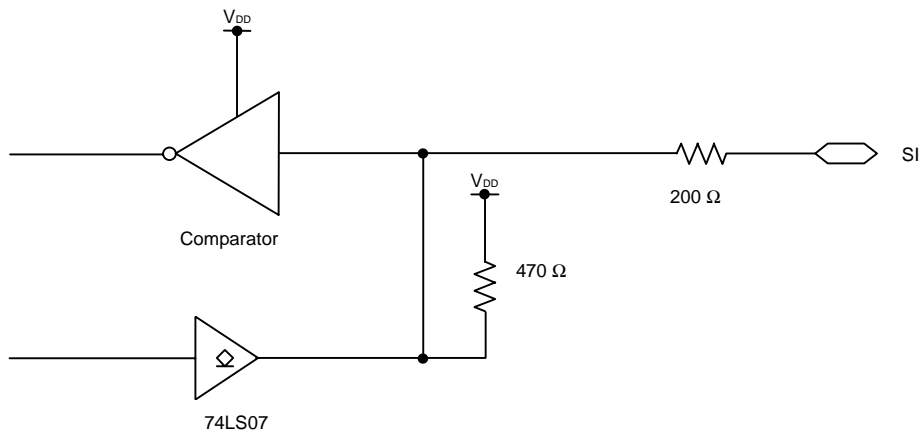

- SO and RESET output pins

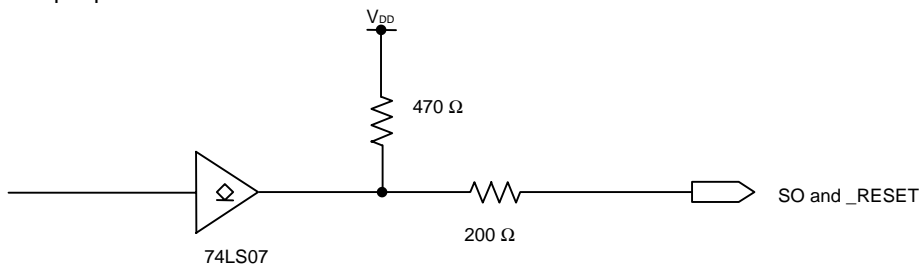

- CLK output pin

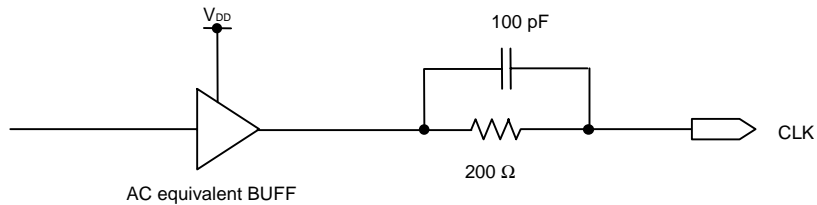

- SCK I/O pin

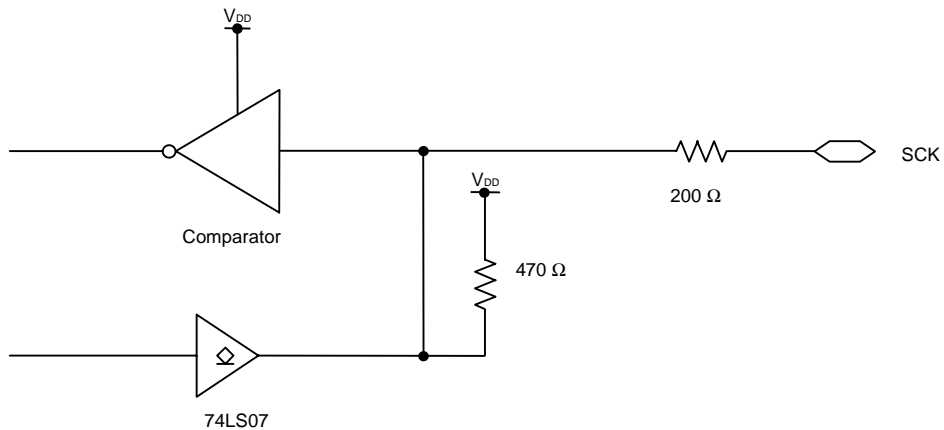

- HS input pin

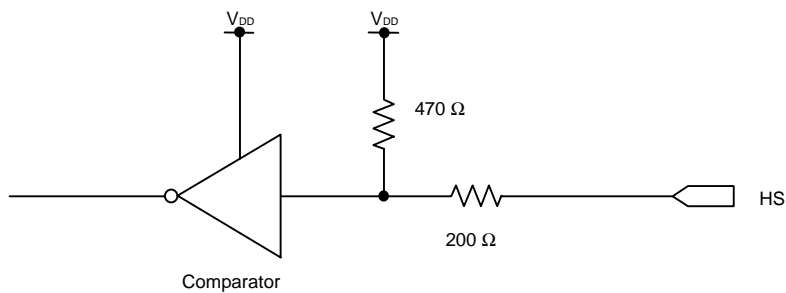

- Target load condition

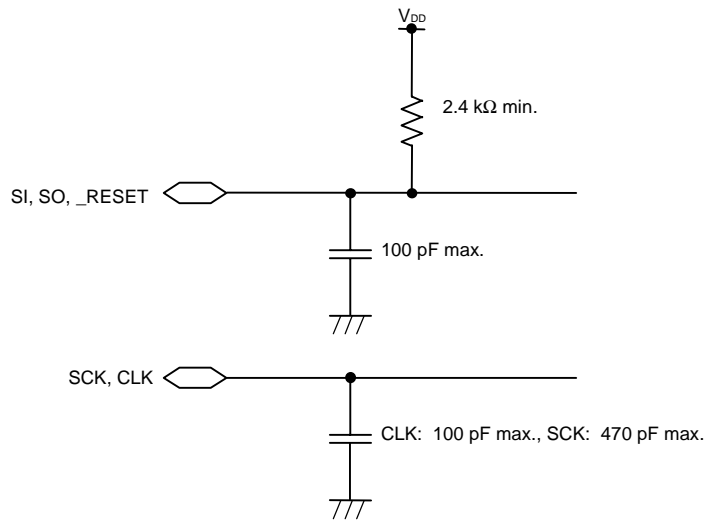

[MEMO]

CHAPTER 8 ERROR MESSAGES AND REMEDIAL ACTIONS

Error No.	Message	Cause/action	
		Cause	Action
ER01	Illegal command.	Cause	Input of wrong command
		Action	Enter the correct command.
ER02	Illegal parameter.	Cause	Input of wrong parameter during command input
		Action	Enter the correct parameter.
ER03	Host is closed.	Cause	Incorrect interfacing with host machine
		Action	Check the connection between the PG-FP3 and the host.
ER04	Flash memory cannot read.	Cause	An attempt was made to read flash memory.
		Action	Flash memory cannot be read.
ER05	SYSTEM error.	Cause	PG-FP3 system error
		Action	The PG-FP3 may be damaged.
ER06	Intel HEX format error.	Cause	Intel HEX format cannot be recognized.
		Action	Check to see if the file is in Intel HEX format, and reload the file.
ER07	Check sum error	Cause	A checksum error was detected during loading.
		Action	Load the file again.
ER08	Target initialize error.	Cause	Initialization with the target microcontroller cannot be made.
		Action	Check to see if the target device was correctly set with the TYPE command.
ER09	Target no SIGNATURE.	Cause	The set target microcontroller has no signature.
		Action	Check to see if the target device was correctly set with TYPE setting.
ER0A	No EEPROM.	Cause	The set target microcontroller has no EEPROM.
		Action	Check to see if the target device was correctly set with TYPE setting (cannot be read).
ER0B	Target return error.	Cause	The target microcontroller is not normal.
		Action	Communication with the target device is not normal. Check to see if the correct communication rate was set with the TYPE command.
ER0C	Target status no return.	Cause	An error was detected during communication with the target device.
		Action	Check the connection with the target device again.
ER0D	SW STOP!!	Cause	Execution has been forcibly terminated with the Start/Stop switch.
		Action	Redo the processing from the beginning.
ER0E	No character.	Cause	An illegal character was detected in the displayed character string.
		Action	Turn off power to the PG-FP3 and then back on again.
ER0F	This DEVICE is NO BLOCK	Cause	The set target device is not divided into blocks.
		Action	Block manipulation commands cannot be used if a microcontroller that is not divided into blocks was selected with the TYPE command.
ER10	EEPROM size over flow.	Cause	The size of the EEPROM exceeds 64 Kbytes.
		Action	Check the Start/End address in the TYPE setting.

Error No.	Message	Cause/action	
		Cause	Action
ER11	ECC address error.	Cause	An incorrect ECC address was entered.
		Action	Check the entered ECC address and reexecute.
ER12	Blank check.. Failed	Cause	The target microcontroller is not blank.
		Action	Erase the target microcontroller with the Erase command.
ER13	ROM Erase.. Failed	Cause	The target microcontroller cannot be erased.
		Action	The microcontroller may be damaged.
ER14	Program.. Failed at XXXXXXH	Cause	A write error was detected at address XXXXXXH.
		Action	Erase the device with the Erase command and execute writing again.
ER15	Cannot program.	Cause	An error was detected during writing.
		Action	Erase the device with the Erase command and execute writing again.
ER16	Verify.. Failed at XXXXXXH	Cause	A verify error was detected at address XXXXXXH.
		Action	Erase the device with the Erase command and execute writing again.
ER17	Verify error.	Cause	An error was detected during verification.
		Action	Erase the device with the Erase command and execute writing again.
ER18	Erase Verify error.	Cause	Excessive erasing was detected.
		Action	The microcontroller may be damaged.
ER19	Device error.	Cause	Excessive erasing was detected.
		Action	The microcontroller may be damaged.
ER1A	SLAVE ADDRESS ERROR	Cause	IIC communication error
		Action	Check the connection with the target system.
ER1B	Blank check.. Failed BLOCK xx	Cause	The specified block is not blank.
		Action	Erase the specified block with the Erase command.
ER1C	ROM Erase.. Failed BLOCK xx	Cause	The specified block cannot be erased.
		Action	The specified block may be damaged.
ER1D	Verify error BLOCK xx	Cause	A verify error was detected in the specified block.
		Action	Erase the block with the Erase command, and re-execute writing.
ER1E	Device error BLOCK xx	Cause	Excessive erasing was detected in the specified block.
		Action	The microcontroller may be damaged.
ER1F	Erase setting error. BLOCK	Cause	A pre-write error was detected in the specified block.
		Action	The microcontroller may be damaged.
ER20	Cannot save TYP.	Cause	The TYPE settings cannot be saved to the PG-FP3.
		Action	The internal flash memory in the PG-FP3 may have been destroyed.
ER21	PROM different type.	Cause	The master ROM mounted in the socket is not supported.
		Action	Replace the master ROM with the one supported by the PG-FP3.
ER22	System flash error.	Cause	An abnormal condition was detected in the PG-FP3 memory.
		Action	The internal flash memory in the PG-FP3 may have been destroyed.
ER23	Flash time out error.	Cause	The memory in the PG-FP3 cannot be accessed.
		Action	The internal flash memory in the PG-FP3 may have been destroyed.

Error No.	Message	Cause/action	
		Cause	Action
ER24	Cannot get TYPE data.	Cause	The data stored in flash memory cannot be read.
		Action	The internal flash memory in the PG-FP3 may have been destroyed.
ER26	Over run error.	Cause	An overrun error was detected during communication with the host machine.
		Action	Check the connection environment with the host machine.
ER27	Framing error.	Cause	A framing error was detected during communication with the host machine.
		Action	Check the connection environment with the host machine.
ER28	Parity error.	Cause	A parity error was detected during communication with the host machine.
		Action	Check the connection environment with the host machine.
ER30	Illegal select BLOCK !	Cause	The block set with TYPE setting does not exist.
		Action	Check the block information in the TYPE settings.
ER31	EPV is not supported BLOCK operation	Cause	The E.P.V. command was executed in the BLOCK mode.
		Action	The version of the PG-FP3 terminal software does not match.
ER32	Cannot execute when ECC set.	Cause	An attempt was made to perform batch processing with a device with ECC memory.
		Action	Batch processing cannot be performed with a device with ECC memory.
ER33	ECC BLOCK address unknown.	Cause	An ECC memory address was not entered.
		Action	An ECC memory address was not entered correctly.
ER34	Unpacked BCD format error.	Cause	A value exceeding the range was specified.
		Action	The version of the PG-FP3 terminal software does not match.
ER35	Cannot get SLAVE address. (1 bit)	Cause	IIC communication error
		Action	Check the wiring and other devices on IIC.
ER36	Cannot get SLAVE address. (9 bit)	Cause	IIC communication error
		Action	Check the wiring and other devices on IIC.
ER37	Cannot get SLAVE address. (ACK)	Cause	IIC communication error
		Action	Check the target microcontroller.
ER38	IIC WRITE error. (1 bit)	Cause	IIC communication error
		Action	Check the wiring and other devices on IIC.
ER39	IIC WRITE error. (9 bit)	Cause	IIC communication error
		Action	Check the wiring and other devices on IIC.
ER3A	IIC WRITE error. (ACK)	Cause	IIC communication error
		Action	Check the target microcontroller.
ER3B	IIC READ error. (1 bit)	Cause	IIC communication error
		Action	Check the wiring and other devices on IIC.
ER3C	IIC READ error. (9 bit)	Cause	IIC communication error
		Action	Check the wiring and other devices on IIC.

Error No.	Message	Cause/action	
		Cause	Action
ER3D	IIC READ error. (ACK)	Cause	IIC communication error
		Action	Check the target microcontroller.
ER3E	Illegal select AREA.	Cause	The area set with TYPE setting does not exist.
		Action	Check the area information in the TYPE settings.
ER40	CPU RAM error.	Cause	An abnormal condition was detected in the internal RAM of the PG-FP3.
		Action	The PG-FP3 may be damaged.
ER41	Expansion RAM error.	Cause	An abnormal condition was detected in the expansion RAM of the PG-FP3.
		Action	The PG-FP3 may be damaged.
ER42	Illegal SW Target ON.	Cause	The POWER SELECT switch is V _{DD} OUT but USER V _{DD} is supplied.
		Action	Do not supply power (V _{DD}) from the target when the POWER SELECT switch is V _{DD} OUT.
ER43	Illegal SW Target OFF.	Cause	The POWER SELECT switch is USER V _{DD} but USER V _{DD} is not supplied.
		Action	Supply power (V _{DD}) from the target when the POWER SELECT switch is USER V _{DD} .
ER44	Target is closed.	Cause	The target system is not connected.
		Action	Check the connection of the target system.
ER45	IIC SCLK is Low level.	Cause	The SCK pin does not go high.
		Action	Check the SCK pin of the target system.
ER50	VPP OUT CURRENT error.	Cause	An excess V _{PP} current was detected.
		Action	Check the V _{PP} pin of the target system.
ER51	VDD OUT CURRENT error.	Cause	An excess V _{DD} current was detected.
		Action	Check the V _{DD} pin of the target system.
ER52	VCC (+5V) CURRENT error.	Cause	An excess V _{CC} (+5 V) current was detected.
		Action	The PG-FP3 may be damaged.
ER53	EPROM VPP CURRENT error.	Cause	An excess EPROM V _{PP} current was detected.
		Action	Check the master PROM. Alternatively, Flashpro3 may be damaged.
ER54	User VDD error.	Cause	The target system voltage is abnormal.
		Action	Check the voltage of the target system.
ER5B	Blank check.. Failed AREA	Cause	The specified area is not blank.
		Action	Erase the specified area with the Erase command.
ER5C	ROM Erase.. Failed AREA	Cause	The specified area cannot be erased.
		Action	The specified area may be damaged.
ER5D	Verify error. AREA	Cause	A verify error was detected in the specified area.
		Action	Erase the area with the Erase command, and reexecute writing.
ER5E	Device error. AREA	Cause	Excessive erasing was detected in the specified area.
		Action	The microcontroller may be damaged.
ER5F	Erase setting error. AREA	Cause	A pre-write error was detected in the specified area.
		Action	The microcontroller may be damaged.

APPENDIX A NOTES ON DESIGNING A TARGET

Design a board using a flash microcontroller if you want to study the possibility of on-board writing.

- Pin processing

The target may have pins that require special processing when the mode is changed from normal operating mode to flash memory programming mode, or pins that go to high-impedance during programming. In a mode in which the operation of the microcontroller is stopped by pin processing, the programming operation cannot be performed. Therefore, be sure to read the manual for the device before creating the target.

- Interface circuit for the PG-FP3

Interface circuit examples for a UART (asynchronous communication port) and SIO (3-wire clocked port) are given below. Because the PG-FP3 senses the voltage on the target even when V_{DD} is not supplied to the target, be sure to connect the V_{DD} pin. For information on pin processing of the device, be sure to refer to the manual for the device used.

★

Figure A-1. Interface Circuit Example for a UART

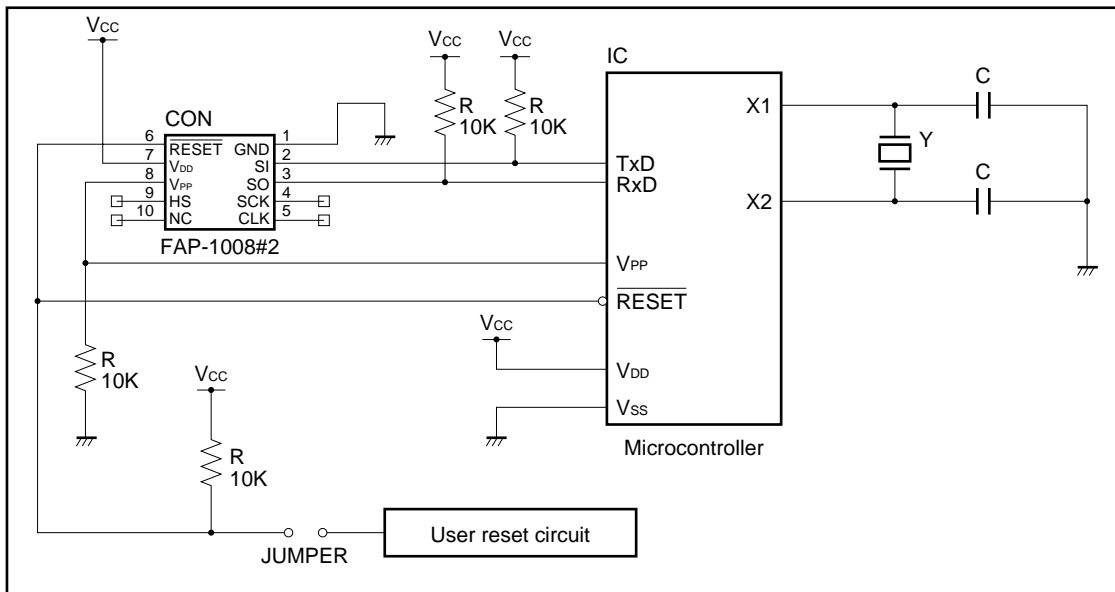

★

Figure A-2. Interface Circuit Example for SIO

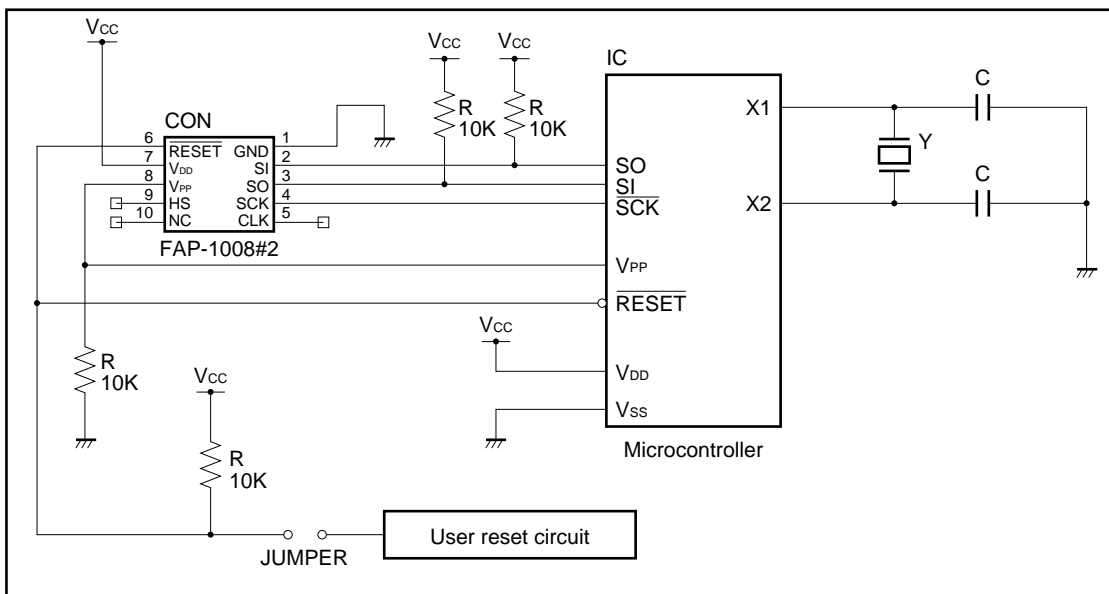

★

APPENDIX B REVISION HISTORY

The revision history of this manual is listed below. The applicable chapter column indicates the chapters in the corresponding edition.

Edition	Description	Applicable chapter
Second edition	The setting of the baud rate in the RS-232C interface specifications and the capacity for downloading the user program have been changed.	Chapter 1
	The PG-FP3 system organization has been changed.	Chapter 2
	A description of EXPANSION CONNECTOR has been deleted from the description of parts.	
	A description of installing has been changed.	Chapter 3
	A description of the Erase command has been added.	Chapter 5
	A description of the Program command has been added.	
	A description of the Verify command has been added.	
	Caution has been added to the description of the E.P.V. command.	
	A description of the Blank Check command has been deleted from the first edition.	
	A description of the Read command has been deleted from the first edition.	
	A description of the Cancel command has been deleted from the first edition.	Chapter 7
	The setting of the baud rate in the RS-232C interface specifications has been changed.	
The description of the expansion interface specifications has been deleted from the first edition.		

[MEMO]

Facsimile Message

Although NEC has taken all possible steps to ensure that the documentation supplied to our customers is complete, bug free and up-to-date, we readily accept that errors may occur. Despite all the care and precautions we've taken, you may encounter problems in the documentation. Please complete this form whenever you'd like to report errors or suggest improvements to us.

From:

Name

Company

Tel.

FAX

Address

Thank you for your kind support.

North America

NEC Electronics Inc.
Corporate Communications Dept.
Fax: 1-800-729-9288
1-408-588-6130

Hong Kong, Philippines, Oceania

NEC Electronics Hong Kong Ltd.
Fax: +852-2886-9022/9044

Asian Nations except Philippines

NEC Electronics Singapore Pte. Ltd.
Fax: +65-250-3583

Europe

NEC Electronics (Europe) GmbH
Technical Documentation Dept.
Fax: +49-211-6503-274

Korea

NEC Electronics Hong Kong Ltd.
Seoul Branch
Fax: 02-528-4411

Japan

NEC Semiconductor Technical Hotline
Fax: 044-548-7900

South America

NEC do Brasil S.A.
Fax: +55-11-6465-6829

Taiwan

NEC Electronics Taiwan Ltd.
Fax: 02-2719-5951

I would like to report the following error/make the following suggestion:

Document title: _____

Document number: _____ Page number: _____

If possible, please fax the referenced page or drawing.

Document Rating	Excellent	Good	Acceptable	Poor
Clarity	<input type="checkbox"/>	<input type="checkbox"/>	<input type="checkbox"/>	<input type="checkbox"/>
Technical Accuracy	<input type="checkbox"/>	<input type="checkbox"/>	<input type="checkbox"/>	<input type="checkbox"/>
Organization	<input type="checkbox"/>	<input type="checkbox"/>	<input type="checkbox"/>	<input type="checkbox"/>

Free Manuals Download Website

<http://myh66.com>

<http://usermanuals.us>

<http://www.somanuals.com>

<http://www.4manuals.cc>

<http://www.manual-lib.com>

<http://www.404manual.com>

<http://www.luxmanual.com>

<http://aubethermostatmanual.com>

Golf course search by state

<http://golfingnear.com>

Email search by domain

<http://emailbydomain.com>

Auto manuals search

<http://auto.somanuals.com>

TV manuals search

<http://tv.somanuals.com>