

CMX158886 cpuModules™

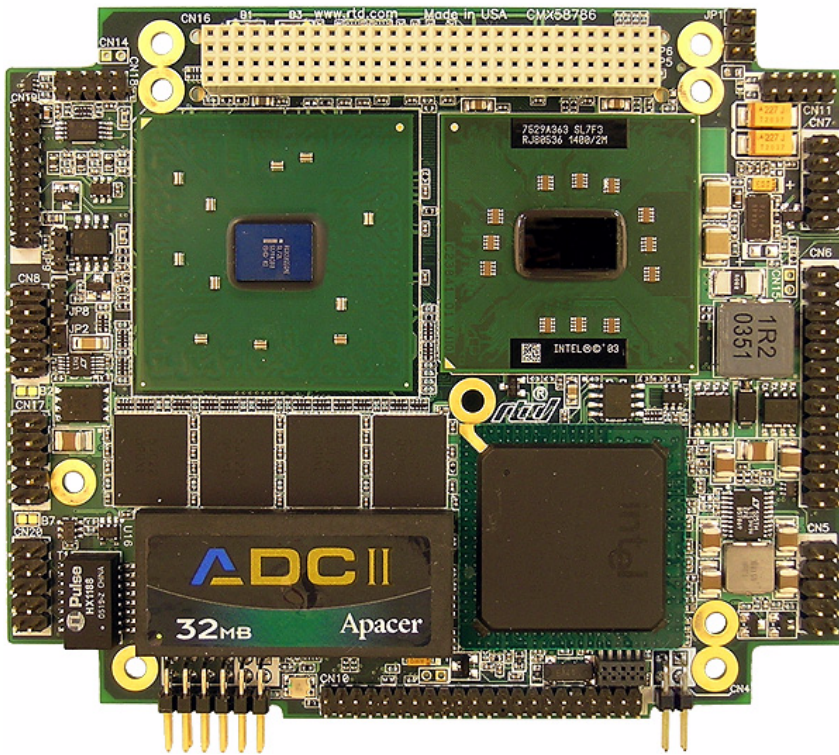

User's Manual

BDM-61000049 Revision G

www.rtd.com



An ISO9001:2000 Company

rtd[®]
"Accessing the Analog World"

CMX158886 cpuModules™ User's Manual

RTD Document Number: BDM-610000049 Revision G

Copyright © 2008 RTD Embedded Technologies, Inc. All rights reserved.

Trademarks

Advanced Digital I/O, aDIO, a2DIO, Autonomous SmartCal, cpuModule, dspFramework, dspModule, IDAN, HiDAN, HiDANplus, "MIL Value for COTS prices", multiPort, and PC/104EZ are trademarks, and "Accessing the Analog World", dataModule, RTD, and the RTD logo are registered trademarks of RTD Embedded Technologies, Inc. PS/2, PC/XT, PC/AT, and IBM are trademarks of International Business Machines Inc. MS-DOS, Windows, Windows 95, Windows 98, and Windows NT are trademarks of Microsoft Corporation. Linux is a registered trademark of Linus Torvalds. ROM-DOS is a trademark of Datalight, Inc. Intel is a registered trademark of Intel Corporation. PC/104 is a registered trademark of PC/104 Consortium. All other trademarks appearing in this document are the property of their respective owners.

Contents and specifications within this manual are subject to change without notice.

Revision History

Revision	Date	Reason for Change
A	12/13/06	Initial release
B	07/26/06	Added section to Chapter 3 with instructions for installing an ATA/IDE Disk Chip Removed the "Preliminary" tag on the cover sheet Added section describing proper grounding techniques
C	10/02/06	Added block diagrams to Appendix C to show the dimensions and connectors of the IDAN CMX158886 that includes a PCI to ISA bridge board Added "Network Boot" bullet to list of board features Removed references to 1.1 GHz Pentium M processor
D	11/29/06	Described +3.3 V source for FP_VCC, and added footnote for DDC signals (see Table 13 on page 33) Added section to Chapter 4: <i>DVMT Mode Select</i> — page 79 Removed table describing solder jumpers (see footnote of Table 62 on page 87) Added height of Mini Fan Heatsink (see <i>Physical Dimensions</i> on page 89) Made correction to IDAN SVGA connector pinout table (see Table 71 on page 101) Added dimension of heatsink fins on IDAN frames (see page 96 and page 104)
E	2/23/07	Removed Thermal Throttling. Corrected multiPort Floppy setup. Removed EEPROM section. Updated board name.
F	1/9/08	Added 1024 MB versions. Combined PX and CX manuals. Added support for dual serial ports. Corrected storage temperatures.
G	5/21/08	Corrected Table 26, COM A (RS-422/485) and COM B (RS-422/485)— 41 Added User EEPROM on page 80 Corrected aDIO Connector in Figure 10, IDAN-CMX158886-BRG Connectors— 104 Added information for ECC version.

CMX158886 cpuModules™

www.rtd.com



An ISO9001:2000 Company

rtd®
"Accessing the Analog World"

Table of Contents

Chapter 1 Introduction

CMX158886 cpuModules	2
Enhanced Intel SpeedStep (PX only)	3
Thermal Monitor	3
Error-Correction Codes (Selected Models Only)	3
aDIO with Wake-on-aDIO	3
Ordering Information	5
CMX158886 Model Options	5
Cable Kits and Accessories	6
Board Features	7
I/O	8
BIOS	9
Block Diagram	11
Specifications	12
Physical Characteristics	12
Power Consumption	12
Operating Conditions	12
Electrical Characteristics	12
Contact Information	15

Chapter 2 Getting Started

Connector Locations	18
Connecting the Utility Cable	20
Connecting a Keyboard	20
Connecting to the PC/104-Plus (PCI) Bus	20
Slot Selection Switches	21
PCI Bus Expansion Card Power	21
+5 Volt DC	21
+3.3 Volt DC	21
PCI Bus Signaling Levels	21
Booting the CMX158886 cpuModule for the First Time	22

Chapter 3 Connecting the cpuModule

Proper Grounding Techniques	24
Connector Locations	24
Auxiliary Power (CN3)	26
Utility Port Connector (CN5)	28
Speaker	28
Keyboard	29
Mouse	29
System Reset	29

Soft Power Button	29
Battery	30
SVGA Video Connector (CN18)	31
LVDS Flat Panel Video Connector (CN19)	33
EIDE Connector (CN10)	34
ATA/IDE Disk Chip Socket (U16)	35
Installing and Configuring the ATA/IDE Disk Chip.....	35
Serial Port 1 (CN7) and Serial Port 2 (CN8)	37
Serial Port UART	37
RS-232 Serial Port (Default)	37
RS-422 or RS-485 Serial Port.....	38
RS-422 and RS-485 Mode Pinout	39
Dual Serial Port Modes.....	40
multiPort™ (CN6)	42
multiPort Configured as an Advanced Digital I/O (aDIO™) Port	42
multiPort Configured as a Parallel Port	43
multiPort Configured as a Floppy Drive Controller	44
USB 2.0 Connector (CN17)	45
Ethernet (10/100Base-T and -TX) Connector (CN20)	47
Audio (CN11)	48
PC/104-Plus PCI Bus (CN16)	49
PC/104-Plus PCI Bus Signals	50
Address and Data	50
Interface Control Pins	50
Error Reporting	50
Arbitration (Bus Masters Only).....	50
System.....	50
Interrupts.....	50
Power Supplies and VIO.....	51
ATX Power Management Signals (optional)	51
Bridge Link (CN4)	52
External Power Management (CN12)	53
Optional RTC Battery Input (CN13)	53
Fan Power, +5 V (CN14)	53
Fan Power, Switched (CN15)	54
Chapter 4 Using the cpuModule	
The RTD Enhanced AMI BIOS	56
Configuring the RTD Enhanced AMI BIOS	56
Entering the BIOS Setup.....	56
Field Selection	56
Main Menu Setup Fields	57
Power On Self Test (POST) Codes	57
Bootting to Boot Block Flash with Fail Safe Boot ROM	58

Memory Map	59
I/O Address Map	60
Hardware Interrupts	61
multiPort: Advanced Digital I/O Ports (aDIO™)	62
Digital I/O Register Set	62
Port 1 Data register is a read/write byte direction	64
Interrupts	64
Advanced Digital Interrupts	64
Event Mode	64
Match Mode	64
Strobe Mode	65
Wake-on-aDIO	65
multiPort: Parallel Port Control	66
multiPort: Floppy Drive	66
AC'97 Audio	66
Ethernet (10/100Base-T and -TX)	66
IDE Controller Configuration	67
Cable Modes	67
Cable Detection	67
Device and Host Mode	67
Host Determination of Cable Type	67
Device Detect	67
Legacy Mode and Native Mode IDE	68
Legacy Mode	68
Native Mode	68
Configuring the ATA/IDE Disk Chip Socket	68
Real Time Clock Control	69
Overview	69
Accessing the RTC Registers	69
Watchdog Timer Control	71
Thermal Management	72
Thermal Monitor	72
Fan Mode	72
Further Temperature Reduction	72
Power Management	73
Enabling Enhanced Intel SpeedStep Technology (PX only)	73
Advanced Configuration and Power Interface (ACPI)	73
Power Button Modes	73
Low-Power Wake Options	73
AT vs. ATX Power Supplies	74
ATX Power Supply Signals	74
Reducing Power Consumption	75
Multi-Color LED	76
Reset Status Register	77
DVMT Mode Select	79

User EEPROM	80
Features and Settings That Can Affect Boot Time	81
Quick Boot.....	81
Add-On Cards With BIOS Extensions.....	81
VGA Controller.....	81
Hard Drive Type.....	81
Monitor Type.....	81
NVRAM Updates.....	81
Boot Device Order.....	81
System Recovery	82
Loading Default BIOS Settings.....	82
Booting to the Fail Safe Boot ROM (FSBR).....	82
Basic Interrupt Information for Programmers	83
What happens when an interrupt occurs?.....	83
How long does it take to respond to an interrupt?.....	83
Interrupt Request Lines.....	83
Intel 8259 Programmable Interrupt Controller.....	84
PCI Interrupts.....	84
Writing an Interrupt Service Routine (ISR).....	84
Sample Code.....	84
Appendix A Hardware Reference	
Jumper Settings and Locations	86
Onboard PCI Devices	88
Physical Dimensions	89
Appendix B Troubleshooting	
Common Problems and Solutions	92
Troubleshooting a PC/104-Plus System	93
How to Obtain Technical Support	94
Appendix C IDAN™ Dimensions and Pinout	
IDAN Dimensions and Connectors	96
External I/O Connections	97
IDAN Dimensions and Connectors (BRG version only)	104
External I/O Connections (BRG version only)	105
Appendix D Additional Information	
Application Notes	107
Drivers and Example Programs	107
Interrupt Programming	107
Serial Port Programming	107

PC/104 and PC/104-Plus Specifications 107

Appendix E Limited Warranty

Chapter 1 Introduction

This manual provides comprehensive hardware and software information for users developing with the CMX158886 PC/104-Plus cpuModule.



Note Read the specifications beginning on page 12 prior to designing with the cpuModule.

This manual is organized as follows:

- Chapter 1** **Introduction**
introduces main features and specifications
- Chapter 2** **Getting Started**
provides abbreviated instructions to get started quickly
- Chapter 3** **Connecting the cpuModule**
provides information on connecting the cpuModule to peripherals
- Chapter 4** **Using the cpuModule**
provides information to develop applications for the cpuModule, including general cpuModule information, detailed information on storing both applications and system functions, and using utility programs
- Appendix A** **Hardware Reference**
lists jumper locations and settings, physical dimensions, and processor thermal management
- Appendix B** **Troubleshooting**
offers advice on debugging problems with your system
- Appendix C** **IDAN™ Dimensions and Pinout**
provides connector pinouts for the cpuModule installed in an RTD Intelligent Data Acquisition Node (IDAN) frame
- Appendix D** **Additional Information**
lists sources and websites to support the cpuModule installation and configuration
- Appendix E** **Limited Warranty**

CMX158886 cpuModules

RTD's CMX158886 cpuModule represents the latest in high-performance embedded computing solutions. It includes 400 MHz source-synchronous Front Side Bus (FSB), on-die 2 MB (PX) or 512kB (CX) L2 cache, and data pre-fetch logic. It uses a 333MHz DDR-SDRAM controller that can support up to 2.7 G-Bytes per second of memory bandwidth. All memory chips are soldered directly onto the board. The Pentium-M (PX) processor features Enhanced Intel SpeedStep® technology, which enables real-time dynamic switching between multiple voltage and frequency points. This results in optimal performance without compromising low power.

The video interface is provided by an Analog SVGA output and an LVDS flat panel output. The two outputs are independent, and can display separate images and display timings. Maximum resolution is 2048 x 1536.

High-speed peripheral connections include USB 2.0, with up to 480 Mb/sec data throughput. An ATA-100/66/33 IDE controller provides a fast connection to the hard drive. Network connectivity is provided by an integrated 10/100 Mbps Ethernet controller. Other features include two RS-232/422/485 COM ports, Parallel Port, and AC97 audio.

RTD has gone the extra mile to include additional advanced features for maximum flexibility. These include an ATA/IDE Disk Chip socket that allows a true IDE drive to be attached to the board, either socketed or soldered. A MultiPort can be configured as a standard EPP/ECP parallel port, a floppy drive port, or an Advanced Digital I/O (aDIO) port. The DDR-SDRAM controller on selected models uses Error-Correcting-Codes (ECC) to correct single bit memory errors, and detect two-bit memory errors, providing for a more robust memory system. SDRAM is soldered directly to the board for high vibration resistance. The CMX158886 is also available in a rugged, fanless IDAN enclosure.

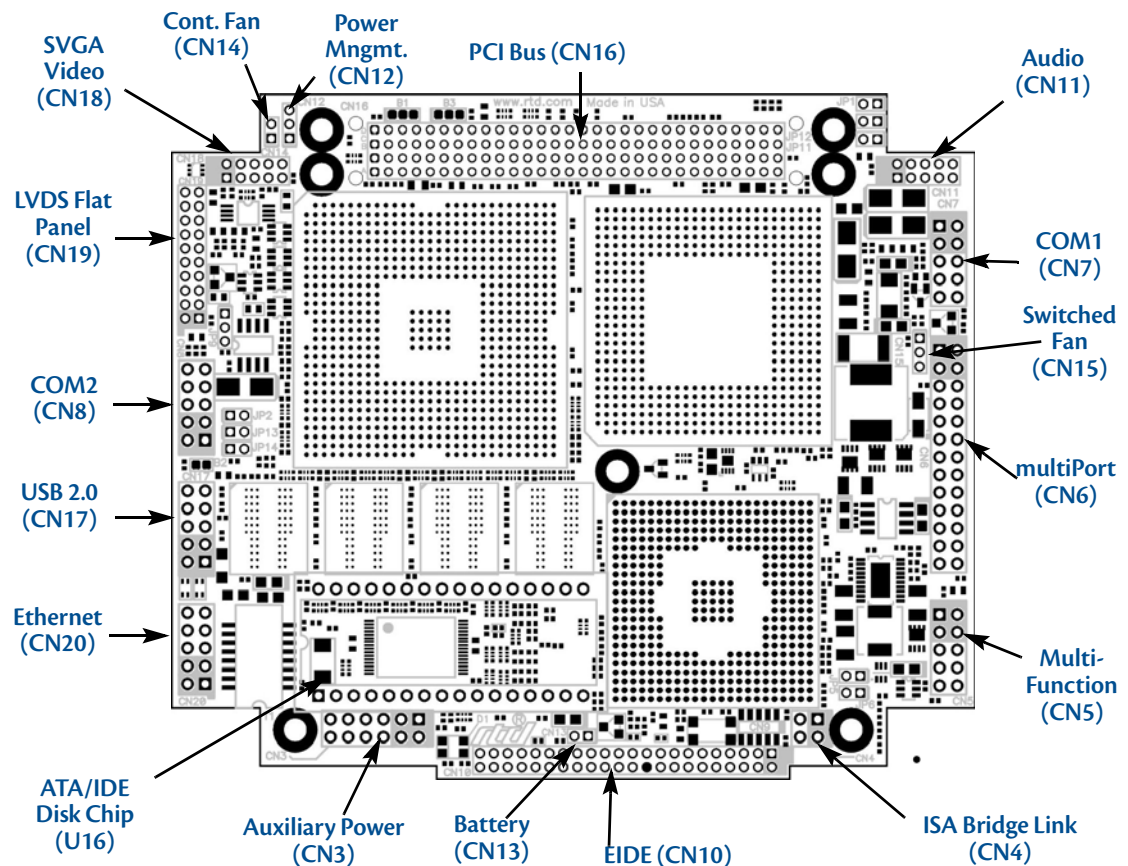

Figure 1 CMX158886 cpuModule (top view)

Enhanced Intel SpeedStep (PX only)

Enhanced Intel® SpeedStep® Technology has revolutionized thermal and power management by giving application software greater control over the processor's operating frequency and input voltage. Systems can easily manage power consumption dynamically. Today's embedded systems are demanding greater performance at equivalent levels of power consumption. Legacy hardware support for backplanes, board sizes and thermal solutions have forced design teams to place greater emphasis on power and thermal budgets. Intel has extended architectural innovation for saving power by implementing new features such as Enhanced Intel SpeedStep Technology. Enhanced Intel SpeedStep Technology allows the processor performance and power consumption levels to be modified while a system is functioning. This is accomplished via application software, which changes the processor speed and the processor core voltage while the system is operating. A variety of inputs such as system power source, processor thermal state, or operating system policy are used to determine the proper operating state.

The software model behind Enhanced Intel SpeedStep Technology has ultimate control over the frequency and voltage transitions. This software model is a major step forward over previous implementations of Intel SpeedStep technology. Legacy versions of Intel SpeedStep technology required hardware support through the chipset. Enhanced Intel SpeedStep Technology has removed the chipset hardware requirement and only requires the support of the voltage regulator, processor and operating system. Centralization of the control mechanism and software interface to the processor, and reduced hardware overhead has reduced processor core unavailability time to 10 µs from the previous generation unavailability of 250 µs.

Thermal Monitor

The Intel® Thermal Monitor is a feature on the CMX158886 that automatically initiates a SpeedStep transition or throttles the CPU when the CPU exceeds its thermal limit. The maximum temperature of the processor is defined as the temperature that the Thermal Monitor is activated. The thermal limit and duty cycle of the Thermal Monitor cannot be modified.

Error-Correction Codes (Selected Models Only)

The Graphics and Memory Controller Hub (GMCH) may be configured in the BIOS setup to operate in an Error-Correction-Code (ECC) data integrity mode. ECC mode allows multiple bit error detection and single bit error correction. The GMCH generate an 8-bit code word for each 64-bit Qword of memory, and performs a full Qword write at a time so that an 8-bit code is sent with each write. Since the code word covers a full Qword, writes of less than a Qword require a read-merge-write operation. Consider a Dword write to memory. In this case, when in ECC mode, GMCH will read the Qword where the addressed Dword will be written, merge in the new Dword, generate a code covering the new Qword and finally write the entire Qword and code back to memory. Any correctable (single-bit) errors detected during the initial Qword read are corrected before merging the new Dword.

Memory with ECC enabled requires additional system memory resources. This will cause the integrated graphics engine to have less memory bandwidth for access to the graphics frame buffer. Because of this, the display may flicker at high resolutions when the graphics processor is fully utilized and ECC is enabled. ECC memory is supported with internal graphics only.

aDIO with Wake-on-aDIO

RTD's exclusive multiPort™ allows the parallel port to be configured as an Advanced Digital I/O (aDIO™), ECP/EPP parallel port, or a floppy drive. aDIO™ is 16 digital bits configured as 8 bit-direction programmable and 8-bit port-direction programmable I/O giving you any combination of inputs and outputs. Match, event, and strobe interrupt modes mean no more wasting valuable processor time polling digital inputs. Interrupts are generated when the 8 bit-direction programmable digital inputs match a pattern or on any value change event. Bit masking

allows selecting any subgroup of eight bits. The strobe input latches data into the bit-programmable port and generates an interrupt. Any of the interrupt modes can be used to generate a wake event from any standby/powerdown mode.

Ordering Information

The CMX158886 cpuModule is available with a 1.4 GHz Pentium-M processor, or a 1.0 GHz Celeron-M processor and 512 or 1024 MB of DDR SDRAM. The cpuModule can also be purchased as part of an Intelligent Data Acquisition Node (IDAN™) building block, which consists of the cpuModule and a milled aluminum IDAN frame. The IDAN building block can be used in just about any combination with other IDAN building blocks to create a simple but rugged PC/104 stack. Refer to Appendix C, *IDAN™ Dimensions and Pinout*, for more information. The CMX158886 cpuModule can also be purchased as part of a custom-built RTD HiDAN™ or HiDANplus High Reliability Intelligent Data Acquisition Node. Contact RTD for more information on its high reliability PC/PCI-104 systems.

CMX158886 Model Options

The basic cpuModule model options are shown below. Refer to the RTD website (www.rtd.com) for more detailed ordering information.

Table 1 CMX158886 cpuModule Model Options

Part Number	Description
CMX158886PX1400HR-512	1.4 GHz Pentium-M, 512MB DDR-SDRAM cpuModule
CMX158886PX1400HR-E512	1.4 GHz Pentium-M, 512MB DDR-SDRAM cpuModule with ECC
CMX158886PX1400HR-1024	1.4 GHz Pentium-M, 1024MB DDR-SDRAM cpuModule
CMX158886CX1000HR-512	1.0 GHz Celeron-M, 512MB DDR-SDRAM cpuModule
CMX158886CX1000HR-E512	1.0 GHz Celeron-M, 512MB DDR-SDRAM cpuModule with ECC
CMX158886CX1000HR-1024	1.0 GHz Celeron-M, 1024MB DDR-SDRAM cpuModule

Cable Kits and Accessories

For maximum flexibility, RTD does not provide cables with the `cpuModule`. You may wish to purchase the CMX158886 `cpuModule` cable kit (P/N XK-CM65), which contains:

- Multi-function utility harness (keyboard socket, battery, reset, speaker)
- Two serial port cables (DIL-10 to DSUB-9)
- Parallel port cable (DIL-26 to DSUB-25)
- Two IDE cables
- VGA monitor cable (DIL-10 to high density 15-pin DSUB)
- Power cable (DIL-12 to wire leads)
- Two USB cables (5-pin SIL to USB A)
- Audio Cable (DIL-10 to three Mini-Jacks)
- One Ethernet cable (DIL-10 to RJ-45)

A floppy drive cable kit (P/N XK-CM49) is also available for connecting to the `multiPort`. This cable kit comes with:

- 3.5" HDD Floppy Drive with a `multiPort` interface board
- Two floppy cables

For additional accessories, refer to the RTD website.

Board Features

- 1.4 GHz Intel Pentium M with thermal throttling
 - 400 MHz, source-synchronous Front Side Bus
 - Math coprocessor
 - Supports MMX and SSE2 instructions
 - Internal Cache
 - L1 - 32KB of instruction and 32KB data; L2 - 2 MB
- 1.0 GHz Intel Celeron M with thermal throttling
 - 400 MHz, source-synchronous Front Side Bus
 - Math coprocessor
 - Supports MMX and SSE2 instructions
 - Internal Cache
 - L1 - 32KB of instruction and 32KB data; L2 - 512kB
- 512 or 1024 Mbytes BGA DDR SDRAM
 - Up to 333 MHz Data Rate
 - ECC corrects single-bit memory errors and detects 2-bit errors (selected models)
- Stackable 120-pin PCI bus
 - 4 Bus master add-on cards capable
 - 3.3V or 5V PCI bus signaling
- Advanced power management features including Enhanced Intel SpeedStep Technology (PX only)
- Advanced Thermal Management
 - Auto Fan Control only runs fan when needed
 - SMBus Temperature Monitor for CPU and board temperature
 - Mini Fan Heatsink with Auto Fan control
 - Passive Structural Heatsink & Heatpipes in IDAN and HiDAN System Configurations
- Advanced Programmable Interrupt Controller (APIC)
 - High resolution 100 MHz APIC timer
 - 24 interrupt channels with APIC enabled (15 in legacy PIC mode)
- Advanced Configuration and Power Interface (ACPI)
 - ACPI 1.0 Compliant
 - Supported power down modes: S1 (Power On Suspend), S3 (Suspend to RAM), S4 (Hibernate), and S5 (Soft-Off)
 - CPU Clock Throttling and Clock Stop for C0 to C3 Support
 - Wake events include:
 - aDIO Interrupt
 - Wake-on-LAN
 - Real Time Clock
 - COM port Ring
 - Power Switch
 - etc.
- Network Boot supported by Intel PXE

- Three (3) counter/timers (Intel 8254 compatible)
- Seven (7) DMA channels (Intel 8237 compatible)
- Y2K compliant Real-Time Clock (external battery required)
- Nonvolatile storage of CMOS settings without battery
- Watchdog timer
- Complete PC-compatible Single Board Computer

I/O

- AC97 Audio Support
 - Selectable Headphone or Line level output
 - Line level input
 - Microphone input
- Fast Ethernet
 - Ethernet Controller
 - Intel 82562 Fast Ethernet PCI Controller
 - Integrated 3KByte Transmit and 3Kbyte Receive FIFOs
 - Physical Layer
 - 100Base-Tx and 10Base-T
 - Full Duplex support
 - Easy to Use
 - Low Power Features
 - LED Status
 - Software configuration
- 855GME SVGA controller Onboard with 3D Acceleration
 - DirectX & OpenGL 3D Accelerator
 - Analog SVGA Output
 - LVDS Flat Panel output
 - Resolution up to 2048 x 1536 pixels with 32K colors
 - VGA, SVGA, XGA, SXGA, UXGA
 - Up to 16 million colors
 - 64-bit AGP Hardware graphics-accelerator
 - 1MB to 64MB of shared DDR high-performance memory
- Software-configurable RS-232/422/485 serial ports
 - 16550 compatible UARTs for high-speed
 - Termination resistors for RS-422/485
 - Each serial port connector can be configured as two limited serial ports, for a total of four serial ports
- multiPort function connector
 - Parallel port
 - SPP, PS/2 bi-directional, EPP & ECP
 - Advanced Digital I/O (aDIO)

- One 8-bit port programmable as input or output
- Eight bit-programmable I/O with Advanced Digital Interrupt Modes
- Event Mode Interrupt generates an interrupt when any input bit changes
- Match Mode Interrupt generates an interrupt when input bits match a preset value
- External Strobe Mode latches 8 data inputs and generates an interrupt
- Two Strobes can be configured as readable inputs
- Floppy controller interface
 - Interfaces with RTD's multiPort Floppy Drive and Cable Kit
- ESD protection
- Two USB 2.0 (Universal Serial Bus) Ports
 - Supports 480 Mb/s (high-speed), 12Mb/s (full-speed), and 1.5Mbs (low speed) peripherals
 - 500 mA @ 5 Vdc provided per port
 - USB Boot capability
- UltraDMA-100 / 66 / 33 Master Mode PCI EIDE Controller
 - Transfer rate up to 100MB/sec using UltraDMA
 - Increased reliability using UltraDMA-66 transfer protocols
 - Support ATAPI compliant devices including DVD drives
 - 48-bit LBA support for hard drives up to 2.2 terabytes.
- 32 pin ATA/IDE Disk Chip Socket
 - Miniature ATA/IDE Flash Disk Chip
 - Capacities up to 4GB¹
 - Natively supported by all major operating systems
- Utility port
 - PC/AT compatible keyboard port
 - PS/2 Mouse Port
 - Speaker port (0.1W output)
 - Hardware Reset input
 - Battery input for Real Time Clock
 - Soft Power Button input
- Power I/O
 - Access to PCI-104 Bus pins
 - Power ground, ± 12 , 5 & 3.3 VDC

BIOS

- RTD Enhanced AMI BIOS
- User-configurable using built-in Setup program
- Nonvolatile storage of CMOS settings without battery
- Boot Devices
 - Standard Devices (floppy disk, hard disk, etc.)
 - ATA/IDE Disk Chip

1. During the time of this manual's publication, 4GB was the largest available ATA/IDE Disk Chip capacity

- USB Device
- Network
- Fail Safe Boot ROM
 - Surface-mount Flash chip that holds ROM-DOS™
- Quick Boot mode

Block Diagram

The next figure shows a simplified block diagram of the CMX158886 cpuModule.

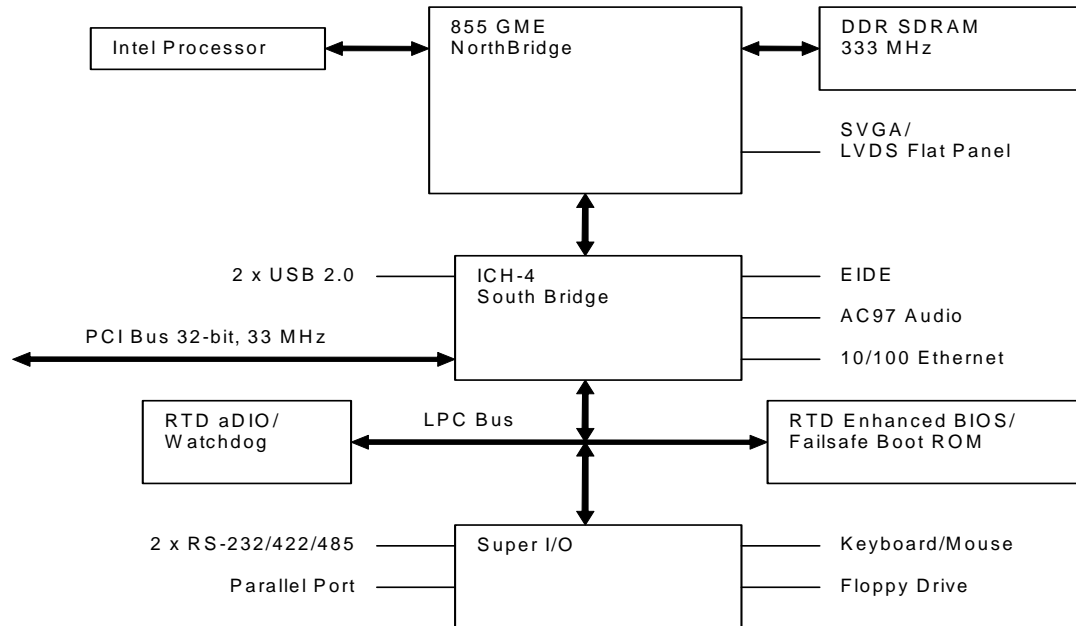

Figure 2 CMX158886 cpuModule Simplified Block Diagram

You can easily customize the cpuModule by stacking PCI-104 modules such as video controllers, modems, LAN controllers, or analog and digital data acquisition modules. Stacking modules onto the cpuModule avoids expensive installations of backplanes and card cages, and preserves the module's compactness.

The cpuModule uses the RTD Enhanced AMI BIOS. Drivers in the BIOS allow booting from floppy disk, hard disk, ATA/IDE Disk Chip, or boot block flash, thus enabling the system to be used with traditional disk drives or nonmechanical drives. Boot from USB devices and network are also supported.

The cpuModule and BIOS are also compatible with most real-time operating systems for PC compatible computers, although these may require creation of custom drivers to use the aDIO and watchdog timer.

Specifications

Physical Characteristics

- Dimensions: 117mm L x 97mm W x 15mm H (4.6"L x 3.8"W x 0.6"H)
- Weight: Approximately 0.19 Kg (0.40 lbs.)

Power Consumption

Exact power consumption depends on the actual application. Table 2 lists power consumption for typical configurations and clock speeds.

Table 2 cpuModule Power Consumption

Module	Speed	RAM	Power, typ.	Power, Max.
CMX158886PX	1.4 GHz	512 MB	12.7 W	15.2 W
CMX158886CX	1.0 GHz	512 MB	10.9 W	12.2 W

Operating Conditions

Table 3 Operating Conditions

Symbol	Parameter	Test Condition	Min.	Max.
V _{CC5}	5V Supply Voltage		4.75V	5.25V
V _{CC3}	3.3V Supply Voltage		n/a ¹	n/a
V _{CC12}	12V Supply Voltage		n/a ¹	n/a
V _{CC-12}	-12V Supply Voltage		n/a ¹	n/a
V _{CCSTBY}	5V Standby Voltage ²		4.75V	5.25V
I _{CCSTBY}	5V Standby Current ²		-	500mA
T _a	Ambient Operating Temperature	Standard	-40C	+85C
T _s	Storage Temperature		-40C	+85C
Rh	Humidity	Non-Condensing	0	90%
MTBF	Mean Time Before Failure	23 C	110,000 hours	

1. The 12V, -12V, and external +3.3V rails are not used by the cpuModule. Any requirements on these signals are driven by other components in the system, such as an LVDS Flat Panel or PCI device.
2. 5V Standby is used to power the board when the main supply is turned off (power down modes S3-S5). It is not required for board operation.

Electrical Characteristics

The table below lists the Electrical Characteristics of the CMX158886. Operating outside of these parameters may cause permanent damage to the cpuModule.

Table 4 Electrical Characteristics

Symbol	Parameter	Test Condition	Min.	Max.
PCI				
V_{OH}	Output Voltage High	$I_{OH} = -0.5 \text{ mA}$	2.9 V	3.3 V
V_{OL}	Output Voltage Low	$I_{OL} = 6.0 \text{ mA}$	0.0 V	0.55 V
V_{IH}	Input Voltage High	—	1.8 V	5.5 V
V_{IL}	Input Voltage Low	—	-0.5 V	0.9
$I_{3.3V}$	3.3V supplied to PCI bus from power connector (CN3)	—	—	2 A
Bridge Link (CN4)				
V_{OH}	Output Voltage High	$I_{OH} = -0.5 \text{ mA}$	2.4 V	3.3 V
V_{OL}	Output Voltage Low	$I_{OL} = 6.0 \text{ mA}$	0.0 V	0.55 V
V_{IH}	Input Voltage High	—	2.0 V	5.5 V
V_{IL}	Input Voltage Low	—	-0.5 V	0.8 V
IDE & ATA/IDE Disk Chip Socket¹				
V_{OH}	Output Voltage High	$I_{OH} = -6.0 \text{ mA}$	2.8 V	3.3 V
V_{OL}	Output Voltage Low	$I_{OL} = 6.0 \text{ mA}$	0.0 V	0.51 V
V_{IH}	Input Voltage High	—	2.0 V	5.5 V
V_{IL}	Input Voltage Low	—	-0.5 V	0.8 V
USB Ports				
I_{oc}	Overcurrent Limit	Total of both ports on a connector	1.0A	5.0A
LVDS Port				
V_{OD}	Differential Output Voltage		250 mV	450 mV
V_{os}	Offset Voltage		1.125 V	1.375 V
I_{VCC}	Supply Current for Panel Electronics	—	—	2 A
I_{BKLT}	Supply Current for Backlight	—	—	2 A
V_{OH}	Output Voltage High DDC_*, FP_ENABLK	$I_{OH} = -1.0 \text{ mA}$	2.97 V	3.3 V
V_{OL}	Output Voltage Low DDC_*, FP_ENABLK	$I_{OL} = 1.0 \text{ mA}$	0	0.33 V
V_{IH}	Input Voltage High DDC_*	—	2.0	3.6 V
V_{IL}	Input Voltage Low DDC_*	—	-0.3	0.8 V

Table 4 Electrical Characteristics

Symbol	Parameter	Test Condition	Min.	Max.
SVGA Port				
V _{OH}	Output Voltage High HSYNC, VSYNC	I _{OH} = -32.0 mA	3.8 V	5.0 V
V _{OL}	Output Voltage Low HSYNC, VSYNC	I _{OL} = 32.0 mA	0.0 V	0.55 V
V _{OH}	Output Voltage High DDC_*	I _{OH} = -4.0 mA	2.4 V	3.3 V
V _{OL}	Output Voltage Low DDC_*	I _{OL} = 8.0 mA	0.0 V	0.4 V
V _{IH}	Input Voltage High DDC_*	—	2.0 V	5.5 V
V _{IL}	Input Voltage Low DDC_*	—	-0.3 V	0.8 V
I _{DDCvcc}	Supply Current for DDC Electronics	—		100 mA
Serial Ports - RS-232				
V _{OH}	Output Voltage High	R _L = 3 k	5.0 V	10.0 V
V _{OL}	Output Voltage Low	R _L = 3 k	-10.0 V	-5.0 V
V _{IH}	Input Voltage High	—	2.4 V	25 V
V _{IL}	Input Voltage Low	—	-25 V	0.8 V
Serial Ports - RS-422/485				
V _{OD1}	Differential Output	R _L = 50 Ohm	2.0 V	6.0 V
V _{OD2}	Differential Output	R _L = 27 Ohm	1.5 V	6.0 V
V _{OC}	Common Mode Output	R _L = 27 or 50 Ohm	0.0 V	3.0 V
V _{TH}	Differential Input Threshold	-7V < V _{CM} < 7V	-0.3 V	0.3 V
V _I	Absolute Max Input Voltage	—	-25 V	25 V
multiPort - all modes				
V _{OH}	Output Voltage High	I _{OH} = -4.0 mA	2.4 V	3.3 V
V _{OL}	Output Voltage Low	I _{OL} = 8.0 mA	0.0 V	0.4 V
V _{IH}	Input Voltage High ²	—	2.0 V	5.5 V
V _{IL}	Input Voltage Low ²	—	-0.5 V	0.8 V
I _{ADIOvcc}	Supply current	—		500 mA
Utility Port Connector (CN5)				
V _{RTC}	Input RTC Voltage ³	—	2.0V	3.6 V
I _{UTILvcc}	Utility Supply Current	—		500 mA
External Power Management (CN12) - PME#				
V _{IH}	Input Voltage High	—	2.0 V	5.5 V
V _{IL}	Input Voltage Low	—	-0.5 V	0.8 V

1. Applies to modes up to UltraDMA Mode 4 (ATA/66)

2. Maximum DC undershoot below ground must be limited to either 0.5V or 10mA. During transitions, the device pins may undershoot to -2.0V or overshoot to 7.0V, provided it is less than 10ns, with the forcing current limited to 200 mA.
3. Only required to maintain date and time when power is completely removed from the system. Not required for board operation.

Contact Information

RTD Embedded Technologies, Inc.
103 Innovation Blvd.
State College, PA 16803-0906
USA

Phone: +1-814-234-8087

Fax: +1-814-234-5218

E-mail: sales@rtd.com
techsupport@rtd.com

Internet: <http://www.rtd.com>



Chapter 2 Getting Started

For many users, the factory configuration of the CMX158886 cpuModule can be used to get a PC/104 system operational. You can get your system up and running quickly by following the simple steps described in this chapter, which are:

1. Before connecting the cpuModule, the user must be properly grounded to prevent electrostatic discharge (ESD). For more information, refer to *Proper Grounding Techniques* on page 24.
2. Connect power.
3. Connect the utility harness.
4. Connect a keyboard.
5. Default BIOS configuration.
6. Fail Safe Boot ROM.
7. Connect a VGA monitor to the SVGA connector.

Refer to the remainder of this chapter for details on each of these steps.

Connector Locations

Figure 3 shows the connectors and the ATA/IDE Disk Chip socket of the CMX158886 cpuModule.

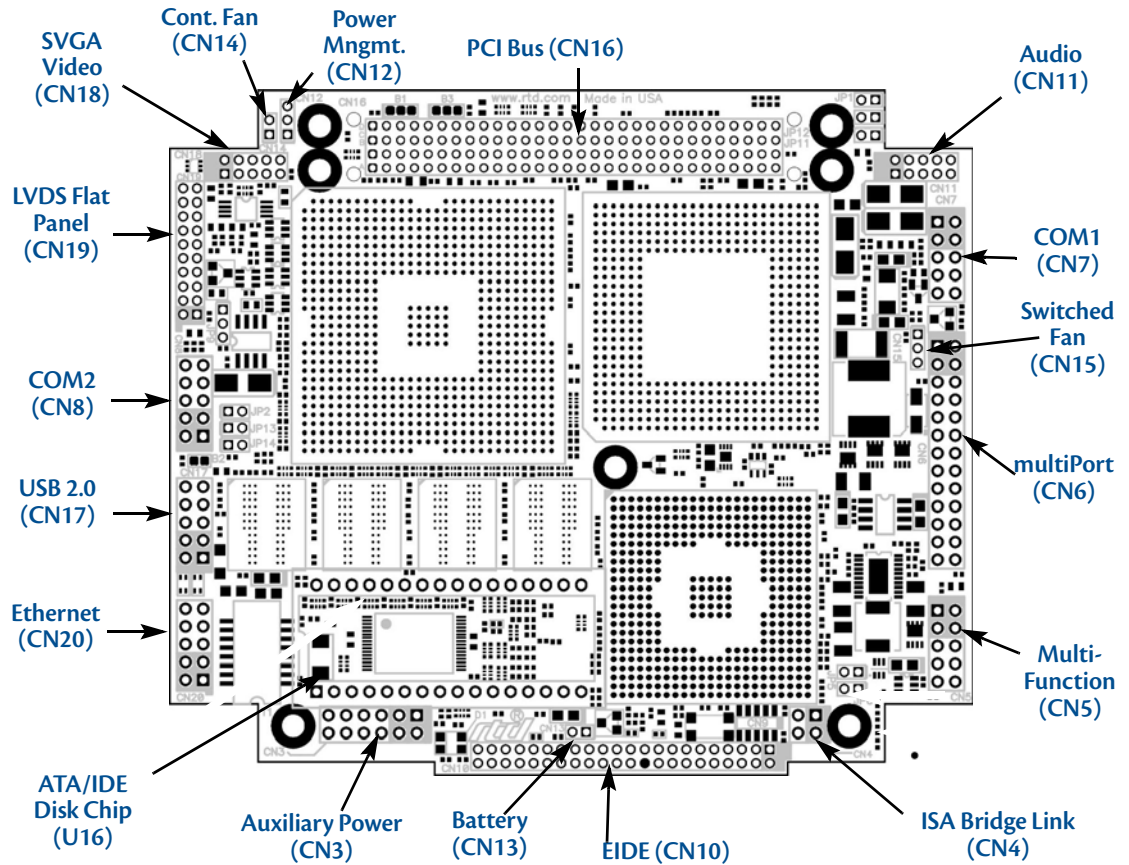

Figure 3 CMX158886 Connector Locations



Note Pin 1 of each connector is indicated by a white silk-screened square on the top side of the board and a square solder pad on the bottom side of the board. Pin 1 of the bus connectors match when stacking PC104-Plus or PCI-104 modules.

Table 5 CMX158886 Basic Connectors

Connector	Function	Size
CN3	Auxiliary Power	12-pin
CN4	Bridge Link	4-pin
CN5	Utility Port	10-pin
CN6	multiPort	26-pin
CN7	Serial Port 1 (COM1)	10-pin
CN8	Serial Port 2 (COM2)	10-pin
CN10	EIDE Connector	44-pin
CN11	Audio Connector	10-pin
CN12	External Power Management	3-pin
CN13	RTC Battery Input (optional)	2-pin
CN14	Fan Power (+5V)	2-pin
CN15	Fan Power (switched)	2-pin
CN16	PC/104-Plus (PCI) Bus	120-pin
CN17	USB 2.0	10-pin
CN18	Video (SVGA)	10-pin
CN19	Flat Panel Video (LVDS)	30-pin
CN20	Ethernet	10-pin
U16	ATA/IDE Disk Chip Socket	32-pin



WARNING *If you connect power incorrectly, the module will almost certainly be damaged or destroyed. Such damage is not covered by the RTD warranty! Please verify connections to the module before applying power.*

Power is normally supplied to the cpuModule through the PCI bus connectors (**CN16**). If you are placing the cpuModule onto a PC/104-Plus or PCI-104 stack that has a power supply, you do not need to make additional connections to supply power.

If you are using the cpuModule without a PCI-104 or PC/104-Plus stack or with a stack that does not include a power supply, refer to *Auxiliary Power (CN3)* on page 26 for more details.

Some PCI-104 and PC/104-Plus expansion cards may require +3.3V supplied on the PC/104-Plus (PCI) connector (**CN16**). To learn how to supply this voltage, refer to *Auxiliary Power (CN3)* on page 26 and *Jumper Settings and Locations* on page 86.

Connecting the Utility Cable

The multi-function connector (**CN5**) implements the following interfaces:

- PC/AT compatible keyboard
- PS/2 mouse port
- Speaker port (0.1W output)
- Hardware Reset input
- Battery input for Real Time Clock
- Soft Power Button input

To use these interfaces, you must connect to the utility port connector (**CN5**). The utility harness from the RTD cable kit provides a small speaker, two connectors for the keyboard and mouse, a push-button for resetting the PCI-104 system, a soft-power button, and a lithium battery to provide backup power for the real time clock.

Refer to *Utility Port Connector (CN5)* on page 28 to connect devices to the utility port connector.

Connecting a Keyboard

You may plug a PC/AT compatible keyboard directly into the PS/2 connector of the utility harness in the cable kit.



Note Many keyboards are switchable between PC/XT and AT operating modes, with the mode usually selected by a switch on the back or bottom of the keyboard. For correct operation with this cpuModule, you must select AT mode.

Connecting to the PC/104-Plus (PCI) Bus

Other PC/104-Plus or PCI-104 expansion boards may be connected to the cpuModule's PC/104-Plus (PCI) bus connector. To connect expansion modules to the PC/104-Plus bus, follow the procedure below to ensure that stacking of the modules does not damage connectors or electronics.



WARNING Do not force the module onto the stack! Wiggling the module or applying too much pressure may damage it. If the module does not readily press into place, remove it, check for bent pins or out-of-place keying pins, and try again.

1. Turn off power to the PC/104-Plus or PCI-104 system or stack.
2. Select and install stand-offs to properly position the cpuModule on the stack.
3. Touch a grounded metal part of the rack to discharge any buildup of static electricity.
4. Remove the cpuModule from its anti-static bag.
5. Check that keying pins in the bus connector are properly positioned.
6. Check the stacking order; if a PCI to ISA bridge card is used to connect any PC/104 modules, make sure an XT bus card will not be placed between two AT bus cards or it will interrupt the AT bus signals.
7. Hold the cpuModule by its edges and orient it so the bus connector pins line up with the matching connector on the stack.
8. Gently and evenly press the cpuModule onto the PC/104-Plus or PCI-104 stack.

There are three additional considerations to make when using the PCI bus:

- Slot selection switches on add-in boards

- PCI bus expansion card power
- PCI bus signaling levels

Slot Selection Switches

Unlike PC/104 cards, PC/104-Plus and PCI-104 expansion cards have a “slot” selection switch or jumpers. In total, there are 4 PCI cards that can be stacked onto the cpuModule with switch positions 0 through 3. The distance from the CPU determines these switch settings. The card closest to the CPU is said to be in slot 0, the next closest slot 1 and so on to the final card as slot 3.



Note This requirement means that all PC/104-Plus and PCI-104 cards must be stacked either on the top or the bottom of the CPU, not on both sides.

The “slot” setting method may vary from manufacturer to manufacturer, but the concept is the same. The CPU is designed to provide the correct delay to the clock signals to compensate for the bus length. The correct switch setting ensures the proper clock delay setting, interrupt assignment, and bus grant/request channel assignment. Refer to the expansion board’s manual for the proper settings. Each expansion card must be in a different slot.

PCI Bus Expansion Card Power

+5 Volt DC

The +5 V power pins on the PC/104-Plus (PCI) bus are connected directly to the +5 V pins on the auxiliary power connector, **CN3** (pins 2 and 8).

+3.3 Volt DC

The +3.3V pins on the PCI bus can be configured to be supplied from the power connector (**CN3**) or the onboard +3.3V power supply. The factory default configuration connects the +3.3 V pins on the PCI bus to the auxiliary power connector (**CN3**). This is to ensure that the cpuModule’s onboard +3.3V supply will not supply power to the PC/104-Plus connector while a PC/104-Plus or PCI-104 power supply is already powering the +3.3V pins.

For more information on configuring the +3.3V pins on the PCI bus, contact RTD Technical Support.

PCI Bus Signaling Levels

The PCI bus can operate at +3.3 V or +5 V signaling levels. The default PCI bus signaling level is +3.3 V. For more information, contact RTD Technical Support.



WARNING You will have to ensure that all your expansion cards can operate together at a single signaling level.

Booting the CMX158886 cpuModule for the First Time

You can now apply power to the cpuModule. You will see:

- A greeting message from the VGA BIOS (if the VGA BIOS has a sign-on message)
- The cpuModule BIOS version information
- A message requesting you press **Delete** to enter the Setup program

If you don't press **Delete**, the cpuModule will try to boot from the current settings. If you press **Delete**, the cpuModule will enter Setup. Once you have configured the cpuModule using Setup, save your changes and reboot.



Note You may miss the initial sign-on messages if your monitor takes a while to power on.

Note By default, cpuModules are shipped with Fail Safe Boot ROM enabled. When Fail Safe Boot ROM is enabled, the system will boot to it exclusively.



Chapter 3 Connecting the cpuModule

This chapter provides information on all CMX158886 cpuModule connectors.

- Proper Grounding Techniques* — page 24
- Connector Locations* — page 24
- Auxiliary Power (CN3)* — page 26
- Utility Port Connector (CN5)* — page 28
- SVGA Video Connector (CN18)* — page 31
- LVDS Flat Panel Video Connector (CN19)* — page 33
- EIDE Connector (CN10)* — page 34
- ATA/IDE Disk Chip Socket (U16)* — page 35
- Serial Port 1 (CN7) and Serial Port 2 (CN8)* — page 37
- multiPort™ (CN6)* — page 42
- USB 2.0 Connector (CN17)* — page 45
- Ethernet (10/100Base-T and -TX) Connector (CN20)* — page 47
- Audio (CN11)* — page 48
- PC/104-Plus PCI Bus (CN16)* — page 49
- Bridge Link (CN4)* — page 52
- External Power Management (CN12)* — page 53
- Optional RTC Battery Input (CN13)* — page 53
- Fan Power, +5 V (CN14)* — page 53
- Fan Power, Switched (CN15)* — page 54

Proper Grounding Techniques

Before removing the CMX158886 from its static bag, proper grounding techniques must be used to prevent electrostatic discharge (ESD) damage to the cpuModule. Common grounding procedures include an anti-static mat on a workbench, which may connect to an anti-static wrist strap (also known as an ESD wrist strap) on the wrist of the technician or engineer.

Connector Locations

Figure 4 shows the connectors and the ATA/IDE Disk Chip socket of the CMX158886 cpuModule.

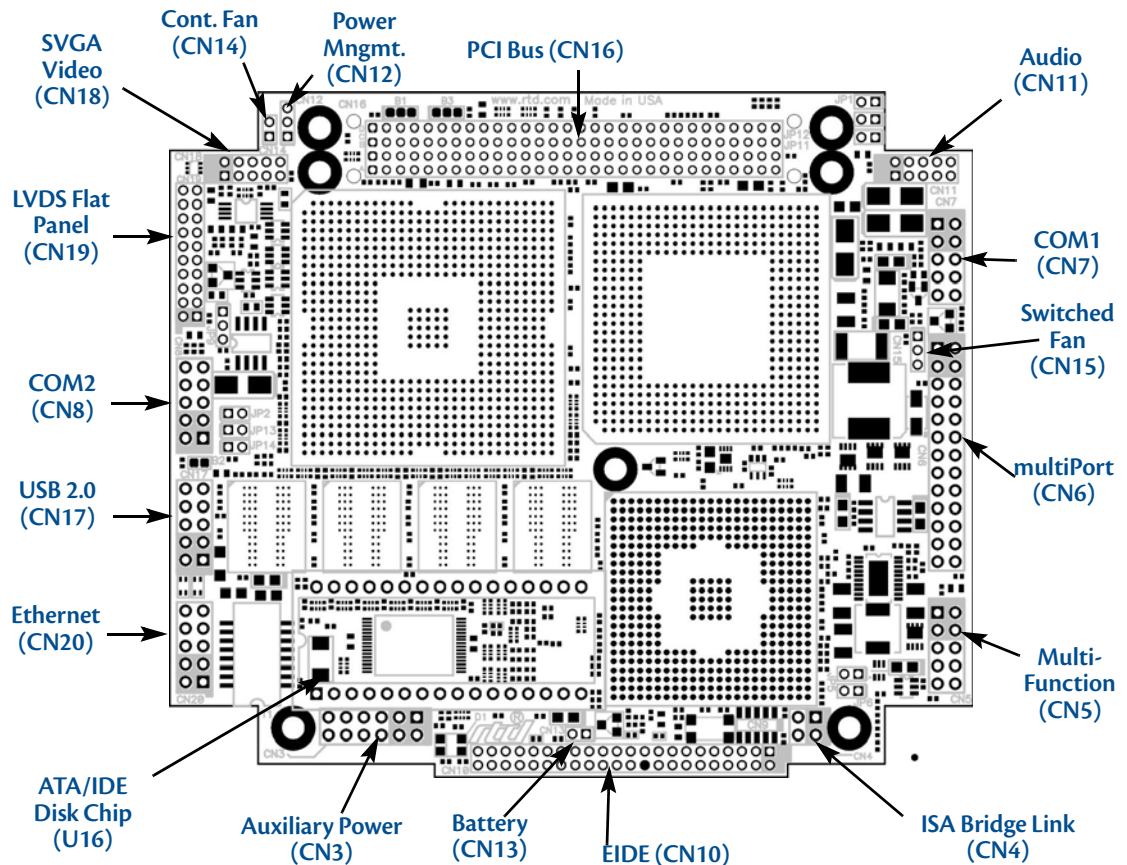

Figure 4 CMX158886 Connector Locations



Note Pin 1 of each connector is indicated by a white silk-screened square on the top side of the board and a square solder pad on the bottom side of the board. Pin 1 of the bus connectors match when stacking PC104-Plus or PCI-104 modules.

Table 6 CMX158886 Basic Connectors

Connector	Function	Size
CN3	Auxiliary Power	12-pin
CN4	Bridge Link	4-pin
CN5	Utility Port	10-pin
CN6	multiPort	26-pin
CN7	Serial Port 1 (COM1)	10-pin
CN8	Serial Port 2 (COM2)	10-pin
CN10	EIDE Connector	44-pin
CN11	Audio Connector	10-pin
CN12	External Power Management	3-pin
CN13	RTC Battery Input (optional)	2-pin
CN14	Fan Power (+5V)	2-pin
CN15	Fan Power (switched)	2-pin
CN16	PC/104-Plus (PCI) Bus	120-pin
CN17	USB 2.0	10-pin
CN18	Video (SVGA)	10-pin
CN19	Flat Panel Video (LVDS)	30-pin
CN20	Ethernet	10-pin
U16	ATA/IDE Disk Chip Socket	32-pin

Auxiliary Power (CN3)

The Auxiliary Power connector (**CN3**) can be used to supply power to devices that are attached to the cpuModule. These devices include hard drive, front-end boards for data acquisition systems, and other devices.

Power can also be conveyed to the module through the Auxiliary Power connector (**CN3**). The cpuModule only requires +5 VDC and ground for operation; however, other modules in the system may require +3.3V, +12 VDC, –12 VDC, and –5 VDC. In these instances, the corresponding pins on the Auxiliary Power Connector (**CN3**) may be used to supply these voltages.



Note Although it is possible to power the cpuModule through the Auxiliary Power connector, the preferred method is to power it through the bus connector from a power supply in the stack. The cpuModule can have large current transients during operation, which make powering it through wires difficult. Powering through the bus eliminates such problems as voltage drop and lead inductance.

If using the Auxiliary Power connector to power the system, care must be taken to ensure a good power connections. The power and ground leads must be twisted together, or as close together as possible to reduce lead inductance. A separate lead must be used for each of the power pins. Both 5V pins must be connected. The gauge of wire must be selected taking into account the total power of the system. A good rule of thumb is to use wire that can supply twice the power required by the system, and do not use less than 18 gauge wire. The length of the wire must not exceed 3 ft. The power supply solution must be verified by measuring voltage at the Auxiliary Power Connector and verifying that it does not drop below 4.75 V. The voltage at the connector should be checked with an oscilloscope while the system is operational.



WARNING If you connect power incorrectly, the module will almost certainly be destroyed. Please verify power connections to the module before applying power.

Table 7 Auxiliary Power Connector (CN3)¹

Pin	Signal	Function
1	GND	Ground
2	+5 V	+5 Volts DC
3	+5V_STDBY	+5V Standby (ATX)
4	+12 V	+12 Volts DC
5	Reserved	Reserved
6	–12 V	–12 Volts DC
7	GND	Ground
8	+5 V	+5 Volts DC
9	GND	Ground
10	+3.3 V	See note below
11	PSON#	Power Supply On (ATX)
12	+3.3 V	See note below

1. For more information on the ATX style signals, +5V Standby and PSON#, refer to the *Power Management* section in Chapter 4, *Using the cpuModule*.



Note The +3.3 V pins (10 and 12) on the auxiliary power connector (CN3) are connected to the +3.3 V pins on the PC/104-Plus bus by default. These pins are also configured to supply +3.3V to FP_VCC on the LVDS Flat Panel Video connector (CN19).

Note For more information on configuring the +3.3V pins on the auxiliary power connector (CN3) the PCI bus connector (CN16), or the LVDS Flat Panel Video connector (CN19), contact RTD Technical Support.

Facing the connector pins, the pinout of the Auxiliary Power connector is:

11	9	7	5	3	1
PS0N#	GND	GND	Reserved	+5V_STDBY	GND
+3.3 V	+3.3 V	+5 V	-12 V	+12 V	+5 V
12	10	8	6	4	2

Utility Port Connector (CN5)

The utility port connector implements the following functions:

- PC/AT compatible keyboard port
- PS/2 mouse port
- Speaker port (0.1W output)
- Hardware Reset input
- Battery input for Real Time Clock
- Soft Power Button input

Table 8 provides the pinout of the multi-function connector.

Table 8 Utility Port Connector (CN5)

Pin	Signal	Function	In/Out
1	SPKR+	Speaker Output (open collector)	out
2	PWR	+5 V	out
3	RESET	Manual Push-Button Reset	in
4	PWRSW	Soft Power Button	in
5	KBD	Keyboard Data	in/out
6	KBC	Keyboard Clock	out
7	GND	Ground	—
8	MSC	Mouse Clock	out
9	BAT	RTC Battery Input	in
10	MSD	Mouse Data	in/out

Facing the connector pins, the pinout is:

9	7	5	3	1
BAT	GND	KBD	RESET	SPKR+
MSD	MSC	KBC	PWRSW	PWR
10	8	6	4	2

Speaker

A speaker output is available on pins 1 and 2 of the multi-function connector. These outputs are controlled by a transistor to supply 0.1 W of power to an external speaker. The external speaker should have 8 Ω impedance and be connected between pins 1 and 2.

Keyboard

A PS/2 compatible keyboard can be connected to the multi-function connector. Usually PC keyboards come with a cable ending with a 5-pin male PS/2 connector. Table 9 lists the relationship between the multi-function connector pins and a standard PS/2 keyboard connector.

Table 9 Keyboard Connector Pins (CN5)

Pin	Signal	Function	PS/2
5	KBD	Keyboard Data	1
6	KBC	Keyboard Clock	5
7	GND	Ground	3
2	PWR	Keyboard Power (+5 V)	4

To ensure correct operation, check that the keyboard is either an AT compatible keyboard or a switchable XT/AT keyboard set to AT mode. Switchable keyboards are usually set by a switch on the back or bottom of the keyboard.

Mouse

A PS/2 compatible mouse can be connected to the multi-function connector. Table 10 lists the relationship between the multi-function connector pins and a standard PS/2 mouse connector.

Table 10 Mouse Connector Pins (CN5)

Pin	Signal	Function	PS/2
10	MSD	Mouse Data	1
8	MSC	Mouse Clock	5
7	GND	Ground	3
2	PWR	Keyboard Power (+5 V)	4

System Reset

Pin 3 of the multi-function connector allows connection of an external push-button to manually reset the system. The push-button should be normally open, and connect to ground when pushed.

Soft Power Button

Pin 4 of the multi-function connector allows connection of an external push-button to send a soft power signal to the system. The push-button should be normally open, and connect to ground when pushed. For more information on the modes of the Soft Power Button, refer to the *Power Management* section in Chapter 4, *Using the cpuModule*.

Battery

Pin 9 of the multi-function connector is the connection for an external backup battery. This battery is used by the cpuModule when system power is removed in order to preserve the date and time in the real time clock.

Connecting a battery is only required to maintain time when power is completely removed from the cpuModule. A battery is not required for board operation.



WARNING *The optional RTC battery input connector (CN13) should be left unconnected if the multi-function connector (CN5) has a battery connected to pin 9.*

SVGA Video Connector (CN18)

Table 11 provides the pinout of the video connector.

Table 11 SVGA Video Connector (CN18)

Pin	Signal	Function	In/Out
1	VSYNC	Vertical Sync	out
2	HSYNC	Horizontal Sync	out
3	DDCSCL	Monitor Communications Clock	out
4	RED	Red Analog Output	out
5	DDCSDA	Monitor Communications Data	bidirectional
6	GREEN	Green Analog Output	out
7	PWR	+5 V	out
8	BLUE	Blue Analog Output	out
9	GND	Ground	out
10	GND	Ground	out

Facing the connector pins of the SVGA Video connector (**CN18**), the pinout is:

9	7	5	3	1
GND	PWR	DDCSDA	DDCSCL	VSYNC
GND	BLUE	GREEN	RED	HSYNC
10	8	6	4	2

The following table lists the supported video resolutions.

Table 12 SVGA Video Resolutions

Resolution	Colors	Refresh Rates
640 x 480	16, 256, 64k, 16M	60, 70, 72, 75, 85, 100, 120 Hz
720 x 480	256, 64k, 16M	60 Hz
720 x 576	256, 64k, 16M	50 Hz
800 x 600	16, 256, 64k, 16M	60, 70, 72, 75, 85, 100, 120 Hz
960 x 540	256, 64k, 16M	60 Hz
1024 x 768	256, 64k, 16M	60, 70, 75, 85, 100, 120 Hz
1152 x 864	256, 64k, 16M	60, 70, 72, 75, 85, 100 Hz
1280 x 720	256, 64k, 16M	60, 75, 85, 100 Hz
1280 x 768	256, 64k, 16M	60, 75, 85 Hz
1280 x 960	256, 64k, 16M	60, 75, 85 Hz
1280 x 1024	256, 64k, 16M	60, 70, 72, 75, 85, 100, 120 Hz
1400 x 1050	256, 64k, 16M	60, 75, 85 Hz
1600 x 900	256, 64k, 16M	60, 75, 85, 100, 120 Hz
1600 x 1200	256, 64k, 16M	60, 65, 70, 72, 75, 85, 100, 120 Hz
1856 x 1392	256, 64k, 16M	60, 75 Hz
1920 x 1080	256, 64k, 16M	50, 60, 75, 85, 100 Hz
1920 x 1200	256, 64k, 16M	60, 75 Hz
1920 x 1440	256, 64k, 16M	60, 75, 85 Hz
2048 x 1536	256, 64k, 16M	60, 75 Hz

LVDS Flat Panel Video Connector (CN19)

Table 13 provides the pinout of the Flat Panel Video connector (**CN19**). FP_VCC is configured for +3.3V by default. Contact RTD to have FP_VCC configured for +5 V. FP_VBKLT can be either +5 V or +12 V, and can be selected with **JP9**. See *Jumper Settings and Locations* on page 86 for more details.

Table 13 Flat Panel Video Connector (CN19)

Pin	Signal	Function	In/Out
1	Y0P	LVDS Data 0+	out
2	Y0M	LVDS Data 0-	out
3	DDC_CLK ¹	Panel Detection Clock	out
4	GND	Ground	GND
5	Y1P	LVDS Data 1+	out
6	Y1M	LVDS Data 1-	out
7	DDC_DATA ¹	Panel Detection Data	in/out
8	GND	Ground	GND
9	Y2P	LVDS Data 2+	out
10	Y2M	LVDS Data 2-	out
11	GND	Ground	GND
12	GND	Ground	GND
13	YCP	LVDS Clock+	out
14	YCM	LVDS Clock-	out
15	Y3P	LVDS Data 3+	out
16	Y3M	LVDS Data 3-	out
17	GND	Ground	GND
18	FP_VCC ²	Power for flat panel electronics	out
19	FP_VBKLT	Power for flat panel backlight	out
20	FP_ENABLK	Enable for Backlight Power	out

1. The DDC signals use a +3.3 V signal level, and are not +5 V tolerant.
2. When configured for +3.3 V, FP_VCC is sourced from the auxiliary power connector (**CN3**) or PC/104-Plus connector (**CN16**).

Table 14 lists several LVDS panels that were tested with this cpuModule. When evaluating a panel to be used with this cpuModule, review the specifications of the tested panels to assure compatibility.

Table 14 Tested LVDS Panels

Manufacturer	Model Number	Resolution	Color Depth
Optrex	T-51756D121J-FW-A-AA	1024 x 768	18 bit
Optrex	T-51639D084JU-FW-A-AB	1024 x 768	24 bit

EIDE Connector (CN10)

The EIDE connector is a 44-pin, 2 mm connector that can connect to a variety of EIDE or IDE devices. The connector provides all signals and power needed to use a 2.5-inch form factor (laptop) hard drive. Also, the first 40 pins of the connector provide all of the signals needed to interface to a 3.5-inch or 5-inch form factor hard drive, CD-ROM drive, or other EIDE device. The larger form factors use a 40-pin, 0.1 inch spacing connector, so an adapter cable or adapter board is needed to connect to **CN10**.

Table 15 EIDE Connector (CN10)¹

Pin	Signal	Pin	Signal
1	RESET#	2	GND
3	DD7	4	DD8
5	DD6	6	DD9
7	DD5	8	DD10
9	DD4	10	DD11
11	DD3	12	DD12
13	DD2	14	DD13
15	DD1	16	DD14
17	DD0	18	DD15
19	GND	20	N/C
21	DMARQ	22	GND
23	DIOW#:STOP	24	GND
25	DIOR#:HDMARDY#:HSTROBE	26	GND
27	IORDY:DDMARDY#:DSTROB	28	GND
29	DMACK#	30	GND
31	INTRQ	32	N/C
33	DA1	34	PDIAG
35	DA0	36	DA2
37	CS0#	38	CS1#
39	DASP#	40	GND
41	+5 V (logic)	42	+5 V (motor)
43	GND	44	N/C

1. Signals marked with (#) are active low.

ATA/IDE Disk Chip Socket (U16)

The ATA/IDE Disk Chip socket is a 32-pin socket that supports +3.3V or +5V miniature ATA/IDE flash disk chips. The socket allows a true IDE device to be attached to the board with either a socketed or soldered connection. Such true IDE devices are supported by all major operating systems, and do not require special drivers.



WARNING The ATA/IDE Disk Chip socket does not support conventional SSD memory devices or devices that install as a BIOS extension (such as the M-Systems DiskOnChip®). If such a device is installed, the cpuModule and device will almost certainly be destroyed.

Table 16 ATA/IDE Disk Chip Socket (U16)¹

Pin	Signal	Pin	Signal
1	RESET#	32	VDD ²
2	D7	31	D8
3	D6	30	D9
4	D5	29	D10
5	D4	28	D11
6	D3	27	D12
7	D2	26	D13
8	D1	25	D14
9	D0	24	D15
10	DMARQ/WP#	23	IOWR#
11	IORD#	22	DMACK/CSEL
12	INTRQ	21	IOCS16#
13	A1	20	PDIAG#
14	A0	19	A2
15	CS1FX#	18	CS3FX#
16	GND	17	DASP#

1. Signals marked with (#) are active low.
2. The hardware default configuration for VDD is +3.3 V, but this pin may also be configured as +5 V. For more information, contact RTD Technical Support.

Installing and Configuring the ATA/IDE Disk Chip

To ensure proper installation and of the ATA/IDE Disk Chip, follow the following configuration steps. Note that the first few steps must be performed **before installing the Disk Chip**.

1. Before installing the ATA/IDE Disk Chip in the Disk Chip Socket (**U16**), verify that cpuModule is configured for the correct Disk Chip supply voltage. The hardware default configuration is +3.3V. To use a +5 V Disk Chip with cpuModules, contact RTD Technical Support.
2. Next, apply power to the system, and press the delete key repeatedly to enter the BIOS setup screen. Once in the BIOS, specify the following settings:
 - a. Enable the cpuModule's secondary IDE channel.
 - b. Specify the IDE mode of the ATA/IDE Disk Chip. For more information on the supported IDE modes, refer to *Configuring the ATA/IDE Disk Chip Socket* section of this manual on page 68.

- c. Save the settings in the BIOS setup
3. Remove power from the system.



WARNING The preceding steps should be performed before installing the Disk Chip in the ATA/IDE Disk Chip Socket. These steps ensure that the system is properly configured for the correct device and supply voltage, so neither the Disk Chip or cpuModule are damaged.

4. Insert the Disk Chip in the ATA/IDE Disk Chip Socket (**U16**) aligning pin 1 with the square solder pad on the board.
5. Apply power to the system.
6. Re-enter the BIOS and set the boot order of the system accordingly.

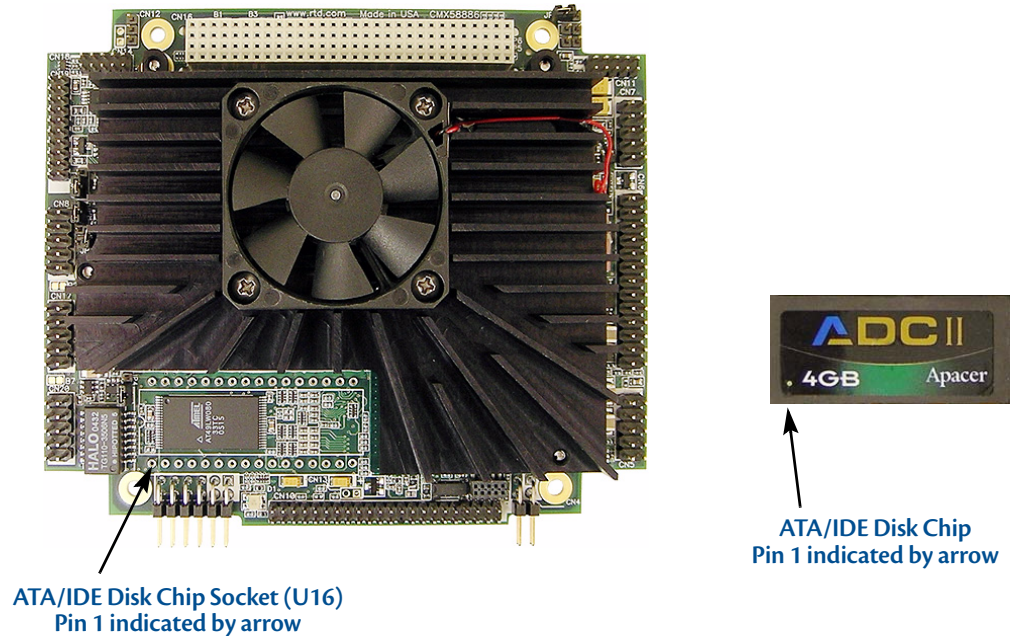

Figure 5 CMX158886 before and after ATA/IDE Disk Chip Installation

Serial Port 1 (CN7) and Serial Port 2 (CN8)

Serial Port 1 (COM1) is implemented on connector **CN7**, and Serial Port 2 is implemented on connector **CN8**. The serial ports are normally configured as PC compatible full-duplex RS-232 ports, but you may use the BIOS Setup program to reconfigure these ports as half-duplex RS-422 or full-duplex RS-422 or RS-485. If you reconfigure the ports, you must also select the I/O address and corresponding interrupt using Setup. Table 17 provides the available I/O addresses and corresponding interrupts.

Table 17 Serial Port Settings

I/O Address (hex)	IRQ
03F8	IRQ4
02F8	IRQ3
03E8	IRQ4
02E8	IRQ3

Serial Port UART

The serial ports are implemented with a 16550-compatible UART (Universal Asynchronous Receiver/Transmitter). This UART is capable of baud rates up to 115.2 kbaud in 16450 and 16550A compatible mode, and includes a 16-byte FIFO. Refer to any standard PC-AT hardware reference for the register map of the UART. For more information about programming UARTs, refer to Appendix D.

RS-232 Serial Port (Default)

The default serial port mode is full-duplex RS-232. With this mode enabled, the serial port connectors must be connected to RS-232 compatible devices. Table 18 provides the serial port connector pinout and shows how to connect to an external DB-25 or DB-9 compatible serial connector.

Table 18 Serial Port in RS-232 Mode

Pin	Signal	Function	In/Out	DB-25	DB-9
1	DCD	Data Carrier Detect	in	8	1
2	DSR	Data Set Ready	in	6	6
3	RXD	Receive Data	in	3	2
4	RTS	Request To Send	out	4	7
5	TXD	Transmit Data	out	2	3
6	CTS	Clear To Send	in	5	8
7	DTR	Data Terminal Ready	out	20	4
8	RI	Ring Indicate	in	22	9
9,10	GND	Signal Ground	—	7	5

Facing the serial port's connector pins, the pinout is:

9	7	5	3	1
GND	DTR	TXD	RXD	DCD
GND	RI	CTS	RTS	DSR
10	8	6	4	2

RS-422 or RS-485 Serial Port

You may use Setup to configure the serial ports as RS-422 or RS-485. In this case, you must connect the serial port to an RS-422 or RS-485 compatible device.

When using RS-422 or RS-485 mode, you can use the serial ports in either half-duplex (two-wire) or full-duplex (four-wire) configurations. For half-duplex (2-wire) operation, you must connect RXD+ to TXD+, and connect RXD- to TXD-.



Note The *cpuModule* has a 120 Ω termination resistor. Termination is usually necessary on all RS-422 receivers and at the ends of the RS-485 bus.

Note If required, the termination resistor can be enabled by closing jumper **JP1** for Serial Port 1 (COM1), **JP2** for Serial Port 2 (COM2), **JP11** for Serial Port 3 (COM3), and **JP13** for Serial Port 4 (COM4).

When using full-duplex (typically in RS-422 mode), connect the ports as shown in Table 19.

Table 19 Full-Duplex Connections

Port 1	Port 2
RXD+	TXD+
TXD+	RXD+
RXD-	TXD-
TXD-	RXD-

When using half-duplex in RS-485 mode, connect the ports as shown in Table 20.

Table 20 Half-Duplex RS-485 Mode

From	To
Port 1 TXD+	Port 1 RXD+
Port 1 TXD-	Port 1 RXD-
Port 1 TXD+	Port 2 RXD+
Port 1 RXD-	Port 2 TXD-

RS-422 and RS-485 Mode Pinout

Table 21 provides the serial port connector pinout when RS-422 or RS-485 modes are enabled.

Table 21 Serial Port in RS-422/485 Mode

Pin	Signal	Function	In/Out	DB-9
1	—	Reserved	—	1
2	—	Reserved	—	6
3	RXD-	Receive Data (-)	in	2
4	TXD+	Transmit Data (+)	out	7
5	TXD-	Transmit Data (-)	out	3
6	RXD+	Receive Data (+)	in	8
7	—	Reserved	—	4
8	—	Reserved	—	9
9,10	GND	Signal Ground	out	5

Facing the serial port connector, the pinout is:

9	7	5	3	1
GND	Rsvd	TXD-	RXD-	Rsvd
GND	Rsvd	RXD+	TXD+	Rsvd
10	8	6	4	2



Note When using the serial port in RS-485 mode, the serial transmitters are enabled and disabled under software control. The transmitters are enabled by manipulating the Request To Send (RTS*) signal of the serial port controller. This signal is controlled by writing bit 1 of the Modem Control Register (MCR) as follows:

- If MCR bit 1 = 1, then RTS* = 0, and serial transmitters are disabled
- If MCR bit 1 = 0, then RTS* = 1, and serial transmitters are enabled

Note For more information on the serial port registers, including the MCR, refer to the Serial Port Programming reference in Appendix D.

Dual Serial Port Modes

The serial port connectors can be configured as dual serial ports in the BIOS. The mapping between the connectors and COM port numbers is shown in Table 22. The supported combinations of serial port modes are listed in Table 23, which also includes a reference to the corresponding connector pinout. For the configurations that have RS-422 or RS-485 on COM B, a jumper must be installed.

Table 22 Dual Serial Port Connections

Connector	COM A	COM B
CN7	COM 1	COM 3
CN8	COM 2	COM 4

Table 23 Dual Serial Port Modes

COM A	COM B	Pinout Reference	JP12/JP14
RS-232	RS-232	Table 24	Not Installed
RS-422	RS-232	Table 25	Not Installed
RS-422	RS-422	Table 26	CN7: JP12 CN8: JP14
RS-485	RS-232	Table 25	Not Installed
RS-485	RS-485	Table 26	CN7: JP12 CN8: JP14

Table 24 COM A (RS-232) and COM B(RS-232)

Pin	Signal	Function	In/Out	DB-9
1	DCD1	COM A- Data Carrier Detect	in	1
2	RXD2	COM B- Receive Data	in	6
3	RXD1	COM A - Receive Data	in	2
4	RTS1	COM A - Request To Send	out	7
5	TXD1	COM A - Transmit Data	out	3
6	CTS1	COM A - Clear To Send	in	8
7	TXD2	COM B - Transmit Data	out	4
8	RI1	COM A - Ring Indicate	in	9
9,10	GND	Signal Ground	—	5

Table 25 COM A (RS-422/485) and COM B (RS-232)

Pin	Signal	Function	In/Out	DB-9
1	DCD1	COM A - Data Carrier Detect	in	1
2	RXD2	COM B - Receive Data	in	6
3	RXD1-	COM A - Receive Data (-)	in	2
4	TXD1+	COM A - Transmit Data (+)	out	7
5	TXD1-	COM A - Transmit Data (-)	out	3
6	RXD1+	COM A - Receive Data (+)	in	8
7	TXD2	COM B - Transmit Data	out	4
8	RI1	COM A - Ring Indicate	in	9
9,10	GND	Signal Ground	—	5

Table 26 COM A (RS-422/485) and COM B (RS-422/485)

Pin	Signal	Function	In/Out	DB-9
1	RXD2+	COM B - Receive Data (+)	in	1
2	RXD2-	COM B - Receive Data (-)	in	6
3	RXD1-	COM A - Receive Data (-)	in	2
4	TXD1+	COM A - Transmit Data (+)	out	7
5	TXD1-	COM A - Transmit Data (-)	out	3
6	RXD1+	COM A - Receive Data (+)	in	8
7	TXD2-	COM B - Transmit Data (-)	out	4
8	TXD2+	COM B - Transmit Data (+)	out	9
9,10	GND	Signal Ground	—	5

multiPort™ (CN6)

RTD's exclusive multiPort can be configured as an Advanced Digital I/O (aDIO™), a parallel port, or a floppy drive. Refer to Chapter 4, *Using the cpuModule*, to configure the multiPort.

multiPort Electrostatic Discharge (ESD) and Undershoot Protection

The multiPort interface provides electrostatic discharge (ESD) protection allowing the aDIO port, parallel port, and floppy port circuits to be protected from electrically charged external objects that may come in contact with the cpuModule.

The ESD protection minimizes susceptibility of the circuitry to ESD from human contact, and is rated to withstand up to 2000V with the Human Body Model (HBM) standardized ESD test. The protected circuitry is also rated to protect against up to 1000V with the Charged Device Model (CDM) standardized ESD test.

In addition to the ESD protection, the circuitry also provides -2V undershoot protection by ensuring that the pins remain in the off state when such voltage levels are connected as inputs to the cpuModule.

For specific electrical characteristics, refer to Table 4 on page 13.

multiPort Configured as an Advanced Digital I/O (aDIO™) Port

The multiPort connector (CN6) can be configured as an aDIO port. aDIO is 16 digital bits configured as 8-bit programmable and 8-bit port programmable I/O, providing any combination of inputs and outputs. Match, event, and strobe interrupt modes mean no more wasting valuable processor time polling digital inputs. Interrupts are generated when the 8-bit programmable digital inputs match a pattern, or on any value change event. Bit masking allows selecting any subgroup of 8 bits. The strobe input latches data into the bit programmable port and generates an interrupt. Refer to *multiPort: Advanced Digital I/O Ports (aDIO™)* on page 62 for information on programming the multiPort.

Table 27 multiPort aDIO Pinout

CN6 Pin	Function	CN6 Pin	Function
1	strobe 0	2	P0-4
3	P1-0	4	P0-5
5	P1-1	6	P0-6
7	P1-2	8	P0-7
9	P1-3	10	strobe 1
11	P1-4	12	GND
13	P1-5	14	GND
15	P1-6	16	GND
17	P1-7	18	GND
19	P0-0	20	GND
21	P0-1	22	GND
23	P0-2	24	GND
25	P0-3	26	+5 V

multiPort Configured as a Parallel Port

The parallel port is available on connector **CN6**. Make sure the multiPort in the BIOS Setup is configured to parallel port. You can use the BIOS Setup to select the parallel port's address and associated interrupt, and choose between its operational modes (SPP, ECP, EPP 1.7, and EPP 1.9).

The pinout of the connector enables a ribbon cable to be connected directly to a DB-25 connector, thus providing a standard PC compatible port.



Note For correct operation, keep the length of the cable connecting the cpuModule and parallel device less than 3 meters (10 feet).

Table 28 lists the parallel port signals and explains how to connect it to a DB-25 connector to obtain a PC compatible port.

Table 28 multiPort Connector (CN6) as a Parallel Port

CN6 Pin	Signal	Function	In/Out	DB-25
1	STB	Strobe Data	out	1
2	AFD	Autofeed	out	14
3	PD0	Printer Data 0 (LSB)	out	2
4	ERR	Printer Error	in	15
5	PD1	Parallel Data 1	out	3
6	INIT	Initialize Printer	out	16
7	PD2	Printer Data 2	out	4
8	SLIN	Select Printer	out	17
9	PD3	Printer Data 3	out	5
10	GND	Signal Ground	—	18
11	PD4	Printer Data 4	out	6
12	GND	Signal Ground	—	19
13	PD5	Printer Data 5	out	7
14	GND	Signal Ground	—	20
15	PD6	Printer Data 6	out	8
16	GND	Signal Ground	—	21
17	PD7	Printer Data 7 (MSB)	out	9
18	GND	Signal Ground	—	22
19	ACK	Acknowledge	in	10
20	GND	Signal Ground	—	23
21	BSY	Busy	in	11
22	GND	Signal Ground	—	24
23	PE	Paper End	in	12
24	GND	Signal Ground	—	25
25	SLCT	Ready To Receive	in	13
26	—	+5 V	—	—

multiPort Configured as a Floppy Drive Controller

The multiPort (CN6) can be configured to be a floppy drive controller. This can be configured in the BIOS Setup under Integrated Peripherals. For more information on configuring the multiPort in the BIOS Setup, refer to page 66

Table 29 shows the pin assignments to connect a floppy drive to the multiPort.

Table 29 multiPort Connector Floppy Pinout (CN6)¹

CN6 Pin	Function	DB-25	Floppy Drive Pin
1	DS0#	1	14
2	DR0	14	2
3	INDEX#	2	8 ²
4	HDSEL#	15	32
5	TRK0#	3	26 ²
6	DIR#	16	18
7	WRTPRT#	4	28 ²
8	STEP#	17	20
9	RDATA#	5	30 ²
10	GND	18	—
11	DSKCHG	6	34 ²
12	GND	19	odd pins
13	—	7	—
14	GND	20	odd pins
15	MTR0#	8	10
16	GND	21	odd pins
17	—	9	—
18	GND	22	odd pins
19	DS1#	10	12
20	GND	23	odd pins
21	MTR1#	11	16
22	GND	24	odd pins
23	WDATA#	12	22
24	GND	25	odd pins
25	WGATE#	13	24
26	+5 V	—	—

1. Signals marked with (#) are active low.
2. These signals must be pulled to 5V with separate 470 Ohm resistors.

USB 2.0 Connector (CN17)

Two USB 2.0 compliant connectors are available on connector **CN17**. Table 30 provides the pinout of the USB connector.



Note For proper operation at USB 2.0 speeds, be sure to use a cable that is rated for USB 2.0, such as the cable kit supplied by RTD.

Table 30 USB Connector (CN17)

Pin	Signal	Function	In/Out
1	VCC1	Supply +5 V to USB1	out
2	VCC2	Supply +5 V to USB2	out
3	DATA1-	Bidirectional data line for USB1	in/out
4	DATA2-	Bidirectional data line for USB2	in/out
5	DATA1+	Bidirectional data line for USB1	in/out
6	DATA2+	Bidirectional data line for USB2	in/out
7	GND	Ground	out
8	GND	Ground	out
9	GND	Ground	out
10	GND	Ground	out

Facing the connector pins, the pinout of **CN17** is:

	9	7	5	3	1
	GND	GND	DATA1+	DATA1-	VCC1
	GND	GND	DATA2+	DATA2-	VCC2
	10	8	6	4	2

Ethernet (10/100Base-T and -TX) Connector (CN20)

The functionality of the Ethernet port is based on the Intel 82562 Fast Ethernet PCI controller. Table 31 provides the pinout of the Ethernet connector.

Table 31 Ethernet Connector (CN20)

RJ-45 Pin	10-Pin DIL Pin	Signal	Function	In/Out
3	1	RX+	Receive+	in
6	2	RX-	Receive-	in
1	5	TX+	Transmit+	out
2	6	TX-	Transmit-	out
4	3	CT	Termination connected to pin 4	—
5	4	CT	Termination connected to pin 3	—
7	7	CT	Termination connected to pin 8	—
8	8	CT	Termination connected to pin 7	—
—	9	AGND	Ground	—
—	10	AGND	Ground	—

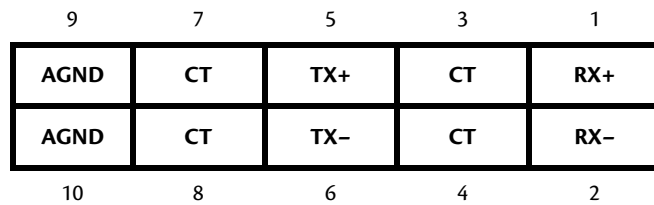

Audio (CN11)

A full featured AC97 compliant audio port is available on CN11. It provides a mono microphone input, stereo line level input, and a stereo output that can be configured as line level or headphone level. The output is configured in the BIOS setup utility. When used as a headphone output, it will drive 32 Ohm speaker at 50mW.

Table 32 Audio Connector (CN11)

10-Pin DIL Pin	Signal	Function	In/Out
1	MIC_VREF	2.2V Supply to bias microphones. 5mA max.	out
2	MIC_IN	Microphone input. 1V RMS or 0.1V RMS.	in
3	GND	Signal GND	GND
4	LINE_IN_LEFT	Line level input for left channel. 1V RMS nominal.	in
5	GND	Signal GND	GND
6	LINE_IN_RIGHT	Line level input for right channel. 1V RMS nominal.	in
7	GND	Signal GND	GND
8	OUTPUT_LEFT	Left channel output. Selectable as line level (1V RMS) or headphone.	out
9	GND	Signal GND	GND
10	OUTPUT_RIGHT	Left channel output. Selectable as line level (1V RMS) or headphone.	out

9	7	5	3	1
GND	GND	GND	GND	MIC_VREF
OUTPUT_RIGHT	OUTPUT_LEFT	LINE_IN_RIGHT	LINE_IN_LEFT	MIC_IN
10	8	6	4	2

PC/104-Plus PCI Bus (CN16)

Connector **CN16** carries the signals of the PC/104-Plus PCI bus. These signals match definitions of the PCI Local Bus specification Revision 2.1. Table 33 list the pinouts of the PC/104-Plus bus connector.

Table 33 PC/104-Plus Bus Signal Assignments¹

Pin	A	B	C	D
1	GND	Reserved/+5V_STDBY ²	+5 V	AD00
2	VIO	AD02	AD01	+5 V
3	AD05	GND	AD04	AD03
4	C/BE0#	AD07	GND	AD06
5	GND	AD09	AD08	GND
6	AD11	VIO	AD10	M66EN
7	AD14	AD13	GND	AD12
8	+3.3 V	C/BE1#	AD15	+3.3 V
9	SERR#	GND	Reserved / PSON# ²	PAR
10	GND	PERR#	+3.3 V	Reserved / PME# ²
11	STOP#	+3.3 V	LOCK#	GND
12	+3.3 V	TRDY#	GND	DEVSEL#
13	FRAME#	GND	IRDY#	+3.3 V
14	GND	AD16	+3.3 V	C/BE2#
15	AD18	+3.3 V	AD17	GND
16	AD21	AD20	GND	AD19
17	+3.3 V	AD23	AD22	+3.3 V
18	IDSEL0	GND	IDSEL1	IDSEL2
19	AD24	C/BE3#	VIO	IDSEL3
20	GND	AD26	AD25	GND
21	AD29	+5 V	AD28	AD27
22	+5 V	AD30	GND	AD31
23	REQ0#	GND	REQ1#	VIO
24	GND	REQ2#	+5 V	GNT0#
25	GNT1#	VIO	GNT2#	GND
26	+5V	CLK0	GND	CLK1
27	CLK2	+5 V	CLK3	GND
28	GND	INTD#	+5 V	RST#
29	+12 V	INTA#	INTB#	INTC#
30	-12V	REQ3#	GNT3#	GND

1. Signals marked with (#) are active low.
2. Optional signals for ATX power management

PC/104-Plus PCI Bus Signals

The following are brief descriptions of the PC/104-Plus PCI bus signals.

Address and Data

AD[31:00] — Address and Data are multiplexed. A bus transaction consists of an address cycle followed by one or more data cycles.

C/BE[3:0]# — Bus Command/Byte Enables are multiplexed. During the address cycle, the command is defined. During the Data cycle, they define the byte enables.

PAR — Parity is even on AD[31:00] and C/BE[3:0]# and is required.

Interface Control Pins

FRAME# — Frame is driven by the current master to indicate the start of a transaction and will remain active until the final data cycle.

TRDY# — Target Ready indicates the selected device's ability to complete the current data cycle of the transaction. Both IRDY# and TRDY# must be asserted to terminate a data cycle.

IRDY# — Initiator Ready indicates the master's ability to complete the current data cycle of the transaction.

STOP# — Stop indicates the current selected device is requesting the master to stop the current transaction.

DEVSEL# — Device Select is driven by the target device when its address is decoded.

IDSEL[3:0] — Initialization Device Select is used as a chip-select during configuration.

LOCK# — Lock indicates an operation that may require multiple transactions to complete.

Error Reporting

PERR# — Parity Error is for reporting data parity errors.

SERR# — System Error is for reporting address parity errors.

Arbitration (Bus Masters Only)

REQ[3:0]# — Request indicates to the arbitrator that this device desires use of the bus.

GNT[3:0]# — Grant indicates to the requesting device that access has been granted.

System

CLK — Clock provides timing for all transactions on the PCI bus.

RST# — Reset is used to bring PCI-specific registers to a known state.

Interrupts

INTA# — Interrupt A is used to request Interrupts.

INTB# — Interrupt B is used to request Interrupts only for multi-function devices.

INTC# — Interrupt C is used to request Interrupts only for multi-function devices.

INTD# — Interrupt D is used to request Interrupts only for multi-function devices.

Power Supplies and VIO

+5 V — +5 V supply connected to the PC/104 bus and Auxiliary Power Connector (**CN3**) +5 V supplies. This is the only power supply that is required for board operation.

+12 V — +12 V supply connected to the PC/104 bus and Auxiliary Power Connector (**CN3**) +12 V supplies.

-12 V — -12 V supply connected to the PC/104 bus and Auxiliary Power Connector (**CN3**) -12 V supplies.

+3.3 V — The +3.3 V pins on the PC/104-Plus (PCI) connector are connected to the Auxiliary Power Connector (**CN3**) by default. To supply +3.3V via the onboard +3.3V power supply, contact RTD Technical Support.

VIO — This signal is typically the I/O power to the bus drivers on a PCI bus card, or used by the clamp diodes on a PCI bus card. This is always driven by the cpuModule. By default, the signaling level is set to +3.3 V. For information on configuring VIO for +5 V, contact RTD Technical Support.

ATX Power Management Signals (optional)

If an ATX power supply is connected to the system, the following signals listed below may be used to wake the system from low power modes. For more information on these signals, refer to the *Power Management* section on page 73.

+5V_STDBY — Some low power modes require that +5 V standby power is applied to the cpuModule during the wake event. This signal is an input to the CPU.

PME# — Power Management Event input

PSON# — This is an active low open-drain output used to turn the power supply on when the system is exiting a low power state.



Note Use of these signals will require board customization. For more information, contact the RTD.

Bridge Link (CN4)

The Bridge Link connector allows devices that requires Legacy/ISA interrupts to interface with the cpuModule. When ISA devices are installed in the system (via a PCI to ISA bridge card), the Bridge Link connector provides Legacy/ISA DMA request signals, as well as a serial interrupt signal which permits access to all available system interrupts.

Multiple devices may utilize the serial interrupt signal, SERIRQ, which is decoded on the cpuModule. Only one device may use the DMA request and grant signal pair.

Table 34 Bridge Link (CN4)

Pin	Signal	Function
1	GND	Ground
2	DMAREQ	Legacy/ISA DMA Request
3	SERIRQ	Serial Interrupt Request
4	DMAGNT	Legacy/ISA DMA Grant

Facing the connector pins, the pinout is:

3	1
SERIRQ	GND
DMAGNT	DMAREQ
4	2

External Power Management (CN12)

An external power management connector (CN12) is available for external devices to wake the system from low power states. Some low power modes require that +5 V standby power is applied to the cpuModule during the wake event.

For more information on power management, including a description of the board's supported wake options, refer to the *Power Management* section on page 73.

Table 35 External Power Management (CN12)

Pin	Signal	Function
1	+5V_STDBY	+5 V standby Power
2	GND	Ground
2	PME#	Power Management Event input

Optional RTC Battery Input (CN13)

The optional RTC battery input is the connection for an external backup battery. This battery is used by the cpuModule when system power is removed in order to preserve the date and time in the real time clock.

Connecting a battery is only required to maintain time when power is completely removed from the cpuModule. A battery is not required for board operation.

Table 36 Optional RTC Battery Input (CN13)

Pin	Signal	Function
1	BAT	RTC Battery Input
2	GND	Ground



WARNING This optional RTC battery connector (CN13) should be left unconnected if the utility port connector (CN5) has a battery connected.

Fan Power, +5 V (CN14)

If a fan is required to cool the cpuModule, it can be wired to CN14, which provides a continuous connection to +5 V and ground.

Table 37 Fan Power, +5 V (CN14)

Pin	Signal	Function
1	+5V	+5 Volts DC
2	GND	Ground



Note To utilize the thermal fan mode feature in the BIOS, the fan must be connected to CN15

Fan Power, Switched (CN15)

The switched fan power connector (CN15) is an optional fan connector which allows the system to power the fan only when the processor temperature reaches high temperatures.

To utilize this connector, refer to the *Thermal Management* section on page 72.

Table 38 Fan Power, Switched (CN15)

Pin	Signal	Function
1	CPU_FAN_PWM	+5 Volts DC, switched
2	GND	Ground



Chapter 4 Using the cpuModule

This chapter provides information for users who wish to develop their own applications programs for the CMX158886 cpuModule.

This chapter includes information on the following topics:

- The RTD Enhanced AMI BIOS* — page 56
- Memory Map* — page 59
- I/O Address Map* — page 60
- Hardware Interrupts* — page 61
- multiPort: Advanced Digital I/O Ports (aDIO™)* — page 62
- multiPort: Parallel Port Control* — page 66
- multiPort: Floppy Drive* — page 66
- AC'97 Audio* — page 66
- Ethernet (10/100Base-T and -TX)* — page 66
- IDE Controller Configuration* — page 67
- Real Time Clock Control* — page 69
- Watchdog Timer Control* — page 71
- Thermal Management* — page 72
- Power Management* — page 73
- Multi-Color LED* — page 76
- Reset Status Register* — page 77
- DVMT Mode Select* — page 79
- User EEPROM* — page 80
- Features and Settings That Can Affect Boot Time* — page 81
- System Recovery* — page 82
- Basic Interrupt Information for Programmers* — page 83

The RTD Enhanced AMI BIOS

The RTD Enhanced AMI BIOS is software that interfaces hardware-specific features of the cpuModule to an operating system (OS). Physically, the BIOS software is stored in a Flash EPROM on the cpuModule. Functions of the BIOS are divided into two parts.

The first part of the BIOS is known as POST (power-on self-test) software, and it is active from the time power is applied until an OS boots (begins execution). POST software performs a series of hardware tests, sets up the machine as defined in Setup, and begins the boot of the OS.

The second part of the BIOS is known as the CORE BIOS. It is the normal interface between cpuModule hardware and the OS which is in control. It is active from the time the OS boots until the cpuModule is turned off. The CORE BIOS provides the system with a series of software interrupts to control various hardware devices.

Configuring the RTD Enhanced AMI BIOS

The cpuModule Setup program allows you to customize the cpuModule's configuration. Selections made in Setup are stored on the board and are read by the BIOS at power-on.

Entering the BIOS Setup

You can run Setup by rebooting the cpuModule and repeatedly pressing the **Delete** key. When you are finished with Setup, save your changes and exit. The system will automatically reboot.

Field Selection

To move between fields in Setup, use the keys listed below.

Table 39 Setup Keys

Key	Function
→, ←, ↓, ↑	Move between fields
+, -, PgUp, PgDn	Selects next/previous values in fields
Enter	Go to the submenu for the field
Esc	To previous menu then to exit menu

Main Menu Setup Fields

The following is a list of Main Menu Setup fields.

Table 40 Main Menu Setup Fields

Field	Active Keys	Selections
Main	Press Enter to select	Access system information such as BIOS version, EPLD version, and CMOS time and date settings
Advanced	Press Enter to select	Setup advanced cpuModule features
PCIPnP	Press Enter to select	Set PnP and PCI options and control system resources
Boot	Press Enter to select	Set the system boot sequence
Security	Press Enter to select	Setup the supervisor and user access passwords or enable boot sector virus protection
Power	Press Enter to select	Control power management settings, including power supply type, and system wake functions
Thermal	Press Enter to select	Monitor the cpuModule temperature, or activate thermal or fan modes.
Exit	Press Enter to select	Save or discard changes and exit the BIOS, or load the default BIOS settings



Note Future BIOS versions may have slightly different setup menus and options.

Power On Self Test (POST) Codes

Each POST Code represents a series of events that take place in a system during the POST. If the POST fails during a particular POST Code, the system will not boot as expected.

The BIOS uses I/O port 80h to store the active POST Code. A POST Code board is a tool that is used to display the POST Codes on I/O port 80h. This is usually accomplished with two 7-segment LEDs. Such a board is useful for debugging a system that is unable to boot.

Booting to Boot Block Flash with Fail Safe Boot ROM



Note Boards are shipped with Fail Safe Boot ROM enabled. When Fail Safe Boot ROM is enabled, the system will boot to it exclusively.

The Fail Safe Boot ROM is a minimal build of ROM-DOS™ located inside a surface-mounted Boot Block Flash chip. Boot Block Flash is a write-protected flash device that contains the BIOS and extra room where the Fail Safe Boot ROM is stored. Additionally, Fail Safe Boot ROM is an emergency interface accessible by an external computer. The ROM DISK contains utilities for remote access to the system's disk drives. Due to the size of the flash chip, Fail Safe Boot ROM contains an abbreviated selection of the ROM-DOS™ utilities; however, the complete ROM-DOS™ is contained on a CD shipped with the cpuModule.

The purpose of the Fail Safe Boot ROM is to make the cpuModule bootable upon receipt. The Fail Safe Boot ROM can be used as an indicator of the module's functionality when booting problems arise with another operating system. This test can be accomplished by enabling the Fail Safe Boot ROM in the Boot section of the BIOS Setup Utility. Enabling this option forces the cpuModule to boot to Fail Safe Boot ROM.

To boot to the Fail Safe Boot ROM, install jumper **JP5**, and apply power to the system.



Note If power is applied to the system while **JP5** is installed, the multi-color LED will turn red.

Memory Map

Table 41 shows how memory in the first megabyte is allocated in the system.

Table 41 First Megabyte Memory Map

Address (hex)	Description
C0000–FFFFFh ROM	256 KB BIOS in Flash EPROM, shadowed into DRAM during runtime.
C0000–EFFFFh	Run time user memory space. Usually, memory between C0000h and CFFFFh is used for the BIOS of add-on VGA video cards.
A0000–BFFFFh	Normally used for video RAM as follows: EGA/VGA 0A0000–0AFFFFh Monochrome 0B0000–0B7FFFh CGA 0B8000–0BFFFFh
00502–9FFFFh	DOS reserved memory area
00400–00501h	BIOS data area
00000–003FFh	Interrupt vector area

Memory beyond the first megabyte can be accessed in real mode by using EMS or a similar memory manager. See your OS or programming language references for information on memory managers.

I/O Address Map

As with all standard PC/104 boards, the I/O total I/O space is 64k in size. However, because early processors only addressed 0 address lines (SA0–SA9), the first 1k is used for legacy I/O devices. Any ISA add-on modules you install must therefore use I/O addresses in the range of 0–1023 (decimal) or 000–3FF (hex). The upper I/O addresses are used for PCI I/O devices, and are automatically assigned by the BIOS or operating system at boot time.



Note If you add any PC/104 modules or other peripherals to the system you must ensure they do not use reserved addresses listed below, or malfunctions will occur. The exception to this is if the resource has been released by the user.

Table 42 lists I/O addresses reserved for the CMX158886 cpuModule.

Table 42 I/O Addresses Reserved for the CMX158886 cpuModule

Address Range (hex)	Bytes	Device
000–00Fh	16	DMA Controller
010–01Fh	16	Reserved for CPU
020–021h	2	Interrupt Controller 1
022–02Fh	13	Reserved
040–043h	4	Timer
060–064h	5	Keyboard Interface
070–071h	2	Real Time Clock Port
080–08Fh	16	DMA Page Register
0A0–0A1h	2	Interrupt Controller 2
0C0–0DFh	32	DMA Controller 2
0F0–0FFh	16	Math Coprocessor
100–101h	2	Video Initialization
1F0–1FFh	16	Hard Disk ¹
200–201h	2	Reserved
238–23Bh	4	Bus Mouse ²
2E8–2EFh	8	Serial Port ³
2F8–2FFh	8	Serial Port ³
3E8–3EFh	8	Serial Port ³
3F0–3F7h	8	Floppy Disk ¹
3F8–3FFh	8	Serial Port ³
450–454h	4	aDIO ⁴
455h	1	Watchdog Timer ⁵
456–45F	9	EPLD

1. If a floppy or IDE controller is not connected to the system, the I/O addresses listed will not be occupied.
2. If a PS/2 mouse is not connected to the system, the I/O addresses listed will not be occupied.
3. The I/O addresses for the serial port are selected in the BIOS Setup utility.
4. If aDIO is disabled, the I/O addresses listed will not be occupied.
5. If watchdog timer is disabled, the I/O addresses listed will not be occupied.

Hardware Interrupts



Note If you add any expansion modules or other peripherals to the system, you must ensure they do not use interrupts needed by the `cpuModule`, or malfunctions will occur.

The CMX158886 `cpuModule` supports the standard PC interrupts listed in Table 43. Interrupts not in use by hardware on the `cpuModule` itself are listed as available. Similarly, if the operating system is using APIC, more IRQs will be available.

Table 43 Hardware Interrupts Used on the CMX158886 `cpuModule`

Interrupt	Normal Use
0	Timer 0
1	Keyboard
2	Cascade of IRQ 8–15
3	COM2
4	COM1
5	Available
6	Floppy
7	Printer
8	Real Time Clock
9	Available, routed to IRQ 2
10	Available
11	Available
12	Bus Mouse
14 ¹	Primary IDE hard disk
15 ¹	ATA/IDE Disk Chip socket

1. IRQs 14 and 15 may be available if the IDE controller is configured in Native Mode (refer to *IDE Controller Configuration* — page 67)



Note The `cpuModule` has onboard PCI devices that will claim IRQ lines. In some instances, a PCI device will claim an IRQ line that is required by a legacy device. To reserve an IRQ for a legacy device, refer to the PnP/PCI Configuration Setup fields in the BIOS.

Note A device's hardware interrupt will be available for use if the given device is not present in the system and the device is disabled in Setup.

For external devices that require Legacy/ISA interrupts, a serial interrupt signal is available which permits access to the CPU's hardware interrupts. One pair of Legacy/ISA DMA request/grant signals are also available. For more information on the serial interrupt signal, and the DMA request/grand pair, refer to *Bridge Link (CN4)* in Chapter 3, *Connecting the cpuModule*

multiPort: Advanced Digital I/O Ports (aDIO™)

Ensure that the BIOS setup has the multiPort set to aDIO mode. This board supports 16 bits of TTL/CMOS compatible digital I/O (TTL signaling). These I/O lines are grouped into two ports, Port 0 and Port 1. Port 0 is bit programmable; Port 1 is byte programmable. Port 0 supports RTD's Advanced Digital Interrupt modes. The three modes are strobe, match and event. Strobe mode generates an interrupt and latches Port 0 when the strobe input transitions from low to high. Match mode generates an interrupt when an 8-bit pattern is received in parallel that matches the match mask register. Event mode generates an interrupt when a change occurs on any bit. In any mode, masking can be used to monitor selected lines.

When the CPU boots, all digital I/O lines are programmed as inputs, meaning that the digital I/O line's initial state is undetermined. If the digital I/O lines must power up to a known state, an external 10 kΩ resistor must be added to pull the line high or low.

The 8-bit control read/write registers for the digital I/O lines are located from I/O address 450h to 454h. These registers are written to zero upon power up. From 450h to 454h, the name of these registers are **Port 0 data**, **Port 1 data**, **Multi-Function**, **DIO-Control**, and **Wake Control** register.



Note RTD provides drivers that support the aDIO interface on popular operating systems. RTD recommends using these drivers instead of accessing the registers directly.

Digital I/O Register Set

Table 44 Port 0 Data I/O Address 450h

D7	D6	D5	D4	D3	D2	D1	D0
P0.7	P0.6	P0.5	P0.4	P0.3	P0.2	P0.1	P0.0

Port 0 Data register is a read/write bit direction programmable register. A particular bit can be set to input or output. A read of an input bit returns the value of port 0. A read of an output bit returns the last value written to Port 0. A write to an output bit sends that value to port 0.

Table 45 Port 1 Data I/O Address 451h

D7	D6	D5	D4	D3	D2	D1	D0
P1.7	P1.6	P1.5	P1.4	P1.3	P1.2	P1.1	P1.0

Port 1 Data register is a read/write byte direction programmable register. A read on this register when it is programmed to input will read the value at the aDIO connector. A write on this register when it is programmed as output will write the value to the aDIO connector. A read on this register when it is set to output will read the last value sent to the aDIO connector.

Table 46 Multi-Function I/O Address 452h

D7	D6	D5	D4	D3	D2	D1	D0
----	----	----	----	----	----	----	----

The multi-function register is a read/write register whose contents are set by the DIO-Control register. See the DIO-Control register description for a description of this register.

Table 47 DIO-Control I/O Address 453h—Read Access

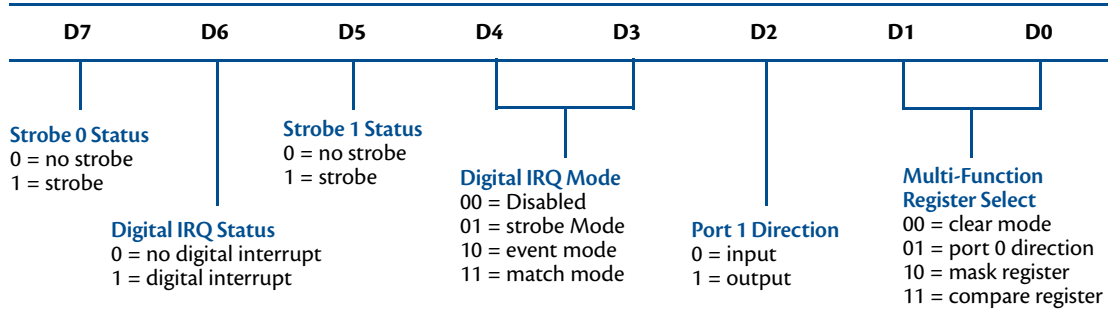

Table 48 DIO-Control I/O Address 453h—Write Access

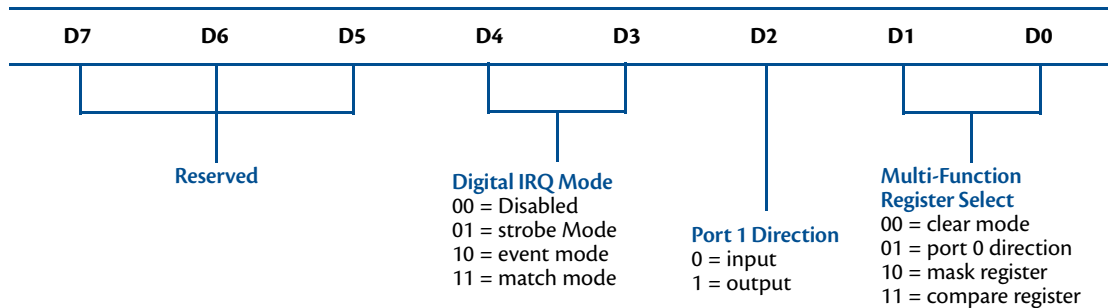

Table 49 Multi-Function at Address 452h¹

read/write	00 clear	X	X	X	X	X	X	X	X
0 in, 1 out	01 Port 0 direction	I/O	I/O	I/O	I/O	I/O	I/O	I/O	I/O
0 no mask, 1 mask	10 DIO mask	M7	M6	M5	M4	M3	M2	M1	M0
read/write	11 compare	C7	C6	C5	C4	C3	C2	C1	C0

1. Contents based on bits D0 and D1 of DIO-Control.

Clear Register:

A read to this register Clears the IRQs and a write to this register sets the DIO-Compare, DIO- Mask, DIO-Control, Port 1, and Port 0 to zeros. A write to this register is used to clear the board.

Port 0 Direction Register:

Writing a zero to a bit in this register makes the corresponding pin of the aDIO connector an input. Writing a one to a bit in this register makes the corresponding pin of the aDIO connector an output.

Mask Register:

Writing a zero to a bit in this register will not mask off the corresponding bit in the DIO-Compare register. Writing a one to a bit in this register masks off the corresponding bit in the DIO-Compare register. When all bits are masked off the aDIOs comparator is disabled. This condition means Event and Match mode will not generate an interrupt. This register is used by Event and Match modes.

Compare Register:

A Read/Write register used for Match Mode. Bit values in this register that are not masked off are compared against the value on Port 0. A Match or Event causes bit 6 of DIO-Control to be set and if the aDIO is in Advanced interrupt mode, the Match or Event causes an interrupt.

Table 50 Wake Control I/O Address 451h

D7	D6	D5	D4	D3	D2	D1	D0
Reserved						Int Mask	Wake Enable
						1 = Interrupt is masked 0=Interrupt is enabled	1=Interrupt triggers a Wake Event 0=Interrupt does not trigger a wake event.

Port 1 Data register is a read/write byte direction

Interrupts

In order to use an interrupt with aDIO, the interrupt must first be selected in the BIOS setup utility under **Advanced, I/O Devices, aDIO Configuration, aDIO Interrupt**. The Digital I/O can use interrupts 3, 5, 6, 7, 10, 11, and 12. The interrupt must also be reserved so that it is not assigned to PCI devices. To reserve the interrupt, enter the BIOS under **PCIPnP** and change the interrupt you wish to use to “Reserved.” Then, select the appropriate interrupt mode in the DIO Control register. Also, verify that the Int Mask bit is cleared in the Wake Control register

Advanced Digital Interrupts

There are three Advanced Digital Interrupt modes available. These three modes are Event, Match, and Strobe. The use of these three modes is to monitor state changes at the aDIO connector. Interrupts are enabled by writing to the **Digital IRQ Mode** field in the **DIO-Control** register.

Event Mode

When this mode is enabled, Port 0 is latched into the DIO-Compare register at 8.33 MHz. The aDIO circuitry includes deglitching logic. The deglitching requires pulses on Port 0 to be at least 120 ns in width. As long as changes are present longer than that, the event is guaranteed to register. Pulses as small as 60 ns can register as an event, but they must occur between the rising and falling edge of the 8.33 MHz clock. To enter Event mode, set bits [4:3] of the DIO-Control register to “10”.

Match Mode

When this mode is enabled, Port 0 is latched into the DIO-Compare register at 8.33 MHz. The aDIO circuitry includes deglitching logic. The deglitching requires pulses on Port 0 to be at least 120 ns in width. As long as changes are present longer than that, the match is guaranteed to register. Pulses as small as 60 ns can register as a match, but they must occur between the rising and falling edge of the 8.33 MHz clock. To enter Match mode, set bits [4:3] of the DIO-Control register to “11”.



Note Make sure bits [4:3] are set BEFORE writing the DIO-Compare register. If you do not set them first, the contents of the DIO-Compare register could be lost because the Event mode latches in Port 0 into the DIO-Compare register.

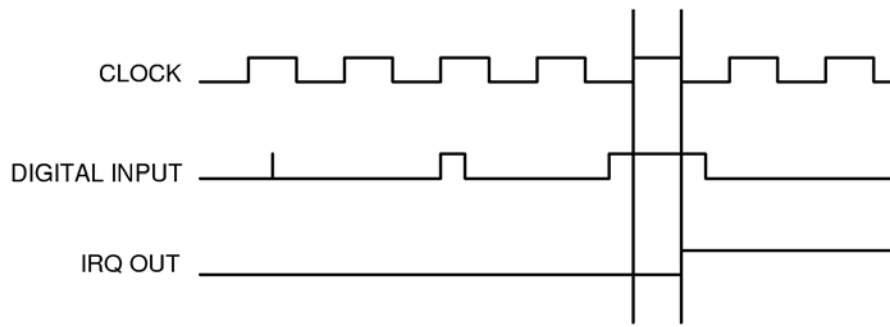

Figure 6 aDIO Match Mode

Strobe Mode

Another interrupt mode supported by aDIO is Strobe mode. This allows the strobe pin of the DIO connector to trigger an interrupt. A low to high transition on the strobe pin will cause an interrupt request. The request will remain high until the Clear Register is read from. Additionally, the Compare Register latched in the value at Port 0 when the Strobe pin made a low to high transition. No further strobes will be available until a read of the Compare Register is made. You must read the Compare Register, and then clear interrupts so that the latched value in the compare register is not lost. To enter Strobe mode, set bits [4:3] of the DIO-Control register to "01".

Wake-on-aDIO

The aDIO Strobe, Match and Event interrupt can be used to generate a wake event. This event can wake the CPU from any power-down mode, including Soft-Off (S5). Wake from aDIO will work as long as +5V Standby power is applied to the board. To use the aDIO to wake the system, Wake from aDIO must first be enabled in the BIOS setup utility. Then the aDIO is configured in the appropriate interrupt mode. The "Wake Enable" bit is then set in the Wake Control Register at 0x454. The CPU can then be placed in a standby mode, and the aDIO interrupt will wake the system.

During system standby, a 32kHz clock is used for the aDIO instead of an 8.33 MHz clock. Therefore, transitions must be at least 30 us in order to trigger a wake event.

If the aDIO is to be used for a wake event only, and not an interrupt, the "Int Mask" bit can be set in the Wake Control Register. This will block the interrupt, but still allow a wake event to occur. The various settings for "Wake Enable" and "Int Mask" are shown in Table 51 below.

Table 51 Interrupt and Wake Event Generation

WakeEnable	Int Mask	Function
0	0	Interrupt Only
0	1	No Interrupt or Wake event is generated
1	0	Interrupt and Wake Event
1	1	Wake Event Only

multiPort: Parallel Port Control

The parallel port may be operated in SPP (output-only), EPP (bidirectional), and ECP (extended capabilities) modes. The mode may be selected in the BIOS, or by application software.

To configure the parallel port in the BIOS, enter the BIOS, and follow the steps below:

1. Under the “Advanced” menu in the BIOS, select the “I/O Device Configuration” submenu
2. Set the multiPort mode to “Parallel Port”
3. When a new “Parallel Port Configuration” appears, select it and configure the parallel port base address, parallel port mode, and IRQ

multiPort: Floppy Drive

The multiPort connector can be configured as a floppy drive. To utilize the floppy controller, the multiPort mode must be first be set to Floppy Drive in the BIOS. The complete process for setting up the multiPort as a floppy drive is described below.

1. With the system powered off, attach a floppy drive with an adapter board to **CN6**.
2. Power on the system and enter the BIOS setup screen by pressing the delete key as the system boots.
3. Set Drive A to **1.44 MB** in the Standard CMOS Settings section of BIOS Setup.
4. Set the multiPort to **Floppy** in the BIOS Setup.
5. If booting to the floppy drive is required, set the first boot device in the boot sequence to floppy drive

When the floppy drive is enabled, a special cable and adapter board is required. For more information about this cable kit, refer to the *Cable Kits and Accessories* section in page 6.

AC'97 Audio

To use the CPU's onboard audio, it must first be enabled in the BIOS. Two signaling levels are supported, so a line out connection can be used for powered speakers, as well as a headphone connection for non-powered speakers.

Once enabled, two audio output modes can be selected:

- **Line Out:** This signaling level should be used for powered speakers.
- **Headphone:** This signaling level should be used for non-powered speakers.

Ethernet (10/100Base-T and -TX)

To use the onboard 10/100 Ethernet controller, Ethernet must first be enabled in the BIOS.

When enabled, the multi-color LED will blink to indicate an Ethernet connection. For more information, refer to the *Multi-Color LED* section on page 76.

IDE Controller Configuration

The CPU's onboard EIDE connector (**CN10**) supports several different drive speed modes, which are BIOS configurable. Supported drive modes will depend on whether a 40-conductor or 80-conductor cable is connecting the EIDE device. The modes and cable detection schemes described below may be set in the BIOS Setup. Similarly, the ATA/IDE Disk Chip socket (**U16**) is BIOS configurable.

Cable Modes

There are two types of cables that may be used for connecting drives to the EIDE connector: 40 conductor cables or 80 conductor cables. Depending on the cable used, different drive speeds are supported. A 40 conductor cable can be used for speeds up to UDMA Mode 2 (Ultra ATA/33).

In order to use drive speeds faster than UDMA Mode 2 (Ultra ATA/33), an 80 conductor cable is required. The BIOS can be configured to detect the presence of an 80 conductor cable. The 80 conductor cable adds a ground wire between each signal, and uses standard 40 pin connectors.

Cable Detection

Every time the cpuModule is powered on or a hardware reset is issued, the BIOS will automatically detect the presence of a 80 conductor cable connecting a device to **CN10**. The user selectable cable detection modes are described below.

Device and Host Mode

For this method, there is a capacitor on the CBLID pin at the CPU, and a pull-up at the hard drive. The CPU sends a command to the hard drive to drive the CBLID pin low, and then release it. The CPU then waits a certain amount of time, and instructs the hard drive to read the status of the CBLID pin. If an 80 conductor cable is attached, the CBLID signal is not connected between the CPU and the hard drive, and the hard drive will read the signal as a logic high. If a 40 conductor cable is attached, the CBLID pin is connected between the CPU and the hard drive, the capacitor delays the signal from going high, and the hard drive reads it as a logic low.

Host Determination of Cable Type

For this method of detection, the CPU reads the CPBLID pin, which determines if a 40-conductor or 80-conductor cable is connected between the CPU and device. An 80-conductor cable has this signal grounded at the CPU end, and not connected to the hard drive. A 40-conductor cable connects the CBLID signal to the hard drive, where it is pulled to a logic high.

Device Detect

For device detect mode, the CPU issues a command to the device, which tells the CPU the fastest drive speed mode it can use. The CPU then sets the transfer mode to the fastest speed supported by the device.



WARNING When this cable detection method is enabled, the highest transfer speed supported by the device will be used regardless of whether a 40-conductor or 80-conductor cable is used. If the device speed does not match the cable, data corruption and unexpected behaviors may occur. This mode should not be selected unless the user knows the cable type and the modes supported by the connected EIDE device.

Legacy Mode and Native Mode IDE

The onboard EIDE controller may be configured as either a Legacy or Native Mode IDE controller in the BIOS Setup. However, the operating system must support the selected mode for the device to operate correctly. The default configuration for the controller is Legacy Mode, as this is supported by most operating systems.

Legacy Mode

Legacy mode is the default configuration of the onboard EIDE controller. When in this mode, the controller will be fixed to use two interrupts: IRQs 14 and 15. Similarly, the I/O address of the controller will be fixed in the system. When in Legacy Mode, only a primary and secondary channel may be used in the system.

Native Mode

Native Mode allows more flexibility, as the system resources used by the IDE controller may be modified. When in Native Mode, the IDE controller only requires a single IRQ. Unlike Legacy Mode, this IRQ may be changed by the user or the operating system for better distribution of the system IRQs. When IRQs in the system are more evenly distributed, interrupt latency is minimized. The base address of the controller may also be modified.

Configuring the ATA/IDE Disk Chip Socket

The cpuModule was designed to be used in embedded computing applications. In such environments, rotating media like hard disks and floppy disks are not very desirable. It is possible to eliminate rotating storage devices by placing your operating system and application software into the cpuModule's ATA/IDE Disk Chip socket.



WARNING Before installing a device in the ATA/IDE Disk Chip socket, the system must be configured in the correct mode. For details on configuring the socket, refer to Chapter 4, Using the cpuModule

Before installing a device in the ATA/IDE Disk Chip socket, it is highly recommend to first configure the secondary IDE controller and device mode in the BIOS setup.

The secondary IDE controller must be enabled in the BIOS to allow read and write access to the device. When a device is installed in the socket, it will always appear as a master on the cpuModule's secondary IDE controller.

From the BIOS setup screen, the user can also configure whether the socket contains a DMA mode or PIO mode device.

- **DMA Mode:** DMA mode will reduce CPU overhead.
- **PIO Mode:** When the socket is in PIO mode, PIO transfers are supported. PIO mode supports write protection.

Real Time Clock Control

Overview

The cpuModule is equipped with a Real Time Clock (RTC) which provides system date and time functions. When the cpuModule is turned off, a battery must be attached to the utility connector to provide power to the RTC. Without power, the RTC will lose the date/time information when the system is turned off.

The RTC also provides an “alarm” function. This may be used to generate an interrupt at a particular time and day. This feature is commonly used to wake up the system from Sleep/Standby to run a scheduled task (defragment the hard drive, back up files, etc.).

In addition to the date/time/alarm functions, the RTC contains several bytes of battery-backed RAM, commonly called CMOS memory. In a typical desktop PC, the CMOS memory is used by the BIOS to store user settings. This RTD cpuModule uses onboard flash to store user BIOS settings. To preserve compatibility with traditional PCs, the RTD Enhanced BIOS also mirrors the user settings from flash in CMOS. Therefore, the contents of CMOS may be overwritten at boot time, and should be treated as “read only”.

Accessing the RTC Registers

You may access the RTC date/time and CMOS memory using the Index and Data Registers located at I/O addresses 70h and 71h.

- Address 70h is the Index register. It must be written with the number of the register to read or write. Valid values are 00h to 7Fh.
- Address 71h is the Data register. It contains the contents of the register pointed to by the Index.

To read/write an RTC register, you must first set the Index register with the register number, and then read/write the Data register.

A list of key RTC registers is shown in Table 52 below:

Table 52 Real Time Clock Registers

Registers (hex)	Registers (decimal)	Function
00h	0	RTC Seconds
02h	2	RTC Minutes
04h	4	RTC Hours
06h	6	RTC Day of Week
07h	7	RTC Day of Month
08h	8	RTC Month
09h	9	RTC Year
0Ah	10	RTC Status Register A

- **Bit 7:** RTC Update In Progress (Read Only) - RTC registers should not be accessed when this bit is high.
- **Bits 6-4:** Divider for 32.768 KHz input (should always be 010)
- **Bits 3-0:** Rate select for periodic interrupt.

Table 52 Real Time Clock Registers

Registers (hex)	Registers (decimal)	Function
0Bh	11	<p>RTC Status Register B</p> <ul style="list-style-type: none"> • Bit 7: Inhibit Update - When high, the RTC is prevented from updating. • Bit 6: Periodic Interrupt Enable - When high, the RTC IRQ will be asserted by the periodic interrupt. • Bit 5: Alarm Interrupt Enable - When high, the RTC IRQ will be asserted when the current time matches the alarm time. • Bit 4: Update Ended Interrupt Enable - When high, the RTC IRQ will be asserted every time the RTC updates (once per second). • Bit 3: Square Wave Enable - Not used. • Bit 2: Data Mode - Sets the data format of the RTC clock/calendar registers (0=BCD, 1=binary). This is typically set to BCD mode. • Bit 1: Hours Byte Format - Sets the hour byte to 12 or 24 hour time (0=12 hour, 1=24 hour). This is typically set to 24 hour mode. • Bit 0: Daylight Savings Enable - When high, the RTC will automatically update itself for Daylight Savings Time. It is recommended to leave this bit low and let the operating system manage time zones and DST.
0Ch	12	<p>RTC Status Register C (Read Only)</p> <ul style="list-style-type: none"> • Bit 7: IRQ Flag - Indicates that the Real Time Clock IRQ is asserted. Goes high whenever one of the enabled interrupt conditions in Register B occurs. • Bit 6: Periodic Flag • Bit 5: Alarm Flag • Bit 4: Update Ended Flag • Bit 3-0: Reserved <p>Reading this register will also clear any of set flag (IRQ, Periodic, Alarm, Update Ended). Note that even if the interrupt source is not enabled in Register B, the flags in Register C bits 4, 5, and 6 may still be set.</p>
0Dh	13	<p>RTC Status Register D</p> <ul style="list-style-type: none"> • Bit 7: Valid Time/Date (always reads 1) • Bit 6: Reserved • Bits 5-0: RTC Alarm Day of the Month



Note RTC registers that are not listed above are used by the BIOS and should be considered "Reserved". Altering the contents of any unlisted RTC register may interfere with the operation of your cpuModule. The specific uses of the unlisted RTC registers will depend on the BIOS version loaded on the cpuModule. Contact RTD's technical support for more information.

Watchdog Timer Control

The cpuModule includes a watchdog timer, which provides protection against programs “hanging”, or getting stuck in an execution loop where they cannot respond correctly. When enabled, the watchdog timer must be periodically reset by your application program. If it is not refreshed before the time-out period expires, it will cause a hardware reset of the cpuModule.

The watchdog time-out period is typically 1.1 seconds, but can vary between 550 ms and 1.65 seconds. Because of operating system latency, it is recommended that the watchdog be refreshed at half of the period, or every 275 ms.

Before using the Watchdog timer, it must be enabled in the BIOS setup utility. When it is disabled in the BIOS, the watchdog register does not appear in I/O space and it will not generate an a reset.



Note Enabling the watchdog timer in the BIOS does not actually arm it. The watchdog timer can be armed by accessing I/O address 455h, as explained below.

Three functions have been implemented on the cpuModule for controlling watchdog timer control. These are:

- **Arm:** The watchdog timer can be enabled by writing a 1 to bit 7 of I/O port 0x455. To ensure compatibility with future designs, you should read the register and only change the bit you need to change.
- **Disarm:** The watchdog timer is disabled by writing a 0 to bit 7 of I/O port 0x455. To ensure compatibility with future designs, you should read the register and only change the bit you need to change.
- **Refresh:** The watchdog timer is refreshed by reading from I/O port 0x455. After you enable the watchdog timer, you must refresh it at least once every 550 ms.

Table 53 Watchdog Timer Control I/O Address 455h

D7	D6	D5	D4	D3	D2	D1	D0
Watchdog Enable	Reserved						
0=Watchdog timer is disabled and will not generate an interrupt							
1=Watchdog Timer is enabled and needs to be refreshed							

Thermal Management

The cpuModule has several thermal features which can be used to monitor and control the board's temperature when extreme operating conditions are prevalent.

Thermal Monitor

The Intel® Thermal Monitor is a feature on the CMX158886 that automatically initiates a SpeedStep transition or throttles the CPU when the CPU exceeds its thermal limit. The maximum temperature of the processor is defined as the temperature that the Thermal Monitor is activated. The thermal limit and duty cycle of the Thermal Monitor cannot be modified.



Note The CPU and PCB temperatures displayed in the BIOS are approximate and should not be used to validate a cooling solution.

Fan Mode

The CPU fan can be controlled by the CPU when connected to the switched fan power connector (**CN15**). Three fan modes are supported, which can be toggled in the BIOS setup. When the fan is not always on, the CPU's power consumption is reduced, and the life of the fan is increased.

- **Always On:** When in this mode, the fan is always powered by the CPU.
- **On At 70C:** This mode allows the system to keep the fan turned off until the CPU reaches 70C. In this mode, the fan will slowly transition between on and off to prevent oscillations. This is the best mode for applications that will spend most of the time below 0C.
- **Variable:** The fan will spin slowly until the CPU reaches 60C, and then will increase speed. Maximum speed is reached when the CPU reaches 75C.



Note If the CPU fan is connected to the continuous +5 V fan connector (**CN14**), changing the fan mode options in the BIOS will not affect the fan, as it will always be turned on.

Further Temperature Reduction

The cpuModule's temperature is directly related to power consumption. Reducing the power consumption of the CPU will have an effect on the CPU's temperature. Suggested methods for reducing the CPU's power consumption can be found in the *Power Management* section on page 73.

Power Management

The CMX158886 cpuModule supports various powering mechanisms which allow the cpuModule to monitor power consumption and temperature, and achieve minimal power consumption states. These unique features include Enhanced Intel® SpeedStep® Technology (PX only), thermal monitoring and thermal throttling, as well as low power modes including ACPI configurations. Various wake options are also available to resume normal system power.

Enabling Enhanced Intel SpeedStep Technology (PX only)

When enabled, Enhanced Intel® SpeedStep® Technology can give application software greater control over the processor's operating frequency and input voltage. This allows the system to easily manage power consumption dynamically. This feature can be enabled or disabled in the BIOS. When enabled, the feature can be set to several different modes, which are described below.

- **Maximum Speed:** The processor speed is set to its maximum operating frequency.
- **Minimum Speed:** The processor speed is set to its minimum operating frequency.
- **Automatic:** When set to automatic mode, the processor speed is controlled by the operating system.

Advanced Configuration and Power Interface (ACPI)

The cpuModule supports several different ACPI low power modes, including the S1, S3, S4, and S5 sleeping states. The BIOS setup utility provides an option to select between S1 and S3 as the Standby state. Sleep modes S4 and S5 are setup by the operating system.

The cpuModule's ACPI suspend modes are described below

- **S1 (Power on Suspend):** The S1 low power state consumes the most power of all supported ACPI sleep modes. In this mode, the CPU stops executing instructions, but power to the CPU and RAM is maintained.
- **S3 (Suspend to RAM):** Everything in the system is powered off except for the system memory. When the system wakes from this mode, operating systems allow applications to resume where they left off, as the state of the application is preserved in memory.
- **S4 (Hibernate):** When the system enters this state, the operating system will save the current state of applications and relevant data to disk, thus allowing the system RAM to be powered down.
- **S5 (Soft-Off):** The system is in a soft off state, and must be rebooted when it wakes.

Power Button Modes

The soft power button input of the utility port connector (CN5) can be configured by the operating system as a suspend button (transition to S1 or S3) or as soft power button (transition to S5). Consult your operating system documentation for information on how to configure it. The power button will always cause a transition to S5 if pressed for 4 seconds or longer, without interaction from the operating system.

Low-Power Wake Options

The cpuModule supports several methods of waking from a low power state. Several of these wake options are BIOS configurable, and can be accessed directly from the "Power" menu in the BIOS setup:

- **Resume on Ring:** While in a low power mode, the ring indicator input of either COM port may be used to wake the system.

- **Resume on aDIO:** This option allows the system to use an aDIO Strobe, Match, or Event interrupt to generate a wake event. This event can wake the CPU from any power-down mode, including Soft-Off (S5). For more information, refer to the section titled *Wake-on-aDIO* on page 65.
- **Resume on PME#:** When enabled, the system can wake when a signal is applied to the External Power Management connector (**CN12**). This includes wake-up on onboard LAN controller. The PME# signal is also available on the *PC/104-Plus* (PCI) bus connector.
- **Resume on RTC Alarm:** The RTC Alarm allows the system to turn on at a certain time every day.

AT vs. ATX Power Supplies

Both AT and ATX power supplies may be used with the CMX158886 cpuModule, however AT power supplies do not provide any standby power to the cpuModule. When an AT power supply is used to power the system, low power modes that require a standby power to wake the system will not be fully supported.

ATX power supplies do provide a standby power, thus allowing the system to utilize all low power modes supported by the hardware. When an ATX supply is used to power the cpuModule, lower power modes can be achieved. During these low power modes, the standby power from the ATX power supply provides power to a small circuit on the CPU, which is used to watch for a system wake event.

ATX Power Supply Signals

The auxiliary power connector (**CN3**) provides two ATX style signals, +5V Standby and PSON#. The +5V Standby rail is used to power certain parts of the cpuModule when the main power supply is turned off, i.e. during Suspend-to-RAM (S3), Hibernate (S4), or Soft-Off (S5) power modes. The PSON# signal is an active low open-drain output that signals the power supply to turn on. Use of these signals allows the power consumption to drop to below 1W during standby modes, and still enable any of the wake events.

Reducing Power Consumption

In addition to the CPU's low power modes, power consumption can further be reduced by making some modifications to the BIOS setup. When the following features are modified, the CPU's power consumption will decrease:

- **CPU Speed:** Setting the processor to its minimum speed in the BIOS will reduce power consumption
- **Memory Speed:** Changing the DDR DRAM clock frequency will reduce power consumption, however memory performance will also be reduced.
- **Ethernet:** Can be disabled in the BIOS
- **Serial Ports:** Can be disabled in the BIOS
- **LVDS Flat Panel:** If an LVDS panel is not connected to the cpuModule while using a VGA monitor, setting the BIOS to use only a CRT (VGA) monitor will reduce power consumption.
- **Fan Mode:** Set the fan to auto mode so it is used only when the processor reaches high temperatures. This option will only effect the fan if it is connected to the switched fan power connector (**CN15**).
- **Multi-Color LED:** Can be disabled in the BIOS

Multi-Color LED

The CMX158886 has a Multi-Color LED located beside the EIDE connector (**CN10**) which can be enabled or disabled in the BIOS setup screen. The color of the LED indicates the status of the board, as shown in Table 54.

Table 54 LED Colors

Color	Description
Green	Normal Operation
Blue	On Board IDE Activity
Red	cpuModule is in reset ¹
Yellow (Red + Green)	cpuModule is in Standby
White (R+G+B)	cpuModule is approaching thermal limit ²
Cyan (Blue + Green)	Ethernet Link at 10 Mbps
Magenta (Blue + Red)	Ethernet Link at 100 Mbps
Blink	Ethernet Activity

1. If power is applied to the cpuModule while jumper **JPS** is installed, the LED will be red. This does not indicate that the board is in reset
2. The LED will remain White until the system is shut down.

The LED can also be controlled manually by writing to I/O Port 456h, as shown in Table 55 and Table 56.

Table 55 Multi-Color LED I/O Address 456h

D7	D6	D5	D4	D3	D2	D1	D0
Reserved (User EEPROM)	Reserved (User EEPROM)	Reserved (User EEPROM)	Reserved	Reserved			Multi-Color LED



Note When writing to I/O Port 456h, only the lower three bits of the register should be modified. Modifying the upper bits will effect the User EEPROM

The following table lists the color displayed and the value written.

Table 56 Manual LED Colors

I/O Port 456h Value	Color
0x00	Automatic (see Table 54)
0x08	Off (will reduce system power consumption.)
0x09	Blue
0x0A	Green
0x0B	Cyan (Green + Blue)
0x0C	Red
0x0D	Magenta (Red + Blue)
0x0E	Yellow (Red + Green)
0x0F	White (Red + Green + Blue)

Reset Status Register

The cpuModule has several different signals on board which can cause a system reset. If a reset occurs, the reset status register can be used to see which reset or resets have been asserted on the cpuModule.

The user has the ability to see which resets have been asserted. Resets can also be cleared.

- **Examine Resets:** Reading from I/O port 0x457 will indicate if a reset has been asserted. If a 1 is read, the corresponding reset has been asserted. If a 0 is read from the bit, the reset has not been asserted
- **Clear Reset:** Each reset can be cleared by writing a 1 to the selected bit of I/O port 0x457.

Table 57 Reset Status I/O Address 457h - Read Access

D7	D6	D5	D4	D3	D2	D1	D0
Main Power (+5V) 1 = reset asserted 0 = no reset	CPU Core Power 1 = reset asserted 0 = no reset	Non-Standby Power 1 = reset asserted 0 = no reset	Memory Power 1 = reset asserted 0 = no reset	Standby Power 1 = reset asserted 0 = no reset	Reserved	PCI Reset 1 = reset asserted 0 = no reset	Utility Reset 1 = reset asserted 0 = no reset

Table 58 Reset Status I/O Address 457h - Write Access

D7	D6	D5	D4	D3	D2	D1	D0
Main Power (+5V) 1 = clear reset	CPU Core Power 1 = clear reset	Non-Standby Power 1 = clear reset	Memory Power 1 = clear reset	Standby Power 1 = clear reset	Reserved	PCI Reset 1 = clear reset	Utility Reset 1 = clear reset

Table 59 Reset Status Description and Priorities

I/O Address 457h	Reset Signal	Reset Priority ¹	Description
D7	Main Power (+5V)	2	Main input power to cpuModule (+5V)
D6	CPU Core Power	3	CPU core powers supply
D5	Non-Standby Power	3	Power supplies that are not for standby power
D4	Memory Power	3	Power to onboard memory banks
D3	Standby Power	1	Standby power supplies
D2	reserved	-	reserved
D1	PCI Reset	4	PCI bus reset signal
D0	Utility Reset	-	Utility connector push button reset ²

1. When a reset is asserted, all resets with a higher reset priority will also be asserted. For example, if the standby power reset is asserted, all other resets will also be asserted.
2. The BIOS allows the user to change the function of the utility connector's push button reset. Even if the push button is not configured as a reset, this bit will always read a 1(asserted) when the reset button has been pushed.

DVMT Mode Select

The CMX158886 supports Dynamic Video Memory Technology (DVMT). DVMT allows the CPU to allocate memory to system processing or graphics processing on the fly based on changing processing requirements.

For example, a graphics intensive program will require the operating system to request a larger amount of video memory than one that does not require large amounts of graphics processing. For the graphics intensive process, DVMT will allocate a larger portion of system memory. When the process is complete, DVMT will allocate the memory back to the system.

The CMX158886 supports three user-selectable modes, including Fixed Mode, DVMT Mode, and Combo Mode.

- **Fixed Mode:** A fixed amount of system memory is reserved for video.
- **DVMT Mode:** Video memory is dynamically allocated as needed.
- **Combo Mode:** A fixed amount of memory is allocated, but more can be claimed as needed.

User EEPROM

A 512kB serial EEPROM (Atmel AT93C66) is available on the cpuModule for the user to save nonvolatile parameters on the cpuModule. The EEPROM can be accessed by reading and writing to I/O address 456h, as shown in the following table.

Table 60 User EEPROM I/O Address 456h

D7	D6	D5	D4	D3	D2	D1	D0
CS	SK	DI	DO	Reserved		(Multi-Color LED)	

Table 61 EEPROM Register Description

Bit	Signal	Function	Read / Write
D7	CS	Chip Select	Read / Write
D6	SK	Serial Data Clock	Read / Write
D5	DI	Serial Data Input	Read / Write
D4	DO	Serial Data Output	Read Only
D3		Reserved	
D2		(Multi-Color LED)	
D1		(Multi-Color LED)	
D0		(Multi-Color LED)	

Features and Settings That Can Affect Boot Time

The boot time of a system is dependent upon numerous system settings as well as devices attached to a system. This section addresses some devices and settings that can increase or decrease a system's boot time.

Quick Boot

The BIOS contains a Quick Boot option that minimizes the boot time of the system. Quick Boot eliminates the exhaustive tests that are performed during Power On Self Test (POST) while maintaining the functionality of the board. By enabling the Quick Boot feature, your system can achieve 5-second boot times.

Add-On Cards With BIOS Extensions

Some add-on cards have an integrated BIOS extension. The most common examples are SCSI controllers and network cards with boot ROMs. During POST, the BIOS executes the card's extension code. This extension code is third-party code, which is beyond RTD's control. The BIOS extension will most likely increase the boot time. Exactly how much it increases boot time will depend on the particular card and firmware version.

VGA Controller

VGA controllers have a VGA BIOS that must be initialized during POST. It can take some time to initialize the VGA BIOS. Exactly how long will depend on the particular VGA controller and BIOS version.

Hard Drive Type

During IDE initialization, each IDE device must be probed. Some devices take longer to probe. 2.5-inch hard drives tend to take longer than 3.5-inch ones, because they spin at a lower RPM.

Monitor Type

Some monitors take a while to power on. Desktop flat panels are especially slow. This does not affect the actual boot time of the CPU. However, the CPU may boot before the monitor powers on.

NVRAM Updates

System configuration data is stored in the onboard NVRAM. When the system configuration changes, this information must be updated. If an update is necessary, it will happen at the end of POST (the BIOS will display an "Updating NVRAM..." message). The NVRAM update takes a few seconds and increases the boot time. Once the NVRAM is updated, boot times will return to normal.

NVRAM updates only happen when the system configuration changes. They do not happen spuriously. They are usually triggered by adding or removing a PCI device from a stack. Updates can also be triggered by altering the Plug-n-Play configuration of the BIOS.

Boot Device Order

The BIOS contains a list of devices to try booting from. If you wish to boot to a particular device (for example, a hard drive), make sure that it is first in the boot order. This will speed up boot times.

System Recovery

Loading Default BIOS Settings

The default BIOS can be restored either by using the “Load Defaults” option in the BIOS, or by installing jumper **JP5** (see Figure 7 on page 87). In most cases, the easiest way to load default settings is by setting them in the BIOS. For other unique cases, jumper **JP5** provides an alternative method of restoring the BIOS settings.

To restore the default BIOS settings with jumper **JP5**, follow the procedure below.

1. Remove power from the system.
2. Install **JP5**.
3. Apply power to the system. The cpuModule will then load its default settings. Note that the multi-color LED will be red if power is applied while **JP5** is installed.
4. Reboot and press **Delete** to enter BIOS Setup.
5. Save the BIOS settings and exit, allowing the system to boot to the FSBR.
6. The next time the system is powered, the BIOS Setup will be configured to use the default settings.

Booting to the Fail Safe Boot ROM (FSBR)

If your system is in configuration that will not allow it to boot, the Fail Safe Boot ROM is a minimal build of ROM-DOS which can be booted to for system debugging. To boot to the FSBR, follow the instructions below.

1. Reboot the system and press **Delete** to enter BIOS Setup.
2. In the **Boot** menu, select **Bootup Options**, and change **RTD Fail Safe Boot ROM** to **Enabled**.
3. Save the BIOS settings and exit.

If you are unable to enter the BIOS Setup, an alternate method is to use **JP5** as described below:

1. Remove power from the system.
2. Install **JP5**. This will force the cpuModule to boot using the default BIOS configuration.
3. Apply power to the system. The cpuModule will then boot to the Fail Safe Boot ROM image. Note that the multi-color LED will be red if power is applied while **JP5** is installed.
4. Press the **Delete** key to enter Setup, or allow the cpuModule to boot to Failsafe

Basic Interrupt Information for Programmers

An interrupt is a subroutine called asynchronously by external hardware (usually an I/O device) during the execution of another application. The CPU halts execution of its current process by saving the system state and next instruction, and then jumps to the interrupt service routine, executes it, loads the saved system state and saved next instruction, and continues execution. Interrupts are good for handling infrequent events such as keyboard activity. Interrupts on this `cpuModule` are controlled by two Intel 8259-equivalent interrupt controllers containing 13 available interrupt request lines.

What happens when an interrupt occurs?

An IRQx pin on the PC/104 bus makes a low to high transition while the corresponding interrupt mask bit is unmasked and the PIC determines that the IRQ has priority, that is, the PIC interrupts the processor. The current code segment (CS), instruction pointer (IP), and flags are pushed onto the stack. The CPU then reads the 8-bit vector number from the PIC, and a new CS and IP are loaded from a vector—indicated by the vector number—from the interrupt vector table that exists in the lowest 1024 bytes of memory. The processor then begins executing instructions located at CS:IP. When the interrupt service routine is completed the CS, IP, and flags that were pushed onto the stack are popped from the stack into their appropriate registers and execution resumes from the point where it was interrupted.

How long does it take to respond to an interrupt?

A DOS system can respond to an interrupt between 6 and 15 μ s. A Windows system can take a much longer time when a service routine has been installed by a device driver implemented as a DLL—from 250 to 1500 μ s or longer. The time the CPU spends in the interrupt depends on the efficiency of the code in the ISR. These numbers are general guidelines and will fluctuate depending on operating system and version. Minimum time between two IRQ requests is 125 ns per ISA specification.

Interrupt Request Lines

To allow different peripheral devices to generate interrupts on the same computer, the ISA bus has eight different interrupt request (IRQ) lines. On the ISA bus, a transition from low to high on one of these lines generates an interrupt request, which is handled by the PC's interrupt controller. On the PCI bus, an interrupt request is level-triggered.

The interrupt controller checks to see if interrupts are to be acknowledged from that IRQ and, if another interrupt is already in progress, it decides if the new request should supersede the one in progress or if it has to wait until the one in progress is done. This prioritizing allows an interrupt to be interrupted if the second request has a higher priority. The priority level is based on the number of the IRQ; IRQ0 has the highest priority, IRQ1 is second-highest, and so on through IRQ7, which has the lowest. Many of the IRQs are used by the standard system resources. IRQ0 is used by the system timer, IRQ1 is used by the keyboard, IRQ3 by COM2, IRQ4 by COM1, and IRQ6 by the disk drives. Therefore, it is important to know which IRQ lines are available in your system for use by the `cpuModule`.

Intel 8259 Programmable Interrupt Controller

The chip responsible for handling interrupt requests in the PC is the Intel 8259 Programmable Interrupt Controller. To use interrupts, you need to know how to read and set the Intel 8259's interrupt mask register (IMR) and how to send the end-of-interrupt (EOI) command to the Intel 8259.

Each bit in the IMR contains the mask status of an IRQ line; bit 0 is for IRQ0, bit 1 is for IRQ1, and so on. If a bit is set (1), then the corresponding IRQ is masked and will not generate an interrupt. If a bit is clear (0), then the corresponding IRQ is unmasked and can generate interrupts. The IMR is programmed through port 21h.



Note When in APIC mode, the PIC is programmed differently, and IRQ routing behaves differently. For more information, refer to the APIC datasheets and specifications provided by Intel.

PCI Interrupts

PCI devices can share interrupts. The BIOS or operating system may assign multiple PCI devices to the same IRQ line. Any interrupt service routine (ISR) written for PCI devices must be able to handle shared interrupts. Refer to *Interrupt-Driven PC System Design* (ISBN: 0-929392-50-7) for more information on PCI interrupts.

Writing an Interrupt Service Routine (ISR)

The first step in adding interrupts to your software is to write the ISR. This is the routine that will automatically be executed each time an interrupt request occurs on the specified IRQ. An ISR is different than standard routines that you write. First, on entrance, the processor registers should be pushed onto the stack BEFORE you do anything else. Second, just before exiting your ISR, you must clear the interrupt status flag and write an end-of-interrupt command to the Intel 8259 controller. Finally, when exiting the ISR, in addition to popping all the registers you pushed on entrance, you must use the IRET instruction and not a plain RET. The IRET automatically pops the flags, CS, and IP that were pushed when the interrupt was called.

Most C compilers allow you to identify a procedure (function) as an interrupt type and will automatically add these instructions to your ISR, with one important exception: most compilers do not automatically add the end-of-interrupt command to the procedure; you must do this yourself. Other than this and the few exceptions discussed below, you can write your ISR just like any other routine. It can call other functions and procedures in your program and it can access global data. If you are writing your first ISR, RTD recommends focusing on the basics, such as incrementing a global variable.

Most operating systems have restrictions on what instructions can be called in your ISR. Consult your OS documentation for details on writing your ISR.



Note A complete explanation of interrupt programming is beyond the scope of this manual. For more information on interrupts, refer to the Appendix.

Sample Code

RTD's drivers provide examples of ISR's and interrupt handling. Refer to them as working examples. These drivers were shipped with your cpuModule, but they can also be downloaded from RTD's website (www.rtd.com).



Appendix A Hardware Reference

This appendix provides information on CMX158886 cpuModule hardware, including:

Jumper Settings and Locations — page 86

Onboard PCI Devices — page 88

Physical Dimensions — page 89

Jumper Settings and Locations

Many cpuModule options are configured by positioning jumpers. Jumpers are labeled on the board as **JP** followed by a number.

Some jumpers have three pins, allowing three settings:

- Pins 1 and 2 connected (indicated as “1–2”)
- Pins 2 and 3 connected (indicated as “2–3”)
- No pins connected

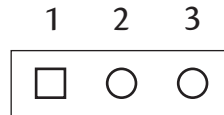

Some jumpers have two pins, allowing two settings:

- Pins 1 and 2 connected (indicated as “closed”)
- Pins 1 and 2 unconnected (indicated as “open”)

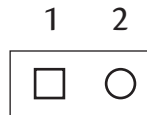

Figure 7 shows the jumper locations that are used to configure the cpuModule. Table 62 lists the jumpers and their settings.

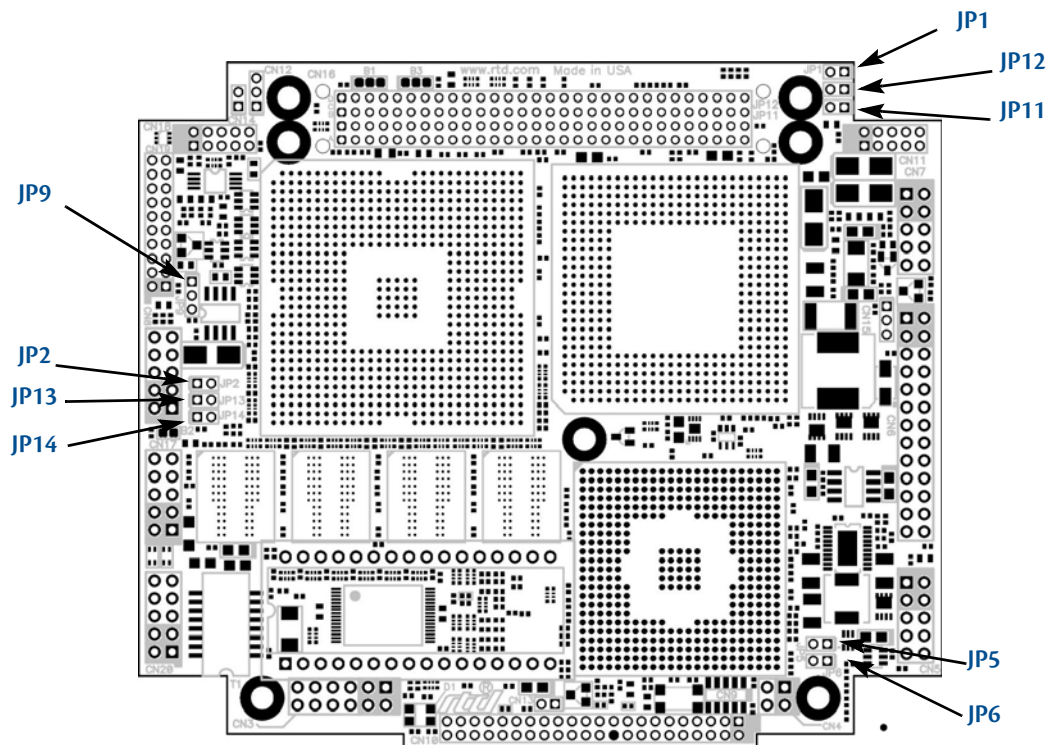

Figure 7 CMX158886 Jumper Locations (top side)

Table 62 CMX158886 Jumpers

Jumper	Pins	Function	Default
JP1	2	Enable/disable 120 Ω series termination to COM1 (CN7) in RS-422/485 modes	open
JP2	2	Enable/disable 120 Ω series termination to COM2 (CN8) in RS-422/485 modes	open
JP5	2	Install to load the default BIOS settings and boot to Fail Safe (for more information, refer to <i>System Recovery</i> — page 82). Note that the multi-color LED will be red if JP5 is installed.	open
JP6	2	Reserved	open
JP9	3	Select power for flat panel backlight pins 1–2: +12 V pins 2–3: +5 V	pins 2–3
JP11	2	Enable/disable 120 Ω series termination to second serial port on CN7 in RS-422/485 modes	open
JP12	2	Install to support RS-422/485 modes for second serial port on CN7	open
JP13	2	Enable/disable 120 Ω series termination to second serial port on CN8 in RS-422/485 modes	open
JP14	2	Install to support RS-422/485 modes for second serial port on CN8	open

Onboard PCI Devices

The CMX158886 cpuModule has several onboard PCI devices, all of which are listed in the table below.

Table 63 Onboard PCI Devices

Device ID	Vendor ID	Description
103E	8086	LAN Controller
244E	8086	Hub to PCI Bridge
24C0	8086	PCI to LPC Bridge
24C2	8086	USB UHCI Controller
24C3	8086	SMBus Controller
24C5	8086	AC'97 Audio Controller
24CB	8086	IDE Controller
24CD	8086	USB EHCI Controller
3580	8086	Host-Hub
3582	8086	Graphics Device
3584	8086	Main Memory
3585	8086	Configuration Process
-	-	PCI Slot 1
-	-	PCI Slot 2
-	-	PCI Slot 3
-	-	PCI Slot 4



Appendix B Troubleshooting

Many problems you may encounter with operation of your CMX158886 cpuModule are due to common errors. This appendix includes the following sections to help you get your system operating properly.

Common Problems and Solutions — page 92

Troubleshooting a PC/104-Plus System — page 93

How to Obtain Technical Support — page 94

Common Problems and Solutions

Table 64 lists some of the common problems you may encounter while using your CMX158886 cpuModule, and suggests possible solutions.

If you are having problems with your cpuModule, review this table before contacting RTD Technical Support.

Table 64 Troubleshooting

Problem	Cause	Solution
cpuModule "will not boot"	no power or wrong polarity	<ul style="list-style-type: none"> check for correct power on the PC/104-Plus (PCI) bus connector
	incorrect Setup	<ul style="list-style-type: none"> reboot and press Delete to run Setup
	defective or misconnected device on bus	<ul style="list-style-type: none"> check for misaligned bus connectors remove other cards from stack
	cable connected backwards	<ul style="list-style-type: none"> verify all cables are connected correctly
	SSD installed backwards	<ul style="list-style-type: none"> check for an SSD memory installed in socket backwards
cpuModule keeps rebooting	problem with power supply	<ul style="list-style-type: none"> check for correct power on the PC/104-Plus (PCI) bus connector
	reset switch is on	<ul style="list-style-type: none"> check that the reset button is not pushed in
	watchdog timer is not being serviced quickly enough	<ul style="list-style-type: none"> verify that the watchdog timer is being refreshed before it times out
cpuModule will not boot from particular drive or device	device not bootable	<ul style="list-style-type: none"> use sys command on drive or reformat the device using the /s switch
	device not formatted	<ul style="list-style-type: none"> format drive using /s switch
	power not connected to boot drive	<ul style="list-style-type: none"> connect power cable to floppy or hard drive
erratic operation	excessive bus loading	<ul style="list-style-type: none"> reduce number of modules in stack remove termination components from bus signals remove any power supply bus terminations
	power supply noise	<ul style="list-style-type: none"> examine power supply output with oscilloscope glitches below 4.75 VDC will trigger a reset add bypass caps
	power supply limiting	<ul style="list-style-type: none"> examine power supply output with oscilloscope check for voltage drop below 4.75 VDC when hard drive or floppy drive starts add bypass caps
	insufficient cabling through power connector	<ul style="list-style-type: none"> increase wire gauge to connector power through bus connectors
	temperature too high	<ul style="list-style-type: none"> add fan, processor heatsink, or other cooling device(s) See <i>Thermal Management</i> on page 72
	memory address conflict	<ul style="list-style-type: none"> check for two hardware devices (e.g. Ethernet, SSD, Arcnet, PCMCIA) trying to use the same memory address check for two software devices (e.g. EMM386, PCMCIA drivers, etc.) trying to use the same memory addresses check for hardware and software devices trying to use the same memory address check for an address range shadowed (see Advanced Setup screen) while in use by another hardware or software device
	I/O address conflict	<ul style="list-style-type: none"> check for another module trying to use I/O addresses reserved for the cpuModule between 010h and 01Fh check for two modules (e.g. dataModules, PCMCIA cards, Ethernet) trying to use the same I/O addresses

Table 64 Troubleshooting (cont'd)

Problem	Cause	Solution
keyboard does not work	keyboard interface damaged by misconnection	<ul style="list-style-type: none"> • check if keyboard LEDs light
	wrong keyboard type	<ul style="list-style-type: none"> • verify keyboard is an "AT" type or switch to "AT" mode
floppy drive light always on	cable misconnected	<ul style="list-style-type: none"> • check for floppy drive cable connected backwards
two hard drives will not work, but one does	both drives configured for master	<ul style="list-style-type: none"> • set one drive for master and the other for slave operation (consult drive documentation)
floppy does not work	"data error" due to drive upside down	<ul style="list-style-type: none"> • orient drive properly (upright or on side)
will not boot when video card is removed	illegal calls to video controller	<ul style="list-style-type: none"> • look for software trying to access nonexistent video controller for video, sound, or beep commands
abnormal video	flat panel is enabled	<ul style="list-style-type: none"> • disable the flat panel in the BIOS
can only use 640 x 480 resolution in Windows	flat panel is enabled	<ul style="list-style-type: none"> • disable the flat panel in the BIOS
	video drivers not installed	<ul style="list-style-type: none"> • install the video drivers
will not boot from PCMCIA hard drive	booting from PCMCIA is not supported	<ul style="list-style-type: none"> • boot from SSD, use autoexec.bat to load PCMCIA drivers, run application from PCMCIA card
COM port will not work in RS-422 or RS-485 modes	not configured for RS-422/485	<ul style="list-style-type: none"> • correctly configure serial port in Setup program
COM port will not transmit in RS-422 or RS-485 mode	not enabling transmitters	<ul style="list-style-type: none"> • control RTS* bit of Modem Control Register to enable transmitters; see Serial Port descriptions
date and time not saved when power is off	no backup battery	<ul style="list-style-type: none"> • connect a backup battery to the multi-function connector
screen flickers at high resolutions when processor is fully utilized	memory with ECC enabled requires additional system memory resources; the integrated graphics engine has less memory bandwidth for access to the graphics frame buffer	<ul style="list-style-type: none"> • disable ECC

Troubleshooting a PC/104-Plus System

If you have reviewed the preceding table and still cannot isolate the problem with your CMX158886 cpuModule, please try the following troubleshooting steps. Even if the resulting information does not help you find the problem, it will be very helpful if you need to contact technical support.

1. **Simplify the system.** Remove items one at a time and see if one particular item seems to cause the problem.
2. **Swap components.** Try replacing items in the system one-at-a-time with similar items.

How to Obtain Technical Support

If after following the above steps, you still cannot resolve a problem with your CMX158886 cpuModule, please gather the following information:

- cpuModule model, BIOS version, and serial number
- List of all boards in system
- List of settings from cpuModule Setup program
- Printout of autoexec.bat and config.sys files (if applicable)
- Description of problem
- Circumstances under which problem occurs

Then contact RTD Technical Support:

Phone: 814-234-8087

Fax: 814-234-5218

E-mail: techsupport@rtd.com

Appendix C IDAN™ Dimensions and Pinout

cpuModules, like all other RTD PC/PCI-104 modules, can be packaged in Intelligent Data Acquisition Node (IDAN) frames, which are milled aluminum frames with integrated heat sinks and heat pipes for fanless operation. RTD modules installed in IDAN frames are called building blocks. IDAN building blocks maintain the simple but rugged stacking concept of PC/104 and PC/104-Plus. Each RTD module is mounted in its own IDAN frame and all I/O connections are brought to the walls of each frame using standard PC connectors. No connections are made from module to module internal to the system other than through the PC/104 and PC/104-Plus bus, enabling quick interchangeability and system expansion without hours of rewiring and board redesign.

The CMX158886 cpuModule can also be purchased as part of a custom-built RTD HiDAN™ or HiDANplus™ High Reliability Intelligent Data Acquisition Node. This appendix provides the dimensions and pinouts of the CMX158886 installed in an IDAN frame. Contact RTD for more information on high reliability IDAN, HiDAN, and HiDANplus PC/PCI-104 systems.



IDAN—Adhering to the PC/104 stacking concept, IDAN allows you to build a customized system with any combination of RTD modules.

IDAN Heat Pipes—Advanced heat pipe technology maximizes heat transfer to heat sink fins.



HiDANplus—Integrating the modularity of IDAN with the ruggedization of HiDAN, HiDANplus enables connectors on all system frames, with signals running between frames through a dedicated stack-through raceway.

IDAN Dimensions and Connectors

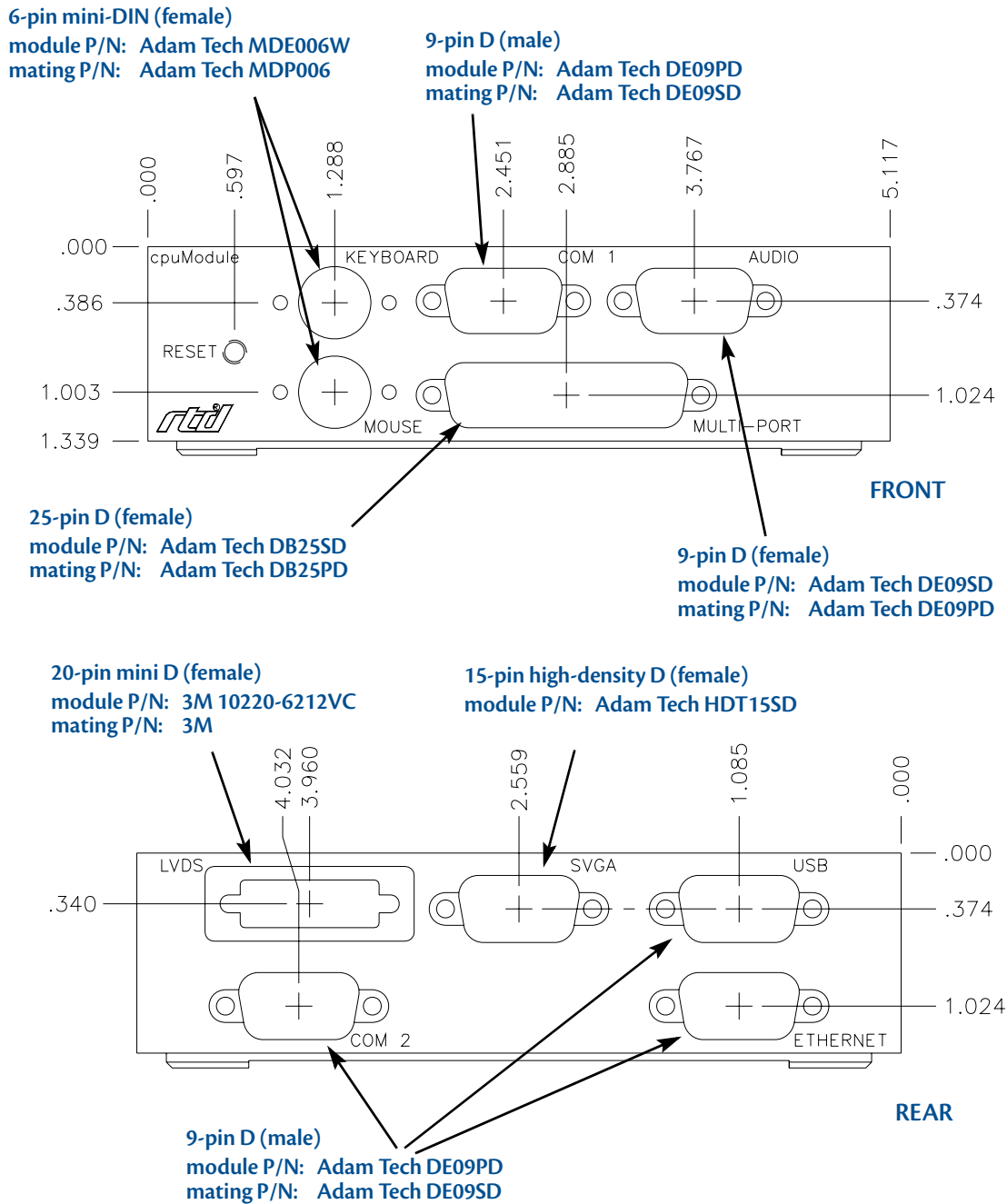

Figure 9 IDAN-CMX15886 Connectors¹

1. Heatsink fins (not shown in Figure 9) extend 0.75 inches from the sides of the IDAN frame.

External I/O Connections

Table 65 PS/2 Mouse — 6-Pin mini-DIN Connector (female)

IDAN Pin #	Signal	Function
1	MDAT	Mouse Data
2	Reserved	—
3	GND	Ground
4	+5 V	+5 Volts
5	MCLK	Mouse Clock
6	Reserved	—

Table 66 Keyboard — 6-Pin mini-DIN Connector (female)

IDAN Pin #	Signal	Function
1	KDAT	Keyboard Data
2	Reserved	—
3	GND	Ground
4	+5 V	+5 V
5	KCLK	Keyboard Clock
6	Reserved	—

Table 67 COM1/COM2 (RS-232) — 9-Pin D Connector (male)

IDAN Pin #	Signal	Function	Mode
1	DCD	Data Carrier Detect	Input
2	RXD	Receive Data	Input
3	TXD	Transmit Data	Output
4	DTR	Data Terminal Ready	Output
5	GND	Ground	—
6	DSR	Data Set Ready	Input
7	RTS	Request To Send	Output
8	CTS	Clear To Send	Input
9	RI	Ring Indicator	Input

Table 68 COM1/COM2 (RS-422/485) — 9-Pin D Connector (male)

IDAN Pin #	Signal	Function	Mode
1	Reserved	—	—
2	RXD-	Receive Data -	Input
3	TXD-	Transmit Data -	Output
4	Reserved	—	—
5	GND	Ground	—
6	Reserved	—	—
7	TXD+	Transmit Data +	Output
8	RXD+	Receive Data +	Input
9	Reserved	—	—

Table 69 multiPort — 25-Pin D Connector (female)

IDAN Pin #	aDIO Port	Parallel Port	Floppy Port	CPU Pin #
1	strobe 0	STB	—	1
2	P1-0	PD0	INDEX#	3
3	P1-1	PD1	TRK0#	5
4	P1-2	PD2	WRTPRT#	7
5	P1-3	PD3	RDATA#	9
6	P1-4	PD4	DSKCHG	11
7	P1-5	PD5	—	13
8	P1-6	PD6	—	15
9	P1-7	PD7	—	17
10	P0-0	ACK	DS1#	19
11	P0-1	BSY	MTR#	21
12	P0-2	PE	WDATA#	23
13	P0-3	SLCT	WGATE#	25
14	P0-4	AFD	DR0#	2
15	P0-5	ERR	HDSEL#	4
16	P0-6	INIT	DIR#	6
17	P0-7	SLIN	STEP#	8
18	strobe 1	GND	GND	10
19	GND	GND	GND	12
20	GND	GND	GND	14
21	GND	GND	GND	16
22	GND	GND	GND	18
23	GND	GND	GND	20
24	GND	GND	GND	22
25	GND	GND	GND	24

Table 70 Panel — 20-Pin mini D Connector (female)

IDAN Pin #	Signal Name	CPU Pin #
1	LVDS_YAP0	1
2	LVDS_DDCPCLK	3
3	LVDS_YAP1	5
4	LVDS_DDCPDATA	7
5	LVDS_YAP2	9
6	GND	11
7	LVDS_CLKAP	13
8	LVDS_YAP3	15
9	GND	17
10	FP_BKLT	19
11	LVDS_YAM0	2
12	GND	4
13	LVDS_YAM1	6
14	GND	8
15	LVDS_YAM2	10
16	GND	12
17	LVDS_CLKAM	14
18	LVDS_YAM3	16
19	FP_VCC	18
20	LVDS_BKLTCTL	20

Table 71 SVGA — 15-Pin High Density D Connector (female)

IDAN Pin #	Signal	Function	CPU Pin #
1	Red	Red Analog Output	4
2	Green	Green Analog Output	6
3	Blue	Blue Analog Output	8
4	Reserved	Reserved	—
5	GND	Ground	9
6	GND	Ground	9
7	GND	Ground	9
8	GND	Ground	10
9	+5 V	+ 5 Volts	7
10	GND	Ground	10
11	Reserved	Reserved	—
12	DDC Data	Monitor data	5
13	HSYNC	Horizontal Sync	2
14	VSYNC	Vertical Sync	1
15	DDC CLK	Monitor Clock	3

Table 72 USB — 9-Pin D Connector (male)

IDAN Pin #	Signal	Function	Mode
1	VCC1	+5 V to USB1	output
2	Data USB1-	USB1 Data-	input/output
3	Data USB1+	USB1 Data+	input/output
4	GND	Ground	—
5	GND	Ground	—
6	VCC2	+5 V to USB2	output
7	Data USB2-	USB2 Data-	input/output
8	Data USB2+	USB2 Data+	input/output
9	GND	Ground	—

Table 73 Ethernet — 9-Pin D Connector (female)

IDAN Pin #	10Base-T Adapter Pin #	Signal	CPU Pin #
1	1	Receive +	1
2	2	Reserved	3
3	3	Transmit +	5
4	4	Reserved	7
5	5	Ground	9
6	6	Receive -	2
7	7	Reserved	4
8	8	Transmit -	6
9	—	Reserved	8

Table 74 Audio — 9-Pin D Connector (female)

IDAN Pin #	Signal	CPU Pin #
5	MIC_VREF	1
4	GND	3
3	LINE_IN_GND	5
2	GND	7
2	GND	9
9	MIC_IN	2
8	LINE_IN_LEFT	4
7	LINE_IN_RIGHT	6
6	OUTPUT_LEFT	8
1	OUTPUT_RIGHT	10

IDAN Dimensions and Connectors (BRG version only)

This section describes some of the primary physical differences between the standard dual height IDAN cpuModule and the IDAN cpuModule that comes with a PCI to ISA bridge module ("BRG" version).

6-pin mini-DIN (female)
 module P/N: Adam Tech MDE006W
 mating P/N: Adam Tech MDP006

9-pin D (male)
 module P/N: Adam Tech DE09PD
 mating P/N: Adam Tech DE09SD

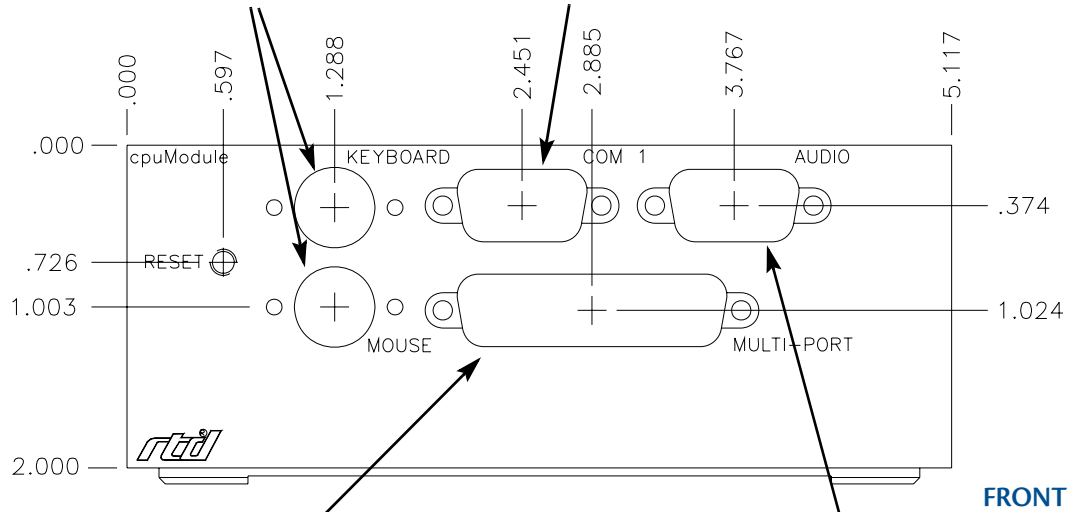

25-pin D (female)
 module P/N: Adam Tech DB25SD
 mating P/N: Adam Tech DB25PD

9-pin D (female)
 module P/N: Adam Tech DE09SD
 mating P/N: Adam Tech DE09PD

20-pin mini D (female)
 module P/N: 3M 10220-6212VC
 mating P/N: 3M 10120-3000VE

15-pin high-density D (female)
 module P/N: Adam Tech HDT15SD
 mating P/N: Adam Tech HDT15PD

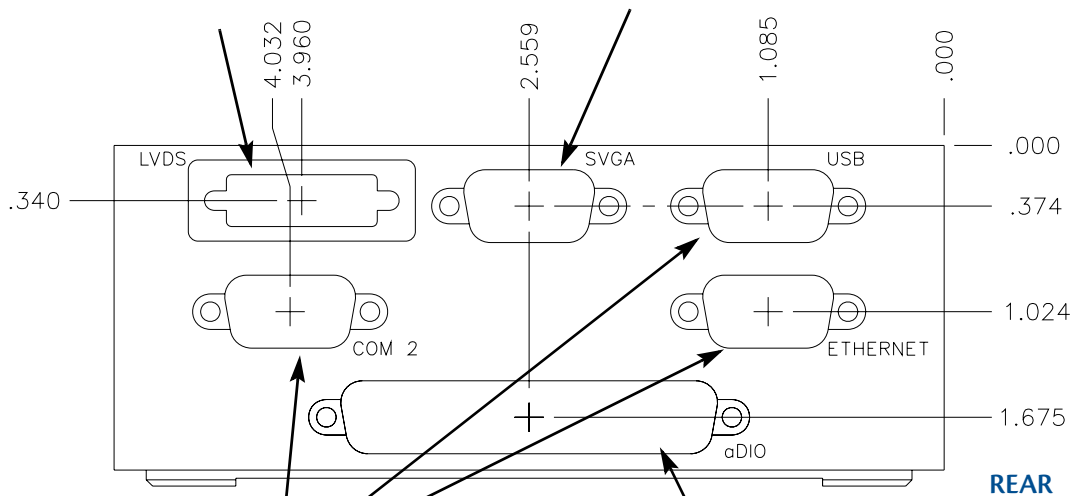

9-pin D (male)
 module P/N: Adam Tech DE09PD
 mating P/N: Adam Tech DE09SD

37-pin high-density D (female)
 module P/N: Adam Tech HDT37SD
 mating P/N: Adam Tech HDT37PD

Figure 10 IDAN-CMX158886-BRG Connectors¹

1. Heatsink fins (not shown in Figure 10) extend 0.75 inches from the sides of the IDAN frame.

External I/O Connections (BRG version only)

An additional connector is added to the IDAN PCI to ISA bridge configuration to allow additional digital I/O signals to be accessible from outside the IDAN frame. The pinout for this connection is shown in the table below.

Table 75 aDIO — 37-Pin D Connector (female)

BRG Pin #	Function	IDAN Pin #
1	P1-0	1
2	GND	20
3	P1-1	2
4	GND	21
5	P1-2	3
6	GND	22
7	P1-3	4
8	GND	23
9	P1-4	5
10	GND	24
11	P1-5	6
12	GND	25
13	P1-6	7
14	GND	26
15	P1-7	8
16	GND	27
17	P1-Strobe	9
18	GND	28
19	P2-0	10
20	GND	29
21	P2-1	11
22	GND	30
23	P2-2	12
24	GND	31
25	P2-3	13
26	GND	32
27	P2-4	14
28	GND	33
29	P2-5	15
30	GND	34
31	P2-6	16
32	GND	35
33	P2-7	17

BRG Pin #	Function	IDAN Pin #
34	GND	36
35	P2-Strobe	18
36	GND	37
37	+5 Volts Fused @ 2A	19
38	GND	N/C
39	GND	N/C
40	GND	N/C



Appendix D Additional Information

Application Notes

RTD offers many application notes that provide assistance with the unique feature set of the CMX158886 cpuModule. For the latest application notes, refer to the RTD website.

Drivers and Example Programs

To obtain the latest versions of drivers and example programs for this cpuModule, refer to the RTD website.

Interrupt Programming

For more information about interrupts and writing interrupt service routines, refer to the following book:

Interrupt-Driven PC System Design
by Joseph McGivern
ISBN: 0929392507

Serial Port Programming

For more information about programming serial port UARTs, consult the following book:

Serial Communications Developer's Guide
by Mark Nielson
ISBN: 0764545701

PC/104 and PC/104-Plus Specifications

A copy of the latest PC/104 and PC/104-Plus specifications can be found on the webpage for the PC/104 Embedded Consortium:

<http://www.pc104.org>



Appendix E Limited Warranty

RTD Embedded Technologies, Inc. warrants the hardware and software products it manufactures and produces to be free from defects in materials and workmanship for one year following the date of shipment from RTD Embedded Technologies, Inc. This warranty is limited to the original purchaser of product and is not transferable.

During the one year warranty period, RTD Embedded Technologies will repair or replace, at its option, any defective products or parts at no additional charge, provided that the product is returned, shipping prepaid, to RTD Embedded Technologies. All replaced parts and products become the property of RTD Embedded Technologies. Before returning any product for repair, customers are required to contact the factory for a Return Material Authorization number.

This limited warranty does not extend to any products which have been damaged as a result of accident, misuse, abuse (such as: use of incorrect input voltages, improper or insufficient ventilation, failure to follow the operating instructions that are provided by RTD Embedded Technologies, "acts of god" or other contingencies beyond the control of RTD Embedded Technologies), or as a result of service or modification by anyone other than RTD Embedded Technologies. Except as expressly set forth above, no other warranties are expressed or implied, including, but not limited to, any implied warranties of merchantability and fitness for a particular purpose, and RTD Embedded Technologies expressly disclaims all warranties not stated herein. All implied warranties, including implied warranties for merchantability and fitness for a particular purpose, are limited to the duration of this warranty. In the event the product is not free from defects as warranted above, the purchaser's sole remedy shall be repair or replacement as provided above. Under no circumstances will RTD Embedded Technologies be liable to the purchaser or any user for any damages, including any incidental or consequential damages, expenses, lost profits, lost savings, or other damages arising out of the use or inability to use the product.

Some states do not allow the exclusion or limitation of incidental or consequential damages for consumer products, and some states do not allow limitations on how long an implied warranty lasts, so the above limitations or exclusions may not apply to you.

This warranty gives you specific legal rights, and you may also have other rights which vary from state to state.

RTD Embedded Technologies, Inc.
103 Innovation Blvd.
State College PA 16803-0906
USA
Website: www.rtd.com

Free Manuals Download Website

<http://myh66.com>

<http://usermanuals.us>

<http://www.somanuals.com>

<http://www.4manuals.cc>

<http://www.manual-lib.com>

<http://www.404manual.com>

<http://www.luxmanual.com>

<http://aubethermostatmanual.com>

Golf course search by state

<http://golfingnear.com>

Email search by domain

<http://emailbydomain.com>

Auto manuals search

<http://auto.somanuals.com>

TV manuals search

<http://tv.somanuals.com>