

# Linux Performance and Tuning Guidelines

Operating system tuning methods

Performance monitoring tools

Performance analysis

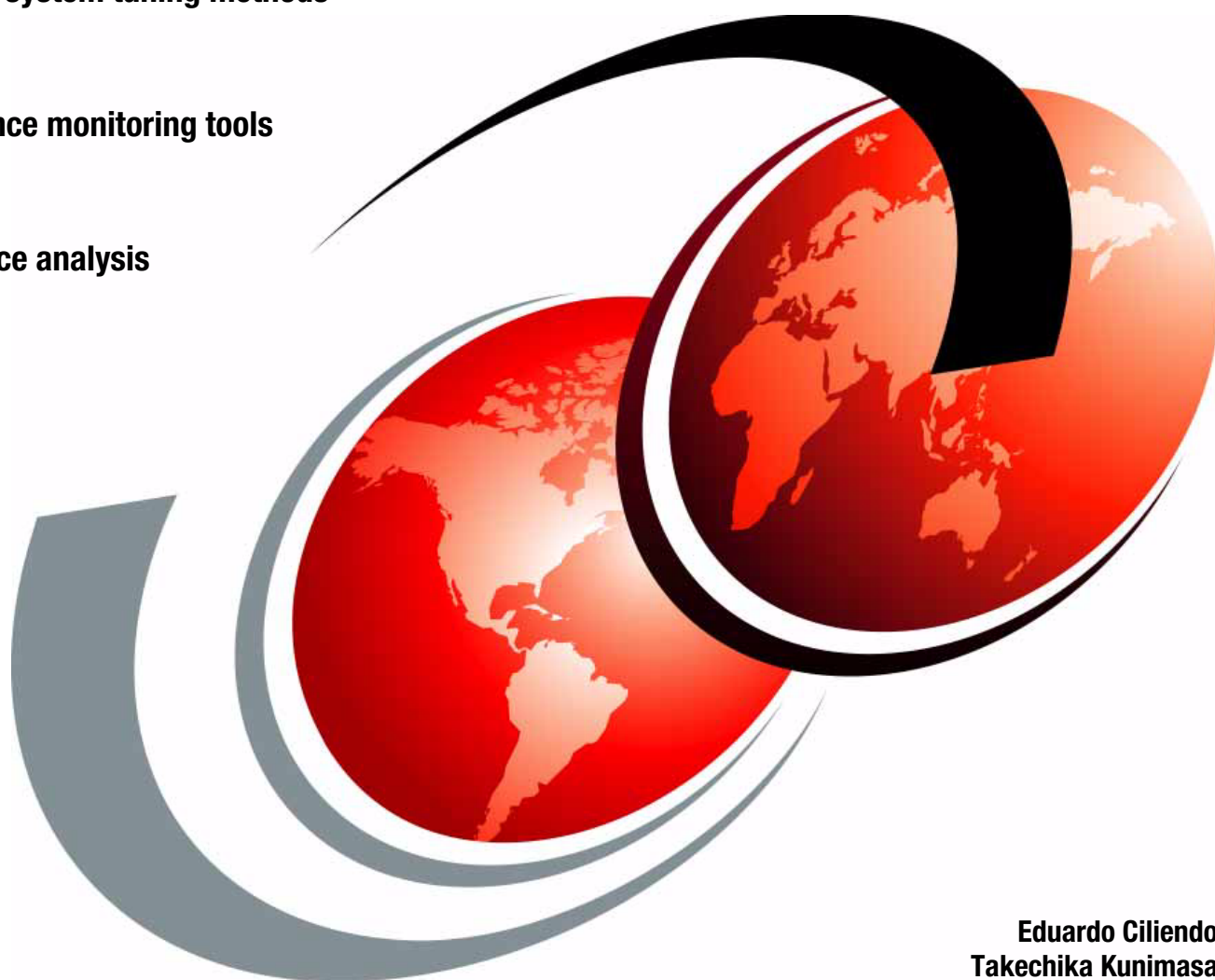

Eduardo Ciliendo  
Takechika Kunimasa





International Technical Support Organization

**Linux Performance and Tuning Guidelines**

April 2007

**Note:** Before using this information and the product it supports, read the information in “Notices” on page vii.

**First Edition (April 2007)**

This edition applies to kernel 2.6 Linux distributions.

This document created or updated on May 4, 2007.

© Copyright International Business Machines Corporation 2007. All rights reserved.

Note to U.S. Government Users Restricted Rights -- Use, duplication or disclosure restricted by GSA ADP Schedule Contract with IBM Corp.

# Contents

<b>Notices</b> .....	vii
Trademarks .....	viii
<b>Preface</b> .....	ix
How this Redpaper is structured .....	ix
The team that wrote this Redpaper .....	x
Become a published author .....	xi
Comments welcome .....	xi
<b>Chapter 1. Understanding the Linux operating system</b> .....	1
1.1 Linux process management .....	3
1.1.1 What is a process? .....	3
1.1.2 Lifecycle of a process .....	4
1.1.3 Thread .....	4
1.1.4 Process priority and nice level .....	5
1.1.5 Context switching .....	6
1.1.6 Interrupt handling .....	6
1.1.7 Process state .....	7
1.1.8 Process memory segments .....	8
1.1.9 Linux CPU scheduler .....	9
1.2 Linux memory architecture .....	11
1.2.1 Physical and virtual memory .....	11
1.2.2 Virtual memory manager .....	13
1.3 Linux file systems .....	15
1.3.1 Virtual file system .....	15
1.3.2 Journaling .....	16
1.3.3 Ext2 .....	17
1.3.4 Ext3 .....	18
1.3.5 ReiserFS .....	19
1.3.6 Journal File System .....	19
1.3.7 XFS .....	19
1.4 Disk I/O subsystem .....	19
1.4.1 I/O subsystem architecture .....	20
1.4.2 Cache .....	21
1.4.3 Block layer .....	23
1.4.4 I/O device driver .....	24
1.4.5 RAID and Storage system .....	25
1.5 Network subsystem .....	26
1.5.1 Networking implementation .....	26
1.5.2 TCP/IP .....	30
1.5.3 Offload .....	33
1.5.4 Bonding module .....	34
1.6 Understanding Linux performance metrics .....	34
1.6.1 Processor metrics .....	34
1.6.2 Memory metrics .....	35
1.6.3 Network interface metrics .....	36
1.6.4 Block device metrics .....	36
<b>Chapter 2. Monitoring and benchmark tools</b> .....	39

2.1	Introduction	40
2.2	Overview of tool function	40
2.3	Monitoring tools	41
2.3.1	top	41
2.3.2	vmstat	42
2.3.3	uptime	43
2.3.4	ps and pstree	44
2.3.5	free	46
2.3.6	iostat	48
2.3.7	sar	50
2.3.8	mpstat	51
2.3.9	numastat	52
2.3.10	pmap	52
2.3.11	netstat	53
2.3.12	iptraf	54
2.3.13	tcpdump / ethereal	55
2.3.14	nmon	58
2.3.15	strace	59
2.3.16	Proc file system	60
2.3.17	KDE System Guard	62
2.3.18	Gnome System Monitor	67
2.3.19	Capacity Manager	67
2.4	Benchmark tools	70
2.4.1	LMbench	71
2.4.2	IOzone	72
2.4.3	netperf	73
2.4.4	Other useful tools	76
	<b>Chapter 3. Analyzing performance bottlenecks</b>	<b>77</b>
3.1	Identifying bottlenecks	78
3.1.1	Gathering information	78
3.1.2	Analyzing the server's performance	80
3.2	CPU bottlenecks	81
3.2.1	Finding CPU bottlenecks	81
3.2.2	SMP	81
3.2.3	Performance tuning options	82
3.3	Memory bottlenecks	82
3.3.1	Finding memory bottlenecks	82
3.3.2	Performance tuning options	84
3.4	Disk bottlenecks	84
3.4.1	Finding disk bottlenecks	84
3.4.2	Performance tuning options	87
3.5	Network bottlenecks	87
3.5.1	Finding network bottlenecks	87
3.5.2	Performance tuning options	89
	<b>Chapter 4. Tuning the operating system</b>	<b>91</b>
4.1	Tuning principals	92
4.1.1	Change management	92
4.2	Installation considerations	92
4.2.1	Installation	92
4.2.2	Check the current configuration	94
4.2.3	Minimize resource use	97

4.2.4 SELinux . . . . .	102
4.2.5 Compiling the kernel . . . . .	104
4.3 Changing kernel parameters . . . . .	104
4.3.1 Where the parameters are stored . . . . .	107
4.3.2 Using the sysctl command . . . . .	108
4.4 Tuning the processor subsystem . . . . .	108
4.4.1 Tuning process priority . . . . .	109
4.4.2 CPU affinity for interrupt handling . . . . .	109
4.4.3 Considerations for NUMA systems . . . . .	109
4.5 Tuning the vm subsystem . . . . .	110
4.5.1 Setting kernel swap and pflush behavior . . . . .	110
4.5.2 Swap partition . . . . .	111
4.5.3 HugeTLBfs . . . . .	112
4.6 Tuning the disk subsystem . . . . .	113
4.6.1 Hardware considerations before installing Linux . . . . .	114
4.6.2 I/O elevator tuning and selection . . . . .	116
4.6.3 File system selection and tuning . . . . .	121
4.7 Tuning the network subsystem . . . . .	125
4.7.1 Considerations of traffic characteristics . . . . .	125
4.7.2 Speed and duplexing . . . . .	126
4.7.3 MTU size . . . . .	127
4.7.4 Increasing network buffers . . . . .	127
4.7.5 Additional TCP/IP tuning . . . . .	129
4.7.6 Performance impact of Netfilter . . . . .	133
4.7.7 Offload configuration . . . . .	134
4.7.8 Increasing the packet queues . . . . .	136
4.7.9 Increasing the transmit queue length . . . . .	136
4.7.10 Decreasing interrupts . . . . .	136
<b>Appendix A. Testing configurations . . . . .</b>	<b>139</b>
Hardware and software configurations . . . . .	140
Linux installed on guest IBM z/VM systems . . . . .	140
Linux installed on IBM System x servers . . . . .	140
<b>Abbreviations and acronyms . . . . .</b>	<b>143</b>
<b>Related publications . . . . .</b>	<b>145</b>
IBM Redbooks . . . . .	145
Other publications . . . . .	145
Online resources . . . . .	145
How to get IBM Redbooks . . . . .	147
Help from IBM . . . . .	147
<b>Index . . . . .</b>	<b>149</b>





# Notices

This information was developed for products and services offered in the U.S.A.

IBM may not offer the products, services, or features discussed in this document in other countries. Consult your local IBM representative for information on the products and services currently available in your area. Any reference to an IBM product, program, or service is not intended to state or imply that only that IBM product, program, or service may be used. Any functionally equivalent product, program, or service that does not infringe any IBM intellectual property right may be used instead. However, it is the user's responsibility to evaluate and verify the operation of any non-IBM product, program, or service.

IBM may have patents or pending patent applications covering subject matter described in this document. The furnishing of this document does not give you any license to these patents. You can send license inquiries, in writing, to:

*IBM Director of Licensing, IBM Corporation, North Castle Drive, Armonk, NY 10504-1785 U.S.A.*

**The following paragraph does not apply to the United Kingdom or any other country where such provisions are inconsistent with local law:** INTERNATIONAL BUSINESS MACHINES CORPORATION PROVIDES THIS PUBLICATION "AS IS" WITHOUT WARRANTY OF ANY KIND, EITHER EXPRESS OR IMPLIED, INCLUDING, BUT NOT LIMITED TO, THE IMPLIED WARRANTIES OF NON-INFRINGEMENT, MERCHANTABILITY OR FITNESS FOR A PARTICULAR PURPOSE. Some states do not allow disclaimer of express or implied warranties in certain transactions, therefore, this statement may not apply to you.

This information could include technical inaccuracies or typographical errors. Changes are periodically made to the information herein; these changes will be incorporated in new editions of the publication. IBM may make improvements and/or changes in the product(s) and/or the program(s) described in this publication at any time without notice.

Any references in this information to non-IBM Web sites are provided for convenience only and do not in any manner serve as an endorsement of those Web sites. The materials at those Web sites are not part of the materials for this IBM product and use of those Web sites is at your own risk.

IBM may use or distribute any of the information you supply in any way it believes appropriate without incurring any obligation to you.

Information concerning non-IBM products was obtained from the suppliers of those products, their published announcements or other publicly available sources. IBM has not tested those products and cannot confirm the accuracy of performance, compatibility or any other claims related to non-IBM products. Questions on the capabilities of non-IBM products should be addressed to the suppliers of those products.

This information contains examples of data and reports used in daily business operations. To illustrate them as completely as possible, the examples include the names of individuals, companies, brands, and products. All of these names are fictitious and any similarity to the names and addresses used by an actual business enterprise is entirely coincidental.

## COPYRIGHT LICENSE:

This information contains sample application programs in source language, which illustrate programming techniques on various operating platforms. You may copy, modify, and distribute these sample programs in any form without payment to IBM, for the purposes of developing, using, marketing or distributing application programs conforming to the application programming interface for the operating platform for which the sample programs are written. These examples have not been thoroughly tested under all conditions. IBM, therefore, cannot guarantee or imply reliability, serviceability, or function of these programs.

## Trademarks

The following terms are trademarks of the International Business Machines Corporation in the United States, other countries, or both:

Redbooks (logo) ®  
eServer™  
xSeries®  
z/OS®  
AIX®  
DB2®

DS8000™  
IBM®  
POWER™  
Redbooks®  
ServeRAID™  
System i™

System p™  
System x™  
System z™  
System Storage™  
TotalStorage®

The following terms are trademarks of other companies:

Java, JDBC, Solaris, and all Java-based trademarks are trademarks of Sun Microsystems, Inc. in the United States, other countries, or both.

Excel, Microsoft, Windows, and the Windows logo are trademarks of Microsoft Corporation in the United States, other countries, or both.

Intel, Itanium, Intel logo, Intel Inside logo, and Intel Centrino logo are trademarks or registered trademarks of Intel Corporation or its subsidiaries in the United States, other countries, or both.

UNIX is a registered trademark of The Open Group in the United States and other countries.

Linux is a trademark of Linus Torvalds in the United States, other countries, or both.

Other company, product, or service names may be trademarks or service marks of others.

# Preface

Linux® is an open source operating system developed by people all over the world. The source code is freely available and can be used under the GNU General Public License. The operating system is made available to users in the form of distributions from companies such as Red Hat and Novell. Some desktop Linux distributions can be downloaded at no charge from the Web, but the server versions typically must be purchased.

Over the past few years, Linux has made its way into the data centers of many corporations all over the globe. The Linux operating system has become accepted by both the scientific and enterprise user population. Today, Linux is by far the most versatile operating system. You can find Linux on embedded devices such as firewalls and cell phones and mainframes. Naturally, performance of the Linux operating system has become a hot topic for both scientific and enterprise users. However, calculating a global weather forecast and hosting a database impose different requirements on the operating system. Linux has to accommodate all possible usage scenarios with the most optimal performance. The consequence of this challenge is that most Linux distributions contain general tuning parameters to accommodate all users.

IBM® has embraced Linux, and it is recognized as an operating system suitable for enterprise-level applications running on IBM systems. Most enterprise applications are now available on Linux, including file and print servers, database servers, Web servers, and collaboration and mail servers.

With use of Linux in an enterprise-class server comes the need to monitor performance and, when necessary, tune the server to remove bottlenecks that affect users. This IBM Redpaper describes the methods you can use to tune Linux, tools that you can use to monitor and analyze server performance, and key tuning parameters for specific server applications. The purpose of this redpaper is to understand, analyze, and tune the Linux operating system to yield superior performance for any type of application you plan to run on these systems.

The tuning parameters, benchmark results, and monitoring tools used in our test environment were executed on Red Hat and Novell SUSE Linux kernel 2.6 systems running on IBM System x servers and IBM System z servers. However, the information in this redpaper should be helpful for all Linux hardware platforms.

## How this Redpaper is structured

To help readers new to Linux or performance tuning get a fast start on the topic, we have structured this book the following way:

- ▶ Understanding the Linux operating system

This chapter introduces the factors that influence systems performance and the way the Linux operating system manages system resources. The reader is introduced to several important performance metrics that are needed to quantify system performance.

- ▶ Monitoring Linux performance

The second chapter introduces the various utilities that are available for Linux to measure and analyze systems performance.

- ▶ Analyzing performance bottlenecks

This chapter introduces the process of identifying and analyzing bottlenecks in the system.

► Tuning the operating system

With the basic knowledge of the operating systems way of working and the skills in a variety of performance measurement utilities, the reader is now ready to go to work and explore the various performance tweaks available in the Linux operating system.

## The team that wrote this Redpaper

This Redpaper was produced by a team of specialists from around the world working at the International Technical Support Organization, Raleigh Center.

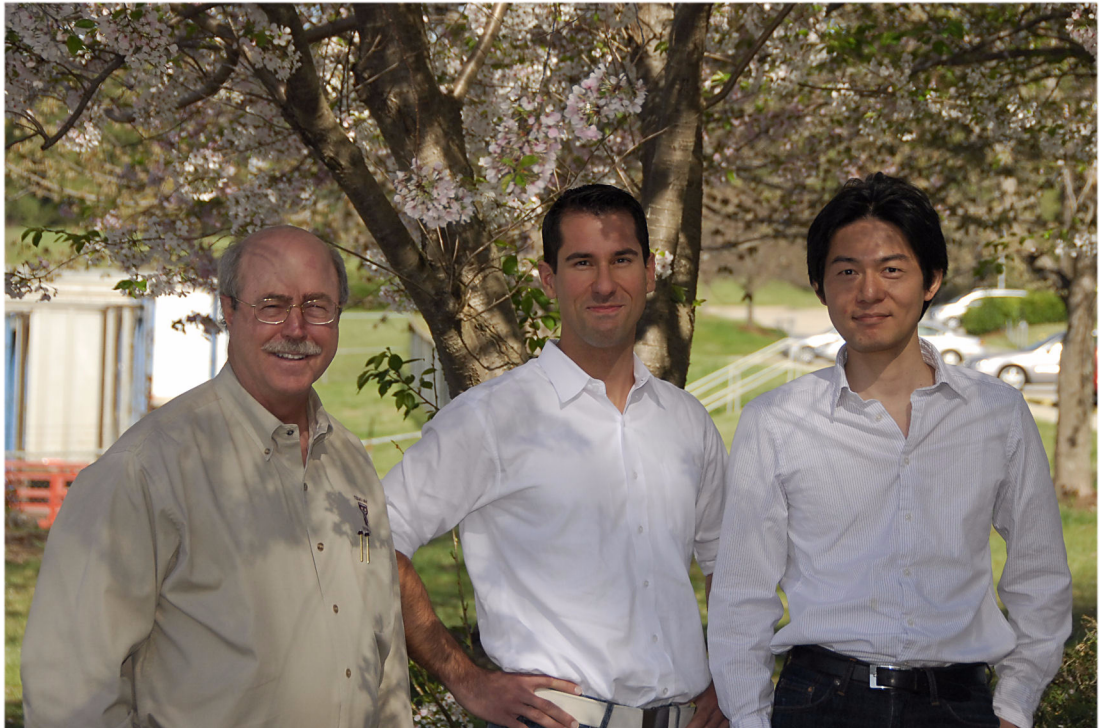

*The team: Byron, Eduardo, Takechika*

**Eduardo Ciliendo** is an Advisory IT Specialist working as a performance specialist on IBM Mainframe Systems in IBM Switzerland. He has over than 10 years of experience in computer sciences. Eddy studied Computer and Business Sciences at the University of Zurich and holds a post-diploma in Japanology. Eddy is a member of the zChampion team and holds several IT certifications including the RHCE title. As a Systems Engineer for IBM System z™, he works on capacity planning and systems performance for z/OS® and Linux for System z. Eddy has made several publications on systems performance and Linux.

**Takechika Kunimasa** is an Associate IT Architect in IBM Global Service in Japan. He studied Electrical and Electronics engineering at Chiba University. He has more than 10 years of experience in IT industry. He worked as network engineer for 5 years and he has been working for Linux technical support. His areas of expertise include Linux on System x™, System p™ and System z, high availability system, networking and infrastructure architecture design. He is Cisco Certified Network Professional and Red Hat Certified Engineer.

**Byron Braswell** is a Networking Professional at the International Technical Support Organization, Raleigh Center. He received a B.S. degree in Physics and an M.S. degree in

Computer Sciences from Texas A&M University. He writes extensively in the areas of networking, application integration middleware, and personal computer software. Before joining the ITSO, Byron worked in IBM Learning Services Development in networking education development.

Thanks to the following people for their contributions to this project:

Margaret Ticknor  
Carolyn Briscoe  
International Technical Support Organization, Raleigh Center

Roy Costa  
Michael B Schwartz  
Frieder Hamm  
International Technical Support Organization, Poughkeepsie Center

Christian Ehrhardt  
Martin Kammerer  
IBM Böblingen, Germany

Erwan Auffret  
IBM France

## Become a published author

Join us for a two- to six-week residency program! Help write an IBM Redbook dealing with specific products or solutions, while getting hands-on experience with leading-edge technologies. You will have the opportunity to team with IBM technical professionals, Business Partners, and Clients.

Your efforts will help increase product acceptance and customer satisfaction. As a bonus, you'll develop a network of contacts in IBM development labs, and increase your productivity and marketability.

Find out more about the residency program, browse the residency index, and apply online at:

[ibm.com/redbooks/residencies.html](http://ibm.com/redbooks/residencies.html)

## Comments welcome

Your comments are important to us!

We want our papers to be as helpful as possible. Send us your comments about this Redpaper or other Redbooks® in one of the following ways:

- ▶ Use the online **Contact us** review redbook form found at:

[ibm.com/redbooks](http://ibm.com/redbooks)

- ▶ Send your comments in an e-mail to:

[redbooks@us.ibm.com](mailto:redbooks@us.ibm.com)

- ▶ Mail your comments to:

IBM Corporation, International Technical Support Organization  
Dept. HYTD Mail Station P099

2455 South Road  
Poughkeepsie, NY 12601-5400

# Understanding the Linux operating system

We begin this Redpaper with a quick overview of how the Linux operating system handles its tasks to complete interacting with its hardware resources. Performance tuning is a difficult task that requires in-depth understanding of the hardware, operating system, and application. If performance tuning were simple, the parameters we are about to explore would be hard-coded into the firmware or the operating system and you would not be reading these lines. However, as shown in the following figure, server performance is affected by multiple factors.

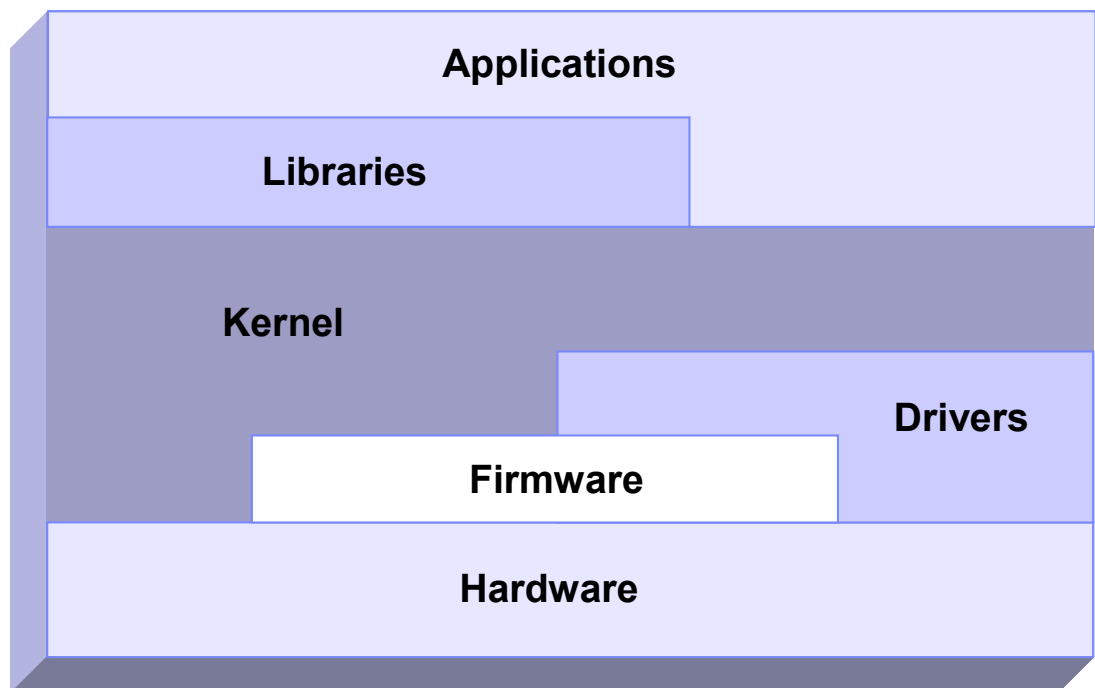

Figure 1-1 Schematic interaction of different performance components

We can tune the I/O subsystem for weeks in vain if the disk subsystem for a 20,000-user database server consists of a single IDE drive. Often a new driver or an update to the application will yield impressive performance gains. Even as we discuss specific details, never forget the complete picture of systems performance. Understanding the way an operating system manages the system resources aids us in understanding what subsystems we need to tune, given a specific application scenario.

The following sections provide a short introduction to the architecture of the Linux operating system. A complete analysis of the Linux kernel is beyond the scope of this Redpaper. The interested reader is pointed to the kernel documentation for a complete reference of the Linux kernel. Once you get a overall picture of the Linux kernel, you can go further depth into the detail more easily.

**Note:** This Redpaper focuses on the performance of the Linux operating system.

In this chapter we cover:

- ▶ 1.1, “Linux process management” on page 3
- ▶ 1.2, “Linux memory architecture” on page 11
- ▶ 1.3, “Linux file systems” on page 15
- ▶ 1.4, “Disk I/O subsystem” on page 19
- ▶ 1.5, “Network subsystem” on page 26
- ▶ 1.6, “Understanding Linux performance metrics” on page 34



## 1.1 Linux process management

Process management is one of the most important roles of any operating system. Effective process management enables an application to operate steadily and effectively.

Linux process management implementation is similar to UNIX® implementation. It includes process scheduling, interrupt handling, signaling, process prioritization, process switching, process state, process memory and so on.

In this section, we discuss the fundamentals of the Linux process management implementation. It helps to understand how the Linux kernel deals with processes that will have an effect on system performance.

### 1.1.1 What is a process?

A process is an instance of execution that runs on a processor. The process uses any resources Linux kernel can handle to complete its task.

All processes running on Linux operating system are managed by the `task_struct` structure, which is also called *process descriptor*. A process descriptor contains all the information necessary for a single process to run such as process identification, attributes of the process, resources which construct the process. If you know the structure of the process, you can understand what is important for process execution and performance. Figure 1-2 shows the outline of structures related to process information.

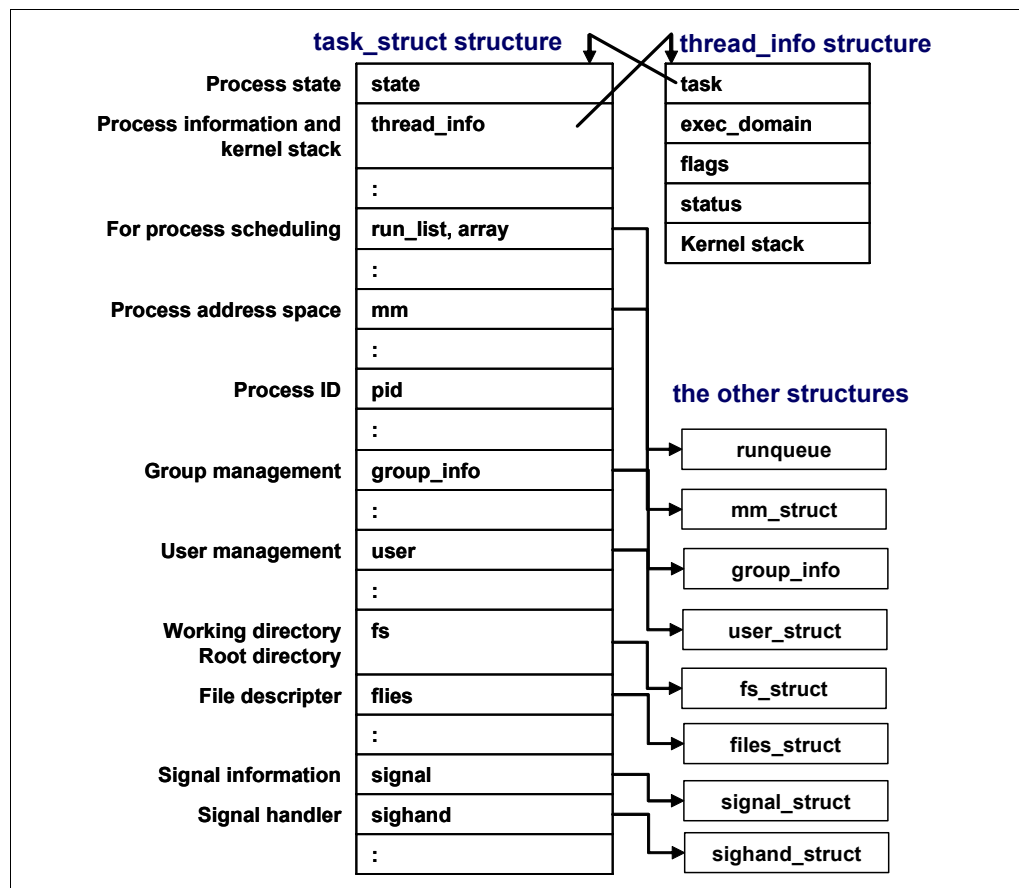

Figure 1-2 `task_struct` structure

## 1.1.2 Lifecycle of a process

Every process has its own lifecycle such as creation, execution, termination and removal. These phases will be repeated literally millions of times as long as the system is up and running. Therefore, the process lifecycle is a very important topic from the performance perspective.

Figure 1-3 shows typical lifecycle of processes.

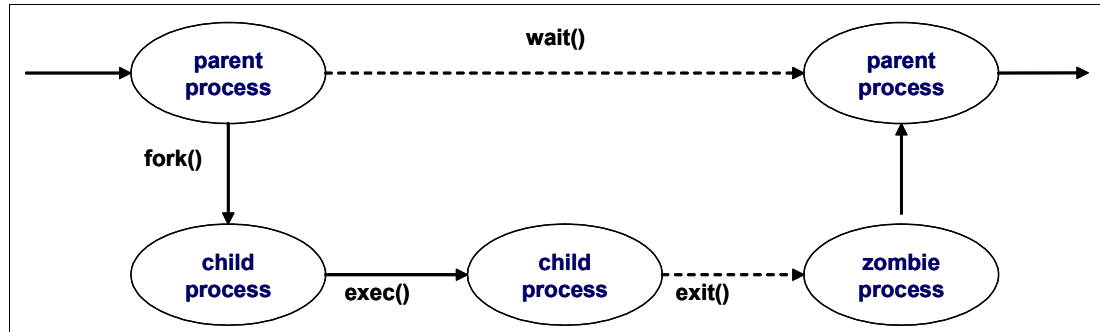

Figure 1-3 Lifecycle of typical processes

When a process creates new process, the creating process (parent process) issues a **fork()** system call. When a **fork()** system call is issued, it gets a process descriptor for the newly created process (child process) and sets a new process id. It then copies the values of the parent process's process descriptor to the child's. At this time the entire address space of the parent process is not copied; both processes share the same address space.

The **exec()** system call copies the new program to the address space of the child process. Because both processes share the same address space, writing new program data causes a page fault exception. At this point, the kernel assigns the new physical page to the child process.

This deferred operation is called the *Copy On Write*. The child process usually executes their own program rather than the same execution as its parent does. This operation is a reasonable choice to avoid unnecessary overhead because copying an entire address space is a very slow and inefficient operation which uses much processor time and resources.

When program execution has completed, the child process terminates with an **exit()** system call. The **exit()** system call releases most of the data structure of the process, and notifies the parent process of the termination sending a certain signal. At this time, the process is called a *zombie process* (refer to "Zombie processes" on page 8).

The child process will not be completely removed until the parent process knows of the termination of its child process by the **wait()** system call. As soon as the parent process is notified of the child process termination, it removes all the data structure of the child process and release the process descriptor.

## 1.1.3 Thread

A *thread* is an execution unit which is generated in a single process and runs in parallel with other threads in the same process. They can share the same resources such as memory, address space, open files and so on. They can access the same set of application data. A thread is also called *Light Weight Process* (LWP). Because they share resources, each thread should take care not to change their shared resources at the same time. The implementation of mutual exclusion, locking and serialization etc. are the user application's responsibility.

From the performance perspective, thread creation is less expensive than process creation because a thread does not need to copy resources on creation. On the other hand, processes and threads have similar characteristics in term of scheduling algorithm. The kernel deals with both of them in the similar manner.

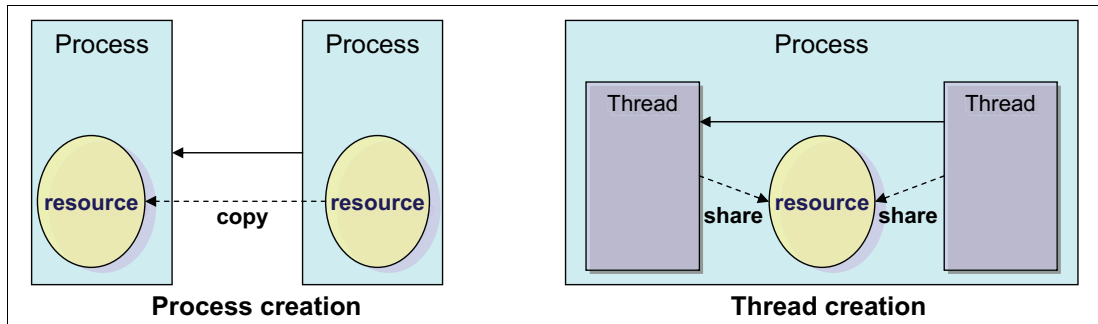

Figure 1-4 process and thread

In current Linux implementations, a thread is supported with the POSIX (Portable Operating System Interface for UNIX) compliant library (*pthread*). There are several thread implementations available in the Linux operating system. The following are the widely used.

- ▶ LinuxThreads

LinuxThreads have been the default thread implementation since Linux kernel 2.0 was available. The LinuxThread has some noncompliant implementations with the POSIX standard. NPTL is taking the place of LinuxThreads. The LinuxThreads will not be supported in future release of Enterprise Linux distributions.

- ▶ Native POSIX Thread Library (NPTL)

The NPTL was originally developed by Red Hat. NPTL is more compliant with POSIX standards. Taking advantage of enhancements in kernel 2.6 such as the new `clone()` system call, signal handling implementation etc., it has better performance and scalability than LinuxThreads.

There is some incompatibility with LinuxThreads. An application which has a dependence on LinuxThread may not work with the NPTL implementation.

- ▶ Next Generation POSIX Thread (NGPT)

NGPT is an IBM developed version of POSIX thread library. It is currently under maintenance operation and no further development is planned.

Using the `LD_ASSUME_KERNEL` environment variable, you can choose which threads library the application should use.

## 1.1.4 Process priority and nice level

*Process priority* is a number that determines the order in which the process is handled by the CPU and is determined by dynamic priority and static priority. A process which has higher process priority has higher chances of getting permission to run on processor.

The kernel dynamically adjusts dynamic priority up and down as needed using a heuristic algorithm based on process behaviors and characteristics. A user process can change the static priority indirectly through the use of the *nice* level of the process. A process which has higher static priority will have longer time slice (how long the process can run on processor).

Linux supports nice levels from 19 (lowest priority) to -20 (highest priority). The default value is 0. To change the nice level of a program to a negative number (which makes it higher priority), it is necessary to log on or `su` to root.

### 1.1.5 Context switching

During process execution, information of the running process is stored in registers on processor and its cache. The set of data that is loaded to the register for the executing process is called the *context*. To switch processes, the context of the running process is stored and the context of the next running process is restored to the register. The process descriptor and the area called kernel mode stack are used to store the context. This switching process is called *context switching*. Having too much context switching is undesirable because the processor has to flush its register and cache every time to make room for the new process. It may cause performance problems.

Figure 1-5 illustrates how the context switching works.

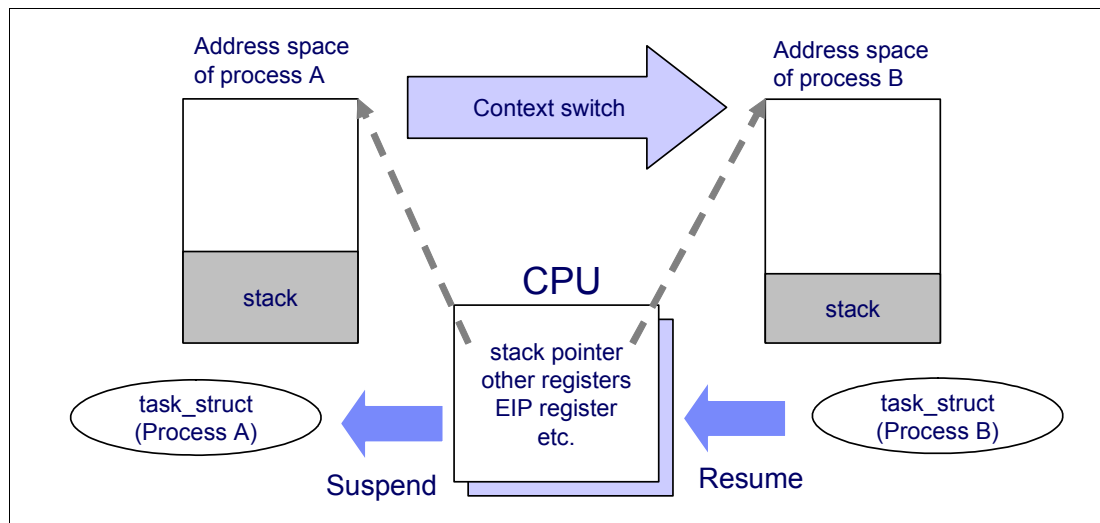

Figure 1-5 Context switching

### 1.1.6 Interrupt handling

Interrupt handling is one of the highest priority tasks. Interrupts are usually generated by I/O devices such as a network interface card, keyboard, disk controller, serial adapter, and so on. The interrupt handler notifies the Linux kernel of an event (such as keyboard input, ethernet frame arrival, and so on). It tells the kernel to interrupt process execution and perform interrupt handling as quickly as possible because some device requires quick responsiveness. This is critical for system stability. When an interrupt signal arrives to the kernel, the kernel must switch a currently execution process to new one to handle the interrupt. This means interrupts cause context switching, and therefore a significant amount of interrupts may cause performance degradation.

In Linux implementations, there are two types of interrupt. A *hard interrupt* is generated for devices which require responsiveness (disk I/O interrupt, network adapter interrupt, keyboard interrupt, mouse interrupt). A *soft interrupt* is used for tasks which processing can be deferred (TCP/IP operation, SCSI protocol operation etc.). You can see information related to hard interrupts at `/proc/interrupts`.

In a multi-processor environment, interrupts are handled by each processor. Binding interrupts to a single physical processor may improve system performance. For further details, refer to 4.4.2, “CPU affinity for interrupt handling”.

### 1.1.7 Process state

Every process has its own state to show what is currently happening in the process. Process state changes during process execution. Some of the possible states are as follows:

► **TASK\_RUNNING**

In this state, a process is running on a CPU or waiting to run in the queue (run queue).

► **TASK\_STOPPED**

A process suspended by certain signals (ex. **SIGINT**, **SIGSTOP**) is in this state. The process is waiting to be resumed by a signal such as **SIGCONT**.

► **TASK\_INTERRUPTIBLE**

In this state, the process is suspended and waits for a certain condition to be satisfied. If a process is in **TASK\_INTERRUPTIBLE** state and it receives a signal to stop, the process state is changed and operation will be interrupted. A typical example of a **TASK\_INTERRUPTIBLE** process is a process waiting for keyboard interrupt.

► **TASK\_UNINTERRUPTIBLE**

Similar to **TASK\_INTERRUPTIBLE**. While a process in **TASK\_INTERRUPTIBLE** state can be interrupted, sending a signal does nothing to the process in **TASK\_UNINTERRUPTIBLE** state. A typical example of **TASK\_UNINTERRUPTIBLE** process is a process waiting for disk I/O operation.

► **TASK\_ZOMBIE**

After a process exits with **exit()** system call, its parent should know of the termination. In **TASK\_ZOMBIE** state, a process is waiting for its parent to be notified to release all the data structure.

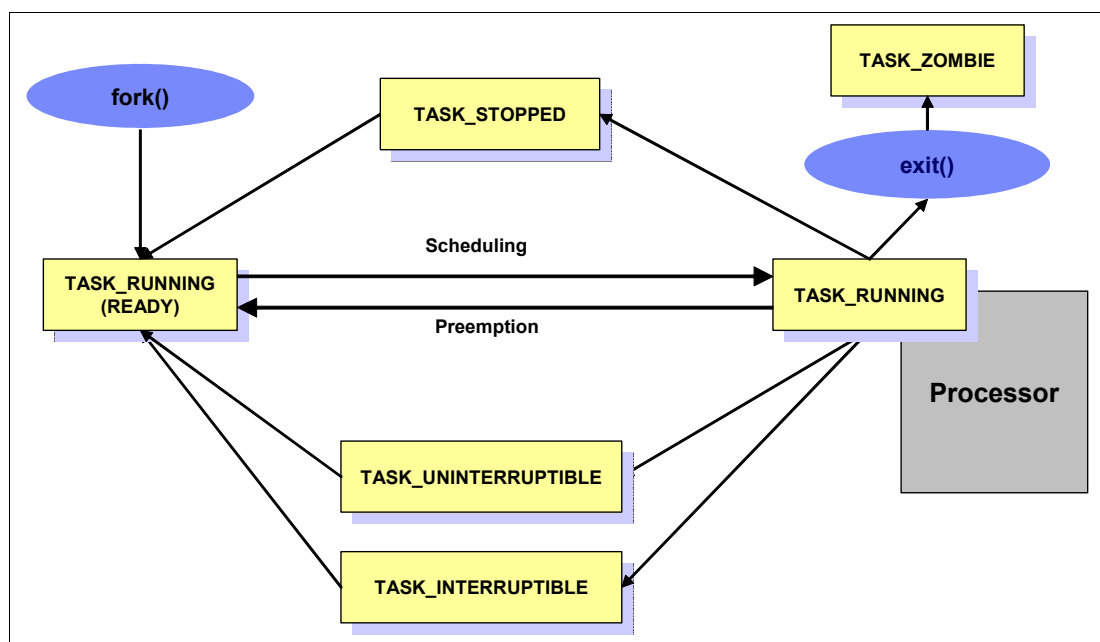

Figure 1-6 Process state

### ***Zombie processes***

When a process has already terminated, having received a signal to do so, it normally takes some time to finish all tasks (such as closing open files) before ending itself. In that normally very short time frame, the process is a *zombie*.

After the process has completed all of these shutdown tasks, it reports to the parent process that it is about to terminate. Sometimes, a zombie process is unable to terminate itself, in which case it shows a status of **Z** (zombie).

It is not possible to kill such a process with the `kill` command, because it is already considered “dead.” If you cannot get rid of a zombie, you can kill the parent process and then the zombie disappears as well. However, if the parent process is the `init` process, you should not kill it. The `init` process is a very important process and therefore a reboot may be needed to get rid of the zombie process.

## **1.1.8 Process memory segments**

A process uses its own memory area to perform work. The work varies depending on the situation and process usage. A process can have different workload characteristics and different data size requirements. The process has to handle any of varying data sizes. To satisfy this requirement, the Linux kernel uses a dynamic memory allocation mechanism for each process. The process memory allocation structure is shown in Figure 1-7.

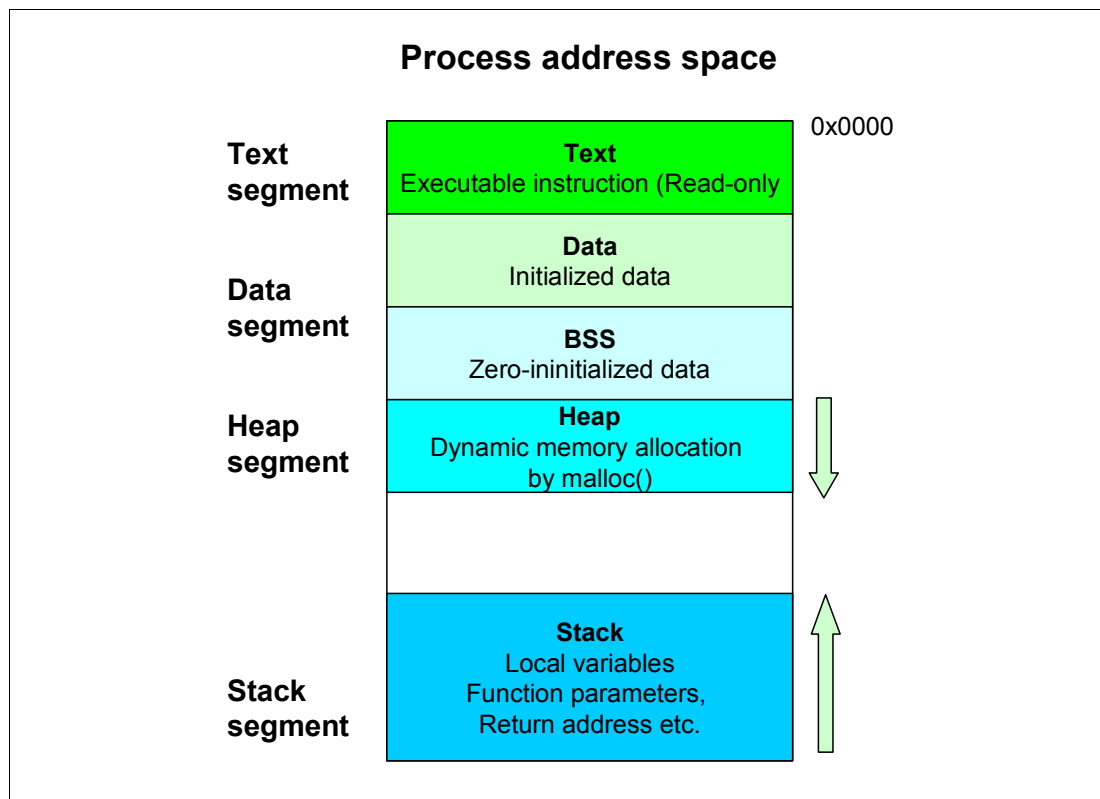

Figure 1-7 Process address space

The process memory area consist of these segments

- Text segment

The area where executable code is stored.

- ▶ Data segment

The data segment consist of these three area.

- Data: The area where initialized data such as static variables are stored.
- BSS: The area where zero-initialized data is stored. The data is initialized to zero.
- Heap: The area where `malloc()` allocates dynamic memory based on the demand. The heap grows toward higher addresses.

- ▶ Stack segment

The area where local variables, function parameters, and the return address of a function is stored. The stack grows toward lower addresses.

The memory allocation of a user process address space can be displayed with the `pmap` command. You can display the total size of the segment with the `ps` command. Refer to 2.3.10, “pmap” on page 52 and 2.3.4, “ps and pstree” on page 44.

## 1.1.9 Linux CPU scheduler

The basic functionality of any computer is, quite simply, to compute. To be able to compute, there must be a means to manage the computing resources, or processors, and the computing tasks, also known as threads or processes. Thanks to the great work of Ingo Molnar, Linux features a kernel using a  $O(1)$  algorithm as opposed to the  $O(n)$  algorithm used to describe the former CPU scheduler. The term  $O(1)$  refers to a static algorithm, meaning that the time taken to choose a process for placing into execution is constant, regardless of the number of processes.

The new scheduler scales very well, regardless of process count or processor count, and imposes a low overhead on the system. The algorithm uses two process priority arrays:

- ▶ active
- ▶ expired

As processes are allocated a timeslice by the scheduler, based on their priority and prior blocking rate, they are placed in a list of processes for their priority in the active array. When they expire their timeslice, they are allocated a new timeslice and placed on the expired array. When all processes in the active array have expired their timeslice, the two arrays are switched, restarting the algorithm. For general interactive processes (as opposed to real-time processes) this results in high-priority processes, which typically have long timeslices, getting more compute time than low-priority processes, but not to the point where they can starve the low-priority processes completely. The advantage of such an algorithm is the vastly improved scalability of the Linux kernel for enterprise workloads that often include vast amounts of threads or processes and also a significant number of processors. The new  $O(1)$  CPU scheduler was designed for kernel 2.6 but backported to the 2.4 kernel family. Figure 1-8 illustrates how the Linux CPU scheduler works.

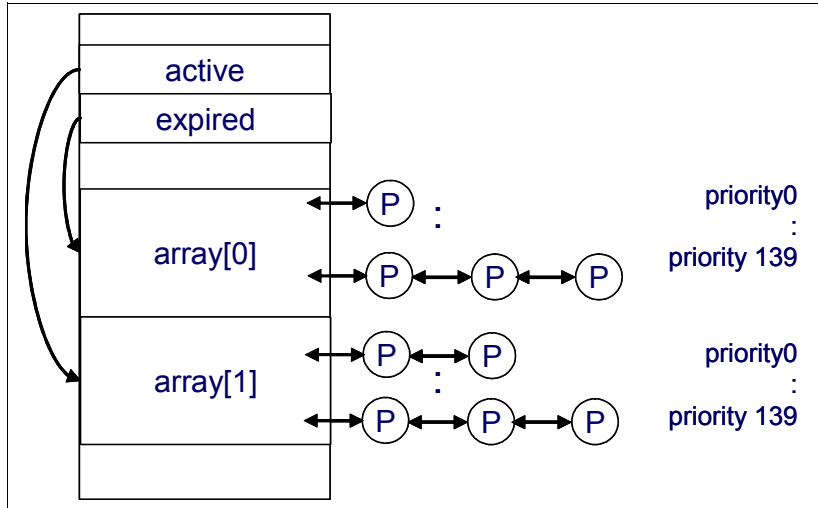

Figure 1-8 Linux kernel 2.6 O(1) scheduler

Another significant advantage of the new scheduler is the support for Non-Uniform Memory Architecture (NUMA) and symmetric multithreading processors, such as Intel® Hyper-Threading technology.

The improved NUMA support ensures that load balancing will not occur across NUMA nodes unless a node gets overburdened. This mechanism ensures that traffic over the comparatively slow scalability links in a NUMA system are minimized. Although load balancing across processors in a scheduler domain group will be load balanced with every scheduler tick, workload across scheduler domains will only occur if that node is overloaded and asks for load balancing.

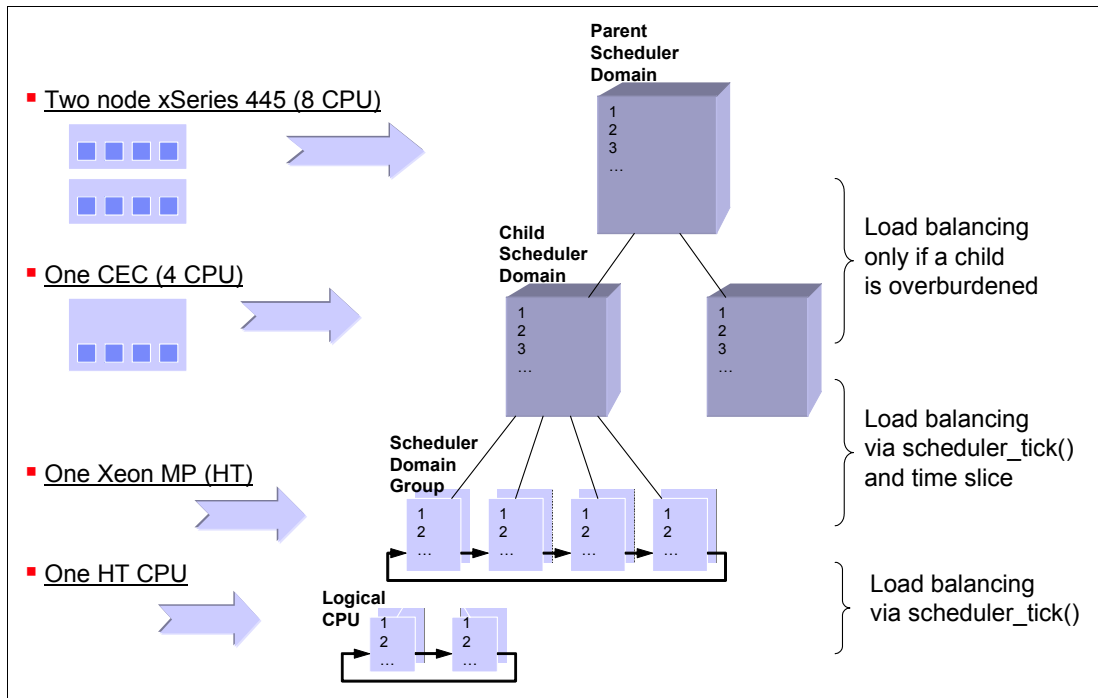

Figure 1-9 Architecture of the O(1) CPU scheduler on an 8-way NUMA based system with Hyper-Threading enabled



## 1.2 Linux memory architecture

To execute a process, the Linux kernel allocates a portion of the memory area to the requesting process. The process uses the memory area as workspace and performs the required work. It is similar to you having your own desk allocated and then using the desktop to scatter papers, documents and memos to perform your work. The difference is that the kernel has to allocate space in more dynamic manner. The number of running processes sometimes comes to tens of thousands and amount of memory is usually limited. Therefore, Linux kernel must handle the memory efficiently. In this section, we describe the Linux memory architecture, address layout, and how the Linux manages memory space efficiently.

### 1.2.1 Physical and virtual memory

Today we are faced with the choice of 32-bit systems and 64-bit systems. One of the most important differences for enterprise-class clients is the possibility of virtual memory addressing above 4 GB. From a performance point of view, it is therefore interesting to understand how the Linux kernel maps physical memory into virtual memory on both 32-bit and 64-bit systems.

As you can see in Figure 1-10 on page 12, there are obvious differences in the way the Linux kernel has to address memory in 32-bit and 64-bit systems. Exploring the physical-to-virtual mapping in detail is beyond the scope of this paper, so we highlight some specifics in the Linux memory architecture.

On 32-bit architectures such as the IA-32, the Linux kernel can directly address only the first gigabyte of physical memory (896 MB when considering the reserved range). Memory above the so-called `ZONE_NORMAL` must be mapped into the lower 1 GB. This mapping is completely transparent to applications, but allocating a memory page in `ZONE_HIGHMEM` causes a small performance degradation.

On the other hand, with 64-bit architectures such as x86-64 (also x64), `ZONE_NORMAL` extends all the way to 64GB or to 128 GB in the case of IA-64 systems. As you can see, the overhead of mapping memory pages from `ZONE_HIGHMEM` into `ZONE_NORMAL` can be eliminated by using a 64-bit architecture.

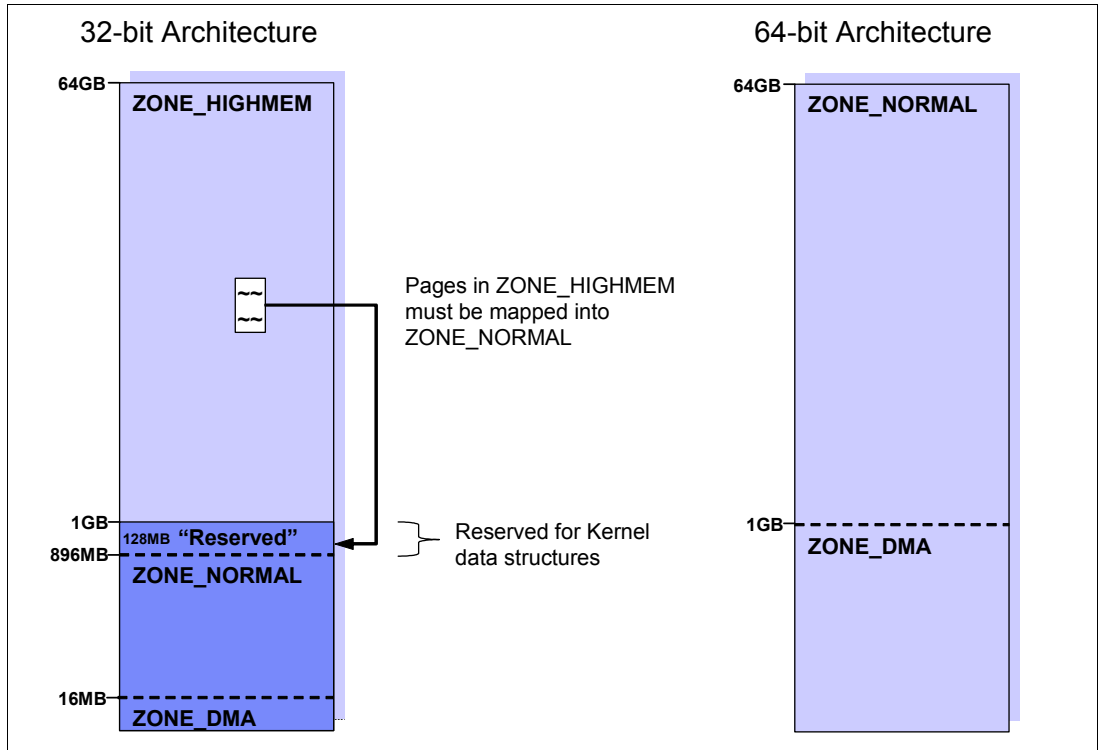

Figure 1-10 Linux kernel memory layout for 32-bit and 64-bit systems

### Virtual memory addressing layout

Figure 1-11 shows the Linux virtual addressing layout for 32-bit and 64-bit architecture.

On 32-bit architectures, the maximum address space that single process can access is 4GB. This is a restriction derived from 32-bit virtual addressing. In a standard implementation, the virtual address space is divided into a 3GB user space and a 1GB kernel space. There is some variants like 4G/4G addressing layout implementing.

On the other hand, on 64-bit architecture such as x86\_64 and ia64, no such restriction exists. Each single process can enjoy the vast and huge address space.

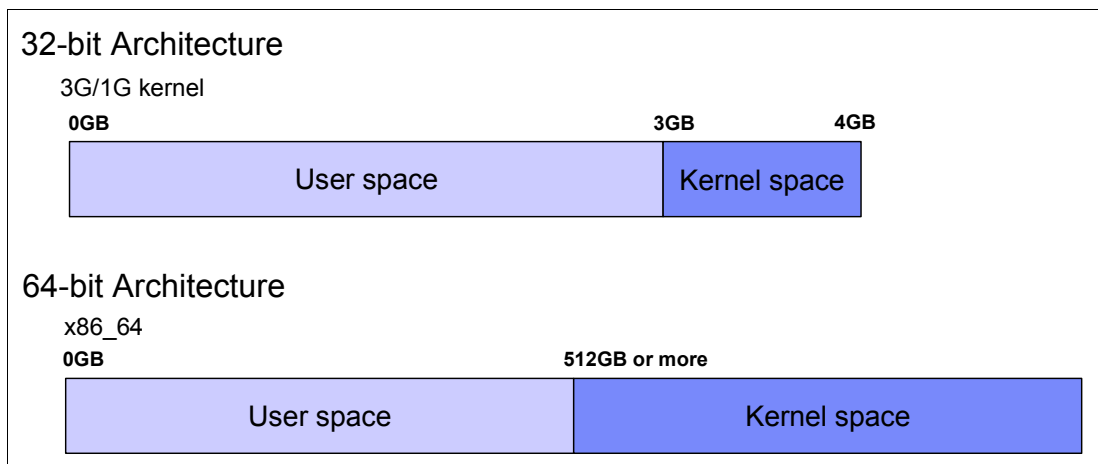

Figure 1-11 Virtual memory addressing layout for 32bit and 64-bit architecture

## 1.2.2 Virtual memory manager

The physical memory architecture of an operating system usually is hidden to the application and the user because operating systems map any memory into virtual memory. If we want to understand the tuning possibilities within the Linux operating system, we have to understand how Linux handles virtual memory. As explained in 1.2.1, “Physical and virtual memory” on page 11, applications do not allocate physical memory, but request a memory map of a certain size at the Linux kernel and in exchange receive a map in virtual memory. As you can see in Figure 1-12 on page 13, virtual memory does not necessarily have to be mapped into physical memory. If your application allocates a large amount of memory, some of it might be mapped to the swap file on the disk subsystem.

Another enlightening fact that can be taken from Figure 1-12 on page 13 is that applications usually do not write directly to the disk subsystem, but into cache or buffers. The *pdflush* kernel threads then flushes out data in cache/buffers to the disk whenever it has time to do so (or, of course, if a file size exceeds the buffer cache). Refer to “Flushing dirty buffer” on page 22

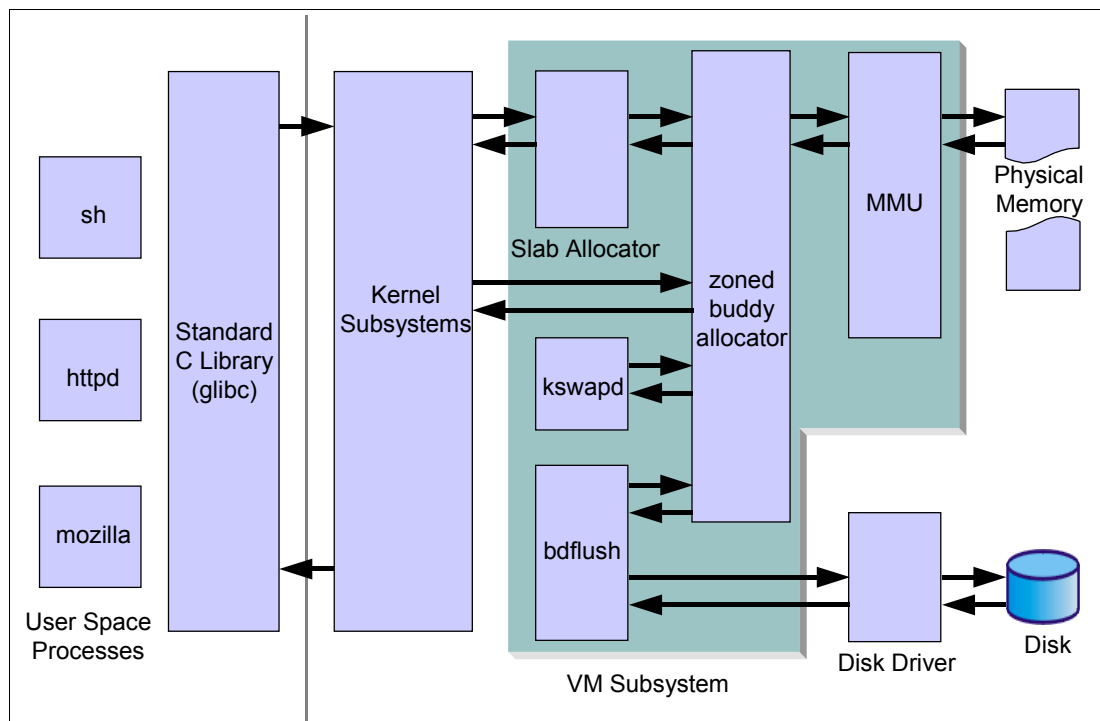

Figure 1-12 The Linux virtual memory manager

Closely connected to the way the Linux kernel handles writes to the physical disk subsystem is the way the Linux kernel manages disk cache. While other operating systems allocate only a certain portion of memory as disk cache, Linux handles the memory resource far more efficiently. The default configuration of the virtual memory manager allocates all available free memory space as disk cache. Hence it is not unusual to see productive Linux systems that boast gigabytes of memory but only have 20 MB of that memory free.

In the same context, Linux also handles swap space very efficiently. The fact that swap space is being used does not mean a memory bottleneck but rather proves how efficiently Linux handles system resources. See “Page frame reclaiming” on page 14 for more detail.

## Page frame allocation

A page is a group of contiguous linear addresses in physical memory (page frame) or virtual memory. The Linux kernel handles memory with this page unit. A page is usually 4K bytes in size. When a process requests a certain amount of pages, if there are available pages, the Linux kernel can allocate them to the process immediately. Otherwise pages have to be taken from some other process or page cache. The kernel knows how many memory pages are available and where they are located.

### Buddy system

The Linux kernel maintains its free pages by using the mechanism called *buddy system*. The buddy system maintains free pages and tries to allocate pages for page allocation requests. It tries to keep the memory area contiguous. If small pages are scattered without consideration, it may cause memory fragmentation and it's more difficult to allocate large portion of pages into a contiguous area. It may lead to inefficient memory use and performance decline.

Figure 1-13 illustrates how the buddy system allocates pages.

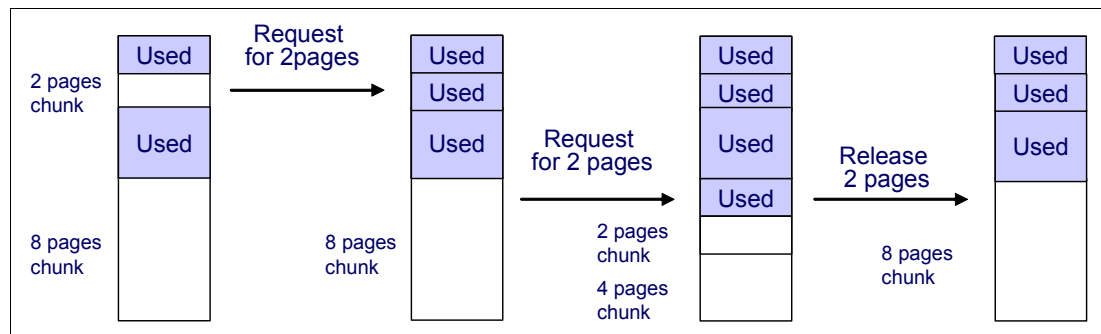

Figure 1-13 Buddy System

When the attempt of pages allocation failed, the page reclaiming will be activated. Refer to “Page frame reclaiming” on page 14.

You can find information on the buddy system through `/proc/buddyinfo`. For detail, please refer to “Memory used in a zone” on page 47.

## Page frame reclaiming

If pages are not available when a process requests to map a certain amount of pages, the Linux kernel tries to get pages for the new request by releasing certain pages which are used before but not used anymore and still marked as active pages based on certain principals and allocating the memory to new process. This process is called *page reclaiming*. `kswapd` kernel thread and `try_to_free_page()` kernel function are responsible for page reclaiming.

While `kswapd` is usually sleeping in task interruptible state, it is called by the buddy system when free pages in a zone fall short of a certain threshold. It then tries to find the candidate pages to be gotten out of active pages based on the Least Recently Used (*LRU*) principal. This is relatively simple. The pages least recently used should be released first. The active list and the inactive list are used to maintain the candidate pages. `kswapd` scans part of the active list and check how recently the pages were used then the pages not used recently is put into inactive list. You can take a look at how much memory is considered as active and inactive using `vmstat -a` command. For detail refer to 2.3.2, “`vmstat`”.

`kswapd` also follows another principal. The pages are used mainly for two purpose; *page cache* and *process address space*. The page cache is pages mapped to a file on disk. The pages belonging to a process address space is used for heap and stack (called anonymous memory because it's not mapped to any files, and has no name) (refer to 1.1.8, “Process

memory segments” on page 8). When kswaped reclaims pages, it would rather shrink the page cache than page out (or swap out) the pages owned by processes.

**Note:** The phrase “page out” and “swap out” is sometimes confusing. “page out” means take some pages (a part of entire address space) into swap space while “swap out” means taking entire address space into swap space. They are sometimes used interchangeably.

The good proportion of page cache reclaimed and process address space reclaimed may depend on the usage scenario and will have certain effects on performance. You can take some control of this behavior by using `/proc/sys/vm/swappiness`. Please refer to 4.5.1, “Setting kernel swap and pdflush behavior” on page 110 for tuning detail.

### ***swap***

As we stated before, when page reclaiming occurs, the candidate pages in the inactive list which belong to the process address space may be paged out. Having swap itself is not problematic situation. While swap is nothing more than a guarantee in case of over allocation of main memory in other operating systems, Linux utilizes swap space far more efficiently. As you can see in Figure 1-12, virtual memory is composed of both physical memory and the disk subsystem or the swap partition. If the virtual memory manager in Linux realizes that a memory page has been allocated but not used for a significant amount of time, it moves this memory page to swap space.

Often you will see daemons such as `getty` that will be launched when the system starts up but will hardly ever be used. It appears that it would be more efficient to free the expensive main memory of such a page and move the memory page to swap. This is exactly how Linux handles swap, so there is no need to be alarmed if you find the swap partition filled to 50%. The fact that swap space is being used does not mean a memory bottleneck but rather proves how efficiently Linux handles system resources.

## **1.3 Linux file systems**

One of the great advantages of Linux as an open source operating system is that it offers users a variety of supported file systems. Modern Linux kernels can support nearly every file system ever used by a computer system, from basic FAT support to high performance file systems such as the journaling file system JFS. However, because Ext2, Ext3 and ReiserFS are native Linux file systems and are supported by most Linux distributions (ReiserFS is commercially supported only on Novell SUSE Linux), we will focus on their characteristics and give only an overview of the other frequently used Linux file systems.

For more information on file systems and the disk subsystem, see 4.6, “Tuning the disk subsystem” on page 113.

### **1.3.1 Virtual file system**

Virtual Files System (VFS) is an abstraction interface layer that resides between the user process and various types of Linux file system implementations. VFS provides common object models (i.e. i-node, file object, page cache, directory entry etc.) and methods to access file system objects. It hides the differences of each file system implementation from user processes. Thanks to VFS, user processes do not need to know which file system to use, or which system call should be issued for each file system. Figure 1-14 illustrates the concept of VFS.

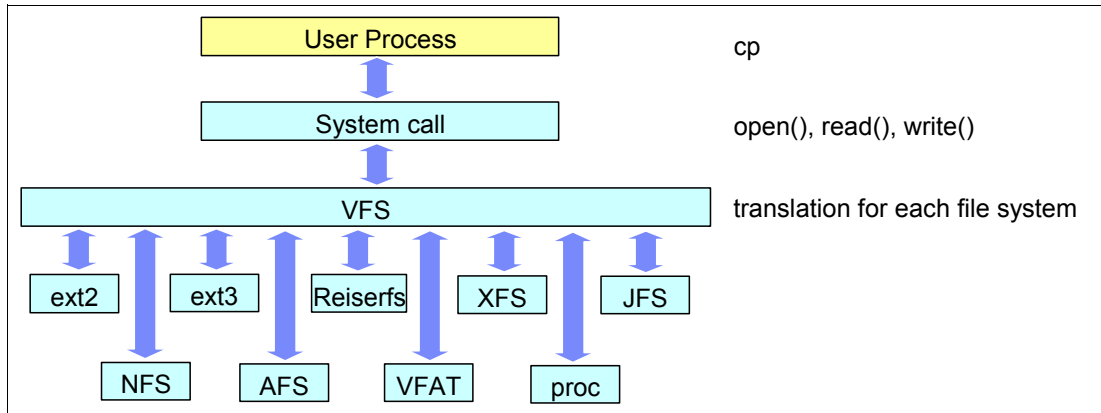

Figure 1-14 VFS concept

### 1.3.2 Journaling

In a non-journaling file system, when a write is performed to a file system the Linux kernel makes changes to the file system metadata first and then writes actual user data next. This operations sometimes causes higher chances of losing data integrity. If the system suddenly crashes for some reason while the write operation to file system metadata is in process, the file system consistency may be broken. *fsck* will fix the inconsistency by checking all the metadata and recover the consistency at the time of next reboot. But it takes way much time to be completed when the system has large volume. The system is not operational during this process.

A Journaling file system solves this problem by writing data to be changed to the area called the journal area before writing the data to the actual file system. The journal area can be placed both in the file system itself or out of the file system. The data written to the journal area is called the journal log. It includes the changes to file system metadata and the actual file data if supported.

As journaling write journal logs before writing actual user data to the file system, it may cause performance overhead compared to no-journaling file system. How much performance overhead is sacrificed to maintain higher data consistency depends on how much information is written to disk before writing user data. We will discuss this topic in 1.3.4, "Ext3" on page 18.

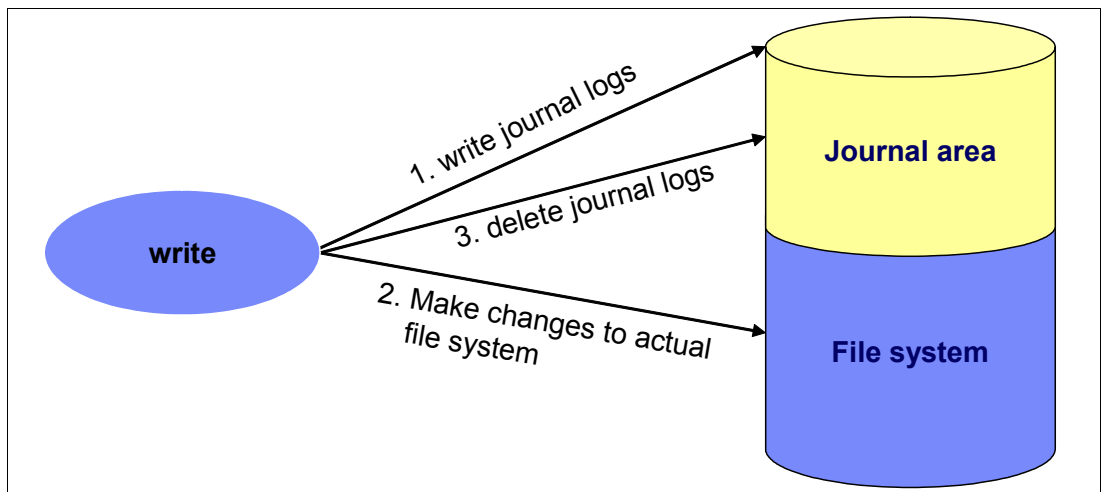

Figure 1-15 Journaling concept

### 1.3.3 Ext2

The extended 2 file system is the predecessor of the extended 3 file system. A fast, simple file system, it features no journaling capabilities, unlike most other current file systems.

Figure 1-16 shows the Ext2 file system data structure. The file system starts with boot sector and followed by block groups. Splitting entire file system into several small block groups contributes performance gain because i-node table and data blocks which hold user data can reside closer on disk platter, then seek time can be reduced. A block group consists of:

- Super block: Information on the file system is stored here. The exact copy of a super block is placed in the top of every block group.
- Block group descriptor: Information on the block group is stored.
- Data block bitmaps: Used for free data block management.
- i-node bitmaps: Used for free i-node management.
- i-node tables: i-node tables are stored here. Every file has a corresponding i-node table which holds meta-data of the file such as file mode, uid, gid, atime, ctime, mtime, dtime and pointer to the data block.
- Data blocks: Where actual user data is stored.

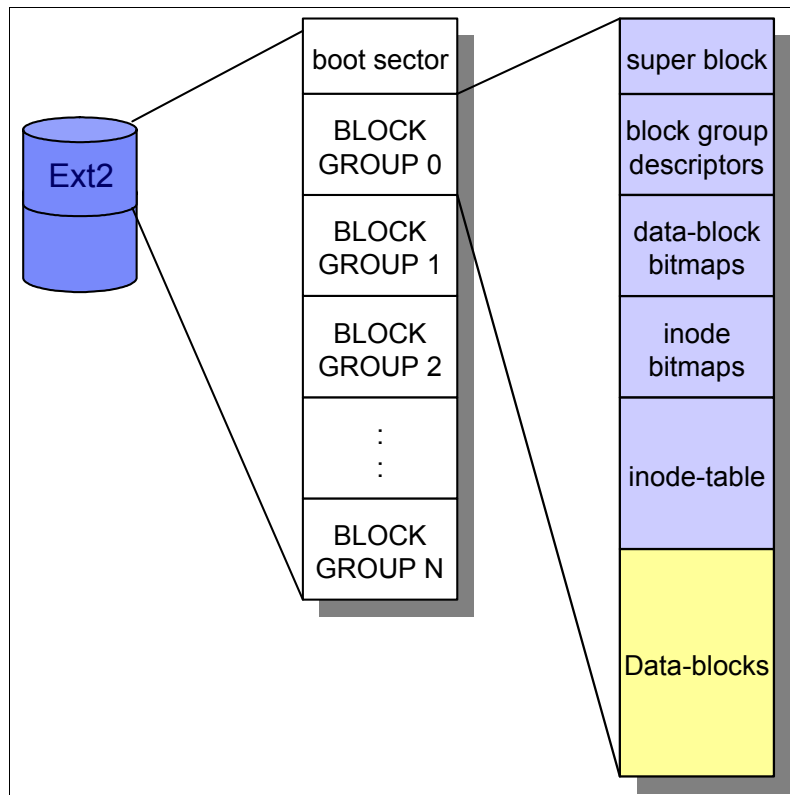

Figure 1-16 Ext2 file system data structure

To find data blocks which consist of a file, the kernel searches the i-node of the file first. When a request to open `/var/log/messages` comes from a process, the kernel parses the file path and searches a directory entry of `/` (root directory) which has the information about files and directories under itself (root directory). Then the kernel can find the i-node of `/var` next and takes a look at the directory entry of `/var`, and it also has the information of files and directories under itself as well. The kernel gets down to the file in same manner until it finds

i-node of the file. The Linux kernel uses file object cache such as directory entry cache, i-node cache to accelerate finding the corresponding i-node.

Now the Linux kernel knows i-node of the file then it tries to reach actual user data block. As we described, i-node has the pointer to the data block. By referring to it, the kernel can get to the data block. For large files, Ext2 implements direct/indirect reference to data block. Figure 1-17 illustrates how it works.

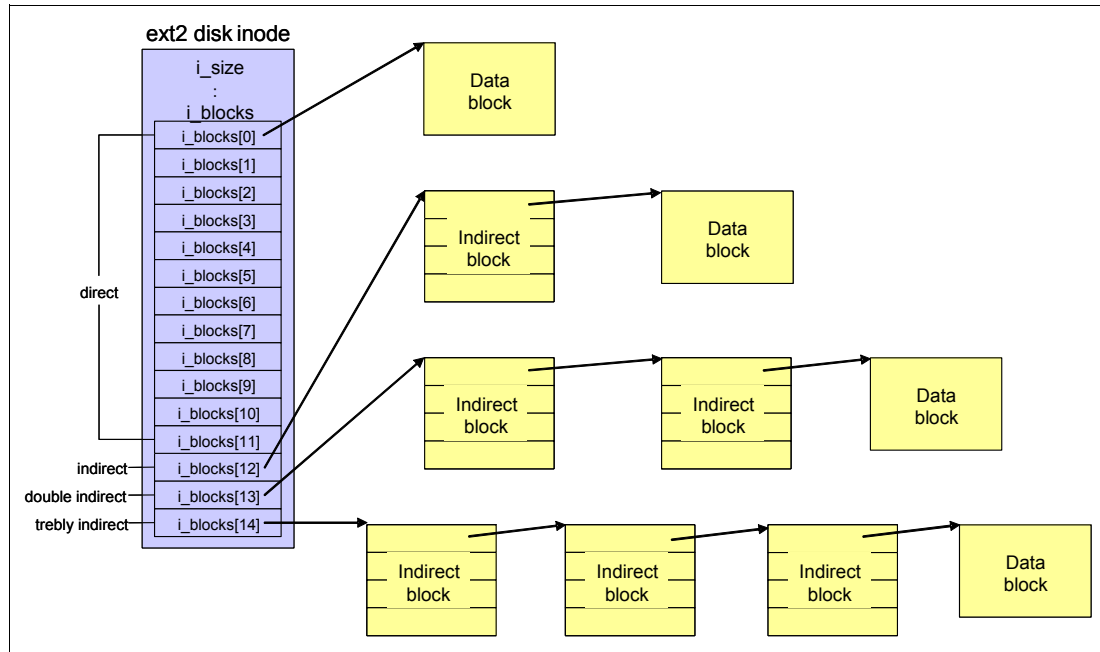

Figure 1-17 Ext2 file system direct / indirect reference to data block

The file system structure and file access operations differ by file system. This makes different characteristics of each file system.

### 1.3.4 Ext3

The current Enterprise Linux distributions support the extended 3 file system. This is an updated version of the widely used extended 2 file system. Though the fundamental structures are quite similar to Ext2 file system, the major difference is the support of journaling capability. Highlights of this file system include:

- ▶ **Availability:** Ext3 always writes data to the disks in a consistent way, so in case of an unclean shutdown (unexpected power failure or system crash), the server does not have to spend time checking the consistency of the data, thereby reducing system recovery from hours to seconds.
- ▶ **Data integrity:** By specifying the journaling mode `data=journal` on the `mount` command, all data, both file data and metadata, is journaled.
- ▶ **Speed:** By specifying the journaling mode `data=writeback`, you can decide on speed versus integrity to meet the needs of your business requirements. This will be notable in environments where there are heavy synchronous writes.
- ▶ **Flexibility:** Upgrading from existing Ext2 file systems is simple and no reformatting is necessary. By executing the `tune2fs` command and modifying the `/etc/fstab` file, you can easily update an Ext2 to an Ext3 file system. Also note that Ext3 file systems can be mounted as Ext2 with journaling disabled. Products from many third-party vendors have



the capability of manipulating Ext3 file systems. For example, PartitionMagic can handle the modification of Ext3 partitions.

### Mode of journaling

Ext3 support three types of journaling mode.

- ▶ journal

This journaling option provides the highest form of data consistency by causing both file data and metadata to be journaled. It is also has the higher performance overhead.

- ▶ ordered

In this mode only metadata is written. However, file data is guaranteed to be written first. This is the default setting.

- ▶ writeback

This journaling option provides the fastest access to the data at the expense of data consistency. The data is guaranteed to be consistent as the metadata is still being logged. However, no special handling of actual file data is done and this may lead to old data appearing in files after a system crash.

## 1.3.5 ReiserFS

ReiserFS is a fast journaling file system with optimized disk-space utilization and quick crash recovery. ReiserFS has been developed to a great extent with the help of Novell. ReiserFS is commercially supported only on Novell SUSE Linux.

## 1.3.6 Journal File System

The Journal File System (JFS) is a full 64-bit file system that can support very large files and partitions. JFS was developed by IBM originally for AIX® and is now available under the general public license (GPL). JFS is an ideal file system for very large partitions and file sizes that are typically encountered in high performance computing (HPC) or database environments. If you would like to learn more about JFS, refer to:

<http://jfs.sourceforge.net>

**Note:** In Novell SUSE Linux Enterprise Server 10, JFS is no longer supported as a new file system.

## 1.3.7 XFS

The eXtended File System (XFS) is a high-performance journaling file system developed by Silicon Graphics Incorporated originally for its IRIX family of systems. It features characteristics similar to JFS from IBM by also supporting very large file and partition sizes. Therefore usage scenarios are very similar to JFS.

## 1.4 Disk I/O subsystem

Before a processor can decode and execute instructions, data should be retrieved all the way from sectors on a disk platter to processor cache and its registers and the results of the executions may be written back to the disk.

We'll take a look at Linux disk I/O subsystem to have better understanding of the components which have large effect on system performance.

### 1.4.1 I/O subsystem architecture

Figure 1-18 on page 20 shows basic concept of I/O subsystem architecture

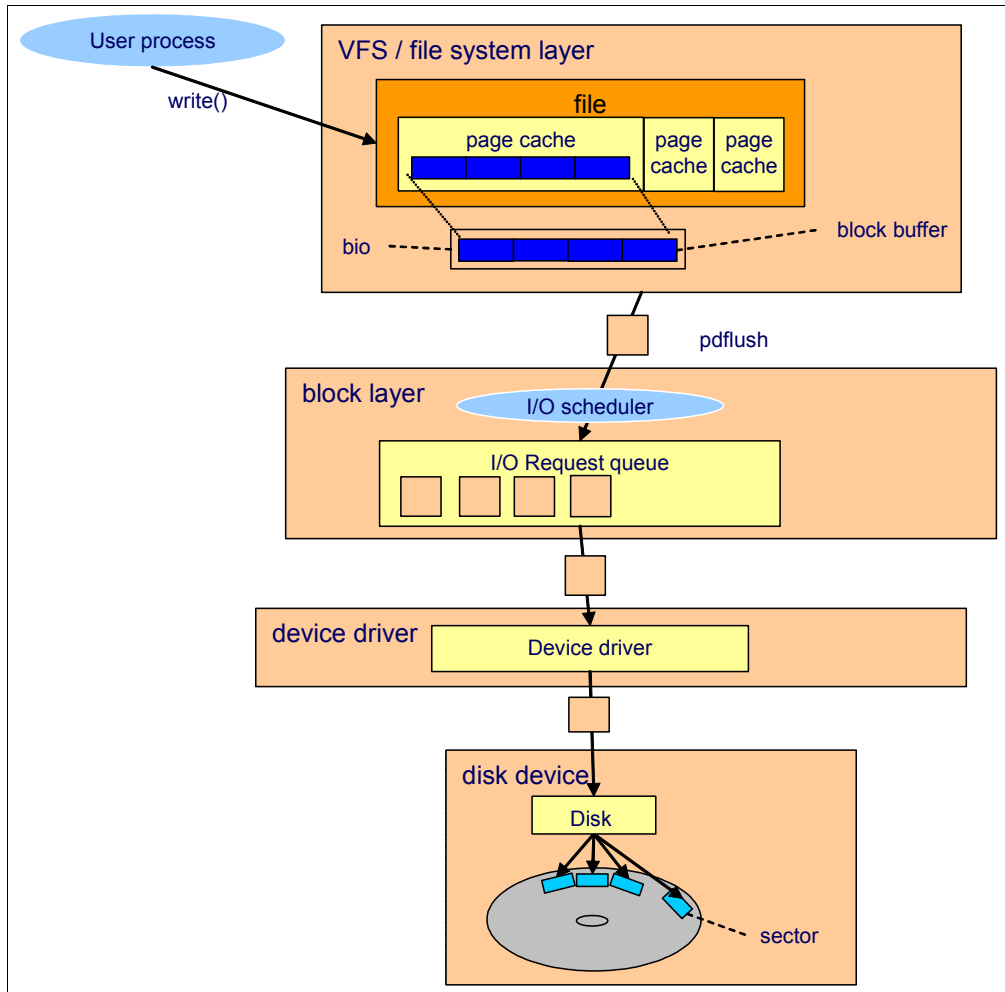

Figure 1-18 I/O subsystem architecture

For a quick understanding of overall I/O subsystem operations, we will take an example of writing data to a disk. The following sequence outlines the fundamental operations that occur when a disk-write operation is performed. Assuming that the file data is on sectors on disk platters and has already been read and is on the page cache.

1. A process requests to write a file through the `write()` system call
2. The kernel updates the *page cache* mapped to the file
3. A *pdflush* kernel thread takes care of flushing the page cache to disk
4. The file system layer puts each block buffer together to a *bio* struct (refer to 1.4.3, "Block layer" on page 23) and submits a write request to the block device layer
5. The block device layer gets requests from upper layers and performs an *I/O elevator* operation and puts the requests into the I/O request queue

6. A device driver such as SCSI or other device specific drivers will take care of write operation
7. A disk device firmware do hardware operation like seek head, rotation, data transfer to the sector on the platter.

## 1.4.2 Cache

In the past 20 years, the performance improvement of processors has outperformed that of the other components in a computer system such as processor cache, bus, RAM, disk and so on. Slower access to memory and disk restricts overall system performance, so system performance is not be benefited by processor speed improvement. The cache mechanism resolves this problem by caching frequently used data in faster memory. It reduces the chances of having to access slower memory. Current computer system uses this technique in most all I/O components such as hard disk drive cache, disk controller cache, file system cache, cache handled by each application and so on.

### Memory hierarchy

Figure 1-19 shows the concept of memory hierarchy. As the difference of access speed between the CPU register and disk is large, the CPU will spend much time waiting for data from slow disk devices, and therefore it significantly reduces the advantage of a fast CPU. Memory hierarchal structure reduces this mismatch by placing L1 cache, L2 cache, RAM and some other caches between the CPU and disk. It enables a process to get less chance to access slower memory and disk. The memory closer to processor has higher speed and less size.

This technique can also take advantage of locality of reference principal. The higher cache hit rate on faster memory is, the faster the access to data is.

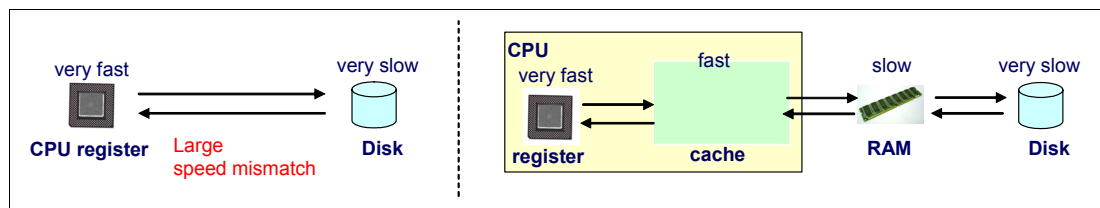

Figure 1-19 Memory hierarchy

### Locality of reference

As we stated previously in “Memory hierarchy” above, achieving higher cache hit rate is the key for performance improvement. To achieve higher cache hit rate, the technique called “locality of reference” is used. This technique is based on the following principals:

- ▶ The data most recently used has a high probability of being used in near future (temporal locality)
- ▶ The data resides close to the data which has been used has a high probability of being used (spatial locality)

Figure 1-20 on page 22 illustrates this principal.

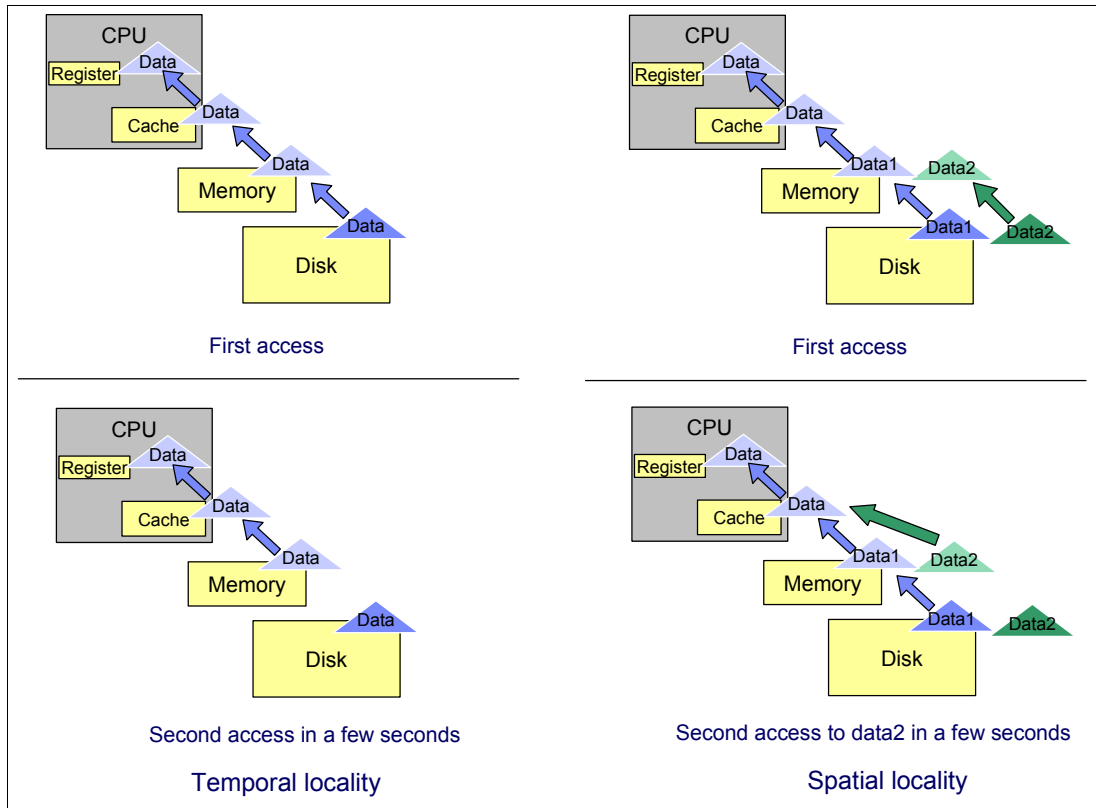

Figure 1-20 Locality of reference

Linux implementation make use of this principal in many components such as page cache, file object cache (i-node cache, directory entry cache etc.), read ahead buffer and so on.

### Flushing dirty buffer

When a process reads data from disk, the data is copied on to memory. The process and other processes can retrieve the same data from the copy of the data cached in memory. When a process tries to change the data, the process changes the data in memory first. At this time, the data on disk and the data in memory is not identical and the data in memory is referred to as a *dirty buffer*. The dirty buffer should be synchronized to the data on disk as soon as possible, or the data in memory may be lost if a sudden crash occurs.

The synchronization process for a dirty buffer is called *flush*. In the Linux kernel 2.6 implementation, *pdflush* kernel thread is responsible for flushing data to the disk. The flush occurs on regular basis (kupdate) and when the proportion of dirty buffers in memory exceeds a certain threshold (bdflush). The threshold is configurable in the `/proc/sys/vm/dirty_background_ratio` file. For more information, refer to 4.5.1, "Setting kernel swap and pdflush behavior" on page 110.

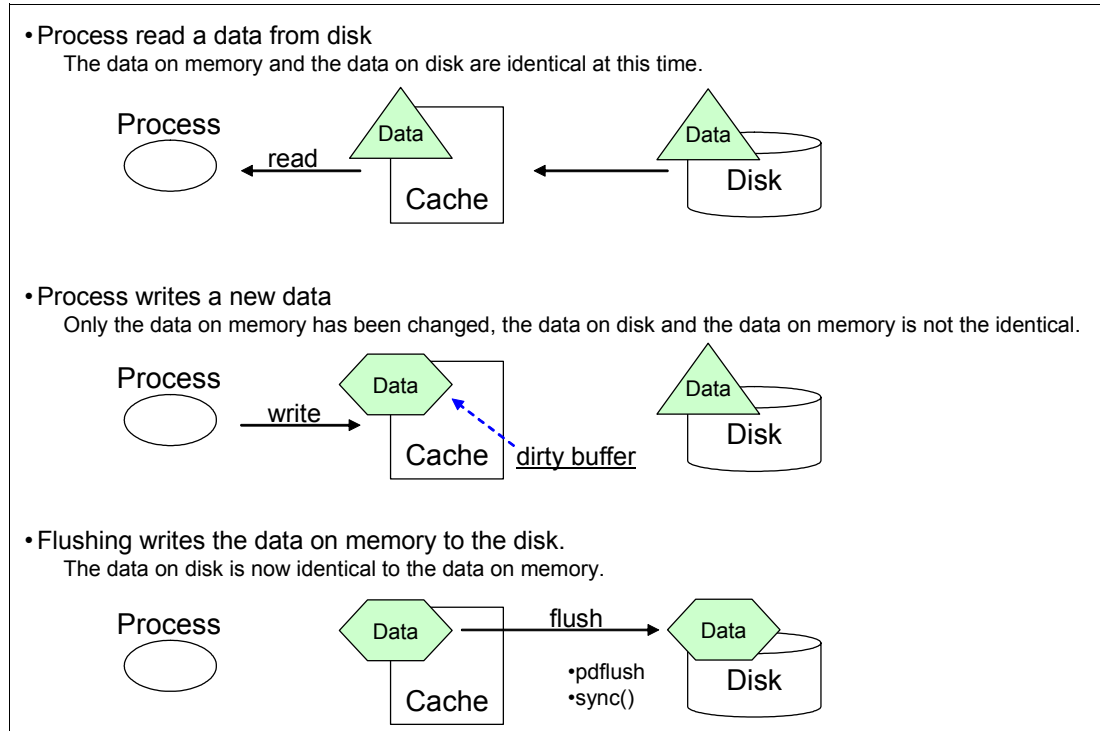

Figure 1-21 Flushing dirty buffers

### 1.4.3 Block layer

The block layer handles all the activity related to block device operation (refer to Figure 1-18 on page 20). The key data structure in the block layer is the *bio* structure. The bio structure is an interface between file system layer and block layer.

When a write is performed, file system layer tries to write to page cache which is made up of block buffers. It makes up a bio structure by putting the contiguous blocks together, then sends bio to the block layer. (refer to Figure 1-18 on page 20)

The block layer handles the bio request and links these requests into a queue called the I/O request queue. This linking operation is called *I/O elevator*. In Linux kernel 2.6 implementations, four types of I/O elevator algorithms are available. These are described below.

#### Block sizes

The block size, the smallest amount of data that can be read or written to a drive, can have a direct impact on a server's performance. As a guideline, if your server is handling many small files, then a smaller block size will be more efficient. If your server is dedicated to handling large files, a larger block size may improve performance. Block sizes cannot be changed on the fly on existing file systems, and only a reformat will modify the current block size.

#### I/O elevator

Apart from a vast amount of other features, the Linux kernel 2.6 employs a new I/O elevator model. While the Linux kernel 2.4 used a single, general-purpose I/O elevator, kernel 2.6 offers the choice of four elevators. Because the Linux operating system can be used for a wide range of tasks, both I/O devices and workload characteristics change significantly. A

laptop computer quite likely has different I/O requirements from a 10,000-user database system. To accommodate this, four I/O elevators are available.

► Anticipatory

The anticipatory I/O elevator was created based on the assumption of a block device with only one physical seek head (for example a single SATA drive). The anticipatory elevator uses the deadline mechanism described in more detail below plus an anticipation heuristic. As the name suggests, the anticipatory I/O elevator “anticipates” I/O and attempts to write it in single, bigger streams to the disk instead of multiple very small random disk accesses. The anticipation heuristic may cause latency for write I/O. It is clearly tuned for high throughput on general purpose systems such as the average personal computer. Up to kernel release 2.6.18 the Anticipatory elevator is the standard I/O scheduler. However most Enterprise Linux distributions default to the CFQ elevator.

► Complete Fair Queuing (CFQ)

The CFQ elevator implements a QoS (Quality of Service) policy for processes by maintaining per-process I/O queues. The CFQ elevator is well suited for large multiuser systems with a vast amount of competing processes. It aggressively attempts to avoid starvation of processes and features low latency. Starting with kernel release 2.6.18 the improved CFQ elevator is the default I/O scheduler.

Depending on the system setup and the workload characteristic the CFQ scheduler can slowdown a single main application, for example a massive database with its fairness oriented algorithms. The default configuration handles the fairness based on process groups which compete against each other. For example a single database and also all writes via the page cache (all `pdflush` instances are in one `pgroup`) are considered as a single application by CFQ that may compete against many background processes. It can be useful to experiment with I/O scheduler subconfigurations and/or the deadline scheduler in such cases.

► Deadline

The deadline elevator is a cyclic elevator (round robin) with a deadline algorithm that provides a near real-time behavior of the I/O subsystem. The deadline elevator offers excellent request latency while maintaining good disk throughput. The implementation of the deadline algorithm ensures that starvation of a process cannot occur.

► NOOP

NOOP stands for No Operation, and the name explains most of its functionality. The NOOP elevator is simple and lean. It is a simple FIFO queue that performs no data ordering but simple merging of adjacent requests, so it adds very low processor overhead to disk I/O. The NOOP elevator assumes that a block device either features its own elevator algorithm such as TCQ for SCSI, or that the block device has no seek latency such as a flash card.

**Note:** With the Linux kernel release 2.6.18 the I/O elevators are now selectable on a per disk subsystem basis and have no longer to be set on a per system level.

## 1.4.4 I/O device driver

The Linux kernel takes control of devices using a device driver. The device driver is usually a separate kernel module and is provided for each device (or group of devices) to make the device available for the Linux operating system. Once the device driver is loaded, it runs as a part of the Linux kernel and takes full control of the device. Here we describe SCSI device drivers.

## SCSI

The Small Computer System Interface (SCSI) is the most commonly used I/O device technology, especially in the enterprise server environment. In Linux kernel implementations, SCSI devices are controlled by device driver modules. They consist of the following types of modules.

- ▶ Upper level drivers: sd\_mod, sr\_mod(SCSI-CDROM), st(SCSI Tape), sq(SCSI generic device) etc.  
Provide functionalities to support several types of SCSI devices such as SCSI CD-ROM, SCSI tape etc.
- ▶ Middle level driver: scsi\_mod  
Implements SCSI protocol and common SCSI functionality
- ▶ Low level drivers  
Provide lower level access to each devices. Low level driver is basically specific to a hardware device and provided for each device. For example, ips for IBM ServerAID™ controller, qla2300 for QLogic HBA, mptscsih for LSI Logic SCSI controller etc.
- ▶ Pseudo driver: ide-scsi  
Used for IDE-SCSI emulation.

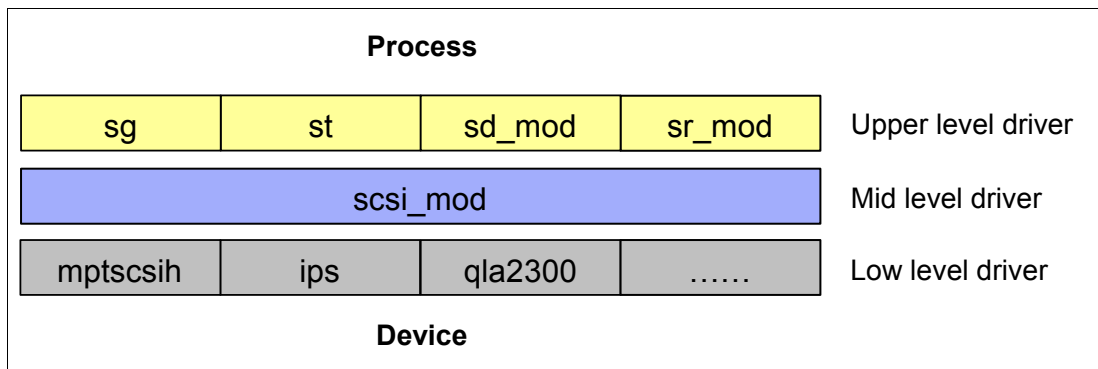

Figure 1-22 Structure of SCSI drivers

If there is specific functionality implemented for a device, it should be implemented in device firmware and the low level device driver. The supported functionality depend on which hardware you use and which version of device driver you use. The device itself should also support the desired functionality. Specific functions are usually tuned by a device driver parameter. You may try some performance tuning in `/etc/modules.conf`. Refer to the device and device driver documentation for possible tuning hints and tips.

### 1.4.5 RAID and Storage system

The selection and configuration of storage system and RAID types are also important factors in terms of system performance. However we leave the details of this topic out of scope of this Redpaper, though Linux supports software RAID. We include some of tuning considerations in 4.6.1, "Hardware considerations before installing Linux" on page 114.

For additional, in-depth coverage of the available IBM storage solutions, see:

- ▶ *Tuning IBM System x Servers for Performance*, SG24-5287
- ▶ *IBM System Storage Solutions Handbook*, SG24-5250
- ▶ *Introduction to Storage Area Networks*, SG24-5470

## 1.5 Network subsystem

The network subsystem is another important subsystem in the performance perspective. Networking operations interact with many components other than Linux itself such as switches, routers, gateways, PC clients etc. Though these components may be out of the control of Linux, they have much influence on the overall performance. Keep in mind that you have to work closely with people working on the network system.

Here we mainly focus on how Linux handles networking operations.

### 1.5.1 Networking implementation

The TCP/IP protocol has a layered structure similar to the OSI layer model. The Linux kernel networking implementation employs a similar approach. Figure 1-23 illustrates the layered Linux TCP/IP stack and quick overview of TCP/IP communication.

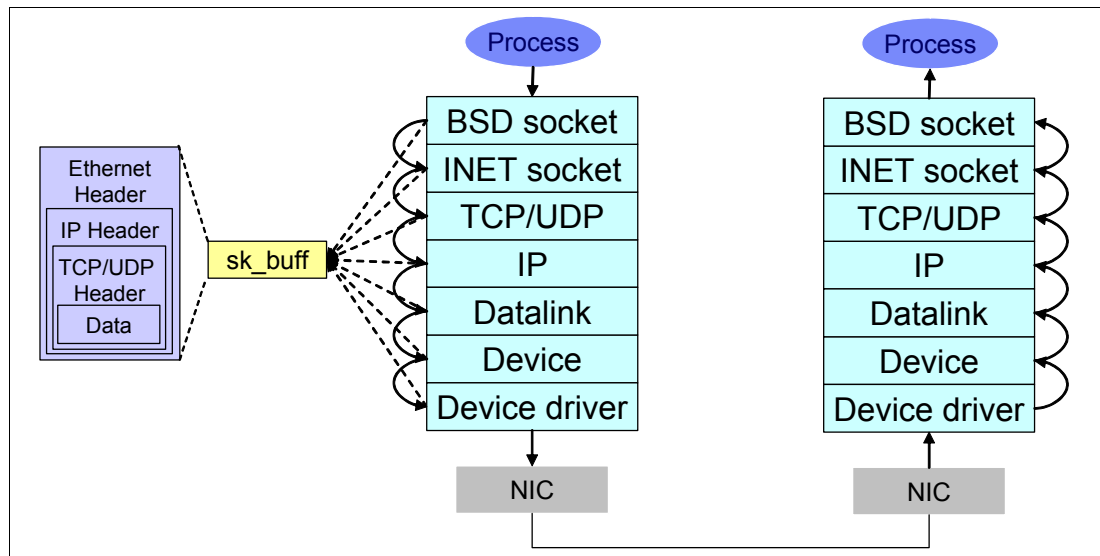

Figure 1-23 Network layered structure and quick overview of networking operation

Linux uses a socket interface for TCP/IP networking operation as well as many UNIX systems do. The socket provides an interface for user applications. We will take a quick look at the sequence that outlines the fundamental operations that occur during network data transfer.

1. When an application sends data to its peer host, the application creates its data.
2. The application opens the socket and writes the data through the socket interface.
3. The *socket buffer* is used to deal with the transferred data. The socket buffer has reference to the data and it goes down through the layers.
4. In each layer, appropriate operations such as parsing the headers, adding and modifying the headers, check sums, routing operation, fragmentation etc. are performed. When the socket buffer goes down through the layers, the data itself is not copied between the layers. Because copying actual data between different layer is not effective, the kernel avoids unnecessary overhead by just changing the reference in the socket buffer and passing it to the next layer.
5. Finally the data goes out to the wire from network interface card.
6. The Ethernet frame arrives at the network interface of the peer host



7. The frame is moved into the network interface card buffer if the MAC address matches the MAC address of the interface card.
8. The network interface card eventually moves the packet into a socket buffer and issues a hard interrupt at the CPU.
9. The CPU then processes the packet and moves it up through the layers until it arrives at (for example) a TCP port of an application such as Apache.

### Socket buffer

As we stated before, the kernel uses buffers to send and receive data. Figure 1-24 shows configurable buffers which can be used for networking. They can be tuned through files in /proc/sys/net.

```
/proc/sys/net/core/rmem_max  
/proc/sys/net/core/rmem_default  
/proc/sys/net/core/wmem_max  
/proc/sys/net/core/wmem_default  
/proc/sys/net/ipv4/tcp_mem  
/proc/sys/net/ipv4/tcp_rmem  
/proc/sys/net/ipv4/tcp_wmem
```

Sometimes it may have an effect on the network performance. We'll cover the details in 4.7.4, "Increasing network buffers" on page 127.

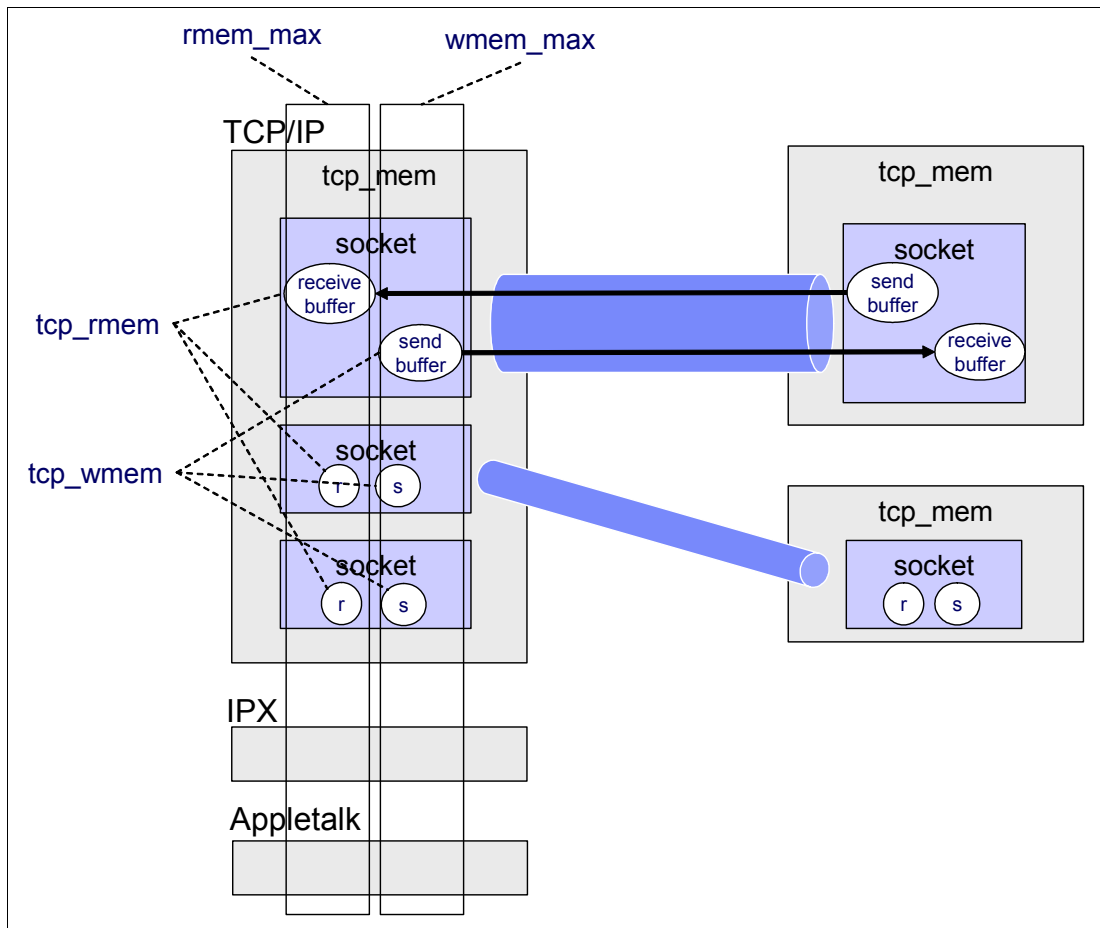

Figure 1-24 socket buffer memory allocation

## Network API (NAPI)

The network subsystem has undergone some changes with the introduction of the new network API (NAPI). The standard implementation of the network stack in Linux focuses more on reliability and low latency than on low overhead and high throughput. While these characteristics are favorable when creating a firewall, most enterprise applications such as file and print or databases will perform more slowly than a similar installation under Windows®.

In the traditional approach of handling network packets, as depicted by the blue arrows in Figure 1-25, the network interface card eventually moves the packet into a network buffer of the operating systems kernel and issues a hard interrupt at the CPU, as we stated before.

This is only a simplified view of the process of handling network packets, but it illustrates one of the shortcomings of this very approach. As you have realized, every time an Ethernet frame with a matching MAC address arrives at the interface, there will be a hard interrupt. Whenever a CPU has to handle a hard interrupt, it has to stop processing whatever it was working on and handle the interrupt, causing a context switch and the associated flush of the processor cache. While one might think that this is not a problem if only a few packets arrive at the interface, Gigabit Ethernet and modern applications can create thousands of packets per second, causing a vast number of interrupts and context switches to occur.

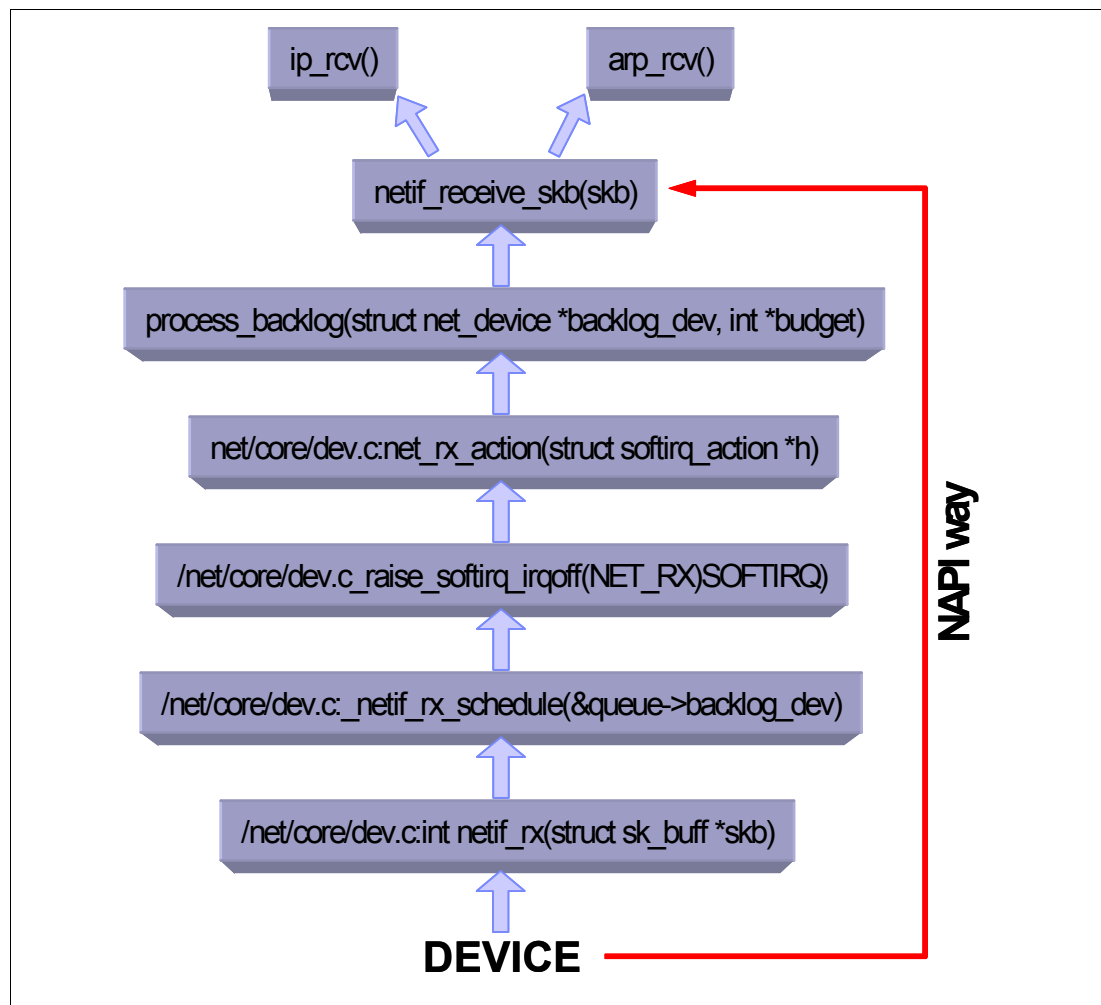

Figure 1-25 The Linux network stack

Because of this, NAPI was introduced to counter the overhead associated with processing network traffic. For the first packet, NAPI works just like the traditional implementation as it issues an interrupt for the first packet. But after the first packet, the interface goes into a polling mode: As long as there are packets in the DMA ring buffer of the network interface, no new interrupts will be caused, effectively reducing context switching and the associated overhead. Should the last packet be processed and the ring buffer be emptied, then the interface card will again fall back into the interrupt mode we explored earlier. NAPI also has the advantage of improved multiprocessor scalability by creating soft interrupts that can be handled by multiple processors. While NAPI would be a vast improvement for most enterprise class multiprocessor systems, it requires NAPI-enabled drivers. There is significant room for tuning, as we will explore in the tuning section of this Redpaper.

## Netfilter

Linux has an advanced firewall capability as a part of the kernel. This capability is provided by *Netfilter* modules. You can manipulate and configure Netfilter using `iptables` utility.

Generally speaking, Netfilter provides the following functions.

- ▶ Packet filtering: If a packet match a certain rule, Netfilter accept or deny the packets or take appropriate action based on defined rules
- ▶ Address translation: If a packet match a certain rule, Netfilter alter the packet itself to meet the address translation requirements.

Matching filters can be defined with the following properties.

- ▶ Network interface
- ▶ IP address, IP address range, subnet
- ▶ Protocol
- ▶ ICMP Type
- ▶ Port
- ▶ TCP flag
- ▶ State (refer to “Connection tracking” on page 30)

Figure 1-26 give an overview of how packets traverse the Netfilter chains which are the lists of defined rules applied at each point in sequence.

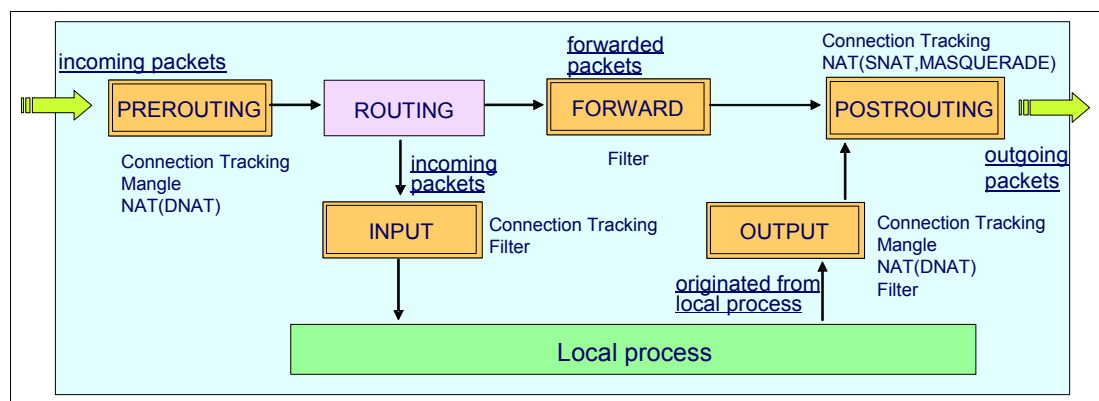

Figure 1-26 Netfilter packet flow

Netfilter will take appropriate actions if packet matches the rule. The action is called a target. Some of possible targets are:

ACCEPT: Accept the packet and let it through.  
DROP: Silently discard the packet.  
REJECT: Discard the packet with sending back the packet such as ICMP port unreachable, TCP reset to originating host.  
LOG: Logging matching packet.  
MASQUERADE, SNAT, DNAT, REDIRECT: Address translation

### **Connection tracking**

To achieve more sophisticated firewall capability, Netfilter employs the connection tracking mechanism which keeps track of the state of all network traffic. Using the TCP connection state (refer to "Connection establishment" on page 30) and other network properties (such as IP address, port, protocol, sequence number, ack number, ICMP type etc.), Netfilter classifies each packet to the following four states.

NEW: packet attempting to establish new connection  
ESTABLISHED: packet goes through established connection  
RELATED: packet which is related to previous packets  
INVALID: packet which is unknown state due to malformed or invalid packet

In addition, Netfilter can use a separate module to perform more detailed connection tracking by analyzing protocol specific properties and operations. For example, there are connection tracking modules for FTP, NetBIOS, TFTP, IRC and so on.

## **1.5.2 TCP/IP**

TCP/IP has been default network protocol for many years. Linux TCP/IP implementation is fairly compliant with its standards. For better performance tuning, you should be familiar with basic TCP/IP networking.

For additional detail refer to the following documentation:

*TCP/IP Tutorial and Technical Overview, SG24-3376.*

### **Connection establishment**

Before application data is transferred, the connection should be established between client and server. The connection establishment process is called TCP/IP 3-way hand shake. Figure 1-27 on page 31 outlines basic connection establishment and termination process.

1. A client sends a SYN packet (a packet with SYN flag set) to its peer server to request connection.
2. The server receives the packet and sends back SYN+ACK packet
3. Then the client sends an ACK packet to its peer to complete connection establishment.

Once the connection is established, the application data can be transferred through the connection. When all data has been transferred, the connection closing process starts.

1. The client sends a FIN packet to the server to start the connection termination process.
2. The server sends the acknowledgement of the FIN back and then sends the FIN packet to the client if it has no data to send to the client.
3. Then the client sends an ACK packet to the server to complete connection termination.

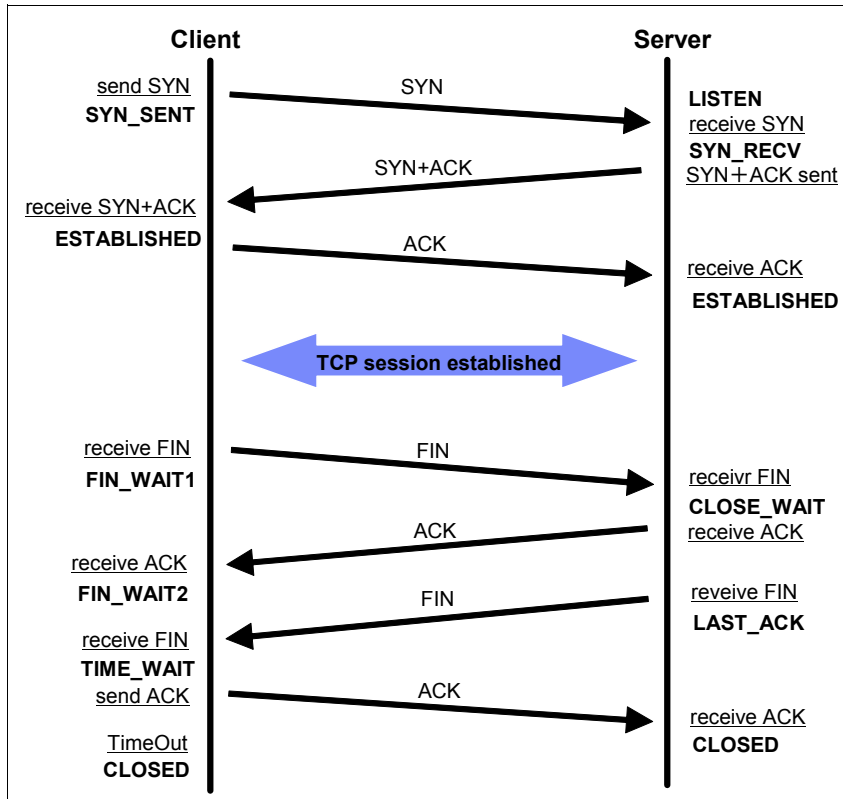

Figure 1-27 TCP 3-way handshake

The state of a connection changes during the session. Figure 1-28 on page 32 show the TCP/IP connection state diagram.

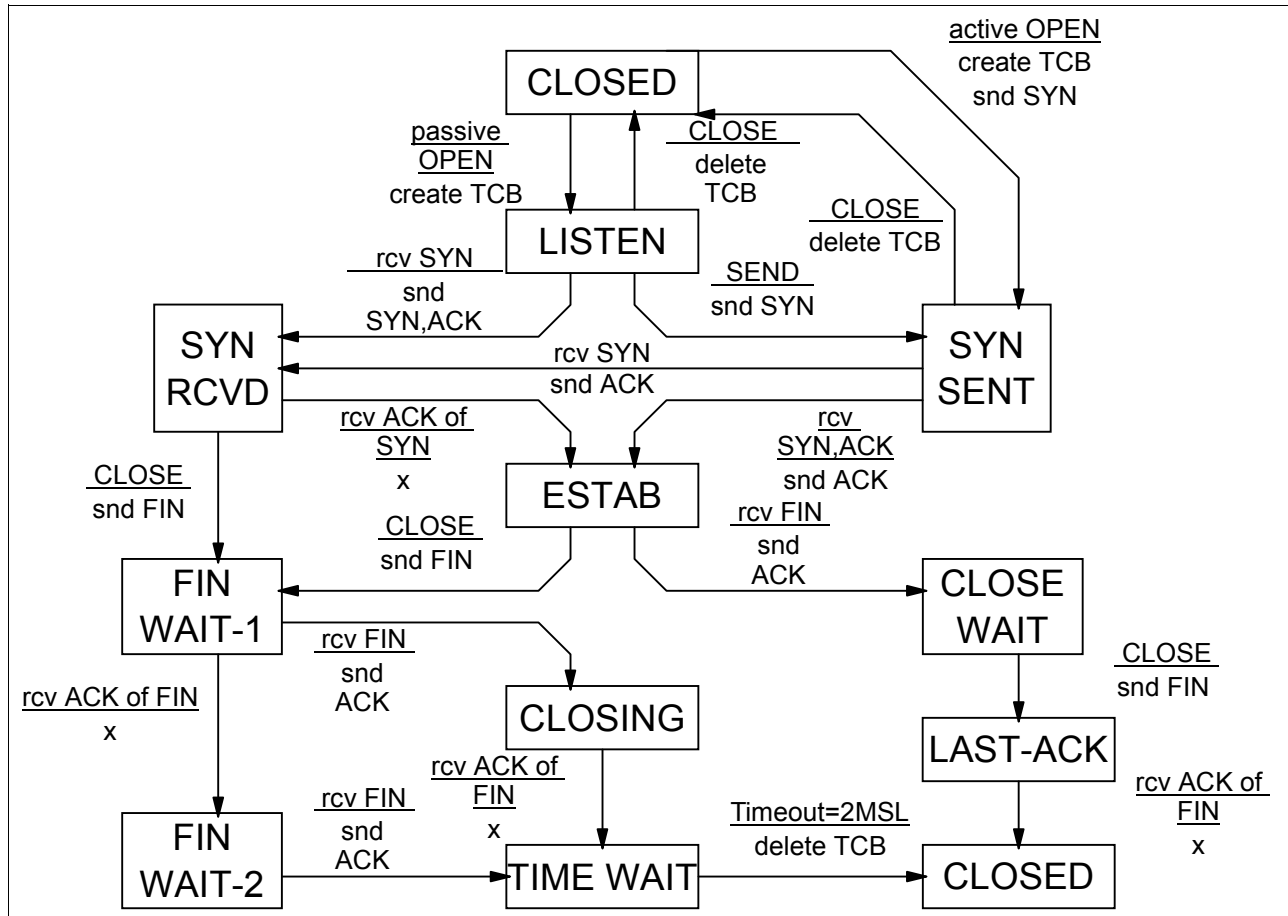

Figure 1-28 TCP connection state diagram

You can see the connection state of each TCP/IP session using **netstat** command. For more detail, see 2.3.11, “netstat” on page 53.

## Traffic control

TCP/IP implementation has a mechanism that ensures efficient data transfer and guarantees packet delivery even in time of poor network transmission quality and congestion.

### TCP/IP transfer window

The principle of transfer windows is an important aspect of the TCP/IP implementation in the Linux operating system in regard to performance. Very simplified, the TCP transfer window is the maximum amount of data a given host can send or receive before requiring an acknowledgement from the other side of the connection. The window size is offered from the receiving host to the sending host by the window size field in the TCP header. Using the transfer window, the host can send packets more effectively because the sending host doesn't have to wait for acknowledgement for each sending packet. It enables the network to be utilized more. Delayed acknowledgement also improve efficiency. TCP windows start small and increase slowly with every successful acknowledgement from the other side of the connection. To optimize window size, see 4.7.4, “Increasing network buffers” on page 127

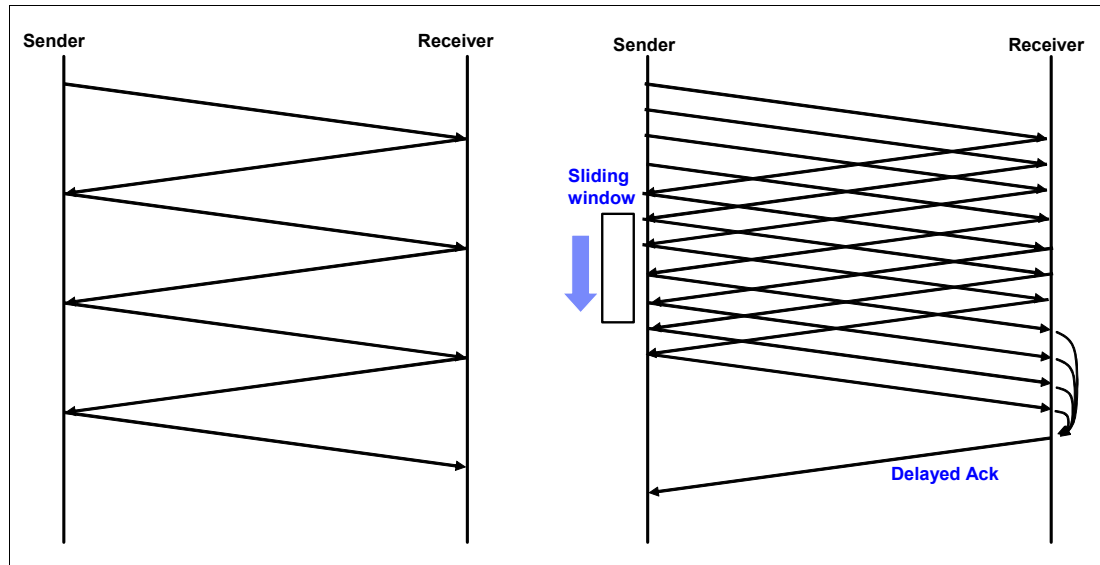

Figure 1-29 Sliding window and delayed ack

As an option, high-speed networks may use a technique called *window scaling* to increase the maximum transfer window size even more. We will analyze the effects of these implementations in more detail in “Tuning TCP options” on page 132.

### Retransmission

In the connection establishment and termination and data transfer, many timeouts and data retransmissions may be caused by various reasons (faulty network interface, slow router, network congestion, buggy network implementation, and so on). TCP/IP handles this situation by queuing packets and trying to send packets several times.

You can change some behavior of the kernel by configuring parameters. You may want to increase the number of attempts for TCP SYN connection establishment packet on the network with high rate of packet loss. You can also change some of timeout threshold through files under `/proc/sys/net`. For more information, see “Tuning TCP behavior” on page 131.

## 1.5.3 Offload

If the network adapter on your system supports hardware offload functionality, the kernel can offload part of its task to the adapter and it can reduce CPU utilization.

### ► Checksum offload

IP/TCP/UDP checksum is performed to make sure if the packet is correctly transferred by comparing the value of checksum field in protocol headers and the calculated values by the packet data.

### ► TCP segmentation offload (TSO)

When the data that is larger than supported maximum transmission unit (MTU) is sent to the network adapter, the data should be divided into MTU sized packets. The adapter takes care of that on behalf of the kernel.

For more advanced network features, refer to redbook *Tuning IBM System x Servers for Performance*, SG24-5287, section 10.3. Advanced network features.

## 1.5.4 Bonding module

The Linux kernel provides network interface aggregation capability by using a *bonding* driver. This is a device independent bonding driver, while there are device specific drivers as well. The bonding driver supports the 802.3 link aggregation specification and some original load balancing and fault tolerant implementations as well. It achieves a higher level of availability and performance improvement. Please refer to the kernel documentation [Documentation/networking/bonding.txt](#).

## 1.6 Understanding Linux performance metrics

Before we can look at the various tuning parameters and performance measurement utilities in the Linux operating system, it makes sense to discuss various available metrics and their meaning in regard to system performance. Because this is an open source operating system, a significant amount of performance measurement tools are available. The tool you ultimately choose will depend upon your personal liking and the amount of data and detail you require. Even though numerous tools are available, all performance measurement utilities measure the same metrics, so understanding the metrics enables you to use whatever utility you come across. Therefore, we cover only the most important metrics, understanding that many more detailed values are available that might be useful for detailed analysis beyond the scope of this paper.

### 1.6.1 Processor metrics

- ▶ CPU utilization  
This is probably the most straightforward metric. It describes the overall utilization per processor. On IBM System x architectures, if the CPU utilization exceeds 80% for a sustained period of time, a processor bottleneck is likely.
- ▶ User time  
Depicts the CPU percentage spent on user processes, including nice time. High values in user time are generally desirable because, in this case, the system performs actual work.
- ▶ System time  
Depicts the CPU percentage spent on kernel operations including IRQ and softirq time. High and sustained system time values can point you to bottlenecks in the network and driver stack. A system should generally spend as little time as possible in kernel time.
- ▶ Waiting  
Total amount of CPU time spent waiting for an I/O operation to occur. Like the *blocked* value, a system should not spend too much time waiting for I/O operations; otherwise you should investigate the performance of the respective I/O subsystem.
- ▶ Idle time  
Depicts the CPU percentage the system was idle waiting for tasks.
- ▶ Nice time  
Depicts the CPU percentage spent on re-nicing processes that change the execution order and priority of processes.
- ▶ Load average  
The load average is not a percentage, but the rolling average of the sum of the followings:
  - the number of processes in queue waiting to be processed
  - the number of processes waiting for uninterruptable task to be completed



That is, the average of the sum of TASK\_RUNNING and TASK\_UNINTERRUPTIBLE process. If processes that request CPU time are blocked (which means that the CPU has no time to process them), the load average will increase. On the other hand, if each process gets immediate access to CPU time and there are no CPU cycles lost, the load will decrease.

- ▶ **Runnable processes**

This value depicts the processes that are ready to be executed. This value should not exceed 10 times the amount of physical processors for a sustained period of time; otherwise a processor bottleneck is likely.

- ▶ **Blocked**

Processes that cannot execute as they are waiting for an I/O operation to finish. Blocked processes can point you toward an I/O bottleneck.

- ▶ **Context switch**

Amount of switches between threads that occur on the system. High numbers of context switches in connection with a large number of interrupts can signal driver or application issues. Context switches generally are not desirable because the CPU cache is flushed with each one, but some context switching is necessary. Refer to 1.1.5, “Context switching” on page 6.

- ▶ **Interrupts**

The interrupt value contains hard interrupts and soft interrupts; hard interrupts have more of an adverse effect on system performance. High interrupt values are an indication of a software bottleneck, either in the kernel or a driver. Remember that the interrupt value includes the interrupts caused by the CPU clock. Refer to 1.1.6, “Interrupt handling” on page 6

## 1.6.2 Memory metrics

- ▶ **Free memory**

Compared to most other operating systems, the free memory value in Linux should not be a cause for concern. As explained in 1.2.2, “Virtual memory manager” on page 13, the Linux kernel allocates most unused memory as file system cache, so subtract the amount of buffers and cache from the used memory to determine (effectively) free memory.

- ▶ **Swap usage**

This value depicts the amount of swap space used. As described in 1.2.2, “Virtual memory manager” on page 13, swap usage only tells you that Linux manages memory really efficiently. Swap In/Out is a reliable means of identifying a memory bottleneck. Values above 200 to 300 pages per second for a sustained period of time express a likely memory bottleneck.

- ▶ **Buffer and cache**

Cache allocated as file system and block device cache.

- ▶ **Slabs**

Depicts the kernel usage of memory. Note that kernel pages cannot be paged out to disk.

- ▶ **Active versus inactive memory**

Provides you with information about the active use of the system memory. Inactive memory is a likely candidate to be swapped out to disk by the kswapd daemon. Refer to “Page frame reclaiming” on page 14.

### 1.6.3 Network interface metrics

- ▶ Packets received and sent  
This metric informs you of the quantity of packets received and sent by a given network interface.
- ▶ Bytes received and sent  
This value depicts the number of bytes received and sent by a given network interface.
- ▶ Collisions per second  
This value provides an indication of the number of collisions that occur on the network the respective interface is connected to. Sustained values of collisions often concern a bottleneck in the network infrastructure, not the server. On most properly configured networks, collisions are very rare unless the network infrastructure consists of hubs.
- ▶ Packets dropped  
This is a count of packets that have been dropped by the kernel, either due to a firewall configuration or due to a lack in network buffers.
- ▶ Overruns  
Overruns represent the number of times that the network interface ran out of buffer space. This metric should be used in conjunction with the *packets dropped* value to identify a possible bottleneck in network buffers or the network queue length.
- ▶ Errors  
The number of frames marked as faulty. This is often caused by a network mismatch or a partially broken network cable. Partially broken network cables can be a significant performance issue for copper-based Gigabit networks.

### 1.6.4 Block device metrics

- ▶ I/O wait  
Time the CPU spends waiting for an I/O operation to occur. High and sustained values most likely indicate an I/O bottleneck.
- ▶ Average queue length  
Amount of outstanding I/O requests. In general, a disk queue of 2 to 3 is optimal; higher values might point toward a disk I/O bottleneck.
- ▶ Average wait  
A measurement of the average time in ms it takes for an I/O request to be serviced. The wait time consists of the actual I/O operation and the time it waited in the I/O queue.
- ▶ Transfers per second  
Depicts how many I/O operations per second are performed (reads and writes). The *transfers per second* metric in conjunction with the *kBytes per second* value helps you to identify the average transfer size of the system. The average transfer size generally should match with the stripe size used by your disk subsystem.
- ▶ Blocks read/write per second  
This metric depicts the reads and writes per second expressed in blocks of 1024 bytes as of kernel 2.6. Earlier kernels may report different block sizes, from 512 bytes to 4 KB.
- ▶ Kilobytes per second read/write  
Reads and writes from/to the block device in kilobytes represent the amount of actual data transferred to and from the block device.







## Monitoring and benchmark tools

The open and flexible nature of the Linux operating system has led to a significant number of performance monitoring tools. Some of them are Linux versions of well-known UNIX utilities, and others were specifically designed for Linux. The fundamental support for most Linux performance monitoring tools lays in the virtual proc file system. To measure performance, we also have to use appropriate benchmark tools.

In this chapter we outline a selection of Linux performance monitoring tools and discuss useful commands and we also introduce some of useful benchmark tools. It is up to the reader to select utilities to achieve the performance monitoring task.

Most of the monitoring tools we discuss ship with Enterprise Linux distributions.

## 2.1 Introduction

The Enterprise Linux distributions are shipped with many monitoring tools. Some of them deal with many metrics in a single tool and give us well formatted output for easy understanding of system activities. Some of them are specific to certain performance metrics (i.e. Disk I/O) and give us detailed information.

Being familiar with these tools will help to enhance your understand of what's going on in the system and to find the possible causes of a performance problem.

## 2.2 Overview of tool function

Table 2-1 lists the function of the monitoring tools covered in this chapter.

*Table 2-1 Linux performance monitoring tools*

<b>Tool</b>	<b>Most useful tool function</b>
top	Process activity
vmstat	System activity Hardware and system information
uptime, w	Average system load
ps, pstree	Displays the processes
free	Memory usage
iostat	Average CPU load, disk activity
sar	Collect and report system activity
mpstat	Multiprocessor usage
numastat	NUMA-related statistics
pmap	Process memory usage
netstat	Network statistics
iptraf	Real-time network statistics
tcpdump, ethereal	Detailed network traffic analysis
nmon	Collect and report system activity
strace	System calls
Proc file system	Various kernel statistics
KDE system guard	Real-time systems reporting and graphing
Gnome System Monitor	Real-time systems reporting and graphing

Table 2-2 lists the function of the benchmark tools covered in this chapter.

*Table 2-2 Benchmark tools*

<b>Tool</b>	<b>Most useful tool function</b>
Imbench	Microbenchmark for operating system functions
iozone	File system benchmark

Tool	Most useful tool function
netperf	Network performance benchmark

## 2.3 Monitoring tools

In this section, we discuss the monitoring tools. Most of the tools come with Enterprise Linux distributions. You should be familiar with the tools for better understanding of system behavior and performance tuning.

### 2.3.1 top

The **top** command shows actual process activity. By default, it displays the most CPU-intensive tasks running on the server and updates the list every five seconds. You can sort the processes by PID (numerically), age (newest first), time (cumulative time), and resident memory usage and time (time the process has occupied the CPU since startup).

*Example 2-1 Example output from the top command*

---

```
top - 02:06:59 up 4 days, 17:14,  2 users,  load average: 0.00, 0.00, 0.00
Tasks: 62 total,  1 running, 61 sleeping,  0 stopped,  0 zombie
Cpu(s):  0.2% us,  0.3% sy,  0.0% ni, 97.8% id,  1.7% wa,  0.0% hi,  0.0% si
Mem:   515144k total,  317624k used,  197520k free,  66068k buffers
Swap: 1048120k total,    12k used, 1048108k free,  179632k cached
```

PID	USER	PR	NI	VIRT	RES	SHR	S	%CPU	%MEM	TIME+	COMMAND
13737	root	17	0	1760	896	1540	R	0.7	0.2	0:00.05	top
238	root	5	-10	0	0	0	S	0.3	0.0	0:01.56	reiserfs/0
1	root	16	0	588	240	444	S	0.0	0.0	0:05.70	init
2	root	RT	0	0	0	0	S	0.0	0.0	0:00.00	migration/0
3	root	34	19	0	0	0	S	0.0	0.0	0:00.00	ksoftirqd/0
4	root	RT	0	0	0	0	S	0.0	0.0	0:00.00	migration/1
5	root	34	19	0	0	0	S	0.0	0.0	0:00.00	ksoftirqd/1
6	root	5	-10	0	0	0	S	0.0	0.0	0:00.02	events/0
7	root	5	-10	0	0	0	S	0.0	0.0	0:00.00	events/1
8	root	5	-10	0	0	0	S	0.0	0.0	0:00.09	kblockd/0
9	root	5	-10	0	0	0	S	0.0	0.0	0:00.01	kblockd/1
10	root	15	0	0	0	0	S	0.0	0.0	0:00.00	kirqd
13	root	5	-10	0	0	0	S	0.0	0.0	0:00.02	khelper/0
14	root	16	0	0	0	0	S	0.0	0.0	0:00.45	pdflush
16	root	15	0	0	0	0	S	0.0	0.0	0:00.61	kswapd0
17	root	13	-10	0	0	0	S	0.0	0.0	0:00.00	aio/0
18	root	13	-10	0	0	0	S	0.0	0.0	0:00.00	aio/1

---

You can further modify the processes using **renice** to give a new priority to each process. If a process hangs or occupies too much CPU, you can kill the process (**kill** command).

The columns in the output are:

- PID** Process identification.
- USER** Name of the user who owns (and perhaps started) the process.
- PRI** Priority of the process. (See 1.1.4, “Process priority and nice level” on page 5 for details.)

<b>NI</b>	Niceness level (that is, whether the process tries to be nice by adjusting the priority by the number given; see below for details).
<b>SIZE</b>	Amount of memory (code+data+stack) used by the process in kilobytes.
<b>RSS</b>	Amount of physical RAM used, in kilobytes.
<b>SHARE</b>	Amount of memory shared with other processes, in kilobytes.
<b>STAT</b>	State of the process: S=sleeping, R=running, T=stopped or traced, D=interruptible sleep, Z=zombie. The process state is discussed further in 1.1.7, "Process state".
<b>%CPU</b>	Share of the CPU usage (since the last screen update).
<b>%MEM</b>	Share of physical memory.
<b>TIME</b>	Total CPU time used by the process (since it was started).
<b>COMMAND</b>	Command line used to start the task (including parameters).

The top utility supports several useful hot keys, including:

<b>t</b>	Displays summary information off and on.
<b>m</b>	Displays memory information off and on.
<b>A</b>	Sorts the display by top consumers of various system resources. Useful for quick identification of performance-hungry tasks on a system.
<b>f</b>	Enters an interactive configuration screen for <b>top</b> . Helpful for setting up <b>top</b> for a specific task.
<b>o</b>	Enables you to interactively select the ordering within <b>top</b> .
<b>r</b>	Issues <b>renice</b> command
<b>k</b>	Issues <b>kill</b> command

## 2.3.2 vmstat

**vmstat** provides information about processes, memory, paging, block I/O, traps, and CPU activity. The **vmstat** command displays either average data or actual samples. The sampling mode is enabled by providing **vmstat** with a sampling frequency and a sampling duration.

**Attention:** In sampling mode consider the possibility of spikes between the actual data collection. Changing sampling frequency to a lower value may evade such hidden spikes.

*Example 2-2 Example output from vmstat*

```
[root@lnxsu4 ~]# vmstat 2
procs -----memory----- ---swap-- -----io----- --system-- -----cpu-----
r  b   swpd   free   buff  cache   si   so    bi   bo   in   cs  us  sy  id  wa
0  1     0 1742264 112116 1999864   0   0     1    4    3    3  0  0 99  0
0  1     0 1742072 112208 1999772   0   0     0 2536 1258 1146  0  1 75 24
0  1     0 1741880 112260 1999720   0   0     0 2668 1235 1002  0  1 75 24
0  1     0 1741560 112308 1999932   0   0     0 2930 1240 1015  0  1 75 24
1  1     0 1741304 112344 2000416   0   0     0 2980 1238  925  0  1 75 24
0  1     0 1741176 112384 2000636   0   0     0 2968 1233  929  0  1 75 24
0  1     0 1741304 112420 2000600   0   0     0 3024 1247  925  0  1 75 24
```

**Note:** The first data line of the **vmstat** report shows averages since the last reboot, so it should be eliminated.



The columns in the output are as follows:

<b>Process (procs)</b>	r: The number of processes waiting for runtime. b: The number of processes in uninterruptable sleep.
<b>Memory</b>	swpd: The amount of virtual memory used (KB). free: The amount of idle memory (KB). buff: The amount of memory used as buffers (KB). cache: The amount of memory used as cache (KB).
<b>Swap</b>	si: Amount of memory swapped from the disk (KBps). so: Amount of memory swapped to the disk (KBps).
<b>IO</b>	bi: Blocks sent to a block device (blocks/s). bo: Blocks received from a block device (blocks/s).
<b>System</b>	in: The number of interrupts per second, including the clock. cs: The number of context switches per second.
<b>CPU (% of total CPU time)</b>	us: Time spent running non-kernel code (user time, including nice time). sy: Time spent running kernel code (system time). id: Time spent idle. Prior to Linux 2.5.41, this included I/O-wait time. wa: Time spent waiting for IO. Prior to Linux 2.5.41, this appeared as zero.

The **vmstat** command supports a vast number of command line parameters that are fully documented in the man pages for **vmstat**. Some of the more useful flags include:

<b>-m</b>	displays the memory utilization of the kernel (slabs).
<b>-a</b>	provides information about active and inactive memory pages.
<b>-n</b>	displays only one header line, useful if running <b>vmstat</b> in sampling mode and piping the output to a file. (For example, <code>root#vmstat -n 2 10</code> generates <b>vmstat</b> 10 times with a sampling rate of two seconds.)

When used with the **-p** {partition} flag, **vmstat** also provides I/O statistics.

### 2.3.3 uptime

The **uptime** command can be used to see how long the server has been running and how many users are logged on, as well as for a quick overview of the average load of the server (Refer to 1.6.1, “Processor metrics” on page 34). The system load average is displayed for the past 1-minute, 5-minute, and 15-minute intervals.

The optimal value of the load is 1, which means that each process has immediate access to the CPU and there are no CPU cycles lost. The typical load can vary from system to system: For a uniprocessor workstation, 1 or 2 might be acceptable, whereas you will probably see values of 8 to 10 on multiprocessor servers.

You can use **uptime** to pinpoint a problem with your server or the network. For example, if a network application is running poorly, run **uptime** and you will see whether the system load is high. If not, the problem is more likely to be related to your network than to your server.

**Tip:** You can use **w** instead of **uptime**. **w** also provides information about who is currently logged on to the machine and what the user is doing.

*Example 2-3 Sample output of uptime*

---

```
1:57am up 4 days 17:05, 2 users, load average: 0.00, 0.00, 0.00
```

---

## 2.3.4 ps and pstree

The **ps** and **ps**tree commands are some of the most basic commands when it comes to system analysis. **ps** can have 3 different types of command options, UNIX style, BSD style and GNU style. Here we'll take UNIX style options.

The **ps** command provides a list of existing processes. The **top** command shows the process information as well, but **ps** will provide more detailed information. The number of processes listed depends on the options used. A simple **ps -A** command lists all processes with their respective process ID (PID) that can be crucial for further investigation. A PID number is necessary to use tools such as **pmap** or **renice**.

On systems running Java™ applications, the output of a **ps -A** command might easily fill up the display to the point where it is difficult to get a complete picture of all running processes. In this case, the **ps**tree command might come in handy as it displays the running processes in a tree structure and consolidates spawned subprocesses (for example, Java threads). The **ps**tree command can be very helpful to identify originating processes. There is another **ps** variant **pgrep**. It might be useful as well.

*Example 2-4 A sample ps output*

---

```
[root@bc1srv7 ~]# ps -A
  PID TTY          TIME CMD
    1 ?            00:00:00 init
    2 ?            00:00:00 migration/0
    3 ?            00:00:00 ksoftirqd/0
 2347 ?            00:00:00 sshd
 2435 ?            00:00:00 sendmail
27397 ?            00:00:00 sshd
27402 pts/0          00:00:00 bash
27434 pts/0          00:00:00 ps
```

---

We will take some useful options for detailed information.

- e All processes. identical to -A
- l Show long format
- F Extra full mode
- H Forest
- L Show threads, possibly with LWP and NLWP columns
- m Show threads after processes

Here's an example of the detailed output of the processes using following command:

```
ps -e1FL
```

*Example 2-5 An example of detailed output*

---

```
[root@lnxsu3 ~]# ps -e1FL
F S UID          PID  PPID  LWP  C  NLWP  PRI  NI  ADDR  SZ  WCHAN  RSS  PSR  STIME  TTY          TIME CMD
4 S root          1    0    1  0    1  76   0  -   457  -    552   0 Mar08 ?           00:00:01 init [3]
1 S root          2    1    2  0    1 -40   -  -    0 migrat  0   0 Mar08 ?           00:00:36 [migration/0]
1 S root          3    1    3  0    1  94  19  -    0 ksofti  0   0 Mar08 ?           00:00:00 [ksoftirqd/0]
```

```

1 S root      4      1      4 0      1 -40  - -      0 migrat  0  1 Mar08 ?      00:00:27 [migration/1]
1 S root      5      1      5 0      1 94 19 -      0 ksofti  0  1 Mar08 ?      00:00:00 [ksoftirqd/1]
1 S root      6      1      6 0      1 -40  - -      0 migrat  0  2 Mar08 ?      00:00:00 [migration/2]
1 S root      7      1      7 0      1 94 19 -      0 ksofti  0  2 Mar08 ?      00:00:00 [ksoftirqd/2]
1 S root      8      1      8 0      1 -40  - -      0 migrat  0  3 Mar08 ?      00:00:00 [migration/3]
1 S root      9      1      9 0      1 94 19 -      0 ksofti  0  3 Mar08 ?      00:00:00 [ksoftirqd/3]
1 S root     10      1     10 0      1 65 -10 -      0 worker  0  0 Mar08 ?      00:00:00 [events/0]
1 S root     11      1     11 0      1 65 -10 -      0 worker  0  1 Mar08 ?      00:00:00 [events/1]
1 S root     12      1     12 0      1 65 -10 -      0 worker  0  2 Mar08 ?      00:00:00 [events/2]
1 S root     13      1     13 0      1 65 -10 -      0 worker  0  3 Mar08 ?      00:00:00 [events/3]

5 S root     3493      1 3493 0      1 76  0 - 1889 -      4504  1 Mar08 ?      00:07:40 hald
4 S root     3502      1 3502 0      1 78  0 - 374 -      408  1 Mar08 tty1      00:00:00 /sbin/mingetty tty1
4 S root     3503      1 3503 0      1 78  0 - 445 -      412  1 Mar08 tty2      00:00:00 /sbin/mingetty tty2
4 S root     3504      1 3504 0      1 78  0 - 815 -      412  2 Mar08 tty3      00:00:00 /sbin/mingetty tty3
4 S root     3505      1 3505 0      1 78  0 - 373 -      412  1 Mar08 tty4      00:00:00 /sbin/mingetty tty4
4 S root     3506      1 3506 0      1 78  0 - 569 -      412  3 Mar08 tty5      00:00:00 /sbin/mingetty tty5
4 S root     3507      1 3507 0      1 78  0 - 585 -      412  0 Mar08 tty6      00:00:00 /sbin/mingetty tty6
0 S takech   3509      1 3509 0      1 76  0 - 718 -      1080  0 Mar08 ?      00:00:00 /usr/libexec/gam_server
0 S takech   4057      1 4057 0      1 75  0 - 1443 -      1860  0 Mar08 ?      00:00:01 xscreensaver -nosplash
4 S root     4239      1 4239 0      1 75  0 - 5843 -      9180  1 Mar08 ?      00:00:01 /usr/bin/metacity
--sm-client-id=default1
0 S takech   4238      1 4238 0      1 76  0 - 3414 -      5212  2 Mar08 ?      00:00:00 /usr/bin/metacity
--sm-client-id=default1
4 S root     4246      1 4246 0      1 76  0 - 5967 -      12112  2 Mar08 ?      00:00:00 gnome-panel
--sm-client-id=default2
0 S takech   4247      1 4247 0      1 77  0 - 5515 -      11068  0 Mar08 ?      00:00:00 gnome-panel
--sm-client-id=default2
0 S takech   4249      1 4249 0      9 76  0 - 10598 -      17520  1 Mar08 ?      00:00:01 nautilus
--no-default-window --sm-client-id=default3
1 S takech   4249      1 4282 0      9 75  0 - 10598 -      17520  0 Mar08 ?      00:00:00 nautilus
--no-default-window --sm-client-id=default3
1 S takech   4249      1 4311 0      9 75  0 - 10598 322565 17520  0 Mar08 ?      00:00:00 nautilus
--no-default-window --sm-client-id=default3
1 S takech   4249      1 4312 0      9 75  0 - 10598 322565 17520  0 Mar08 ?      00:00:00 nautilus
--no-default-window --sm-client-id=default3

```

The columns in the output are:

<b>F</b>	Process flag
<b>S</b>	State of the process: S=sleeping, R=running, T=stopped or traced, D=interruptable sleep, Z=zombie. The process state is discussed further in Chapter 1.1.7, "Process state" on page 7.
<b>UID</b>	Name of the user who owns (and perhaps started) the process.
<b>PID</b>	Process ID number
<b>PPID</b>	Parent process ID number
<b>LWP</b>	LWP(light weight process, or thread) ID of the lwp being reported.
<b>C</b>	Integer value of the processor utilization percentage.(CPU usage)
<b>NLWP</b>	Number of lwps (threads) in the process. (alias thcount).
<b>PRI</b>	Priority of the process. (See 1.1.4, "Process priority and nice level" on page 5 for details.)
<b>NI</b>	Niceness level (that is, whether the process tries to be nice by adjusting the priority by the number given; see below for details).
<b>ADDR</b>	Process Address space (not displayed)
<b>SZ</b>	Amount of memory (code+data+stack) used by the process in kilobytes.

<b>WCHAN</b>	Name of the kernel function in which the process is sleeping, a "-" if the process is running, or a "*" if the process is multi-threaded and ps is not displaying threads.
<b>RSS</b>	Resident set size, the non-swapped physical memory that a task has used (in kiloBytes).
<b>PSR</b>	Processor that process is currently assigned to.
<b>STIME</b>	Time the command started.
<b>TTY</b>	Terminal
<b>TIME</b>	Total CPU time used by the process (since it was started).
<b>CMD</b>	Command line used to start the task (including parameters).

### Thread information

You can see the thread information using **ps -L** option.

#### Example 2-6 thread information with ps -L

```
[root@edam ~]# ps -eLF | grep -E "LWP|/usr/sbin/httpd"
UID      PID  PPID  LWP  C  NLWP   SZ  RSS  PSR  STIME  TTY      TIME  CMD
root     4504   1  4504  0   1  4313 8600  2  08:33 ?        00:00:00 /usr/sbin/httpd
apache  4507  4504  4507  0   1  4313 4236  1  08:33 ?        00:00:00 /usr/sbin/httpd
apache  4508  4504  4508  0   1  4313 4228  1  08:33 ?        00:00:00 /usr/sbin/httpd
apache  4509  4504  4509  0   1  4313 4228  0  08:33 ?        00:00:00 /usr/sbin/httpd
apache  4510  4504  4510  0   1  4313 4228  3  08:33 ?        00:00:00 /usr/sbin/httpd

[root@edam ~]# ps -eLF | grep -E "LWP|/usr/sbin/httpd"
UID      PID  PPID  LWP  C  NLWP   SZ  RSS  PSR  STIME  TTY      TIME  CMD
root     4632   1  4632  0   1  3640 7772  2  08:44 ?        00:00:00 /usr/sbin/httpd.worker
apache  4635  4632  4635  0  27 72795 5352  3  08:44 ?        00:00:00 /usr/sbin/httpd.worker
apache  4635  4632  4638  0  27 72795 5352  1  08:44 ?        00:00:00 /usr/sbin/httpd.worker
apache  4635  4632  4639  0  27 72795 5352  3  08:44 ?        00:00:00 /usr/sbin/httpd.worker
apache  4635  4632  4640  0  27 72795 5352  3  08:44 ?        00:00:00 /usr/sbin/httpd.worker
```

## 2.3.5 free

The command **/bin/free** displays information about the total amounts of free and used memory (including swap) on the system. It also includes information about the buffers and cache used by the kernel.

#### Example 2-7 Example output from the free command

	total	used	free	shared	buffers	cached
Mem:	1291980	998940	293040	0	89356	772016
-/+ buffers/cache:		137568	1154412			
Swap:	2040244	0	2040244			

When using **free**, remember the Linux memory architecture and the way the virtual memory manager works. The amount of free memory in itself is of limited use, and the pure utilization statistics of swap are no indication for a memory bottleneck.

Figure 2-1 on page 47 depicts basic idea of what **free** command output shows.

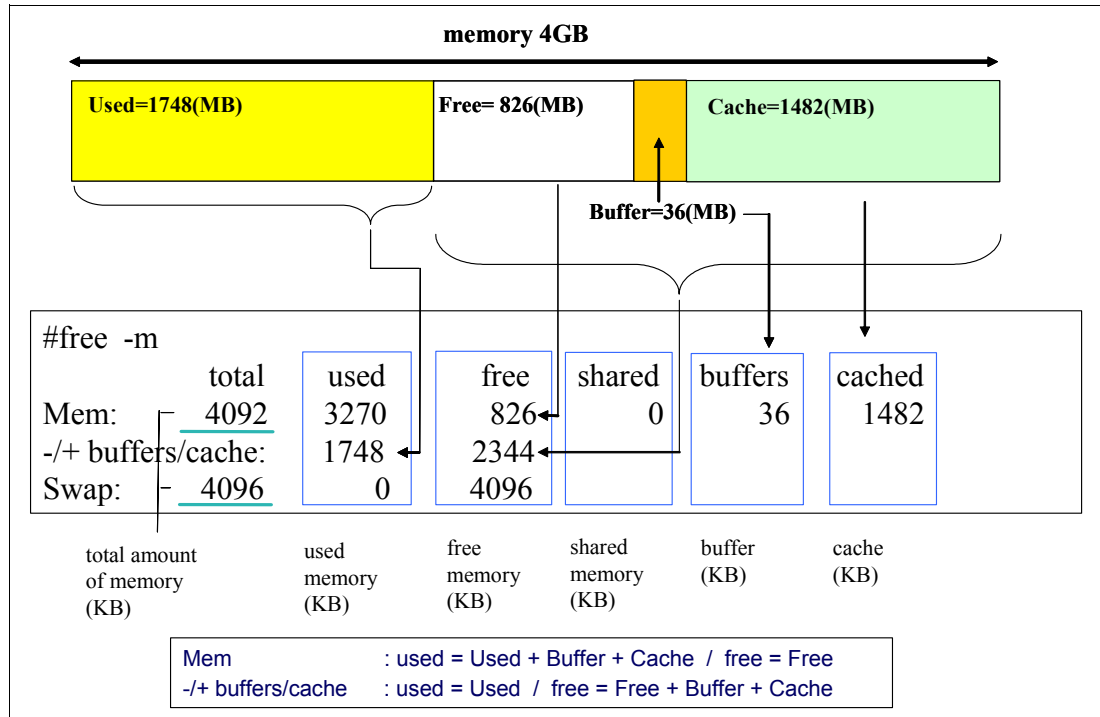

Figure 2-1 free command output

Useful parameters for the `free` command include:

- b, -k, -m, -g display values in bytes, kilobytes, megabytes, and gigabytes.
- l distinguishes between low and high memory (refer to 1.2, “Linux memory architecture” on page 11).
- c <count> displays the free output <count> number of times.

## Memory used in a zone

Using the `-l` option, you can see how much memory is used in each memory zone. Example 2-8 and Example 2-9 show the example of `free -l` output of 32 bit and 64 bit system. Notice that 64-bit system no longer use High memory.

*Example 2-8 Example output from the free command on 32 bit version kernel*

```
[root@edam ~]# free -l
              total          used          free      shared    buffers     cached
Mem:          4154484      2381500      1772984           0       108256     1974344
Low:           877828       199436       678392
High:         3276656      2182064      1094592
-/+ buffers/cache:      298900      3855584
Swap:         4194296           0       4194296
```

*Example 2-9 Example output from the free command on 64 bit version kernel*

```
[root@lnxsu4 ~]# free -l
              total          used          free      shared    buffers     cached
Mem:          4037420      138508      3898912           0         10300     42060
Low:          4037420      138508      3898912
High:           0           0           0
-/+ buffers/cache:       86148      3951272
```

```
Swap:      2031608      332      2031276
```

---

You can also determine much chunks of memory are available in each zone using `/proc/buddyinfo` file. Each column of numbers means the number of pages of that order which are available. In Example 2-10, there are 5 chunks of  $2^2 * \text{PAGE\_SIZE}$  available in `ZONE_DMA`, and 16 chunks of  $2^4 * \text{PAGE\_SIZE}$  available in `ZONE_DMA32`. Remember how the buddy system allocate pages (refer to “Buddy system” on page 14). This information show you how fragmented memory is and give you a clue as to how much pages you can safely allocate.

*Example 2-10 Buddy system information for 64 bit system*

---

```
[root@lnxsu5 ~]# cat /proc/buddyinfo
Node 0, zone  DMA      1      3      5      4      6      1      1      0      2      0      2
Node 0, zone  DMA32    56     14      2     16      7      3      1      7     41     42    670
Node 0, zone  Normal    0      6      3      2      1      0      1      0      0      0      1      0
```

---

### 2.3.6 iostat

The **iostat** command shows average CPU times since the system was started (similar to **uptime**). It also creates a report of the activities of the disk subsystem of the server in two parts: CPU utilization and device (disk) utilization. To use **iostat** to perform detailed I/O bottleneck and performance tuning, see 3.4.1, “Finding disk bottlenecks” on page 84. The **iostat** utility is part of the **sysstat** package.

*Example 2-11 Sample output of iostat*

---

```
Linux 2.4.21-9.0.3.EL (x232)  05/11/2004

avg-cpu:  %user   %nice   %sys   %idle
           0.03    0.00    0.02   99.95

Device:            tps   Blk_read/s   Blk_wrtn/s   Blk_read   Blk_wrtn
dev2-0              0.00         0.00         0.04         203         2880
dev8-0              0.45         2.18         2.21       166464       168268
dev8-1              0.00         0.00         0.00          16           0
dev8-2              0.00         0.00         0.00           8           0
dev8-3              0.00         0.00         0.00         344           0
```

---

The CPU utilization report has four sections:

- %user** Shows the percentage of CPU utilization that was taken up while executing at the user level (applications).
- %nice** Shows the percentage of CPU utilization that was taken up while executing at the user level with a nice priority. (Priority and nice levels are described in 2.3.7, “nice, renice” on page 67.)
- %sys** Shows the percentage of CPU utilization that was taken up while executing at the system level (kernel).
- %idle** Shows the percentage of time the CPU was idle.

The device utilization report has these sections:

- Device** The name of the block device.

**tps** The number of transfers per second (I/O requests per second) to the device. Multiple single I/O requests can be combined in a transfer request, because a transfer request can have different sizes.

**Blk\_read/s, Blk\_wrtn/s**

Blocks read and written per second indicate data read from or written to the device in seconds. Blocks may also have different sizes. Typical sizes are 1024, 2048, and 4048 bytes, depending on the partition size. For example, the block size of /dev/sda1 can be found with:

```
dumpe2fs -h /dev/sda1 |grep -F "Block size"
```

This produces output similar to:

```
dumpe2fs 1.34 (25-Jul-2003)
Block size:                1024
```

**Blk\_read, Blk\_wrtn**

Indicates the total number of blocks read and written since the boot.

The **iostat** can take many options. The most useful one is **-x** option from the performance perspective. It displays extended statistics. The following is sample output.

*Example 2-12 iostat -x extended statistics display*

---

```
[root@lnxsu4 ~]# iostat -d -x sdb 1
Linux 2.6.9-42.ELsmp (lnxsu4.itso.ra1.ibm.com) 03/18/2007
```

Device:	rrqm/s	wrqm/s	r/s	w/s	rsec/s	wsec/s	rkB/s	wkB/s	avgrq-sz	avgqu-sz	await	svctm	%util
sdb	0.15	0.00	0.02	0.00	0.46	0.00	0.23	0.00	29.02	0.00	2.60	1.05	0.00

---

**rrqm/s, wrqm/s**

The number of read/write requests merged per second that were issued to the device. Multiple single I/O requests can be merged in a transfer request, because a transfer request can have different sizes.

**r/s, w/s**

The number of read/write requests that were issued to the device per second.

**rsec/s, wsec/s** The number of sectors read/write from the device per second.

**rkB/s, wkB/s** The number of kilobytes read/write from the device per second.

**avgrq-sz** The average size of the requests that were issued to the device. This value is displayed in sectors.

**avgqu-sz** The average queue length of the requests that were issued to the device.

**await** Shows the percentage of CPU utilization that was taken up while executing at the system level (kernel).

**svctm** The average service time (in milliseconds) for I/O requests that were issued to the device.

**%util** Percentage of CPU time during which I/O requests were issued to the device (bandwidth utilization for the device). Device saturation occurs when this value is close to 100%.

It may be very useful to calculate the average I/O size in order to tailor a disk subsystem towards the access pattern. The following example is the output of using **iostat** with the **-d** and **-x** flag in order to display only information about the disk subsystem of interest:

*Example 2-13 Using iostat -x -d to analyze the average I/O size*

---

Device:	rrqm/s	wrqm/s	r/s	w/s	rsec/s	wsec/s	rkB/s	wkB/s	avgrq-sz	avgqu-sz	await	svctm	%util
dasdc	0.00	0.00	0.00	2502.97	0.00	24601.98	0.00	12300.99	9.83	142.93	57.08	0.40	100.00

---

The `iostat` output in Example 2-13 shows that the device `dasdc` had to write 12300.99 kB of data per second as being displayed under the `kB_wrtn/s` heading. This amount of data was being sent to the disk subsystem in 2502.97 I/Os as shown under `w/s` in the example above. The average I/O size or average request size is displayed under `avgrq-sz` and is 9.83 blocks of 512 byte in our example. For `async` writes the average I/O size is usually some odd number. However most applications perform read and write I/O in multiples of 4kB (for instance 4kB, 8kB, 16kB, 32kB and so on). In the example above the application was issuing nothing but random write requests of 4kB, however `iostat` shows a average request size 4.915kB. The difference is caused by the Linux file system that even though we were performing random writes found some I/Os that could be merged together for more efficient flushing out to the disk subsystem.

**Note:** When using the default `async` mode for file systems, only the average request size displayed in `iostat` is correct. Even though applications perform write requests at distinct sizes, the I/O layer of Linux will most likely merge and hence alter the average I/O size.

### 2.3.7 sar

The `sar` command is used to collect, report, and save system activity information. The `sar` command consists of three applications: `sar`, which displays the data, and `sa1` and `sa2`, which are used for collecting and storing the data. The `sar` tool features a wide range of options so be sure to check the man page for it. The `sar` utility is part of the `sysstat` package.

With `sa1` and `sa2`, the system can be configured to get information and log it for later analysis.

**Tip:** We suggest that you have `sar` running on most if not all of your systems. In case of a performance problem, you will have very detailed information at hand at very small overhead and no additional cost.

To accomplish this, add the lines to `/etc/crontab` (Example 2-14). Keep in mind that a default `cron` job running `sar` daily is set up automatically after installing `sar` on your system.

*Example 2-14 Example of starting automatic log reporting with cron*

---

```
# 8am-7pm activity reports every 10 minutes during weekdays.
*/10 8-18 * * 1-5 /usr/lib/sa/sa1 600 6 &
# 7pm-8am activity reports every an hour during weekdays.
0 19-7 * * 1-5 /usr/lib/sa/sa1 &
# Activity reports every an hour on Saturday and Sunday.
0 * * * 0,6 /usr/lib/sa/sa1 &
# Daily summary prepared at 19:05
5 19 * * * /usr/lib/sa/sa2 -A &
```

---

The raw data for the `sar` tool is stored under `/var/log/sa/` where the various files represent the days of the respective month. To examine your results, select the weekday of the month and the requested performance data. For example, to display the network counters from the 21st, use the command `sar -n DEV -f sa21` and pipe it to `less` as in Example 2-15.



*Example 2-15 Displaying system statistics with sar*

---

```
[root@linux sa]# sar -n DEV -f sa21 | less
Linux 2.6.9-5.ELsmp (linux.itso.ra1.ibm.com)    04/21/2005
```

Time	IFACE	rxpck/s	txpck/s	rxbyt/s	txbyt/s	rxcmp/s	txcmp/s	rxmcst/s
12:00:01 AM								
12:10:01 AM	lo	0.00	0.00	0.00	0.00	0.00	0.00	0.00
12:10:01 AM	eth0	1.80	0.00	247.89	0.00	0.00	0.00	0.00
12:10:01 AM	eth1	0.00	0.00	0.00	0.00	0.00	0.00	0.00

---

You can also use **sar** to run near-real-time reporting from the command line (Example 2-16).

*Example 2-16 Ad hoc CPU monitoring*

---

```
[root@x232 root]# sar -u 3 10
Linux 2.4.21-9.0.3.EL (x232)    05/22/2004
```

Time	CPU	%user	%nice	%system	%idle
02:10:40 PM					
02:10:43 PM	all	0.00	0.00	0.00	100.00
02:10:46 PM	all	0.33	0.00	0.00	99.67
02:10:49 PM	all	0.00	0.00	0.00	100.00
02:10:52 PM	all	7.14	0.00	18.57	74.29
02:10:55 PM	all	71.43	0.00	28.57	0.00
02:10:58 PM	all	0.00	0.00	100.00	0.00
02:11:01 PM	all	0.00	0.00	0.00	0.00
02:11:04 PM	all	0.00	0.00	100.00	0.00
02:11:07 PM	all	50.00	0.00	50.00	0.00
02:11:10 PM	all	0.00	0.00	100.00	0.00
Average:	all	1.62	0.00	3.33	95.06

---

From the collected data, you see a detailed overview of CPU utilization (%user, %nice, %system, %idle), memory paging, network I/O and transfer statistics, process creation activity, activity for block devices, and interrupts/second over time.

## 2.3.8 mpstat

The **mpstat** command is used to report the activities of each of the available CPUs on a multiprocessor server. Global average activities among all CPUs are also reported. The **mpstat** utility is part of the **sysstat** package.

The **mpstat** utility enables you to display overall CPU statistics per system or per processor. **mpstat** also enables the creation of statistics when used in sampling mode analogous to the **vmstat** command with a sampling frequency and a sampling count. Example 2-17 shows a sample output created with **mpstat -P ALL** to display average CPU utilization per processor.

*Example 2-17 Output of mpstat command on multiprocessor system*

---

```
[root@linux ~]# mpstat -P ALL
Linux 2.6.9-5.ELsmp (linux.itso.ra1.ibm.com)    04/22/2005
```

Time	CPU	%user	%nice	%system	%iowait	%irq	%soft	%idle	intr/s
03:19:21 PM									
03:19:21 PM	all	0.03	0.00	0.34	0.06	0.02	0.08	99.47	1124.22
03:19:21 PM	0	0.03	0.00	0.33	0.03	0.04	0.15	99.43	612.12
03:19:21 PM	1	0.03	0.00	0.36	0.10	0.01	0.01	99.51	512.09

---

To display three entries of statistics for all processors of a multiprocessor server at one-second intervals, use the command:

```
mpstat -P ALL 1 2
```

*Example 2-18 Output of mpstat command on two-way machine*

---

```
[root@linux ~]# mpstat -P ALL 1 2
Linux 2.6.9-5.ELsmp (linux.itso.ral.ibm.com)    04/22/2005

03:31:51 PM CPU    %user   %nice %system %iowait  %irq   %soft   %idle   intr/s
03:31:52 PM all    0.00   0.00  0.00   0.00   0.00   0.00  100.00  1018.81
03:31:52 PM 0     0.00   0.00  0.00   0.00   0.00   0.00  100.00   991.09
03:31:52 PM 1     0.00   0.00  0.00   0.00   0.00   0.00  99.01   27.72

Average:   CPU    %user   %nice %system %iowait  %irq   %soft   %idle   intr/s
Average:   all    0.00   0.00  0.00   0.00   0.00   0.00  100.00  1031.89
Average:   0     0.00   0.00  0.00   0.00   0.00   0.00  100.00   795.68
Average:   1     0.00   0.00  0.00   0.00   0.00   0.00  99.67   236.54
```

---

For the complete syntax of the **mpstat** command, issue:

```
mpstat -?
```

## 2.3.9 numastat

With Non-Uniform Memory Architecture (NUMA) systems such as the IBM System x 3950, NUMA architectures have become mainstream in enterprise data centers. However, NUMA systems introduce new challenges to the performance tuning process: Topics such as memory locality were of no interest until NUMA systems arrived. Luckily, Enterprise Linux distributions provides a tool for monitoring the behavior of NUMA architectures. The **numastat** command provides information about the ratio of local versus remote memory usage and the overall memory configuration of all nodes. Failed allocations of local memory as displayed in the `numa_miss` column and allocations of remote memory (slower memory) as displayed in the `numa_foreign` column should be investigated. Excessive allocation of remote memory will increase system latency and most likely decrease overall performance. Binding processes to a node with the memory map in the local RAM will most likely improve performance.

*Example 2-19 Sample output of the numastat command*

---

```
[root@linux ~]# numastat

                node1          node0
numa_hit         76557759        92126519
numa_miss        30772308        30827638
numa_foreign     30827638        30772308
interleave_hit   106507          103832
local_node       76502227        92086995
other_node       30827840        30867162
```

---

### 2.3.10 pmap

The **pmap** command reports the amount of memory that one or more processes are using. You can use this tool to determine which processes on the server are being allocated memory and

whether this amount of memory is a cause of memory bottlenecks. For detailed information, use **pmap -d** option.

```
pmap -d <pid>
```

*Example 2-20 Process memory information the init process is using*

---

```
[root@lnxsu4 ~]# pmap -d 1
1:  init [3]
Address          Kbytes Mode  Offset          Device      Mapping
000000000400000  36 r-x-- 000000000000000 0fd:0000  init
000000000508000  8  rw--- 000000000000800 0fd:0000  init
00000000050a000 132 rwx-- 00000000050a000 000:0000  [ anon ]
0000002a9555600  4  rw--- 0000002a9555600 000:0000  [ anon ]
0000002a9557400  8  rw--- 0000002a9557400 000:0000  [ anon ]
00000030c300000  84 r-x-- 000000000000000 0fd:0000  ld-2.3.4.so
00000030c311400  8  rw--- 000000000014000 0fd:0000  ld-2.3.4.so
00000030c320000 1196 r-x-- 000000000000000 0fd:0000  libc-2.3.4.so
00000030c332b00 1024 ----- 00000000012b000 0fd:0000  libc-2.3.4.so
00000030c342b00  8  r---- 00000000012b000 0fd:0000  libc-2.3.4.so
00000030c342d00 12  rw--- 00000000012d000 0fd:0000  libc-2.3.4.so
00000030c343000 16  rw--- 00000030c343000 000:0000  [ anon ]
00000030c370000  56 r-x-- 000000000000000 0fd:0000  libsepol.so.1
00000030c370e00 1020 ----- 00000000000e000 0fd:0000  libsepol.so.1
00000030c380d00  4  rw--- 00000000000d000 0fd:0000  libsepol.so.1
00000030c380e00  32  rw--- 00000030c380e00 000:0000  [ anon ]
00000030c450000  56 r-x-- 000000000000000 0fd:0000  libselinux.so.1
00000030c450e00 1024 ----- 00000000000e000 0fd:0000  libselinux.so.1
00000030c460e00  4  rw--- 00000000000e000 0fd:0000  libselinux.so.1
00000030c460f00  4  rw--- 00000030c460f00 000:0000  [ anon ]
0000007fbfffc00 16  rw--- 0000007fbfffc00 000:0000  [ stack ]
ffffffff600000  8192 ----- 000000000000000 000:0000  [ anon ]
mapped: 12944K  writeable/private: 248K  shared: 0K
```

---

Some of the most important information is at the bottom of the display. The line shows:

mapped:           total amount of memory mapped to files used in the process

writable/private: the amount of private address space this process is taking.

shared:           the amount of address space this process is sharing with others.

You can also take a look at the address spaces where the information is stored. You can find an interesting difference when you issue the **pmap** command on 32-bit and 64-bit systems. For the complete syntax of the **pmap** command, issue:

```
pmap -?
```

### 2.3.11 netstat

**netstat** is one of the most popular tools. If you work on the network, you should be familiar with this tool. It displays a lot of network related information such as socket usage, routing, interface, protocol, network statistics etc. Here are some of the basic options:

- a       Show all socket information
- r       Show routing information
- i       Show network interface statistics
- s       Show network protocol statistics

There are many other useful options. Please check man page. The following example displays sample output of socket information.

*Example 2-21 Showing socket information with netstat*

---

```
[root@lnxsu5 ~]# netstat -natuw
Active Internet connections (servers and established)
Proto Recv-Q Send-Q Local Address           Foreign Address         State
tcp      0      0 0.0.0.0:111             0.0.0.0:*               LISTEN
tcp      0      0 127.0.0.1:25            0.0.0.0:*               LISTEN
tcp      0      0 127.0.0.1:2207         0.0.0.0:*               LISTEN
tcp      0      0 127.0.0.1:36285        127.0.0.1:12865         TIME_WAIT
tcp      0      0 10.0.0.5:37322         10.0.0.4:33932          TIME_WAIT
tcp      0      1 10.0.0.5:55351         10.0.0.4:33932          SYN_SENT
tcp      0      1 10.0.0.5:55350         10.0.0.4:33932          LAST_ACK
tcp      0      0 10.0.0.5:64093         10.0.0.4:33932          TIME_WAIT
tcp      0      0 10.0.0.5:35122         10.0.0.4:12865          ESTABLISHED
tcp      0      0 10.0.0.5:17318         10.0.0.4:33932          TIME_WAIT
tcp      0      0 :::22                  :::*                     LISTEN
tcp      0 2056 :::ffff:192.168.0.254:22  :::ffff:192.168.0.1:3020 ESTABLISHED
udp      0      0 0.0.0.0:111            0.0.0.0:*               *
udp      0      0 0.0.0.0:631            0.0.0.0:*               *
udp      0      0 :::5353                :::*                     *
```

---

#### Socket information

<b>Proto</b>	The protocol (tcp, udp, raw) used by the socket.
<b>Recv-Q</b>	The count of bytes not copied by the user program connected to this socket.
<b>Send-Q</b>	The count of bytes not acknowledged by the remote host.
<b>Local Address</b>	Address and port number of the local end of the socket. Unless the --numeric (-n) option is specified, the socket address is resolved to its canonical host name (FQDN), and the port number is translated into the corresponding service name.
<b>Foreign Address</b>	Address and port number of the remote end of the socket.
<b>State</b>	The state of the socket. Since there are no states in raw mode and usually no states used in UDP, this column may be left blank. For possible states, see Figure 1-28, "TCP connection state diagram" on page 32 and man page.

### 2.3.12 iptraf

**iptraf** monitors TCP/IP traffic in a real time manner and generates real time reports. It shows TCP/IP traffic statistics by each session, by interface and by protocol. The **iptraf** utility is provided by iptraf package.

The **iptraf** give us some reports like following

- ▶ IP traffic monitor: Network traffic statistics by TCP connection
- ▶ General interface statistics: IP traffic statistics by network interface
- ▶ Detailed interface statistics: Network traffic statistics by protocol
- ▶ Statistical breakdowns: Network traffic statistics by TCP/UDP port and by packet size
- ▶ LAN station monitor: Network traffic statistics by Layer2 address

Following are a few of the reports **iptraf** generates.

```

IPTraf
| Statistics for eth0
x
x
x      Total      Total      Incoming      Incoming      Outgoing      Outgoing
x      Packets    Bytes      Packets      Bytes      Packets      Bytes
x Total:      118      31308      52           3800      66           27508
x IP:         118      29410      52           2826      66           26584
x TCP:        110      28500      44           1916      66           26584
x UDP:         8         910       8            910       0            0
x ICMP:        0          0         0             0         0            0
x Other IP:    0          0         0             0         0            0
x Non-IP:     0          0         0             0         0            0
x
x
x Total rates:                               Broadcast packets:      8
x                                          Broadcast bytes:      1022
x
x Incoming rates:
x
x Outgoing rates:                               IP checksum errors:    0
x

```

Figure 2-2 *iptraf* output of TCP/IP statistics by protocol

```

IPTraf
| Packet Distribution by Size
x
x Packet size brackets for interface eth0
x
x
x Packet Size (bytes)      Count      Packet Size (bytes)      Count
x 1 to 75:                 1021      751 to 825:              0
x 76 to 150:               338       826 to 900:              0
x 151 to 225:              1381     901 to 975:              0
x 226 to 300:               18       976 to 1050:             0
x 301 to 375:               2        1051 to 1125:            0
x 376 to 450:               0        1126 to 1200:            0
x 451 to 525:               0        1201 to 1275:            0
x 526 to 600:               0        1276 to 1350:            0
x 601 to 675:               0        1351 to 1425:            7
x 676 to 750:               0        1426 to 1500+:          0
x
x
x Interface MTU is 1500 bytes, not counting the data-link header
x Maximum packet size is the MTU plus the data-link header length
x Packet size computations include data-link headers, if any
x

```

Figure 2-3 *iptraf* output of TCP/IP traffic statistics by packet size

### 2.3.13 tcpdump / ethereal

The **tcpdump** and **ethereal** are used to capture and analyze network traffic. Both tool uses the libpcap library to capture packets. They monitor all the traffic on a network adapter with promiscuous mode and capture all the frames the adapter has received. To capture all the packets, these commands should be executed with super user privilege to make the interface promiscuous mode.

You can use these tools to dig into the network related problems. You can find TCP/IP retransmission, windows size scaling, name resolution problem, network misconfiguration etc. Just keep in mind that these tools can monitor only frames the network adapter has received, not entire network traffic.

## tcpdump

**tcpdump** is a simple but robust utility. It also has basic protocol analyzing capability allowing you to get rough picture of what is happening on the network. **tcpdump** supports many options and flexible expressions for filtering the frames to be captured (capture filter). We'll take a look at this below.

Options:

- i <interface> Network interface
- e Print the link-level header
- s <snaplen> Capture <snaplen> bytes from each packet
- n Avoid DNS lookup
- w <file> Write to file
- r <file> Read from file
- v, -vv, -vvv Vervose output

Expressions for the capture filter:

Keywords:

host dst, src, port, src port, dst port, tcp, udp, icmp, net, dst net, src net etc.

Primitives may be combined using:

Negation ('!' or 'not').

Concatenation ('&&' or 'and').

Alternation ('||' or 'or').

Example of some useful expressions:

- ▶ DNS query packets
 

```
tcpdump -i eth0 'udp port 53'
```
- ▶ FTP control and FTP data session to 192.168.1.10
 

```
tcpdump -i eth0 'dst 192.168.1.10 and (port ftp or ftp-data)'
```
- ▶ HTTP session to 192.168.2.253
 

```
tcpdump -ni eth0 'dst 192.168.2.253 and tcp and port 80'
```
- ▶ Telnet session to subnet 192.168.2.0/24
 

```
tcpdump -ni eth0 'dst net 192.168.2.0/24 and tcp and port 22'
```
- ▶ Packets for which the source and destination is not in subnet 192.168.1.0/24 with TCP SYN or TCP FIN flags on (TCP establishment or termination)
 

```
tcpdump 'tcp[tcpflags] & (tcp-syn|tcp-fin) != 0 and not src and dst net 192.168.1.0/24'
```

*Example 2-22* Example of tcpdump output

---

```

21:11:49.555340 10.1.1.1.2542 > 66.218.71.102.http: S 2657782764:2657782764(0) win 65535 <mss 1460,nop,nop,sack0K> (DF)
21:11:49.671811 66.218.71.102.http > 10.1.1.1.2542: S 2174620199:2174620199(0) ack 2657782765 win 65535 <mss 1380>
21:11:51.211869 10.1.1.18.2543 > 216.239.57.99.http: S 2658253720:2658253720(0) win 65535 <mss 1460,nop,nop,sack0K> (DF)
21:11:51.332371 216.239.57.99.http > 10.1.1.1.2543: S 3685788750:3685788750(0) ack 2658253721 win 8190 <mss 1380>
21:11:56.972822 10.1.1.1.2545 > 129.42.18.99.http: S 2659714798:2659714798(0) win 65535 <mss 1460,nop,nop,sack0K> (DF)
21:11:57.133615 129.42.18.99.http > 10.1.1.1.2545: S 2767811014:2767811014(0) ack 2659714799 win 65535 <mss 1348>
21:11:57.656919 10.1.1.1.2546 > 129.42.18.99.http: S 2659939433:2659939433(0) win 65535 <mss 1460,nop,nop,sack0K> (DF)
21:11:57.818058 129.42.18.99.http > 9.116.198.48.2546: S 1261124983:1261124983(0) ack 2659939434 win 65535 <mss 1348>

```

---

Refer to the man pages for more detail.

**ethereal**

**ethereal** has quite similar functionality to **tcpdump** but is more sophisticated and has advanced protocol analyzing and reporting capability. It also has a GUI interface as well as a command line interface using the **ethereal** command which is part of a **ethereal** package.

Like **tcpdump**, the capture filter can be used and it also support the display filter. It can be used to narrow down the frames. We'll show you some examples of useful expression here.

## ▶ IP

```

ip.version == 6 and ip.len > 1450
ip.addr == 129.111.0.0/16
ip.dst eq www.example.com and ip.src == 192.168.1.1
not ip.addr eq 192.168.4.1

```

## ▶ TCP/UDP

```

tcp.port eq 22
tcp.port == 80 and ip.src == 192.168.2.1
tcp.dstport == 80 and (tcp.flags.syn == 1 or tcp.flags.fin == 1)
tcp.srcport == 80 and (tcp.flags.syn == 1 and tcp.flags.ack == 1)
tcp.dstport == 80 and tcp.flags == 0x12
tcp.options.mss_val == 1460 and tcp.option.sack == 1

```

## ▶ Application

```

http.request.method == "POST"
smb.path contains \\SERVER\SHARE

```

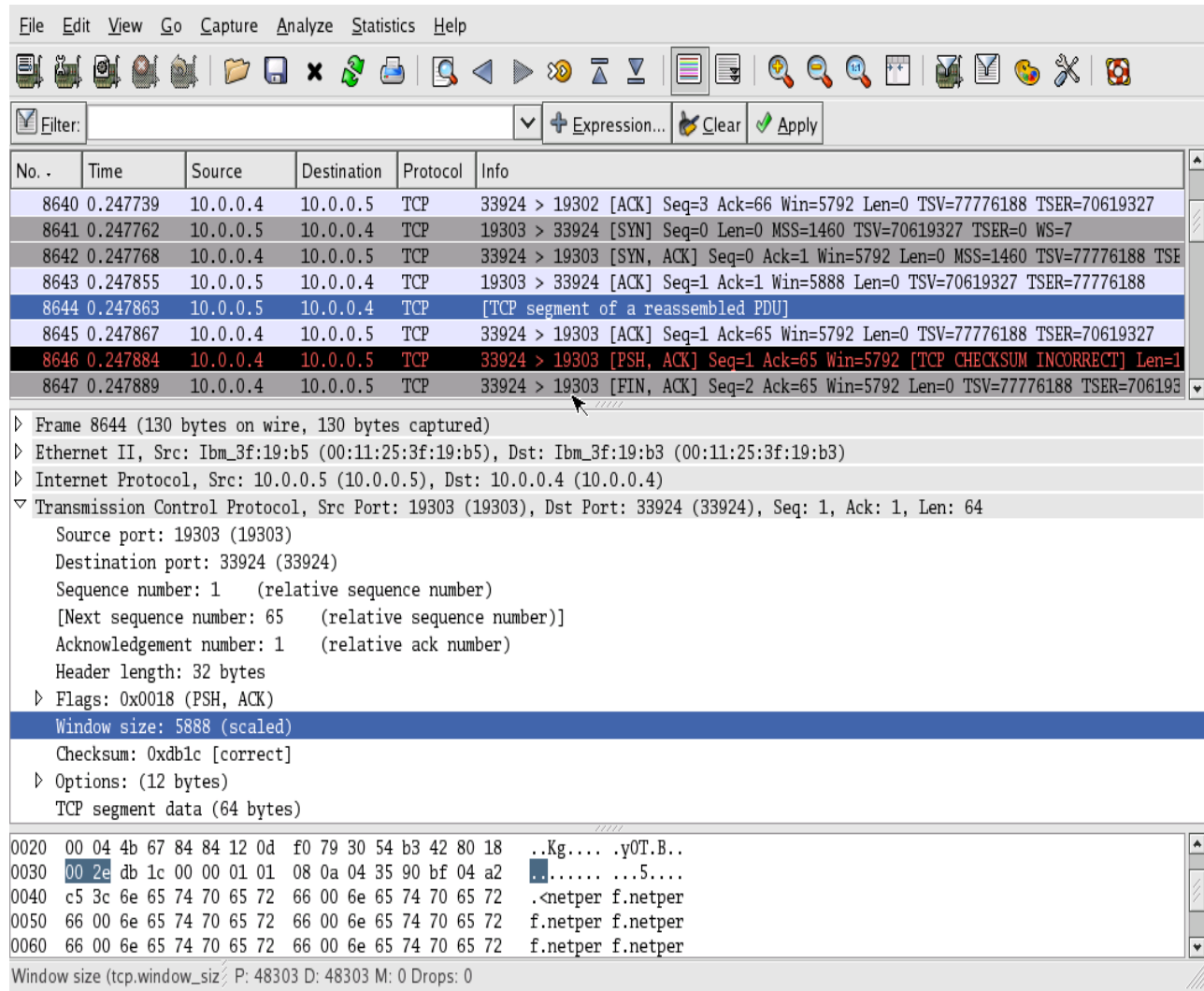

Figure 2-4 ethereal GUI

### 2.3.14 nmon

**nmon**, short for Nigel's Monitor, is a popular tool to monitor Linux systems performance developed by Nigel Griffiths. Since **nmon** incorporates the performance information for several subsystems, it can be used as a single source for performance monitoring. Some of the tasks that can be achieved with **nmon** include processor utilization, memory utilization, run queue information, disks I/O statistics, network I/O statistics, paging activity and process metrics.

In order to run **nmon**, simply start the tool and select the subsystems of interest by typing their one-key commands. For example, to get CPU, memory, and disk statistics, start **nmon** and type **c m d**.

A very nice feature of **nmon** is the possibility to save performance statistics for later analysis in a comma separated values (CSV) file. The CSV output of **nmon** can be imported into a spreadsheet application in order to produce graphical reports. In order to do so **nmon** should be started with the **-f** flag (see **nmon -h** for the details). For example running **nmon** for an hour capturing data snapshots every 30 seconds would be achieved using the command in Example 2-23 on page 59.



*Example 2-23 Using nmon to record performance data*

---

```
# nmon -f -s 30 -c 120
```

---

The output of the above command will be stored in a text file in the current directory named <hostname>\_date\_time.nmon.

For more information on nmon we suggest you visit

<http://www-941.haw.ibm.com/collaboration/wiki/display/WikiPtype/nmon>

In order to download nmon, visit

<http://www.ibm.com/collaboration/wiki/display/WikiPtype/nmonanalyser>

### 2.3.15 strace

The **strace** command intercepts and records the system calls that are called by a process, as well as the signals that are received by a process. This is a useful diagnostic, instructional, and debugging tool. System administrators find it valuable for solving problems with programs.

To trace a process, specify the process ID (PID) to be monitored:

```
strace -p <pid>
```

Example 2-24 shows an example of the output of **strace**.

*Example 2-24 Output of strace monitoring httpd process*

---

```
[root@x232 html]# strace -p 815
Process 815 attached - interrupt to quit
semop(360449, 0xb73146b8, 1) = 0
poll([{fd=4, events=POLLIN}, {fd=3, events=POLLIN, revents=POLLIN}], 2, -1) = 1
accept(3, {sa_family=AF_INET, sin_port=htons(52534), sin_addr=inet_addr("192.168.1.1")}, [16]) = 13
semop(360449, 0xb73146be, 1) = 0
getsockname(13, {sa_family=AF_INET, sin_port=htons(80), sin_addr=inet_addr("192.168.1.2")}, [16]) = 0
fcntl164(13, F_GETFL) = 0x2 (flags O_RDWR)
fcntl164(13, F_SETFL, O_RDWR|O_NONBLOCK) = 0
read(13, 0x8259bc8, 8000) = -1 EAGAIN (Resource temporarily unavailable)
poll([{fd=13, events=POLLIN, revents=POLLIN}], 1, 300000) = 1
read(13, "GET /index.html HTTP/1.0\r\nUser-A"... , 8000) = 91
gettimeofday({1084564126, 750439}, NULL) = 0
stat64("/var/www/html/index.html", {st_mode=S_IFREG|0644, st_size=152, ...}) = 0
open("/var/www/html/index.html", O_RDONLY) = 14
mmap2(NULL, 152, PROT_READ, MAP_SHARED, 14, 0) = 0xb7052000
writev(13, [{"HTTP/1.1 200 OK\r\nDate: Fri, 14 M"... , 264}, {"<html>\n<title>\n RedPaper Per"... , 152}], 2) = 416
munmap(0xb7052000, 152) = 0
socket(PF_UNIX, SOCK_STREAM, 0) = 15
connect(15, {sa_family=AF_UNIX, path="/var/run/.nscd_socket"}, 110) = -1 ENOENT (No such file or directory)
close(15) = 0
```

---

**Attention:** While the **strace** command is running against a process, the performance of the PID is drastically reduced and should only be run for the time of data collection.

Here's another interesting usage. This command reports how much time has been consumed in the kernel by each system call to execute a command.

```
strace -c <command>
```

*Example 2-25 Output of strace counting for system time*

---

```
[root@lnxsu4 ~]# strace -c find /etc -name httpd.conf
/etc/httpd/conf/httpd.conf
Process 3563 detached
```

% time	seconds	usecs/call	calls	errors	syscall
25.12	0.026714	12	2203		getdents64
25.09	0.026689	8	3302		lstat64
17.20	0.018296	8	2199		chdir
9.05	0.009623	9	1109		open
8.06	0.008577	8	1108		close
7.50	0.007979	7	1108		fstat64
7.36	0.007829	7	1100		fcntl64
0.19	0.000205	205	1		execve
0.13	0.000143	24	6		read
0.08	0.000084	11	8		old_mmap
0.05	0.000048	10	5		mmap2
0.04	0.000040	13	3		munmap
0.03	0.000035	35	1		write
0.02	0.000024	12	2	1	access
0.02	0.000020	10	2		mprotect
0.02	0.000019	6	3		brk
0.01	0.000014	7	2		fchdir
0.01	0.000009	9	1		time
0.01	0.000007	7	1		uname
0.01	0.000007	7	1		set_thread_area
100.00	0.106362		12165	1	total

---

For the complete syntax of the **strace** command, issue:

```
strace -?
```

### 2.3.16 Proc file system

The proc file system is not a real file system, but nevertheless is extremely useful. It is not intended to store data; rather, it provides an interface to the running kernel. The proc file system enables an administrator to monitor and change the kernel on the fly. Figure 2-5 depicts a sample proc file system. Most Linux tools for performance measurement rely on the information provided by /proc.

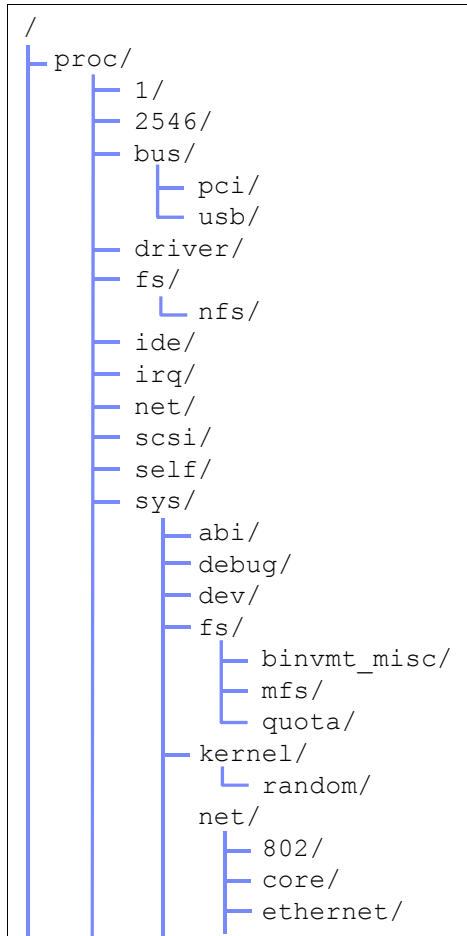

Figure 2-5 A sample /proc file system

Looking at the proc file system, we can distinguish several subdirectories that serve various purposes, but because most of the information in the proc directory is not easily readable to the human eye, you are encouraged to use tools such as **vmstat** to display the various statistics in a more readable manner. Keep in mind that the layout and information contained within the proc file system varies across different system architectures.

► Files in the /proc directory

The various files in the root directory of proc refer to several pertinent system statics. Here you can find information taken by Linux tools such as **vmstat** and **cpuinfo** as the source of their output.

► Numbers 1 to X

The various subdirectories represented by numbers refer to the running processes or their respective process ID (PID). The directory structure always starts with PID 1, which refers to the init process, and goes up to the number of PIDs running on the respective system. Each numbered subdirectory stores statistics related to the process. One example of such data is the virtual memory mapped by the process.

► acpi

ACPI refers to the advanced configuration and power interface supported by most modern desktop and laptop systems. Because ACPI is mainly a PC technology, it is often disabled on server systems. For more information about ACPI refer to:

<http://www.apci.info>

- ▶ bus  
This subdirectory contains information about the bus subsystems such as the PCI bus or the USB interface of the respective system.
- ▶ irq  
The irq subdirectory contains information about the interrupts in a system. Each subdirectory in this directory refers to an interrupt and possibly to an attached device such as a network interface card. In the irq subdirectory, you can change the CPU affinity of a given interrupt (a feature we cover later in this book).
- ▶ net  
The net subdirectory contains a significant number of raw statistics regarding your network interfaces, such as received multicast packets or the routes per interface.
- ▶ scsi  
This subdirectory contains information about the SCSI subsystem of the respective system, such as attached devices or driver revision. The subdirectory ips refers to the IBM ServeRAID controllers found on most IBM System x servers.
- ▶ sys  
In the sys subdirectory you find the tunable kernel parameters such as the behavior of the virtual memory manager or the network stack. We cover the various options and tunable values in `/proc/sys` in 4.3, “Changing kernel parameters” on page 104.
- ▶ tty  
The tty subdirectory contains information about the respective virtual terminals of the systems and to what physical devices they are attached.

### 2.3.17 KDE System Guard

KDE System Guard (KSysguard) is the KDE task manager and performance monitor. It features a client/server architecture that enables monitoring of local and remote hosts.

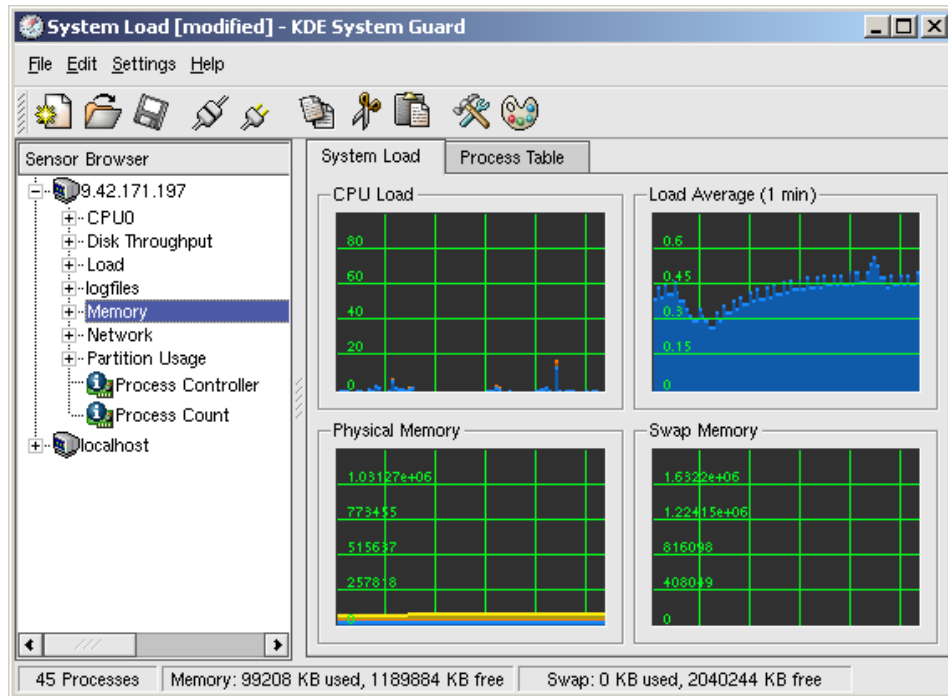

Figure 2-6 Default KDE System Guard window

The graphical front end (Figure 2-6) uses *sensors* to retrieve the information it displays. A sensor can return simple values or more complex information such as tables. For each type of information, one or more displays are provided. Displays are organized in worksheets that can be saved and loaded independent of each other.

The KSysguard main window consists of a menu bar, an optional tool bar and status bar, the sensor browser, and the work space. When first started, you see the default setup: your local machine listed as `localhost` in the sensor browser and two tabs in the work space area.

Each sensor monitors a certain system value. All of the displayed sensors can be dragged and dropped into the work space. There are three options:

- ▶ You can delete and replace sensors in the actual work space.
- ▶ You can edit worksheet properties and increase the number of rows and columns.
- ▶ You can create a new worksheet and drop new sensors meeting your needs.

## Work space

The work space in Figure 2-7 shows two tabs:

- ▶ System Load, the default view when first starting up KSysguard
- ▶ Process Table

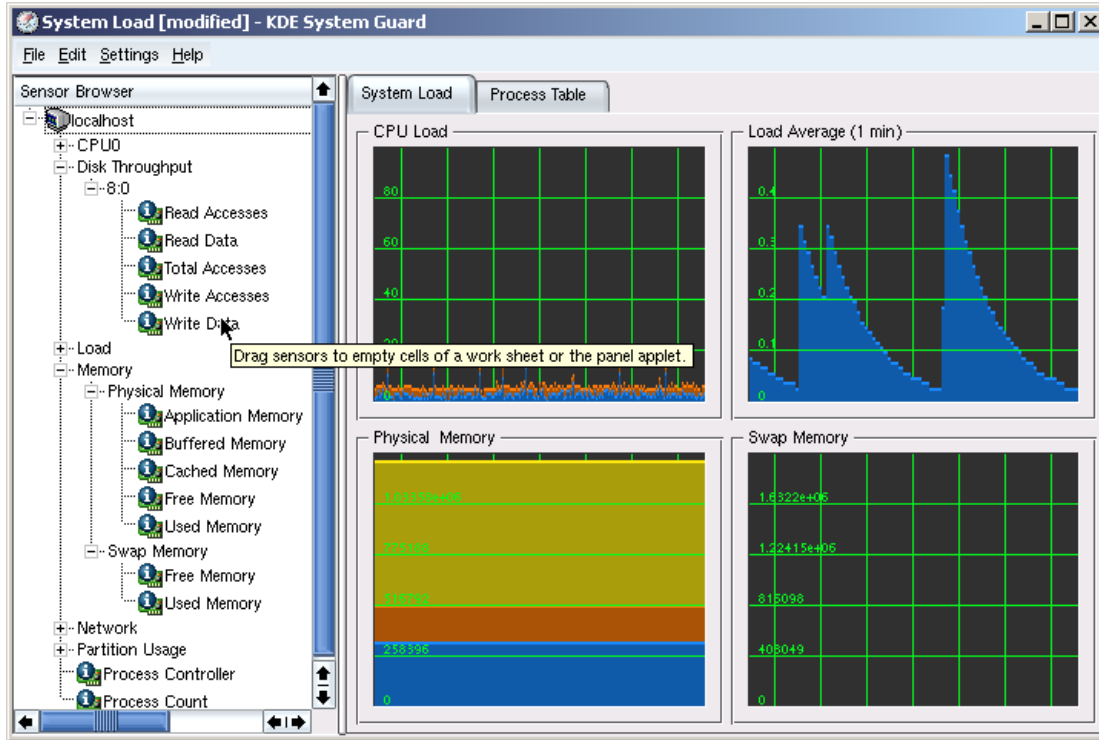

Figure 2-7 KDE System Guard sensor browser

### System Load

The System Load worksheet shows four sensor windows: CPU Load, Load Average (1 Min), Physical Memory, and Swap Memory. Multiple sensors can be displayed in one window. To see which sensors are being monitored in a window, mouse over the graph and descriptive text will appear. You can also right-click the graph and click **Properties**, then click the **Sensors** tab (Figure 2-8). This also shows a key of what each color represents on the graph.

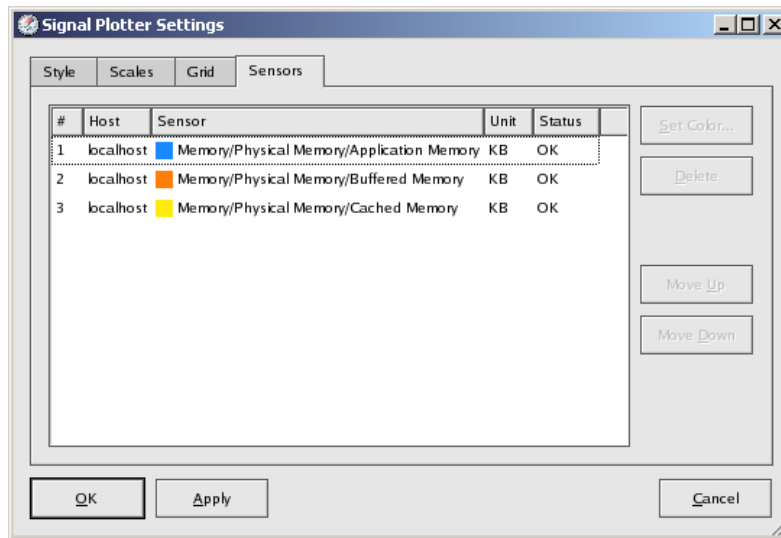

Figure 2-8 Sensor Information, Physical Memory Signal Plotter

## Process Table

Clicking the **Process Table** tab displays information about all running processes on the server (Figure 2-9). The table, by default, is sorted by System CPU utilization, but this can be changed by clicking another one of the headings.

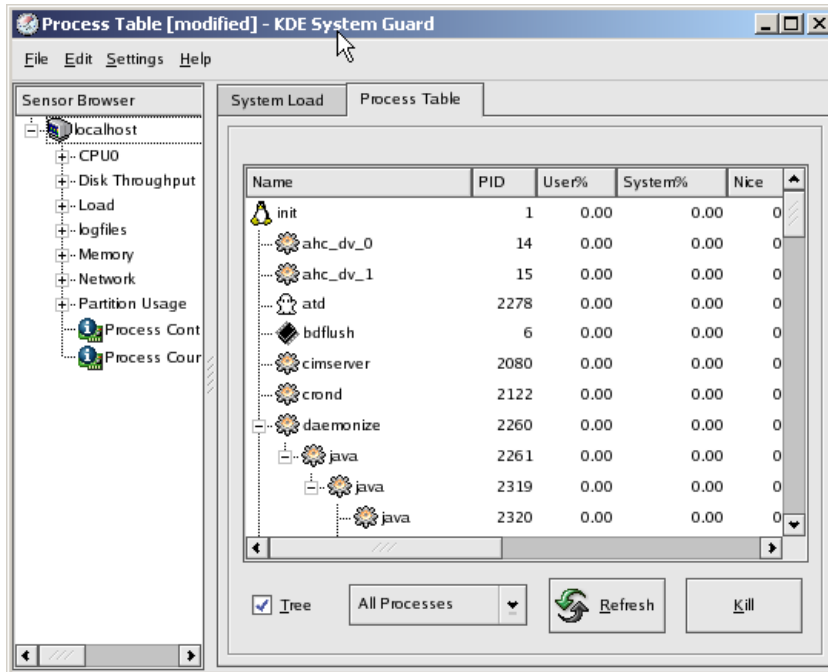

Figure 2-9 Process Table view

## Configuring a work sheet

For your environment or the particular area that you wish to monitor, you might have to use different sensors for monitoring. The best way to do this is to create a custom work sheet. In this section, we guide you through the steps that are required to create the work sheet shown in Figure 2-12 on page 67:

1. Create a blank worksheet by clicking **File** → **New** to open the window in Figure 2-10.

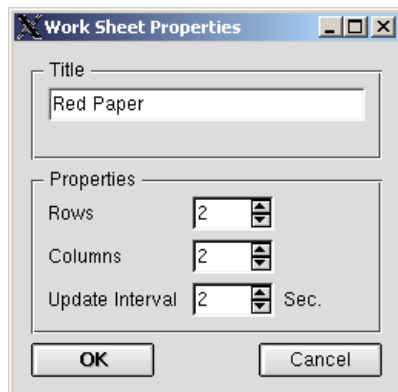

Figure 2-10 Properties for new worksheet

2. Enter a title and a number of rows and columns; this gives you the maximum number of monitor windows, which in our case will be four. When the information is complete, click **OK** to create the blank worksheet, as shown in Figure 2-11 on page 66.

**Note:** The fastest update interval that can be defined is two seconds.

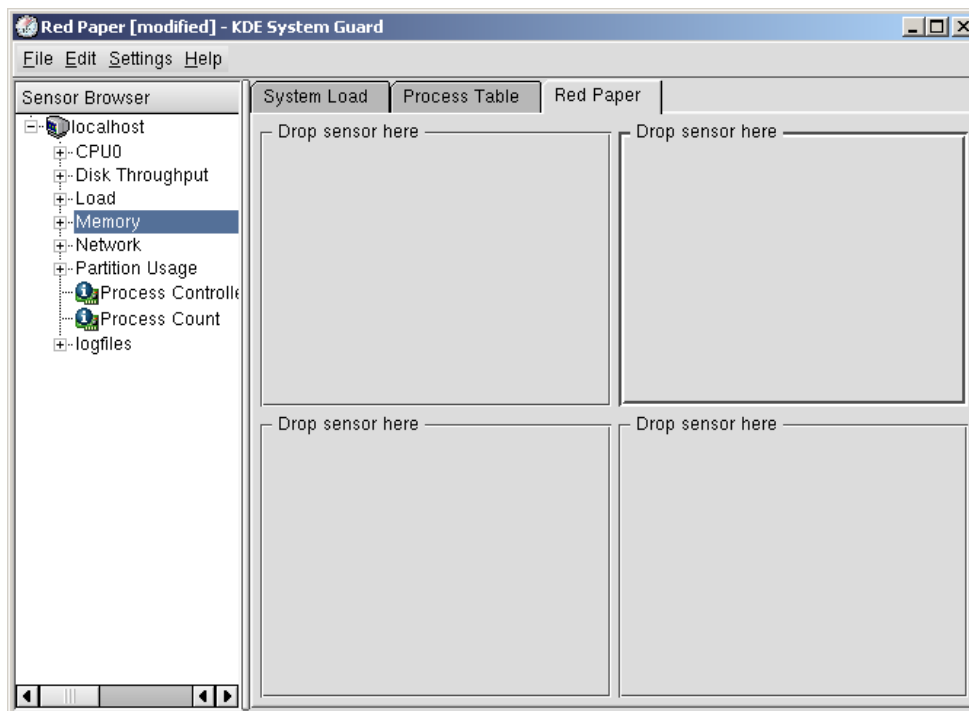

Figure 2-11 Empty worksheet

3. Fill in the sensor boxes by dragging the sensors on the left side of the window to the desired box on the right. The types of display are:

- Signal Plotter: This displays samples of one or more sensors over time. If several sensors are displayed, the values are layered in different colors. If the display is large enough, a grid will be displayed to show the range of the plotted samples.

By default, the automatic range mode is active, so the minimum and maximum values will be set automatically. If you want fixed minimum and maximum values, you can deactivate the automatic range mode and set the values in the Scales tab from the Properties dialog window (which you access by right-clicking the graph).

- Multimeter: This displays the sensor values as a digital meter. In the Properties dialog, you can specify a lower and upper limit. If the range is exceeded, the display is colored in the alarm color.
- BarGraph: This displays the sensor value as dancing bars. In the Properties dialog, you can specify the minimum and maximum values of the range and a lower and upper limit. If the range is exceeded, the display is colored in the alarm color.
- Sensor Logger: This does not display any values, but logs them in a file with additional date and time information.

For each sensor, you have to define a target log file, the time interval the sensor will be logged, and whether alarms are enabled.

4. Click **File** → **Save** to save the changes to the worksheet.

**Note:** When you save a work sheet, it will be saved in the user's home directory, which may prevent other administrators from using your custom worksheets.



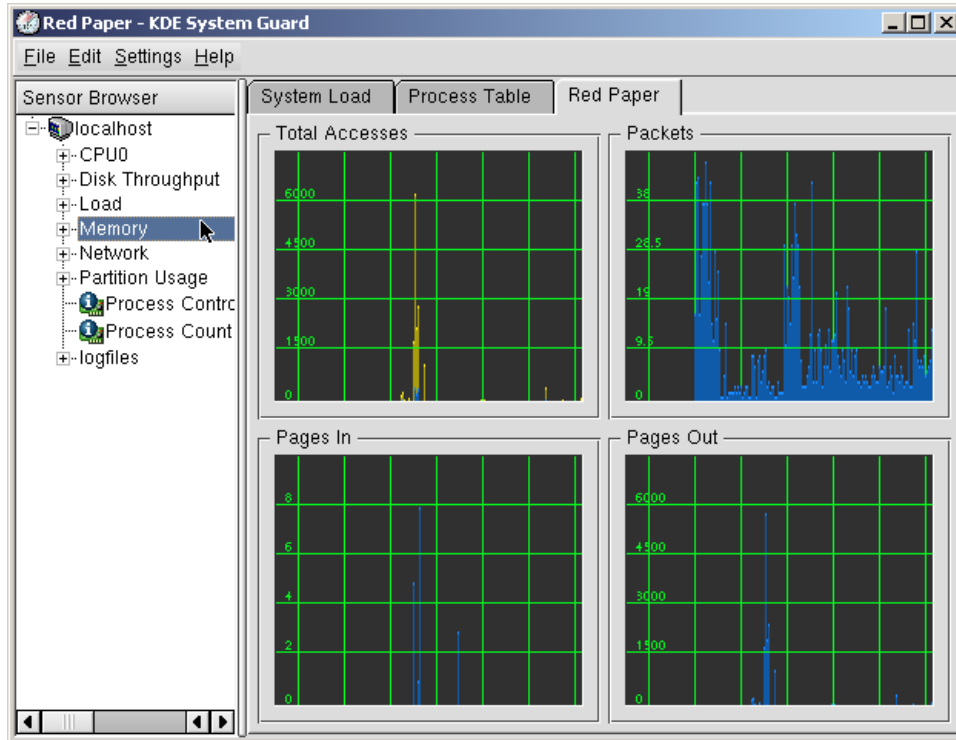

Figure 2-12 Example worksheet

Find more information about KDE System Guard at:

<http://docs.kde.org/>

### 2.3.18 Gnome System Monitor

Although not as powerful as the KDE System Guard, the Gnome desktop environment features a graphical performance analysis tool. The Gnome System Monitor can display performance-relevant system resources as graphs for visualizing possible peaks and bottlenecks. Note that all statistics are generated in real time. Long-term performance analysis should be carried out with different tools.

### 2.3.19 Capacity Manager

Capacity Manager, an add-on to the IBM Director system management suite for IBM Systems, is available in the ServerPlus Pack for IBM System x systems. Capacity Manager offers the possibility of long-term performance measurements across multiple systems and platforms. Apart from performance measurement, Capacity Manager enables capacity planning, offering you an estimate of future required system capacity needs. With Capacity Manager, you can export reports to HTML, XML, and GIF files that can be stored automatically on an intranet Web server. IBM Director can be used on different operating system platforms, which makes it much easier to collect and analyze data in a heterogeneous environment. Capacity Manager is discussed in detail in the redbook *Tuning IBM System x Servers for Performance*, SG24-5287.

To use Capacity Manager, you first must install the respective RPM package on the systems that will use its advanced features. After installing the RPM, select **Capacity Manager** → **Monitor Activator** in the IBM Director Console.

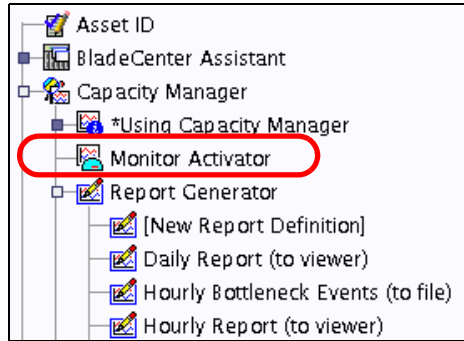

Figure 2-13 The task list in the IBM Director Console

Drag and drop the icon for Monitor Activator over a single system or a group of systems that have the Capacity Manager package installed. A window opens (Figure 2-14) in which you can select the various subsystems to be monitored over time. Capacity Manager for Linux does not yet support the full-feature set of available performance counters. System statistics are limited to a basic subset of performance parameters.

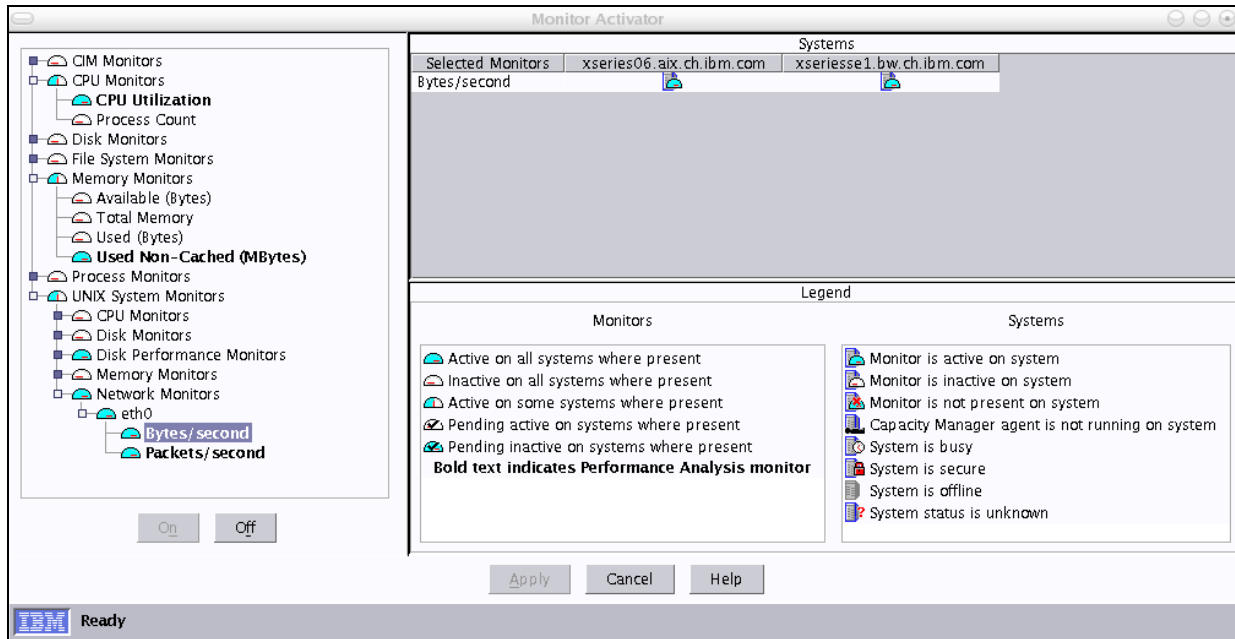

Figure 2-14 Activating performance monitors multiple systems

The Monitor Activator window shows the respective systems with their current status on the right side and the different available performance monitors at the left side. To add a new monitor, select the monitor and click **On**. The changes take effect shortly after the Monitor Activator window is closed. After this step, IBM Director starts collecting the requested performance metrics and stores them in a temporary location on the different systems.

To create a report of the collected data, select **Capacity Manager** → **Report Generator** (see Figure 2-13) and drag it over a single system or a group of systems for which you would like to see performance statistics. IBM Director asks whether the report should be generated right away or scheduled for later execution (Figure 2-15).

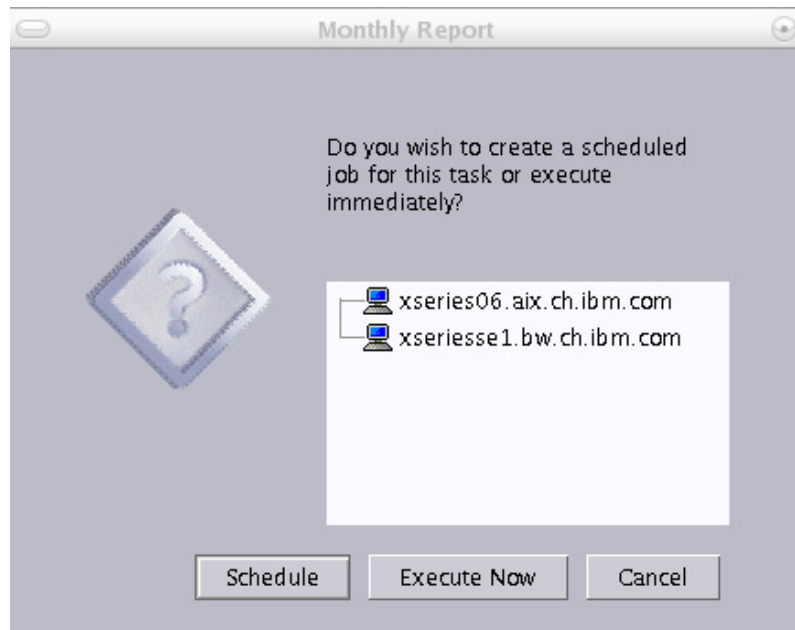

Figure 2-15 Scheduling reports

In a production environment, it is a good idea to have Capacity Manager generate reports on a regular basis. Our experience is that weekly reports that are performed in off-hours over the weekend can be very valuable. An immediate execution or scheduled execution report is generated according to your choice. As soon as the report has completed, it is stored on the central IBM Director management server, where it can be viewed using the Report Viewer task. Figure 2-16 shows sample output from a monthly Capacity Manager report.

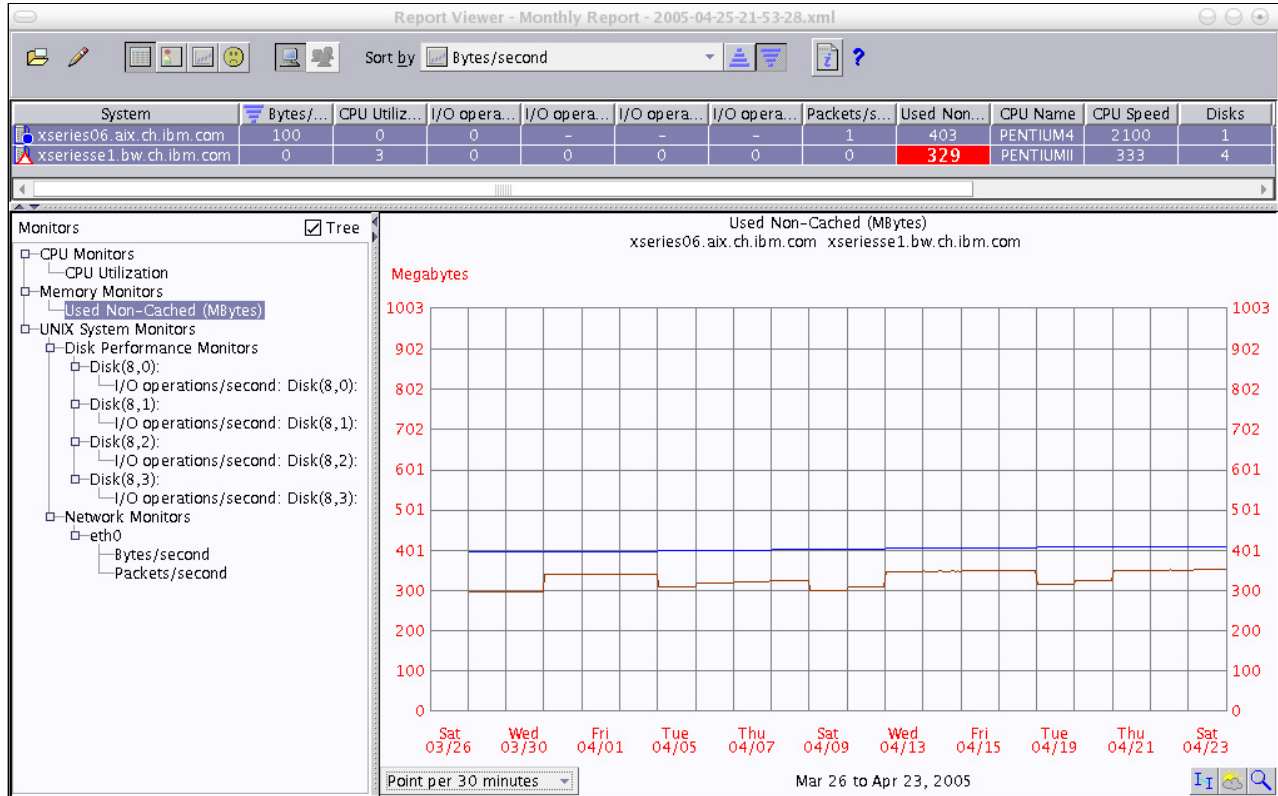

Figure 2-16 A sample Capacity Manager report

The Report Viewer window enables you to select the different performance counters that were collected and correlate this data to a single system or to a selection of systems.

Data acquired by Capacity Manager can be exported to an HTML or XML file to be displayed on an intranet Web server or for future analysis.

## 2.4 Benchmark tools

In this section, we pick up some of major benchmark tools. To measure performance it's wise to use good benchmark tools. There are a lot of good tools available. Some of them have all or some of the following capabilities

- ▶ Load generation
- ▶ Monitor performance
- ▶ Monitor system utilization
- ▶ Reporting

A benchmark is nothing more than a model for a specific workload that may or may not be close to the workload that will finally run on a system. If a system boasts a good Linpack score it might still not be the ideal file server. You should always remember that a benchmark can not simulate the sometimes unpredictable reactions of an end-user. A benchmark will also not tell you how a file server behaves once not only the user access their data but also the backup starts up. Generally the following rules should be observed when performing a benchmark on any system:

- ▶ Use a benchmark for server workloads: Server systems boast very distinct characteristic that make them very different from a typical desktop PC even though the IBM System x

platform shares many of the technologies available for desktop computers. Server benchmarks spawn multiple threads in order to utilize the SMP capabilities of the system and in order to simulate a true multi user environment. While a PC might start one web browser faster than a high-end server, the server will start a thousand web browsers faster than a PC.

- ▶ Simulate the expected workload: All benchmarks have different configuration options that should be used to tailor the benchmark towards the workload that the system should be running in the future. Great CPU performance will be of little use if the application in the end has to rely on low disk latency.
- ▶ Isolate benchmark systems: If a system is to be tested with a benchmark it is paramount to isolate it from any other load as good as possible. Already an open session running the **top** command can greatly impact the results of the benchmark.
- ▶ Average results: Even if you try to isolate the benchmark system as good as possible there might always be unknown factors that might impact systems performance just at the time of your benchmark. It is a good practice to run any benchmark for at least three times and average the results in order to make sure that a one time event does not impact your entire analysis.

In the following sections, we've selected some tools based on these criteria:

- ▶ Works on Linux: Linux is the target of the benchmark
- ▶ Works on all hardware platforms: Since IBM offers three distinct hardware platforms (assuming that the hardware technology of IBM System p and IBM System i™ are both based on the IBM POWER™ architecture) it is important to select a benchmark that may be used without big porting efforts on all architectures.
- ▶ Open source: Linux runs on several platform then the binary file may not be available if the source code is not available.
- ▶ Well-documented: You have to know well about the tool when you perform benchmarking. The documentation will help you to be familiar with the tools. It also helps to evaluate whether the tool is suit for your needs by taking a look at the concept and design and details before you decide to use certain tool.
- ▶ Actively-maintained: The old abandoned tool may not follow the recent specification and technology. It may produce a wrong result and lead misunderstanding.
- ▶ Widely used: You can find a lot of information about widely-used tools more easily.
- ▶ Easy to use: It's always good thing.
- ▶ Reporting capability: Having reporting capability will greatly reduce the performance analysis work.

## 2.4.1 LMBench

LMBench is a suite of microbenchmarks that can be used to analyze different operating system settings such as an SELinux enabled system versus a non SELinux system. The benchmarks included in LMBench measure various operating system routines such as context switching, local communications, memory bandwidth and file operations. Using LMBench is pretty straight forward as there are only three important commands to know;

- ▶ **make results**: The first time LMBench is run it will prompt for some details of the system configuration and what tests it should perform.
- ▶ **make rerun**: After the initial configuration and a first benchmark run, using the **make rerun** command simply repeats the benchmark using the configuration supplied during the **make results** run.

- ▶ **make see:** Finally after a minimum of three runs the results can be viewed using the `make see` command. The results will be displayed and can be copied to a spreadsheet application for further analysis or graphical representation of the data.

The Lmbench benchmark can be found at <http://sourceforge.net/projects/lmbench/>

## 2.4.2 IOzone

IOzone is a file system benchmark that can be utilized to simulate a wide variety of different disk access patterns. Since the configuration possibilities of IOzone are very detailed it is possible to simulate a targeted workload profile very precisely. In essence IOzone writes one or multiple files of variable size using variable block sizes.

While IOzone offers a very comfortable automatic benchmarking mode it is usually more efficient to define the workload characteristic such as file size, I/O size and access pattern. If a file system has to be evaluated for a database workload it would be sensible to cause IOzone to create a random access pattern to a rather large file at large block sizes instead of streaming a large file with a small block size. Some of the most important options for IOzone are:

- b <output.xls>** Tells IOzone to store the results in a Microsoft® Excel® compatible spreadsheet
- C** Displays output for each child process (can be used to check if all children really run simultaneously)
- f <filename>** Can be used to tell IOzone where to write the data
- i <number of test>** This option is used to specify what test are to be run. You will always have to specify **-i 0** in order to write the test file for the first time. Useful tests are **-i 1** for streaming reads and **-i 2** for random read and random write access as well as **-i 8** for a workload with mixed random access
- h** Displays the onscreen help
- r** Tells IOzone what record or I/O size that should be used for the tests. The record size should be as close as possible to the record size that will be used by the targeted workload
- k <number of async I/Os>** Uses the async I/O feature of kernel 2.6 that often is used by databases such as IBM DB2®
- m** Should the targeted application use multiple internal buffers then this behavior can be simulated using the **-m** flag
- s <size in KB>** Specifies the file size for the benchmark. For asynchronous file systems (the default mounting option for most file systems) IOzone should be used with a file size of at least twice the systems memory in order to really measure disk performance. The size can also be specified in MB or GB using **m** or **g** respectively directly after the file size.
- +u** Is an experimental switch that can be used to measure the processor utilization during the test

**Note:** Any benchmark using files that fit into the systems memory and that are stored on asynchronous file systems will measure the memory throughput rather than the disk subsystem performance. Hence you should either mount the file system of interest with the **sync** option or use a file size roughly twice the size of the systems memory.

Using IOzone to measure the random read performance of a given disk subsystem mounted at /perf for a file of 10 GB size at 32KB I/O size (these characteristics could model a simple database) would look as follows:

*Example 2-26 A sample IOzone command line*

```
./iozone -b results.xls -R -i 0 -i 2 -f /perf/iozone.file -r 32 -s 10g
```

Finally, the obtained result can be imported into your spreadsheet application of choice and then transformed into graphs. Using a graphical output of the data might make it easier to analyze a large amount of data and to identify trends. A sample output of the example above (refer to Example 2-26) might look like the graphic displayed in Figure 2-17.

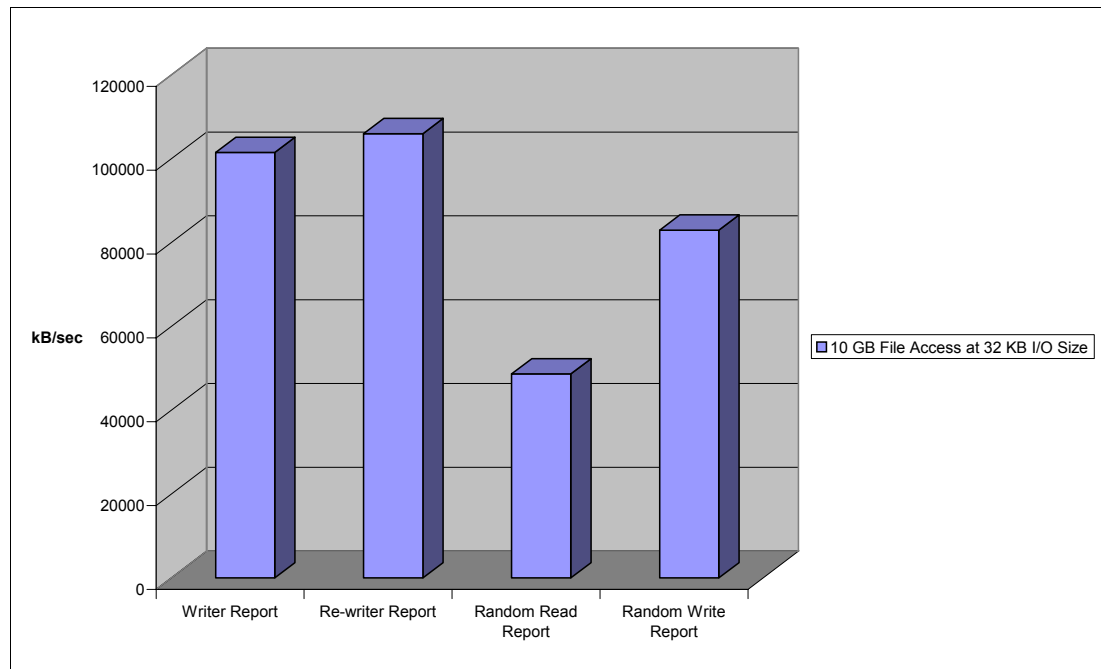

Figure 2-17 A graphic produced out of the sample results of Example 2-26

If IOzone is used with file sizes that either fit into the system's memory or cache it can also be used to gain some data about cache and memory throughput. It should however be noted that due to the file system overheads IOzone will report only 70-80% of a system's bandwidth.

The IOzone benchmark can be found at <http://www.iozone.org/>

### 2.4.3 netperf

**netperf** is a performance benchmark tool especially focusing on TCP/IP networking performance. It also supports UNIX domain socket and SCTP benchmarking.

**netperf** is designed based on a client-server model. **netserver** runs on a target system and **netperf** runs on the client. **netperf** controls the **netserver** and passes configuration data to

**netserver**, generates network traffic, gets the result from **netserver** via a control connection which is separated from the actual benchmark traffic connection. During the benchmarking, no communication occurs on the control connection so it does not have any effect on the result. The netperf benchmark tool also has a reporting capability including a CPU utilization report. The current stable version is 2.4.3 at the time of writing.

**netperf** can generate several types of traffic. Basically these fall into the two categories: bulk data transfer traffic and request/response type traffic. One thing you should keep in mind is netperf uses only one socket at a time. The next version of netperf (netperf4) will fully support benchmarking for concurrent session. At this time, we can perform multiple session benchmarking as described below.

► Bulk data transfer

Bulk data transfer is most commonly measured factor when it comes to network benchmarking. The bulk data transfer is measured by the amount of data transferred in one second. It simulates large file transfer such as multimedia streaming, FTP data transfer.

► Request/response type

This simulate request/response type traffic which is measured by the number of transactions exchanged in one second. Request/response traffic type is typical for online transaction application such as web server, database server, mail server, file server which serves small or medium files and directory server. In real environment, session establishment and termination should be performed as well as data exchange. To simulate this, TCP\_CRR type was introduced.

► Concurrent session

**netperf** does not have real support for concurrent multiple session benchmarking in the current stable version, but we can perform some benchmarking by just issuing multiple instances of **netperf** as follows:

```
for i in `seq 1 10`; do netperf -t TCP_CRR -H target.example.com -i 10 -P 0
&& done
```

We'll take a brief look at some useful and interesting options.

Global options:

<b>-A</b>	Change send and receive buffer alignment on remote system
<b>-b</b>	Burst of packet in stream test
<b>-H &lt;remotehost&gt;</b>	Remote host
<b>-t &lt;testname&gt;</b>	Test traffic type
<b>TCP_STREAM</b>	Bulk data transfer benchmark
<b>TCP_MAERTS</b>	Similar to TCP_STREAM except direction of stream is opposite.
<b>TCP_SENDFILE</b>	Similar to TCP_STREAM except using <b>sendfile()</b> instead of <b>send()</b> . It causes a zero-copy operation.
<b>UDP_STREAM</b>	Same as TCP_STREAM except UDP is used.
<b>TCP_RR</b>	Request/response type traffic benchmark
<b>TCP_CC</b>	TCP connect/close benchmark. No request and response packet is exchanged.
<b>TCP_CRR</b>	Performs connect/request/response/close operation. It's very much like HTTP1.0/1.1 session with HTTP keepalive disabled.
<b>UDP_RR</b>	Same as TCP_RR except UDP is used.



- l <testlen>** Test length of benchmarking. If positive value is set, netperf perform the benchmarking in *testlen* seconds. If negative, it performs until value of *testlen* bytes data is exchanged for bulk data transfer benchmarking or value of *testlen* transactions for request/response type.
- c** Local CPU utilization report
- C** Remote CPU utilization report

**Note:** The report of the CPU utilization may not be accurate in some platform. Make sure if it is accurate before you perform benchmarking.

- I <confllevel><interval>**  
This option is used to maintain confidence of the result. The confidence level should be 99 or 95 (percent) and interval (percent) can be set as well. To keep the result a certain level of confidence, the netperf repeats the same benchmarking several times. For example, **-I 99,5** means that the result is within 5% interval (+- 2.5%) of the real result in 99 times out of 100.
- i <max><min>** Number of maximum and minimum test iterations. This option limits the number of iteration. **-i 10,3** means netperf perform same benchmarking at least 3 times and at most 10 times. If the iteration exceeds the maximum value, the result would not be in the confidence level which is specified with **-I** option and some warning will be displayed in the result.
- s <bytes>, -S <bytes>**  
Changes send and receive buffer size on local, remote system. This will affect the advertised and effective window size.

Options for TCP\_STREAM, TCP\_MAERTS, TCP\_SENDFILE, UDP\_STREAM

- m <bytes>, -M <bytes>**  
Specifies the size of buffer passed to send(), recv() function call respectively and control the size sent and received per call.

Options for TCP\_RR, TCP\_CC, TCP\_CRR, UDP\_RR:

- r <bytes>, -R <bytes>**  
Specifies request, response size respectively. For example, **-r 128,8129** means that **netperf** send 128 byte packets to the netserver and it sends the 8129 byte packets back to **netperf**.

The following is an example output of netperf for TCP\_CRR type benchmark.

*Example 2-27 An example result of TCP\_CRR benchmark*

---

Testing with the following command line:

```
/usr/local/bin/netperf -l 60 -H plnxsu4 -t TCP_CRR -c 100 -C 100 -i ,3 -I 95,5 -v 1 -- -r 64,1 -s 0 -S 512
```

```
TCP Connect/Request/Response TEST from 0.0.0.0 (0.0.0.0) port 0 AF_INET to plnxsu4 (10.0.0.4) port 0 AF_INET
```

```
Local /Remote
```

Socket	Size	Request	Resp.	Elapsed	Trans.	CPU	CPU	S.dem	S.dem
Send	Recv	Size	Size	Time	Rate	local	remote	local	remote
bytes	bytes	bytes	bytes	secs.	per sec	%	%	us/Tr	us/Tr

16384 87380 64 1 60.00 3830.65 25.27 10.16 131.928 53.039  
2048 1024

---

When you perform benchmarking, it's wise to use the sample test scripts which come with **netperf**. By changing some variables in the scripts, you can perform your benchmarking as you like. The scripts are in the `doc/examples/` directory of the **netperf** package.

For more details, refer to <http://www.netperf.org/>

## 2.4.4 Other useful tools

Following are some other useful benchmark tools. Keep in mind that you have to know the characteristics of the benchmark tool and choose the tools that fit your needs.

Table 2-3 Additional benchmarking tools

Tool	Most useful tool function
bonnie	Disk I/O and file system benchmark <a href="http://www.textuality.com/bonnie/">http://www.textuality.com/bonnie/</a>
bonnie++	Disk I/O and file system benchmark. <a href="http://www.coker.com.au/bonnie++/">http://www.coker.com.au/bonnie++/</a>
NetBench	File server benchmark. It runs on Windows.
dbench	File system benchmark. Commonly used for file server benchmark. <a href="http://freshmeat.net/projects/dbench/">http://freshmeat.net/projects/dbench/</a>
iometer	Disk I/O and network benchmark <a href="http://www.iometer.org/">http://www.iometer.org/</a>
ttcp	Simple network benchmark
nttcp	Simple network benchmark
iperf	Network benchmark <a href="http://dast.nlanr.net/projects/Iperf/">http://dast.nlanr.net/projects/Iperf/</a>
ab (Apache Bench)	Simple web server benchmark. It comes with Apache HTTP server. <a href="http://httpd.apache.org/">http://httpd.apache.org/</a>
WebStone	Web server benchmark <a href="http://www.mindcraft.com/webstone/">http://www.mindcraft.com/webstone/</a>
Apache JMeter	Used mainly web server performance benchmarking. It also support other protocol such as SMTP, LDAP, JDBC™ etc. and it has good reporting capability. <a href="http://jakarta.apache.org/jmeter/">http://jakarta.apache.org/jmeter/</a>
fsstone, smtpstone	Mail server benchmark. They come with Postfix. <a href="http://www.postfix.org/">http://www.postfix.org/</a>
nhfsstone	Network File System benchmark. Comes with nfs-utils package.
DirectoryMark	LDAP benchmark <a href="http://www.mindcraft.com/directorymark/">http://www.mindcraft.com/directorymark/</a>



# Analyzing performance bottlenecks

This chapter is useful for finding a performance problem that may be already affecting one of your servers. We outline a series of steps to lead you to a concrete solution that you can implement to restore the server to an acceptable performance level.

The topics that are covered in this chapter are:

- ▶ 3.1, “Identifying bottlenecks” on page 78
- ▶ 3.2, “CPU bottlenecks” on page 81
- ▶ 3.3, “Memory bottlenecks” on page 82
- ▶ 3.4, “Disk bottlenecks” on page 84
- ▶ 3.5, “Network bottlenecks” on page 87

## 3.1 Identifying bottlenecks

The following steps are used as our quick tuning strategy:

1. Know your system.
2. Back up the system.
3. Monitor and analyze the system's performance.
4. Narrow down the bottleneck and find its cause.
5. Fix the bottleneck cause by trying only one single change at a time.
6. Go back to step 3 until you are satisfied with the performance of the system.

**Tip:** You should document each step, especially the changes you make and their effect on performance.

### 3.1.1 Gathering information

Mostly likely, the only first-hand information you will have access to will be statements such as "There is a problem with the server." It is crucial to use probing questions to clarify and document the problem. Here is a list of questions you should ask to help you get a better picture of the system.

- ▶ Can you give me a complete description of the server in question?
  - Model
  - Age
  - Configuration
  - Peripheral equipment
  - Operating system version and update level
- ▶ Can you tell me *exactly* what the problem is?
  - What are the symptoms?
  - Describe any error messages.

Some people will have problems answering this question, but any extra information the customer can give you might enable you to find the problem. For example, the customer might say "It is really slow when I copy large files to the server." This might indicate a network problem or a disk subsystem problem.

- ▶ Who is experiencing the problem?

Is one person, one particular group of people, or the entire organization experiencing the problem? This helps determine whether the problem exists in one particular part of the network, whether it is application-dependent, and so on. If only one user experiences the problem, then the problem might be with the user's PC (or their imagination).

The perception clients have of the server is usually a key factor. From this point of view, performance problems may not be directly related to the server: the network path between the server and the clients can easily be the cause of the problem. This path includes network devices as well as services provided by other servers, such as domain controllers.

- ▶ Can the problem be reproduced?

All reproducible problems can be solved. If you have sufficient knowledge of the system, you should be able to narrow the problem to its root and decide which actions should be taken.

The fact that the problem can be reproduced enables you to see and understand it better. Document the sequence of actions that are necessary to reproduce the problem:

- What are the steps to reproduce the problem?

Knowing the steps may help you reproduce the same problem on a different machine under the same conditions. If this works, it gives you the opportunity to use a machine in a test environment and removes the chance of crashing the production server.

- Is it an intermittent problem?

If the problem is intermittent, the first thing to do is to gather information and find a path to move the problem in the reproducible category. The goal here is to have a scenario to make the problem happen on command.

- Does it occur at certain times of the day or certain days of the week?

This might help you determine what is causing the problem. It may occur when everyone arrives for work or returns from lunch. Look for ways to change the timing (that is, make it happen less or more often); if there are ways to do so, the problem becomes a reproducible one.

- Is it unusual?

If the problem falls into the non-reproducible category, you may conclude that it is the result of extraordinary conditions and classify it as fixed. In real life, there is a high probability that it will happen again.

A good procedure to troubleshoot a hard-to-reproduce problem is to perform general maintenance on the server: reboot, or bring the machine up to date on drivers and patches.

- ▶ When did the problem start? Was it gradual or did it occur very quickly?

If the performance issue appeared gradually, then it is likely to be a sizing issue; if it appeared overnight, then the problem could be caused by a change made to the server or peripherals.

- ▶ Have any changes been made to the server (minor or major) or are there any changes in the way clients are using the server?

Did the customer alter something on the server or peripherals to cause the problem? Is there a log of all network changes available?

Demands could change based on business changes, which could affect demands on a servers and network systems.

- ▶ Are there any other servers or hardware components involved?

- ▶ Are any logs available?

- ▶ What is the priority of the problem? When does it have to be fixed?

- Does it have to be fixed in the next few minutes, or in days? You may have some time to fix it; or it may already be time to operate in panic mode.

- How massive is the problem?

- What is the related cost of that problem?

### 3.1.2 Analyzing the server's performance

**Important:** Before taking any troubleshooting actions, back up all data and the configuration information to prevent a partial or complete loss.

At this point, you should begin monitoring the server. The simplest way is to run monitoring tools from the server that is being analyzed. (See Chapter 2, "Monitoring and benchmark tools" on page 39, for information.)

A performance log of the server should be created during its peak time of operation (for example, 9:00 a.m. to 5:00 p.m.); it will depend on what services are being provided and on who is using these services. When creating the log, if available, the following objects should be included:

- ▶ Processor
- ▶ System
- ▶ Server work queues
- ▶ Memory
- ▶ Page file
- ▶ Physical disk
- ▶ Redirector
- ▶ Network interface

Before you begin, remember that a methodical approach to performance tuning is important. Our recommended process, which you can use for your server performance tuning process, is as follows:

1. Understand the factors affecting server performance.
2. Measure the current performance to create a performance baseline to compare with your future measurements and to identify system bottlenecks.
3. Use the monitoring tools to identify a performance bottleneck. By following the instructions in the next sections, you should be able to narrow down the bottleneck to the subsystem level.
4. Work with the component that is causing the bottleneck by performing some actions to improve server performance in response to demands.

**Note:** It is important to understand that the greatest gains are obtained by upgrading a component that has a bottleneck when the other components in the server have ample "power" left to sustain an elevated level of performance.

5. Measure the new performance. This helps you compare performance before and after the tuning steps.

When attempting to fix a performance problem, remember the following:

- ▶ Applications should be compiled with an appropriate optimization level to reduce the path length.
- ▶ Take measurements before you upgrade or modify anything so that you can tell whether the change had any effect. (That is, take baseline measurements.)
- ▶ Examine the options that involve reconfiguring existing hardware, not just those that involve adding new hardware.

## 3.2 CPU bottlenecks

For servers whose primary role is that of an application or database server, the CPU is a critical resource and can often be a source of performance bottlenecks. It is important to note that high CPU utilization does not always mean that a CPU is busy doing work; it may, in fact, be waiting on another subsystem. When performing proper analysis, it is very important that you look at the system as a whole and at all subsystems because there may be a cascade effect within the subsystems.

**Note:** There is a common misconception that the CPU is the most important part of the server. This is not always the case, and servers are often overconfigured with CPU and underconfigured with disks, memory, and network subsystems. Only specific applications that are truly CPU-intensive can take advantage of today's high-end processors.

### 3.2.1 Finding CPU bottlenecks

Determining bottlenecks with the CPU can be accomplished in several ways. As discussed in Chapter 2, "Monitoring and benchmark tools" on page 39, Linux has a variety of tools to help determine this; the question is: which tools to use?

One such tool is **uptime**. By analyzing the output from **uptime**, we can get a rough idea of what has been happening in the system for the past 15 minutes. For a more detailed explanation of this tool, see 2.3.3, "uptime" on page 43.

*Example 3-1 uptime output from a CPU strapped system*

---

```
18:03:16 up 1 day, 2:46, 6 users, load average: 182.53, 92.02, 37.95
```

---

Using KDE System Guard and the CPU sensors lets you view the current CPU workload.

**Tip:** Be careful not to add to CPU problems by running too many tools at one time. You may find that using a lot of different monitoring tools at one time may be contributing to the high CPU load.

Using **top**, you can see both CPU utilization and what processes are the biggest contributors to the problem (Example 2-1 on page 41). If you have set up **sar**, you are collecting a lot of information, some of which is CPU utilization, over a period of time. Analyzing this information can be difficult, so use **isag**, which can use **sar** output to plot a graph. Otherwise, you may wish to parse the information through a script and use a spreadsheet to plot it to see any trends in CPU utilization. You can also use **sar** from the command line by issuing **sar -u** or **sar -U processornumber**. To gain a broader perspective of the system and current utilization of more than just the CPU subsystem, a good tool is **vmstat** (2.3.2, "vmstat" on page 42).

### 3.2.2 SMP

SMP-based systems can present their own set of interesting problems that can be difficult to detect. In an SMP environment, there is the concept of *CPU affinity*, which implies that you bind a process to a CPU.

The main reason this is useful is CPU cache optimization, which is achieved by keeping the same process on one CPU rather than moving between processors. When a process moves between CPUs, the cache of the new CPU must be flushed. Therefore, a process that moves between processors causes many cache flushes to occur, which means that an individual process will take longer to finish. This scenario is very hard to detect because, when

monitoring it, the CPU load will appear to be very balanced and not necessarily peaking on any CPU. Affinity is also useful in NUMA-based systems such as the IBM System x 3950, where it is important to keep memory, cache, and CPU access local to one another.

### 3.2.3 Performance tuning options

The first step is to ensure that the system performance problem is being caused by the CPU and not one of the other subsystems. If the processor is the server bottleneck, then a number of actions can be taken to improve performance. These include:

- ▶ Ensure that no unnecessary programs are running in the background by using `ps -ef`. If you find such programs, stop them and use `crontab` to schedule them to run at off-peak hours.
- ▶ Identify non-critical, CPU-intensive processes by using `top` and modify their priority using `renice`.
- ▶ In an SMP-based machine, try using `taskset` to bind processes to CPUs to make sure that processes are not hopping between processors, causing cache flushes.
- ▶ Based on the running application, it may be better to scale up (bigger CPUs) than scale out (more CPUs). This depends on whether your application was designed to effectively take advantage of more processors. For example, a single-threaded application would scale better with a faster CPU and not with more CPUs.
- ▶ General options include making sure you are using the latest drivers and firmware, as this may affect the load they have on the CPU.

## 3.3 Memory bottlenecks

On a Linux system, many programs run at the same time; these programs support multiple users and some processes are more used than others. Some of these programs use a portion of memory while the rest are “sleeping.” When an application accesses cache, the performance increases because an in-memory access retrieves data, thereby eliminating the need to access slower disks.

The OS uses an algorithm to control which programs will use physical memory and which are paged out. This is transparent to user programs. Page space is a file created by the OS on a disk partition to store user programs that are not currently in use. Typically, page sizes are 4 KB or 8 KB. In Linux, the page size is defined by using the variable `EXEC_PAGESIZE` in the `include/asm-<architecture>/param.h` kernel header file. The process used to page a process out to disk is called *pageout*.

### 3.3.1 Finding memory bottlenecks

Start your analysis by listing the applications that are running on the server. Determine how much physical memory and swap each application needs to run. Figure 3-1 on page 83 shows KDE System Guard monitoring memory usage.



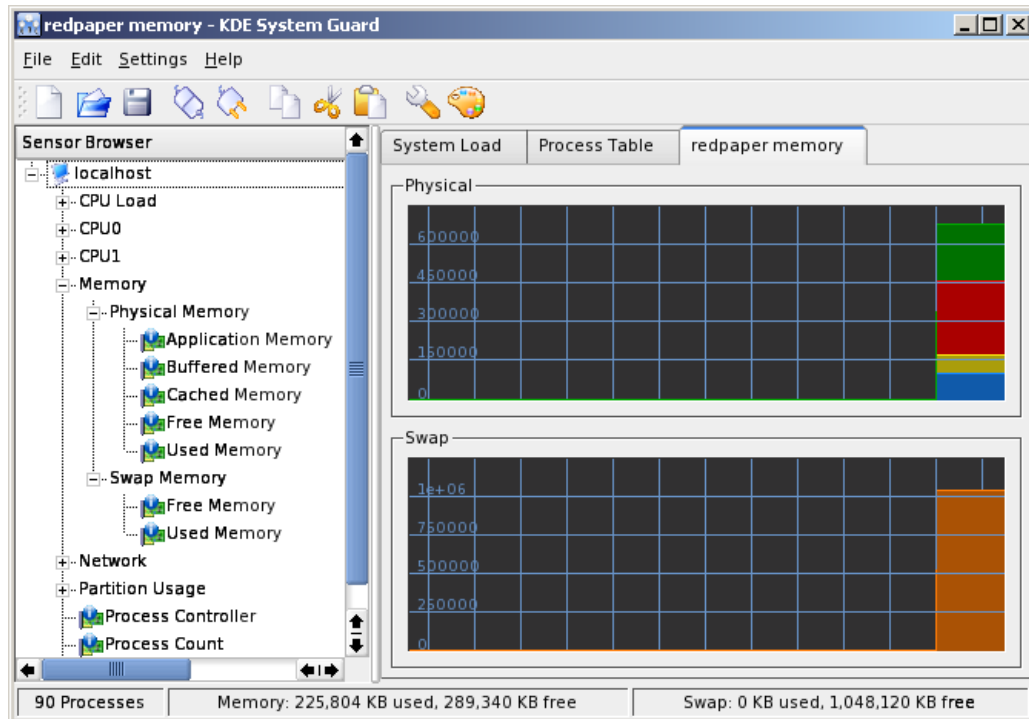

Figure 3-1 KDE System Guard memory monitoring

The indicators in Table 3-1 can also help you define a problem with memory.

Table 3-1 Indicator for memory analysis

Memory indicator	Analysis
Memory available	This indicates how much physical memory is available for use. If, after you start your application, this value has decreased significantly, you may have a memory leak. Check the application that is causing it and make the necessary adjustments. Use <code>free -l -t -o</code> for additional information.
Page faults	There are two types of page faults: soft page faults, when the page is found in memory, and hard page faults, when the page is not found in memory and must be fetched from disk. Accessing the disk will slow your application considerably. The <code>sar -B</code> command can provide useful information for analyzing page faults, specifically columns <code>pgpgin/s</code> and <code>pgpgout/s</code> .
File system cache	This is the common memory space used by the file system cache. Use the <code>free -l -t -o</code> command for additional information.
Private memory for process	This represents the memory used by each process running on the server. You can use the <code>pmap</code> command to see how much memory is allocated to a specific process.

### Paging and swapping indicators

In Linux, as with all UNIX-based operating systems, there are differences between paging and swapping. Paging moves individual pages to swap space on the disk; swapping is a bigger operation that moves the entire address space of a process to swap space in one operation.

Swapping can have one of two causes:

- ▶ A process enters sleep mode. This usually happens because the process depends on interactive action, as editors, shells, and data entry applications spend most of their time waiting for user input. During this time, they are inactive.

- ▶ A process behaves poorly. Paging can be a serious performance problem when the amount of free memory pages falls below the minimum amount specified, because the paging mechanism is not able to handle the requests for physical memory pages and the swap mechanism is called to free more pages. This significantly increases I/O to disk and will quickly degrade a server's performance.

If your server is always paging to disk (a high page-out rate), consider adding more memory. However, for systems with a low page-out rate, it may not affect performance.

### 3.3.2 Performance tuning options

If you believe there is a memory bottleneck, consider performing one or more of these actions:

- ▶ Tune the swap space using `bigpages`, `hugetlb`, shared memory.
- ▶ Increase or decrease the size of pages.
- ▶ Improve the handling of active and inactive memory.
- ▶ Adjust the page-out rate.
- ▶ Limit the resources used for each user on the server.
- ▶ Stop the services that are not needed, as discussed in “Daemons” on page 97.
- ▶ Add memory.

## 3.4 Disk bottlenecks

The disk subsystem is often the most important aspect of server performance and is usually the most common bottleneck. However, problems can be hidden by other factors, such as lack of memory. Applications are considered to be I/O-bound when CPU cycles are wasted simply waiting for I/O tasks to finish.

The most common disk bottleneck is having too few disks. Most disk configurations are based on capacity requirements, not performance. The least expensive solution is to purchase the smallest number of the largest-capacity disks possible. However, this places more user data on each disk, causing greater I/O rates to the physical disk and allowing disk bottlenecks to occur.

The second most common problem is having too many logical disks on the same array. This increases seek time and significantly lowers performance.

The disk subsystem is discussed in 4.6, “Tuning the disk subsystem” on page 113.

### 3.4.1 Finding disk bottlenecks

A server exhibiting the following symptoms may be suffering from a disk bottleneck (or a hidden memory problem):

- ▶ Slow disks will result in:
  - Memory buffers filling with write data (or waiting for read data), which will delay all requests because free memory buffers are unavailable for write requests (or the response is waiting for read data in the disk queue)
  - Insufficient memory, as in the case of not enough memory buffers for network requests, will cause synchronous disk I/O
- ▶ Disk utilization, controller utilization, or both will typically be very high.
- ▶ Most LAN transfers will happen only after disk I/O has completed, causing very long response times and low network utilization.

- ▶ Disk I/O can take a relatively long time and disk queues will become full, so the CPUs will be idle or have low utilization because they wait long periods of time before processing the next request.

The disk subsystem is perhaps the most challenging subsystem to properly configure. Besides looking at raw disk interface speed and disk capacity, it is key to also understand the workload: Is disk access random or sequential? Is there large I/O or small I/O? Answering these questions provides the necessary information to make sure the disk subsystem is adequately tuned.

Disk manufacturers tend to showcase the upper limits of their drive technology's throughput. However, taking the time to understand the throughput of your workload will help you understand what true expectations to have of your underlying disk subsystem.

*Table 3-2 Exercise showing true throughput for 8 KB I/Os for different drive speeds*

Disk speed	Latency	Seek time	Total random access time <sup>a</sup>	I/Os per second per disk <sup>b</sup>	Throughput given 8 KB I/O
15 000 RPM	2.0 ms	3.8 ms	6.8 ms	147	1.15 MBps
10 000 RPM	3.0 ms	4.9 ms	8.9 ms	112	900 KBps
7 200 RPM	4.2 ms	9 ms	13.2 ms	75	600 KBps

a. Assuming that the handling of the command + data transfer < 1 ms, total random access time = latency + seek time + 1 ms.

b. Calculated as 1/total random access time.

Random read/write workloads usually require several disks to scale. The bus bandwidths of SCSI or Fibre Channel are of lesser concern. Larger databases with random access workload will benefit from having more disks. Larger SMP servers will scale better with more disks. Given the I/O profile of 70% reads and 30% writes of the average commercial workload, a RAID-10 implementation will perform 50% to 60% better than a RAID-5.

Sequential workloads tend to stress the bus bandwidth of disk subsystems. Pay special attention to the number of SCSI buses and Fibre Channel controllers when maximum throughput is desired. Given the same number of drives in an array, RAID-10, RAID-0, and RAID-5 all have similar streaming read and write throughput.

There are two ways to approach disk bottleneck analysis: real-time monitoring and tracing.

- ▶ Real-time monitoring must be done while the problem is occurring. This may not be practical in cases where system workload is dynamic and the problem is not repeatable. However, if the problem is repeatable, this method is flexible because of the ability to add objects and counters as the problem becomes well understood.
- ▶ Tracing is the collecting of performance data over time to diagnose a problem. This is a good way to perform remote performance analysis. Some of the drawbacks include the potential for having to analyze large files when performance problems are not repeatable, and the potential for not having all key objects and parameters in the trace and having to wait for the next time the problem occurs for the additional data.

### vmstat command

One way to track disk usage on a Linux system is by using the `vmstat` tool. The columns of interest in `vmstat` with respect to I/O are the `bi` and `bo` fields. These fields monitor the movement of blocks in and out of the disk subsystem. Having a baseline is key to being able to identify any changes over time.

*Example 3-2 vmstat output*

---

```
[root@x232 root]# vmstat 2
r  b  swpd   free   buff  cache   si   so   bi   bo   in   cs us sy id wa
2  1    0   9004  47196 1141672   0   0    0   950  149   74 87 13  0  0
0  2    0   9672  47224 1140924   0   0   12 42392  189   65 88 10  0  1
0  2    0   9276  47224 1141308   0   0   448    0  144   28  0  0  0 100
0  2    0   9160  47224 1141424   0   0   448  1764  149   66  0  1  0  99
0  2    0   9272  47224 1141280   0   0   448    60  155   46  0  1  0  99
0  2    0   9180  47228 1141360   0   0  6208 10730  425  413  0  3  0  97
1  0    0   9200  47228 1141340   0   0 11200    6  631  737  0  6  0  94
1  0    0   9756  47228 1140784   0   0 12224  3632  684  763  0 11  0  89
0  2    0   9448  47228 1141092   0   0  5824 25328  403  373  0  3  0  97
0  2    0   9740  47228 1140832   0   0   640    0  159   31  0  0  0 100
```

---

**iostat command**

Performance problems can be encountered when too many files are opened, being read and written to, then closed repeatedly. This could become apparent as seek times (the time it takes to move to the exact track where the data is stored) start to increase. Using the **iostat** tool, you can monitor the I/O device loading in real time. Different options enable you to drill down even farther to gather the necessary data.

Example 3-3 shows a potential I/O bottleneck on the device `/dev/sdb1`. This output shows average wait times (`await`) of about 2.7 seconds and service times (`svctm`) of 270 ms.

*Example 3-3 Sample of an I/O bottleneck as shown with iostat 2 -x /dev/sdb1*

---

```
[root@x232 root]# iostat 2 -x /dev/sdb1

avg-cpu:  %user   %nice   %sys   %idle
           11.50    0.00    2.00   86.50

Device:   rrqm/s  wrqm/s   r/s   w/s  rsec/s  wsec/s   rkB/s   kB/s  avgrq-sz
avgqu-sz  await  svctm  %util
/dev/sdb1 441.00 3030.00  7.00 30.50 3584.00 24480.00  1792.00 12240.00  748.37
101.70 2717.33 266.67 100.00

avg-cpu:  %user   %nice   %sys   %idle
           10.50    0.00    1.00   88.50

Device:   rrqm/s  wrqm/s   r/s   w/s  rsec/s  wsec/s   rkB/s   kB/s  avgrq-sz
avgqu-sz  await  svctm  %util
/dev/sdb1 441.00 3030.00  7.00 30.00 3584.00 24480.00  1792.00 12240.00  758.49
101.65 2739.19 270.27 100.00

avg-cpu:  %user   %nice   %sys   %idle
           10.95    0.00    1.00   88.06

Device:   rrqm/s  wrqm/s   r/s   w/s  rsec/s  wsec/s   rkB/s   kB/s  avgrq-sz
avgqu-sz  await  svctm  %util
/dev/sdb1 438.81 3165.67  6.97 30.35 3566.17 25576.12  1783.08 12788.06  781.01
101.69 2728.00 268.00 100.00
```

---

For a more detailed explanation of the fields, see the man page for `iostat(1)`.

Changes made to the elevator algorithm as described in 4.6.2, “I/O elevator tuning and selection” on page 116 will be seen in `avgrq-sz` (average size of request) and `avgqu-sz` (average queue length). As the latencies are lowered by manipulating the elevator settings, `avgrq-sz` will decrease. You can also monitor the `rrqm/s` and `wrqm/s` to see the effect on the number of merged reads and writes that the disk can manage.

### 3.4.2 Performance tuning options

After verifying that the disk subsystem is a system bottleneck, several solutions are possible. These solutions include the following:

- ▶ If the workload is of a sequential nature and it is stressing the controller bandwidth, the solution is to add a faster disk controller. However, if the workload is more random in nature, then the bottleneck is likely to involve the disk drives, and adding more drives will improve performance.
- ▶ Add more disk drives in a RAID environment. This spreads the data across multiple physical disks and improves performance for both reads and writes. This will increase the number of I/Os per second. Also, use hardware RAID instead of the software implementation provided by Linux. If hardware RAID is being used, the RAID level is hidden from the OS.
- ▶ Consider using Linux logical volumes with striping instead of large single disks or logical volumes without striping.
- ▶ Offload processing to another system in the network (users, applications, or services).
- ▶ Add more RAM. Adding memory increases system memory disk cache, which in effect improves disk response times.

## 3.5 Network bottlenecks

A performance problem in the network subsystem can be the cause of many problems, such as a kernel panic. To analyze these anomalies to detect network bottlenecks, each Linux distribution includes traffic analyzers.

### 3.5.1 Finding network bottlenecks

We recommend KDE System Guard because of its graphical interface and ease of use. The tool, which is available on the distribution CDs, is discussed in detail in 2.3.17, “KDE System Guard” on page 62. Figure 3-2 on page 88 shows it in action.

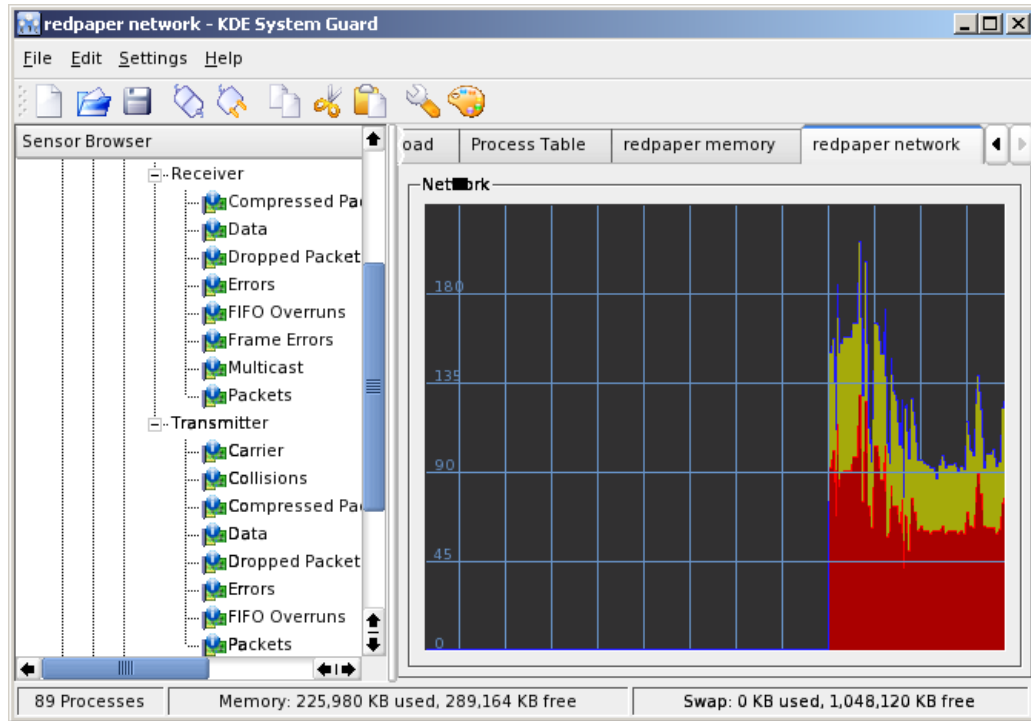

Figure 3-2 KDE System Guard network monitoring

It is important to remember that there are many possible reasons for these performance problems and that sometimes problems occur simultaneously, making it even more difficult to pinpoint the origin. The indicators in Table 3-3 can help you determine the problem with your network.

Table 3-3 Indicators for network analysis

Network indicator	Analysis
Packets received Packets sent	Shows the number of packets that are coming in and going out of the specified network interface. Check both internal and external interfaces.
Collision packets	Collisions occur when there are many systems on the same domain. The use of a hub may be the cause of many collisions.
Dropped packets	Packets may be dropped for a variety of reasons, but the result may affect performance. For example, if the server network interface is configured to run at 100 Mbps full duplex, but the network switch is configured to run at 10 Mbps, the router may have an ACL filter that drops these packets. For example: <code>iptables -t filter -A FORWARD -p all -i eth2 -o eth1 -s 172.18.0.0/24 -j DROP</code>
Errors	Errors occur if the communications lines (for instance, the phone line) are of poor quality. In these situations, corrupted packets must be resent, thereby decreasing network throughput.
Faulty adapters	Network slowdowns often result from faulty network adapters. When this kind of hardware fails, it may begin to broadcast junk packets on the network.

### 3.5.2 Performance tuning options

These steps illustrate what you should do to solve problems related to network bottlenecks:

- ▶ Ensure that the network card configuration matches router and switch configurations (for example, frame size).
- ▶ Modify how your subnets are organized.
- ▶ Use faster network cards.
- ▶ Tune the appropriate IPV4 TCP kernel parameters. (See Chapter 4, “Tuning the operating system” on page 91.) Some security-related parameters can also improve performance, as described in that chapter.
- ▶ If possible, change network cards and recheck performance.
- ▶ Add network cards and bind them together to form an adapter team, if possible.







# Tuning the operating system

By its nature and heritage, the Linux distributions and the Linux kernel offer a variety of parameters and settings to let the Linux administrator tweak the system to maximize performance. As stated earlier in this redpaper, there sadly is no magic tuning knob that will improve systems performance for any application. The settings discussed in the following chapter will improve performance for certain hardware configurations and application layouts. The very same setting that improve performance for a web server scenario might have adverse impacts on the performance of a database system.

This chapter describes the steps you can take to tune Kernel 2.6 based Linux distributions. Since the current kernel 2.6 based distributions vary from kernel release 2.6.9 up to 2.6.19 (at the time of writing this redpaper) some tuning options might only apply to a specific kernel release. The objective is to describe the parameters that give you the most improvement in performance and offer basic understanding of the techniques that are used in Linux, including:

- ▶ Linux memory management
- ▶ System clean up
- ▶ Disk subsystem tuning
- ▶ Kernel tuning using `sysctl`
- ▶ Network optimization

This chapter has the following sections:

- ▶ 4.1, “Tuning principals” on page 92
- ▶ 4.2, “Installation considerations” on page 92
- ▶ 4.3, “Changing kernel parameters” on page 104
- ▶ 4.4, “Tuning the processor subsystem” on page 108
- ▶ 4.5, “Tuning the vm subsystem” on page 110
- ▶ 4.6, “Tuning the disk subsystem” on page 113
- ▶ 4.7, “Tuning the network subsystem” on page 125

## 4.1 Tuning principals

Tuning any system should follow some rather simple principles of which the most important is change management as described below. Generally the first step in systems tuning should be to analyze and evaluate the current system configuration. Ensuring that the system performs as stated by the hardware manufacturer and that all devices are running in their optimal mode will create a solid base for any later tuning. Also prior to any specific tuning tasks a system designed for optimal performance should have a minimum of unnecessary tasks and subsystems running. Finally when moving towards specific systems tuning, it should be noted that tuning often tailors a system towards a specific workload. Hence the system will perform better for under the intended load characteristics but it will most likely perform worse for different workload patterns. An example would be tuning a system for low latency which most of the time has an adverse effect on throughput.

### 4.1.1 Change management

While not strictly related to performance tuning, change management is probably the single most important factor for successful performance tuning. The following considerations might be second nature to you, but as a reminder we highlight these points:

- ▶ Implement a proper change management process before tuning any Linux system.
- ▶ Never start tweaking settings on a production system.
- ▶ Never change more than one variable during the tuning process.
- ▶ Retest parameters that supposedly improved performance; sometimes statistics come into play.
- ▶ Document successful parameters and share them with the community no matter how trivial you think they are. Linux performance is a topic that can benefit greatly from any results obtained in production environments.

## 4.2 Installation considerations

Ideally the tuning of a server system towards a specific performance goal should start with the design and installation phase. A proper installation that tailors a system towards the workload pattern will save a significant amount of time during the later tuning phase.

### 4.2.1 Installation

In a perfect world, tuning of any given system starts at a very early stage. Ideally a system is tailored to the needs of the application and the anticipated workload. We understand that most of the time an administrator has to tune an already installed system due to a bottleneck, but we also want to highlight the tuning possibilities available during the initial installation of the operating system.

Several issues should be resolved before starting the installation of Linux, including:

- ▶ Selection of the processor technology
- ▶ Choice of disk technology
- ▶ Applications

However, these issues are beyond the scope of this redpaper.

Ideally, the following questions should be answered before starting the installation:

► What flavor and version of Linux do I need?

After you have collected the business and application requirements, decide which version of Linux to use. Enterprises often have contractual agreements that allow the general use of a specific Linux distribution. In this case, financial and contractual benefits will most likely dictate the version of Linux that can be used. However, if you have full freedom in choosing the version of your Linux distribution, there are some points to consider:

- A supported Enterprise Linux or a custom made distribution?

In certain scientific environments it is acceptable to run an unsupported version of Linux, such as Fedora. For enterprise workloads, we strongly recommend a fully supported distribution such as Red Hat Enterprise Linux or Novell SUSE Enterprise Linux.

- What version of an enterprise distribution?

Most Enterprise Linux distributions come in various flavors that differ in their kernel version, the supported packages or features and most importantly in their level of hardware support. Before any installation, review the supported hardware configuration carefully as not to lose some of your hardware's capabilities.

► Select the correct kernel

Enterprise Linux distributions offer several kernel packages, as listed in Table 4-1. For performance reasons, be sure to select the most appropriate kernel for your system. However in most cases the correct kernel will be selected by the installation routine. Keep in mind that the exact kernel package name differs by distributions.

Table 4-1 Available kernel types

Kernel type	Description
Standard	Single processor machines.
SMP	Kernel has support for SMP and Hyper-Threaded machines. Some packages also include support for NUMA. There may be some variant, depending on the amount of memory, the number of CPU, and so on.
Xen	Includes a version of the Linux kernel which runs in a Xen virtual machine.

**Note:** Most recent kernels have the capability called SMP alternative which optimizes itself at boot time. Refer to the distribution release notes for details.

► What partition layout to choose?

In the Linux community, the partitioning of a disk subsystem engenders vast discussion. The partitioning layout of a disk subsystem is often dictated by application needs, systems management considerations, and personal liking, and not performance. The partition layout will therefore be given in most cases. The only suggestion we want to give here is to use a swap partition if possible. Swap partitions, as opposed to swap files, have a performance benefit because there is no overhead of a file system. Swap partitions are simple and can be expanded with additional swap partitions or even swap files if needed.

► What file system to use?

Different file systems offer different characteristics in data integrity and performance. Additionally certain file systems might not be supported by the respective Linux distribution or the application that is to be used. For most server installations the default file system proposed by the installation routine will offer adequate performance. If you have however specific requirements for minimal latency or maximal throughput we

suggest that you select the respective file system based on these requirements. Refer to 4.6, “Tuning the disk subsystem” for detailed selection criteria.

- ▶ Package selection: minimal or everything?

During an installation of Linux, administrators are faced with the decision of a minimal-or-everything installation approach. Philosophies differ somewhat in this area. There are voices that prefer everything installations because there is hardly ever the need to install packages to resolve dependencies.

Consider these points: While not related to performance, it is important to point out that an “everything” or “near-everything” installation imposes security threats on a system. The availability of development tools on production systems may lead to significant security threats. The fewer packages you install, the less disk space will be wasted, and a disk with more free space performs better than a disk with little free space. Intelligent software installers such as the Red Hat Packet Manager or rpm or yum will resolve dependencies automatically if desired. Therefore, we suggest you consider a minimal packages selection with only those packages that are absolutely necessary for a successful implementation of the application.

- ▶ Netfilter configuration

You need to choose if the Netfilter firewall configuration is required or not. The Netfilter firewall should usually be used to protect the system from malicious attacks. However having too many and complicated firewall rules may decrease performance in high data traffic environments. We cover the Netfilter firewall in 4.7.6, “Performance impact of Netfilter” on page 133.

- ▶ SELinux

In certain Linux distributions such as Red Hat Enterprise Linux 4.0, the installation routine allows to select the installation of SELinux. SELinux comes at a significant performance penalty and you should carefully evaluate whether the additional security provided by SELinux is really needed for a particular system. For more information, refer to 4.2.4, “SELinux” on page 102.

- ▶ Runlevel selection

The last choice given during the installation process is the selection of the runlevel your system defaults to. Unless you have a specific need to run your system in runlevel 5 (graphical user mode) we strongly suggest using runlevel 3 for all server systems. Normally there should be no need for a GUI on a system that resides in a data center, and the overhead imposed by runlevel 5 is considerable. Should the installation routine not offer a run level selection we suggest to manually select run level 3 after the initial system configuration.

## 4.2.2 Check the current configuration

As stated in the introduction, it is most important to establish a solid base for any system tuning attempts. A solid base means ensuring that all subsystems work the way they were designed to and that there are no anomalies. An example to such an anomaly would be a gigabit network interface card and a server with a network performance bottleneck. Tuning the TCP/IP implementation of the Linux kernel may be of little use if the network card autonegotiated to 100MBit/half duplex.

### **dmesg**

The main purpose of **dmesg** is to display kernel messages. **dmesg** can provide helpful information in case of hardware problems or problems with loading a module into the kernel.

In addition, with `dmesg`, you can determine what hardware is installed on your server. During every boot, Linux checks your hardware and logs information about it. You can view these logs using the command `/bin/dmesg`.

*Example 4-1 partial output from dmesg*

---

```
Linux version 2.6.18-8.el5 (brewbuilder@ls20-bc1-14.build.redhat.com) (gcc version 4.1.1
20070105 (Red Hat 4.1.
```

```
1-52)) #1 SMP Fri Jan 26 14:15:14 EST 2007
```

```
Command line: ro root=/dev/Vo1Group00/LogVo100 rhgb quiet
```

```
No NUMA configuration found
```

```
Faking a node at 0000000000000000-0000000140000000
```

```
Bootmem setup node 0 0000000000000000-0000000140000000
```

```
On node 0 totalpages: 1029288
```

```
  DMA zone: 2726 pages, LIFO batch:0
```

```
  DMA32 zone: 768002 pages, LIFO batch:31
```

```
  Normal zone: 258560 pages, LIFO batch:31
```

```
Kernel command line: ro root=/dev/Vo1Group00/LogVo100 rhgb quiet
```

```
Initializing CPU#0
```

```
Memory: 4042196k/5242880k available (2397k kernel code, 151492k reserved, 1222k data, 196k
init)
```

```
Calibrating delay using timer specific routine.. 7203.13 BogoMIPS (1pj=3601568)
```

```
Security Framework v1.0.0 initialized
```

```
SELinux: Initializing.
```

```
SELinux: Starting in permissive mode
```

```
CPU: Trace cache: 12K uops, L1 D cache: 16K
```

```
CPU: L2 cache: 1024K
```

```
using mwait in idle threads.
```

```
CPU: Physical Processor ID: 0
```

```
CPU: Processor Core ID: 0
```

```
CPU0: Thermal monitoring enabled (TM2)
```

```
SMP alternatives: switching to UP code
```

```
ACPI: Core revision 20060707
```

```
Using local APIC timer interrupts.
```

```
result 12500514
```

```
Detected 12.500 MHz APIC timer.
```

```
SMP alternatives: switching to SMP code
```

```
sizeof(vma)=176 bytes
```

```
sizeof(page)=56 bytes
```

```
sizeof(inode)=560 bytes
```

```
sizeof(dentry)=216 bytes
```

```
sizeof(ext3inode)=760 bytes
```

```
sizeof(buffer_head)=96 bytes
```

```
sizeof(skbuff)=240 bytes
```

```
io scheduler noop registered
```

```
io scheduler anticipatory registered
```

```
io scheduler deadline registered
```

```
io scheduler cfq registered (default)
```

```
SCSI device sda: 143372288 512-byte hdwr sectors (73407 MB)
```

```
sda: assuming Write Enabled
```

```
sda: assuming drive cache: write through
```

```
eth0: Tigon3 [partno(BCM95721) rev 4101 PHY(5750)] (PCI Express) 10/100/1000BaseT Ethernet
00:11:25:3f:19:b4
```

```
eth0: RXcsums[1] LinkChgREG[0] MIirq[0] ASF[1] Split[0] WireSpeed[1] TS0cap[1]
eth0: dma_rwctrl[76180000] dma_mask[64-bit]
```

```
EXT3 FS on dm-0, internal journal
kjournald starting. Commit interval 5 seconds
EXT3 FS on sda1, internal journal
EXT3-fs: mounted filesystem with ordered data mode.
```

---

## ulimit

This command is built into the bash shell and is used to provide control over the resources available to the shell and to the processes started by it on systems that allow such control.

Use the `-a` option to list all parameters that we can set:

```
ulimit -a
```

### Example 4-2 Output of ulimit

---

```
[root@x232 html]# ulimit -a
core file size          (blocks, -c) 0
data seg size           (kbytes, -d) unlimited
file size               (blocks, -f) unlimited
max locked memory       (kbytes, -l) 4
max memory size         (kbytes, -m) unlimited
open files              (-n) 1024
pipe size               (512 bytes, -p) 8
stack size              (kbytes, -s) 10240
cpu time                (seconds, -t) unlimited
max user processes      (-u) 7168
virtual memory          (kbytes, -v) unlimited
```

---

The `-H` and `-S` options specify the hard and soft limits that can be set for the given resource. If the soft limit is passed, the system administrator will receive a warning. The hard limit is the maximum value that can be reached before the user gets the error messages `Out of file handles`.

For example, you can set a hard limit for the number of file handles and open files (`-n`):

```
ulimit -Hn 4096
```

For the soft limit of number of file handles and open files, use:

```
ulimit -Sn 1024
```

To see the hard and soft values, issue the command with a new value:

```
ulimit -Hn
ulimit -Sn
```

This command can be used, for example, to limit Oracle® users on the fly. To set it on startup, enter the following lines, for example, in `/etc/security/limits.conf`:

```
soft nofile 4096
hard nofile 10240
```

In addition, make sure that the default pam configuration file (`/etc/pam.d/system-auth` for Red Hat Enterprise Linux, `/etc/pam.d/common-session` for SUSE Linux Enterprise Server) has the following entry:

```
session required pam_limits.so
```

This entry is required so that the system can enforce these limits.

For the complete syntax of the `ulimit` command, issue:

```
ulimit -?
```

### 4.2.3 Minimize resource use

Systems that are designed for highest levels of performance must minimize any wasting of resources. We understand that a race car will not offer the same amenities as a normal passenger car does but for the purpose of driving as fast as possible cup holders and comfortable seats are a waste of resources. The very same concept also holds true for server systems. Running a memory consuming GUI and a vast amount of unnecessary daemons will also decrease overall performance. This section will hence cover the optimization of system resource consumption.

#### Daemons

After a default installation of Linux distributions, several possibly unnecessary services and daemons might be enabled. Disabling unneeded daemons reduces the overall memory footprint of the system, reduces the amount of running processes and hence context switches and, more important, reduces exposure to various security threats. Disabling unneeded daemons additionally decreases startup time of the server.

By default, several daemons that have been started can be stopped and disabled safely on most systems. Table 4-2 lists the daemons that are started in various Linux installations. You should consider disabling these in your environment if applicable. Note that the table lists the respective daemons for several commercially available Linux distributions. The exact number of running daemons might differ from your specific Linux installation. For a more detailed explanation of these daemons, refer to the **system-config-services** shown in Figure 4-1 on page 99 or the YaST GUI as displayed in Figure 4-2 on page 100.

Table 4-2 Tunable daemons started on a default installation

Daemons	Description
apmd	Advanced power management daemon. apmd will most likely not be used on a server.
arpables_jf	User space program for the arpables network filter. Unless you plan to use arpables, you can safely disable this daemon.
autofs	Automatically mounts file systems on demand (for example, mounts a CD-ROM automatically). On server systems, file systems rarely have to be mounted automatically.
cpuspeed	Daemon to dynamically adjust the frequency of the CPU. In a server environment, this daemon is recommended off.
cups	Common UNIX Printing System. If you plan to provide print services with your server, do not disable this service.
gpm	Mouse server for the text console. Do not disable if you want mouse support for the local text console.

Daemons	Description
hpoj	HP OfficeJet support. Do not disable if you plan to use an HP OfficeJet printer with your server.
irqbalance	Balances interrupts between multiple processors. You may safely disable this daemon on a single CPU system or if you plan to balance IRQ statically.
isdn	ISDN modem support. Do not disable if you plan to use an ISDN modem with your server.
kudzu	Detects and configures new hardware. Should be run manually in case of a hardware change.
netfs	Used in support of exporting NFS shares. Do not disable if you plan to provide NFS shares with your server.
nfslock	Used for file locking with NFS. Do not disable if you plan to provide NFS shares with your server.
pcmcia	PCMCIA support on a server. Server systems rarely rely on a PCMCIA adapter so disabling this daemon is safe in most instances.
portmap	Dynamic port assignment for RPC services (such as NIS and NFS). If the system does not provide RPC-based services there is no need for this daemon.
rawdevices	Provides support for raw device bindings. If you do not intend to use raw devices you may safely turn it off.
rpc*	Various remote procedure call daemons mainly used for NFS and Samba. If the system does not provide RPC-based services, there is no need for this daemon.
sendmail	Mail Transport Agent. Do not disable this daemon if you plan to provide mail services with the respective system.
smartd	Self Monitor and Reporting Technology daemon that watches S.M.A.R.T. compatible devices for errors. Unless you use an IDE/ SATA technology-based disk subsystem, there is no need for S.M.A.R.T. Monitoring.
xfs	Font server for X Windows. If you will run in runlevel 5, do not disable this daemon.

**Attention:** Turning off the xfs daemon prevents X from starting on the server. This should be turned off only if the server will not be booting into the GUI. Simply starting the xfs daemon before issuing the `startx` command enables X to start normally.

On Novell SUSE and Red Hat Enterprise Linux systems, the `/sbin/chkconfig` command provides the administrator with an easy-to-use interface to change start options for various daemons. One of the first commands that should be run when using `chkconfig` is a check for all running daemons:

```
/sbin/chkconfig --list | grep on
```

If you do not want the daemon to start the next time the machine boots, issue either one of the following commands as root. They accomplish the same results, the difference being that the second command disables a daemon on all run levels, whereas the `--level` flag can be used to specify exact run levels:

```
/sbin/chkconfig --levels 2345 sendmail off
/sbin/chkconfig sendmail off
```



**Tip:** Instead of wasting precious time waiting for a reboot to complete, simply change the run level to 1 and back to 3 or 5, respectively.

There is another useful system command, `/sbin/service`, that enables an administrator to immediately change the status of any registered service. In a first instance, an administrator should always choose to check the current status of a service (`sendmail` in our example) by issuing this command:

```
/sbin/service sendmail status
```

To immediately stop the `sendmail` daemon in our example, use this command:

```
/sbin/service sendmail stop
```

The `service` command is especially useful to immediately verify whether a daemon is needed, as changes performed via `chkconfig` will not be active unless you change the system run level or perform a reboot. However, a daemon disabled by the `service` command will be re-enabled after a reboot. Should the `service` command not be available with your Linux distribution there is always the possibility to start or stop a daemon via the `init.d` directory. Checking the status of the CUPS daemon for instance could be performed like this:

```
/etc/init.d/cups status
```

Similarly, there are GUI-based programs for modifying which daemons are started, as shown in Figure 4-1. To run the service configuration GUI for Red Hat Enterprise Linux, click **Main Menu** → **System Settings** → **Server Settings** → **Services** or issue this command:

```
/usr/bin/redhat-config-services
```

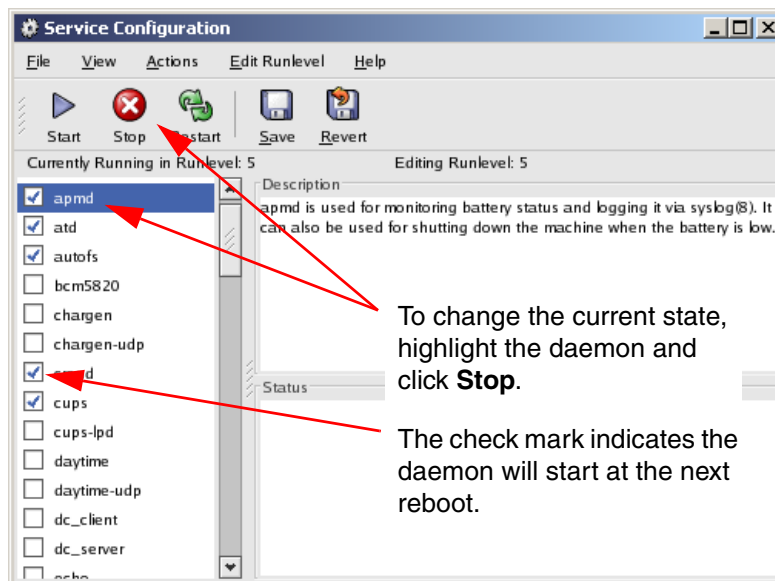

Figure 4-1 Red Hat Service Configuration interface

Novell SUSE systems offer the same features via the YaST utility. In YaST the service configuration can be found under **System** → **System Services (Runlevel)**. Once in the service configuration we suggest to use the expert mode in order to accurately set the status of the respective daemon. Running YaST in runlevel 3 would look as shown in Figure 4-2 on page 100.



## Changing runlevels

Whenever possible, do not run the graphical user interface on a Linux server. Normally, there is no need for a GUI on a Linux server, as most Linux administrators will happily assure you. All administrative tasks can be achieved efficiently via the command line, by redirecting the X display, or through a Web browser interface. If you prefer a graphical interface, there are several useful Web-based tools such as webmin, Linuxconf, and SWAT.

**Tip:** Even if the GUI is disabled locally on the server, you can still connect remotely and use the GUI. To do this, use the `-X` parameter with the `ssh` command.

If a GUI must be used, start and stop it as needed rather than running it all the time. In most cases the server should be running at runlevel 3, which does not start the X Server when the machine boots up. If you want to restart the X Server, use `startx` from a command prompt.

1. Determine which run level the machine is running by using the `runlevel` command.

This prints the previous and current run level. For example, `N 5` means that there was no previous run level (N) and that the current run level is 5.

2. To switch between run levels, use the `init` command. (For example, to switch to runlevel 3, enter the `init 3` command.)

The run levels that are used in Linux are:

- 0** Halt (Do not set `initdefault` to this or the server will shut down immediately after finishing the boot process.)
- 1** Single user mode
- 2** Multiuser, without NFS (the same as 3, if you do not have networking)
- 3** Full multiuser mode
- 4** Unused
- 5** X11
- 6** Reboot (Do not set `initdefault` to this or the server machine will continuously reboot at startup.)

To set the initial runlevel of a machine at boot, modify the `/etc/inittab` file as shown in Figure 4-3 with the line:

```
id:3:initdefault:
```

```

... (lines not displayed)

# The default runlevel is defined here
id:3:initdefault:

# First script to be executed, if not booting in emergency (-b) mode
si::bootwait:/etc/init.d/boot

# /etc/init.d/rc takes care of runlevel handling
#
# runlevel 0 is System halt (Do not use this for initdefault!)
# runlevel 1 is Single user mode
# runlevel 2 is Local multiuser without remote network (e.g. NFS)
# runlevel 3 is Full multiuser with network
# runlevel 4 is Not used
# runlevel 5 is Full multiuser with network and xdm
# runlevel 6 is System reboot (Do not use this for initdefault!)
#

... (lines not displayed)

# getty-programs for the normal runlevels
# <id>:<runlevels>:<action>:<process>
# The "id" field MUST be the same as the last
# characters of the device (after "tty").
1:2345:respawn:/sbin/mingetty --noclear tty1
2:2345:respawn:/sbin/mingetty tty2
#3:2345:respawn:/sbin/mingetty tty3
#4:2345:respawn:/sbin/mingetty tty4
#5:2345:respawn:/sbin/mingetty tty5
#6:2345:respawn:/sbin/mingetty tty6
#
#S0:12345:respawn:/sbin/agetty -L 9600 ttyS0 vt102

... (lines not displayed)

```

To start Linux without starting the GUI, set the run level to 3

To only provide two local virtual terminals, comment out the mingetty entries for 3, 4, 5, and 6.

Figure 4-3 /etc/inittab, modified (only part of the file is displayed)

### Limiting local terminals

By default, several virtual consoles are spawned locally. The amount of memory used by the virtual terminals is negligible; nevertheless we try to get the most out of any system. Additionally, troubleshooting and process analysis will be simplified by simply reducing the amount of running processes, hence the reason for limiting the local terminals to two.

To do this, comment out each `mingetty ttyx` line you want to disable. As an example, in Figure 4-3 on page 102 we limited the consoles to two. This gives you a fallback local terminal in case a command kills the shell you were working on locally.

## 4.2.4 SELinux

Red Hat Enterprise Linux 4 introduced a new security model, Security Enhanced Linux (SELinux), which is a significant step toward higher security. SELinux introduces a mandatory

policy model that overcomes the limitations of the standard discretionary access model employed by Linux. SELinux enforces security on user and process levels; hence a security flaw of any given process affects only the resources allocated to this process and not the entire system. SELinux works similar to a virtual machine. For example, if a malicious attacker uses a root exploit within Apache, only the resources allocated to the Apache daemon could be compromised.

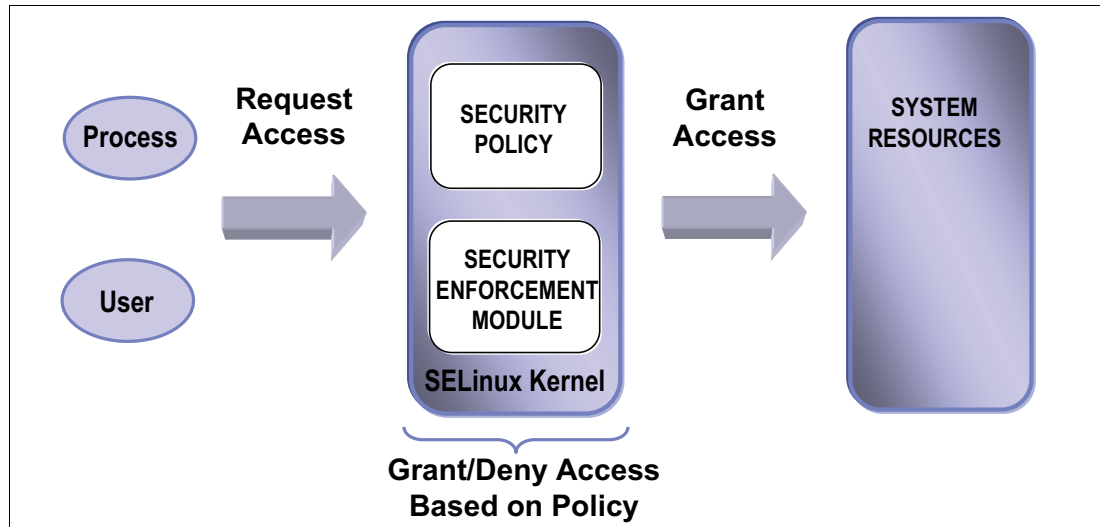

Figure 4-4 Schematic overview of SELinux

However, enforcing such a policy-based security model comes at a price. Every access from a user or process to a system resource such as an I/O device must be controlled by SELinux. The process of checking permissions can cause overhead of up to 10%. SELinux is of great value to any edge server such as a firewall or a Web server, but the added level of security on a back-end database server may not justify the loss in performance.

Generally the easiest way to disable SELinux is to not install it in the first place. But often systems have been installed using default parameters, unaware that SELinux affects performance. To disable SELinux after an installation, append the entry `selinux=0` to the line containing the running kernel in the GRUB boot loader (Example 4-3 on page 103).

Example 4-3 Sample `grub.conf` file with disabled SELinux

---

```
default=0
splashimage=(hd0,0)/grub/splash.xpm.gz
hiddenmenu
title Red Hat Enterprise Linux AS (2.6.9-5.ELsmp)
    root (hd0,0)
    kernel /vmlinuz-2.6.9-5.ELsmp ro root=LABEL=/ selinux=0
    initrd /initrd-2.6.9-5.ELsmp.img
```

---

Another way of disabling SELinux is via the SELinux configuration file stored under `/etc/selinux/config`. Disabling SELinux from within that file looks as shown in the next example Example 4-4 on page 103.

Example 4-4 Disabling SELinux via the `config` file

---

```
# This file controls the state of SELinux on the system.
# SELINUX= can take one of these three values:
#     enforcing - SELinux security policy is enforced.
#     permissive - SELinux prints warnings instead of enforcing.
```

---

```
#      disabled - SELinux is fully disabled.
SELINUX=disabled
# SELINUXTYPE= type of policy in use. Possible values are:
#      targeted - Only targeted network daemons are protected.
#      strict - Full SELinux protection.
SELINUXTYPE=targeted
```

---

If you decide to use SELinux with your Linux-based server, its settings can be tweaked to better accommodate your environment. On a running system, check whether the working set of the cached Linux Security Modules (LSM) permissions exceeds the default Access Vector Cache (AVC) size of 512 entries.

Check `/selinux/avc/hash_stats` for the length of the longest chain. Anything over 10 signals a likely bottleneck.

**Tip:** To check for usage statistics of the access vector cache you may alternatively use the `avcstat` utility.

If the system experiences a bottleneck in the Access Vector Cache (for example, on a heavily loaded firewall), try to resize `/selinux/avc/cache_threshold` to a slightly higher value and recheck the hash stats.

## 4.2.5 Compiling the kernel

Creating and compiling your own kernel has far less of an impact on improving system performance than often thought. Modern kernels shipped with most Linux distributions are modular—they load only the parts that are used. Recompiling the kernel can decrease kernel size and its overall behavior (for example, real-time behavior). Changing certain parameters in the source code might also yield some system performance. However, non-standard kernels are not covered in the support subscription that is provided with most Enterprise Linux distributions. Additionally, the extensive ISV application and IBM hardware certifications that are provided for Enterprise Linux distributions are nullified if a non-standard kernel is used.

Having said that, performance improvements can be gained with a custom-made kernel, but they hardly justify the challenges you face running an unsupported kernel in an enterprise environment. While this is true for commercial workloads, if scientific workloads such as high performance computing are your area of interest, custom kernels might nevertheless be of interest to you.

Also do not attempt to use special compiler flags such as `-C09` when recompiling the kernel. The source code for the Linux kernel has been hand-tuned to match the GNU C compiler. Using special compiler flags might at best decrease the kernel performance and at worst break the code.

Keep in mind that unless you really know what you are doing, you might actually decrease system performance due to wrong kernel parameters.

## 4.3 Changing kernel parameters

Although modifying and recompiling the kernel source code is not recommended for most users, the Linux kernel features yet another means of tweaking kernel parameters. The `proc`

file system provides an interface to the running kernel that may be used for monitoring purposes and for changing kernel settings on the fly.

To view the current kernel configuration, choose a kernel parameter in the `/proc/sys` directory and use the `cat` command on the respective file. In Example 4-5 we parse the system for its current memory overcommit strategy. The output 0 tells us that the system will always check for available memory before granting an application a memory allocation request. To change this default behavior we can use the `echo` command and supply it with the new value, 1 in the case of our example (1 meaning that the kernel will grant every memory allocation without checking whether the allocation can be satisfied).

*Example 4-5 Changing kernel parameters via the proc file system*

---

```
[root@linux vm]# cat overcommit_memory
0
[root@linux vm]# echo 1 > overcommit_memory
```

---

While the demonstrated way of using `cat` and `echo` to change kernel parameters is fast and available on any system with the `proc` file system, it has two significant shortcomings.

- ▶ The `echo` command does not perform any consistency check on the parameters.
- ▶ All changes to the kernel are lost after a reboot of the system.

To overcome this, a utility called `sysctl` aids the administrator in changing kernel parameters.

**Tip:** By default, the kernel includes the necessary module to enable you to make changes using `sysctl` without having to reboot. However, if you chose to remove this support (during the operating system installation), then you will have to reboot Linux before the change will take effect.

In addition, Red Hat Enterprise Linux and Novell SUSE Enterprise Linux offer graphical methods of modifying these `sysctl` parameters. Figure 4-5 on page 106 shows one of the user interfaces.

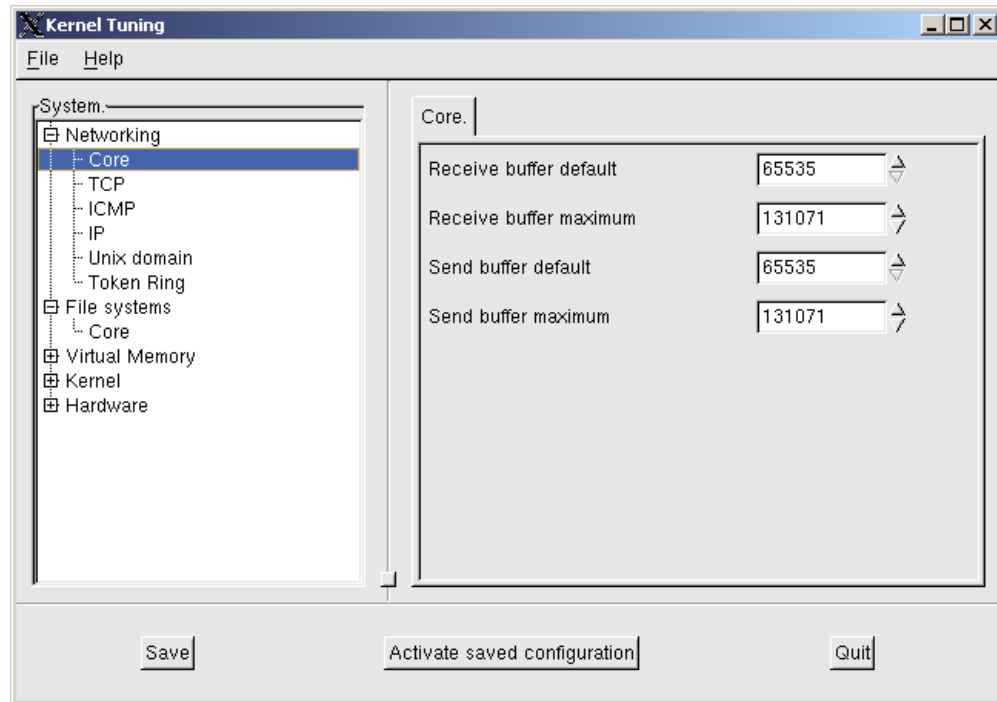

Figure 4-5 Red Hat kernel tuning

For Novell SUSE based systems, again YaST and more specifically powertweak is the tool of choice for changing any kernel parameter.



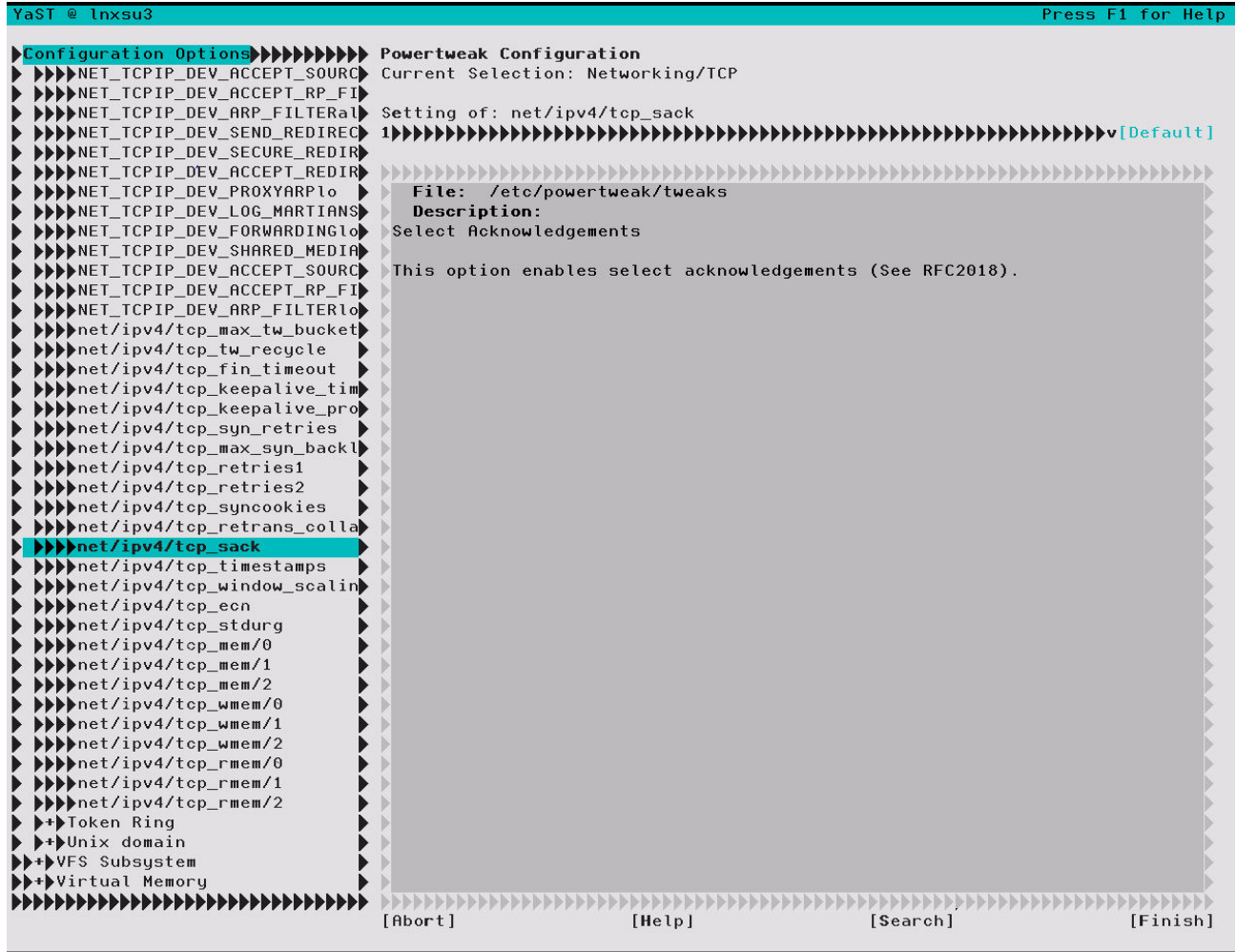

Figure 4-6 The powertweak utility

The big advantage of powertweak via sysctl for instance is the fact that all tuning parameters are presented with a short explanation. Note that all changes made with the help of powertweak will be stored under /etc/powerweak/tweaks.

### 4.3.1 Where the parameters are stored

The kernel parameters that control how the kernel behaves are stored in /proc (in particular, /proc/sys).

Reading the files in the /proc directory tree provides a simple way to view configuration parameters that are related to the kernel, processes, memory, network, and other components. Each process running in the system has a directory in /proc with the process ID (PID) as its name. Figure 4-3 lists some of the files that contain kernel information.

Table 4-3 Parameter files in /proc

File/directory	Purpose
/proc/sys/abi/*	Used to provide support for “foreign” binaries, not native to Linux — those compiled under other UNIX variants such as SCO UnixWare 7, SCO OpenServer, and SUN Solaris™ 2. By default, this support is installed, although it can be removed during installation.

File/directory	Purpose
/proc/sys/fs/*	Used to increase the number of open files the OS allows and to handle quota.
/proc/sys/kernel/*	For tuning purposes, you can enable hotplug, manipulate shared memory, and specify the maximum number of PID files and level of debug in syslog.
/proc/sys/net/*	Tuning of network in general, IPV4 and IPV6.
/proc/sys/vm/*	Management of cache memory and buffer.

### 4.3.2 Using the sysctl command

The `sysctl` command uses the names of files in the `/proc/sys` directory tree as parameters. For example, to modify the `shmmax` kernel parameter, you can display (using `cat`) and change (using `echo`) the file `/proc/sys/kernel/shmmax`:

```
#cat /proc/sys/kernel/shmmax
33554432
#echo 33554430 > /proc/sys/kernel/shmmax
#cat /proc/sys/kernel/shmmax
33554430
```

However, using these commands can easily introduce errors, so we recommend that you use the `sysctl` command because it checks the consistency of the data before it makes any change. For example:

```
#sysctl kernel.shmmax
kernel.shmmax = 33554432
#sysctl -w kernel.shmmax=33554430
kernel.shmmax = 33554430
#sysctl kernel.shmmax
kernel.shmmax = 33554430
```

This change to the kernel stays in effect only until the next reboot. If you want to make the change permanent, then you can edit the `/etc/sysctl.conf` file and add the appropriate command. In our example:

```
kernel.shmmax = 33554439
```

The next time you reboot, the parameter file will be read. You can do the same thing without booting by issuing the following command:

```
#sysctl -p
```

## 4.4 Tuning the processor subsystem

In any computer, be it a hand-held device or a cluster for scientific applications, the main subsystem is the processor that does the actual computing. During the past decade Moore's Law has caused processor subsystems to evolve significantly faster than other subsystems have. The result is that now bottlenecks rarely occur within the CPU, unless number crunching is the sole purpose of the system. This is impressively illustrated by the average CPU utilization of an Intel-compatible server system that lies below 10%. Having said that, it is important to understand the bottlenecks that can occur at the processor level and to know possible tuning parameters in order to improve CPU performance.

### 4.4.1 Tuning process priority

As we stated in 1.1.4, “Process priority and nice level” on page 5, it is not possible to change the process priority of a process. This is only indirectly possible through the use of the nice level of the process, but even this is not always possible. If a process is running too slowly, you can assign more CPU to it by giving it a lower nice level. Of course, this means that all other programs will have fewer processor cycles and will run more slowly.

Linux supports nice levels from 19 (lowest priority) to -20 (highest priority). The default value is 0. To change the nice level of a program to a negative number (which makes it higher priority), it is necessary to log on or **su** to root.

To start the program xyz with a nice level of -5, issue the command:

```
nice -n -5 xyz
```

To change the nice level of a program already running, issue the command:

```
renice level pid
```

To change the priority of a program with a PID of 2500 to a nice level of 10, issue:

```
renice 10 2500
```

### 4.4.2 CPU affinity for interrupt handling

Two principles have proven to be most efficient when it comes to interrupt handling (refer to 1.1.6, “Interrupt handling” on page 6 for a review of interrupt handling):

- ▶ Bind processes that cause a significant amount of interrupts to a CPU.

CPU affinity enables the system administrator to bind interrupts to a group or a single physical processor (of course, this does not apply on a single-CPU system). To change the affinity of any given IRQ, go into `/proc/irq/{number of respective irq}/` and change the CPU mask stored in the file `smp_affinity`. To set the affinity of IRQ 19 to the third CPU in a system (without SMT) use the command in Example 4-6.

*Example 4-6 Setting the CPU affinity for interrupts*

---

```
[root@linux ~]#echo 03 > /proc/irq/19/smp_affinity
```

---

- ▶ Let physical processors handle interrupts.

In symmetric multithreading (SMT) systems such as IBM POWER 5+ processors supporting multi threading, it is suggested that you bind interrupt handling to the physical processor rather than the SMT instance. The physical processors usually have the lower CPU numbering so in a two-way system with multi threading enabled, CPU ID 0 and 2 would refer to the physical CPU, and 1 and 3 would refer to the multi threading instances. If you do not use the `smp_affinity` flag, you will not have to worry about this.

### 4.4.3 Considerations for NUMA systems

Non-Uniform Memory Architecture (NUMA) systems are gaining market share and are seen as the natural evolution of classic symmetric multiprocessor systems. Although the CPU scheduler used by current Linux distributions is well suited for NUMA systems, applications might not always be. Bottlenecks caused by a non-NUMA-aware application can cause performance degradations that are hard to identify. The recent `numastat` utility shipped in the `numactl` package helps to identify processes that have difficulties dealing with NUMA architectures.

To help with spotting bottlenecks, statistics provided by the `numastat` tool are available in the `/sys/devices/system/node/{node number}/numastat` file. High values in `numa_miss` and the `other_node` field signal a likely NUMA issue. If you find that a process is allocated memory that does not reside on the local node for the process (the node that holds the processors that run the application), try to `renice` the process to the other node or work with NUMA affinity.

## 4.5 Tuning the vm subsystem

Tuning the memory subsystem is a difficult task that requires constant monitoring to ensure that changes do not negatively affect other subsystems in the server. If you do choose to modify the virtual memory parameters (in `/proc/sys/vm`), we recommend that you change only one parameter at a time and monitor how the server performs.

Remember that most applications under Linux do not write directly to the disk, but to the file system cache maintained by the virtual memory manager that will eventually flush out the data. When using an IBM ServeRAID controller or an IBM TotalStorage disk subsystem, you should try to decrease the number of flushes, effectively increasing the I/O stream caused by each flush. The high-performance disk controller can handle the larger I/O stream more efficiently than multiple small ones.

### 4.5.1 Setting kernel swap and pdflush behavior

With the introduction of the improved virtual memory subsystem in the Linux kernel 2.6, administrators now have a simple interface to fine-tune the swapping behavior of the kernel.

- ▶ The parameter stored in `/proc/sys/vm/swappiness` can be used to define how aggressively memory pages are swapped to disk. An introduction to the Linux virtual memory manager and the general use of swap space in Linux is discussed in “Page frame reclaiming” on page 14. It states that Linux moves memory pages that have not been accessed for some time to the swap space even if there is enough free memory available. By changing the percentage in `/proc/sys/vm/swappiness` you can control that behavior, depending on the system configuration. If swapping is not desired, `/proc/sys/vm/swappiness` should have low values. Systems with memory constraints that run batch jobs (processes that sleep for a long time) might benefit from an aggressive swapping behavior. To change swapping behavior, use either `echo` or `sysctl` as shown in Example 4-7.

*Example 4-7 Changing swappiness behavior*

---

```
# sysctl -w vm.swappiness=100
```

---

- ▶ Especially for fast disk subsystems, it may also be desirable to cause large flushes of dirty memory pages. The value stored in `/proc/sys/vm/dirty_background_ratio` defines at what percentage of main memory the `pdflush` daemon should write data out to the disk. If larger flushes are desired then increasing the default value of 10% to a larger value will cause less frequent flushes. As in the example above the value can be changed as shown in Example 4-8.

*Example 4-8 Increasing the wake up time of pdflush*

---

```
# sysctl -w vm.dirty_background_ratio=25
```

---

- ▶ Another related setting in the virtual memory subsystem is the ratio at which dirty pages created by application disk writes will be flushed out to disk. As explained in chapter one 1.3.1, “Virtual file system”, writes to the file system will not be written instantly but rather written in the page cache and flushed out to the disk subsystem at a later stage. Using the

parameter stored in `/proc/sys/vm/dirty_ratio` the system administrator can define at what level the actual disk writes will take place. The value stored in `dirty_ratio` is a percentage of main memory. A value of 10 would hence mean that data will be written into system memory until the file system cache has a size of 10% of the server's RAM. As in the previous two examples, the ratio at which dirty pages are written to disk can be altered as follows to a setting of 20% of the system memory:

*Example 4-9 Altering the dirty ratio*

---

```
# sysctl -w vm.dirty_ratio=20
```

---

## 4.5.2 Swap partition

The swap device is used when physical RAM is fully in use and the system needs additional memory. Linux also uses swap space to page memory areas to disk that have not been accessed for a significant amount of time. When no free memory is available on the system, it begins paging the least-used data from memory to the swap areas on the disks. The initial swap partition is created during the Linux installation process with current guidelines stating that the size of the swap partition should be two times physical RAM. Linux kernels 2.4 and beyond support swap sizes up to 24 GB per partition with an 8 TB theoretical maximum for 32-bit systems. Swap partitions should reside on separate disks.

If more memory is added to the server after the initial installation, additional swap space must be configured. There are two ways to configure additional swap space after the initial install:

- ▶ A free partition on the disk can be created as a swap partition. This can be difficult if the disk subsystem has no free space available. In that case, a swap file can be created.
- ▶ If there is a choice, the preferred option is to create additional swap partitions. There is a performance benefit because I/O to the swap partitions bypasses the file system and all of the overhead involved in writing to a file.

Another way to improve the performance of swap partitions and files is to create multiple swap partitions. Linux can take advantage of multiple swap partitions or files and perform the reads and writes in parallel to the disks. After creating the additional swap partitions or files, the `/etc/fstab` file will contain such entries as those shown in Example 4-10.

*Example 4-10 /etc/fstab file*

---

<code>/dev/sda2</code>	swap	swap	sw	0 0
<code>/dev/sdb2</code>	swap	swap	sw	0 0
<code>/dev/sdc2</code>	swap	swap	sw	0 0
<code>/dev/sdd2</code>	swap	swap	sw	0 0

---

Under normal circumstances, Linux would use the `/dev/sda2` swap partition first, then `/dev/sdb2`, and so on, until it had allocated enough swapping space. This means that perhaps only the first partition, `/dev/sda2`, will be used if there is no need for a large swap space.

Spreading the data over all available swap partitions improves performance because all read/write requests are performed simultaneously to all selected partitions. Changing the file as shown in Example 4-11 assigns a higher priority level to the first three partitions.

*Example 4-11 Modified /etc/fstab to make parallel swap partitions*

---

<code>/dev/sda2</code>	swap	swap	sw,pri=3	0 0
<code>/dev/sdb2</code>	swap	swap	sw,pri=3	0 0
<code>/dev/sdc2</code>	swap	swap	sw,pri=3	0 0

---

```
/dev/sdd2          swap          swap      sw,pri=1      0 0
```

---

Swap partitions are used from the highest priority to the lowest (where 32767 is the highest and 0 is the lowest). Giving the same priority to the first three disks causes the data to be written to all three disks; the system does not wait until the first swap partition is full before it starts to write on the next partition. The system uses the first three partitions in parallel and performance generally improves.

The fourth partition is used if additional space is needed for swapping after the first three are completely filled up. It is also possible to give all partitions the same priority to stripe the data over all partitions, but if one drive is slower than the others, performance would decrease. A general rule is that the swap partitions should be on the fastest drives available.

**Important:** Although there are good tools to tune the memory subsystem, frequent page outs should be avoided as much as possible. The swap space is not a replacement for RAM because it is stored on physical drives that have a significantly slower access time than memory. Then frequent page out (or swap out) may be almost never a good behavior. Before trying to improve the swap process, ensure that your server simply has enough memory or that there is no memory leak.

### 4.5.3 HugeTLBfs

This memory management feature is valuable for applications that use a large virtual address space. It is especially useful for database applications.

The CPU's Translation Lookaside Buffer (TLB) is a small cache used for storing virtual-to-physical mapping information. By using the TLB, a translation can be performed without referencing the in-memory page table entry that maps the virtual address. However, to keep translations as fast as possible, the TLB is typically quite small. It is not uncommon for large memory applications to exceed the mapping capacity of the TLB.

The HugeTLBfs feature permits an application to use a much larger page size than normal, so that a single TLB entry can map a correspondingly larger address space. A HugeTLB entry can vary in size. For example, in an Itanium® 2 system, a huge page might be 1000 times larger than a normal page. This enables the TLB to map 1000 times the virtual address space of a normal process without incurring a TLB cache miss. For simplicity, this feature is exposed to applications by means of a file system interface.

To allocate hugepage, you can define number of hugepages by configuring value at `/proc/sys/vm/nr_hugepages` using `sysctl` command.

```
sysctl -w vm.nr_hugepages=512
```

If your application use huge pages through the `mmap()` system call, you have to mount a file system of type `hugetlbfs` like this:

```
mount -t hugetlbfs none /mnt/hugepages
```

`/proc/meminfo` file will provide information about hugetlb pages as shown in Example 4-12.

*Example 4-12 Hugepage information in `/proc/meminfo`*

---

```
[root@lnxsu4 ~]# cat /proc/meminfo
MemTotal:      4037420 kB
MemFree:       386664 kB
Buffers:       60596 kB
Cached:        238264 kB
```

```
SwapCached:          0 kB
Active:              364732 kB
Inactive:            53908 kB
HighTotal:           0 kB
HighFree:            0 kB
LowTotal:            4037420 kB
LowFree:             386664 kB
SwapTotal:           2031608 kB
SwapFree:            2031608 kB
Dirty:               0 kB
Writeback:           0 kB
Mapped:              148620 kB
Slab:                24820 kB
CommitLimit:        2455948 kB
Committed_AS:       166644 kB
PageTables:          2204 kB
VmallocTotal: 536870911 kB
VmallocUsed:         263444 kB
VmallocChunk: 536607255 kB
HugePages_Total: 1557
HugePages_Free: 1557
Hugepagesize: 2048 kB
```

---

Please refer to kernel documentation in `Documentation/vm/hugetlbpage.txt` for more information.

## 4.6 Tuning the disk subsystem

Ultimately, all data must be retrieved from and stored to disk. Disk accesses are usually measured in milliseconds and are at least thousands of times slower than other components (such as memory and PCI operations, which are measured in nanoseconds or microseconds). The Linux file system is the method by which data is stored and managed on the disks.

Many different file systems are available for Linux that differ in performance and scalability. Besides storing and managing data on the disks, file systems are also responsible for guaranteeing data integrity. The newer Linux distributions include *journaling* file systems as part of their default installation. Journaling, or logging, prevents data inconsistency in case of a system crash. All modifications to the file system metadata have been maintained in a separate journal or log and can be applied after a system crash to bring it back to its consistent state. Journaling also improves recovery time, because there is no need to perform file system checks at system reboot. As with other aspects of computing, you will find that there is a trade-off between performance and integrity. However, as Linux servers make their way into corporate data centers and enterprise environments, requirements such as high availability can be addressed.

In addition to the various file systems, the Linux kernel 2.6 knows 4 distinct I/O scheduling algorithms that again can be used to tailor the system to a specific task. Each I/O elevator has distinct features that may or may not make it suitable for a specific hardware configuration and a desired task. While some elevators pronounce streaming I/O as it is often found in multi media or desktop PC environments, other elevators focus on low latency access times necessary for database workloads.

In this section we cover the characteristics and tuning options of the standard file system such as ReiserFS and Ext3 as well as the tuning potential found in the kernel 2.6 I/O elevators.

## 4.6.1 Hardware considerations before installing Linux

Minimum requirements for CPU speed and memory are well documented for current Linux distributions. Those instructions also provide guidance for the minimum disk space that is required to complete the installation. However, they fall short on how to initially set up the disk subsystem. Because Linux servers cover a vast assortment of work environments as server consolidation makes its impact in data centers, one of the first questions to answer is: What is the function of the server being installed?

A server's disk subsystems can be a major component of overall system performance. Understanding the function of the server is key to determining whether the I/O subsystem will have a direct impact on performance.

Examples of servers where disk I/O is most important:

- ▶ A file and print server must move data quickly between users and disk subsystems. Because the purpose of a file server is to deliver files to the client, the server must initially read all data from a disk.
- ▶ A database server's ultimate goal is to search and retrieve data from a repository on the disk. Even with sufficient memory, most database servers perform large amounts of disk I/O to bring data records into memory and flush modified data to disk.

Examples of servers where disk I/O is not the most important subsystem:

- ▶ An e-mail server acts as a repository and router for electronic mail and tends to generate a heavy communication load. Networking is more important for this type of server.
- ▶ A Web server that is responsible for hosting Web pages (static, dynamic, or both) benefits from a well-tuned network and memory subsystem.

### Number of drives

The number of disk drives significantly affects performance because each drive contributes to total system throughput. Capacity requirements are often the only consideration that is used to determine the number of disk drives that are configured in a server. Throughput requirements are usually not well understood or are completely ignored. The key to a well-performing disk subsystem is maximizing the number of read-write heads that can service I/O requests.

With RAID (redundant array of independent disks) technology, you can spread the I/O over multiple spindles. There are two options for implementing RAID in a Linux environment: software RAID and hardware RAID. Unless your server hardware comes standard with hardware RAID, you may want to start with the software RAID options that come with the Linux distributions; if a need arises, you can grow into the more efficient hardware RAID solutions.

If it is necessary to implement a hardware RAID array, you will need a RAID controller for your system. In this case the disk subsystem consists of the physical hard disks and the controller.

**Tip:** In general, adding drives is one of the most effective changes that can be made to improve server performance.

It is paramount to remember that the disk subsystem performance ultimately depends on the number of input output requests a given device is able to handle. Once the operating system



cache and the cache of the disk subsystem can no longer accommodate the amount or size of a read or write request, the physical disk spindles have to work. Consider the following example. A disk device is able to handle 200 I/Os per second. You have an application that performs 4kB write requests at random locations on the file systems so streaming or request merging is not an option. The maximum throughput of the specified disk subsystem is now:

$$\text{I/Os per second of physical disk} * \text{request size} = \text{maximum throughput}$$

Hence the example above results in:

$$200 * 4\text{kB} = 800\text{kB}$$

Since the 800kB is a physical maximum, the only possibility to improve performance in this case is to either add more spindles or physical disks or to cause the application to write larger I/Os. Databases such as DB2 can be configured to use larger request sizes that will in most cases improve disk throughput.

For additional, in-depth coverage of the available IBM storage solutions, see:

- ▶ *IBM System Storage Solutions Handbook*, SG24-5250
- ▶ *Introduction to Storage Area Networks*, SG24-5470

## Guidelines for setting up partitions

A partition is a contiguous set of blocks on a drive that are treated as if they were independent disks. The default installation of today's Enterprise Linux distributions use rather flexible partitioning layouts by creating one or more logical volumes.

There is a great deal of debate in Linux circles about the optimal disk partition. A single root partition method may lead to problems in the future if you decide to redefine the partitions because of new or updated requirements. On the other hand, too many partitions can lead to a file system management problem. During the installation process, Linux distributions enable you to create a multipartition layout.

There are benefits to running Linux on a multipartitioned or even logical volume disk:

- ▶ Improved security with finer granularity on file system attributes  
For example, the /var and /tmp partitions are created with attributes that permit very easy access for all users and processes on the system and are susceptible to malicious access. By isolating these partitions to separate disks, you can reduce the impact on system availability if these partitions have to be rebuilt or recovered.
- ▶ Improved data integrity, as loss of data with a disk crash would be isolated to the affected partition  
For example, if there is no RAID implementation on the system (software or hardware) and the server suffers a disk crash, only the partitions on that bad disk would have to be repaired or recovered.
- ▶ New installations and upgrades can be done without affecting other more static partitions.  
For example, if the /home file system has not been separated to another partition, it will be overwritten during an OS upgrade, losing all user files stored on it.
- ▶ More efficient backup process  
Partition layouts must be designed with backup tools in mind. It is important to understand whether backup tools operate on partition boundaries or on a more granular level like file systems.

Table 4-4 lists some of the partitions that you may want to consider separating out from root to provide more flexibility and better performance in your environment.

Table 4-4 Linux partitions and server environments

Partition	Contents and possible server environments
/home	A <i>file server environment</i> would benefit from separating out /home to its own partition. This is the home directory for all users on the system, if there are no disk quotas implemented, so separating this directory should isolate a user's runaway consumption of disk space.
/tmp	If you are running a <i>high-performance computing environment</i> , large amounts of temporary space are needed during compute time, then released upon completion.
/usr	This is where the <i>kernel source tree</i> and Linux <i>documentation</i> (as well as most executable binaries) are located. The /usr/local directory stores the executables that must be accessed by all users on the system and is a good location to store custom scripts developed for your environment. If it is separated to its own partition, then files will not have to be reinstalled during an upgrade or re-install by simply choosing not to have the partition reformatted.
/var	The /var partition is important in <i>mail, Web, and print server environments</i> as it contains the log files for these environments as well as the overall system log. Chronic messages can flood and fill this partition. If this occurs and the partition is not separate from the /, service interruptions are possible. Depending on the environment, further separation of this partition is possible by separating out /var/spool/mail for a mail server or /var/log for system logs.
/opt	The installation of some third-party software products, such as Oracle's database server, default to this partition. If not separate, the installation will continue under / and, if there is not enough space allocated, may fail.

For a more detailed look at how Linux distributions handle file system standards, see the Filesystem Hierarchy Standard's home page at:

<http://www.pathname.com/fhs>

## 4.6.2 I/O elevator tuning and selection

With Linux kernel 2.6 new I/O scheduling algorithms were introduced in order to allow for more flexibility when handling different I/O patterns. A system administrator now has to select the best suited elevator for a given hardware and software layout. Additionally each I/O elevator features a set of tuning options to further tailor a system towards a specific workload.

### Selecting the right I/O elevator in kernel 2.6

For most server workloads, either the Complete Fair Queuing (CFQ) elevator or the deadline elevator are an adequate choice as they are optimized for the multiuser, multiprocess environment a typical server operates in. Enterprise distributions typically default to the CFQ elevator. However on Linux for IBM System z, the deadline scheduler is favoured as the default elevator. Certain environments can benefit from selecting a different I/O elevator. With Red Hat Enterprise Linux 5.0 and Novell SUSE Linux Enterprise Server 10 the I/O schedulers can now be selected on a per disk subsystem basis as opposed to the global setting in Red Hat Enterprise Linux 4.0 and Novell SUSE Linux Enterprise Server 9. With the possibility of different I/O elevators per disk subsystem, the administrator now has the possibility to isolate a specific I/O pattern on a disk subsystem (such as write intensive workloads) and select the appropriate elevator algorithm.

#### ► Synchronous file system access

Certain types of applications need to perform file system operations synchronously. This may be true for databases that may even use a raw file system or for very large disk subsystems where caching asynchronous disk accesses simply is not an option. In those

cases the performance of the anticipatory elevator usually has the least throughput and the highest latency. The three other schedulers perform equally good up to a I/O size of roughly 16kB at where the CFQ and the NOOP elevator begin to outperform the deadline elevator (unless disk access is very seek intense) as can be seen in Figure 4-7.

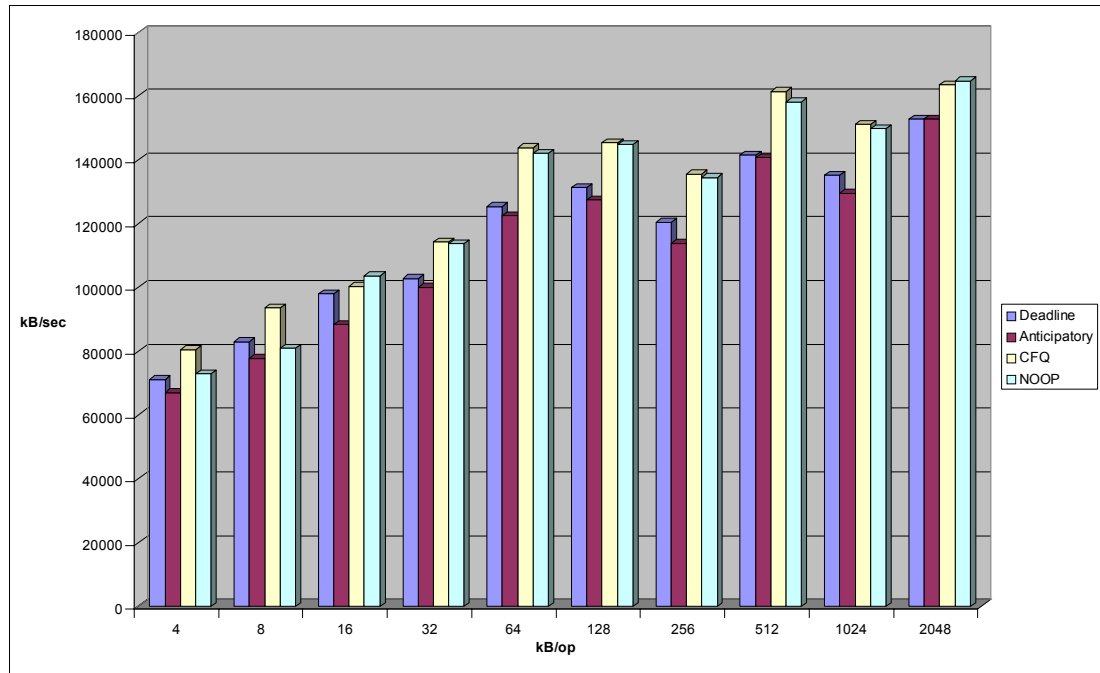

Figure 4-7 Random read performance per I/O elevator (synchronous)

► Complex disk subsystems

Benchmarks have shown that the NOOP elevator is an interesting alternative in high-end server environments. When using very complex configurations of IBM ServeRAID or TotalStorage® DS class disk subsystems, the lack of ordering capability of the NOOP elevator becomes its strength. Enterprise class disk subsystems may contain multiple SCSI or FibreChannel disks that each have individual disk heads and data striped across the disks. It becomes very difficult for an I/O elevator to anticipate the I/O characteristics of such complex subsystems correctly, so you might often observe at least equal performance at less overhead when using the NOOP I/O elevator. Most large scale benchmarks that use hundreds of disks most likely use the NOOP elevator.

► Database systems

Due to the seek-oriented nature of most database workloads some performance gain can be achieved when selecting the deadline elevator for these workloads.

► Virtual machines

Virtual machines, regardless of whether in VMware or VM for System z, usually communicate through a virtualization layer with the underlying hardware. Hence a virtual machine is not aware of the fact if the assigned disk device consists of a single SCSI device or an array of FibreChannel disks on a TotalStorage DS8000™. The virtualization layer takes care of necessary I/O reordering and the communication with the physical block devices.

► CPU bound applications

While some I/O schedulers may offer superior throughput than others they may at the same time also create more system overhead. The overhead that for instance the CFQ or deadline elevator cause comes from aggressively merging and reordering the I/O queue.

Sometimes however the workload is not so much limited by the performance of the disk subsystem but much more by the performance of the CPU. Such a case could be a scientific workload or a data warehouse processing very complex queries. In such scenarios the NOOP elevator offers some advantage over the other elevators as it causes less CPU overhead as shown on the following chart. However it should also be noted that when comparing CPU overhead to throughput the deadline and CFQ elevator still are the best choice for most access patterns to asynchronous file systems.

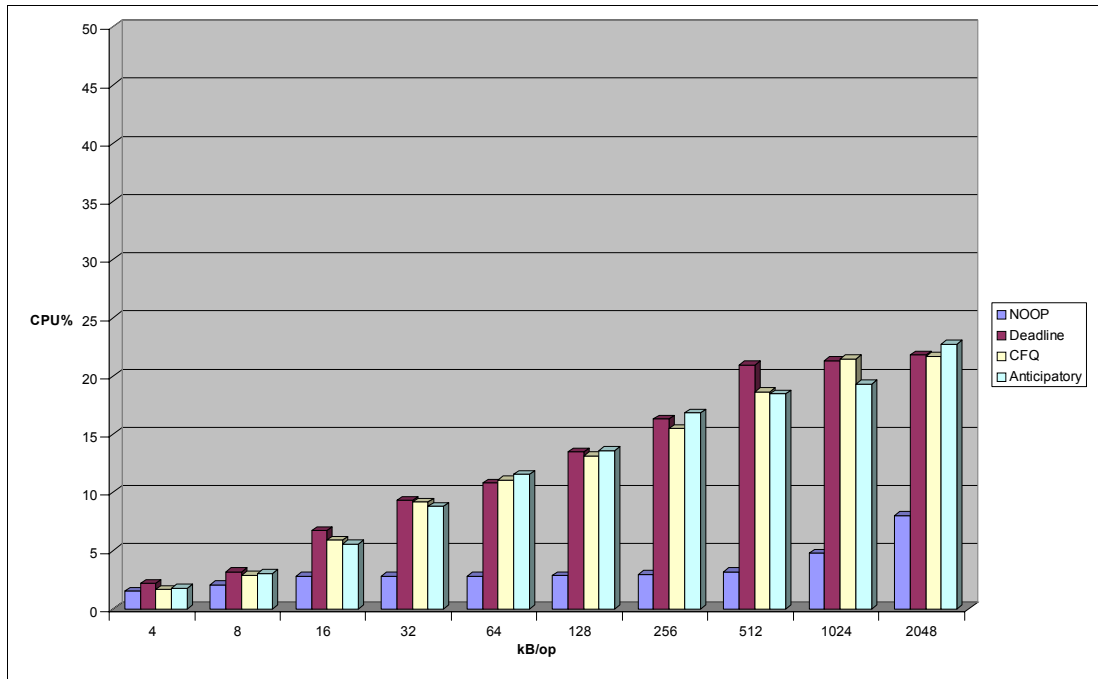

Figure 4-8 CPU utilization by I/O elevator (asynchronous)

► Single ATA or SATA disk subsystems

If you choose to use a single physical ATA or SATA disk, consider using the anticipatory I/O elevator, which reorders disk writes to accommodate the single disk head found in these devices.

### Impact of nr\_requests

The pluggable I/O scheduler implementation of kernel 2.6 also features a possibility to increase or decrease the number of requests that can be issued to a disk subsystem. With `nr_requests` as with so many other tuning parameters there is no one best setting. The correct value that should be used for the number of requests largely depends on the underlying disk subsystem and even more on the I/O characteristics of the workload. The impact of different values of `nr_requests` may also differ from file system and I/O scheduler that you plan to use as can be easily seen by the two benchmarks displayed in Figure 4-9 on page 119 and Figure 4-10 on page 120. As indicated by the chart in Figure 4-9 on page 119 the Deadline elevator is less prone to variations caused by different values of `nr_requests` than the CFQ elevator is.

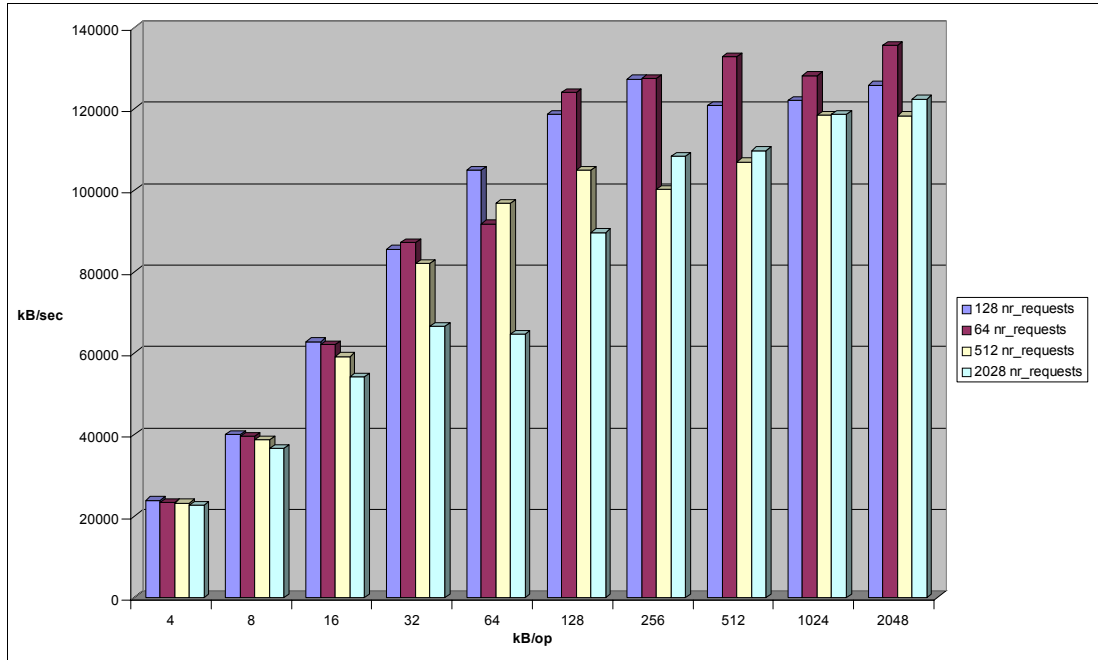

Figure 4-9 Impact of `nr_requests` on the Deadline elevator (random write ReiserFS)

A larger request queue may be offering a higher throughput for workloads that write many small files. As it can be seen in the graphic displayed in Figure 4-10 a setting of 8192 offers the highest levels of performance for I/O sizes of up to 16 kB. At 64 kB the analyzed value of `nr_requests` from 64 up to 8192 offer about equal performance. However as the I/O size increases, smaller levels of `nr_requests` will in most cases result in superior performance. The number of requests can be changed via the following command:

*Example 4-13 Changing `nr_requests`*

---

```
# echo 64 > /sys/block/sdb/queue/nr_requests
```

---

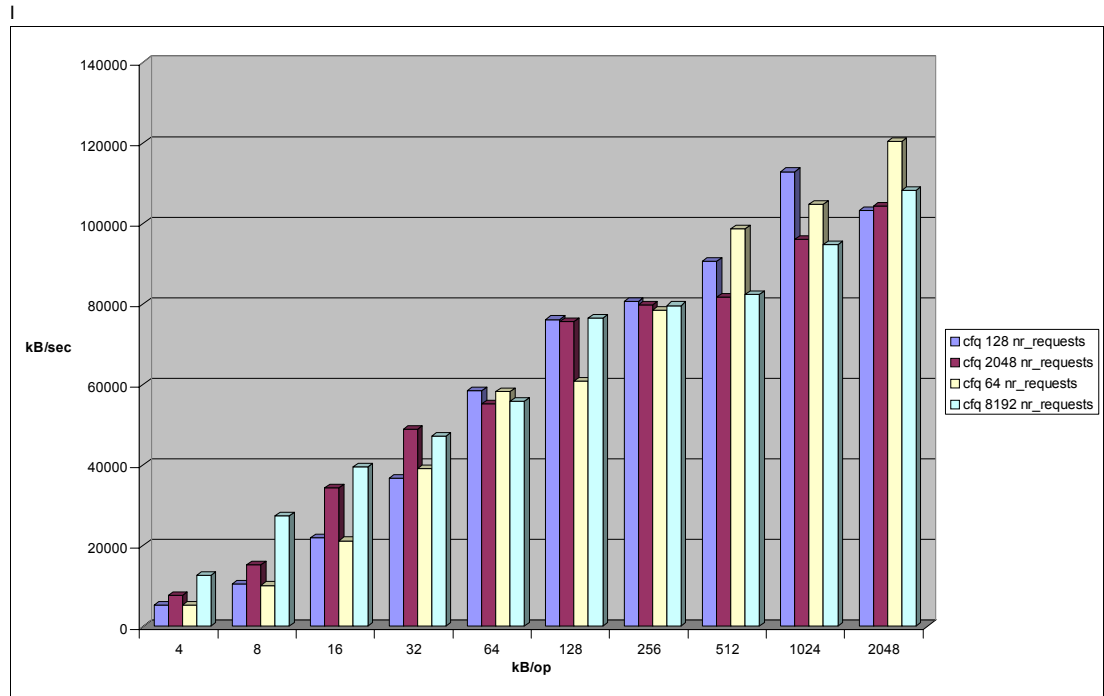

Figure 4-10 Impact of nr\_requests on the CFQ elevator (random write Ext3)

It is important to point out that the current enterprise distributions from Red Hat and Linux offer the possibility to set nr\_requests on a per disk subsystem basis. Hence I/O access patterns can be isolated and optimally tuned. An example would be a database system where the log partitions and the database would be stored on a dedicated disks or disk subsystems (such as a storage partition on a DS8300). In this example it would be beneficial to use a large nr\_requests for the log partition that has to accommodate a large number of small write I/Os and a smaller value for the database partition that might see read I/Os as large as 128kB.

**Tip:** In order to find out how to measure and calculate the average I/O size, please refer to 2.3.6, “iostat” on page 48.

### Impact of read\_ahead\_kb

In the case of large streaming reads, increasing the size of the read ahead buffer may increase performance yet more. Remember though that increasing this value will not increase performance for most server workloads as these are mainly random I/O operations. The value in read\_ahead\_kb defines how large read ahead operations can be. The value stored in /sys/block/<disk\_subsystem>/queue/read\_ahead\_kb defines how large the read operations may be in kB. The value can be parsed or changed using for instance the **cat** or **echo** command as indicated in Example 4-14.

*Example 4-14 Parsing and setting the size of read ahead operations*

```
# cat /sys/block/<disk_subsystem>/queue/read_ahead_kb
# echo 64 > /sys/block/<disk_subsystem>/queue/read_ahead_kb
```

### 4.6.3 File system selection and tuning

As stated in 1.3, “Linux file systems” on page 15 the different file systems that are available for Linux have been designed with different workload and availability characteristics in mind. If your Linux distribution and the application allow the selection of a different file system, it might be worthwhile to investigate if Ext, Journal File System (JFS), ReiserFS or eXtended File System (XFS) is the optimal choice for the planned workload. Generally speaking ReiserFS is more suited to accommodate small I/O requests whereas XFS and JFS are tailored toward very large file systems and very large I/O sizes. Ext3 fits the gap between ReiserFS and JFS/XFS since it can accommodate small I/O requests while offering good multi-processor scalability.

The workload patterns JFS and XFS are best suited for are high-end data warehouses, scientific workloads, large SMP servers or streaming media servers. ReiserFS and Ext3 on the other hand are what would typically be used for a file, web, mail serving. For write intense workloads that create smaller I/Os up to 64kB, ReiserFS may have an edge over Ext3 with default journaling mode as displayed in the chart in Figure 4-11. However this holds only true for synchronous file operations.

An option to consider is the Ext2 file system. Due to it’s lack of journaling abilities Ext2 outperforms ReiserFS and Ext3 for synchronous file system access no matter what the access pattern and I/O size may be. Ext2 may hence be an option where performance is much more important than data integrity.

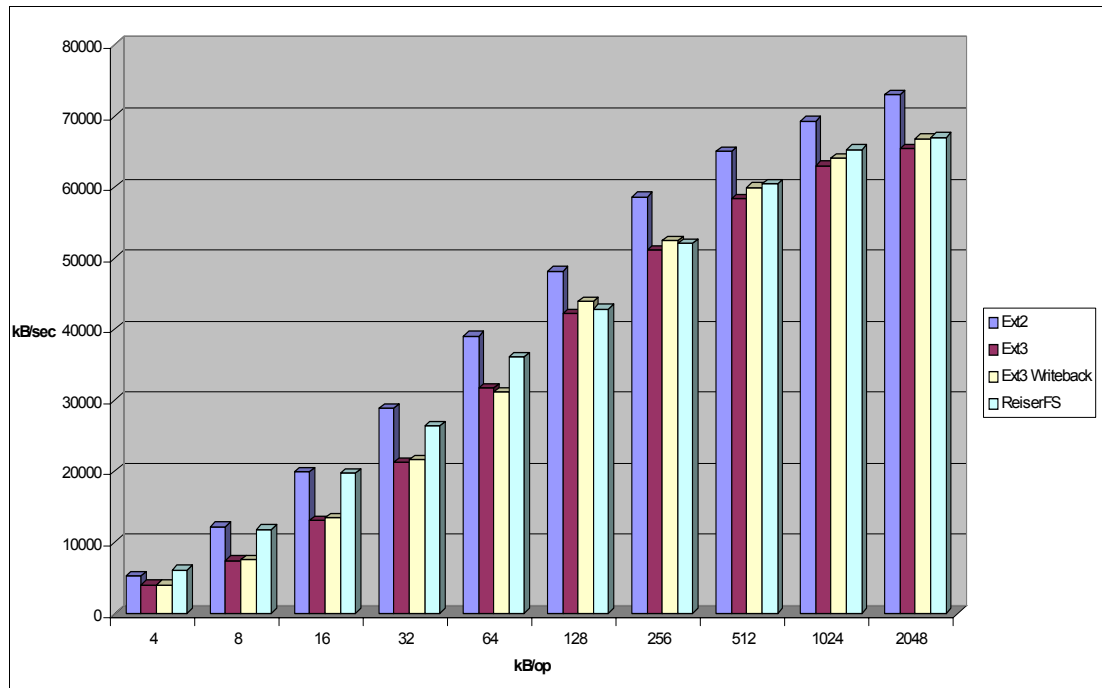

Figure 4-11 Random write throughput comparison between Ext and ReiserFS (synchronous)

In the most common scenario of an asynchronous file system ReiserFS most often delivers solid performance and outperforms Ext3 with the default journaling mode (data=ordered). It should be noted however that Ext3 is on par with ReiserFS as soon as the default journaling mode is switched to writeback as the chart below illustrates (please refer to Figure 4-12).

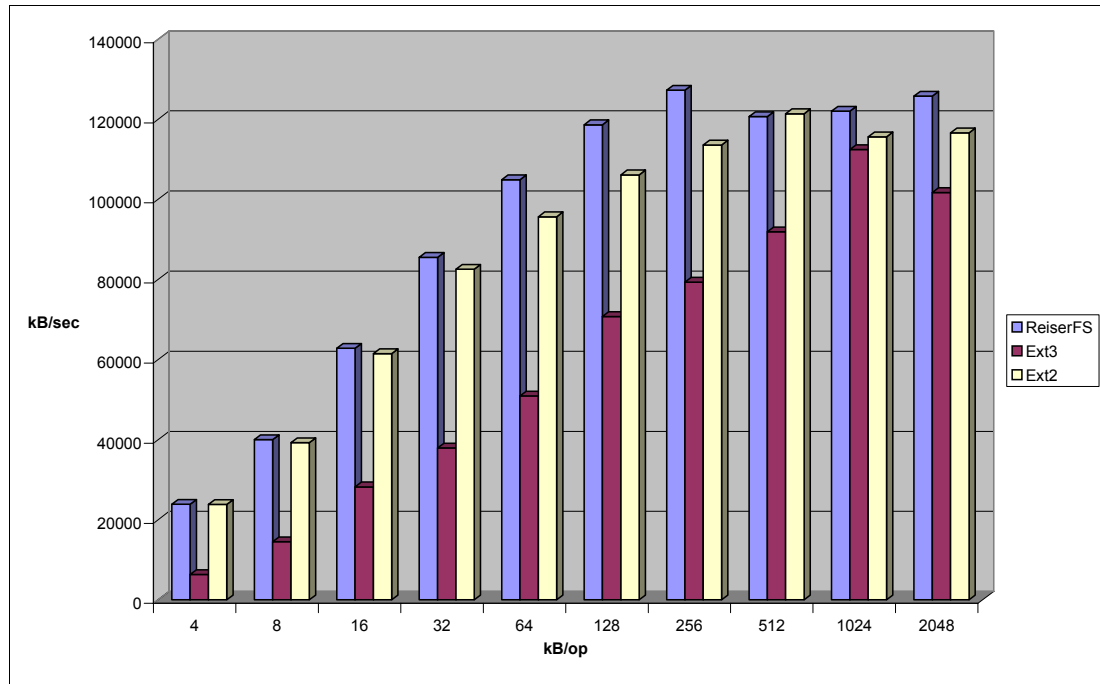

Figure 4-12 Random write throughput comparison between Ext3 and ReiserFS (asynchronous)

## Using `ionice` to assign I/O priority

A new feature of the CFQ I/O elevator is the possibility to assign priorities on a process level. Using the `ionice` utility it is now possible to restrict the disk subsystem utilization of a specific process. At the time of writing this paper there are three priorities that can be assigned using `ionice`, these are:

- ▶ **Idle:** A process with the assigned I/O priority idle will only be granted access to the disk subsystems if no other processes with a priority of **best-effort** or higher request access to data. This setting is hence very useful for tasks that should only run when the system has free resources such as the `updatedb` task.
- ▶ **Best-effort:** As a default all processes that do not request a specific I/O priority are assigned to this class. Processes will inherit 8 levels of the priority of their respective CPU nice level to the I/O priority class.
- ▶ **Real time:** The highest available I/O priority is real time meaning that the respective process will always be given priority access to the disk subsystem. The real time priority setting may also accept 8 priority levels. Caution should be used when assigning a thread a priority level of real time as this process may cause starvation of other tasks.

The `ionice` tool accepts the following options:

- c<#> I/O priority 1 for real time, 2 for best-effort, 3 for idle
- n<#> I/O priority class data 0 to 7
- p<#> process id of a running task, use without -p to start a task with the respective I/O priority

An example of running `ionice` is displayed below in Example 4-15 where `ionice` is used to assign an idle I/O priority to the process with the PID 113.



*Example 4-15 ionice command*

---

```
# ionice -c3 -p113
```

---

## Access time updates

The Linux file system keeps records of when files are created, updated, and accessed. Default operations include updating the last-time-read attribute for files during reads and writes to files. Because writing is an expensive operation, eliminating unnecessary I/O can lead to overall improved performance. However under most conditions disabling file access time updates will yield but a very small performance improvement.

Mounting file systems with the **noatime** option prevents inode access times from being updated. If file and directory update times are not critical to your implementation, as in a Web-serving environment, an administrator might choose to mount file systems with the **noatime** flag in the `/etc/fstab` file as shown in Example 4-16. The performance benefit of disabling access time updates to be written to the file system ranges from 0 to 10% with an average of 3% for file server workloads.

*Example 4-16 Update /etc/fstab file with noatime option set on mounted file systems*

---

```
/dev/sdb1 /mountlocation ext3 defaults,noatime 1 2
```

---

**Tip:** It is generally a good idea to have a separate `/var` partition and mount it with the **noatime** option.

## Select the journaling mode of the file system

Three journaling options of most file system can be set with the **data** option in the **mount** command. However the journaling mode has the biggest effect on performance for Ext3 file systems hence we suggest to use this tuning option mainly for Red Hat's default file system:

▶ **data=journal**

This journaling option provides the highest form of data consistency by causing both file data and metadata to be journalled. It is also has the higher performance overhead.

▶ **data=ordered** (default)

In this mode only metadata is written. However, file data is guaranteed to be written first. This is the default setting.

▶ **data=writeback**

This journaling option provides the fastest access to the data at the expense of data consistency. The data is guaranteed to be consistent as the metadata is still being logged. However, no special handling of actual file data is done and this may lead to old data appearing in files after a system crash. It should be noted that the kind of metadata journaling implemented when using the writeback mode is comparable to the defaults of ReiserFS, JFS or XFS. The writeback journaling mode improves Ext3 performance especially for small I/O sizes as it is clearly visible from the chart displayed under Figure 4-13 on page 124. The benefit of using writeback journaling declines as I/O sizes grow. Also note that the journaling mode of your file system does only impact write performance. Therefore a workload that performs mainly reads (e.g. a web server) will not benefit from changing the journaling mode.

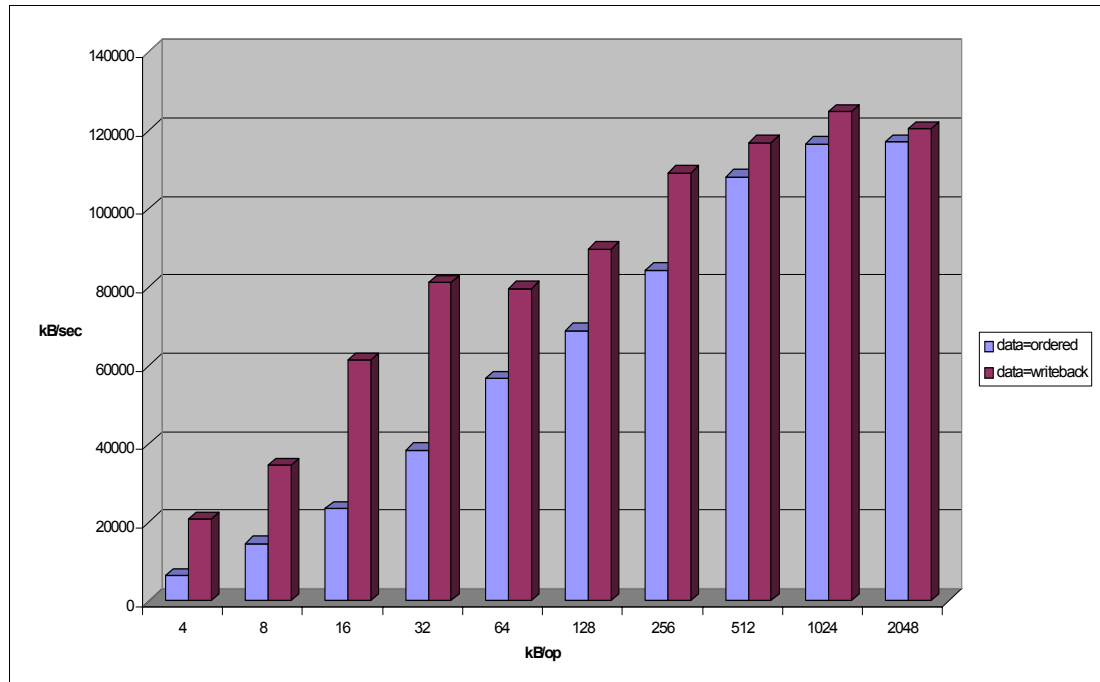

Figure 4-13 Random write performance impact of `data=writeback`

There are three ways to change the journaling mode on a file system:

- ▶ When executing the `mount` command:

```
mount -o data=writeback /dev/sdb1 /mnt/mountpoint
```

- `/dev/sdb1` is the file system being mounted.

- ▶ Including it in the options section of the `/etc/fstab` file:

```
/dev/sdb1 /testfs ext3 defaults,data=writeback 0 0
```

- ▶ If you want to modify the default `data=ordered` option on the root partition, make the change to the `/etc/fstab` file listed above, then execute the `mkinitrd` command to scan the changes in the `/etc/fstab` file and create a new image. Update `grub` or `lilo` to point to the new image.

## Block sizes

The block size, the smallest amount of data that can be read or written to a drive, can have a direct impact on a server's performance. As a guideline, if your server is handling many small files, then a smaller block size will be more efficient. If your server is dedicated to handling large files, a larger block size may improve performance. Block sizes cannot be changed on the fly on existing file systems, and only a reformat will modify the current block size. Most Linux distributions allow block sizes between 1K, 2K, and 4K. As benchmarks have shown, there is hardly any performance improvement to be gained from changing the block size of a file system, hence it is generally better to leave it at the default of 4K.

When a hardware RAID solution is being used, careful consideration must be given to the *stripe size* of the array (or *segment* in the case of Fibre Channel). The *stripe-unit size* is the granularity at which data is stored on one drive of the array before subsequent data is stored on the next drive of the array. Selecting the correct stripe size is a matter of understanding the predominant request size performed by a particular application. The stripe size of a hardware array has, in contrast to the block size of the file system, a significant influence on the overall disk performance.

Streaming and sequential content usually benefits from large stripe sizes by reducing disk head seek time and improving throughput, but the more random type of activity, such as that found in databases, performs better with a stripe size that is equivalent to the record size.

## 4.7 Tuning the network subsystem

The network subsystem should be tuned when the OS is first installed as well as when there is a perceived bottleneck in the network subsystem. A problem here can affect other subsystems: for example, CPU utilization can be affected significantly, especially when packet sizes are too small, and memory use can increase if there is an excessive number of TCP connections.

### 4.7.1 Considerations of traffic characteristics

One of the most important considerations for network performance tuning is to understand network traffic patterns as accurately as possible. Keep in mind that performance greatly varies depending on the network traffic characteristics.

For example, the following two figures shows the result of throughput performance using **netperf** and they illustrate quite different performance characteristics. The only difference is traffic type. Figure 4-14 shows the result of TCP\_RR type traffic and TCP\_CRR type traffic (refer to 2.4.3, “netperf” on page 73). This performance difference is mainly caused by the TCP session connect and close operations overhead and the major factor is Netfilter connection tracking (refer to 4.7.6, “Performance impact of Netfilter” on page 133).

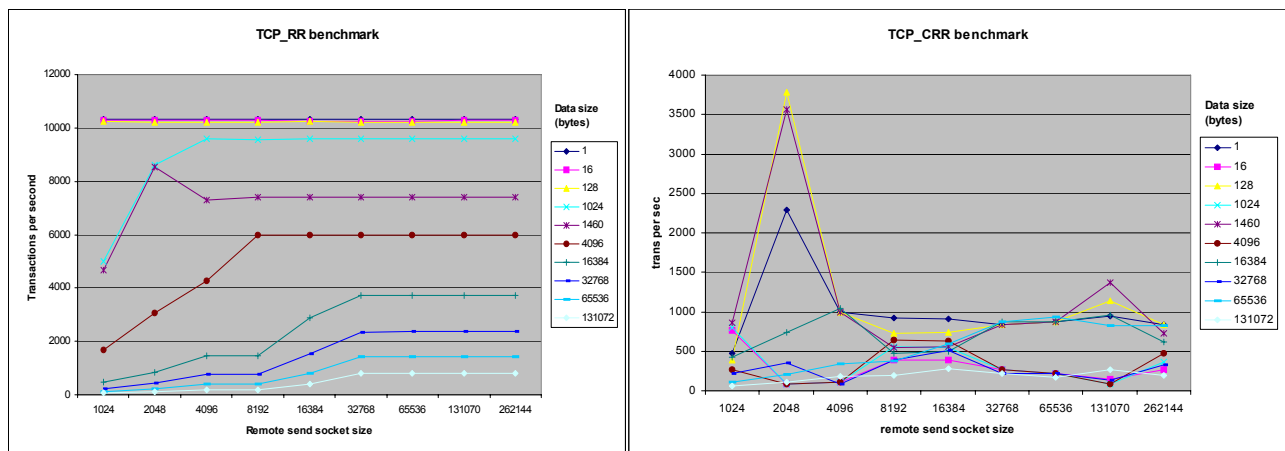

Figure 4-14 An example result of netperf TCP\_RR and TCP\_CRR benchmark

As we have shown here, even in exactly the same configuration, performance varies greatly depending on even slight traffic characteristics differences. You should take much care of network traffic characteristics and requirements. At least be familiar or have a reasonable guess about the followings.

- ▶ Transaction throughput requirements (peak, average)
- ▶ Data transfer throughput requirements (peak, average)
- ▶ Latency requirements
- ▶ Transfer data size
- ▶ Proportion of send and receive
- ▶ Frequency of connection establishment and close or number of concurrent connections.
- ▶ Protocol (TCP, UDP and application protocol such as HTTP, SMTP, LDAP etc.)

**netstat**, **tcpdump** and **ethereal** are useful tools to get more accurate characteristics (Refer to 2.3.11, “netstat” on page 53 and 2.3.13, “tcpdump / ethereal” on page 55).

### 4.7.2 Speed and duplexing

It may sound trivial but one of the easiest ways to improve network performance is by checking the actual speed of the network interface because there can be issues between network components (such as switches or hubs) and the network interface cards. The mismatch can have a large performance impact as shown in Example 4-17.

*Example 4-17 Using ethtool to check the actual speed and duplex settings*

```
[root@linux ~]# ethtool eth0
Settings for eth0:
    Supported ports: [ MII ]
    Supported link modes:   10baseT/Half 10baseT/Full
                           100baseT/Half 100baseT/Full
                           1000baseT/Half 1000baseT/Full
    Supports auto-negotiation: Yes
    Advertised link modes:  10baseT/Half 10baseT/Full
                           100baseT/Half 100baseT/Full
                           1000baseT/Half 1000baseT/Full
    Advertised auto-negotiation: Yes
    Speed: 100Mb/s
    Duplex: Full
```

From the benchmark results shown in Figure 4-15, note that a small data transfer is less impacted than a larger data transfer when network speeds are incorrectly negotiated. Especially data transfers larger than 1KB shows the drastic performance impact (throughput declines 50-90%). Make sure that the speed and duplex are correctly set.

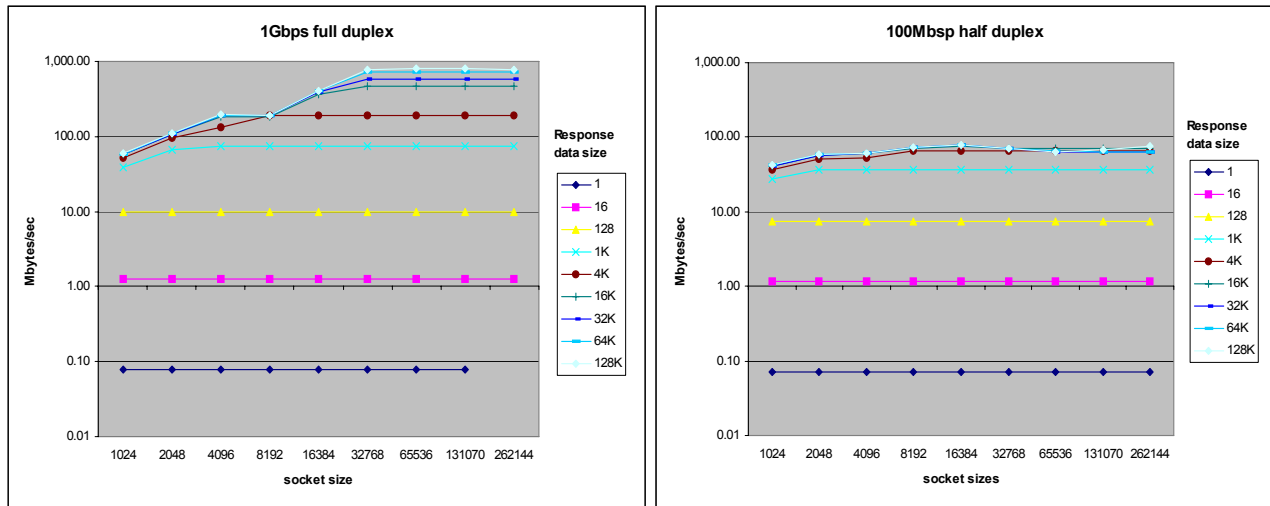

Figure 4-15 Performance degradation caused by auto negotiation failure

Numerous network devices default to 100 Mb half-duplex in case of a minor mismatch during the auto negotiation process. To check for the actual line speed and duplex setting of a network connection, use the **ethtool** command.

Note that most network administrators believe that the best way to attach a network interface to the network is by specifying static speeds at both the NIC and the switch or hub port. To

change the configuration, you can use **ethtool** if the device driver supports the **ethtool** command. You may have to change `/etc/modules.conf` for some device drivers.

### 4.7.3 MTU size

Especially in Gigabit networks, large maximum transmission units (MTU) sizes (also known as JumboFrames) may provide better network performance. The challenge with large MTU sizes is the fact that most networks do not support them and that there are a number of network cards that also do not support large MTU sizes. If your objective is transferring large amounts of data at gigabit speeds (as in HPC environments, for example), increasing the default MTU size can provide significant performance gains. In order to change the MTU size, use `/sbin/ifconfig` as shown in Example 4-17.

*Example 4-18 Changing the MTU size with ifconfig*

---

```
[root@linux ~]# ifconfig eth0 mtu 9000 up
```

---

**Attention:** For large MTU sizes to work, they must be supported by both the network interface card and the network components.

### 4.7.4 Increasing network buffers

The Linux network stack is rather cautious when it comes to assigning memory resources to network buffers. In modern high-speed networks that connect server systems, these values should be increased to enable the system to handle more network packets.

- ▶ Initial overall TCP memory is calculated automatically based on system memory; you can find the actual values in:

```
/proc/sys/net/ipv4/tcp_mem
```

- ▶ Set the default and maximum amount for the receive socket memory to a higher value:

```
/proc/sys/net/core/rmem_default
/proc/sys/net/core/rmem_max
```

- ▶ Set the default and maximum amount for the send socket to a higher value:

```
/proc/sys/net/core/wmem_default
/proc/sys/net/core/wmem_max
```

- ▶ Adjust the maximum amount of option memory buffers to a higher value:

```
/proc/sys/net/core/optmem_max
```

#### Tuning window sizes

Maximum window sizes can be tuned by the network buffer size parameters described above. Theoretical optimal window sizes can be obtained by using BDP (bandwidth delay product). BDP is the total amount of data that resides on the wire in transit. BDP is calculated with this simple formula:

$$\text{BDP} = \text{Bandwidth (bytes/sec)} * \text{Delay (or round trip time) (sec)}$$

To keep the network pipe always full and fully utilize the line, network nodes should have buffers available to store the same size of data as BDP. Otherwise, a sender has to stop sending data and wait for acknowledgement to come from the receiver (refer to “Traffic control” on page 32).

For example, in a Gigabit Ethernet LAN with 1msec delay BDP comes to:

125Mbytes/sec (1Gbit/sec) \* 1msec = 125Kbytes

As the default value of `rmem_max` and `wmem_max` are about 128Kbytes in most enterprise distributions, it may be fair enough for low-latency general purpose network environment. However if the latency is large, the default size may be too small.

Taking another example, assuming that a samba file server has to support 16 concurrent file transfer session from various locations, socket buffer size for each session comes down to 8Kbytes in default configuration. This may be relatively small if the data transfer is high.

- ▶ Set the max OS send buffer size (`wmem`) and receive buffer size (`rmem`) to 8 MB for queues on all protocols:

```
sysctl -w net.core.wmem_max=8388608
sysctl -w net.core.rmem_max=8388608
```

These specify the amount of memory that is allocated for each TCP socket when it is created.

- ▶ In addition, you should also use the following commands for send and receive buffers. They specify three values: minimum size, initial size, and maximum size:

```
sysctl -w net.ipv4.tcp_rmem="4096 87380 8388608"
sysctl -w net.ipv4.tcp_wmem="4096 87380 8388608"
```

The third value must be the same as or less than the value of `wmem_max` and `rmem_max`. However we also suggest increasing the first value on high-speed, high-quality networks so that the TCP windows start out at a sufficiently high value.

- ▶ Increase the values in `/proc/sys/net/ipv4/tcp_mem`. The three values refer to minimum, pressure, and maximum memory allocations for TCP memory

You can see what's been changed by socket buffer tuning using `tcpdump`. As the examples show, limiting socket buffer to small size results in small window size and causes frequent acknowledgement packets and inefficient use (Example 4-19). On the contrary, making socket buffer large results in a large window size (Example 4-20).

*Example 4-19 Small window size (rmem, wmem=4096)*

---

```
[root@lnxsu5 ~]# tcpdump -ni eth1
22:00:37.221393 IP plnxsu4.34087 > plnxsu5.32837: P 18628285:18629745(1460) ack 9088 win 46
22:00:37.221396 IP plnxsu4.34087 > plnxsu5.32837: . 18629745:18631205(1460) ack 9088 win 46
22:00:37.221499 IP plnxsu5.32837 > plnxsu4.34087: . ack 18629745 win 37
22:00:37.221507 IP plnxsu4.34087 > plnxsu5.32837: P 18631205:18632665(1460) ack 9088 win 46
22:00:37.221511 IP plnxsu4.34087 > plnxsu5.32837: . 18632665:18634125(1460) ack 9088 win 46
22:00:37.221614 IP plnxsu5.32837 > plnxsu4.34087: . ack 18632665 win 37
22:00:37.221622 IP plnxsu4.34087 > plnxsu5.32837: P 18634125:18635585(1460) ack 9088 win 46
22:00:37.221625 IP plnxsu4.34087 > plnxsu5.32837: . 18635585:18637045(1460) ack 9088 win 46
22:00:37.221730 IP plnxsu5.32837 > plnxsu4.34087: . ack 18635585 win 37
22:00:37.221738 IP plnxsu4.34087 > plnxsu5.32837: P 18637045:18638505(1460) ack 9088 win 46
22:00:37.221741 IP plnxsu4.34087 > plnxsu5.32837: . 18638505:18639965(1460) ack 9088 win 46
22:00:37.221847 IP plnxsu5.32837 > plnxsu4.34087: . ack 18638505 win 37
```

---

*Example 4-20 Large window size (rmem, wmem=524288)*

---

```
[root@lnxsu5 ~]# tcpdump -ni eth1
22:01:25.515545 IP plnxsu4.34088 > plnxsu5.40500: . 136675977:136677437(1460) ack 66752 win 46
22:01:25.515557 IP plnxsu4.34088 > plnxsu5.40500: . 136687657:136689117(1460) ack 66752 win 46
22:01:25.515568 IP plnxsu4.34088 > plnxsu5.40500: . 136699337:136700797(1460) ack 66752 win 46
22:01:25.515579 IP plnxsu4.34088 > plnxsu5.40500: . 136711017:136712477(1460) ack 66752 win 46
22:01:25.515592 IP plnxsu4.34088 > plnxsu5.40500: . 136722697:136724157(1460) ack 66752 win 46
```

---

```

22:01:25.515601 IP plnxsu4.34088 > plnxsu5.40500: . 136734377:136735837(1460) ack 66752 win 46
22:01:25.515610 IP plnxsu4.34088 > plnxsu5.40500: . 136746057:136747517(1460) ack 66752 win 46
22:01:25.515617 IP plnxsu4.34088 > plnxsu5.40500: . 136757737:136759197(1460) ack 66752 win 46
22:01:25.515707 IP plnxsu5.40500 > plnxsu4.34088: . ack 136678897 win 3061
22:01:25.515714 IP plnxsu5.40500 > plnxsu4.34088: . ack 136681817 win 3061
22:01:25.515764 IP plnxsu5.40500 > plnxsu4.34088: . ack 136684737 win 3061
22:01:25.515768 IP plnxsu5.40500 > plnxsu4.34088: . ack 136687657 win 3061
22:01:25.515774 IP plnxsu5.40500 > plnxsu4.34088: . ack 136690577 win 3061
    
```

### Impact of socket buffer size

Small socket buffers may cause performance degradation when a server deals with many concurrent large file transfer. As Figure 4-16 shows, a clear performance decline is observed when using small socket buffers. A low value of `rmem_max` and `wmem_max` limit available socket buffer sizes even if the peer has affordable socket buffers available. This causes small window sizes and creates a performance ceiling for large data transfers. Though not included in this chart, no clear performance difference is observed for small data (less than 4Kbytes) transfer.



Figure 4-16 the comparison with socket buffer 4Kbytes and 132 bytes

### 4.7.5 Additional TCP/IP tuning

There are many other configuration options which may increase or decrease network performance. The parameters we describe below may help to prevent a decrease in network performance. The following `sysctl` commands are used to change these parameters.

#### Tuning IP and ICMP behavior

- ▶ Disabling the following parameters prevents a cracker from using a spoofing attack against the IP address of the server:

```
sysctl -w net.ipv4.conf.eth0.accept_source_route=0
```

```
sysctl -w net.ipv4.conf.lo.accept_source_route=0
sysctl -w net.ipv4.conf.default.accept_source_route=0
sysctl -w net.ipv4.conf.all.accept_source_route=0
```

- ▶ These commands configure the server to ignore redirects from machines that are listed as gateways. Redirect can be used to perform attacks, so we only want to allow them from trusted sources:

```
sysctl -w net.ipv4.conf.eth0.secure_redirects=1
sysctl -w net.ipv4.conf.lo.secure_redirects=1
sysctl -w net.ipv4.conf.default.secure_redirects=1
sysctl -w net.ipv4.conf.all.secure_redirects=1
```

- ▶ You could allow the interface to accept or not accept any ICMP redirects. The ICMP redirect is a mechanism for routers to convey routing information to hosts. For example, the gateway can send a redirect message to a host when the gateway receives an Internet datagram from a host on a network to which the gateway is attached. The gateway checks the routing table to get the address of the next gateway, and the second gateway routes the Internet datagram to the network destination. Disable these redirects using the following commands:

```
sysctl -w net.ipv4.conf.eth0.accept_redirects=0
sysctl -w net.ipv4.conf.lo.accept_redirects=0
sysctl -w net.ipv4.conf.default.accept_redirects=0
sysctl -w net.ipv4.conf.all.accept_redirects=0
```

- ▶ If this server does not act as a router, it does not have to send redirects, so they can be disabled:

```
sysctl -w net.ipv4.conf.eth0.send_redirects=0
sysctl -w net.ipv4.conf.lo.send_redirects=0
sysctl -w net.ipv4.conf.default.send_redirects=0
sysctl -w net.ipv4.conf.all.send_redirects=0
```

- ▶ Configure the server to ignore broadcast pings and smurf attacks:

```
sysctl -w net.ipv4.icmp_echo_ignore_broadcasts=1
```

- ▶ Ignore all kinds of icmp packets or pings:

```
sysctl -w net.ipv4.icmp_echo_ignore_all=1
```

- ▶ Some routers send invalid responses to broadcast frames, and each one generates a warning that is logged by the kernel. These responses can be ignored:

```
sysctl -w net.ipv4.icmp_ignore_bogus_error_responses=1
```

- ▶ We should set the ipfrag parameters, particularly for NFS and Samba servers. Here, we can set the maximum and minimum memory used to reassemble IP fragments. When the value of ipfrag\_high\_thresh in bytes of memory is allocated for this purpose, the fragment handler will drop packets until ipfrag\_low\_thresh is reached.

Fragmentation occurs when there is an error during the transmission of TCP packets. Valid packets are stored in memory (as defined with these parameters) while corrupted packets are retransmitted.

For example, to set the range of available memory to between 256 MB and 384 MB, use:

```
sysctl -w net.ipv4.ipfrag_low_thresh=262144
sysctl -w net.ipv4.ipfrag_high_thresh=393216
```



## Tuning TCP behavior

Here we describe some of tuning parameters that will change TCP behaviors.

The following commands can be used for tuning servers that support a large number of multiple connections:

- ▶ For servers that receive many connections at the same time, the TIME-WAIT sockets for new connections can be reused. This is useful in Web servers, for example:

```
sysctl -w net.ipv4.tcp_tw_reuse=1
```

If you enable this command, you should also enable fast recycling of TIME-WAIT sockets status:

```
sysctl -w net.ipv4.tcp_tw_recycle=1
```

Figure 4-17 shows that with these parameters enabled, the number of connections is significantly reduced. This is good for performance because each TCP transaction maintains a cache of protocol information about each of the remote clients. In this cache, information such as round-trip time, maximum segment size, and congestion window are stored. For more details, review RFC 1644.

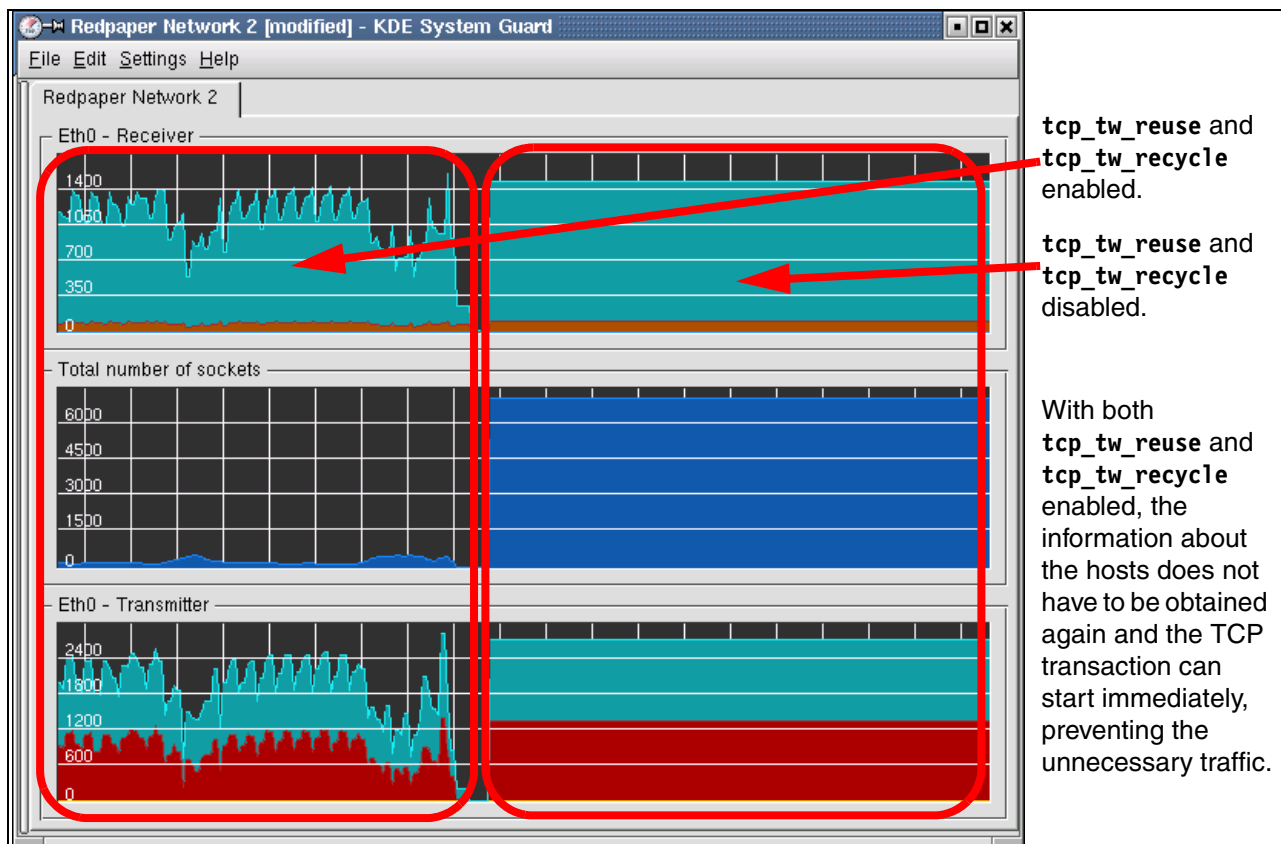

Figure 4-17 Parameters reuse and recycle enabled (left) and disabled (right)

- ▶ The parameter `tcp_fin_timeout` is the time to hold a socket in state FIN-WAIT-2 when the socket is closed at the server.

A TCP connection begins with a three-segment synchronization SYN sequence and ends with a three-segment FIN sequence, neither of which holds data. By changing the `tcp_fin_timeout` value, the time from the FIN sequence to when the memory can be freed for new connections can be reduced, thereby improving performance. This value, however,

should be changed only after careful monitoring, as there is a risk of overflowing memory because of the number of dead sockets:

```
sysctl -w net.ipv4.tcp_fin_timeout=30
```

- ▶ One of the problems found in servers with many simultaneous TCP connections is the large number of connections that are open but unused. TCP has a keepalive function that probes these connections and, by default, drops them after 7200 seconds (2 hours). This length of time may be too long for your server and may result in excess memory usage and a decrease in server performance.

Setting it to 1800 seconds (30 minutes), for example, may be more appropriate:

```
sysctl -w net.ipv4.tcp_keepalive_time=1800
```

- ▶ When the server is heavily loaded or has many clients with bad connections with high latency, it can result in an increase in half-open connections. This is common for Web servers, especially when there are many dial-up users. These half-open connections are stored in the *backlog connections* queue. You should set this value to at least 4096. (The default is 1024.)

Setting this value is useful even if your server does not receive this kind of connection, as it can still be protected from a DoS (syn-flood) attack.

```
sysctl -w net.ipv4.tcp_max_syn_backlog=4096
```

- ▶ While TCP SYN cookies are helpful in protecting the server from syn-flood attacks, both denial-of-service (DoS) or distributed denial-of-service (DDoS), they may have an adverse effect on performance. We suggest enabling TCP SYN cookies only when there is a clear need for them.

```
sysctl -w net.ipv4.tcp_syncookies=1
```

**Note:** This command is valid only when the kernel is compiled with CONFIG\_SYNCOOKIES.

## Tuning TCP options

- ▶ Selective acknowledgments are a way of optimizing TCP traffic considerably. However, SACKs and DSACKs may adversely affect performance on Gigabit networks. While enabled by default, `tcp_sack` and `tcp_dsack` oppose optimal TCP/IP performance in high-speed networks and should be disabled.

```
sysctl -w net.ipv4.tcp_sack=0
sysctl -w net.ipv4.tcp_dsack=0
```

- ▶ Every time an Ethernet frame is forwarded to the network stack of the Linux kernel, it receives a time stamp. This behavior is useful and necessary for edge systems such as firewalls and Web servers, but backend systems may benefit from disabling the TCP time stamps by reducing some overhead. TCP timestamps can be disabled via this call:

```
sysctl -w net.ipv4.tcp_timestamps=0
```

- ▶ We have also learned that window scaling may be an option to enlarge the transfer window. However, benchmarks have shown that window scaling is not suited for systems experiencing very high network load. Additionally, some network devices do not follow the RFC guidelines and may cause window scaling to malfunction. We suggest disabling window scaling and manually setting the window sizes.

```
sysctl -w net.ipv4.tcp_window_scaling=0
```

### 4.7.6 Performance impact of Netfilter

As Netfilter provides TCP/IP connection tracking and packet filtering capability (refer to “Netfilter” on page 29), in certain circumstances it may have a large performance impact. The impact is clearly visible when the number of connection establishments is high. Figure 4-18 and Figure 4-19 show benchmark results with large and small connection establishments counts. The results clearly illustrate the effect of the Netfilter.

When no Netfilter rule is applied (Figure 4-18), the result shows quite similar performance characteristics to a benchmark that connection establishment rarely occurs (refer to the left chart of Figure 4-14 on page 125) while absolute throughput still differs because of connection establishment overhead.

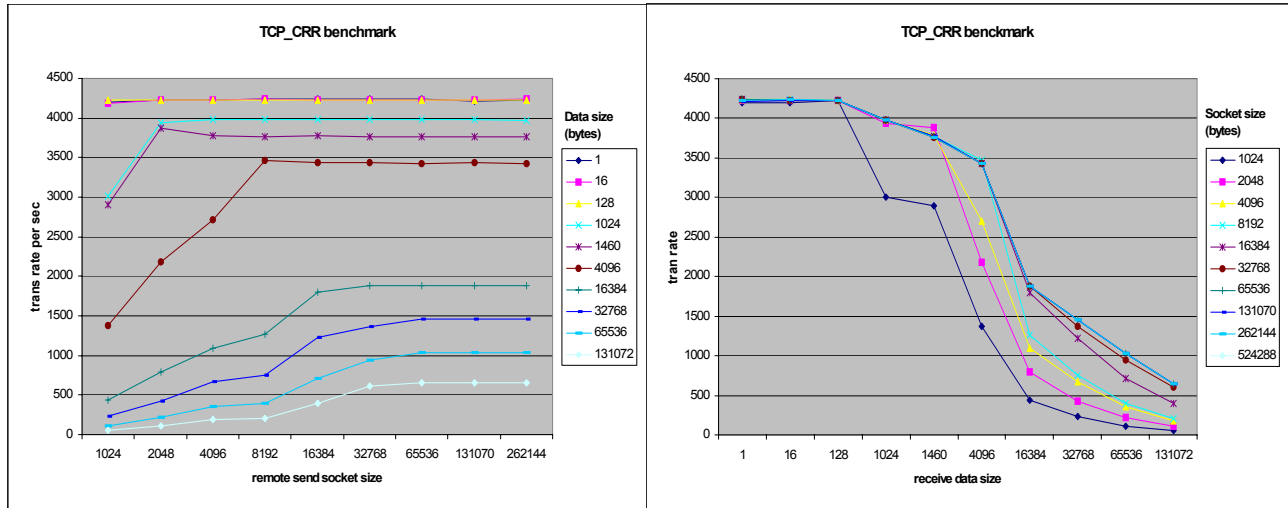

Figure 4-18 No Netfilter rule applied

However, when filtering rules are applied, relatively inconsistent behavior can be seen (Figure 4-19).

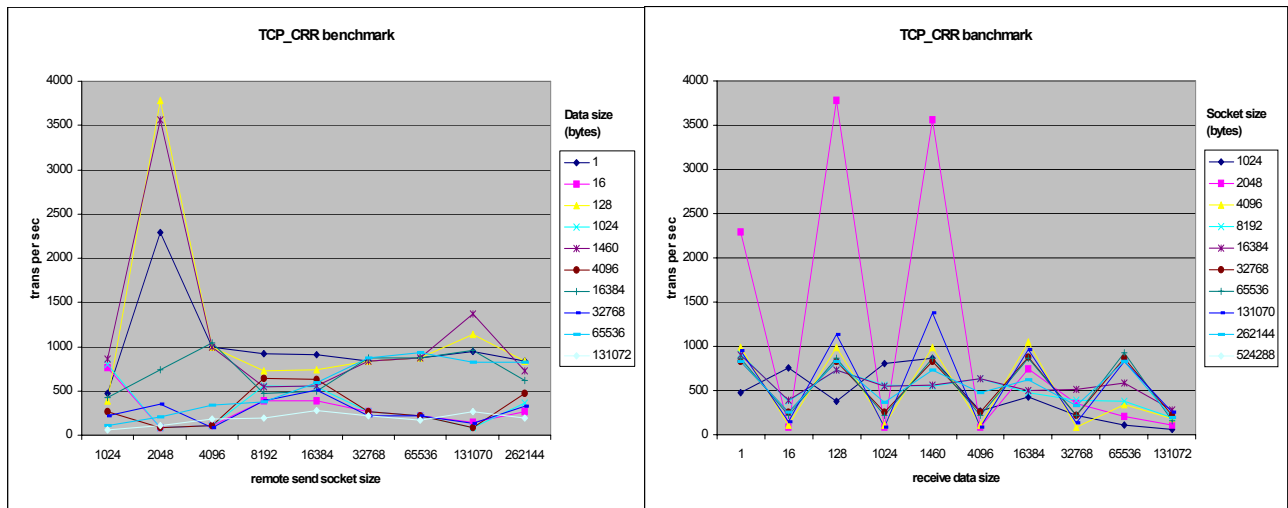

Figure 4-19 Netfilter rules applied

However, Netfilter provides packet filtering capability and enhances network security. It can be a trade-off between security and performance. How much the Netfilter performance impact is depends on the following factors:

- ▶ Number of rules
- ▶ Order of rules
- ▶ Complexity of rules
- ▶ Connection tracking level (depends on protocols)
- ▶ Netfilter kernel parameter configuration

### 4.7.7 Offload configuration

As we described in 1.5.3, “Offload” on page 33, some network operations can be offloaded to a network interface device if it supports the capability. You can use the `ethtool` command to check the current offload configurations.

*Example 4-21 Checking offload configurations*

---

```
[root@lnxsu5 plnxsu4]# ethtool -k eth0
Offload parameters for eth0:
rx-checksumming: off
tx-checksumming: off
scatter-gather: off
tcp segmentation offload: off
udp fragmentation offload: off
generic segmentation offload: off
```

---

Change the configuration command syntax is as follows:

```
ethtool -K DEVNAME [ rx on|off ] [ tx on|off ] [ sg on|off ] [ tso on|off ] [
ufo on|off ] [ gso on|off ]
```

*Example 4-22 Example of offload configuration change*

---

```
[root@lnxsu5 plnxsu4]# ethtool -k eth0 sg on tso on gso off
```

---

Supported offload capability may differ by network interface device, Linux distribution, kernel version and the platform you choose. If you issue an unsupported offload parameter, you may get some error messages.

### Impact of offloading

Benchmarks have shown that the CPU utilization can be reduced by NIC offloading. Figure 4-20 on page 135 shows the higher CPU utilization improvement in large data size (more than 32Kbytes). The large packets take advantage of checksum offloading because checksumming needs to calculate the entire packet, so more processing power is consumed as the data size increases.

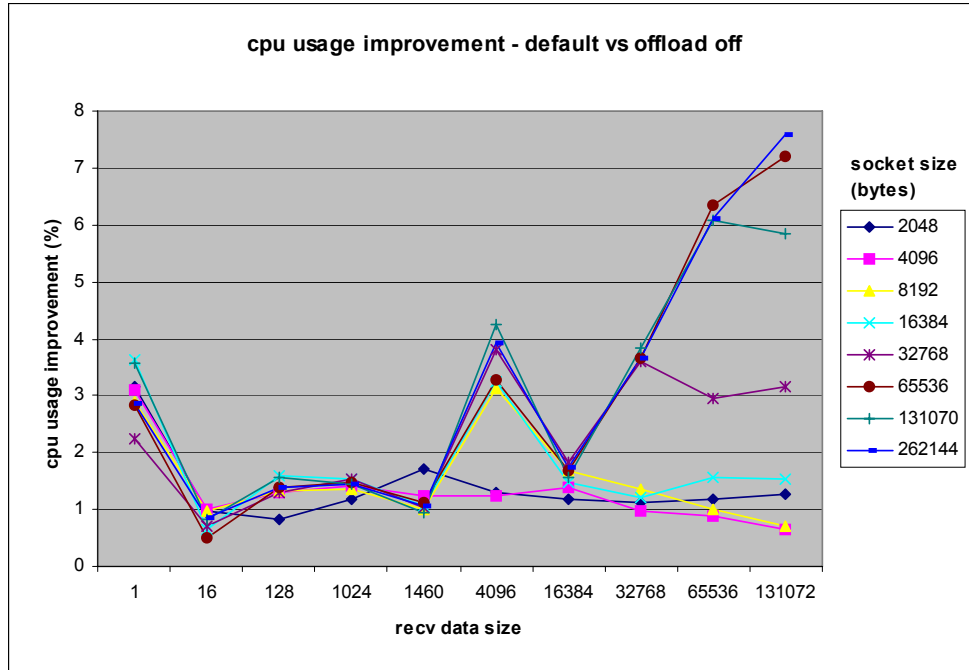

Figure 4-20 CPU usage improvement by offloading

However, a slight performance degradation is observed in using offloading (Figure 4-21). The processing of checksums for such a high packet rate is a significant load on certain LAN adapter processors. As the packet size gets larger, fewer packets per second are being generated (because it takes a longer time to send and receive all that data) and it is prudent to offload the checksum operation on to the adapter.

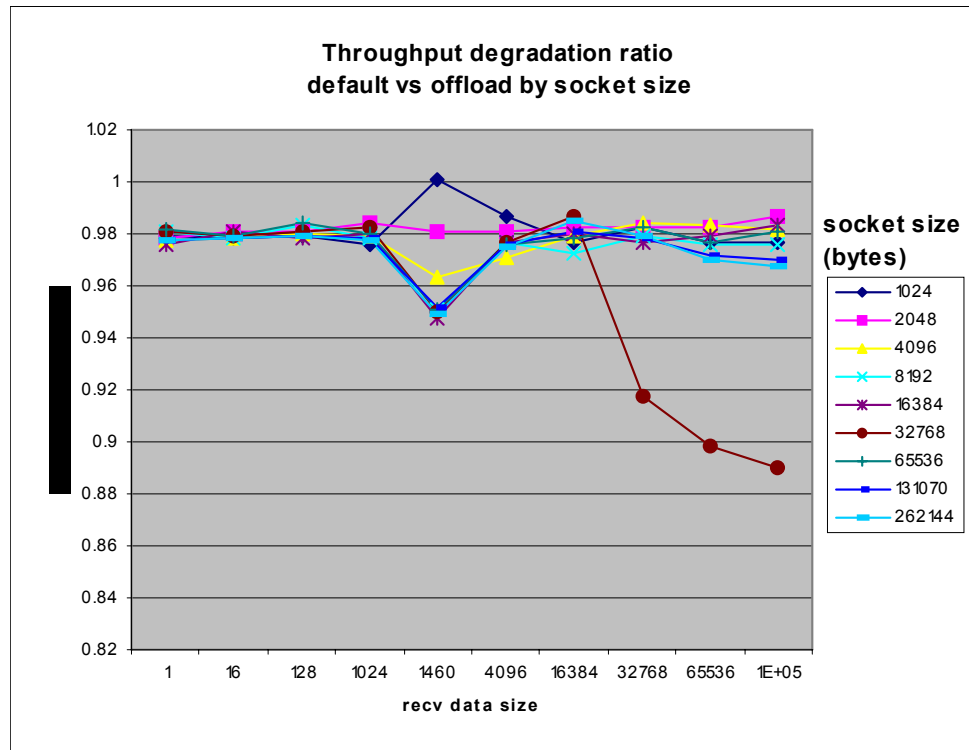

Figure 4-21 Throughput degradation by offloading

LAN adapters are efficient when network applications requesting data generate requests for large frames. Applications that request small blocks of data require the LAN adapter communication processor to spend a larger percentage of time executing overhead code for every byte of data transmitted. This is why most LAN adapters cannot sustain full wire speed for all frame sizes.

Refer to *Tuning IBM System x Servers for Performance*, SG24-5287, section 10.3. Advance d network features for more details.

### 4.7.8 Increasing the packet queues

After increasing the size of the various network buffers, it is suggested that the amount of allowed unprocessed packets be increased, so that the kernel will wait longer before dropping packets. To do so, edit the value in `/proc/sys/net/core/netdev_max_backlog`.

### 4.7.9 Increasing the transmit queue length

Increase the `txqueuelen` parameter to a value between 1000 and 20000 per interface. This is especially useful for high-speed connections that perform large, homogeneous data transfers. The transmit queue length can be adjusted by using the `ifconfig` command as shown in Example 4-23.

*Example 4-23 Setting the transmit queue length*

---

```
[root@linux ipv4]# ifconfig eth1 txqueuelen 2000
```

---

### 4.7.10 Decreasing interrupts

Handling network packets requires the Linux kernel to handle a significant amount of interrupts and context switches unless NAPI is being used. For Intel e1000-based network interface cards, make sure that the network card driver was compiled with the `CFLAGS_EXTRA -DCONFIG_E1000_NAPI` flag. Broadcom tg3 modules should come in their newest version with built-in NAPI support.

If you need to recompile the Intel e1000 driver in order to enable NAPI, you can do so by issuing the following command on your build system:

```
make CFLAGS_EXTRA -DCONFIG_E1000_NAPI
```

In addition, on multiprocessor systems, binding the interrupts of the network interface cards to a physical CPU may yield additional performance gains. To achieve this goal you first have to identify the IRQ by the respective network interface. The data obtained via the `ifconfig` command will inform you of the interrupt number.

*Example 4-24 Identifying the interrupt*

---

```
[root@linux ~]# ifconfig eth1
eth1      Link encap:Ethernet  HWaddr 00:11:25:3F:19:B3
          inet addr:10.1.1.11  Bcast:10.255.255.255  Mask:255.255.0.0
          inet6 addr: fe80::211:25ff:fe3f:19b3/64  Scope:Link
          UP BROADCAST RUNNING MULTICAST  MTU:1500  Metric:1
          RX packets:51704214 errors:0 dropped:0 overruns:0 frame:0
          TX packets:108485306 errors:0 dropped:0 overruns:0 carrier:0
          collisions:0 txqueuelen:1000
          RX bytes:4260691222 (3.9 GiB)  TX bytes:157220928436 (146.4 GiB)
          Interrupt:169
```

---

After obtaining the interrupt number, you can use the `smp_affinity` parameter found in `/proc/irq/{irq number}` to tie an interrupt to a CPU. Example 4-25 illustrates this for the above output of interrupt 169 of `eth1` being bound to the second processor in the system.

*Example 4-25 Setting the CPU affinity of an interrupt*

---

```
[root@linux ~]# echo 02 > /proc/irq/169/smp_affinity
```

---





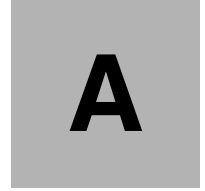

# Testing configurations

This appendix lists the hardware and software configurations used to load and test various tuning parameters, monitoring software, and benchmark runs.

## Hardware and software configurations

The tests, tuning modifications, benchmark runs, and monitoring performed for this redpaper were executed with Linux installed on two different hardware platforms:

- ▶ Guest on IBM z/VM systems
- ▶ Native on IBM System x servers

### Linux installed on guest IBM z/VM systems

IBM z/VM V5.2.0 was installed on an LPAR on an IBM z9 processor. Installed z/VM components were tcpip, dirmaint, rscs, pvm, and vswitch.

The various Linux guest VM systems were configured as shown in Table A-1.

*Table A-1 Linux installed on guest z/VM systems*

System name	LNXSU1	LNXSU2	LNXRH1
Linux distribution	SUSE Linux Enterprise Server 10	SUSE Linux Enterprise Server 10	Red Hat Enterprise Linux 5
Install	default with sysstat 6.0.2-16.4	default with sysstat 6.0.2-16.4	default with sysstat 7.0.0-3.el5
Memory	512 MB	512 MB	512 MB
swap (2105 Shark DASD)	710 MB	710 MB	710 MB
/root (2105 Shark DASD)	6.1 GB	6.1 GB	6.1 GB
/perf (2107 DS8000 DASD)	ReiserFS 6.8 GB	Ext3 6.8 GB	Ext3 6.8 GB

### Linux installed on IBM System x servers

Three IBM System x x236 servers were configured as shown in Table A-2.

*Table A-2 Linux installed on System x servers*

System name	LNXSU3	LNXSU4	LNXSU5
Linux distribution	SUSE Linux Enterprise Server 10 (runlevel 3)	Red Hat Enterprise Linux 4 (runlevel 5)	Red Hat Enterprise Linux 5 (runlevel 5)
Install	default with sysstat 6.0.2-16.4 and powertweak	default with sysstat	default with sysstat
Memory	4096 MB	4096 MB	4096 MB
swap (RAID 1, 2*74GB)	2 GB	2 GB	2 GB
/root (RAID 1, 2*74GB)	70 GB	70 GB	70 GB

/perf (RAID 5EE, 4*74GB)	ReiserFS 200 GB	Ext3 200 GB	Ext3 200 GB
-----------------------------	-----------------	-------------	-------------



# Abbreviations and acronyms

<b>ACK</b>	acknowledgment character	<b>JFS</b>	Journal File System
<b>ACPI</b>	Advanced Configuration and Power Interface	<b>KDE</b>	K Desktop Environment
<b>AIX</b>	Advanced Interactive eXecutive	<b>LAN</b>	local area network
<b>API</b>	application programming interface	<b>LDAP</b>	Lightweight Directory Access Protocol
<b>ATA</b>	AT Attachment	<b>LIFO</b>	last-in first-out
<b>AVC</b>	Access Vector Cache	<b>LRU</b>	Least Recently Used
<b>BDP</b>	bandwidth delay product	<b>LSI</b>	large-scale integration
<b>BSD</b>	Berkeley Software Distribution	<b>LSM</b>	Linux Security Modules
<b>BSS</b>	block storage segment	<b>LWP</b>	Light Weight Process
<b>CEC</b>	central electronics complex	<b>MAC</b>	Medium Access Control
<b>CFQ</b>	Complete Fair Queuing	<b>MTU</b>	maximum transmission units
<b>CPU</b>	central processing unit	<b>NAPI</b>	network API
<b>CSV</b>	comma separated values	<b>NFS</b>	Network File System
<b>CUPS</b>	Common UNIX Printing System	<b>NGPT</b>	Next Generation POSIX Thread
<b>DF</b>	decision federator	<b>NIC</b>	Network Information Center
<b>DMA</b>	direct memory access	<b>NLWP</b>	number of light weight processes
<b>DNAT</b>	dynamic network address translation	<b>NOOP</b>	no operation
<b>DNS</b>	Domain Name System	<b>NPTL</b>	Native POSIX Thread Library
<b>DS</b>	directory services	<b>NUMA</b>	Non-Uniform Memory Access
<b>FAT</b>	file allocation table	<b>OSI</b>	open systems interconnection
<b>FIFO</b>	first-in-first-out	<b>PC</b>	path control
<b>FQDN</b>	fully qualified domain name	<b>PCI</b>	Peripheral Component Interconnect
<b>FS</b>	fibre-channel service	<b>PID</b>	process ID
<b>FTP</b>	File Transfer Protocol	<b>POSIX</b>	Portable Operating System Interface for Computer Environments
<b>GNU</b>	GNU's Not Unix	<b>PPID</b>	parent process ID
<b>GPL</b>	general public license	<b>PRI</b>	primary rate interface
<b>GRUB</b>	grand unified bootloader	<b>RAID</b>	Redundant Array of Independent Disks
<b>GUI</b>	Graphical User Interface	<b>RAM</b>	random access memory
<b>HBA</b>	host bus adapter	<b>RFC</b>	Request for Comments
<b>HPC</b>	high performance computing	<b>RPM</b>	Redhat Package Manager
<b>HTML</b>	Hypertext Markup Language	<b>RSS</b>	rich site summary
<b>HTTP</b>	Hypertext Transfer Protocol	<b>SACK</b>	selective acknowledgment
<b>IBM</b>	International Business Machines Corporation	<b>SATA</b>	Serial ATA
<b>ICMP</b>	Internet Control Message Protocol	<b>SCSI</b>	Small Computer System Interface
<b>IDE</b>	integrated drive electronics	<b>SMP</b>	symmetric multiprocessor
<b>IP</b>	Internet Protocol	<b>SMT</b>	symmetric multithreading
<b>IRC</b>	interregion communication	<b>SMTP</b>	Simple Mail Transport Protocol
<b>IRQ</b>	interrupt request	<b>SUSE</b>	Software Und System Entwicklung
<b>ISV</b>	independent software vendor	<b>SWAT</b>	Samba Web Administration Tool
<b>ITSO</b>	International Technical Support Organization		

<b>SYN</b>	synchronization character
<b>TCQ</b>	Tagged Command Queuing
<b>TFTP</b>	Trivial File Transfer Protocol
<b>TLB</b>	Translation Lookaside Buffer
<b>TSO</b>	TCP segmentation offload
<b>TTY</b>	teletypewriter
<b>UDP</b>	User Datagram Protocol
<b>UID</b>	unique identifier
<b>UP</b>	uniprocessor
<b>USB</b>	Universal Serial Bus
<b>VFS</b>	Virtual Files System
<b>VM</b>	virtual machine
<b>XFS</b>	eXtended File System
<b>XML</b>	Extensible Markup Language
<b>YaST</b>	yet another setup tool

# Related publications

The publications listed in this section are considered particularly suitable for a more detailed discussion of the topics covered in this Redpaper.

## IBM Redbooks

For information about ordering these publications, see “How to get IBM Redbooks” on page 147. Note that some of the documents referenced here may be available in softcopy only.

- ▶ *Linux Handbook A Guide to IBM Linux Solutions and Resources*, SG24-7000
- ▶ *Tuning IBM System x Servers for Performance*, SG24-5287
- ▶ *IBM System Storage Solutions Handbook*, SG24-5250
- ▶ *IBM TotalStorage Productivity Center for Replication on Linux*, SG24-7411
- ▶ *Introduction to Storage Area Networks*, SG24-5470
- ▶ *TCP/IP Tutorial and Technical Overview*, SG24-3376

## Other publications

These publications are also relevant as further information sources:

- ▶ Beck, M., et al., *Linux Kernel Internals*, Second Edition, Addison-Wesley Pub Co, 1997, ISBN 0201331438
- ▶ Bovet, Daniel P., Cesati, Marco, *Understanding the Linux Kernel*, O'Reilly Media, Inc. 2005, ISBN-10: 0596005652
- ▶ Kabir, M., *Red Hat Linux Security and Optimization*. John Wiley & Sons, 2001, ISBN 0764547542
- ▶ Musumeci, Gian-Paolo D., Loukides, Mike, *System Performance Tuning*, 2nd Edition, O'Reilly Media, Inc. 2002, ISBN-10: 059600284X
- ▶ Stanfield, V., et al., *Linux System Administration*, Second Edition, Sybex Books, 2002, ISBN 0782141382

## Online resources

These Web sites are also relevant as further information sources:

- ▶ Linux Networking Scalability on High-Performance Scalable Servers  
<http://www.ibm.com/servers/eserver/xseries/benchmarks/>
- ▶ Linux tuning hints and tips on System z  
<http://www.ibm.com/developerworks/linux/linux390/perf/index.html>
- ▶ System Tuning Info for Linux Servers  
[http://people.redhat.com/alikins/system\\_tuning.html](http://people.redhat.com/alikins/system_tuning.html)
- ▶ Securing and Optimizing Linux (Red Hat 6.2)

- <http://www.faqs.org/docs/securing/index.html>
- ▶ Linux 2.6 Performance in the Corporate Data Center  
[http://www.osdl.org/docs/linux\\_2\\_6\\_datacenter\\_performance.pdf](http://www.osdl.org/docs/linux_2_6_datacenter_performance.pdf)
- ▶ Developer of ReiserFS  
<http://www.namesys.com>
- ▶ New features of V2.6 kernel  
[http://www.infoworld.com/infoworld/article/04/01/30/05FElinux\\_1.html](http://www.infoworld.com/infoworld/article/04/01/30/05FElinux_1.html)
- ▶ WebServing on 2.4 and 2.6  
<http://www.ibm.com/developerworks/linux/library/l-web26/>
- ▶ man page about the **ab** command  
<http://cmpp.linuxforum.net/cman-html/man1/ab.1.html>
- ▶ Network Performance improvements in Linux 2.6  
[http://developer.osdl.org/shemminger/LWE2005\\_TCP.pdf](http://developer.osdl.org/shemminger/LWE2005_TCP.pdf)
- ▶ RADIANT Publications and Presentations  
<http://public.lanl.gov/radiant/pubs.html>
- ▶ RFC: Multicast  
<http://www.ietf.org/rfc/rfc2365.txt>
- ▶ RFC: Internet Control Message Protocol  
<http://www.networksorcery.com/enp/RFC/Rfc792.txt>
- ▶ RFC: Fault Isolation and Recovery  
<http://www.networksorcery.com/enp/RFC/Rfc816.txt>
- ▶ RFC: Type of Service in the Internet Protocol Suite  
<http://www.networksorcery.com/enp/rfc/rfc1349.txt>
- ▶ Performance Tuning with OpenLDAP  
<http://www.openldap.org/faq/data/cache/190.html>
- ▶ RFC: TCP Extensions for Long-Delay Paths  
<http://www.cse.ohio-state.edu/cgi-bin/rfc/rfc1072.html>
- ▶ RFC: TCP Extensions for High Performance  
<http://www.cse.ohio-state.edu/cgi-bin/rfc/rfc1323.html>
- ▶ RFC: Extending TCP for Transactions -- Concepts  
<http://www.cse.ohio-state.edu/cgi-bin/rfc/rfc1379.html>
- ▶ RFC: T/TCP -- TCP Extensions for Transactions  
<http://www.cse.ohio-state.edu/cgi-bin/rfc/rfc1644.html>
- ▶ LOAD - Load and Performance Test Tools  
<http://www.softwareqatest.com/qatweb1.html>
- ▶ The Web100 Project  
<http://www.web100.org/>
- ▶ Information about Hyper-Threading  
<http://www.intel.com/business/bss/products/hyperthreading/server/>



- ▶ Information about EM64T

<http://www.intel.com/technology/64bitextensions/>

## How to get IBM Redbooks

You can search for, view, or download Redbooks, Redpapers, Hints and Tips, draft publications and Additional materials, as well as order hardcopy Redbooks or CD-ROMs, at this Web site:

[ibm.com/redbooks](http://ibm.com/redbooks)

## Help from IBM

IBM Support and downloads

[ibm.com/support](http://ibm.com/support)

IBM Global Services

[ibm.com/services](http://ibm.com/services)



# Index

## Symbols

/proc  
parameter files in 107

## Numerics

32-bit architectures 11  
3-way hand shake 30  
64-bit architectures 11

## A

Access Vector Cache 104  
ACK packet 30  
ACPI  
    *See advanced configuration and power interface*  
advanced configuration and power interface 61  
anticipatory 24, 117–118  
apmd 97  
arptables 97  
autofs 97  
AVC  
    *See Access Vector Cache*

## B

bandwidth delay product 127  
benchmark tools 70–76  
    functions overview 40  
    IOzone 72  
    LMbench 71  
    netperf 73–76  
bind a process to a CPU 81  
bind an interrupt to a CPU 7, 109  
block device metrics 36  
block layer 23–24  
block size 124  
bonding driver 34  
bonding module 34  
bottlenecks  
    analyzing the server's performance 80  
    CPU bottlenecks 81–82  
    disk bottlenecks 84–87  
    gathering information 78  
    memory bottlenecks 82–84  
    network bottlenecks 87–89  
bus subdirectory 62

## C

C09 compiler flag 104  
cache 21–22  
cache optimization 81  
Capacity Manager 67–70  
cat command 105, 108  
CFQ

*See Complete Fair Queuing*  
change management 92  
changing kernel parameters 104–108  
checksum offload 33  
child process 4  
chkconfig command 98  
clone() 5  
collision packets 88  
compiling the kernel 104  
Complete Fair Queuing 24, 116–118, 122  
connection establishment 30  
    3-way hand shake 30  
connection tracking 30  
context 6  
context switching 6  
CPU affinity 81  
CPU bottlenecks 81–82  
    actions 82  
CPU scheduler 9–10  
cpuinfo command 61  
cpuspeed 97  
cups 97

## D

daemons 97–100  
    default 97  
    tunable 97  
data segment 9  
deadline 24, 116–117  
dirty buffer 22, 110  
    flushing 22, 110  
dirty\_ratio 111  
disable SELinux 103  
disc drives 114  
disk bottlenecks 84–87  
    iostat command 86  
    solutions 87  
    vmstat command 85  
disk I/O subsystem 19–25  
    block layer 23–24  
    cache 21–22  
    I/O subsystem architecture 20  
disk subsystem 113–125  
    adding drives 87  
    file system selection 121–125  
    file system tuning 121–125  
    hardware considerations 114  
    I/O elevator selection 116–120  
    I/O elevator tuning 116–120  
dmesg command 94–95  
dropped packets 88  
duplexing 126  
dynamic memory allocation 8

**E**

elevator  
     *See* I/O elevator  
 Enterprise Linux distributions 93  
 ethereal command 55, 57  
 ethtool command 126–127  
 exec() 4  
 exit() 4  
 Ext2 17–18, 121  
 Ext3 18–19, 121, 123  
 extended 2 file system  
     *See* Ext2  
 extended 3 file system  
     *See* Ext3  
 eXtended File System 19, 121

**F**

faulty adapters 88  
 Fibre Channel controllers 85  
 file system 15–19  
     Ext2 17–18  
     Ext3 18–19  
     eXtended File System 19  
     Journal File System 19  
     journaling 16  
     ReiserFS 19  
     selection 121–125  
     tuning 121–125  
     virtual file system 15  
 file system selection 93  
 FIN packet 30  
 fork() 4  
 free command 46  
     memory used in a zone 47

**G**

getty 15  
 Gnome System Monitor 67  
 gpm 97

**H**

hardware considerations 114  
 hpoj 98  
 HugeTLBfs 112

**I**

I/O elevator 20, 23–24, 113, 116–120  
     anticipatory 24, 117–118  
     Complete Fair Queuing 24, 116–118, 122  
     deadline 24, 116–117  
     NOOP 24, 117–118  
     selection 116–120  
     tuning 116–120  
 I/O subsystem architecture 20  
 IBM Director 67  
 init command 101  
 installation considerations 92–104

interrupt handling 6  
     bind an interrupt to a CPU 7, 109  
     CPU affinity 109  
 interrupts  
     decreasing 136  
 ionice 122  
 iostat command 48, 86  
 IOzone 72  
 iptraf 54  
 irq subdirectory 62  
 irqbalance 98  
 isdn 98

**J**

JFS  
     *See* Journal File System  
 Journal File System 19, 121, 123  
 journaling 16, 113  
     mode 123

**K**

KDE System Guard 62–67, 82  
     Process Table 65  
     System Load 64  
 kernel  
     changing parameters 104–108  
     compiling 104  
     swap behavior 110  
     view current configuration 105  
 kernel panic 87  
 kudzu 98

**L**

LD\_ASSUME\_KERNEL 5  
 libpcap library 55  
 Light Weight Process 4  
 Linux  
     distributions 93  
     installation considerations 92–104  
     performance metrics 34–36  
 Linux Security Modules 104  
 LinuxThreads 5  
 LMBench 71  
 locality of reference 21  
 LSM  
     *See* Linux Security Modules  
 LWP  
     *See* Light Weight Process

**M**

maximum transmission unit 33, 127–129  
     size 127  
 memory  
     32-bit architectures 11  
     64-bit architectures 11  
 memory architecture 11–15  
 memory bottlenecks 82–84  
     actions 84

- memory hierarchy 21
- memory metrics 35
- memory used in a zone 47
- mmap() 112
- monitoring tools 41–70
  - Capacity Manager 67–70
  - ethtool command 55, 57
  - free command 46
  - functions overview 40
  - Gnome System Monitor 67
  - iostat command 48
  - iptraf 54
  - KDE System Guard 62–67
  - mpstat command 51
  - netstat 53
  - nmon 58
  - numastat command 52
  - pmap command 52
  - proc file system 60–62
  - ps command 44
  - pstree command 44
  - sar command 50
  - strace command 59
  - tcpdump command 55–56
  - top command 41
  - uptime command 43
  - vmstat command 42
- mount command 123
- mpstat command 51
- MTU
  - See maximum transmission unit

## N

- NAPI
  - See network API
- Native POSIX Thread Library 5
- net subdirectory 62
- Netfilter 29–30
  - connection tracking 30
  - performance impact 133–134
  - usage considerations 94
- netfs 98
- netperf 73–76, 125
- netstat 53
- network API 28–29
- network bottlenecks 87–89
- network buffers 127
  - socket buffer size 129
  - tuning window sizes 127
- network interface metrics 36
- network subsystem 26–34, 125–137
  - duplexing 126
  - maximum transmission unit 127–129
  - Netfilter
    - performance impact 133–134
  - network buffers 127
  - offload
    - configuration ??–136
  - TCP/IP 30–34
  - TCP/IP tuning 129–132

- traffic characteristics 125
- networking implementation
  - Netfilter 29–30
  - network API 28–29
  - network subsystem
    - networking implementation 26–30
- Next Generation POSIX Thread 5
- nfslock 98
- NGPT
  - See Next Generation POSIX Thread
- nice command 109
- nice level 5–6, 109
- Nigel's Monitor 58
- nmon 58
- noatime 123
- Non-Uniform Memory Architecture 10, 52, 109
- NOOP 24, 117–118
- NPTL
  - See Native POSIX Thread Library
- nr\_requests 118
- NUMA
  - See Non-Uniform Memory Architecture
- numastat command 52, 109–110
- number of disk drives 114

## O

- O(1) algorithm 9
- O(n) algorithm 9
- offload 33
  - checksum offload 33
  - configuration ??–136
  - impact 134
  - TCP segmentation offload 33

## P

- package selection considerations 94
- packet queues 136
- page cache 20
- paging
  - compared to swapping 83
  - defined 83
- partition layout considerations 93
- partitions
  - setting up 115–116
- pcmcia 98
- pdflush 20, 22, 110
- pdflush behavior 110
- pmap command 9, 52
- Portable Operating System Interface for UNIX 5
- portmap 98
- POSIX
  - See Portable Operating System Interface for UNIX
- power tweak 106–107
- proc file system 60–62
  - ACPI 61
  - bus subdirectory 62
  - changing kernel settings 104
  - irq subdirectory 62
  - net subdirectory 62

- scsi subdirectory 62
- sys subdirectory 62
- tty subdirectory 62
- process
  - child 4
  - defined 3
  - descriptor 4
  - lifecycle 4
- process management 3–10
- process memory segments
  - data segment 9
  - stack segment 9
  - text segment 8
- process priority 5
  - arrays 9
  - tuning 109
- process state
  - TASK\_INTERRUPTIBLE 7
  - TASK\_RUNNING 7
  - TASK\_STOPPED 7
  - TASK\_UNINTERRUPTIBLE 7
  - TASK\_ZOMBIE 7
- Process Table 65
- processor metrics 34
- processor subsystem, tuning 108–110
- ps command 44
- pstree command 44
- pthread 5

## Q

- Quality of Service
  - Complete Fair Queuing 24

## R

- RAID 87, 114, 124
  - RAID-0 85
  - RAID-10 85
  - RAID-5 85
- rawdevices 98
- read\_ahead\_kb 120
- Redbooks Web site 147
  - Contact us xi
- redundant array of independent disks
  - See RAID
- ReiserFS 19, 121, 123
- renice command 109
- retransmission 33
- rpc 98
- runlevel
  - changing 101
  - selection 94
- runlevel command 101

## S

- sa1 50
- sa2 50
- sar command 50
- SCSI

- See Small Computer System Interface
- SCSI buses 85
- scsi subdirectory 62
- Security Enhanced Linux
  - See SELinux
- SELinux 94, 102–104
  - disabling 103
- sendmail 98
- sequential workloads 85
- Small Computer System Interface 25
- smartd 98
- SMP 81
- SMT
  - See symmetric multithreading
- socket buffer 26–27
- socket buffer size 129
- socket interface 26
- speed 126
- stack segment 9
- strace command 59
- streaming 85
- stripe size 124
- stripe-unit size 124
- swap file 13, 93
  - compared to swap partition 93
- swap partition 15, 93, 111–112
  - compared to swap file 93
  - multiple 111
- swap space 13
- swapping
  - compared to paging 83
  - defined 83
- symmetric multithreading 109
- SYN packet 30
- sys subdirectory 62
- sysctl command 105, 108, 129
- system call
  - clone() 5
  - exec() 4
  - exit() 4
  - fork() 4
  - wait() 4
- System Load 64

## T

- TASK\_INTERRUPTIBLE 7
- TASK\_RUNNING 7
- TASK\_STOPPED 7
- TASK\_UNINTERRUPTIBLE 7
- TASK\_ZOMBIE 7
- TCP segmentation offload 33
- TCP/IP 30–34
  - bonding module 34
  - connection establishment 30
  - offload 33
  - retransmission 33
  - traffic control 32
  - transfer window 32
  - tuning 129–132
- tcpdump 128

- tcpdump command 55–56
- text segment 8
- thread 4–5
  - defined 4
  - LD\_ASSUME\_KERNEL 5
  - Light Weight Process 4
  - LinuxThreads 5
  - Native POSIX Thread Library 5
  - Next Generation POSIX Thread 5
- top command 41
- traffic characteristics 125
- traffic control 32
- transfer window 32
- Translation Lookaside Buffer 112
- transmit queue length 136
- TSO
  - See TCP segmentation offload
- tty subdirectory 62
- tunable daemons 97
- tuning
  - disk subsystem 113–125
  - ICMP 129
  - IP 129
  - network subsystem 125–137
  - processor subsystem 108–110
  - TCP 131
  - TCP options 132
  - virtual memory subsystem 110–113
  - window sizes 127

## U

- ulimit command 96
- uptime command 43, 81

## V

- VFS
  - See virtual file system
- virtual file system 15
- virtual memory 11
- virtual memory manager 13
- virtual memory subsystem 110–113
- virtual terminals 102
- vmstat command 42, 51, 61, 85

## W

- wait() 4

## X

- XFS
  - See eXtended File System
- xfstool 98

## Z

- zombie processes 8







# Linux Performance and Tuning Guidelines



## Operating system tuning methods

## Performance monitoring tools

## Performance analysis

IBM® has embraced Linux, and it is recognized as an operating system suitable for enterprise-level applications running on IBM systems. Most enterprise applications are now available on Linux, including file and print servers, database servers, Web servers, and collaboration and mail servers.

With use of Linux in an enterprise-class server comes the need to monitor performance and, when necessary, tune the server to remove bottlenecks that affect users. This IBM Redpaper describes the methods you can use to tune Linux, tools that you can use to monitor and analyze server performance, and key tuning parameters for specific server applications. The purpose of this redpaper is to understand, analyze, and tune the Linux operating system to yield superior performance for any type of application you plan to run on these systems.

The tuning parameters, benchmark results, and monitoring tools used in our test environment were executed on Red Hat and Novell SUSE Linux kernel 2.6 systems running on IBM System x servers and IBM System z servers. However, the information in this redpaper should be helpful for all Linux hardware platforms.

## INTERNATIONAL TECHNICAL SUPPORT ORGANIZATION

## BUILDING TECHNICAL INFORMATION BASED ON PRACTICAL EXPERIENCE

IBM Redbooks are developed by the IBM International Technical Support Organization. Experts from IBM, Customers and Partners from around the world create timely technical information based on realistic scenarios. Specific recommendations are provided to help you implement IT solutions more effectively in your environment.

For more information:  
[ibm.com/redbooks](http://ibm.com/redbooks)

REDP-4285-00

## Free Manuals Download Website

<http://myh66.com>

<http://usermanuals.us>

<http://www.somanuals.com>

<http://www.4manuals.cc>

<http://www.manual-lib.com>

<http://www.404manual.com>

<http://www.luxmanual.com>

<http://aubethermostatmanual.com>

Golf course search by state

<http://golfingnear.com>

Email search by domain

<http://emailbydomain.com>

Auto manuals search

<http://auto.somanuals.com>

TV manuals search

<http://tv.somanuals.com>