



**MODEL: IBM-412CID  
ADVANCED HOME/OFFICE  
4 LINE TELEPHONE  
WITH CALLER-ID**

**INSTALLATION AND OPERATION GUIDE**

Please read this manual carefully prior to installing your telephone.



# TABLE OF CONTENTS

<b>IMPORTANT SAFETY INSTRUCTIONS</b> .....	5
<b>BATTERY CAUTIONARY INSTRUCTIONS</b> .....	6
<b>GETTING STARTED</b> .....	7
Package Contents .....	7
Compatibility .....	7
<b>LOCATION OF CONTROLS AND FEATURES</b> .....	7
Useful Features and Terms .....	8
Lights and Cadence Reference List .....	10
Display Reference List .....	11
<b>INSTALLATION</b> .....	13
Selecting a Location to Install Your Telephone .....	13
Installing the Batteries .....	13
Connecting Your Telephone Lines .....	13
Counter Top/Desk Top Tabletop Installation .....	15
Wall Mounting .....	16
<b>TELEPHONE OPERATIONS SETUP</b> .....	18
List of System Defaults .....	18
Assigning Extension Numbers .....	18
Setting the Clock and Calendar .....	19
Programming Tone or Pulse Mode .....	19
Programming Line Connection ON/OFF .....	19
Programming Ringer ON/OFF .....	20
Adjusting Volume Levels .....	20
<b>BASIC OPERATIONS</b> .....	21
Making an Outgoing Call .....	21
Using Speed Dial .....	21
Using Last Number Redial .....	21
Using Auto Redial .....	22
Answering an Incoming Call .....	22
Placing a Call on Hold .....	22
<b>HEADSET OPERATION</b> .....	23
Headset Enable/Disable .....	23

Adjusting the Headset Volume .....	23
Making an Outgoing Call Using the Headset .....	24
Answering an Incoming Call .....	24
<b>INTERCOM</b> .....	25
Direct Station Select (DSS) Keys .....	25
Placing an Intercom Call .....	25
Answering an Intercom Call .....	26
<b>PAGING</b> .....	27
Paging a Specific Extension .....	27
Receiving an Individual Page .....	27
Answering an Individual Page .....	27
Paging All Extensions .....	27
Answering the Page to All Extensions .....	27
<b>CALLER ID SERVICE</b> .....	28
Caller Identification Displays .....	28
Area Code programming .....	28
Using the Caller ID Log .....	29
<b>TELEPHONE FEATURES AND OPERATIONS</b> .....	31
Pause .....	31
Flash .....	31
Mute .....	31
Tone .....	31
Do Not Disturb (DND) .....	31
Using the Call Timer .....	32
Line Privacy .....	32
Call Transfer .....	32
Speed Dialing .....	33
Conference Calling .....	34
New Call/Message Waiting Indicator .....	34
Technical Specifications .....	36
<b>CARE AND MAINTENANCE</b> .....	37
<b>TROUBLESHOOTING</b> .....	40
<b>LIMITED WARRANTY STATEMENT</b> .....	40
<b>WALL MOUNTING TEMPLATE</b> .....	41

## **IMPORTANT SAFETY INSTRUCTIONS**

Before using your telephone equipment, basic safety precautions should always be followed to reduce the risk of fire, electrical shock and injury to persons, including the following:

- Read and understand all instructions.
- Follow all warnings and instructions marked on the product.
- Unplug this product from the wall telephone jack and power outlet before cleaning. Do not use liquid cleaners or aerosol cleaners. Use a damp cloth for cleaning.
- Do not use this product near water, for example, near a bathtub, wash bowl, sink or laundry tub.
- Do not place this product on an unstable cart, stand, or table. The product may fall, causing serious damage to the product.
- This product should never be placed near or over a radiator or heat register.
- This product should be operated only from the type of power source indicated on the marking label.
- Do not allow anything to rest on the power cord. Do not locate this product where the cord will be walked on.
- Do not overload wall outlets and extension cords as this can result in the risk of fire or electric shock.
- Never push objects of any kind into this product through cabinet slots as they may touch dangerous voltage points or cause shorts that could result in the risk of fire or electric shock.
- To reduce the risk of electric shock, do not disassemble this product. Take it to a qualified serviceman when service or repair work is required. Opening or removing covers may expose you to dangerous voltages or other risks. Incorrect re-assembly can cause electric shock when the appliance is subsequently used.
- Unplug this product from the wall outlet and refer servicing to qualified service personnel under the following conditions:
  - When the power supply cord or plug is damaged or frayed.
  - If liquid has been spilled into the product.
  - If the product has been exposed to rain or water.
  - If the product does not operate normally by following the operating instructions. Adjust only those controls that are covered by the operating instructions because improper adjustment of other controls may result in damage.
  - If the product has been dropped or cabinet has been damaged.
  - If the product exhibits a distinct change in performance.
- Avoid using a telephone (other than a cordless type) during an electrical storm. There is risk of electric shock from lightning.
- Do not use the telephone to report a gas leak in the vicinity of the leak.

**SAVE THESE INSTRUCTIONS**

## BATTERY CAUTIONARY INSTRUCTIONS

### BATTERIES: CAUTION

- Use only 1.5 volt, AA-size batteries, (15A) carbon or alkaline batteries. (batteries not included.)
- Do not dispose of the batteries in a fire. The cells may explode. Check with local codes for possible special disposal instructions.
- Do not open or mutilate the batteries. Released electrolyte is corrosive and may cause damage to the eyes or skin. It may be toxic if swallowed.
- Exercise care in handling batteries in order not to short the battery with conducting materials such as rings, bracelets, and keys. The battery or conductor may overheat and cause burns.
- Do not attempt to recharge the batteries identified for use with this product. The batteries may leak corrosive electrolyte or explode.
- Do not attempt to rejuvenate the batteries identified for use with this product by heating them. Sudden release of the battery electrolyte may occur causing burns or irritation to eyes or skin.
- When replacing batteries, all batteries should be replaced at the same time. Mixing fresh and discharged batteries could increase internal cell pressure and rupture the discharged batteries.
- When inserting batteries into this product, the proper polarity or direction must be observed. Reverse insertion of batteries can cause charging, and that may result in leakage or explosion.
- Remove the batteries from this product if the product will not be used for a long period of time (several months or more) since during this time the battery could leak in the product.
- Discard “dead” batteries as soon as possible since “dead” batteries are more likely to leak in a product.
- Do not store this product, or the batteries identified for use with this product, in high temperature areas. Batteries that are stored in a freezer or refrigerator for the purpose of extending shelf life should be protected from condensation during storage and defrosting. Batteries should be stabilized at room temperature prior to use after cold storage .

# GETTING STARTED

## PACKAGE CONTENTS

1. Check to be sure that you have all the following components in the package:
2. Telephone base.
3. Handset.
4. Headset.
5. Normal telephone line cord (2 pc's).
6. Short telephone line cord.
7. Handset coiled cord.
8. Handset "Y" adapter.
9. AC power adapter.
10. Quick Reference Guide
11. This instruction manual.  
(batteries not included)

## COMPATIBILITY

Your IBM-412CID is a corded version of the IBM system telephone, featuring a fully integrated hands-free headset, speakerphone, speed dial, useful LCD display, four line Caller ID support, message waiting indicator, and much more.

The IBM-412 is an extremely cost-effective IBM system telephone, featuring a fully integrated hands-free headset, speakerphone, speed dial, as well as other advanced telephone system features and more.

The IBM-4900 is a four line cordless system telephone designed to work with other IBM system telephones to provide all of the advanced telephone system features of the IBM-412CID.

# LOCATION OF CONTROLS AND FEATURES

## Model IBM-412CID Top View

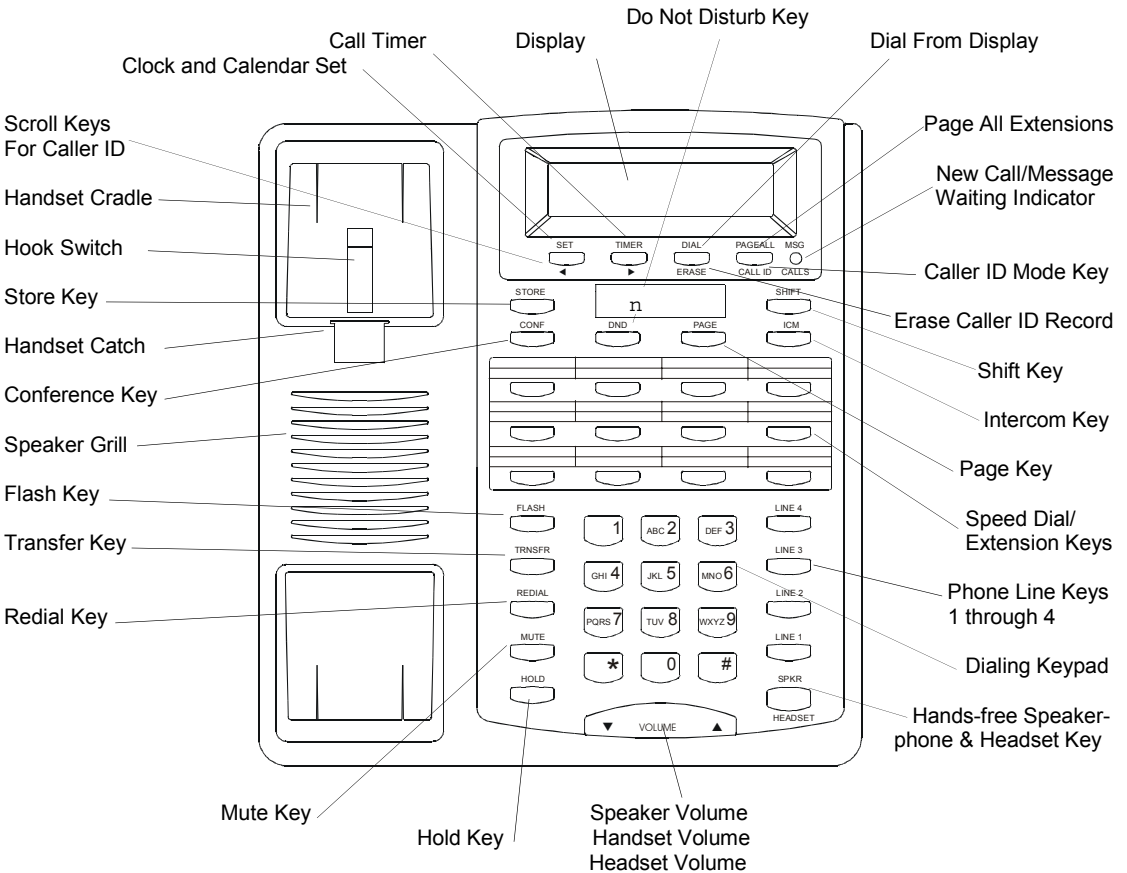

## Model IBM-412CID Rear View

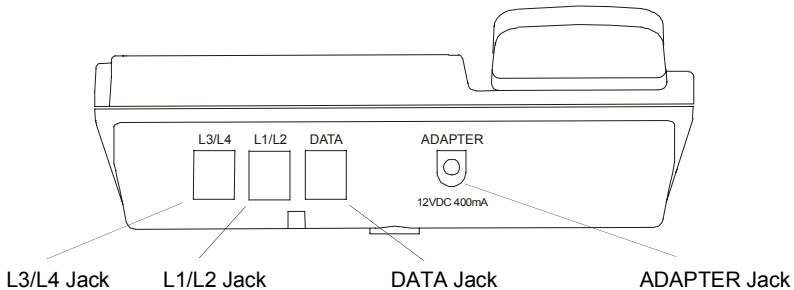



## USEFUL FEATURES AND TERMS

---

**Auto Line Selection** — Automatically selects first available line for outgoing calls. Automatically selects ringing line for incoming calls.

**Auto Redial** — Redials the last number dialed approximately every 60 seconds.

**Calendar/Clock** — Visual display of date, day and time.

**Caller ID** — Enables user to view name and number of callers. Contact your local telephone company to subscribe to Caller ID Service.

**Caller ID Log** — Stores up to 30 Caller ID entries.

**Call Privacy** — Ensures that no one can access your call while you are on the line.

**Call Timer** — Allows timing of phone conversations.

**Call Transfer** — Allows the user to transfer an outside call to another extension.

**Conferencing** — Allows inclusion of a third person into a conversation for a three-party conference call.

**Data/FAX Port** — Allows connection of a PC or FAX machine directly into the phone versus a wall outlet. Requires line #2 connection.

**Dial from Display** — One-button dialing from the Caller ID log.

**Display** — The Liquid Crystal Display (LCD) that shows clock and calendar, number dialed, intercom, page, extension, low battery indicator, Caller ID information and call timer.

**Do Not Disturb (DND)** — Prevents any incoming calls (paging, intercom or outside) from being heard by that extension.

**Extension** — An individual telephone in the system.

**Flash** — A signal sent by the phone to the local telephone company supporting services such as call waiting.

**Headset Integration** — The included headset may be used as a substitute to the handset, allowing hands free conversation.

**Hold** — Permits user to place a call on hold. Allows access by that user or by any other extension in the system.

**Intercom Calling** — A call placed from one extension to another extension within the system.

**Message Waiting Indicator** — A visual indicator that there are new messages in your voicemail box. Requires FSK signaling by phone company. Contact your local telephone company to subscribe to Voicemail Service.

**Multi-line Capability** — System supports from 1 to 4 phone lines.

**Mute** — Prevents the party on the other end of the line from hearing local conversation.

**New Calls Indicator** — A visual indicator that new calls have been received.

**Page** — An announcement placed from one extension to another extension.

**Page All** — An announcement from one extension to all other extensions.

**Redial** — Performs single button dialing of last number dialed.

**Ringer Level Control** — Permits adjustment of the ringer volume level.

**Shift** — This button enables user to switch between the upper and lower functions of select keys such as speed dial.

**Speakerphone** — Allows hands-free conversation.

**Speed Dialing** — Allows programming of frequently dialed numbers so that they can be dialed with the single press of a button.

**Tone/Pulse Option** — Enables you to switch from pulse (rotary) to tone dialing.

**Volume Level Control** — Permits volume adjustment of the handset, headset and speakerphone during a conversation.

## LIGHTS AND CADENCE REFERENCE LIST

LED	Status	Indication
<b>Lines 1-4</b>		
	Off	Line is not in use
	Flashing Slowly	Incoming outside call is ringing
	On Steady	Line is in use by another extension or phone line is not connected
<b>To that Line.</b>		
	Flashing Rapidly	Line is on hold by your extension
	Blink 1	Line in use by you
	Blink 2	Line on hold by another extension
	Blink 3	Call being transferred to your extension
<b>Intercom</b>		
	Off	Not in use
	Flashing Slowly	You are making an intercom call or paging
	Flashing Rapidly	You are receiving an intercom call
<b>Speakerphone</b>		
	Off	Phone in handset mode or your phone is idle
	On Steady	Phone in speakerphone mode
	Flashing Slowly	Phone in headset mode
<b>Shift</b>		
	Off	First level of key functions active (lower) mode
	On Steady	Second level of key functions active (upper) mode
<b>Mute</b>		
	Off	Extension is not muted
	On Steady	Extension is muted
<b>Do Not Disturb (DND)</b>		
	Off	DND is OFF
	On Steady	DND is ON
<b>Redial</b>		
	Off	Not in use or single redial
	Flashing Slowly	Phone in auto redial mode
<b>Messages/New Calls</b>		
	Off	No messages or new calls
	On Steady	Phone has received new calls
	Flashing Rapidly	Messages have been left in voicemail box

# DISPLAY REFERENCE

## Idle Display

```
J A N   0 1   S U  
1 0 : 0 6 A
```

## Low Battery Display

The telephone will indicate that the batteries are low (or not installed) by displaying a low battery indicator, **“BATT”**, on the display.

```
J A N   0 1   S U  
1 0 : 0 6 A
```

## Dialing Display

As you dial 12345, the display shows the numbers dialed and begins the call timer.

```
1 2 3 4 5  
0 0 : 0 0
```

If you dial more than 15 digits, then all the digits will shift to the left:

```
    5 6 7 8 9 0 1 2 3 4 5 6 7  
0 0 : 0 0
```

## Programming Display

```
S T O R E  
0 0 0 1
```

# CALLER ID DISPLAY REFERENCE

The phone is idle

```
J A N   0 1   S U
1 0 : 0 6 A
```

Line 2 ringing

```
L 2 : 2 1 2 6 6 6 5 3 7 7
S M I T H   J O H N
```

Call dropped

```
J A N   0 1   S U
1 0 : 0 7 A
```

Press [CALL ID]

```
L 2 : 9 1 8 2 6 5 6 5 1 7
B R O W N   M A R Y
```

Press [CALL ID]

```
J A N   0 1   S U
1 0 : 0 7 A
```

Press [CALL ID]

First time

```
T O T A L : 3 0
N E W   C A L L S : 0 0
```

IA ↓

IB ↑

```
0 1 : 3 5 2 4 6 1 7 9
J A C K S O N   M A R K
```

2A ↓

2B ↑

```
0 2 : 5 1 4 6 7 7 9
J A C K S O N   T H O M A S
```

3A ↓

3B ↑

```
3 0 : 5 7 4 6 1 2 5
T H O M A S   F R A N K
```

↓ 4

```
M A R   0 6   S U
0 9 : 4 0 A
```

## Display Priority

When the phone is handling simultaneous functions, messages are displayed according to the following precedence:

- |                        |                          |                   |
|------------------------|--------------------------|-------------------|
| 1. Dialed digits       | 3. Timer                 | 5. Caller ID data |
| 2. Intercom operations | 4. Programming functions |                   |

# INSTALLATION

## SELECTING A LOCATION TO INSTALL YOUR TELEPHONE

The phone may be used on a desk or mounted on a wall. Select a location which meets the following requirements:

1. Near an AC (electrical) outlet.
2. Near a telephone line jack.
3. Away from any electrical machinery, appliances, and metal walls or filing cabinets.

## INSTALLING THE BATTERIES

The phone requires three 1.5 volt, AA-size batteries, preferably alkaline, (batteries not included). Batteries are required for the retention of user programmed settings during a power outage.

**NOTE:** *In the event of a power outage, your IBM-412CID telephone will not operate until power is restored.*

To install the batteries:

1. Turn the unit over (if unit is wall-mounted, lift it off the wall).
2. Open the battery compartment by removing the safety screw and pressing the tab to release the cover.
3. Insert the batteries into the battery compartment as indicated.
4. Reinstall the battery compartment cover and safety screw.

**NOTE:** *When replacing batteries in the future, keep the AC power adapter line connected to the phone to avoid memory loss.*

## CONNECTING YOUR TELEPHONE LINES

Wherever you intend to locate each phone, have your local telephone company install as many telephone lines and wall jacks as necessary to enable you to connect each telephone. If possible, have 2 two-line (RJ14) wall jacks installed instead of 4 single-line (RJ11) wall jacks (see illustrations on pages 13 and 14). Each telephone must be connected to each telephone line in order for it to access every line in the system.

1. If you have 4 single-line wall jacks, you will need to use a two line coupler (not included) to provide the required 2 two-line (RJ14) telephone jack(s).
2. The two adapter coupler can be purchased in most electronic stores.
3. All lines must be connected to each extension in the same manner. Switching connectors or lines to connectors will result in improper operation.
4. All extensions must be connected to [LINE 1] for intercom, paging and transfer functions to operate.

## USING THE DATA JACK

The jack located on the rear of the telephone labeled "DATA" is a convenience jack. It is useful for connecting a FAX machine or PC when there is no telephone jack available for that device. The DATA jack allows connection to Line 2 only. An installation using two RJ11 telephone jacks results in Line 1 and Line 3 being active (See diagram on page 16). In this case the DATA jack is not active and can not be used.

**NOTE:** *Many of the advanced system features of the BE-412CID require the use of Line 1. Because of this it is not recommended that electronic devices (modems, FAX machines, door bells, etc.) Be connected to Line 1.*

## SINGLE LINE JACKS

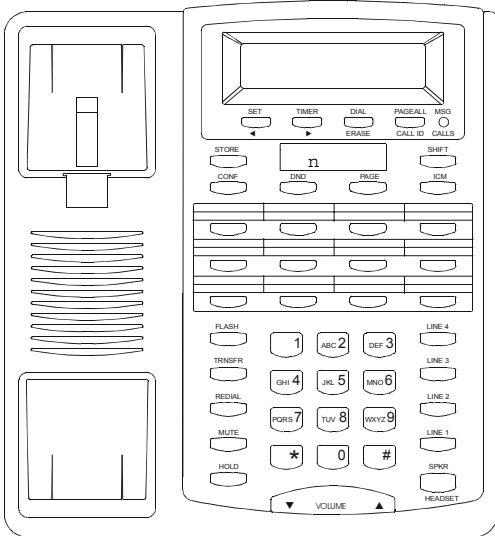
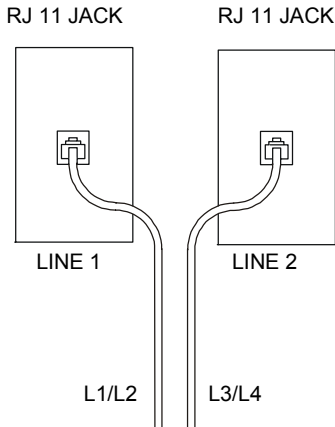

## TWO LINE JACKS

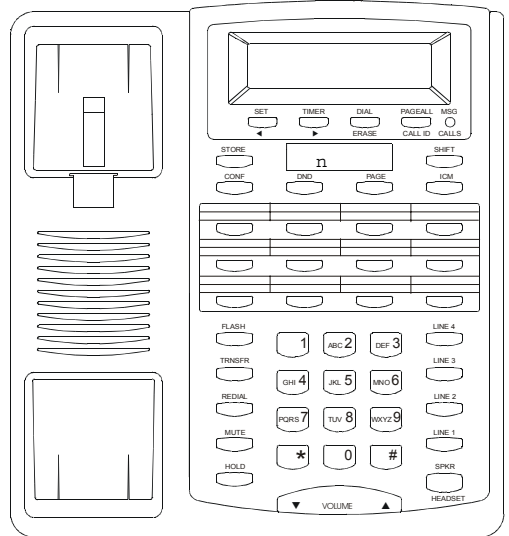
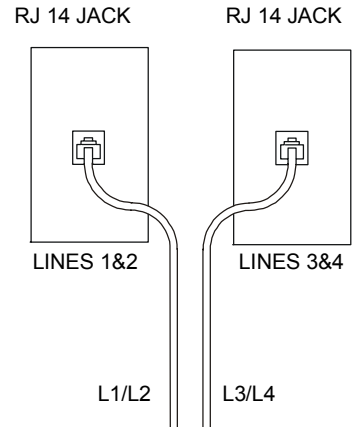

### CAUTION:

1. Never install telephone wiring during a lightning storm.
2. Never install telephone jacks in wet locations unless the jack is specifically designed for wet locations.
3. Never touch un-insulated telephone wires or terminals unless the incoming telephone line has been disconnected at the network interface.
4. Use caution when installing or modifying telephone lines.

## FOUR SINGLE LINE JACKS

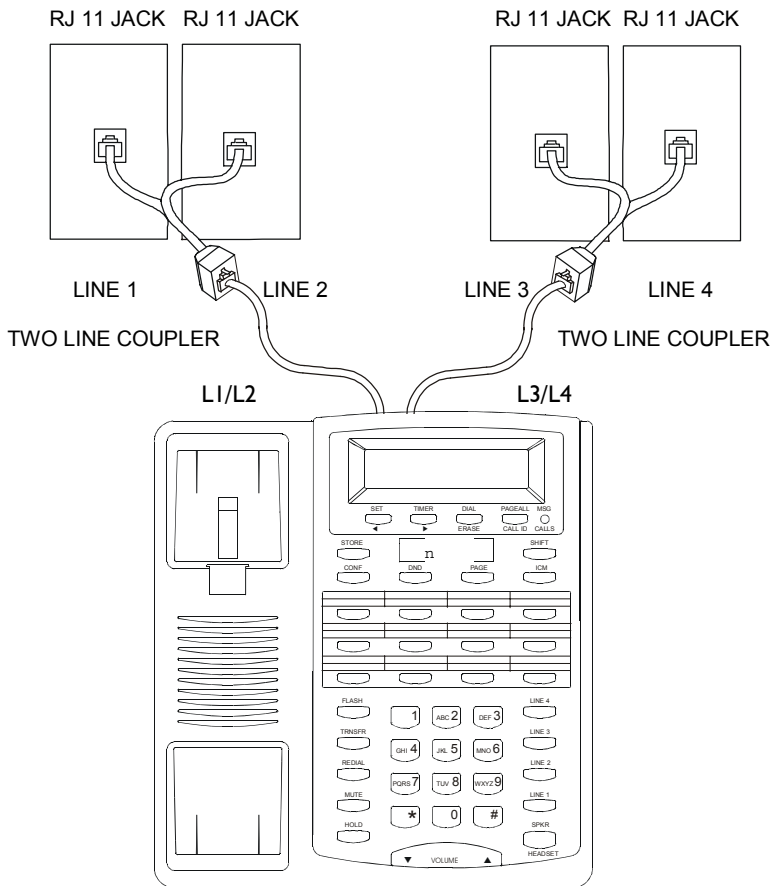

## COUNTER TOP/DESK TOP INSTALLATION

1. For lines 1 and 2, plug the telephone line cord (provided with the telephone) into the L1/L2 jack as indicated on the rear base of the telephone.
2. For lines 3 and 4, plug the other telephone line cord (provided with the telephone) into the L3/L4 jack as indicated on the rear base of the telephone.
3. Insert the AC adapter cable into the jack labeled ADAPTER in the rear of the telephone.
4. Connect the telephone line(s) to the wall telephone jack(s).
5. Plug the AC adapter into the wall AC (electrical) power outlet.
6. Plug one end of the handset coiled cord into the handset. Plug the other end of the cord into the handset jack located underside of the phone base.

## Adjusting the Viewing Angle Brackets

Adjust the viewing angle brackets (one on each side of the phone) to position the phone to the desired viewing angle. Take care to keep the right side bracket on the right side of the phone and the left bracket on the left side of the phone. These brackets are not interchangeable. The character R or L appears on the inside of each bracket to indicate proper installation.

The brackets are adjusted by removing them from the base and reattaching them at desired angle. To remove the brackets, insert your finger into the bracket opening (on the underside of the bracket) and press up as you pull the bracket straight out from the side of the phone. To attach the brackets, use alignment guides (small marks) on the side of the phone and on the brackets as you snap them in place.

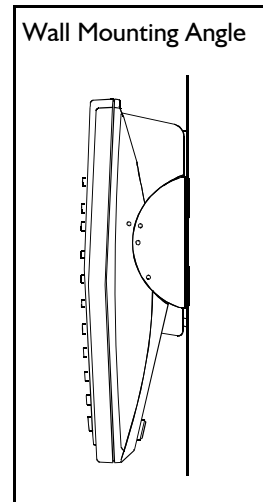
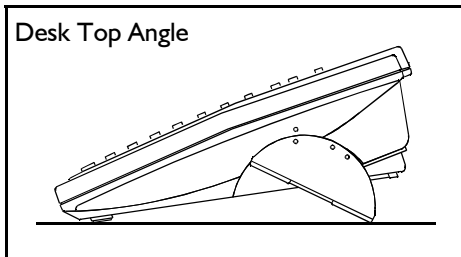
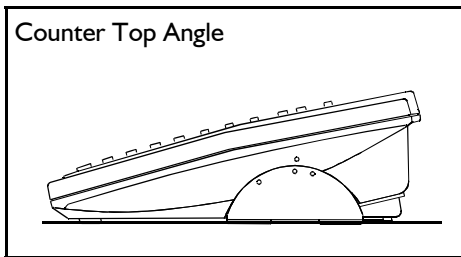

## WALL MOUNTING

The telephone may be installed on the studs of a standard wall phone plate or onto two screws (not included) fastened into the wall. When installing screws, use wall anchors (not included) to insure that the screws are secure. To install screws properly, remove the template from page 42 of this manual and use it to mark the screw locations on the wall. Insert the screws into the wall leaving 3/16" of each screw extending out from the wall.



Expansion  
Anchor

#6 or #8 Pan Head  
Self Tapping Screw

*(Not Included)*





# TELEPHONE OPERATIONS SETUP

## LIST OF SYSTEM DEFAULTS

The default telephone setup is as follows:

Function	Default
Tone/Pulse Mode	Tone
Headset	Disable
Extension Number	11
Ringer	On - 4 lines
Line Connection	On - 4 lines
Speaker Volume	12th level
Handset Volume	Minimum level
Headset Volume	Middle level
Ringer Volume	Middle level
Speed Dial	Empty
Area Code	Empty
Calendar	Jan 01 Fr 12:00 am
Caller ID Log	Empty

You may clear all programmed data and all the parameters will revert to the above default values. To do this:

1. Press [STORE].
2. Press [\*], [#], [\*], [#].
3. Press [MUTE].
4. A short ring will be heard to signal successful programming.

## ASSIGNING EXTENSION NUMBERS (11 THROUGH 22)

When you use two or more phones, each phone must be assigned a different extension number. If two stations are given the same number, you will hear a loud continuous warning alerting you to the system error.

All phones arrive with the default extension number 11. Valid extension numbers are 11 through 22. To program extension numbers, follow these steps, assigning numbers sequentially to each extension:

1. Press [STORE].
2. Press [1], [0].
3. Enter 2 digits XX where XX is a number from 11 to 22.
4. Press [MUTE].
5. A short ring will be heard to signal successful programming.

**NOTE:** The programmable speed dial keys double in function as Direct, Station to Station (DSS) keys. The upper most left key is extension (Station) 11, the next key to the right is extension 12, etc. When using the features intercom (ICM) and page, extensions may be dialed by pressing these keys even after each key has also been programmed as a speed dial number.

## SETTING THE CLOCK AND CALENDAR

The time and date appear on the display screen when the phone is not in use. To set the clock and calendar:

1. Press [SHIFT].
2. Press [SET].
3. Enter 2 digits for MONTH from 01 ~ 12.
4. Enter 2 digits for DAY from 01 ~ 31.
5. Enter DAY of WEEK from 1 ~ 7 where 1 is for SU, 2 is for MO, etc.
6. Enter 2 digits for HOUR from 01 ~ 12.
7. Enter 2 digits for MINUTE from 00 ~ 59.
8. Enter AM or PM, [\*] for AM and [#] for PM.
9. A short ring will be heard to signal successful programming.

## PROGRAMMING TONE OR PULSE MODE

Tone mode is the system default. To change the setting to either pulse or tone:

1. Press [STORE].
2. Press [0], [0].
3. Press [0], [1] for TONE mode, or [0], [0] key for PULSE mode.
4. Press [MUTE].
5. A short ring will be heard to signal successful programming.

## PROGRAMMING LINE CONNECTION ON/OFF

This refers to deactivating individual phone lines on an extension. By default, all lines are ON.

To deactivate a phone line(s) for an extension, program that extension to turn OFF the phone line connection for that specific line (L1, L2, L3, or L4). Note that if a phone does not have 4 incoming phone lines, those lines that are not used will appear lit (the LED on the [LINE] keys will be lit) unless the line connection is programmed OFF. To set:

1. Press [STORE].

2. Press [5].
3. Press a digit X where X is for line numbers 1-4.
4. Press [0], [1] for ON, or [0], [0] for OFF.
5. Press [MUTE].
6. A short ring will be heard to signal successful programming.

## PROGRAMMING RINGER ON/OFF

The ringer may be turned OFF and ON for incoming calls on a line-by-line basis. To set the ringer value for an individual phone line:

1. Press [STORE].
2. Press [2].
3. Press a digit X where X is for lines 1-4
4. Press [0], [1] for ON or [0], [0] for OFF.
5. Press [MUTE].
6. A short ring will be heard to signal successful programming.

**NOTE:** The default value is ON for all 4 lines.

## ADJUSTING VOLUME LEVELS

### Adjusting Ringer Volume

There are 3 levels of volume adjustment (low, middle, and high) for the ringer.

1. Press the [VOLUME] key (beneath the dial keys) up or down when receiving a call or when the phone is idle.

**NOTE:** *The default level is low level.*

### Adjusting Speakerphone Volume

1. Press the [SPKR] key.
2. Press the [VOLUME] key up or down to the desired volume level.

**NOTE:** *The default level is the 12th (out of 16) level. A short ring will be heard when the volume is set at the maximum or minimum level.*

### Adjusting Handset and Headset Volume

There are 3 volume levels (low, middle, high). As the handset or headset is in use, adjust the volume by pressing the [VOLUME] key up or down to the desired volume level.

**NOTE:** *The default level is the middle level. A short ring will be heard when the volume is set at the maximum or minimum level.*

# BASIC OPERATIONS

## MAKING AN OUTGOING CALL

### Using the Handset

1. Lift the handset. The first available line is automatically selected.
2. Dial desired number. The display will show the digits as they are dialing.
3. At the end of the call, return the handset to the base.

### Using the Speakerphone (hands free)

1. Press the speakerphone [SPKR] key. The first available line is automatically selected.
2. Dial the desired number.
3. At the end of the call, press [SPKR] to hang up.

**NOTE:** *If you dial more than sixteen digits, the numbers will scroll to the left as additional numbers are entered.*

## USING SPEED DIAL

There are 24 total memory locations, in two speed dial “groups“. See pages 35 and 36 for details on how to store speed dial numbers.

### Dialing Numbers in the First Speed Dial Group

1. Press a speed dial key to automatically access an available outside line and dial the stored number. The number will appear on the display.

### Dialing Numbers in the Second Speed Dial Group

1. Press the [SHIFT] key (the SHIFT LED will light).
2. Press the speed dial key.
3. The number stored in the second speed dial group will automatically be dialed and displayed on the LCD.
4. After selecting a number in this second group, the [SHIFT] key is automatically released (the [SHIFT] LED turns off) and the extension is returned to first group dialing.

## USING LAST NUMBER REDIAL

The telephone automatically stores the last phone number dialed. To automatically re-dial that number:

1. Press the [REDIAL] key.
2. The extension will pick up an available outside line, and dial the last number dialed automatically.

## USING AUTO REDIAL

If the phone number dialed is busy or not answered, the phone can automatically redial the number approximately every 60 seconds up to 10 times.

1. Press an available [LINE] key [LINE1, LINE2, LINE3, or LINE4]
2. Press [REDIAL]. The [REDIAL] LED will flash and the [MUTE] key will be lit, indicating the phone is in Auto Redial mode. No further action is needed.

### To cancel Auto Redial:

1. Press [REDIAL] and hang up the phone.

## ANSWERING AN INCOMING CALL

### Using the Handset

1. Lift the handset. You will automatically be connected to the ringing outside line.

### Using the Speakerphone (hands free)

1. Press the [LINE] key with the flashing LED to be connected with the outside call or simply press the speakerphone [SPKR] key to be automatically connected to the ringing outside line.
2. Press the [SPKR] key again to end the call.

## PLACING A CALL ON HOLD

### Placing a Call on Hold

1. Press the [HOLD] key to put the current line on hold. The line LED will flash rapidly.

### Releasing a Call on Hold

1. To release a call on hold, press the [LINE] key of the call that is on hold.

**NOTE:** You can access the line (call) on hold from any extension.

## HEADSET OPERATION

A headset has been included for your convenience to provide optional hands-free operation.

1. To use the headset, you must **ENABLE** it. The default value is **DISABLE**.
2. Once headset operation mode is enabled, your telephone unit won't detect the status of the hook switch (under the handset).
3. On-hook and off-hook functions are then activated by the [SPKR] button until you disable this function.

## HEADSET INSTALLATION

For your convenience, a handset/headset "Y" adapter has been included so that you may easily switch from handset to headset operation.

1. Remove the coiled handset cord from the handset jack on the base of the telephone.
2. Plug the handset/headset "Y" adapter (included) into the handset on the base of the telephone.
3. Plug the handset/headset cord into the headset "Y" adapter.
4. Plug the handset coiled cord into the handset/headset "Y" adapter.
5. Adjust the headset to your head for comfort.
6. For maximum comfort, the headset end without a speaker (the end without the padded ear piece) should rest above, not on top of the ear.

## HEADSET ENABLE/DISABLE

1. Press [SHIFT]
2. Press [SPKR] to turn ON/OFF the headset mode
3. You will hear a short ring to signal successful enabling/disabling of the headset.
4. The speaker [SPKR] LED will flash when the headset mode is enabled.
5. To place a call, press [SPKR]. To hang up, press [SPKR].

## ADJUSTING THE HEADSET VOLUME

1. Set phone to headset mode.
2. With the phone off-hook (while placing a call) press the [VOLUME] key UP or DOWN until the desired volume level is achieved.
3. You will hear a short ring when you have reached the maximum or minimum volume level.

## **MAKING AN OUTGOING CALL USING THE HEADSET**

1. The [SPKR] LED will flash to indicate the phone is in headset mode.
2. Press the [SPKR] key. An available line is automatically selected.
3. Dial the desired number, using standard dial pad, speed dial or redial keys.

## **ANSWERING AN INCOMING CALL**

1. Press the flashing [LINE] key (Lines 1-4) to pick up the ringing outside line.
2. Another option is to press the [SPKR] key to pick up the ringing outside line automatically.



# INTERCOM

The Intercom function allows extension-to-extension conversations (phones must be connected to [LINE I]). That means you can speak with another party without having to dial seven digits (using an outside line). As you direct an intercom call to an extension that extension will ring and display a flashing ICM LED.

## DIRECT STATION SELECT (DSS) KEYS

The phone system is preprogrammed so that with the touch of a button, you can dial any of the extensions 11–22. Although not labeled, the buttons correspond to extension numbers 11 through 22 in sequential order.

## PLACING AN INTERCOM CALL

### Placing an Intercom Call with the Handset

1. Lift the hand set.
2. Press the [ICM] key. “ICM” will appear on the display, the Intercom [ICM] LED will light and you will hear the intercom dial tone.
3. Dial the desired extension you wish to call or press one of the Direct Station Select keys (DSS).
4. To end the intercom call, simply return the handset to the phone base.

### Placing an Intercom Call with the Headset

1. Press the [ICM] key. The [ICM] LED will illuminate and you will hear the intercom dial tone. The [SPKR] key LED will continue to flash, indicating that you are in headset mode.
2. “ICM” will appear on the display.
3. Dial the desired extension number or press one of the Direct Station Select (DSS) keys.
4. To end the intercom call, simply press the [SPKR] key to disconnect the call.

### Placing an Intercom Call with the Speakerphone

1. Press the [ICM] key. The [ICM] LED and [SPKR] LED will light and you will hear the intercom dial tone.
2. “ICM” will appear on the display.
3. Dial the desired number you wish to call or press one of the Direct Station Select (DSS) keys.
4. To end the intercom call, simply press the [SPKR] key to disconnect the call.
5. If the called number is idle (doesn't answer), you will hear an ICM ring back tone that alternates 2 seconds on and 2 seconds off.
6. If the called number is busy, you will hear a busy ICM tone that is a continuous on/off tone. The called party will hear a double ring for intercom call waiting.

7. If the called number is set on Do Not Disturb [DND], you will hear an ICM busy tone. The called party will not hear anything, but that extension's ICM LED will flash.

## **ANSWERING AN INTERCOM CALL**

### **Answering an Intercom Call with the Handset**

1. Lift the handset. You will know you are receiving an intercom call because the [ICM] LED flashes, the display will show "ICM" on the screen and you will hear the distinct ICM ring (a double ring).
2. Your phone will automatically connect the intercom call, so you are free to begin your conversation.

### **Answering an Intercom Call with the Headset**

1. Press the flashing [ICM] key or press the [SPKR] key to receive your intercom call.
2. You will know you are receiving an intercom call because the [ICM] LED flashes, the display will show "ICM" on the screen and you will hear the distinct ICM ring (a double ring).
3. Begin your conversation.

### **Answering an Intercom Call with the Speakerphone**

1. Press the [SPKR] key
2. Begin the conversation.

**NOTE:** *If your phone is set on DND when you receive an intercom call, even though you will not hear a ring you still have the option of answering the call by pressing the [ICM] or [SPKR] key. You will see the number of the incoming caller on your display.*

# PAGING

Paging differs from Intercom calling in that the party called does not have to answer the phone in order to hear your message. This permits the caller to broadcast message to one or all other phone extensions.

## PAGING A SPECIFIC EXTENSION (INDIVIDUAL PAGE)

1. Press the [PAGE] key. (You may use the handset, headset or speakerphone to place the call.) The [ICM] LED will be lit.
2. Dial the desired phone extension or press one of the DSS keys. Your display will show the extension which you are paging.

## RECEIVING AN INDIVIDUAL PAGE

1. You will hear a short ring indicating that a page is coming.
2. The [MUTE] and the [ICM] LED's will light and the extension number of the caller will be displayed. Listen to the message over the speakerphone.

## ANSWERING AN INDIVIDUAL PAGE

### With the Handset

1. Lift the handset to answer.

### With the Speakerphone or Headset

1. Press the [MUTE] key to respond to the page.

## PAGING ALL EXTENSIONS (PAGE ALL)

1. Press the [SHIFT] key.
2. Press the [PAGEALL] key. You will hear a page ring.
3. "All Page" will appear on the display.
4. Make your announcement using the handset or the speakerphone. Your message will be sent to all extensions connected to [LINE 1] which are not busy or set to [DND].

## ANSWERING THE PAGE TO ALL EXTENSIONS

1. Press the [PAGE] key (for hands free speaking), or lift the handset and press the [PAGE] key.
2. Upon answering the page to all stations, your voice will only be heard by the paging station. The display will read "ICM".

## CALLER ID

This feature requires Caller ID subscription from the local telephone company. If you have multiple phone lines, you need to subscribe to Caller ID service on each line (defined as each different phone number) in order for Caller ID to display on those lines.

### CALLER IDENTIFICATION DISPLAYS

#### Caller ID Displayed when the Phone is Idle

1. The phone rings, signaling an outside call.
2. The display shows the caller's name and number and line that the call is coming in on.
3. The display returns to the normal display mode after approximately 5 seconds if the caller hangs up before the call is answered or if the call is picked up by another phone in the system.

#### Caller ID Displayed on the Phone when in Use

If a call comes in while a feature requiring the use of the display is being performed (such as programming the SPEED DIAL key, making an outgoing call, setting the clock, etc.), the Caller ID may be displayed by:

1. The phone will ring, indicating an incoming call.
2. To view the Caller ID, press the [CALLID] key.
3. Press the [CALLID] key again to return to your original LCD display.

#### Simultaneous Caller ID Signals (Ringing on Multiple Lines)

The Caller ID function will support up to four incoming calls at once. The [CALLID] key is used to scroll through the incoming Caller ID displays. An example of this follows:

1. The phone rings on two lines (for example, first on [LINE 1] and then immediately after on [LINE 3]).
2. The display will show the caller information for the call that came in first [LINE 1].
3. Press the [CALL ID] key to display information about the caller on the second ringing line [LINE 3].

### AREA CODE PROGRAMMING

This feature allows calls to be stored as a local call and dialed back as a local call. There is storage for one local area code. Once you program the local area code, all incoming phone calls from that point on will have that local area code deleted automatically. Any phone call received prior to area code programming will be stored with the area code and dialed with the area code until deleted from the Caller ID log.

## Setting the Caller ID Local Area Code

1. Press [STORE] key.
2. Press [7], [1].
3. Key in 1 to 5 digits as the area code.
4. Press [MUTE].
5. A short ring will be heard to signal successful programming.

**NOTE:** Remember to delete any local phone numbers that have been stored with their area code prior to the area code programming. This way they can be automatically restored as a phone number without the area code the next time you receive a call from that number.

## Erasing the Caller ID Area Code

1. Press [STORE] key.
2. Press [7], [1].
3. Press [\*].
4. Press [MUTE].
5. A short ring will be heard to signal successful programming.

## USING THE CALLER ID LOG

### Retrieving the List

1. Press the [<] or [>] keys beneath the display to scroll through the Caller ID list.
2. Press either the [<] or [>] and a call summary screen will appear. This screen displays the total number of calls stored in the Caller ID log as well as the number of New Calls. New Calls are calls which have not been viewed previously.
3. To go FORWARD (oldest call to most recent call) through the caller list, press the [>] key.
4. To go BACKWARDS (most recent call to oldest call) through the caller list, press the [<] key.
5. The Caller ID display mode will be terminated by pressing any key other than the [<] or [>] keys or after a 20 second idle period.
6. To view the date and time of any call received press the [#] key.
7. The CALLS LED will go out after the last new call is viewed.

### Other Possible Caller ID Displays

1. Out of Area: The call is coming from an area not supplying Caller ID data.
2. Private: The caller has blocked the sending of Caller ID.
3. Unknown Name: The caller name is not available for this particular number.

## Erasing Caller ID Records

In order to delete a specific Caller ID record in the log:

1. Using the [<] or [>] key, find the particular record you would like to delete..
2. Press the [ERASE] key. The LCD display will indicate that the record has been deleted.
3. You may erase all caller information records simultaneously by pressing [ERASE] from the summary Call ID display.

## Returning a Call on the Caller's List

When reviewing Caller ID entries, you may decide to return a particular call immediately. To do this:

1. Press either the [<] or [>] key to find the particular call you would like to return.
2. Press the [SHIFT] key.
3. Press the [DIAL] key. The number will be automatically dialed and displayed.
4. If the phone number to be called is long distance (10 digits), a "1" must be added to the front of the number to be dialed. To do this, after locating the number in the Caller ID log, go off-hook (pick up the handset or press [SPKR]), dial a "1", then press [SHIFT] followed by [DIAL].

## Saving a Caller's Number to a Speed Dial Key

When reviewing your Caller ID records, you can save the number to a Speed Dial key.

1. Locate the Caller ID record to be stored.
2. Press the [STORE] key.
3. Press the [<] key. The number selected during step 1 will appear.
4. Press the speed dial key selected for this entry.
5. You will hear a short confirmation tone indicating you have successfully stored the phone number to the Speed Dial key.
6. If the phone number to be called is long distance (10 digits), a "1" must be added to the front of the number. To do this, repeat steps 1 and 2 above, press "1" on the dial pad, then resume step 3 above.

# TELEPHONE FEATURES AND OPERATIONS

## PAUSE

You may use this feature to create a dialing pause between digits during a call. Typically, the PAUSE function is most useful for programming dialing delays in long number sequences of certain Speed Dial numbers such as voicemail codes, international phone numbers, and personal banking authorizations.

Each time you press the [REDIAL] key, you add a three second delay to the dialing sequence (you may do this more than once to create a longer delay.) You may insert a pause anywhere in the number (before, in between any two digits and/or the end of the number.)

1. Press the [REDIAL] key to insert a timing delay between digits.

## FLASH

The [FLASH] key supports custom-calling services that you have subscribed to from your local telephone company (such as call waiting or three-party conference calling).

## MUTE

The MUTE feature allows you to temporarily stop the voice transmission to the other party on your call.

1. Press the [MUTE] key. The [MUTE] LED will illuminate and the display will show MUTE. You are now free to converse privately. The other party will not hear your conversation.
2. Press the [MUTE] key again to restore the sound to the other party. The [MUTE] LED will turn off.

## TONE

If you have PULSE telephone service, you may find it necessary to dial a number in TONE because some specialized communication services require signaling. Your phone has the ability to change from PULSE to TONE dialing touch-tone.

1. Dial the desired number in PULSE mode.
2. Press the [\*] key and dial the number in TONE signaling. This temporary tone dialing ends when you terminate the call.

## DO NOT DISTURB (DND)

The DND function prevents all calls (outside, paging or intercom) from ringing at your extension. If receiving an outside call while your phone has DND activated, you have the option to answer the call by pressing the ringing [LINE] key. If you call a phone that is in DND mode, you will hear a busy signal.

1. To activate the DND function, press the [DND] key.
2. To cancel DND, press the [DND] key again.

## **USING THE CALL TIMER**

You can time the length of a phone call. The timer automatically begins ticking as soon as the handset/headset/speakerphone are connected to an outside line. You must reset the timer if you don't want the timer to begin ticking until the other party answers the phone. To reset the timer, you must:

1. Press [SHIFT] + [TIMER] to stop the timer.
2. Press [SHIFT] + [TIMER] again to start it over.

To start timing the length of a call after the other party answers, do the following:

1. Establish a call, either incoming or outgoing.
2. Press the [SHIFT] key.
3. Press the [TIMER] key. The display will show 00:00 and then immediately begin to time the call up to 59:59. If 59:59 is reached, the counter will start over at 00:00.
4. Press the [SHIFT] key first, followed by the [TIMER] key in order to stop the elapsed time. OR, you may simply terminate the call (hang up) to stop the counter function.

## **LINE PRIVACY**

A line in use will always maintain privacy unless you cancel it to allow other phones in the system to join your call. Line Privacy is active by default to ensure conversation privacy.

1. To cancel Line Privacy: While conversing, press the [LINE] key that the call is on. You will hear a short ring indicating that you have released Line Privacy. Line Privacy is automatically restored when the call is terminated.
2. To restore Line Privacy during a call, press the [LINE] key again. You will hear a double ring confirming Line Privacy has been reactivated.

## **CALL TRANSFER**

You have the ability to transfer an outside call to any extension within your phone system.

1. Press the [TRNSFR] key during your conversation.
2. Dial the desired extension number or press one of the Direct Station Select (DSS) keys.
3. A single ring will be heard if the call is successfully transferred. A double ring will be heard if the call has not transferred.
4. Any station can pick up the transferred call.
5. The Call Transfer mode will automatically cancel after 10 seconds if no transfer number is dialed.



## **SPEED DIALING**

There are a total of 24 memory locations located in two groups, in which you can store your Speed Dial numbers. Each memory location can store up to 24 digits, including PAUSE, FLASH, PULSE and TONE.

### **Storing Numbers into the First Speed Dial Group**

1. Press the [STORE] key.
2. Enter the number to be stored including “1” if the call is long distance.
3. Press the corresponding Speed Dial key. A short ring will be heard to signal successful programming.

### **Storing Numbers into the Second Speed Dial Group**

1. Press the [STORE] key.
2. Enter the number to be stored including “1” if the call is long distance.
3. Press the [SHIFT] key.
4. Press the Speed Dial key. A short ring will be heard to signal successful programming. The [SHIFT] LED will revert to dark immediately after pressing the Speed Dial key.

### **Storing the Last Number Dialed into the First Group of Speed Dial Memory**

1. Press the [STORE] key.
2. Press [REDIAL].
3. Press the Speed Dial key. A short ring will be heard to signal successful programming.

### **Storing the Last Number Dialed into the Second Group of Speed Dial Memory**

1. Press the [STORE] key.
2. Press the [REDIAL] key.
3. Press the [SHIFT] key.
4. Press the Speed Dial key. A short ring will be heard to signal successful programming. The [SHIFT] LED will revert to dark immediately after pressing the Speed Dial key.

### **Dialing Numbers in the First Speed Dial Group**

1. Press the SPEED DIAL key to automatically access an available line and the extension will automatically dial the stored number. The number will be shown on the display.

### **Dialing Numbers in the Second Speed Dial Group**

1. Press the [SHIFT] key. The [SHIFT] LED will illuminate
2. Press the SPEED DIAL key to automatically access an available line and the extension will automatically dial the stored number. The number will be shown on the display.

## **Erasing First Group Speed Dial Numbers**

1. Press the [STORE] key.
2. Press [\*].
3. Press the SPEED DIAL key you wish to erase. A ring tone will be heard signaling successful deletion of the Speed Dial number.

## **Erasing Second Group Speed Dial Numbers**

1. Press the [STORE] key.
2. Press [\*].
3. Press [SHIFT].
4. Press the SPEED DIAL key you wish to erase. A ring tone will be heard signaling successful deletion of the Speed Dial number.

## **CONFERENCE CALLING**

When speaking with an outside party, you can include a third person into the conversation for a three-person conference call. The third person may be an internal or external party.

### **Conference Call with an External Party**

1. While in conversation, press the [HOLD] key and make the second call on another available line.
2. After the third party has answered, press the [CONF] key.
3. Your three-way conference call has now been established.

### **Conference Call with an Internal Party**

1. While in conversation, press the [HOLD] key and make the second call via the intercom function.
2. After the third party has answered, press the [CONF] key.
3. Your three-way conference call has now been established.

## **NEW CALL/MESSAGE WAITING INDICATOR**

This indicator functions only when you subscribe to a voice mail service from your local telephone company. When activated, this feature informs you when messages are waiting in your voice mailbox.

You will be made aware of messages via the flashing Voice Mail Indicator light [MSG] (if this LED is lit but not flashing, it is an indicator that new calls have been received). This function requires voice mail subscription from the local telephone company. Furthermore, this indicator light is only compatible with voice mail signaling called "FSK". Check with your local telephone company to see if it can provide "FSK voice mail".

There may be times when you wish to manually turn off the flashing voice mail indicator. To do this:

1. The phone is in idle mode press [ERASE] key
2. The display will read "Del MW indicator".
3. Press [ERASE] key to confirm.
4. A short ring will be heard to signal successful programming.

**NOTE:** *The MSG/CALLS LED may still be lit indicating new calls. Once the calls have been viewed (Caller ID Log) the light will go out entirely.*

## **ACCESSING YOUR VOICE MAIL**

1. Dial the number for your voice messaging service. This number will be provided by your local telephone company when you subscribe to the service.
2. Enter your password.
3. Continue as instructed by your local telephone company.

## TECHNICAL SPECIFICATIONS

### Flash Rate for Lights

On Steady	Solid light.
Flashing Slowly	1 sec on, 1 sec off, repeatedly.
Flashing Rapidly:	0.125 sec on, 0.125 sec off, repeatedly.
Blink 1:	1.875 sec on, 0.125 sec off, repeatedly.
Blink 2:	0.875 sec on, 0.125 sec off, repeatedly.
Blink 3:	0.125 sec on, 0.875 sec off, repeatedly.

### Sound Rate of Intercom Buzzer

Ring:	0.25 sec on.
Double ring:	0.25 sec on, 0.25 sec off, 0.25 sec on, 0.25 sec off.
ICM ring:	0.25 sec on, 0.25 sec off, 0.25 sec on, 1.25 sec off, repeatedly
Transfer ring:	1 sec on, 1 sec off, repeatedly.
ID-error ring:	0.25 sec on, 0.25 sec off, repeatedly.

### Tones

Dial tone:	Continuous tone.
Busy tone:	0.25 sec on, 0.25 sec off, repeatedly.
DND tone:	0.5 sec on, 0.5 sec off, repeatedly.
Ring back tone	1 sec on, 1 sec off, repeatedly

## CARE AND MAINTENANCE

Your IBM-412/CID telephone has been designed to give years of trouble free service. It is a sensitive electromechanical instrument. To assure its longevity, please read the following maintenance instructions.

1. Keep the IBM-412/CID away from heat as high temperatures can shorten the life of the electrical components and distort or melt its plastic parts.
2. The IBM-412/CID should be kept free of dust and moisture. If it gets wet, wipe it dry immediately. Liquids can contain minerals that can corrode electronic circuits.
3. Handle your IBM-412/CID gently and carefully. Dropping it can cause serious damage to circuitry, or the plastic case, which may result in causing it to malfunction.
4. Do not use any type of chemical or any abrasive powder to clean the cabinet. Use only mild detergents on a soft, damp cloth to clean the IBM-412/CID telephone.
5. The IBM-412/CID has built-in surge protection circuits that meet or exceed FCC requirements. However, an incident such as a lightning strike at or near the telephone lines, could cause serious damage.
6. If the IBM-412/CID is installed in an area with frequent or severe electrical storms, it is suggested that the telephone be disconnected during these storms or that additional surge suppression equipment be added to the installation.
7. In the case of trouble with the telephone, do not attempt to repair the telephone yourself. It is the responsibility of users requiring service to report the need for service to our Service Department. They will make the necessary arrangements for repair or replacement.
8. If you should have any questions about the operation of your IBM-412/CID telephone, please call our Service Department at 1-800-288-1683, between the hours of 8:30 A.M. and 7:00 P.M. Eastern time. Or you may contact TT Systems LLC for technical assistance via our Internet Website: **<http://www.support@aastra.com>**.

## TROUBLESHOOTING

### **Intercom, line status, auto-answer, privacy or auto-line selection are inoperable.**

- Check if Lines 1 and 2 are cross wired in the wall jack.
- If used, see if you may have installed your 2-line adapter incorrectly.
- Be sure all extensions in the system are connected to [LINE 1].
- Check the assigned extension codes, making sure they are unique.
- Be sure the length of cable between stations does not exceed 300 feet.
- Check that all phone lines are correctly connected to each station (every [LINE 1] is connected to the appropriate line, every [LINE 2] is connected to the appropriate line, and so on.)
- Remove all RFI filters from the system wiring. You may also need to contact your local telephone company to have any RFI filter removed from the company side of the connection.

### **No dial tone/phone will not dial out.**

- Check that you have plugged the AC power adapter into a working AC power outlet.
- Confirm that the AC power adapter is plugged into the DC jack located at the unit.
- Check all telephone cord connections.
- Try another wall jack.
- Make sure the line connection is programmed ON.

### **Can't hear the ring signal.**

- Check the ringer volume controls. At lowest level the ring may not be heard.
- Check the status of DND (Do Not Disturb). Make sure the LED is not lit.

### **Can't hear the ring signal on one line only.**

- Check the ringer setting on that line.
- See Programming Ringer On/Off.

### **While on a call do you hear another call on the line or are you experiencing radio frequency interference?**

- Make sure all wiring is twisted pair, including modular cords on non-system devices.
- Check the wiring for bad connections.

### **Reaching the wrong number in speed dialing.**

- Check that you are accessing the correct dial group (see speed dialing).

**Handset doesn't appear to be working.**

- Check to see if your phone is in headset mode. If the [SPKR] key is flashing, you are in headset mode and need to deactivate this in order to turn on the handset.
- Make sure the handset cord is connected at both ends.

**Intercom service doesn't appear to work.**

- Check to make sure the phone lines for all extensions are set up consistently, meaning that all phones are properly wired for [LINE 1], 2, 3 and 4. Review "Connecting Your Telephone Lines" section.

**The caller's name and/or phone number does not appear on the display.**

- Make sure you have subscribed to Caller ID Service (from local telephone company).
- Caller ID service may not work when the phone is connected to a Private Branch Exchange (PBX).
- The call is coming from an area not supplying caller ID data. "Out of Area" will appear on the display.
- The caller has requested that their phone number be suppressed from Caller ID service. "Private" or "Unavailable" will appear on the display.
- You answered the call before the Caller ID data was displayed, which usually occurs after the second ring.

**New Call/Message Waiting Indicator doesn't work properly.**

- Make sure you have subscribed to voice mail compatible with "FSK" type signaling (check with your local phone company). If your voice mail product from the local phone company does not support "FSK" signaling, you may use this feature as a New Call Indicator only.

**Can't make phone calls.**

- Check to be sure the phone is set to the correct type of service, either Tone or Pulse..

## AASTRA TELECOM — LIMITED WARRANTY

Statement of limited warranty: Aastra Telecom Inc. warrants that for a period of one year from the date of purchase that this product 1) is free from defects in materials and workmanship and 2) conforms to its specifications. If this product does not function as warranted during the warranty period, Aastra Telecom Inc., at its option, will either replace this product with one that is functionally equivalent or will refund your purchase price. These are your exclusive remedies under this warranty. Please call 1-800-288-1683 for warranty service.

This product is distributed and sold by TT Systems LLC, 7 Odell Plaza, Yonkers, New York 10701, official licensee for this product. IBM, the IBM logo trademarks and the IBM trade dress are owned by International Business Machines Corporation and are used under a license from IBM. IBM does not manufacture this product and provides no warranty or support for this product. Please contact Aastra Telecom Inc. at 1-800-288-1683 for all questions/comments and service or support related to this product.

Aastra Telecom Inc. warrants that the IBM-412/CID sold by Aastra Telecom Inc. within Canada, are free from defects in materials and workmanship under normal use and service for 1 year. This warranty is applicable only to the original purchaser of the IBM-412/CID, when accompanied by a sales receipt stating the date of purchase and name of the company from which purchased. This warranty is in lieu of and excludes all other warranties, expressed or implied, including any implied warranty of merchantability or fitness, and of any other obligation on the part of Aastra Telecom Inc.

If the IBM-412/CID shall prove to be defective, then Aastra Telecom Inc. shall either replace, repair or refund the purchase price of the IBM-412/CID at its discretion as follows: At no cost to the original purchaser except shipping charges, within 90 days of the date of purchase. From 91 days to 365 days, you may return the IBM-412/CID to Aastra Telecom Inc. at the following address: 155 Snow Blvd., Concord, Ontario, Canada L4K 4N9, 1-800-288-1683. Please quote Return Merchandise Authorization number on the package.

Shipping charges are at the customer's expense. Please include a copy of your sales receipt and a check or money order made out to Aastra Telecom Inc. for the amount of \$21.75 Canadian dollars to cover shipping and handling.

This warranty gives you specific legal rights, and you may also have other rights which vary from province to province. Some provinces do not allow limitations on how long an implied warranty lasts and/or do not allow the exclusions or limitations of incidental or consequential damages, so the above limitations or exclusions may not apply to you. There is no informal dispute settlement mechanism available. This warranty will be voided by misuse, improper physical environment, accident, or improper maintenance by you.

THIS WARRANTY REPLACES ALL OTHER WARRANTIES OR CONDITIONS, EXPRESS OR IMPLIED, INCLUDING, BUT NOT LIMITED TO, THE IMPLIED WARRANTIES OR CONDITIONS OF MERCHANTABILITY AND FITNESS FOR A PARTICULAR PURPOSE. THESE WARRANTIES GIVE YOU SPECIFIC LEGAL RIGHTS AND YOU MAY ALSO HAVE OTHER RIGHTS WHICH VARY FROM JURISDICTION TO JURISDICTION. SOME JURISDICTIONS DO NOT ALLOW THE EXCLUSION OR LIMITATION OF EXPRESS OR IMPLIED WARRANTIES, SO THE ABOVE EXCLUSION OR LIMITATION MAY NOT APPLY TO YOU. IN THAT EVENT, SUCH WARRANTIES ARE LIMITED IN DURATION TO THE WARRANTY PERIOD. NO WARRANTIES APPLY AFTER THAT PERIOD.

Circumstances may arise where, because of a default on Aastra Telecom Inc.'s part or other liability, you are entitled to recover damages from Aastra Telecom Inc.. In each such instance, regardless of the basis on which you are entitled to claim damages from Aastra Telecom Inc. (including fundamental breach, negligence, misrepresentation, or other contract or tort claim), Aastra Telecom Inc. is only liable for: 1. Damages for bodily injury (including death) and damage to real property and tangible personal property; and 2. The amount of any other actual direct damages or loss, up to the greater of \$500 or the price paid for this product.

UNDER NO CIRCUMSTANCES IS AASTRA TELECOM INC. OR IBM LIABLE FOR ANY OF THE FOLLOWING: (1) THIRD-PARTY CLAIMS AGAINST YOU FOR LOSSES OR DAMAGES (OTHER THAN THOSE UNDER THE FIRST ITEM LISTED ABOVE); (2) LOSS OF, OR DAMAGE TO, YOUR RECORDS OR DATA; OR (3) SPECIAL, INCIDENTAL OR INDIRECT DAMAGES OR FOR ANY ECONOMIC CONSEQUENTIAL DAMAGES (INCLUDING LOST PROFITS OR SAVINGS), EVEN IF AASTRA TELECOM INC. OR IBM ARE INFORMED OF THEIR POSSIBILITY. SOME JURISDICTIONS DO NOT ALLOW THE EXCLUSION OR LIMITATION OF INCIDENTAL OR CONSEQUENTIAL DAMAGES, SO THE ABOVE EXCLUSION OR LIMITATION MAY NOT APPLY TO YOU.

TT Systems LLC reserves the right to make changes in the design of the IBM-412/CID and to make additions or improvements to the IBM-412/CID without incurring any obligation to modify any IBM-412/CID previously sold.



## WALL MOUNTING TEMPLATE

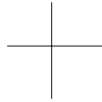

**PLACE THIS TEMPLATE ON THE WALL.**

THE LOCATION OF THE SCREWS IS INDICATED  
BY THE CENTERS OF THE CROSSED LINES.

FASTEN THE SCREWS LEAVING 3/16" OF THE SCREW  
EXTENDING FROM THE WALL

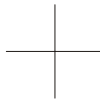

**Remove This Page to Mark Wall**





## Free Manuals Download Website

<http://myh66.com>

<http://usermanuals.us>

<http://www.somanuals.com>

<http://www.4manuals.cc>

<http://www.manual-lib.com>

<http://www.404manual.com>

<http://www.luxmanual.com>

<http://aubethermostatmanual.com>

Golf course search by state

<http://golfingnear.com>

Email search by domain

<http://emailbydomain.com>

Auto manuals search

<http://auto.somanuals.com>

TV manuals search

<http://tv.somanuals.com>