

DN-3000

**AN INTELLIGENT
MULTIPLE-FUNCTION COMMUNICATIONS
INTERFACE UNIT FOR DEVICENET**

User Manual

ICP PANEL-TEC

**Post Office Box 2394
Huntsville, Alabama 35804
(205) 534-8132**

Warranty & Notices

WARRANTY

ICP PANEL-TEC, INC. warrants that all equipment purchased hereunder is warranted on a "RETURN TO FACTORY" basis against all defects in workmanship and materials under normal and proper use and service in its unmodified condition for a period of one (1) year from the date of initial shipment. **ICP PANEL-TEC, INC.** sole obligation under this warranty shall be limited to furnishing parts and labor to remedy such defects; either, at the option of **ICP PANEL-TEC, INC.**, by replacing or repairing any defective parts which are returned to **ICP PANEL-TEC, INC.** factory or by making available at a purchaser designated facility a repaired or replaced part. All replaced equipment shall become the property of **ICP PANEL-TEC, INC.** The cost of freight to and from **ICP PANEL-TEC, INC.** will be borne by the purchaser. If **ICP PANEL-TEC, INC.** determines that the equipment returned to it for warranty correction is not defective, as herein defined, Purchaser shall pay **ICP PANEL-TEC, INC.**, all costs of service, parts, handling and transportation.

IMPORTANT NOTICES

By accepting and using the **DN-3000 (s) CONFIGURATION EDITOR SOFTWARE** and information proprietary to **ICP PANEL-TEC, INC. USA** and/or its Licensers, you agree that such software and information (Software) constitutes valuable trade secrets and proprietary information of **ICP PANEL-TEC, INC.** and/or its Licenses and that you hold the software in confidence and secrecy and shall not, in whole or part, copy or disclose to any third party or make any unauthorized use thereof. Authorized use shall be limited to the DN-3000 (s) upon which the Software is initially supplied. You further agree that this agreement shall insure to the benefit of **ICP PANEL-TEC, INC.** and any third party holding any right, title, or interest in the software, or any software and information from which it is derived, and their respective transferees, successors, and assigns, and that any subsequent transferee of the unit herein decried shall be obligated to the same terms of this agreement.

This document is based on information available at the time of its publication. While efforts have been made to render accuracy to its content, the information contained herein does not purport to cover all details or variations in hardware or software, nor to provide for every possible contingency in connection with installation, operation, and maintenance.

Features may be decried herein which are not present in all hardware and software systems. **ICP PANEL-TEC, INC.** assumes no obligation of notice to holders of this document with respect to changes subsequently made.

ICP PANEL-TEC, INC. makes no representation or warranty expressed, implied, or statutory, with respect to, and assumes no responsibility for accuracy, completeness, sufficiency or usefulness of the information contained herein.

In no event shall **ICP PANEL-TEC, INC.** be responsible or liable for indirect or consequential damages that may result from installation or use of this equipment.

(C) 1997 **ICP PANEL-TEC, INC.**
ALL RIGHTS RESERVED
Post Office Box 2394
Huntsville, Al. 35804-2394

Table of Contents

Introduction	1
Software Installation	2
Software Start-Up	3
Creating Project Files	4
Project Types	5
DeviceNet to PLCs or Devices	7
Device Profile	7
Example Applications	8
Configuring Port #1 (DeviceNet)	10
Configuring Port #2 (PLCs or Devices)	12
Configuring Port #3 (Passthrough)	14
I/O Data Configuration	15
DeviceNet to Motor Drives	23
Device Profile	23
Example Applications	24
Configuring Port #1 (DeviceNet)	26
Configuring Port #2 (Motor Drives)	28
I/O Data Configuration	30
Upper Link Configuration (Mitsubishi Drives Only)	38
Exception Table (Mitsubishi Drives Only)	39
Transferring Project Files	40
Options Settings	
Setting the Project Directory	42
Selecting the Communications Port	44
Setting the Printer Options	45
Load Options	45
Save Options	45
Default Options	45
Technical Information	
Power Requirements	46
Dimensions	46
DIP Switch Settings	47
LED Indicators	47
Troubleshooting	48

Table of Contents

Application Notes – PLCs and Devices

Allen Bradley PLCs	49
GE Fanuc PLCs	49
Idec PLCs	50
Koyo (PLC Direct and TI) PLCs	51
Mitsubishi PLCs	53
Modicon PLCs (and Modbus Devices)	53
Omron PLCs	53
Siemens S7-200 PLCs	54
Square D PLCs	55
TI505 Series PLCs	55
Toshiba PLCs	56
Westinghouse PLCs	56

Application Notes – Motor Drives

Baldor Motor Drives	57
Mitsubishi Motor Drives	59
Woods Motor Drives	59
Yaskawa Motor Drives	59

Cable Diagrams

Configuration Cable Diagram	60
PLC and Device Cable Diagrams	61
Motor Drive Cable Diagrams	72
DeviceNet Cable Diagram	76

INTRODUCTION

The DN-3000 is an intelligent, multiple-function DeviceNet Data Transfer Unit designed for use within the harsh industrial environment.

Using the DN-3000 Configuration Editor Software program, the DN-3000 can be programmed to run either of the two (2) following application types:

1) DEVICENET TO PLCs OR DEVICES Allows a DeviceNet Host to read or write data registers in one or more PLCs or Devices that use the same protocol. One of the DN-3000's three ports can be used as a pass-through port in which all messages received are simply passed through to one of the connected PLCs/Devices (if supported for that PLC/Device protocol), allowing PLC programming software, a third party's intelligent (MMI) Man-Machine Interface terminal or a SCADA software program to be "connected" to the same port on the PLCs/Devices used by the DN-3000.

2) DEVICENET TO MOTOR DRIVES Allows a DeviceNet Host to control and/or monitor parameters in up to 32 Motor Drives.

This manual is presented in two sections. Each section deals with the configuration requirements for each of the above applications: DeviceNet to PLCs and DeviceNet to Motor Drives.

Please note that the application type is selected when a new project is created using the DN-3000 configuration software and may not be changed after the project is created.

Software Installation

GENERAL INFORMATION

The **Panel-Tec DN3000 Configuration Editor Software Program** is designed to operate on an IBM or compatible computer running MS-DOS 3.3 or higher.

While the Configuration Editor Software Program will run under “**WINDOWS 3.1**” in most configurations, it is not recommended. As of this date, no problems have been reported running the software under “**WINDOWS 95**”.

The configuration editor software will default during start-up to using “**COMM 1**” unless changed using the **OPTIONS** menu. This may conflict with a mouse driver program and prevent up/down loading configuration information to the DN-3000 interface unit.

INSTALLATION

Place the supplied program disk into drive “**A**” (or **B**).

At the MS-DOS prompt, **C:>** type in **A:** (or **B:**) and then press the “**ENTER**” key.

When the “**A**” (or **B**) prompt appears, **A:>** type in “**INSTALL**” and press the “**ENTER**” key.

The following message will appear;

DN3000 Configuration Editor Installation Program

Enter the drive where the editor is to be installed ==>

Enter “**C**” (or any other hard drive you care to use), then press the “**ENTER**” key.

A new message will appear:

Enter the sub-directory on drive C to install the editor into ==>

Suggested directory name is: **DN3000**

The next message to appear before the installation is started is:

**The Editor will be installed from “A” to “C:\DN3000”
Is this correct (Y/N) ?**

If the above information is correct, push the “**Y**” key, then the “**ENTER**” key and the software will be installed. The last message to appear will be:

Installation Complete.

Enter “DN3000” to run the configuration Editor

C:\DN3000>

SOFTWARE START-UP

To start the DN-3000 Configuration Editor program. First start your computer and at the MS-DOS prompt; C:> type in “CD\DN3000” (to change the directory) then press the **ENTER** key. At the next MS-DOS prompt; C:\DN3000>, type in “DN3000” and press the **ENTER** key to start the Configuration Editor Software Program.

Upon starting of the configuration software program, the first screen to appear will be the “*Support Information Page*”, shown below.

```

┌──────────┴──────────┐ ┌──────────┴──────────┐ ┌──────────┴──────────┐
Project Transfer Options Project: 09:04:24
DN3000 DN3000 DN3000 DN3000 DN3000 DN3000 DN3000 DN3000 DN3000 DN3000
DN3000 DN3000 DN3000 DN3000 DN3000 DN3000 DN3000 DN3000 DN3000 DN3000
DN3000 DN3000 DN3000 DN3000 DN3000 DN3000 DN3000 DN3000 DN3000 DN3000
DN3000 DN3000 DN3000 DN3000 DN3000 DN3000 DN3000 DN3000 DN3000 DN3000
DN3000 DN3000 DN3000 DN3000 DN3000 DN3000 DN3000 DN3000 DN3000 DN3000
DN3000 DN3000 DN3000 DN3000 DN3000 DN3000 DN3000 DN3000 DN3000 DN3000
DN3000 DN3000 DN3000 DN3000 DN3000 DN3000 DN3000 DN3000 DN3000 DN3000
DN3000 DN3000 DN3000 DN3000 DN3000 DN3000 DN3000 DN3000 DN3000 DN3000
DN3000 DN3000 DN3000 DN3000 DN3000 DN3000 DN3000 DN3000 DN3000 DN3000
DN3000 DN3000 DN3000 DN3000 DN3000 DN3000 DN3000 DN3000 DN3000 DN3000
DN3000 DN3000 DN3000 DN3000 DN3000 DN3000 DN3000 DN3000 DN3000 DN3000
DN3000 DN3000 DN3000 DN3000 DN3000 DN3000 DN3000 DN3000 DN3000 DN3000
DN3000 DN3000 DN3000 DN3000 DN3000 DN3000 DN3000 DN3000 DN3000 DN3000
DN3000 DN3000 DN3000 DN3000 DN3000 DN3000 DN3000 DN3000 DN3000 DN3000
DN3000 DN3000 DN3000 DN3000 DN3000 DN3000 DN3000 DN3000 DN3000 DN3000
DN3000 DN3000 DN3000 DN3000 DN3000 DN3000 DN3000 DN3000 DN3000 DN3000
┌──────────┴──────────┐
Information
DN3000 Configuration Editor v1.03B
Panel-Tec, Inc.
Mailing Address
P.O. Box 2394
Huntsville, AL 35803-2394
Shipping Address
2607 Leeman Ferry Rd
Huntsville, AL 35801
Continental United States - (800) 869-2026
Outside the United States - (205) 534-8132
Fax Number - (205) 534-4769
┌──────────┴──────────┐
Welcome to the DN3000 Configuration Editor.

```

After pressing the computer’s **ENTER** key, the support information page will disappear. Use the computer’s **LEFT/RIGHT** arrow keys and move the highlighted bar (very top of the screen) between the four (4) main system selection headers. To select any one of these main selection headers, place the highlight bar around that desired heading and then press the computer’s **ENTER** key. Below is a brief description of the main project header and each internal subheading; **NOTE:** These brief descriptions listed are as the system starts without any projects opened or new projects created.

Selecting **PROJECT** opens a menu with the following options:

- OPEN** allows you to open any saved project file.
- NEW** allows you to create a new project file.
- DOS SHELL** allows you to exit to MS-DOS without closing the DN-3000 Configuration Editor Program and return to the Configuration Editor Program by typing in EXIT and then pressing the **ENTER** key.
- QUIT** allows you to exit the Configuration Editor Program.

Creating Project Files

CREATING A PROJECT FILE

To create a project file, move the highlighted bar to the **“PROJECT”** heading and press the computer’s **ENTER** key. When the menu appears move the highlight bar to the **“NEW”** sub-heading and press

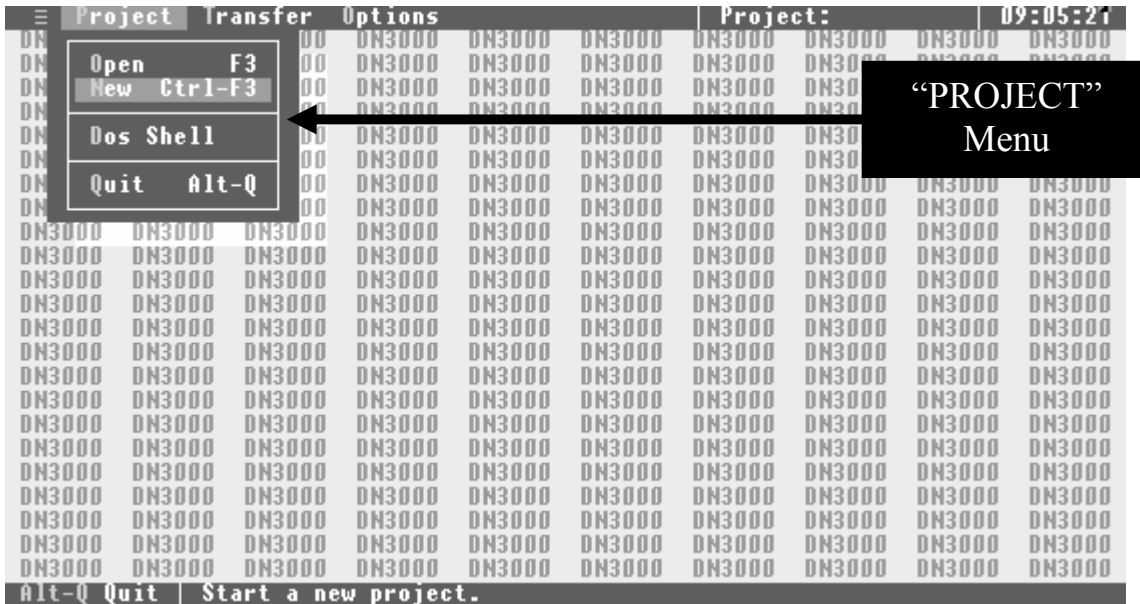

the computer’s **ENTER** key. At the **“Project Name”** entry area, type in your file name.

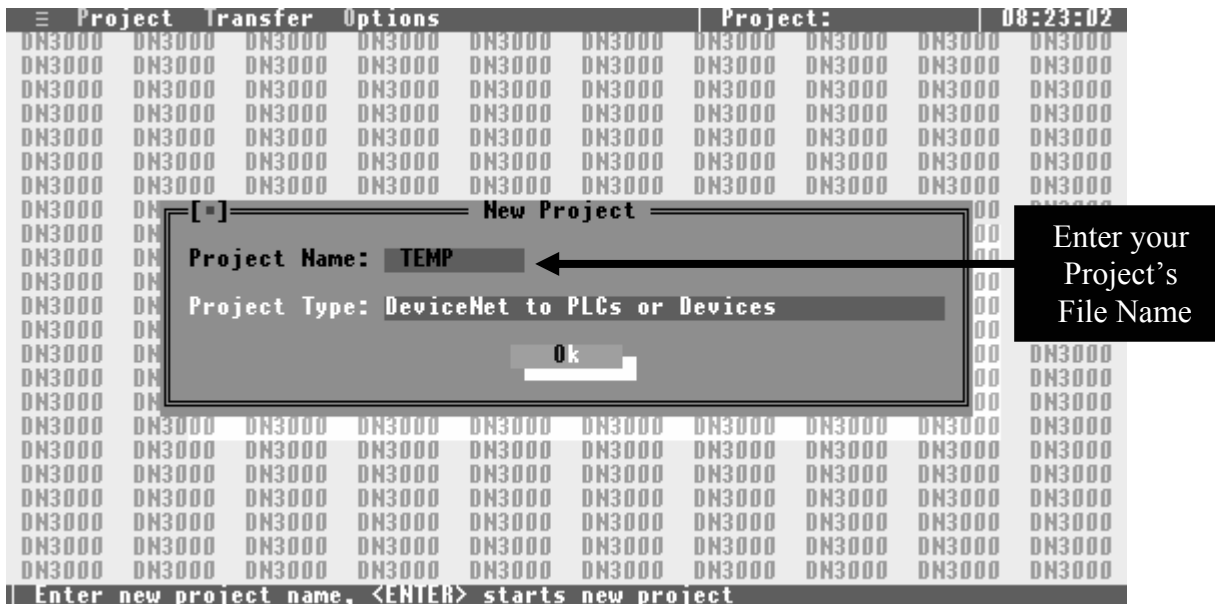

After entering in the project’s file name, press the **ENTER** key. The highlighted bar now moves to **“Project Type”**. Press **ENTER** to open the **“Project Type”** window (default setting is **“DeviceNet to PLCs or Devices”**). Move the highlight bar by pressing the **DOWN** arrow key to the project type you wish to configure and then press the **ENTER** key. The software enters this selection and returns to the **“PROJECT”** menu.

Creating Project Files

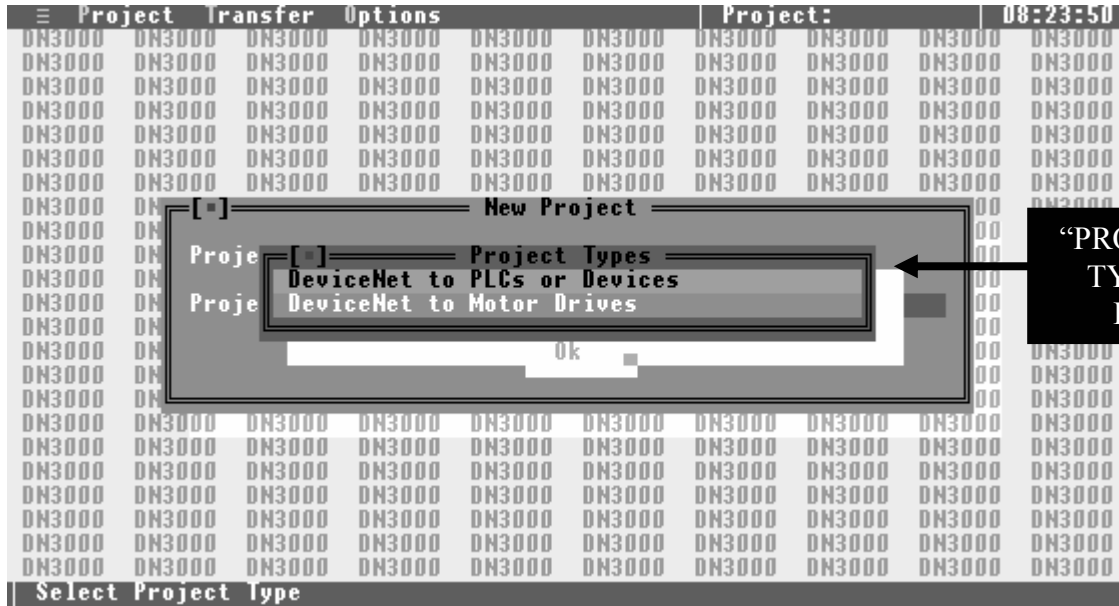

PROJECT TYPES

DeviceNet to PLCs or Devices allows a DeviceNet Host to read and write registers in up to 32 PLCs or devices.

DeviceNet to Motor Drives allows a DeviceNet Host to control and/or monitor up to 32 supported Motor Drives.

Creating Project Files

When the system returns to the “**PROJECT**” menu, notice the additional sub-headings that were added to the “**PROJECT**” menu and are now available for you to use. A brief description of each of these new sub-headings are listed below:

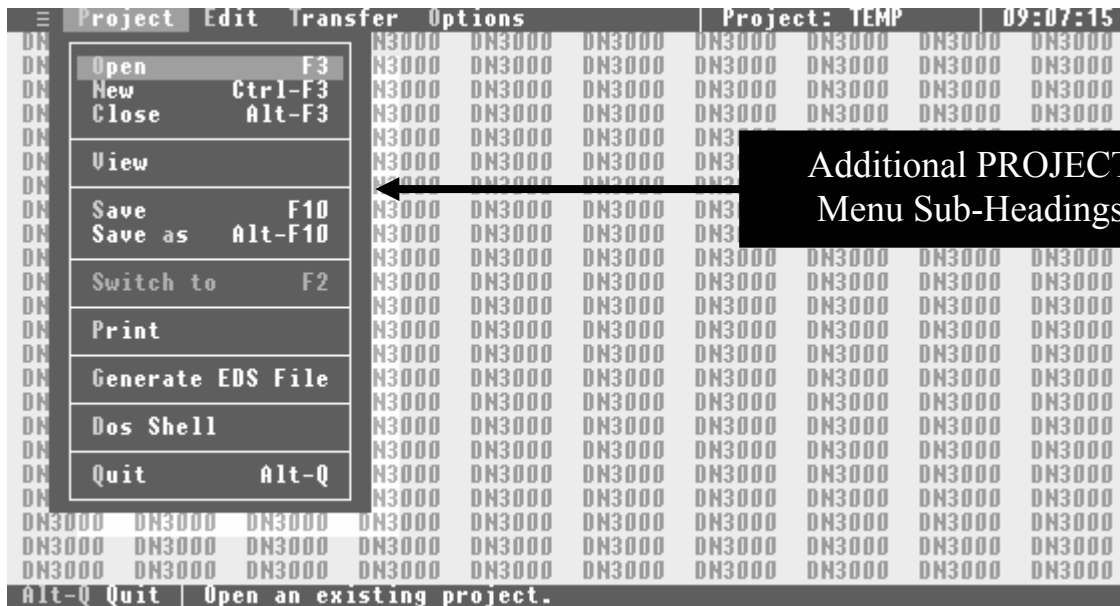

CLOSE allows you to close a project file. More than one project file can be open at any time.

VIEW allows you to view; the project file name, project file type, and the current selections for each of the DN-3000’s serial ports.

SAVE allows you to save the current project file.

SAVE AS allows to save the current open project file under a different file name.

SWITCH TO allows you to switch between the opened project files. (Multiple files can be open.)

PRINT allows you to print the project file’s configuration information.

GENERATE EDS FILE allows you to generate an EDS file for the current Project. The EDS file is used to tell a DeviceNet configuration tool information about the DN-3000 and I/O sizes. If you are using a DeviceNet configuration tool to set up your DeviceNet network, you should generate a new EDS file for each project.

Use the **RIGHT** arrow key to move the highlight bar from the top “**PROJECT**” header to the top “**EDIT**” header to proceed with editing the configuration information stored in the project file.

DeviceNet to PLCs or Devices

DEVICENET TO PLCs OR DEVICES

The "*DeviceNet to Motor Drives*" application allows a DeviceNet Host device to access data registers in up to 32 serial PLCs or Devices via Explicit Messages and/or I/O Data.

Explicit Messages allows the DeviceNet Host to issue requests to the DN-3000 to read or write specific PLC/Device data registers. The DN-3000 converts those requests into serial communications requests in the selected serial PLC's or Device's protocol.

I/O Data allows the DN-3000 to exchange a fixed set of PLC/Device data registers between a DeviceNet Host and serial PLCs or Devices. The DN-3000 writes Output Data received from the DeviceNet Host to fixed PLC/Device data registers (see **Output Data Table** in this section) in the connected serial PLCs or Devices. Input Data is read from fixed PLC/Device data registers in the connected serial PLCs or Devices and sent to the DeviceNet Host (see **Input Data Table** in this section).

Important Note: The DN-3000 can be used to access only *data registers* in the selected PLCs or Devices. See the **Application Notes** for the selected PLC/Device for more information.

DEVICE PROFILE

The DN-3000 is based on the "**PLC/Device Gateway**" Device Profile, a vendor-specific extension of the "**Communications Adapter**" Device Profile (described in the "ODVA DeviceNet Specifications"). This Device Profile introduces two new vendor-specific Objects: the "**PLC/Device Interface Object**" and the "**PLC/Device Command Object**". Documentation on this profile and these objects are available from Panel-Tec, Inc.

The DN-3000 is a *Group 2 Only Server* utilizing the *Predifined Master/Slave Connection Set* (as described in the (ODVA DeviceNet Specifications"). It supports both *Explicit Messaging* and *Polled, Change-of-State (COS) and Cyclic I/O* connections to a DeviceNet Host. It does not support *Bit-Strobed I/O* connections.

To access register data via *Explicit Messaging*, the DeviceNet Host must issue an explicit *Get_Member* or *Set_Member* request to the desired "**PLC/Device Interface Object**" Instance (based on PLC/Device Address) of the DN-3000.

If *Polled, COS and/or Cyclic I/O* connections are to be used, you must first set up the I/O configuration of the DN-3000 with the *DN3000 Configuration Editor* software. See **I/O Data Configuration** in this section.

DeviceNet to PLCs or Devices

EXAMPLE APPLICATIONS

DeviceNet Host to Serial PLC with Pass-Through Connection

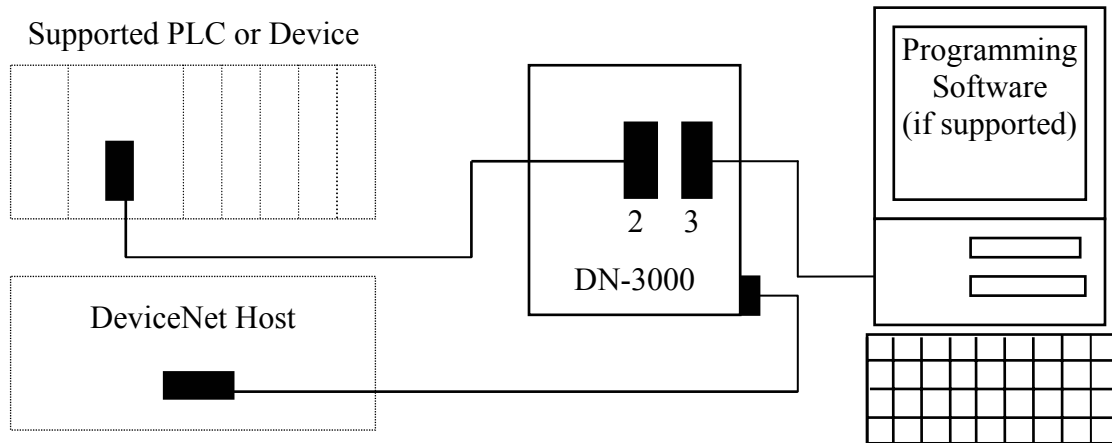

DeviceNet Host to Multi-Dropped Serial PLCs

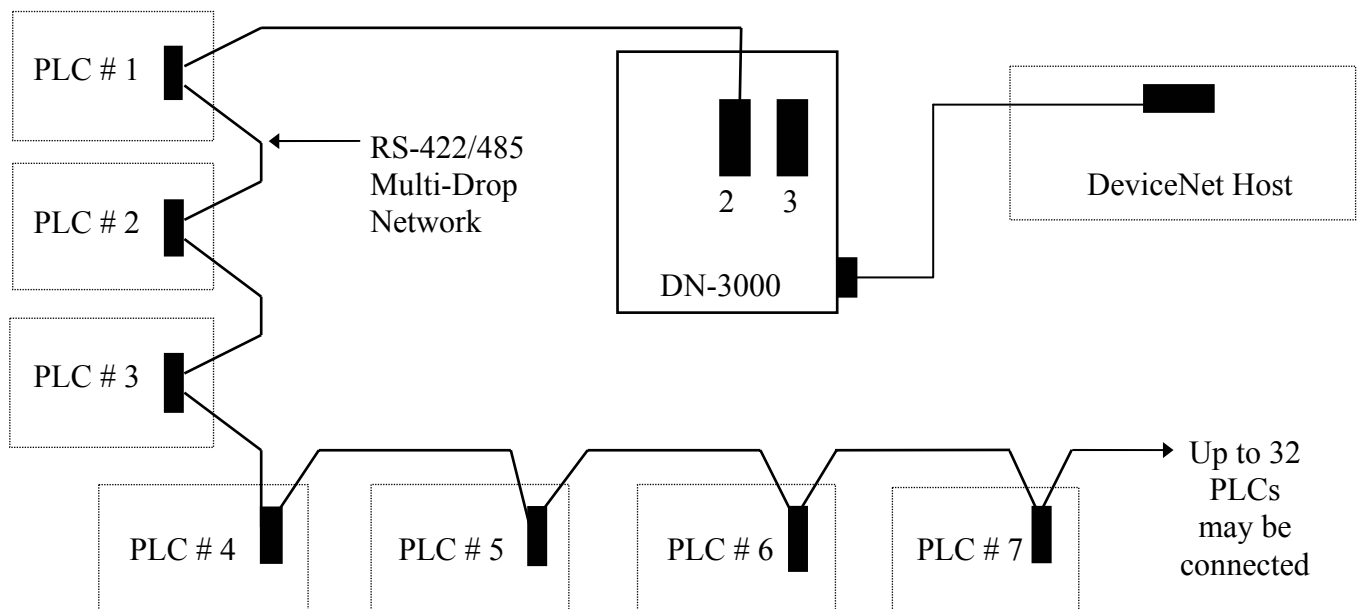

NOTE: Multiple PLCs/Devices can be connected to Port 2 of a DN-3000 if:

- 1) All PLCs/Devices use the same protocol.
- 2) Each PLC/Device can be internally addressed with a network address.
- 3) Each PLC/Device can communicate on a RS-485/422 multi-drop communications network;
-OR- RS232 to RS485 converters (1 per PLC or Device) are used;
-OR- a 3rd Party multi-port communications expansion module (Port Expander) is used.

DeviceNet to PLCs or Devices

Multiple DN-3000s with Different PLC or Device Types

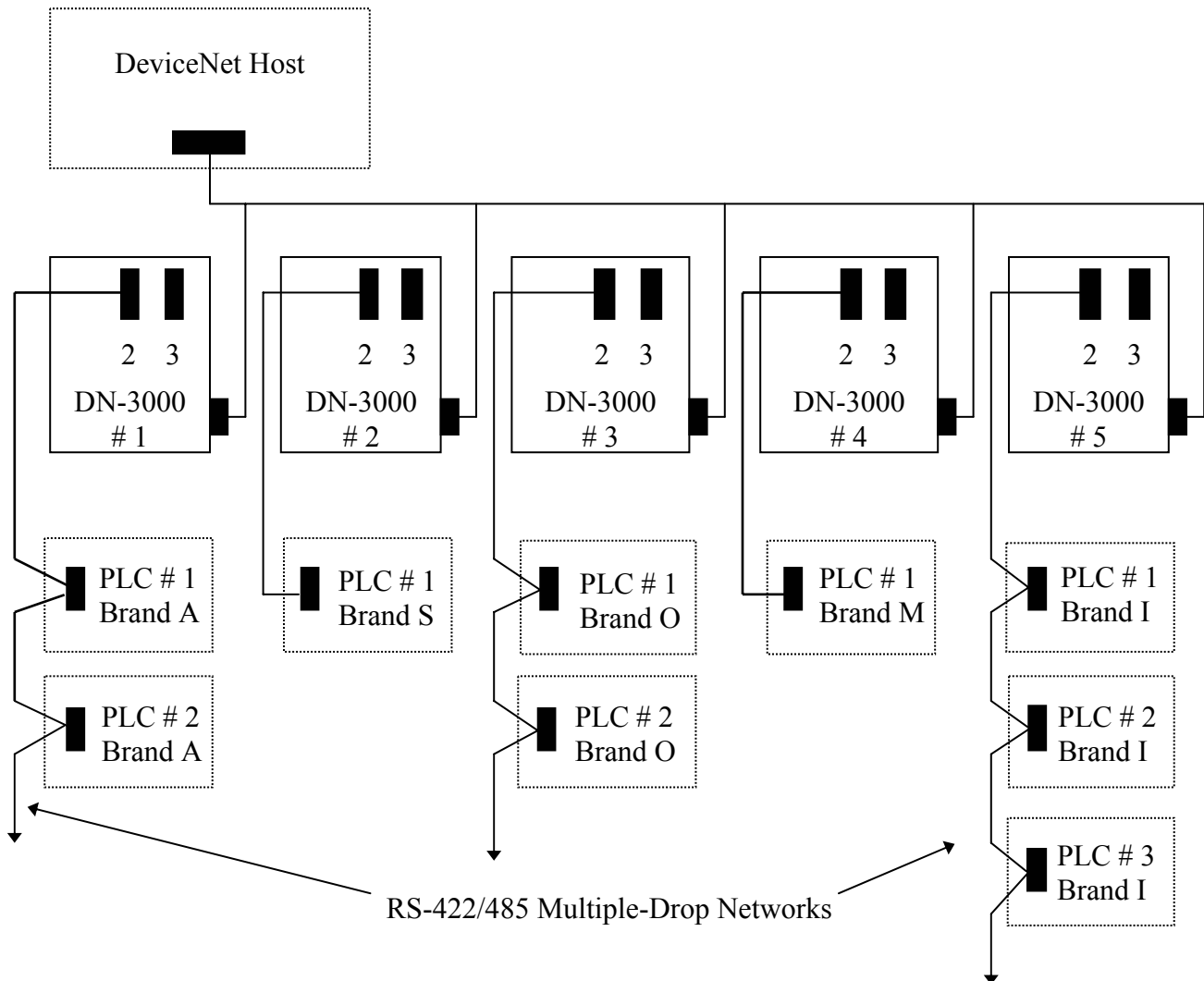

NOTE:

- 1) Each DN-3000 can support up to 32 PLCs/Devices (if they are network addressable internally).
- 2) The DeviceNet Host can address a maximum of 63 DN-3000 units.
- 3) Multiple Brands of PLCs or Devices may be addressed by the DeviceNet Host by using multiple DN-3000s, but only one PLC/Device Protocol may be used on a single DN-3000 unit.
- 4) If multiple DN-3000s are to be used, each DN-3000 must be configured with a unique node address (MAC ID) on the DeviceNet network.

DeviceNet to PLCs or Devices

CONFIGURING PORT #1, (DEVICENET)

With the highlight bar around the “PROJECT” header use the **RIGHT** arrow key and move the highlight bar to the “EDIT” header. This action will close the “PROJECT” menu and open the “EDIT” menu.

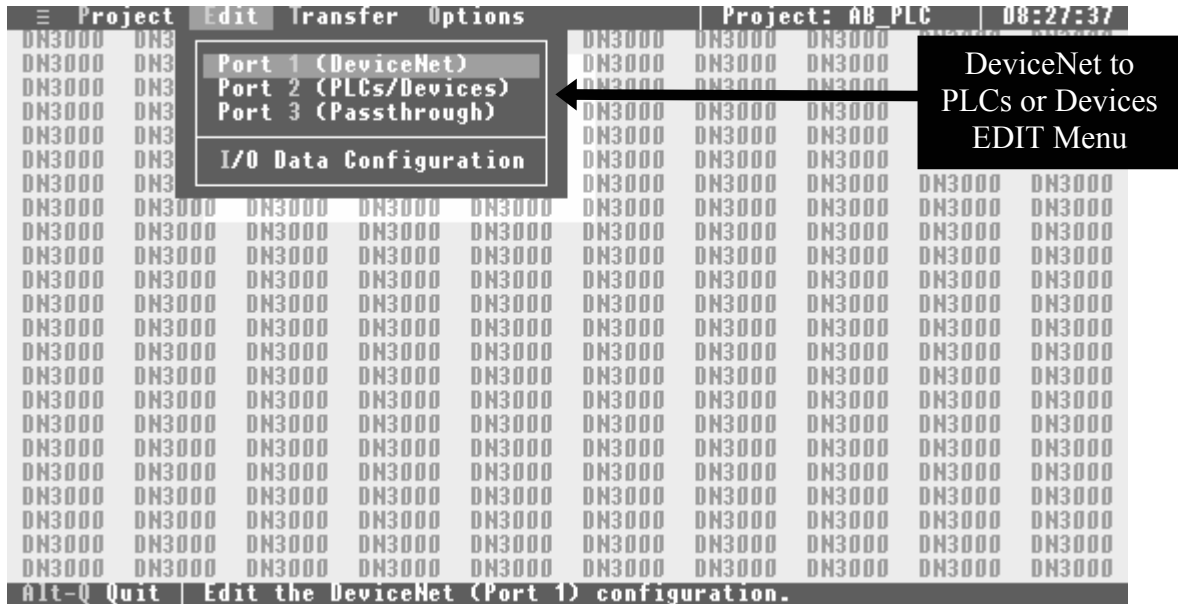

Move the highlight bar to the “Port 1 (DeviceNet)” sub-heading and press the **ENTER** key to open the DeviceNet configuration screen.

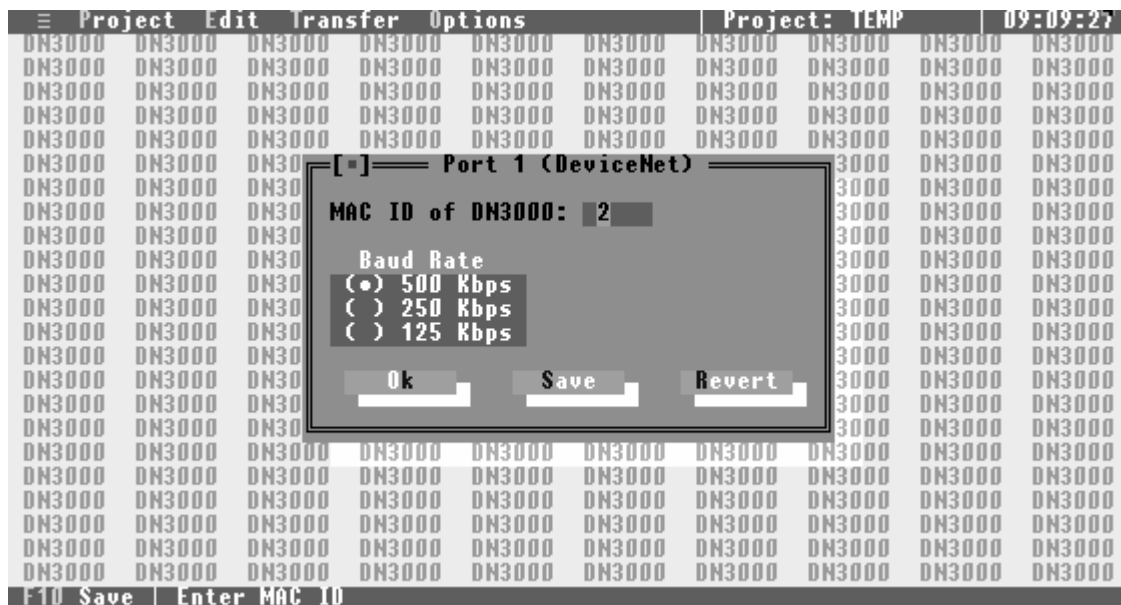

DeviceNet to PLCs or Devices

MAC ID of DN3000

The MAC ID of the DN-3000 is its node address on a DeviceNet Network. The MAC ID of a DN-3000 can range from 0 to 63. Type the desired value in the field and press **ENTER**.

Baud Rate

Baud Rate determines the rate at which the DN-3000 exchanges data on a DeviceNet network. The Baud Rate setting must be the same for all devices on the DeviceNet network. The DN-3000 supports baud rates of 125, 250 and 500 kbps. The dot between the brackets indicates the current selection. Use the **UP/DOWN** arrow keys and the **SPACEBAR** to select the desired baud rate.

DeviceNet to PLCs or Devices

CONFIGURING PORT #2 (PLCs OR DEVICES)

When the highlight bar is around the “Port 2 (PLCs/Devices)” sub-heading, press the ENTER key. This opens a window which allows you to select the type of PLCs or devices connected to this port and check all of the communication settings.

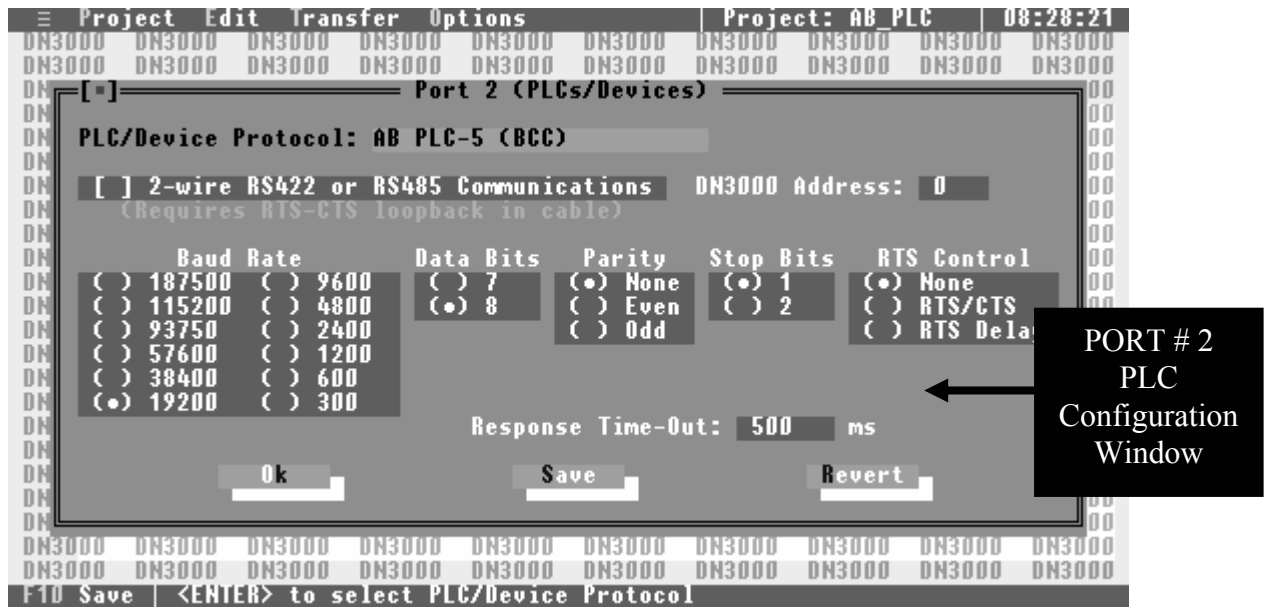

PLC/Device Protocol

The window for PORT # 2 Configuration will open with the highlighted bar at the “PLC/DEVICE PROTOCOL” selection heading. If the displayed Protocol is not the one wanted, simply press the ENTER key and a smaller window will appear.

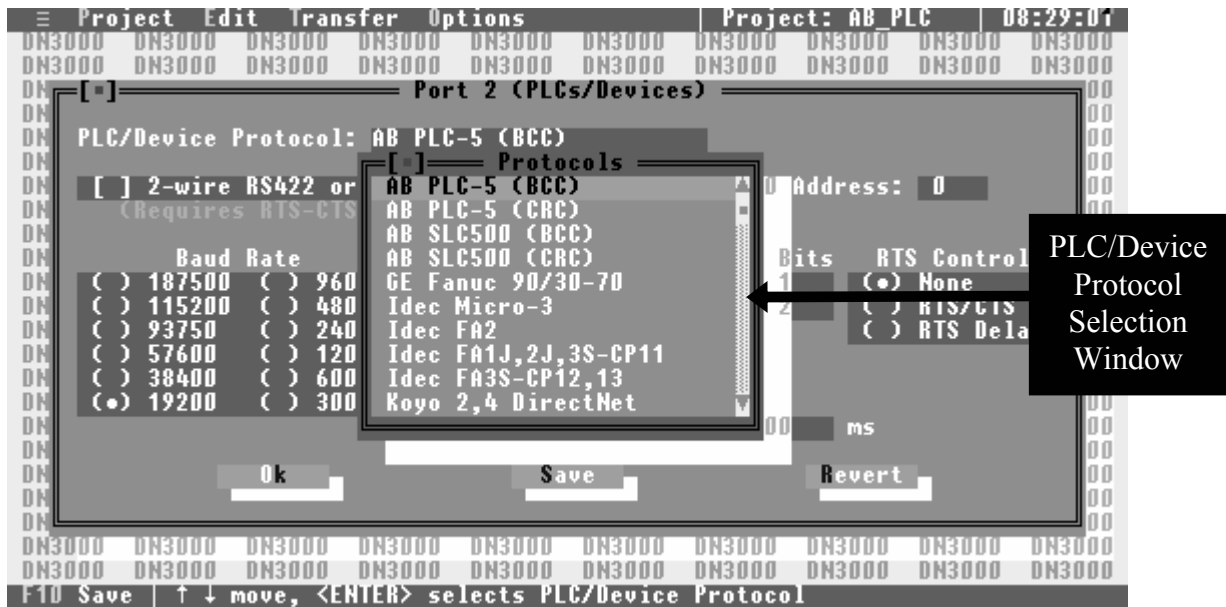

DeviceNet to PLCs or Devices

Use your computer's **UP/DOWN** arrow keys to move through the PLC/Device Protocol List. Place the highlight bar on the desired Protocol and press the **ENTER** key. The software will enter this selection and automatically close the Protocol selection window. After the selection window closes, you will need to check the communications setting for the selected Protocol, making changes as necessary.

2 Wire RS422 or RS485 Communications

This box will only need to be checked if the communications with your PLC/Device is a 2-wire RS485 or RS422 interface. When 2-wire communications are being used, RTS must be looped back to CTS on the DN-3000 side of the cable. This can be done on the RS232 side by looping pins 4 and 5 or on the RS422/485 side by looping 16 to 18 and 17 to 19.

DN3000 Address

Some PLC/Device protocols require each PLC or Device on a network to be assigned a unique address. The DN3000 Address is the address assigned to the DN-3000 on the PLC/Device network.

Communications Settings

The communications settings are automatically set to the default values for each type of PLC/Device when its Protocol is first selected. Before changing any of these settings, consult your PLC/Device manual for the correct settings. To move between the communications settings, press the **TAB** or **ENTER** keys. To select a setting, use the **UP/DOWN** arrow key to move to the desired setting and press the **SPACE BAR** to enter or change your selection.

RTS Control (Request to Send Control)

RTS Control selection is an option provided for modems or for PLCs/Devices that require RTS to be active only while the DN-3000 is transmitting to the PLC. If **RTS/CTS** is selected, the DN-3000 will activate RTS and wait until CTS is active before transmitting to the PLC. If **RTS Delay** is selected, the DN-3000 will activate RTS and wait for the specified delay time to pass before transmitting to the PLC.

Response Time-Out

The Response Time-Out tells the DN-3000 how long to wait after transmitting a request to a PLC/Device if no response has been received from the PLC/Device. After this amount of time (specified in milliseconds) passes with no response being received, the DN-3000 will assume that no response is coming and will retry the request.

To save the configuration for Port #1, press the "**Alt+S**" keys or the **F10** function key once and a small window appears stating the information was saved. Press the **ENTER** key, then the **ESC** key to return to the "**EDIT**" window.

DeviceNet to PLCs or Devices

CONFIGURING PORT # 3 (PASSTHROUGH)

Not all PLC/Device protocols allow for the pass-through communications. If your selected Protocol on Port 2 is capable of pass-through communications, the “Port 3 (Passthrough)” header within the “EDIT” menu will be black (if light gray, the PLC does not support Pass-Through communications). Place the Highlight bar around the “Port 3 (Passthrough)” header and press the ENTER key to open this screen. (See drawing below)

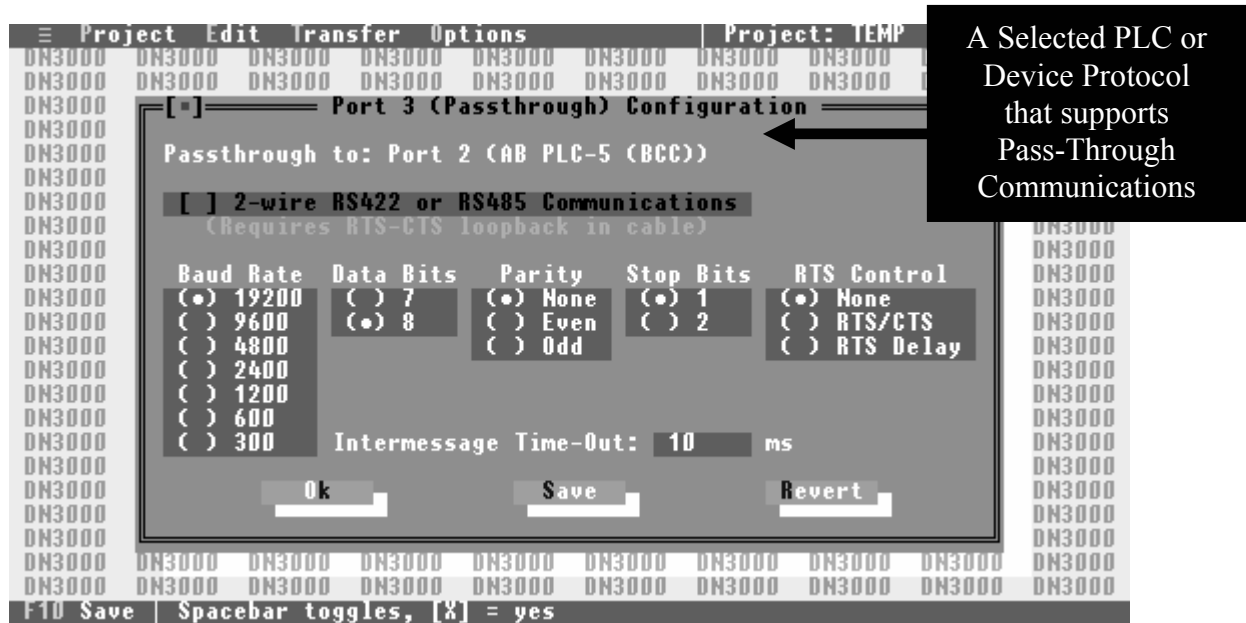

For descriptions of all entry fields on this screen except for the Intermessage Time-Out, refer to *CONFIGURING PORT #2 (PLCs or Devices)* in this section.

Intermessage Time-Out

The DN-3000 uses the Intermessage Time-Out to determine when a complete message has been received on the PassThrough port. Once the first character of a message has been received, if the amount of time specified by the Intermessage Time-Out passes with no additional characters being received, the DN-3000 will consider the message to be complete and process it.

Check over the communications settings, making corrections as needed, and save this information by pressing the letter “S” or the F10 function key(s) once. A small window will appear stating the information was saved. Press the ENTER key, then the ESC key to return to the “EDIT” menu.

DeviceNet to PLCs or Devices

I/O DATA CONFIGURATION

Using the **DOWN** arrow key, move the highlight bar to the **"I/O Data Configuration"** sub-heading within the **"EDIT"** menu and press the **ENTER** key. This action opens the I/O Data Configuration setup screen to allow you to set up the I/O data parameters for your project. You should have some idea of how you want your I/O set up before selecting this option.

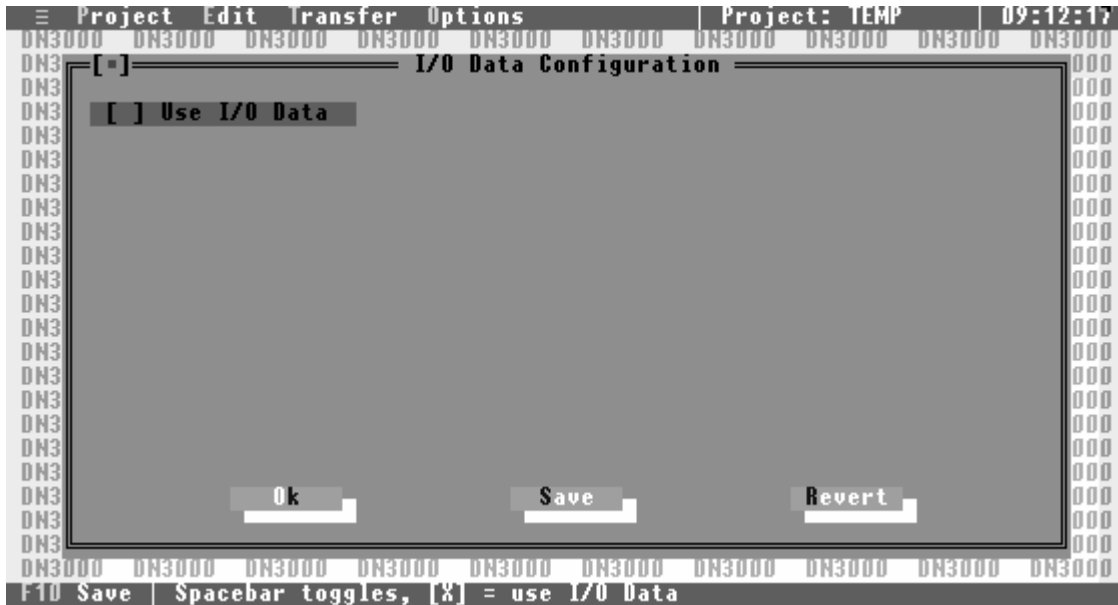

Use I/O Data

If your project requires the use one or more I/O connections (Polled, Change-Of-State (COS) or Cyclic I/O) for data exchange between the DN-3000 and a DeviceNet host, you should select this option by pressing the **SPACEBAR**, 'X' or 'Y' key on your keyboard. When you select **"Use I/O Data"**, the other available I/O options will appear on the screen.

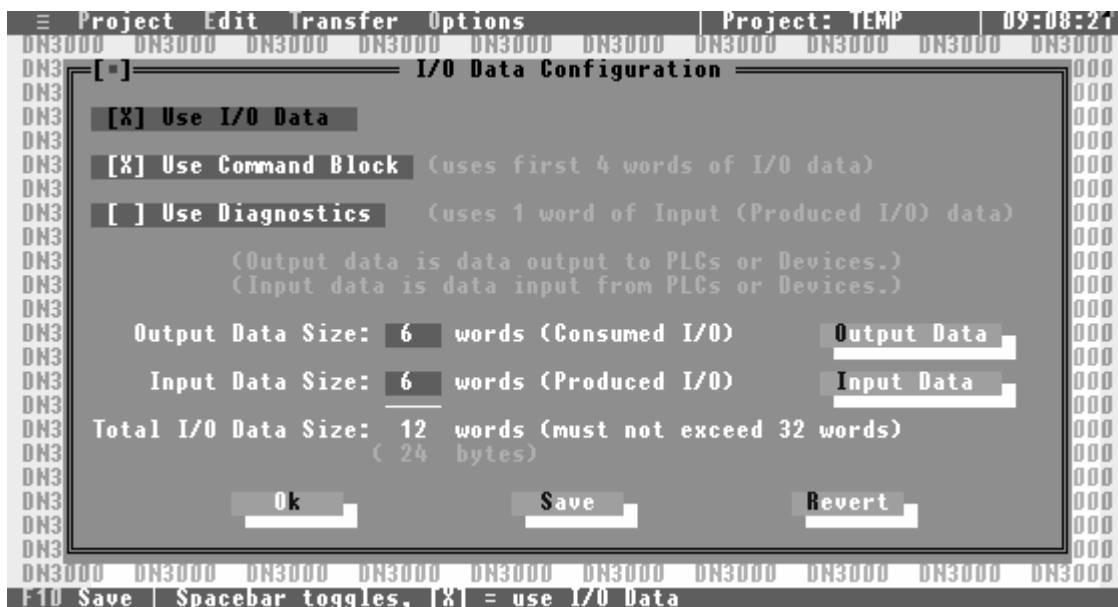

DeviceNet to PLCs or Devices

The DN-3000 supports up to a total of 64 bytes (32 words) of combined Input and Output data. Each word (2 bytes) of Input or Output data can be configured to exchange data with any one valid data register in any one of the PLCs/Devices connected to port 2 of the DN-3000 (see “**CONFIGURING PORT 2**” for PLC/Device Protocol and communication parameters).

Use Command Block

In some projects it may be necessary to be able to access more than just the 32 PLC/Device registers that can be configured in the Input and Output data. A *Command Block* reserves the first 4 words of Output data for commands, and the first 4 words of Input data for command results. This reduces your total number of words that can be used for register data to 24 words, but adds flexibility by allowing your DeviceNet Host to issue commands to the DN-3000 to access *any* valid data registers in any PLC or Device connected to port 2 of the DN-3000. Commands are issued by moving a command code, PLC/Device address, file number (Allen-Bradley PLCs only), register number, and data into the first 4 words of the Output data (see “**COMMAND BLOCK**”).

Use Diagnostics

Diagnostics allows the DeviceNet Host to monitor PLC/Device connections to the DN-3000. The first word of the Input data following the Command Result Block (if any) will be reserved for Diagnostics if this option is selected. The DN-3000 keeps track of the connection status with each PLC/Device address (0-255). Whenever an attempt to communicate with a PLC/Device is successful, the connection status for that PLC/Device is set to ‘0’. Whenever an attempt to communicate with a PLC/Device is unsuccessful, the connection status for that PLC/Device is set to ‘1’. Of course, returning 256 status bits would require 16 words of Input data (*half* of the available I/O data). Instead, only 16 bits (1 word) of are returned. Each of the 16 bits of the Diagnostics word represents the status of 16 PLC/Device addresses, as follows: bit 0 represents PLC/Device addresses 0, 16, 32, 48, 64, etc.; bit 1 represents PLC/Device addresses 1, 17, 33, 49, 65, etc.; and so forth. If the status of *any* of the PLC/Device addresses represented by a bit is ‘1’, that bit will contain a ‘1’, otherwise, that bit will contain a ‘0’. Note that the status of a PLC/Device is set to ‘1’ *only* if the DN-3000 *attempts* to communicate with that PLC/Device *and* that attempt is unsuccessful.

Output Data Size

This determines the number of words of Output data that will be used in your project. Output data is data that is *output* from your DeviceNet Host to the DN-3000 (commands, and register data to be written to PLCs/Devices). This is also known as the *Consumed I/O Data* of the DN-3000. If a Command Block is used, it will automatically reserve 4 words of Output data. The combined size of the Input and Output data must not exceed 32 words.

Output Data

Pressing the Output Data button brings up a window allowing you to edit the configuration of the Output data in your project. You can press the Output Data button by clicking on it with your mouse, or moving the *focus* to the button with the arrow keys and pressing the **SPACEBAR**. See “**OUTPUT DATA TABLE**”.

DeviceNet to PLCs or Devices

Input Data Size

This determines the number of words of Input data that will be used in your project. Input data is data that is *input* to your DeviceNet Host from the DN-3000 (command results, diagnostics information, and register data read from PLCs/Devices). This is also known as the *Produced I/O Data* of the DN-3000. If a Command Block is used, it will automatically reserve 4 words of Input data for command results. Similarly, if Diagnostics is used, it will automatically reserve 1 word of Input data. The combined size of Input and Output data must not exceed 32 words.

Input Data

Pressing the Input Data button brings up a window allowing you to edit the configuration of the Input data in your project. You can press the Input Data button by clicking on it with your mouse, or moving the *focus* to the button with the arrow keys and pressing the **SPACEBAR**. See “**INPUT DATA TABLE**”.

DeviceNet to PLCs or Devices

OUTPUT DATA TABLE

Within the “I/O Data Configuration” screen, use the **DOWN** arrow key to move the *focus* to the Output Data button and press the **ENTER** key. This action opens the Output Data Table setup screen to allow you to set up the PLC/Device registers to be mapped to each word of Output data.

Output data is data received by the DN-3000 from the DeviceNet Host to be written to PLC/Device registers. Each word of Output data (except those reserved for the Command Block) can be mapped to specific PLC/Device registers. Output data is only written to registers when that data changes.



Use the **UP/DOWN** arrow keys to scroll through the list of Output data words until the highlight bar is over the Output word you wish to edit, and press **ENTER**. A window will open allowing you to edit the PLC/Device Address, File Number (Allen-Bradley PLCs only) and Register Number mapped to that Output word.

DeviceNet to PLCs or Devices

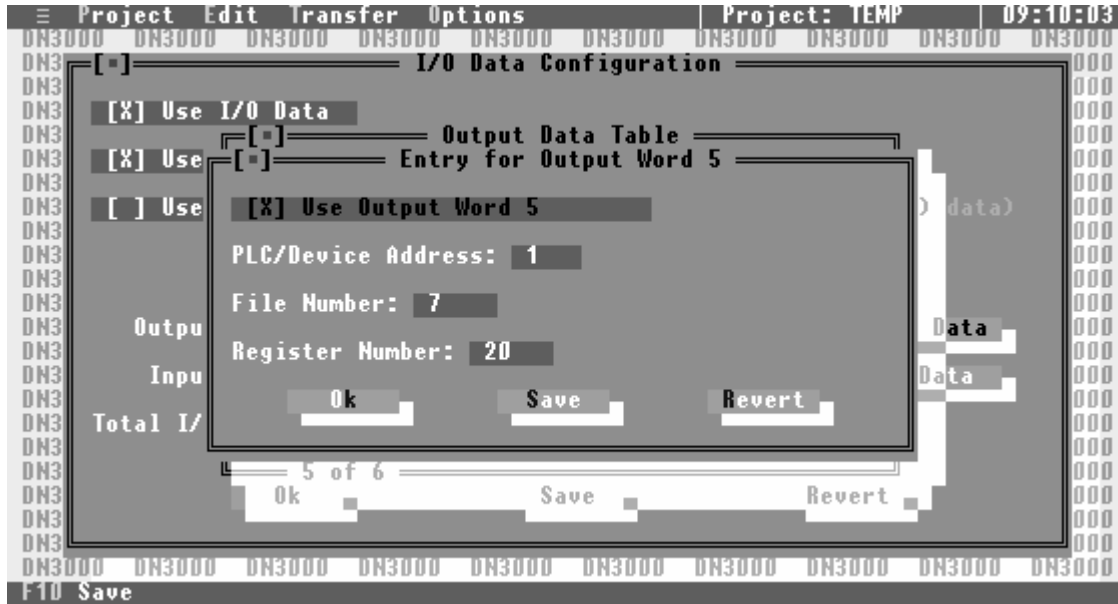

Use Output Word xx

If you want to map this word of Output data to a PLC/Device register, select this option. If this option is not selected, any data appearing in this Output word will be ignored.

PLC/Device Address

This is the Address of the PLC/Device mapped to this word of Output data. The PLC/Device Address must be in the range 0 to 255.

File Number (Allen-Bradley PLCs only)

This is the File Number of the register in the PLC mapped to this word of Output data.

Register Number

This is the Register Number of the PLC/Device mapped to this word of Output data. Whenever the value in this Output word changes, the DN-3000 will write that value to the register specified by the PLC/Device Address, File Number and Register Number.

DeviceNet to PLCs or Devices

INPUT DATA TABLE

Within the “I/O Data Configuration” screen, use the **DOWN** arrow key to move the *focus* to the Input Data button and press the **ENTER** key. This action opens the Input Data Table setup screen to allow you to set up the PLC/Device registers to be mapped to each word of Input data.

Input data is data read from PLC/Device registers and sent from the DN-3000 to the DeviceNet Host. Each word of Input data (except those reserved for the Command Block and Diagnostics) can be mapped to specific PLC/Device registers. Mapped registers in the Input Data Table are read from the PLCs/Devices and placed in the Input data in a round-robin fashion as quickly as the serial communications link allows.

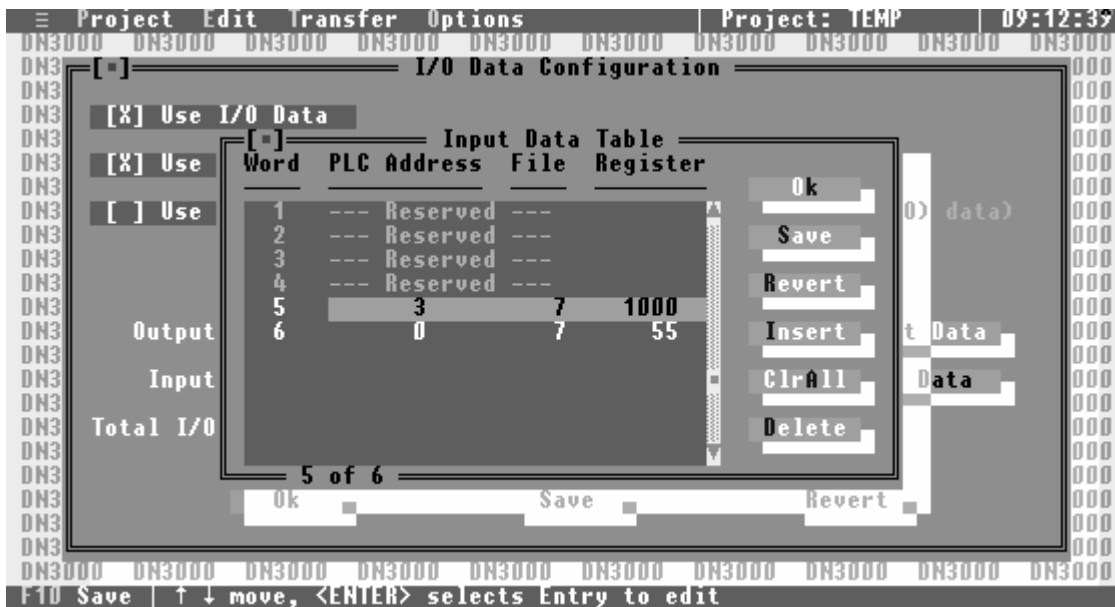

Use the **UP/DOWN** arrow keys to scroll through the list of Input data words until the highlight bar is over the Input word you wish to edit, and press **ENTER**. A window will open allowing you to edit the PLC/Device Address, File Number (Allen-Bradley PLCs only) and Register Number mapped to that Input word.

DeviceNet to PLCs or Devices

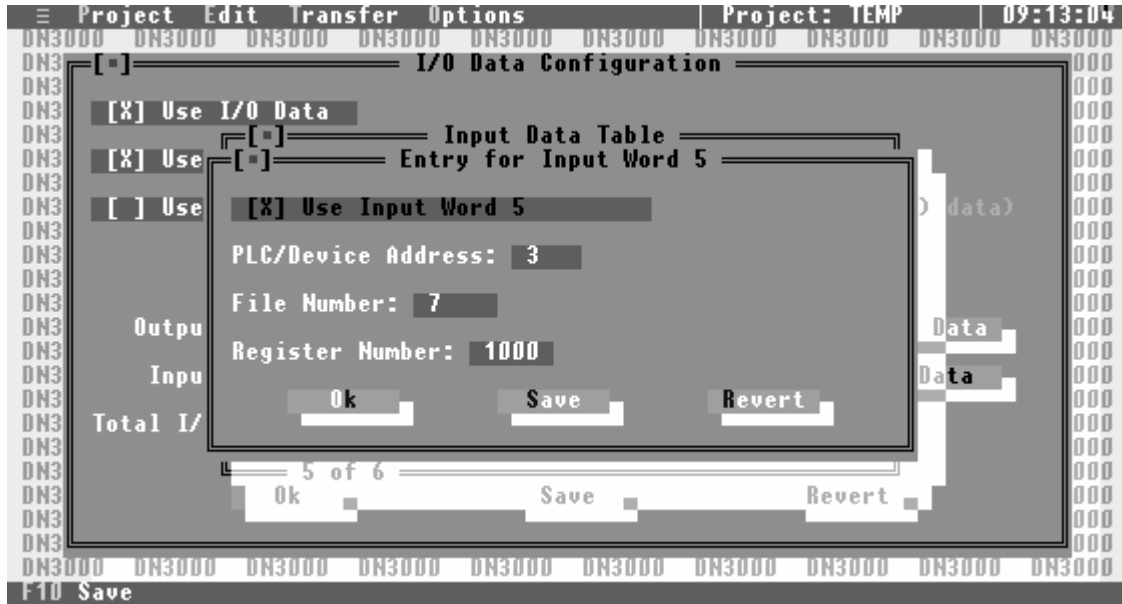

Use Input Word xx

If you want to map this word of Input data to a PLC/Device register, select this option. If this option is not selected, the data in this Input word will be set to 0.

PLC/DeviceAddress

This is the Address of the PLC/Device mapped to this word of Input data. The PLC/Device Address must be in the range 0 to 255.

File Number (Allen-Bradley PLCs only)

This is the File Number of the register in the PLC mapped to this word of Input data.

Register Number

This is the Register Number in the PLC/Device mapped to this word of Input data. The DN-3000 will read the value of the register specified by the PLC/Device Address, File Number (Allen-Bradley PLCs only) and Register Number and place that value in this word of the Input data.

DeviceNet to PLCs or Devices

COMMAND BLOCK

Using I/O data to update and/or monitor motor drive parameters requires very little programming in your DeviceNet Host device – the configuration of the DN-3000 specifies which PLC/Device registers are mapped to which words of I/O data. However, you can only access a total of 32 registers this way, and those registers are fixed when the DN-3000 is configured. If your application requires that you access more than 32 registers, you must either use multiple DN-3000s, or use a *Command Block*.

A Command Block allows your DeviceNet Host to issue commands at run-time to read or write any valid register in any PLC/Device connected to Port 2 of the DN-3000. The Command Block reserves the first 4 words of Output data for commands issued by the Host, and the first 4 words of Input data for the results of those commands (along with any returned data). Commands are issued by moving a *PLC/Device Address*, *File Number*, *Register Number*, any required *Register Data* (for write commands only), and a *Command* code into the *Command Block*, as follows:

	15	14	13	12	11	10	9	8	7	6	5	4	3	2	1	0
word 1	PLC/Device Address (0-255)								0	0	0	0	Command			
word 2	File Number															
word 3	Register Number															
word 4	Register Data (write command only)															

The DN-3000 looks for changes in the *Command Block* data to determine when there is a new request to be processed, “throwing out” any invalid commands received. Valid *Commands* are 1 (read) and 2 (write). To ensure that partial commands are not processed (in systems where it is possible that Output data could be sent by the host before all 4 words of data have been moved into the command block), you should set the *Command* to 0 (indicating no command), then place the data in words 2-4, and only set the *Command* to 1 or 2 after all of the other data is in place. After a command has been processed by the DN-3000, it will “echo” the command in the *Command Result Block* in the Input data, and set the *Result Code* and any *Returned Register Data*, as follows:

	15	14	13	12	11	10	9	8	7	6	5	4	3	2	1	0
word 1	PLC/Device Address								1	Result Code			Command			
word 2	File Number															
word 3	Register Number															
word 4	Returned Register Data (read command only)															

If a *read* command (1) was issued, the *Returned Register Data* will contain the register data read from the specified PLC/Device. If a *write* command (2) was issued, the *Returned Register Data* will be the same as for the issued command. The *Result Code* indicates the result of processing the issued command. Valid *Result Codes* are as follows:

Result Code	Meaning
0	Command was completed successfully.
1	DN-3000 could not communicate with indicated PLC/Device.
7	Command was invalid.

DeviceNet to Motor Drives

DEVICENET TO MOTOR DRIVES

The "*DeviceNet to Motor Drives*" application allows a DeviceNet Host device to access parameters in up to 32 serial Motor Drives via Explicit Messages and/or I/O Data.

Explicit Messages allows the DeviceNet Host to issue requests to the DN-3000 to read or write specific Motor Drive parameters. The DN-3000 converts those requests into serial communications requests in the selected serial Motor Drive's protocol.

I/O Data allows the DN-3000 to exchange a fixed set of Motor Drive parameters between a DeviceNet Host and serial Motor Drives. The DN-3000 writes Output Data received from the DeviceNet Host to fixed Motor Drive parameters (see **Output Data Table** in this section) in the connected serial Motor Drives. Input Data is read from fixed Motor Drive parameters in the connected serial Motor Drives and sent to the DeviceNet Host (see **Input Data Table** in this section).

DEVICE PROFILE

This application of the DN-3000 is based on the "**Motor Drive Gateway**" Device Profile, a vendor-specific extension of the "**Communications Adapter**" Device Profile (described in the "ODVA DeviceNet Specifications"). This Device Profile introduces two new vendor-specific Objects: the "**Motor Drive Interface Object**" and the "**Motor Drive Command Object**". Documentation on this profile and these objects are available from Panel-Tec, Inc.

The DN-3000 is a *Group 2 Only Server* utilizing the *Predefined Master/Slave Connection Set* (as described in the (ODVA DeviceNet Specifications)). It supports both *Explicit Messaging* and *Polled, Change-of-State (COS) and Cyclic I/O* connections to a DeviceNet Host. It does not support *Bit-Strobed I/O* connections.

To access Motor Drive Parameter data via *Explicit Messaging*, the DeviceNet Host must issue an explicit *Get_Member* or *Set_Member* request to the desired "**Motor Drive Interface Object**" Instance (based on Motor Drive Address) of the DN-3000.

If *Polled, COS and/or Cyclic I/O* connections are to be used, you must first set up the I/O configuration of the DN-3000 with the *DN3000 Configuration Editor* software. See **I/O Configuration** in this section.

DeviceNet to Motor Drives

EXAMPLE APPLICATIONS

DeviceNet Host to Serial Motor Drive

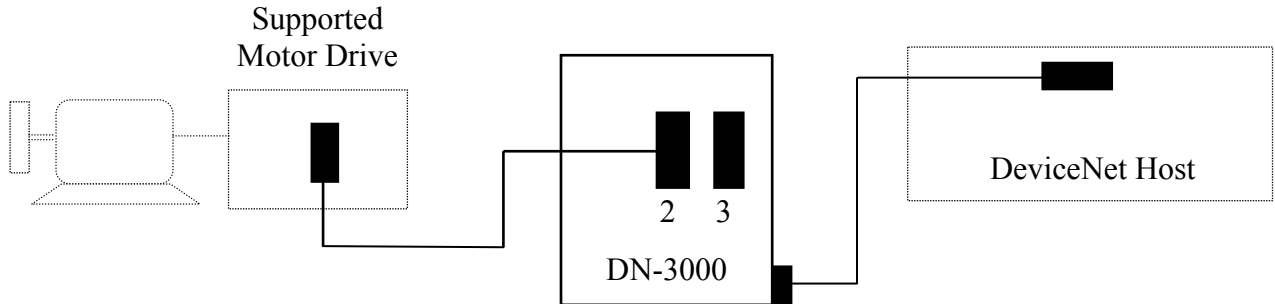

DeviceNet Host to Multi-Dropped Serial Motor Drives

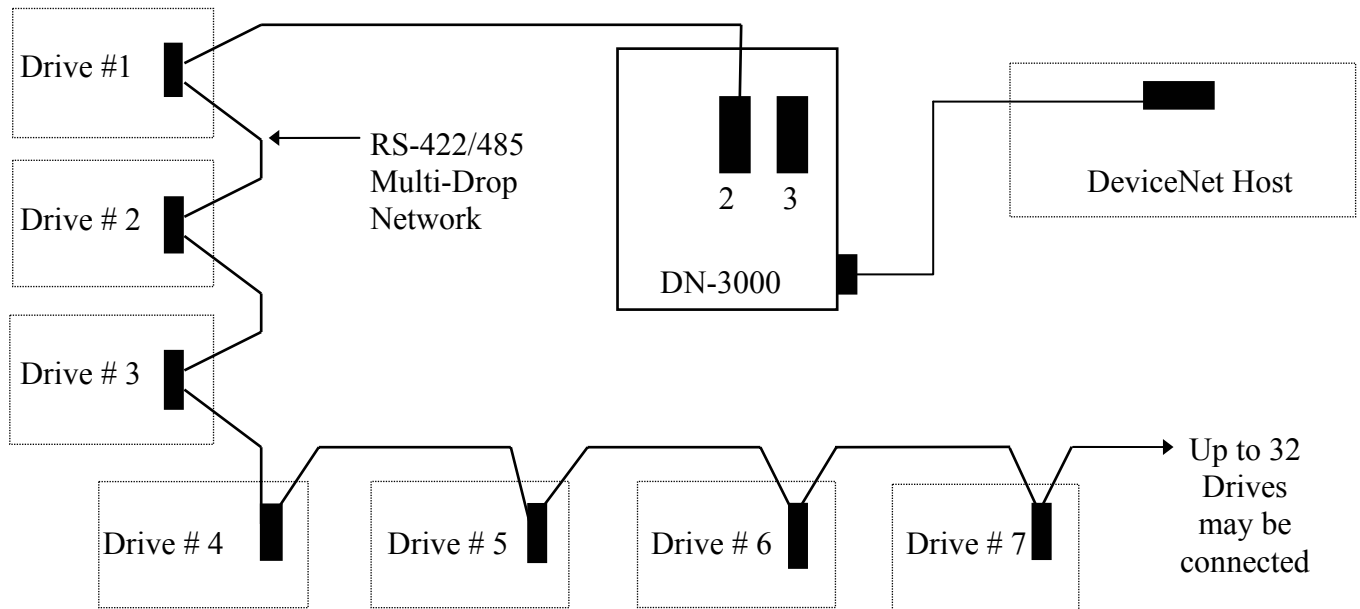

NOTE: Multiple Motor Drives can be connected to Port 2 of a DN-3000 if:

- 1) All Motor Drives use the same protocol.
- 2) Each Motor Drive can be internally addressed with a network address.
- 3) Each Motor Drive can communicate on a RS-485/422 multi-drop communications network;
-OR- RS232 to RS485 converters (1 per Motor Drive) are used;
-OR- a 3rd Party multi-port communications expansion module (Port Expander) is used.

DeviceNet to Motor Drives

Multiple DN-3000s with Different Motor Drive Types

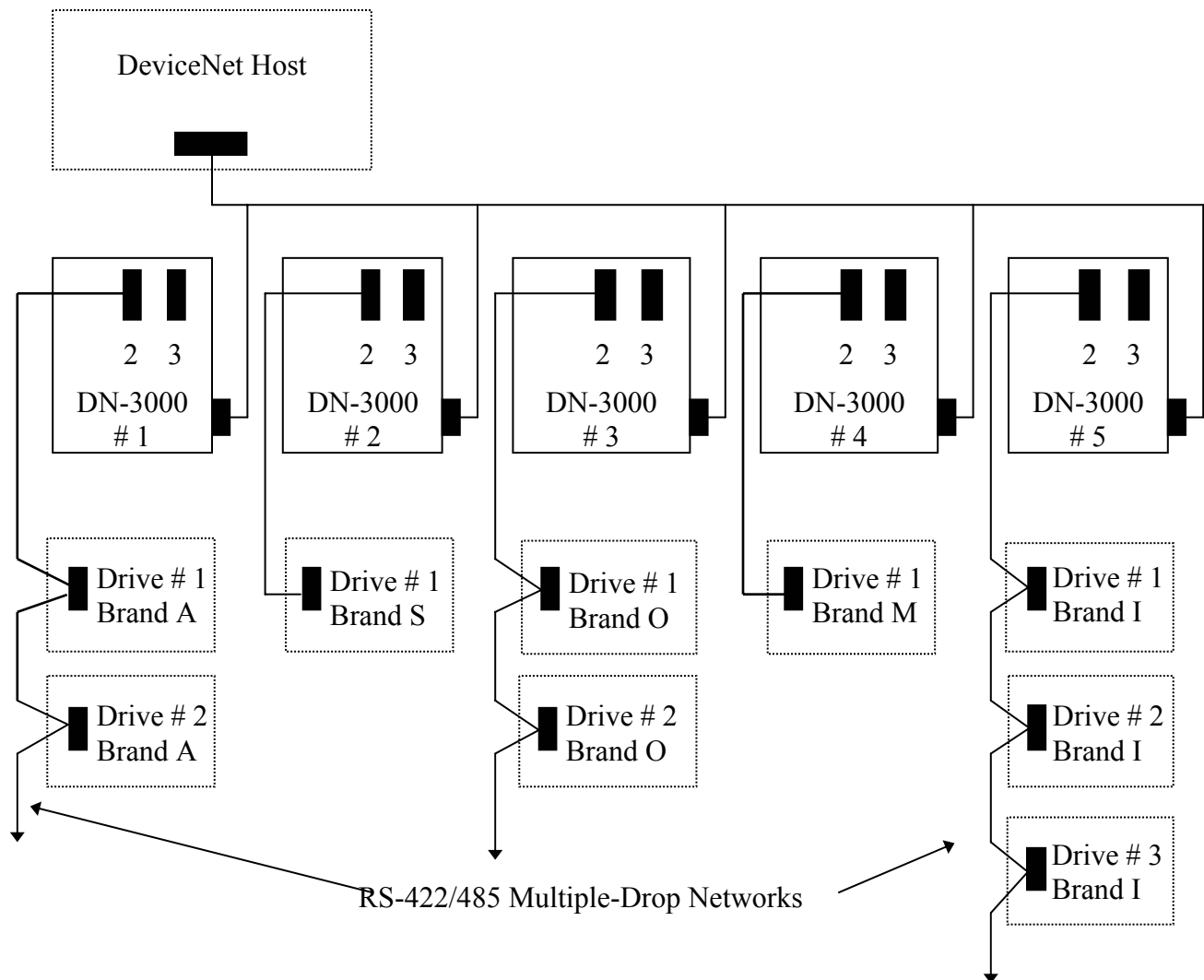

NOTE:

- 1) Each DN-3000 can support up to 32 Motor Drives (if they are network addressable internally).
- 2) The DeviceNet Host can address a maximum of 63 DN-3000 units.
- 3) Multiple Brands of Motor Drives may be addressed by the DeviceNet Host by using multiple DN-3000s, but only one Motor Drive Type may be used on a single DN-3000 unit.
- 4) If multiple DN-3000s are to be used, each DN-3000 must be configured with a unique node address (MAC ID) on the DeviceNet network.

DeviceNet to Motor Drives

CONFIGURING PORT #1, (DEVICENET)

With the highlight bar around the “PROJECT” header use the **RIGHT** arrow key and move the highlight bar to the “EDIT” header. This action will close the “PROJECT” menu and open the “EDIT” menu.

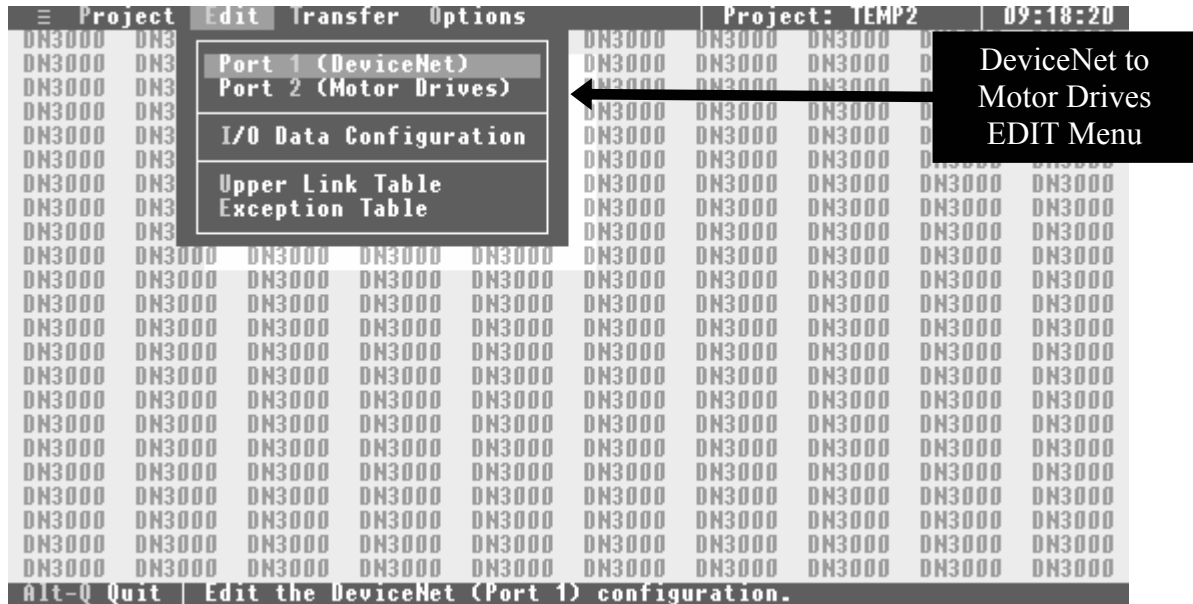

Move the highlight bar to the “Port 1 (DeviceNet)” sub-heading and press the **ENTER** key to open the DeviceNet configuration screen.

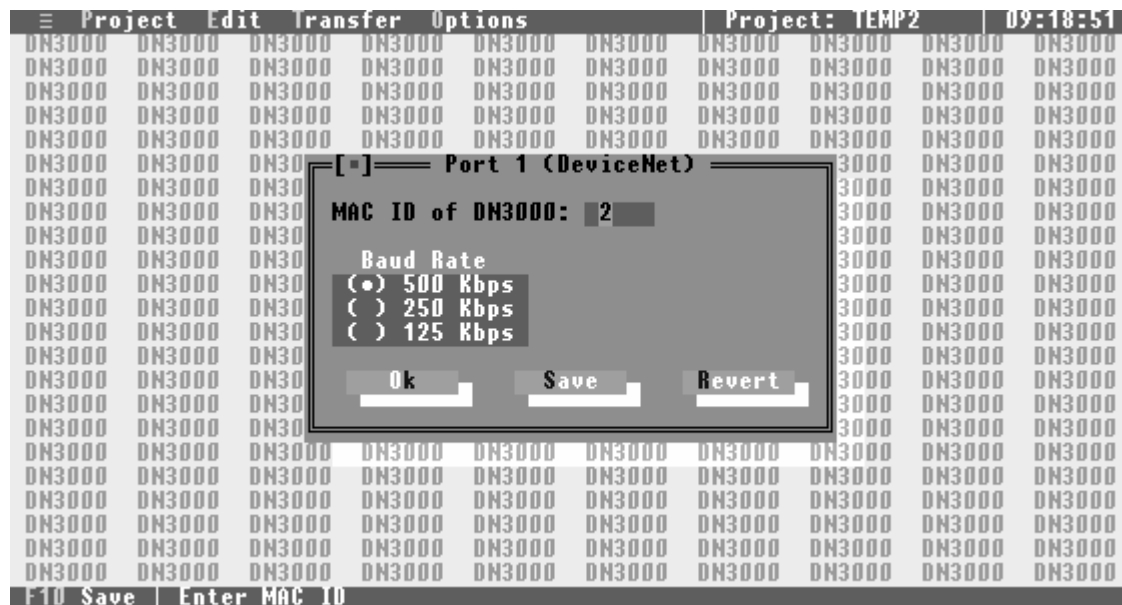

DeviceNet to Motor Drives

MAC ID of DN3000

The MAC ID of the DN-3000 is its node address on a DeviceNet Network. The MAC ID of a DN-3000 can range from 0 to 63. Type the desired value in the field and press **ENTER**.

Baud Rate

Baud Rate determines the rate at which the DN-3000 exchanges data on a DeviceNet network. The Baud Rate setting must be the same for all devices on the DeviceNet network. The DN-3000 supports baud rates of 125, 250 and 500 kbps. The dot between the brackets indicates the current selection. Use the **UP/DOWN** arrow keys and the **SPACEBAR** to select the desired baud rate.

DeviceNet to Motor Drives

CONFIGURING PORT # 2 (MOTOR DRIVES)

Using the **DOWN** arrow key, move the highlight bar to the “**Port 2 (Motor Drives)**” sub-heading (within the “**EDIT**” menu) and press the **ENTER** key. This action opens the Motor Drive selection screen to allow you to select the drive manufacturer and to check all the motor drive’s communications settings.



Motor Drive Type

The Port 2 (Motor Drives) Configuration screen will open with the highlight bar at the “**MOTOR DRIVE TYPE**” selection area. Simply press the **ENTER** key to open the current list of supported motor drives. Use your **UP/DOWN** arrow keys to move through the drive list and place the highlight bar around the drive of your choice, then press the **ENTER** key to enter your selection. The software automatically saves your entry and closes the “**MOTOR DRIVE SELECTION**” window.

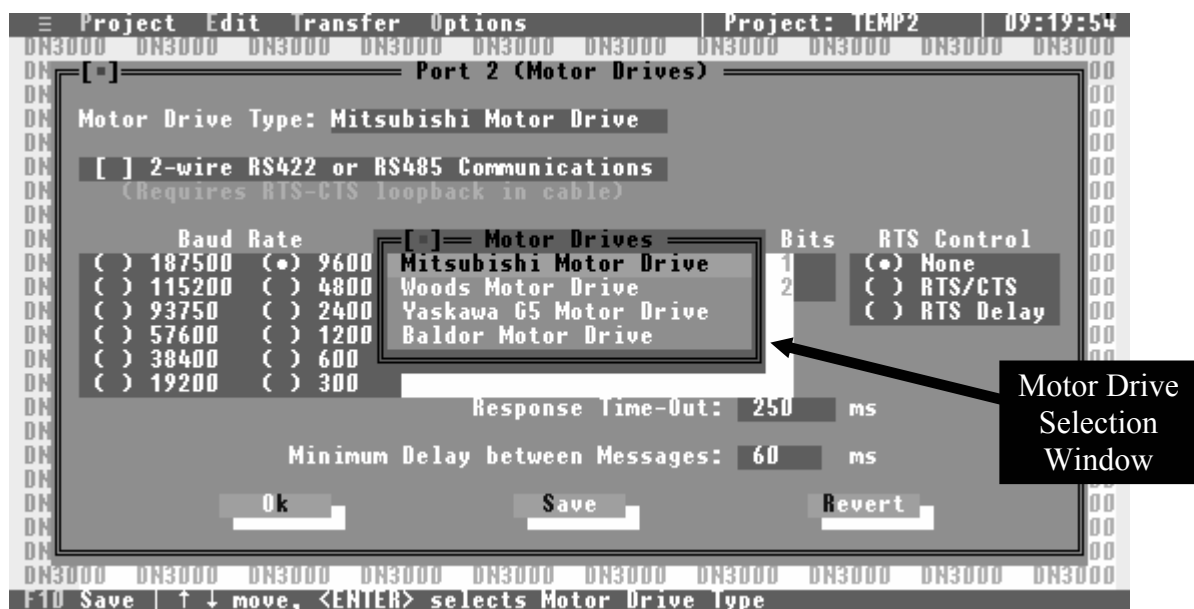

DeviceNet to Motor Drives

2-Wire RS422 or RS485 Communications

This box will only need to be checked if the communications with your Motor Drive is a 2-wire RS485 or RS422 interface. When 2-wire communications are being used, RTS must be looped back to CTS on the DN-3000 side of the cable. This can be done on the RS232 side by looping pins 4 and 5 or on the RS422/485 side by looping 16 to 18 and 17 to 19.

Communications Settings

The communications settings are automatically set to the default values for each type of Motor Drive when the Motor Drive is first selected. Before changing any of these settings, consult your drive manual for the correct settings. To move between the communications settings, press the **TAB** or **ENTER** keys. To select a setting, use the **UP/DOWN** arrow keys to move to the desired setting and press the **SPACE BAR** to enter or change your selection.

RTS Control (Request to Send Control)

RTS Control selection is an option provided for modems or for Motor Drives that require RTS to be active only while the DN-3000 is transmitting to the drive. If **RTS/CTS** is selected, the DN-3000 will activate RTS and wait until CTS is active before transmitting to the drive. If **RTS Delay** is selected, the DN-3000 will activate RTS and wait for the specified delay time to pass before transmitting to the drive.

Response Time-Out

The Response Time-Out tells the DN-3000 how long to wait after transmitting a request to the Motor Drive if no response has been received from the drive. After this amount of time (specified in milliseconds) passes with no response being received, the DN-3000 will assume that no response is coming and will retry the request.

Minimum Delay Between Messages

The Minimum Delay Between Messages is only needed for Motor Drives that get “confused” when consecutive requests are sent too close together. The Mitsubishi Z200 Series of Motor Drives is the only currently known drive that requires this delay (set to 60 ms for Mitsubishi Z200 drives).

Save this information by pressing the **Alt+S** or **F10** function keys. After the **“Information Saved”** window appears, press the **ENTER** key, then the **ESC** key to return to the **“EDIT”** window.

DeviceNet to Motor Drives

I/O DATA CONFIGURATION

Using the **DOWN** arrow key, move the highlight bar to the **"I/O Data Configuration"** sub-heading within the **"EDIT"** menu and press the **ENTER** key. This action opens the I/O Data Configuration setup screen to allow you to set up the I/O data parameters for your project. You should have some idea of how you want your I/O set up before selecting this option.

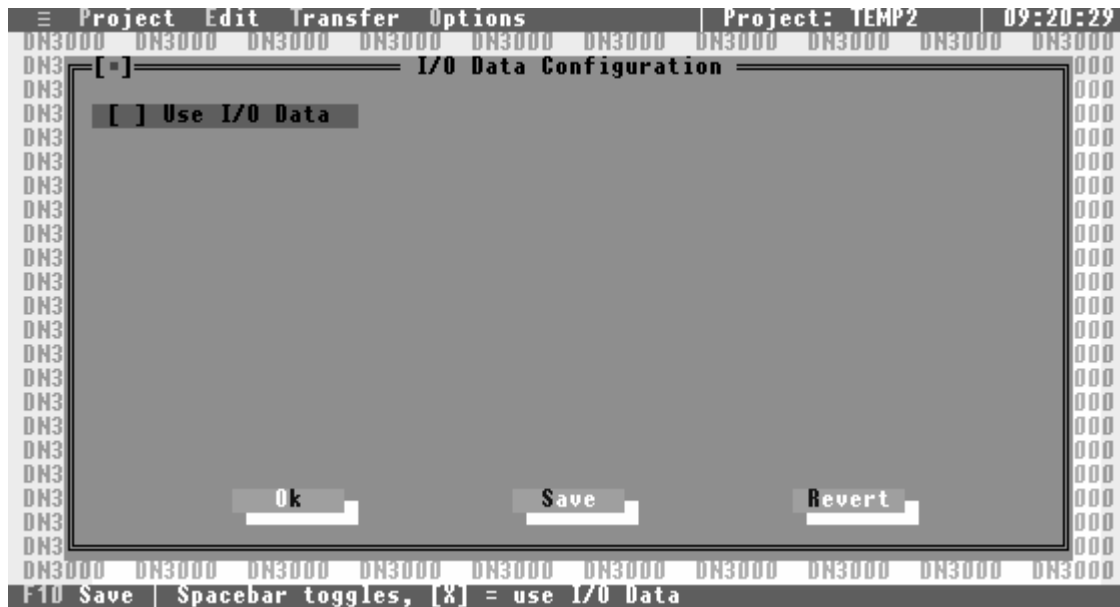

Use I/O Data

If your project requires the use of Polled, Change-Of-State (COS) or Cyclic I/O to be exchanged between the DN-3000 and a DeviceNet host, you should select this option.

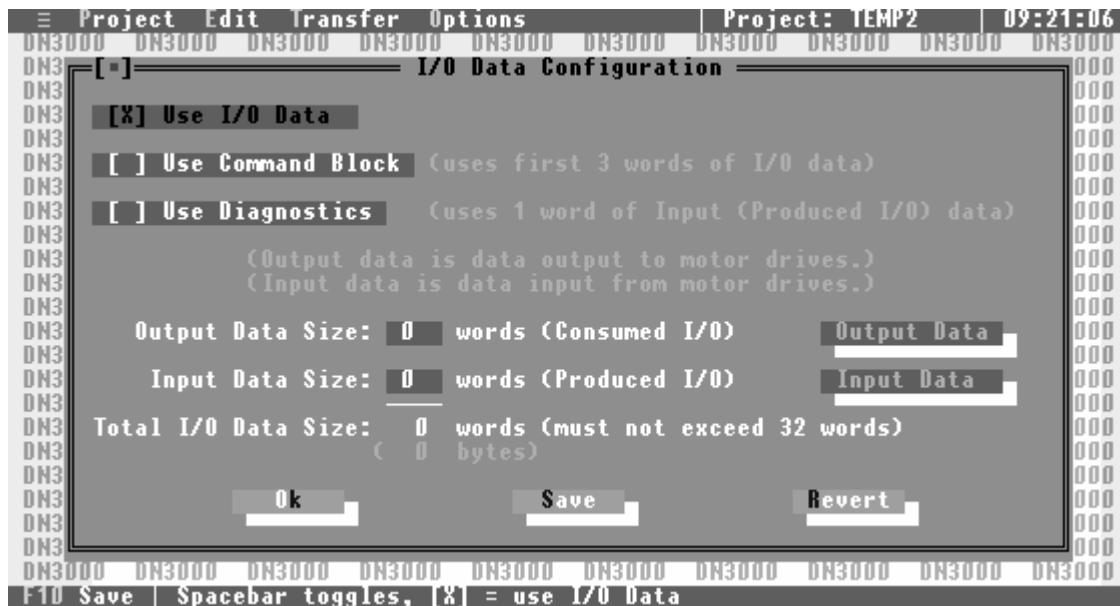

DeviceNet to Motor Drives

The DN-3000 supports up to a total of 64 bytes (32 words) of combined Input and Output data. Each word (2 bytes) of Input or Output data can be configured to exchange data with any one valid parameter in any one of the motor drives connected to port 2 of the DN-3000 (see “**CONFIGURING PORT 2**” for motor drive type and communication parameters).

Use Command Block

In some projects it may be necessary to be able to access more than just the 32 motor drive parameters that can be configured in the Input and Output data. A *Command Block* reserves the first 3 words of Output data for commands, and the first 3 words of Input data for command results. This reduces your total number of words that can be used for parameter data to 26 words, but adds flexibility by allowing your DeviceNet Host to issue commands to the DN-3000 to access *any* valid parameter in any motor drive connected to port 2 of the DN-3000. Commands are issued by moving a command code, motor drive address, parameter number, and data into the first 3 words of the Output data (see “**COMMAND BLOCK**”).

Use Diagnostics

Diagnostics allows the DeviceNet Host to monitor motor drive connections to the DN-3000. The first word of the Input data following the Command Result Block (if any) will be reserved for Diagnostics if this option is selected. The DN-3000 keeps track of the connection status with each motor drive address (0-255). Whenever an attempt to communicate with a motor drive address is successful, the connection status for that address is set to ‘0’. Whenever an attempt to communicate with a motor drive address is unsuccessful, the connection status for that address is set to ‘1’. Of course, returning 256 status bits would require 16 words of Input data (*half* of the available I/O data). Instead, only 16 bits (1 word) of are returned. Each of the 16 bits of the Diagnostics word represents the status of 16 motor drive addresses, as follows: bit 0 represents motor drive addresses 0, 16, 32, 48, 64, etc.; bit 1 represents motor drive addresses 1, 17, 33, 49, 65, etc.; and so forth. If the status of *any* of the motor drive addresses represented by a bit is ‘1’, that bit will contain a ‘1’, otherwise, that bit will contain a ‘0’. Note that the status of a motor drive address is set to ‘1’ *only* if the DN-3000 *attempts* to communicate with that motor drive address *and* that attempt is unsuccessful.

Output Data Size

This determines the number of words of Output data that will be used in your project. Output data is data that is *output* from your DeviceNet Host to the DN-3000 (commands, and parameter data to be written to motor drives). This is also known as the *Consumed I/O Data* of the DN-3000. If a Command Block is used, it will automatically reserve 3 words of Output data. The combined size of the Input and Output data must not exceed 32 words.

Output Data

Pressing the Output Data button brings up a window allowing you to edit the configuration of the Output data in your project. You can press the Output Data button by clicking on it with your mouse, or moving the *focus* to the button with the arrow keys and pressing the **SPACEBAR**. See “**OUTPUT DATA TABLE CONFIGURATION**”.

DeviceNet to Motor Drives

Input Data Size

This determines the number of words of Input data that will be used in your project. Input data is data that is *input* to your DeviceNet Host from the DN-3000 (command results, diagnostics information, and parameter data read from motor drives). This is also known as the *Produced I/O Data* of the DN-3000. If a Command Block is used, it will automatically reserve 3 words of Input data for command results. Similarly, if Diagnostics is used, it will automatically reserve 1 word of Input data. The combined size of Input and Output data must not exceed 32 words.

Input Data

Pressing the Input Data button brings up a window allowing you to edit the configuration of the Input data in your project. You can press the Input Data button by clicking on it with your mouse, or moving the *focus* to the button with the arrow keys and pressing the **SPACEBAR**. See “**INPUT DATA TABLE CONFIGURATION**”.

DeviceNet to Motor Drives

OUTPUT DATA TABLE

Within the “I/O Data Configuration” screen, use the **DOWN** arrow key to move the *focus* to the Output Data button and press the **ENTER** key. This action opens the Output Data Table setup screen to allow you to set up the motor drive parameters to be mapped to each word of Output data.

Output data is data received by the DN-3000 from the DeviceNet Host to be written to motor drive parameters. Each word of Output data (except those reserved for the Command Block) can be mapped to specific motor drive parameters. Output data is only written to motor drive parameters when that data changes.



Use the **UP/DOWN** arrow keys to scroll through the list of Output data words until the highlight bar is over the Output word you wish to edit, and press **ENTER**. A window will open allowing you to edit the Motor Drive Address and Parameter Number mapped to that Output word.

DeviceNet to Motor Drives

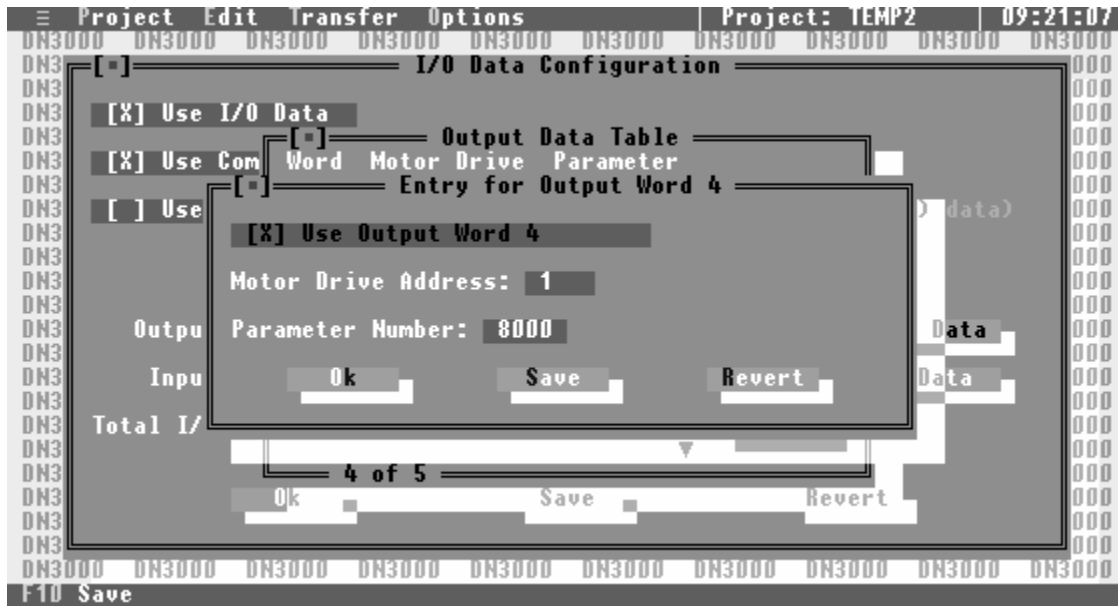

Use Output Word xx

If you want to map this word of Output data to a motor drive parameter, select this option. If this option is not selected, any data appearing in this Output word will be ignored.

Motor Drive Address

This is the Address of the Motor Drive mapped to this word of Output data. The Motor Drive Address must be in the range 0 to 255.

Parameter Number

This is the Parameter Number of the Motor Drive mapped to this word of Output data. Whenever the value in this Output word changes, the DN-3000 will write that value to the motor drive parameter specified by the Motor Drive Address and Parameter Number.

DeviceNet to Motor Drives

INPUT DATA TABLE

Within the “*I/O Data Configuration*” screen, use the **DOWN** arrow key to move the *focus* to the Input Data button and press the **ENTER** key. This action opens the Input Data Table setup screen to allow you to set up the motor drive parameters to be mapped to each word of Input data.

Input data is data read from motor drive parameters and sent from the DN-3000 to the DeviceNet Host. Each word of Input data (except those reserved for the Command Block and Diagnostics) can be mapped to specific motor drive parameters. Mapped motor drive parameters in the Input Data Table are read from the motor drives and placed in the Input data in a round-robin fashion as quickly as the motor drives’ serial communications link allows.



Use the **UP/DOWN** arrow keys to scroll through the list of Input data words until the highlight bar is over the Input word you wish to edit, and press **ENTER**. A window will open allowing you to edit the Motor Drive Address and Parameter Number mapped to that Input word.

DeviceNet to Motor Drives

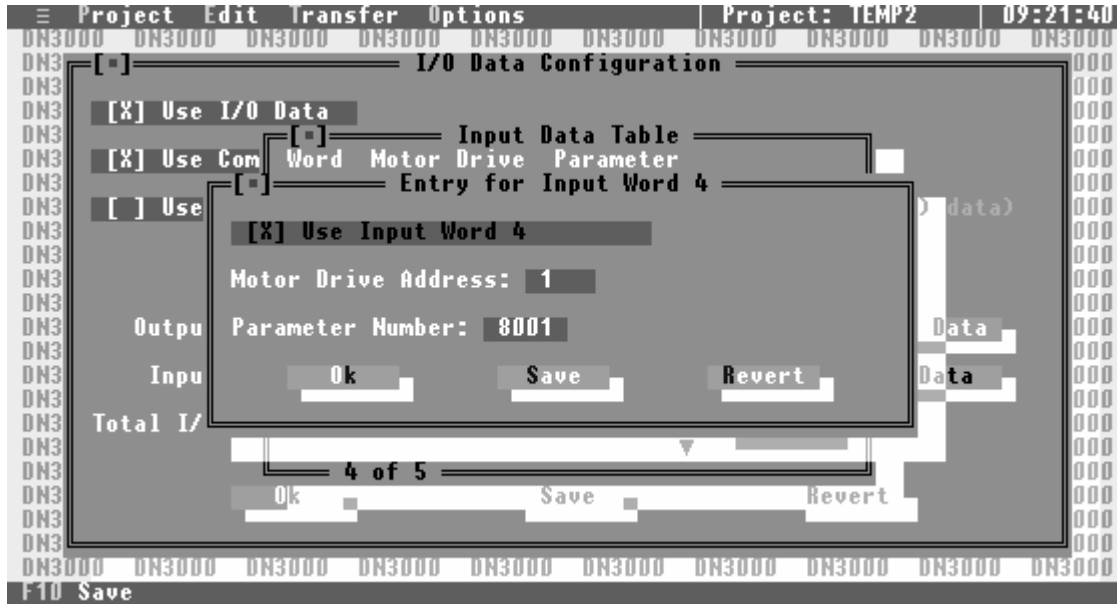

Use Input Word xx

If you want to map this word of Input data to a motor drive parameter, select this option. If this option is not selected, the data in this Input word will be set to 0.

Motor Drive Address

This is the Address of the Motor Drive mapped to this word of Input data. The Motor Drive Address must be in the range 0 to 255.

Parameter Number

This is the Parameter Number of the Motor Drive mapped to this word of Input data. The DN-3000 will read the value of the motor drive parameter specified by the Motor Drive Address and Parameter Number and place that value in this word of the Input data.

DeviceNet to Motor Drives

COMMAND BLOCK

Using I/O data to update and/or monitor motor drive parameters requires very little programming in your DeviceNet Host device – the configuration of the DN-3000 specifies which motor drive parameters are mapped to which words of I/O data. However, you can only access a total of 32 motor drive parameters this way, and those parameters are fixed when the DN-3000 is configured. If your application requires that you access more than 32 motor drive parameters, you must either use multiple DN-3000s, or use a *Command Block*.

A Command Block allows your DeviceNet Host to issue commands at run-time to read or write any valid parameter of any motor drive connected to Port 2 of the DN-3000. The Command Block reserves the first 3 words of Output data for commands issued by the Host, and the first 3 words of Input data for the results of those commands (along with any returned data). Commands are issued by moving a *Motor Drive Address*, *Parameter Number*, any required *Parameter Data* (for write commands only), and a *Command* code into the *Command Block*, as follows:

	15	14	13	12	11	10	9	8	7	6	5	4	3	2	1	0
word 1	Motor Drive Address (0-255)								0	0	0	0	Command			
word 2	Parameter Number															
word 3	Parameter Data (write command only)															

The DN-3000 looks for changes in the *Command Block* data to determine when there is a new request to be processed, “throwing out” any invalid commands received. Valid *Commands* are 1 (read) and 2 (write). To ensure that partial commands are not processed (in systems where it is possible that Output data could be sent by the host before all 4 words of data have been moved into the command block), you should set the *Command* to 0 (indicating no command), then place the data in words 2-3, and only set the *Command* to 1 or 2 after all of the other data is in place. After a command has been processed by the DN-3000, it will “echo” the command in the *Command Result Block* in the Input data, and set the *Result Code* and any *Returned Parameter Data*, as follows:

	15	14	13	12	11	10	9	8	7	6	5	4	3	2	1	0
word 1	Motor Drive Address (0-255)								1	Result Code			Command			
word 2	Parameter Number															
word 3	Returned Parameter Data (read command only)															

If a *read* command (1) was issued, the *Returned Parameter Data* will contain the parameter data read from the specified Motor Drive. If a *write* command (2) was issued, the *Returned Parameter Data* will be the same as for the issued command. The *Result Code* indicates the result of processing the issued command. Valid *Result Codes* are as follows:

Result Code	Meaning
0	Command was completed successfully.
1	DN-3000 could not communicate with indicated motor drive.
2-6	Drive specific error code (see “Application Notes” for motor drive).
7	Command was invalid.

DeviceNet to Motor Drives

UPPER LINK CONFIGURATION (Mitsubishi Drives Only)

The “Upper Link Configuration” screen is only used with Mitsubishi Drives. To open this screen, place the highlighted bar around the “Upper Link Table” sub-heading (within the “EDIT” menu) and press the ENTER key. The Upper Link Table is used to select which drive or drives support Upper Parameter Numbers. If a particular drive supports upper parameters, it must be set in this table to insure proper communications with the motor drive.

To enable the Upper Link for any drive, use the computer’s arrow KEYS to move the highlighted brackets to the desired drive number and press the SPACE BAR. This places an “X” between the brackets. The Upper Link Activity time-out is used by the DN-3000 to ensure the state of the link setting in the drive when it has not had any communications with the drive for a certain period of time.

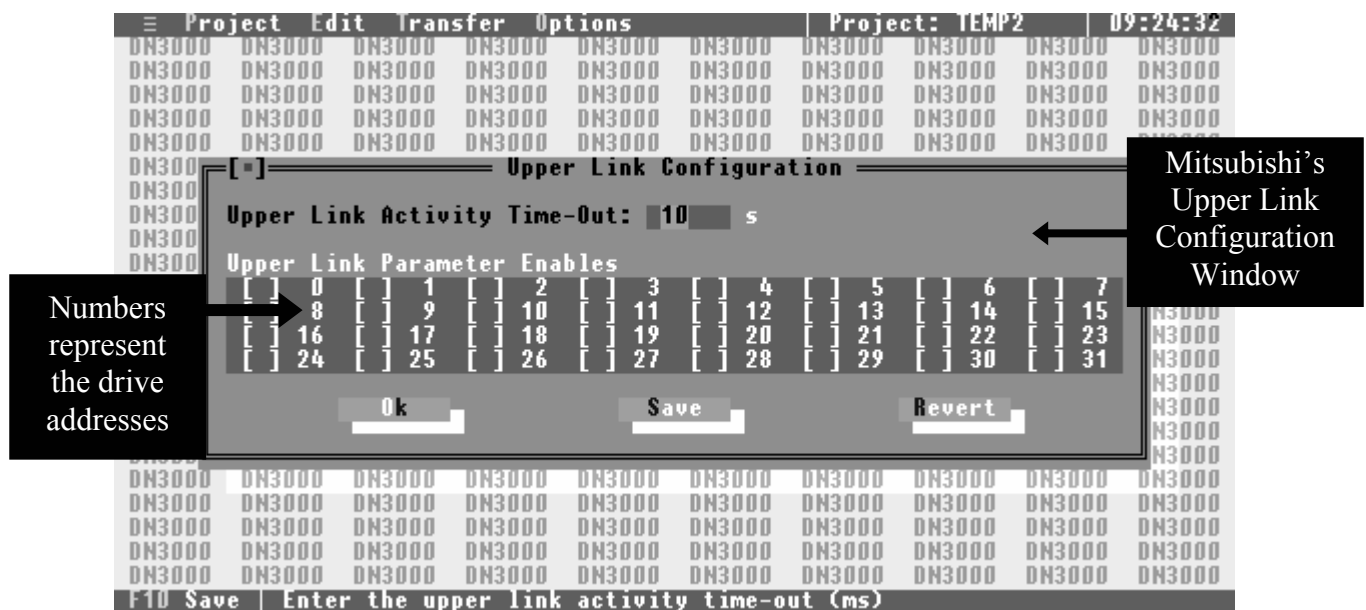

Operation of the Link Switch

When the parameter number 128 or higher is being accessed, the DN-3000 will automatically set the link switch to Upper Parameters if not already set. When parameter number 127 or lower is being accessed, the DN-3000 will automatically set the link switch to Lower Parameters if not already set. If the Upper Link Activity time-out value is reached without any communications activity to a particular drive, the DN-3000 will consider the state of the link switch for that drive to be indeterminate and will set the upper link switch to the appropriate setting for the next parameter that is being accessed regardless of what the previous setting was.

DeviceNet to Motor Drives

EXCEPTION TABLE (Mitsubishi Drives Only)

There are some parameters within Mitsubishi Drives that must be written to the drive as 2-byte ASCII numbers instead of the usual 4-byte ASCII numbers. These parameter numbers need to be entered for each drive that requires these “exceptions” to the usual 4-byte ASCII format. A total of eight (8) exceptions may be entered for each drive.

To enter the exception numbers, move the highlight bar (while in the “EDIT” menu) to the “EXCEPTION TABLE” sub-heading and press the ENTER key. The “EXCEPTION TABLE” screen will open with the highlight bar at motor drive zero (0).

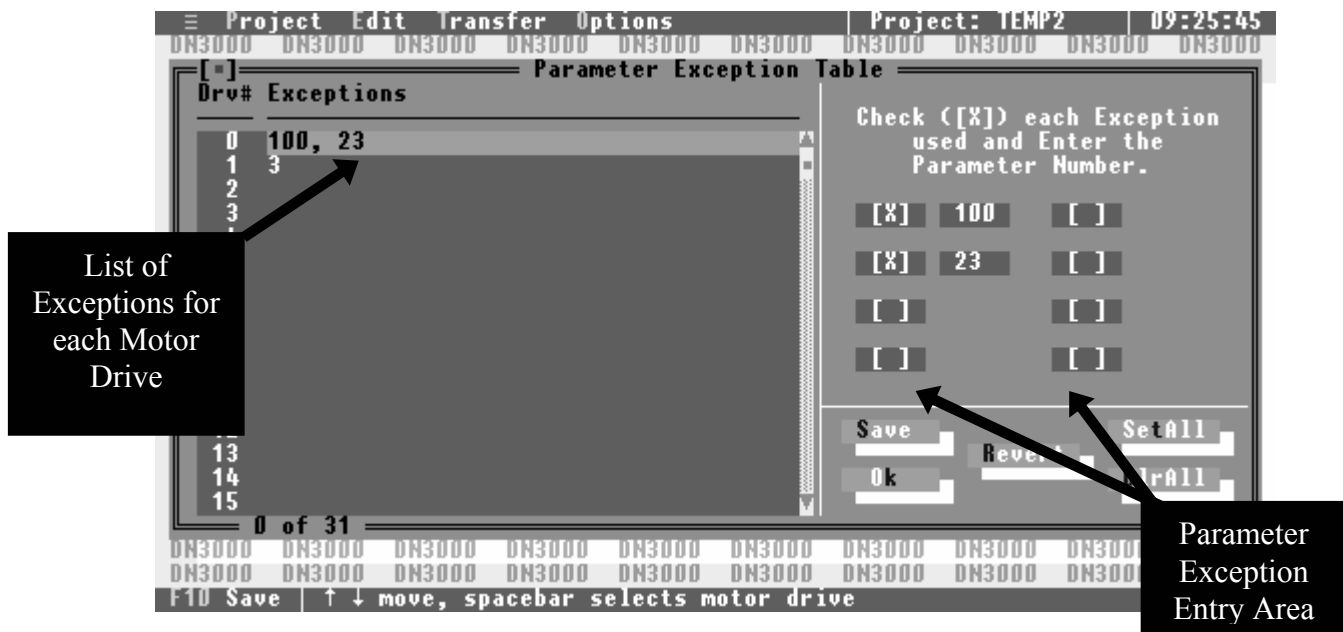

To enter exceptions, press the ENTER, TAB or RIGHT arrow key(s) to move into the Exception Entry Area. Press the SPACE BAR and a “X” will be placed between the brackets of the first exception area and a small shaded area will appear to allow entry of the parameter number. Press the DOWN arrow key and the system will move to the next exception entry area. Repeat all the steps until all exceptions for this drive have been entered, then move the highlight to the “SAVE” button and then press the ENTER key. After the “Information Saved” screen appears, press the ESC key and the highlight returns to the “Drive/Exception List”. Press the DOWN arrow key once and the highlighted bar will move to the second drive in the list. Repeat all the steps to enter exceptions for each drive and then save this information.

NOTE: If all the drives are to have the same exceptions, move the highlight to the “SETALL” button and press the ENTER key. This will allow you to enter the exceptions that will be set for all 32 drives.

Your next step is to transfer this created project file into the DN-3000. Refer to the section “TRANSFERRING PROJECT FILES.”

Transferring Project Files

TRANSFERRING PROJECT FILES

From the “**TRANSFER**” menu you will be able to:

- 1) Transfer (Download) a completed project file to the DN-3000
- 2) Upload a project file from the DN-3000
- 3) Compare a loaded project file within the DN-3000 to a stored project file within the computer.
- 4) Check the current application within the DN-3000

Use the computer’s **RIGHT** arrow key to move the highlight bar to the top “**TRANSFER**” heading and press the **ENTER** key to open the “**TRANSFER**” menu.

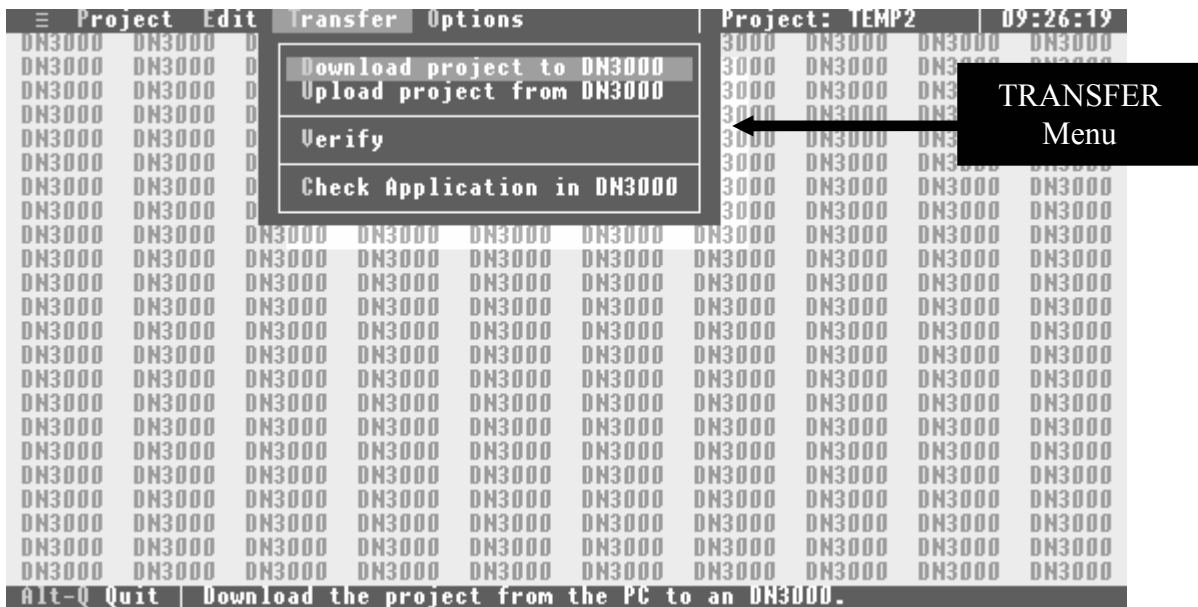

Move the highlight bar (**DOWN** arrow key) to the operation you wish to perform and press the **ENTER** key to begin this function. A message screen will appear as you start the transfer operation and will always appear as a warning screen for any of the four transferring operations:

“Connect Configuration Cable from PC to DN3000, Port 3.”
“Change DN3000 DIP switch to position 3 ON, and the rest OFF.”

Next, check to see the following has been completed before you transfer any files:

- 1) Power is applied to the DN-3000 unit.
- 2) The configuration cable is connected between the computer serial port and port 3 of the DN-3000 unit. (for cable pin-out information see Application Notes.)
- 3) DIP switch number **3** is in the **ON** position and the rest of the switches are in the **OFF** position.

Transferring Project Files

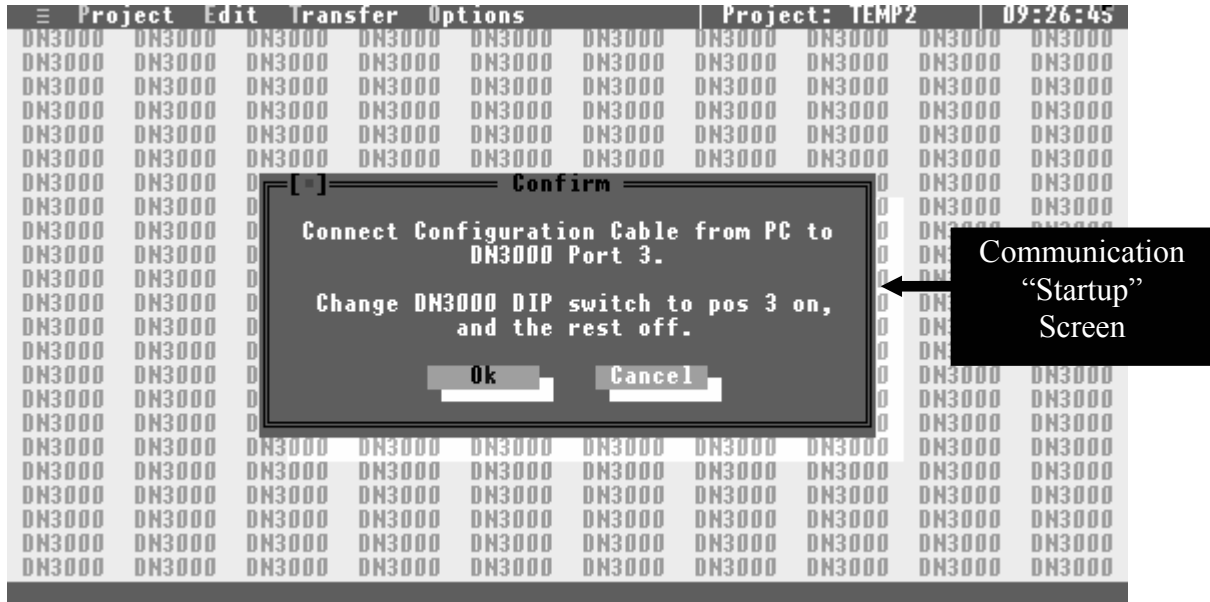

TRANSFER OPTIONS

Download Project to DN3000

Allows you to transfer (download) any created project file from the PC to the DN-3000.

Upload Project from DN3000

Allows you to transfer (upload) the project file stored in the DN-3000 to the PC. The computer will upload the project file under the name "NONAME." You must save this uploaded project file using the "SAVE AS" command from the "PROJECT" window and enter your own file name.

Verify

This feature allows you to verify a project file within your computer against the current project file stored in the DN-3000 unit. After completing the verification process, if the project files are the same, a message will appear stating "Data Verified OK". If the files are different, a message will be displayed stating which part of the project files are different.

Check Application in DN3000

This allows you to check what type of project file is loaded (DeviceNet to PLC, DeviceNet to Motor Drives) and which protocols have been loaded for each of the communication ports.

Options Settings

OPTIONS SETTINGS

Use the **LEFT/RIGHT** arrow keys to highlight the top **“OPTIONS”** heading and press the **ENTER** key. This will open the **“OPTIONS”** menu. From within the **“OPTIONS”** menu you can change the directory where project files are stored, select the PC communications port to use, and set up your printer.

Any changes you make will only be effective while you are operating within this software. When you close the configuration software, all settings for the project directory, communications port and will return to the default, unless you save the new options to Disk.

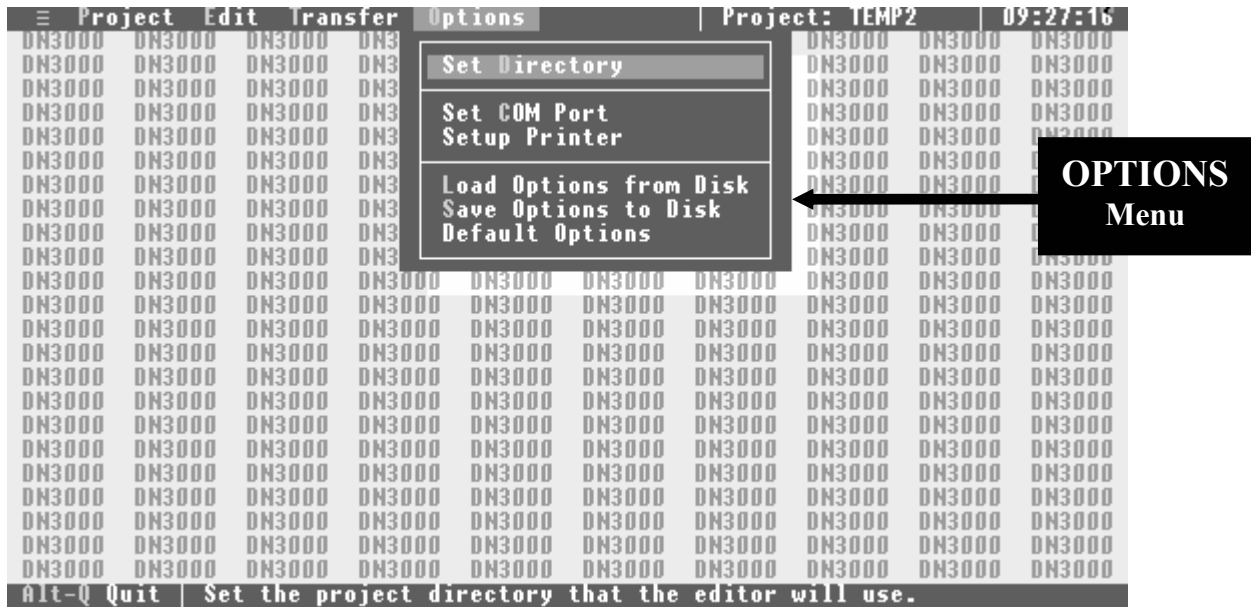

SET DIRECTORY

All saved project files will be stored in the selected **“PROJECT DIRECTORY”**. Changing the directory setting is not usually required unless you wish to group “like” project types in one directory and other “like” project types in another directory.

ADDING A DIRECTORY

Before you save your project file, use the **UP/DOWN** arrow keys to move the highlight bar to the **“Set Directory”** sub-heading, press the **ENTER** key and a directory selection screen (see next page) will appear.

The computer’s cursor will automatically appear at the **“Directory Name.”** Type in your new directory path and press the **ENTER** key. A small window will appear with the following message, **“Directory does not exist, Make the directory?”** Pressing the **ENTER** key creates the new directory and returns you to the **“OPTIONS”** menu.

Options Settings

NOTE: Each time you start the “DN-3000 Configuration Software Program” it defaults (unless you saved the directory information to disk - see “*Save Options to Disk*”) to the “Projects” sub-directory allowing you to open only those files saved within this sub-directory. To access project files saved in a different directory, you will need to use the “*Set Directory*” screen. Only the current directory and sub-directory will be shown. To view all sub-directories, move the highlight bar into the graphic directory area. Place the highlight bar on the configuration software’s main directory (*example:* DN-3000) and press the **ENTER** key. All sub-directories within this main directory will appear. Move the highlight bar to the sub-directory desired and press the **ENTER** key. To enter this change and return to the “*OPTIONS*” menu, tab to the OK box and press **ENTER** or press the **ALT+K** keys.

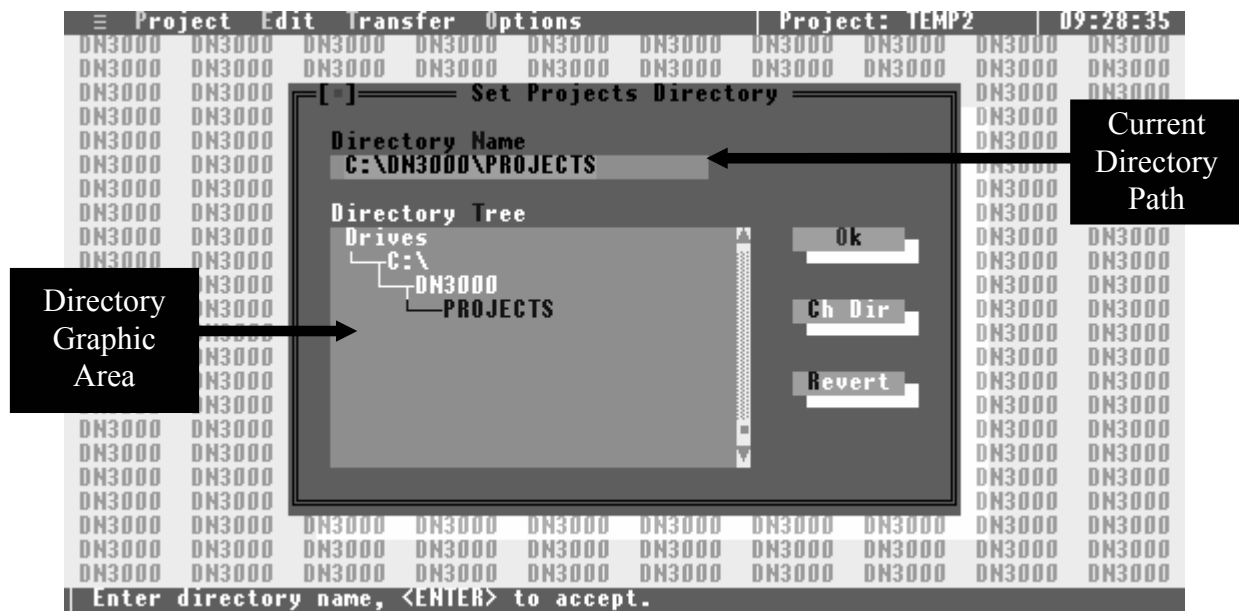

Options Settings

SET COM PORT

To change the communications port (default setting = COM 1) setting, move the highlight bar to the “*Set Com Port*” sub-heading and press the **ENTER** key. When the “*Set Communications Port*” screen appears, use the **LEFT/RIGHT** arrow keys to highlight the communications port desired and then press the **SPACE BAR** to enter this new selection. Press the **ALT+S** (save this entry) and then the **ESC** key to return to the “*OPTIONS*” window.

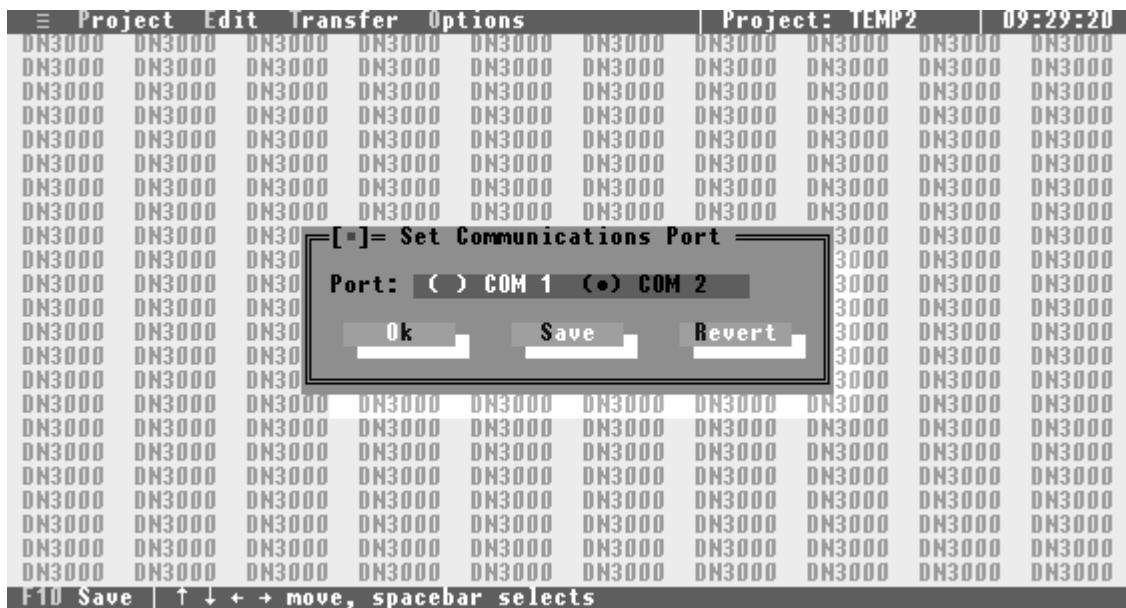

SET PRINTER OPTIONS

To change the printer port (default = LPT 1) setting, move the highlight bar to the “*Setup Printer*” sub-heading and press the **ENTER** key. When the “*Setup Printer*” screen appears (see following page), use the arrow keys to highlight the “*LPTx*” or “*FILE*” setting as required and press the **SPACE BAR** to enter your selection. To print to a file, enter the *drive\directory\file name* and press the **ALT+S** keys (saves this entry) and then the **ESC** key to return to the “*OPTIONS*” menu.

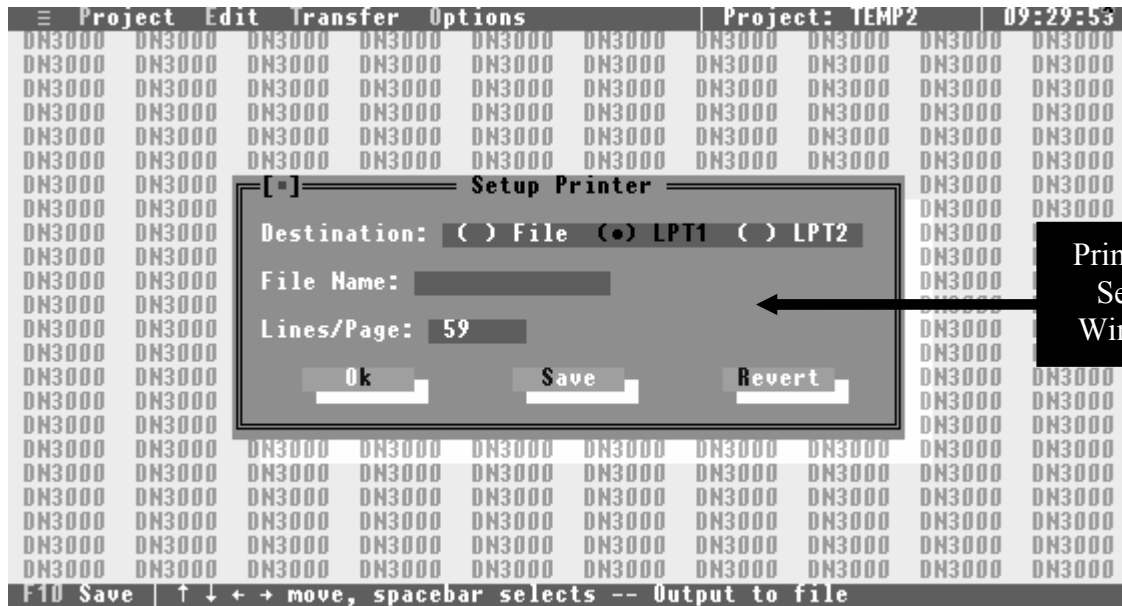

LOAD OPTIONS FROM DISK

The “Load Options from Disk” option will retrieve the options settings that were last saved to disk using “Save Options to Disk”.

SAVE OPTIONS TO DISK

The “Save Options to Disk” option will save all currently selected options settings to disk. The next time the configuration software is loaded, these options will automatically be loaded from disk during startup.

DEFAULT OPTIONS

The “Default Options” option is a quick way to reset all option settings to the original configuration software default settings for directory, communications port and printer options.

Technical Information

POWER REQUIREMENTS

9 - 28 VDC , 7 WATT with optional Earth Ground. A 9 VDC power supply (Part # 4000-0203) is available from Panel-Tec.

PHYSICAL DIMENSIONS

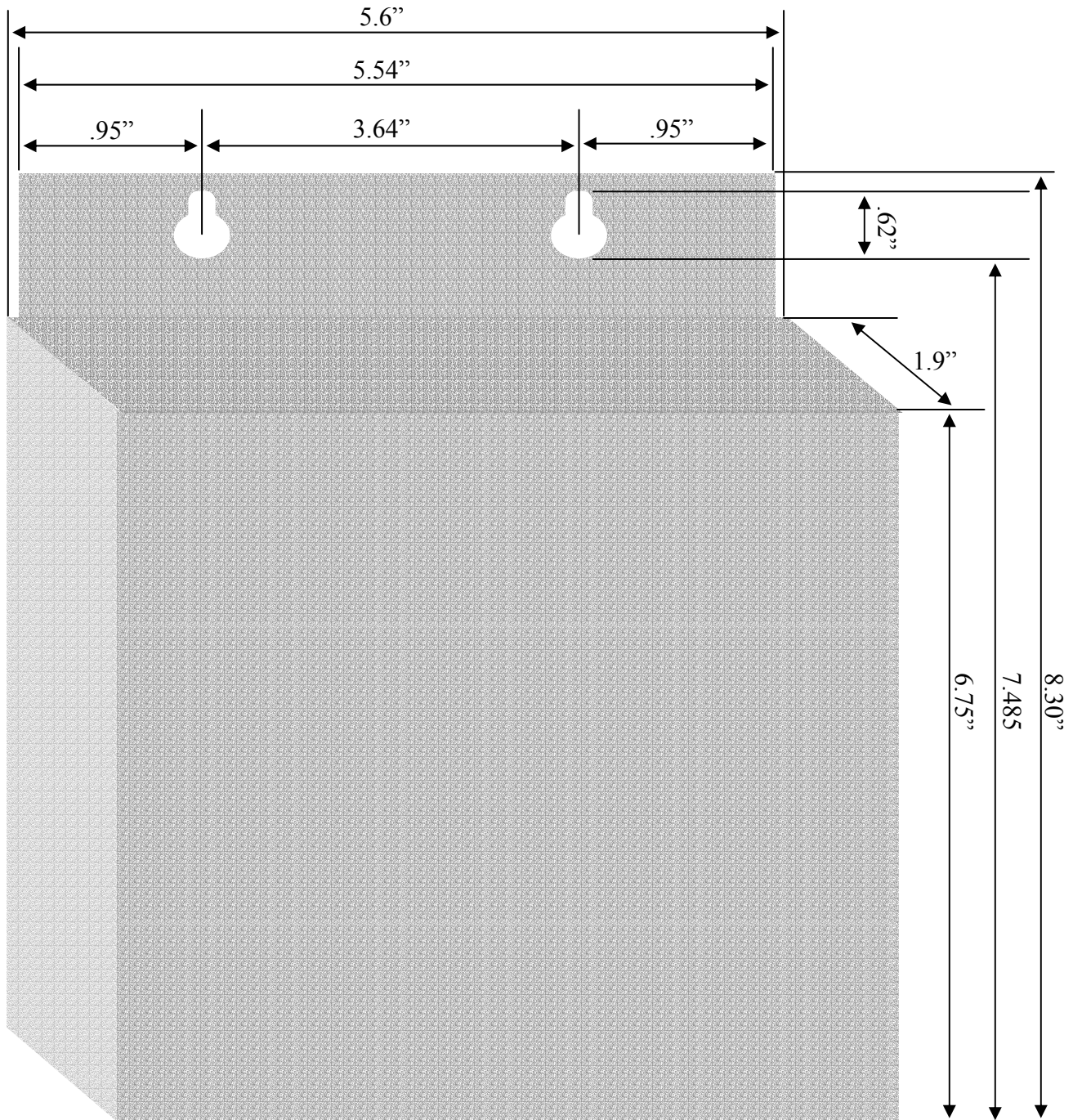

DIP SWITCH SETTINGS

OPERATING MODE	Switch # 1	Switch # 2	Switch # 3	Switch # 4
Normal	Off	Off	Off	Off
Configuration	Off	Off	ON	Off
Diagnostic	ON	ON	Off	Off

VISUAL (LED) INDICATORS

The DN3000 has 5 tri-color LEDs: 2 Communication Port LEDs (Ports 2 and 3), a Status LED and 2 DeviceNet LEDs (Module Status and Network Status). The Module Status and Network Status LEDs are located on the side of the DN-3000, with the Network Status LED closest to the DeviceNet Port. The LEDs change color and go from a steady glow to flashing depending on the current operating mode. The following tables describe the LED indications in the three operating modes: Normal, Configuration and Diagnostic.

NORMAL MODE:

LED	COLOR	MEANING
Communication Port LEDs	Green	Transmitting Data
	Red	Receiving Data
Status LED	Green	DeviceNet Initialized/Ok
	Red	DeviceNet Error
Module Status LED	Off	No Power
	Flashing Green	Device in Standby
	Green	Device Operational
	Flashing Red	Minor Fault
	Red	Unrecoverable Fault
Network Status LED	Flashing Red-Green	Device Self Testing
	Off	Not Powered/Not Online
	Flashing Green	Online, Not Connected
	Green	Link OK, Online, Connected
	Flashing Red	One or more I/O Connections are in the Timed-Out state
	Red	Critical Link Failure (Duplicate Mac ID or Bus-off)
Flashing Red-Green	Device Self Testing	

Technical Information

CONFIGURATION MODE:

LED	COLOR	MEANING
Communication Port # 3 LED	Flashing Red-Green	Communicating with Computer
Status LED	Flashing Green	Configuration Mode

DIAGNOSTIC MODE:

LED	COLOR	MEANING
Communication Port LEDs	Flashing Green	Port is Operational
	Flashing Red or Yellow	Port not Operational or Loopback Connector not Installed
Status LED	Flashing Red	Diagnostics Mode

DN-3000 TROUBLESHOOTING INFORMATION

The DN-3000 performs a self-test each time the unit is powered up or when the Mode Selection DIP Switch is changed. When it detects a failure, it will report the type of failure on the Status LED. All failures are reported as a flash code in which the DN-3000 will flash its Status LED yellow a designated number of times followed by a pause. The flash code will repeat itself until the unit is powered off. The possible errors that can be reported and the recommended actions are:

2 flashes followed by a pause

Random Access Memory Failure (RAM Failure)
Send the unit in for repair (Obtain RMA number first).

3 flashes followed by a pause

Firmware stored in ROM failed checksum test (ROM Failure)
Send the unit in for repair (Obtain RMA number first).

4 flashes followed by a pause

Unit Not Configured or EEPROM failure
If transferring your project file to the DN-3000 does not correct this error, send the unit in for repair (Obtain RMA number first).

5 flashes followed by a pause

Invalid DIP Switch Setting
Verify that the DIP Switch is properly set to a valid operating mode (See DIP Switch Settings in this section). If the DIP Switch is properly set, send the unit in for repair (Obtain RMA number first).

Application Notes – PLCs and Devices

ALLEN-BRADLEY PLC 5, SLC500 AND MICROLOGIX PLCs

Registers Accessed

The DN-3000 will only access registers in Integer files in the PLC memory (N file types). When specifying register numbers in the DN-3000 Configuration Software, the file number is entered into the File Number field and the element number within the file is entered into the Register Number field.

Protocols Supported

The DN-3000 uses the DF1 protocol, which is also known as Full Duplex or Point to Point. It supports both the CRC and BCC methods of error checking.

Please note that the MicroLogix PLC only supports the CRC method of error checking. Therefore, when using a MicroLogix PLC, the protocol selected on the port configuration screen in the DN-3000 Configuration Editor must be “AB SLC500 (CRC)”.

GE FANUC 90/20, 90/30 AND 90/70 PLCs

Registers Accessed

The DN-3000 will only access registers in the Data Register Area of PLC memory (%R1 to %R9999). When entering register numbers, only the offset into this area (1-9999) should be entered. For example, to access register number %R1, the value 1 should be entered. To access register number %R9999, the value 9999 should be entered.

Application Notes – PLCs and Devices

IDEC MICRO-3 PLCs

Registers Accessed

The DN-3000 will only access registers in the Data Register Area of PLC memory (D0 to D9999). When entering register numbers, only the offset into this area (0-9999) should be entered. For example, to access register number D1, the value 1 should be entered. To access register number D9999, the value 9999 should be entered.

Link Adapter Requirement

The DN-3000 requires an Idec Link Adapter or equivalent to be used when communicating with any of the FA Series PLCs.

IDEC FA SERIES PLCs

Registers Accessed

The DN-3000 will only access registers in the Data Register Area of PLC memory (D0 to D9999). When entering register numbers, only the offset into this area (0-9999) should be entered. For example, to access register number D1, the value 1 should be entered. To access register number D9999, the value 9999 should be entered.

Link Adapter Requirement

The DN-3000 requires an Idec Link Adapter or equivalent to be used when communicating with any of the FA Series PLCs.

Application Notes – PLCs and Devices

KOYO / PLC DIRECT 205 SERIES PLCs

Registers Accessed

The DN-3000 can access all register types in the 205 Series PLC through the use of the V-Memory assignments shown in the following table:

V-Memory Address	PLC Registers Accessed
V00000 – V00177	Timer T0 – T177 Current Values
V01000 – V01177	Counter CT0 – CT177 Current Values
V02000 – V03777	Data Words V2000 – V3777
V04000 – V04377	Non-Volatile Data Words V4000 – V4377
V40400 – V40423	Input Points X0 – X477 (16 per V-Memory word)
V40500 – V40523	Output Points Y0 – Y477 (16 per V-Memory word)
V40600 – V40617	Control Relays C0 – C377 (16 per V-Memory word)
V41000 – V41037	Stages S0 – S777 (16 per V-Memory word)
V41100 – V41107	Timer T0 – T177 Status Bits (16 per V-Memory word)
V41140 – V41147	Counter CT0 – CT177 Status Bits (16 per V-Memory word)

Important Note: The V-Memory word numbers in the above table are shown in octal. These numbers must be converted to decimal before they are entered into the DN-3000 Configuration Software. For example, if the DN-3000 is to access register V02000, the value 2000 in octal corresponds to the value 1024 in decimal. The value 1024 is then entered into the DN-3000 Configuration Software.

KOYO / PLC DIRECT / TI 405 SERIES PLCs

Registers Accessed

The DN-3000 can access all register types in the 405 Series PLC through the use of the V-Memory assignments shown in the following table:

V-Memory Address	PLC Registers Accessed
V00000 – V00377	Timer T0 – T377 Current Values
V01000 – V01177	Counter CT0 – CT177 Current Values
V01400 – V07377	Data Words V1400 – V7377
V10000 – V17777	Data Words V10000 – V17777
V40000 – V40077	Remote I/O GX0 – GX1777 (16 per V-Memory word)
V40400 – V40423	Input Points X0 – X477 (16 per V-Memory word)
V40500 – V40523	Output Points Y0 – Y477 (16 per V-Memory word)
V40600 – V40677	Control Relays C0 – C1777 (16 per V-Memory word)
V41000 – V41077	Stages S0 – S1777 (16 per V-Memory word)
V41100 – V41117	Timer T0 – T377 Status Bits (16 per V-Memory word)
V41140 – V41147	Counter CT0 – CT177 Status Bits (16 per V-Memory word)

Application Notes – PLCs and Devices

Important Note: The V-Memory word numbers in the above table are shown in octal. These numbers must be converted to decimal before they are entered into the DN-3000 Configuration Software. For example, if the DN-3000 is to access register V02000, the value 2000 in octal corresponds to the value 1024 in decimal. The value 1024 is then entered into the DN-3000 Configuration Software.

KOYO / PLC DIRECT / TI 305 SERIES PLCs

Registers Accessed

The DN-3000 will only access registers in the Data Area of PLC memory (R400–R577 and R700–R777) which are 8-bit registers. Because the DN-3000 will only read and write 16-bit values, it will use two consecutive 8-bit registers in the 305 Series PLCs to form a 16-bit value. The first of these consecutive registers must be located on an even boundary (i.e. R400, R402, etc.). The low order byte of the 16-bit value is located in the lowest numbered register and the high order byte is located in the highest numbered register.

When entering register numbers into the DN-3000 Configuration Software, they must be converted from octal to decimal. For example, if the DN-3000 is to access register R400 (and R401), the value 400 in octal is converted to the value 256 in decimal. This value of 256 is then entered into the DN-3000 Configuration Software.

Application Notes – PLCs and Devices

MITSUBISHI FX SERIES PLCs

Registers Accessed

The DN-3000 will only access registers in the Data Register Area of PLC memory (D0 to D9999). When entering register numbers, only the offset into this area (0-9999) should be entered. For example, to access register number D1, the value 1 should be entered. To access register number D9999, the value 9999 should be entered.

RTS Control

The Mitsubishi FX-32 and equivalent PLCs require RTS to be active when sending to the PLC and inactive when receiving from the PLC. The DN-3000 can be configured to do so by performing the following steps when configuring the PLC Port in the DN-3000 Configuration Software:

- 1) Select “RTS Delay” in the RTS Control selection box
- 2) Set the RTS Delay time to 2 ms

MODICON PLCs AND MODBUS DEVICES

Registers Accessed

The DN-3000 will only access registers in the Holding Area of PLC memory (40001 to 49999). When entering register numbers, only the offset into this area (1-9999) should be entered. For example, to access register number 40001, the value 1 should be entered. To access register number 49999, the value 9999 should be entered.

OMRON PLCs

Registers Accessed

The DN-3000 will only access registers in the Data Area of PLC memory (DM0 to DM9999). When entering register numbers, only the offset into this area (0-9999) should be entered. For example, to access register number DM1, the value 1 should be entered. To access register number DM9999, the value 9999 should be entered.

PLCs / Protocols Supported

The DN-3000 will communicate with any Omron PLC that uses the Host Link Protocol. On many PLCs, this requires the use of a Host Link Module.

Application Notes – PLCs and Devices

SIEMENS S7-200 PLCs

Registers Accessed

The DN-3000 will only access registers in the V-Memory area of PLC memory (VB0 to VB9999) which are 8-bit registers. Because the DN-3000 will only read and write 16-bit values, it will use two consecutive 8-bit registers in Siemens S7 PLCs to form a 16-bit value. The first of these consecutive registers must be located on an even boundary (i.e. VB0, VB2, etc.). The low order byte of the 16-bit value is located in the lowest numbered register and the high order byte is located in the highest numbered register. These registers can also be accessed in the PLC program or in Charts as 16-bit registers VW0, VW2, VW4, etc.

When entering register numbers, only the offset into the V-Memory area (0-9998) should be entered. For example, to access register number VW0 (VB0 and VB1), the value 0 should be entered. To access register number VW9998 (VB9998 and VB9999), the value 9998 should be entered.

Protocol Information

The DN-3000 follows the Point-to-Point (PPI) protocol specification for token passing masters used with Siemens S7-200 PLCs. It will operate on a PPI network along with other masters.

The fully implemented, multi-master version of the PPI protocol is very slow because of the token passing. Therefore a unique feature has been implemented on the DN-3000 which allows it to run as a single master with no token passing. This feature can only be used when no other masters are present on the PPI network. To activate this feature, enter the value 125 into the DN-3000 Address field on the PLC Port configuration screen in the DN-3000 Configuration Software. Whenever the DN-3000 Address (address which it resides at on the PPI network) is set to 125, it will act as a single master.

Pass-Through Port

For Siemens S7-200 PLCs, there is an additional advantage to the “Pass-Through” port of the DN-3000. It allows a non-token passing master such as a personal computer running Micro/DOS to have access to a multiple-master token passing network without the requirement for an MPI card in the personal computer. This feature can only be used when the DN-3000 Address is not set to 125 (see above).

Application Notes – PLCs and Devices

SQUARE D MODEL 100-700 PLCs

Registers Accessed

The DN-3000 will only access registers in the Data Area of PLC memory (S0 to S9999). When entering register numbers, only the offset into this area (0-9999) should be entered. For example, to access register number S10, the value 10 should be entered. To access register number S999, the value 999 should be entered.

SQUARE D TSX07 PLCs

Registers Accessed

The DN-3000 will only access registers in the Memory Word Area of PLC memory (%MW0 to %MW999). When entering register numbers, only the offset into this area (0-999) should be entered. For example, to access register number %MW0, the value 0 should be entered. To access register number %MW999, the value 999 should be entered.

TI505 SERIES PLCs

Registers Accessed

The DN-3000 will only access registers in the V Area of PLC memory (V1 to V9999). When entering register numbers, only the offset into this area (1-9999) should be entered. For example, to access register number V1, the value 1 should be entered. To access register number V9999, the value 9999 should be entered.

Passthrough Port Note

When using TISOFT PLC programming software on the passthrough port (Port 3) of the DN-3000, the software must be invoked with the following parameters:

p1 T0 0 (for PC COM Port 1) OR
p2 T0 0 (for PC COM Port 2)

For example, if you are using a 545 PLC and you are using COM2 on your PC, you would invoke TISOFT as follows:

TI545 p2 T0 0

These parameters will prevent the programming software from switching over to the Transparent Byte Protocol, which is not supported by the DN-3000.

Application Notes – PLCs and Devices

TOSHIBA EX AND M SERIES PLCs

Registers Accessed

The DN-3000 will only access registers in the Data Register of PLC memory (D0 to D9999). When entering register numbers, only the offset into this area (0-9999) should be entered. For example, to access register number D0, the value 0 should be entered. To access register number D9999, the value 9999 should be entered.

Protocols Supported

The DN-3000 will only communicate with Toshiba EX and M Series PLCs using the Binary Computer Link protocol.

TOSHIBA T SERIES PLCs

Registers Accessed

The DN-3000 will only access registers in the Data Register of PLC memory (D0 to D9999). When entering register numbers, only the offset into this area (0-9999) should be entered. For example, to access register number D0, the value 0 should be entered. To access register number D9999, the value 9999 should be entered.

Protocols Supported

The DN-3000 will only communicate with Toshiba T Series PLCs using the ASCII Computer Link protocol.

WESTINGHOUSE PLCs

Registers Accessed

The DN-3000 will only access registers in the Holding Register of PLC memory (HR1 to HR9999). When entering register numbers, only the offset into this area (1-9999) should be entered. For example, to access register number HR1, the value 1 should be entered. To access register number HR9999, the value 9999 should be entered.

Application Notes – Motor Drives

BALDOR MOTOR DRIVES

Drive Parameter Numbers Assigned By Panel-Tec

ASCII COMMAND	COMMAND DESCRIPTION	READ OR WRITE	PARAMETER NUMBERS
P	Parameter Command	Read/Write	1000-6999 from Baldor Manual
IO	IO Status (J1 or J4)	Read Only	7001 for Terminal Pin 1 Status
IO	IO Status (J1 or J4)	Read Only	7002 for Terminal Pin 2 Status
IO	IO Status (J1 or J4)	Read Only	...
IO	IO Status (J1 or J4)	Read Only	7032 for Terminal Pin 32 Status
O	Report	Read Only	7101 for RPM Value
O	Report	Read Only	7102 for Hz Present Value
O	Report	Read Only	7103 for Motor V(rms)
O	Report	Read Only	7104 for Motor A(rms)
O	Report	Read Only	7105 for % Rated Load
O	Report	Read Only	7106 for Analog Input
O	Report	Read Only	7107 for Opto-Outputs (0-15)
O	Report	Read Only	7108 for Abs Pos from 0 (Low)
O	Report	Read Only	7109 for Abs Pos from 0 (High)
V	Velocity	Read/Write	8000
T	Torque	Read/Write	8001
SC	Security Code	Write Only	8101
W	Position to Zero	Write Only	8501
Z	Set Cursor Pos. to Zero	Write Only	8502
H	Home	Write Only	8503
M	Absolute Move	Read/Write	8504 (Low Order)
M	Absolute Move	Read/Write	8505 (High Order)
m	Incremental Move	Read/Write	8506 (Low Order)
m	Incremental Move	Read/Write	8507 (High Order)
v	Positioning Speed	Read/Write	8508
CALC	Calculate	Write Only	8600
AU	Auto-Tune	Write Only	8601-8609 (for AUI-AU9)
ST	Status	Read Only	9000
E	Enable	Write Only	9001
D	Disable	Write Only	9002
S	Stop	Write Only	9003
F	Return Fault Code	Read Only	9101
C	Clear Fault	Write Only	9102

Note: Parameters 1001-2999 are found in the Baldor Drive Installation & Operating Manual. Parameters 3000-6999 are reserved for additions. Parameters 7000-9999 are assigned by Panel-Tec as shown above.

Application Notes – Motor Drives

Drive Addresses Assigned By Panel-Tec

Drive Number 255 is used to address all motor drives present on a 485 or 422 communications link. This drive address can only be used when writing a parameter or value to the motor drives. This allows for motor drives to be multi-dropped together and a command such as a new velocity to be sent to all drives at the exact same time.

Note: When using Drive Number 255, the same value is sent to all drives as a single Global Broadcast command. Therefore, the number of drives (if using the Command Block or Transfer Table) or the number of registers (if using a Modbus Master) must be set to 1.

Drive Specific Completion Codes (Bits 6 thru 4 of the Result Word)

2 = The DN-3000 obtained an invalid response from drive

Configuring A Baldor Drive For Serial Communications

Before a Baldor Motor Drive can be used for serial communications with the DN-3000, the following steps must be performed:

- 1) The Serial Communication Expansion Board must be installed and configured correctly.
- 2) The DN-3000 must be configured with the same communication options selected on the Dip Switches of the Serial Communication Expansion Board.
- 3) Pins 8, 9, 10, and 17 of Terminal Strip J1 on the Baldor drive must all be jumpered together.
- 4) Using the Baldor keypad, go to the INPUT block title, select OPERATING MODE and change the mode to SERIAL. Press the DISP key and the text SERIAL should appear on the display.

Application Notes – Motor Drives

MITSUBISHI MOTOR DRIVES

Drive Specific Completion Codes (Bits 6 thru 4 of Result Word)

- 2** = Drive Returned a Mode Error
- 3** = Drive Returned an Instruction Code Error
- 4** = Drive Returned a Data Range Error
- 5** = Drive Returned a Communications Error or DN-3000 encountered a Communications Error.
- 6** = Drive Returned an Error Code other than those designated above

WOODS MOTOR DRIVES

Drive Specific Completion Codes (Bits 6 thru 4 of Result Word)

- 5** = The DN-3000 encountered a communications error when receiving the response from the drive.

Configuring A Woods Drive For Serial Communications

- 1)** Parameter number **21** must be set to the value of **16**, **17**, or **18** and parameter number **22** must be set to the value of **3** to be able to control the drive (inverter) with the Woods **SIO** option.
- 2)** Any parameter may be read from the drive (inverter) at any time during operation.
- 3)** Parameter numbers that are less than **30** with the exception of **21** may be written any time during operation.
- 4)** Parameter numbers **30** and above can only be written while the drive (inverter) is in the program mode. To place the drive into the program mode, when the motor is stopped, write the value of **4** to parameter number **22**. When all desired parameters have been changed, the drive should be taken out of the program mode by writing the value of **3** to parameter number **22**.

YASKAWA MOTOR DRIVES

“G5” Drive Specific Completion Codes (Bits 6 thru 4 of Result Word)

- 5** = The DN-3000 encountered a communications error when receiving the response from the drive (Inverter).

DN3000 Configuration Cable (or Pass-Through Port Cable)

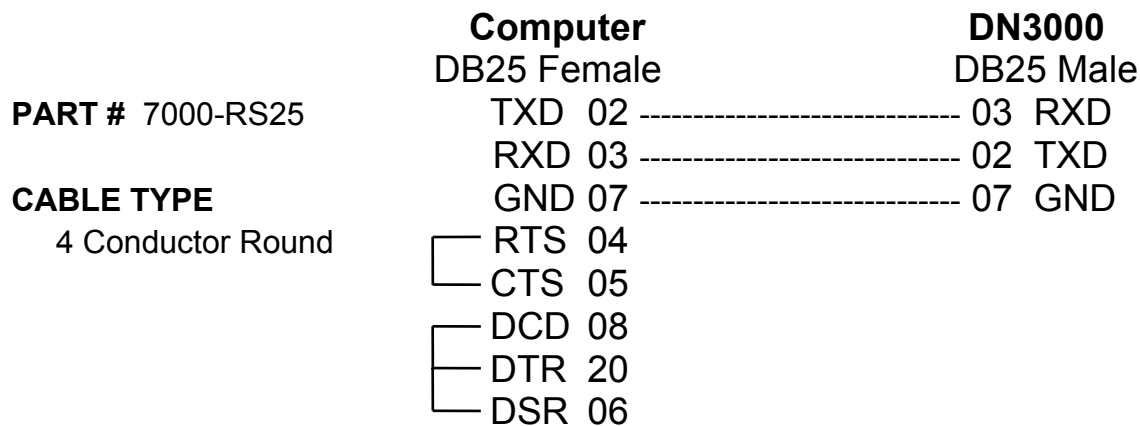
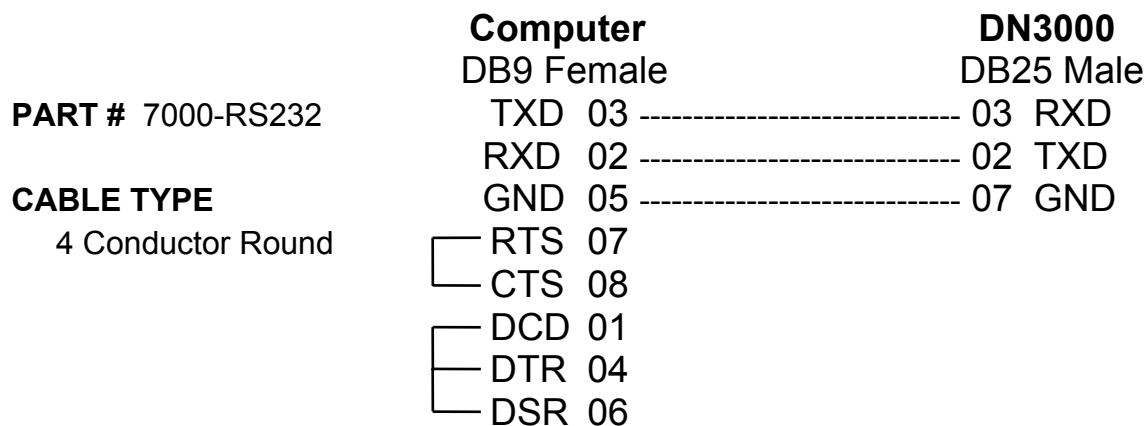

Allen Bradley

PLC MODEL	PLC5	DN3000
PLC5 Channel 0	DB25 Male	DB25 Male
PART # 7000-6004	RXD 03 -----	02 TXD
CABLE TYPE	TXD 02 -----	03 RXD
3 or 4 Conductor Round	GND 07 -----	07 GND
	RTS 04 	
	CTS 05 	

PLC MODEL - SLC5/03 & 04	SLC500	DN3000
PART # 7000-6002	DB9 Female	DB25 Male
CABLE TYPE	RXD 02 -----	02 TXD
4 Conductor Round	TXD 03 -----	03 RXD
	GND05 -----	07 GND

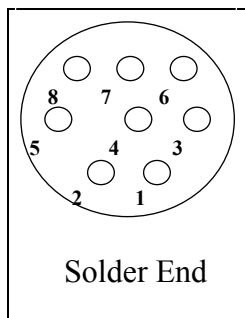

PLC MODEL - MicroLogix	MicroLogix	DN3000
PART # 7000-6003	Mini Din	DB25 Male
CABLE TYPE	RXD 04 -----	02 TXD
4 Conductor Round	TXD 07 -----	03 RXD
	GND 02 -----	07 GND

Cable Diagrams

GE Fanuc 90/20, 30, 70

PLC MODEL	GE Fanuc	DN3000
90/20,30,70	DB15 Male	DB25 Male
PART # 7000-6016	RDB 11 -----	23 TX+
CABLE TYPE	SDB13 -----	24 RX+
4 Conductor Round	RDA 10 -----	21 TX-
	SDA12 -----	22 RX-
	06	
	15	
	08	
	[14	
	[

IDEC

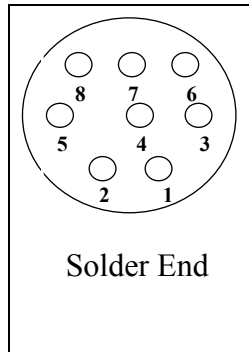

<p>PLC MODEL - Micro-3</p> <p>PART # 7000-6022</p> <p>CABLE TYPE 3 Conductor Round</p>	<p>MICRO-3 Mini Din</p> <p>D+ 01 -----</p> <p>D - 02 -----</p>	<p>DN3000 DB25 Male</p> <p>23 TX+</p> <p>24 RX+</p> <p>21 TX-</p> <p>22 RX -</p> <p>04 RTS</p> <p>05 CTS</p>
-----------------------------------------------------------------------------------------------------------------	---------------------------------------------------------------------------	-------------------------------------------------------------------------------------------------------------------------

<p>PLC MODEL FA with Link Adapter</p> <p>PART # 7000-6023</p> <p>CABLE TYPE 4 Conductor Round</p>	<p>FA Series DB25 Male</p> <p>RXD 03 -----</p> <p>TXD 02 -----</p> <p>GND07 -----</p>	<p>DN3000 DB25 Male</p> <p>02 TXD</p> <p>03 RXD</p> <p>07 GND</p>
--------------------------------------------------------------------------------------------------------------------------------	--------------------------------------------------------------------------------------------------	------------------------------------------------------------------------------

Cable Diagrams

Koyo/PLC Direct

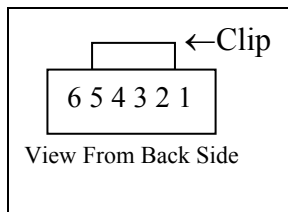

PART # 7000-6031

CABLE TYPE
Round Phone Cable

KOYO 205
RJ11

TXD 04	-----	03 RXD
RXD 03	-----	02 TXD
GND 01	-----	07 GND

DN3000
DB25 Male

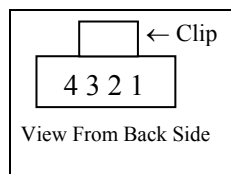

PART # 7000-6032

CABLE TYPE
Round Phone Cable

KOYO 305
RJ04

TXD 02	-----	03 RXD
RXD 01	-----	02 TXD
GND 04	-----	07 GND

DN3000
DB25 Male

PART # 7000-6033

CABLE TYPE
4 Conductor Round

KOYO 405
DB15 Male

	┌01	
	├07	
	└08	
TXD 02	-----	03 RXD
RXD 03	-----	02 TXD
GND -04	-----	07 GND
	-13	
	├14	
	└15	

DN3000
DB25 Male

Mitsubishi FX Series

PLC MODEL - FX	mitsubishi DB25 Male	DN3000 DB25 Male
	RX+ 02 -----	23 TX+
	TX+ 03 -----	24 RX+
PART # 7000-6061	CTS+ 04 -----	18 RTS+
	RX- 15 -----	21 TX-
	TX- 16 -----	22 RX-
CABLE TYPE	CTS- 17 -----	19 RTS-
6 Conductor Round	20	
	21	

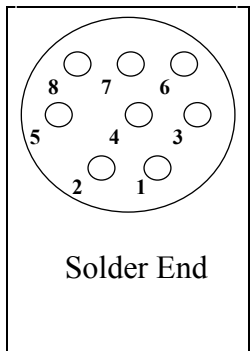

PLC MODEL - FXo/FXon	mitsubishi Mini Din	DN3000 DB25 Male
	RX+ 02 -----	23 TX+
	TX+ 07 -----	24 RX+
PART # 7000-6062	RX - 01 -----	21 TX -
	TX - 04 -----	22 RX -
CABLE TYPE		
6 Conductor Round		

Cable Diagrams

Modicon

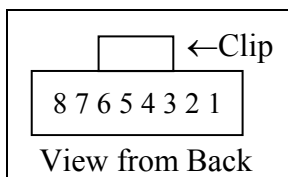

PLC MODEL
Micro 984

PART # 7000-6037

CABLE TYPE
Flat Phone Cable

MODICON
RJ-45

DN3000
DB25 Male

CTS	02	-----	Orange	-----	04	RTS
TXD	03	-----	Black	-----	03	RXD
RXD	04	-----	Red	-----	02	TXD
GND	05	-----	Green	-----	07	GND
	06	-----	Yellow	-----	11	┌
	07	-----	Brown	-----	12	
CGND	08	-----	Gray	-----	01	CGND

PLC MODEL
984 / Compact 984

PART # 7000-6038

CABLE TYPE
3 Conductor Round

MODICON
DB9 Male

DN3000
DB25 Male

TXD	03	-----	03	RXD
RXD	02	-----	02	TXD
GND	05	-----	07	GND
	┌ 07			
	┌ 08			
	┌ 04			
	┌ 06			

Omron

	HOST LINK	DN3000
PLC MODEL	DB25 Male	DB25 Male
232 Host Link	TXD 02 -----	03 RXD
PART # 7000-6043	RXD 03 -----	02 TXD
CABLE TYPE	GND 07 -----	07 GND
4 Conductor Round	RTS 04	
	CTS 05	

	CQM1	DN3000
PLC MODEL	DB9 Male	DB25 Male
CQM1	TXD 02 -----	03 RXD
PART # 7000-6042	RXD 03 -----	02 TXD
CABLE TYPE	GND 09 -----	07 GND
4 Conductor Round		

	C28H	DN3000
PLC MODEL	DB9 Male	DB25 Male
C28H	TXD 02 -----	03 RXD
PART # 7000-6041	RXD 03 -----	02 TXD
CABLE TYPE	GND 07 -----	07 GND
4 Conductor Round		

Cable Diagrams

Siemens S7

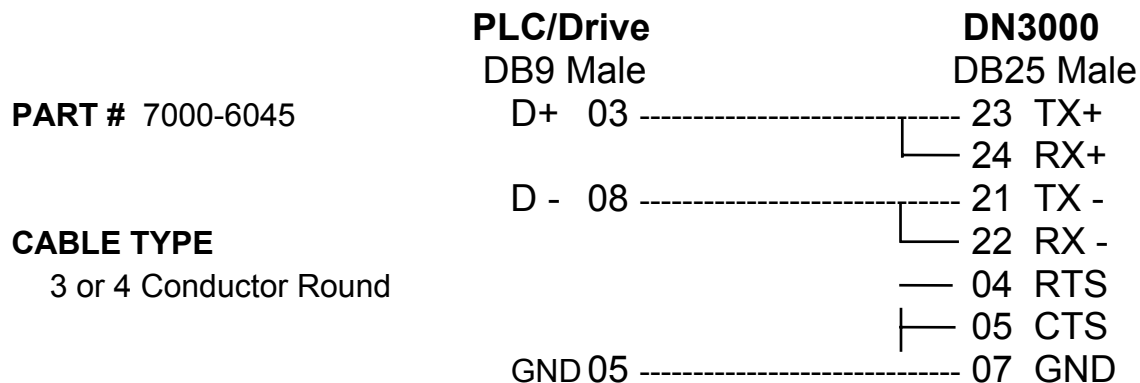

Note: To connect additional PLC's, daisy-chain Pin 3 of each PLC together and daisy-chain Pin 8 of each PLC together before connecting both signals to the DN3000.

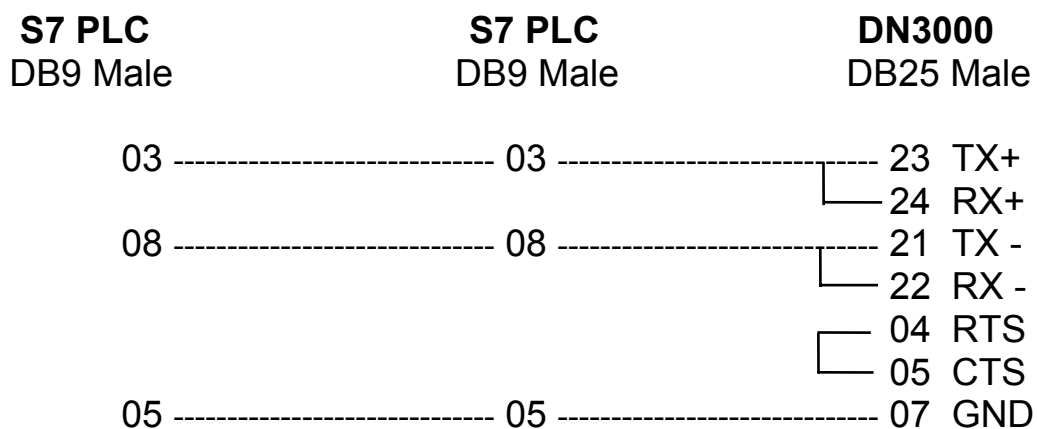

Square D

	Square D DB9 Male	DN3000 DB25 Male
PLC MODEL Models 100-700		
PART # 7000-6052	RX+ 04 -----	23 TX+
	TX+ 02 -----	24 RX+
CABLE TYPE 4 Conductor Round	RX- 03 -----	21 TX-
	TX- 01 -----	22 RX-

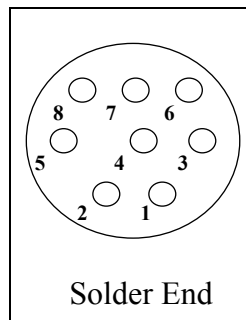

	TSX07 Mini Din	DN3000 DB25 Male
PLC MODEL - TSX07		
PART # 7000-6054	D+ 01 -----	23 TX+
		└─ 24 RX+
CABLE TYPE 3 or 4 Conductor Round	D - 02 -----	21 TX-
		└─ 22 RX-
		└─ 04 RTS
		└─ 05 CTS

Simatic TI5 Series

	TI5 232 Port	DN3000
PLC MODEL	DB9 Female	DB25 Male
TI5 232 Port	TXD 03 -----	03 RXD
	RXD 02 -----	02 TXD
PART # 7000-6047	GND 05 -----	07 GND
	RTS 07	
CABLE TYPE	CTS 08	
4 Conductor Round	DCD 01	
	DTR 04	
	DSR 06	

	TI5 422 Port	DN3000
PLC MODEL	DB9 Male	DB25 Male
TI5 422 Port	TX + 01 -----	24 RX+
	TX - 07 -----	22 RX -
PART # 7000-6048	RX + 05 -----	23 TX +
	RX - 08 -----	21 TX -
CABLE TYPE	GND 06 -----	07 GND
6 Conductor Round		

Toshiba

	Toshiba	DN3000
PLC MODEL	Stripped Wires	DB25 Male
EX & M Series	RXA -----	23 TX+
PART # 7000-6056	TXA -----	24 RX+
CABLE TYPE	RXB -----	21 TX-
4 Conductor Round	TXB -----	22 RX-

	Toshiba	DN3000
PLC MODEL	DB15	DB25 Male
T Series (Computer Link)	RXA 02 -----	23 TX+
	TXA 03 -----	24 RX+
PART # 7000-6057	RXB 10 -----	21 TX-
	TXB 11 -----	22 RX-
CABLE TYPE	□ RTSA 05	
4 Conductor Round	□ CTSA 04	
	□ RTSB 13	
	□ CTSB 12	

Baldor Motor Drives

	BALDOR	DN3000
DRIVE TYPE - 485	Stripped Wires	DB25 Male
PART # 7000-9002	RXB -----	23 TX+
		└ 24 RX+
CABLE TYPE	RXA -----	21 TX-
3 or 4 Conductor Round	GND -----	└ 22 RX -
		07 GND
		└ 04 RTS
		└ 05 CTS

	BALDOR	DN3000
DRIVE TYPE- 232	DB9 Female	DB25 Male
PART # 7000-9001	RXD 02 -----	02 TXD
CABLE TYPE	TXD 03 -----	03 RXD
3 or 4 Conductor Round	GND 05 -----	07 GND

Mitsubishi Motor Drives

	Mitsubishi	DN3000
	Stripped Wires	DB25 Male
PART # 7000-9003	RDIA -----	23 TX+
	SDIA -----	24 RX+
CABLE TYPE	RDIB -----	21 TX-
4 Conductor Round	SDIB -----	22 RX-

Woods Motor Drives

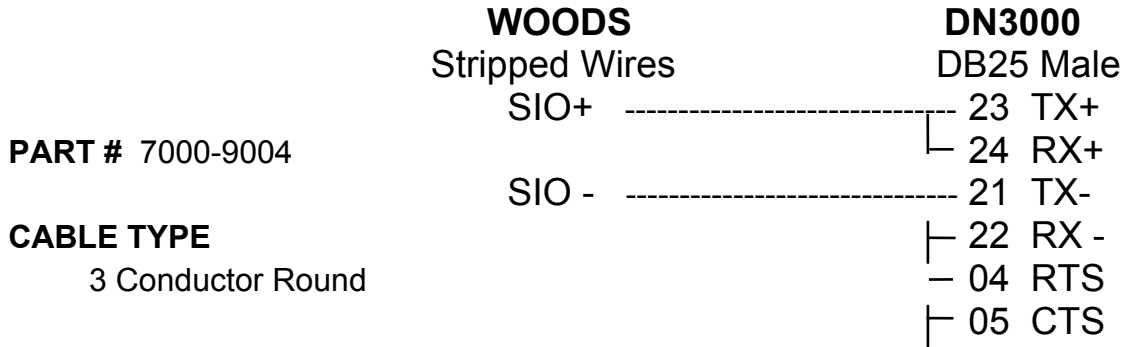

Yaskawa Motor Drives

	G5		DN3000
DRIVE MODEL	Stripped Wires		DB25 Male
G5 Series	1 (+)	-----	23 TX+
			24 RX+
PART # 7000-9005	2 (-)	-----	21 TX-
			22 RX-
CABLE TYPE			04 RTS
2, 3 or 4 Conductor Round			05 CTS

DeviceNet Cable

	DeviceNet	DN3000
	Stripped Wires	DB9 Male
	Black -----	3 V-
	Blue -----	2 CAN_L
PART # 7800-0001	Bare -----	5 Shield
	White -----	7 CAN_H
	Red -----	9 V+

CABLE TYPE

2-twisted pair (blue/white, black/red) w/shield and bare drain wire

The DeviceNet Bus must be powered externally (via a Power Tap). No bus power is provided by the DN3000.

Free Manuals Download Website

<http://myh66.com>

<http://usermanuals.us>

<http://www.somanuals.com>

<http://www.4manuals.cc>

<http://www.manual-lib.com>

<http://www.404manual.com>

<http://www.luxmanual.com>

<http://aubethermostatmanual.com>

Golf course search by state

<http://golfingnear.com>

Email search by domain

<http://emailbydomain.com>

Auto manuals search

<http://auto.somanuals.com>

TV manuals search

<http://tv.somanuals.com>