



PD-Switch

Operation Manual



FCC Radio Frequency Interference Statement

This equipment has been tested and found to comply with the limits for a Class B computing device, pursuant to Part 15 of the FCC Rules. These limits are designed to provide reasonable protection against harmful interference when the equipment is operated in a commercial environment. This equipment generates, uses and can radiate radio frequency energy and, if not installed and used in accordance with the instruction manual, may cause harmful interference to radio communications. Operation of this equipment in a residential area is likely to cause harmful interference in which the user will be required to correct the interference at his own expense.

Any changes or modifications not expressly approved by the manufacturer could void the user's authority to operate the equipment.

The use of non-shielded I/O cables may not guarantee compliance with FCC RFI limits. This digital apparatus does not exceed the Class B limits for radio noise emission from digital apparatus set out in the Radio Interference Regulation of the Canadian Department of Communications.

Le présent appareil numérique n'émet pas de bruits radioélectriques dépassant les limites applicables aux appareils numériques de classe B prescrites dans le Règlement sur le brouillage radioélectrique publié par le ministère des Communications du Canada.

Warranty

IMC Networks warrants to the original end-user purchaser that this product, EXCLUSIVE OF SOFTWARE, shall be free from defects in materials and workmanship under normal and proper use in accordance with IMC Networks' instructions and directions for a period of six (6) years after the original date of purchase. This warranty is subject to the limitations set forth below.

At its option, IMC Networks will repair or replace at no charge the product which proves to be defective within such warranty period. This limited warranty shall not apply if the IMC Networks product has been damaged by unreasonable use, accident, negligence, service or modification by anyone other than an authorized IMC Networks Service Technician or by any other causes unrelated to defective materials or workmanship. Any replaced or repaired products or parts carry a ninety (90) day warranty or the remainder of the initial warranty period, whichever is longer.

To receive in-warranty service, the defective product must be received at IMC Networks no later than the end of the warranty period. The product must be accompanied by proof of purchase, satisfactory to IMC Networks, denoting product serial number and purchase date, a written description of the defect and a Return Merchandise Authorization (RMA) number issued by IMC Networks. No products will be accepted by IMC Networks which do not have an RMA number. For an RMA number, contact IMC Networks at PHONE: (800) 624-1070 (in the U.S and Canada) or (949) 465-3000 or FAX: (949) 465-3020. The end-user shall return the defective product to IMC Networks, freight, customs and handling charges prepaid. End-user agrees to accept all liability for loss of or damages to the returned product during shipment. IMC Networks shall repair or replace the returned product, at its option, and return the repaired or new product to the end-user, freight prepaid, via method to be determined by IMC Networks. IMC Networks shall not be liable for any costs of procurement of substitute goods, loss of profits, or any incidental, consequential, and/or special damages of any kind resulting from a breach of any applicable express or implied warranty, breach of any obligation arising from breach of warranty, or otherwise with respect to the manufacture and sale of any IMC Networks product, whether or not IMC Networks has been advised of the possibility of such loss or damage.

EXCEPT FOR THE EXPRESS WARRANTY SET FORTH ABOVE, IMC NETWORKS MAKES NO OTHER WARRANTIES, WHETHER EXPRESS OR IMPLIED, WITH RESPECT TO THIS IMC NETWORKS PRODUCT, INCLUDING WITHOUT LIMITATION ANY SOFTWARE ASSOCIATED OR INCLUDED. IMC NETWORKS SHALL DISREGARD AND NOT BE BOUND BY ANY REPRESENTATIONS OR WARRANTIES MADE BY ANY OTHER PERSON, INCLUDING EMPLOYEES, DISTRIBUTORS, RESELLERS OR DEALERS OF IMC NETWORKS, WHICH ARE

INCONSISTENT WITH THE WARRANTY SET FORTH ABOVE. ALL IMPLIED WARRANTIES INCLUDING THOSE OF MERCHANTABILITY AND FITNESS FOR A PARTICULAR PURPOSE ARE HEREBY LIMITED TO THE DURATION OF THE EXPRESS WARRANTY STATED ABOVE.

Every reasonable effort has been made to ensure that IMC Networks product manuals and promotional materials accurately describe IMC Networks product specifications and capabilities at the time of publication. However, because of ongoing improvements and updating of IMC Networks products, IMC Networks cannot guarantee the accuracy of printed materials after the date of publication and disclaims liability for changes, errors or omissions.

Table of Contents

FCC Radio Frequency Interference Statement	ii
Warranty.....	ii
About the PD-Switch	1
Installing the PD-Switch	2
Port LEDs.....	3
Applications	5
IMC Networks Technical Support.....	6
Specifications	6
Fiber Optic Cleaning Guidelines.....	7
Electrostatic Discharge Precautions.....	7
Certifications	8

About the PD-Switch

The PD-Switch is an unmanaged Ethernet powered device (IEEE 802.3af) that allows the port density and service area of Ethernet networks to increase. As a powered Layer 2 device, this switch receives power over the Ethernet cable instead of using a separate power outlet, providing Ethernet service to locations without being constrained by the availability of power outlets. The store and forward switch function allows the extension of Ethernet service to locations a total of 200 meters from the Ethernet source. All RJ-45 Ports auto negotiate 10/100BaseT, full/half duplex, and automatically configure for MDI or MDIX operation. The optional Fiber Port is fixed at 100 Mbps full duplex.

The PD-Switch provides a variety of port configurations:

- One IEEE 802.3af PoE compatible RJ-45 port (Port 1 "PD")
- One high-priority RJ-45 port (Port 2)
- And one of the following three configurations:

Configuration 1: Three additional RJ-45 data ports (all copper version)

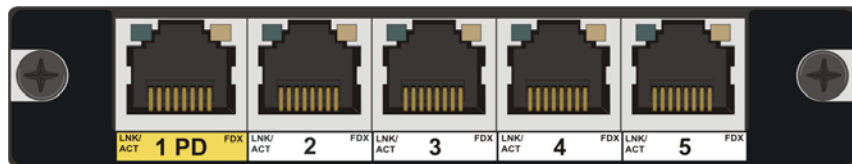

Configuration 2: Two additional RJ-45 data ports and one SFP data port

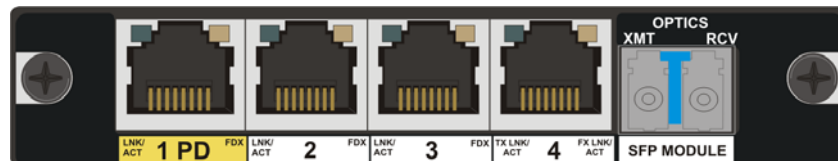

Configuration 3: One additional RJ-45 data port and one Fiber-Optic data port (SFP).

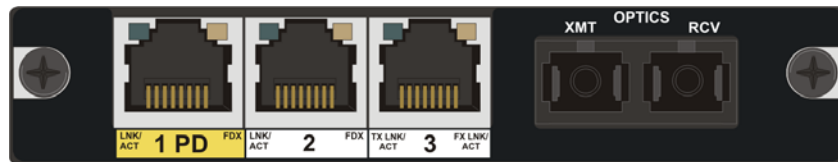

Port 2 is dedicated for high priority applications. All other RJ-45 ports provide fixed DiffServ/ToS-PRI prioritization, giving higher priority to all traffic with a VLAN TAG with PRI>4. All RJ-45 ports incorporate the Auto Cross and Auto Negotiation features. The Fiber-Optic configuration also includes the Far End Fault feature that provides notification of far-end link loss on the fiber port.

Installing the PD-Switch

The PD-Switch is ready to use. Simply connect the appropriate data cables to ports 2 and up. Then connect the powered Ethernet cable to Port 1 (PD).

Wallmount Installation

The PD-Switch includes two X-shaped Wallmount holes in the enclosure. These holes accommodate the use of screws to flushmount the PD-Switch to a wall.

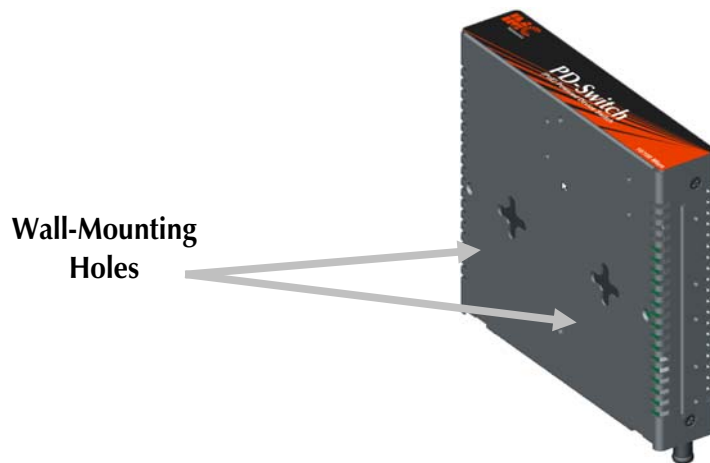

DIN Rail Mounting

The PD-Switch can be mounted with two DIN Rail clips, a hardware option available through IMC Networks. The DIN Rail clips include screws, to allow the installation onto a DIN Rail. Install the screws into DIN Rail clips, which should be mounted perpendicular to the DIN Rail. Snap the converter onto the clips. To remove the converter from the DIN Rail, use a flat-head screwdriver into the slot to gently pry the converter from the rail. The DIN rail clips can be installed either on the bottom of the PD-Switch or on the side.



NOTE

When using the side-installed location, remove the countersunk screw from the enclosure, and then use the vacated hole for one of the DIN clip screws.

Port LEDs

The ports on the PD-Switch include diagnostic LEDs that indicate unique information about the port functionality and status.

PD-Switch-TX/5

For all units with 5 copper ports, the two LEDs associated with each twisted pair port are defined as follows:

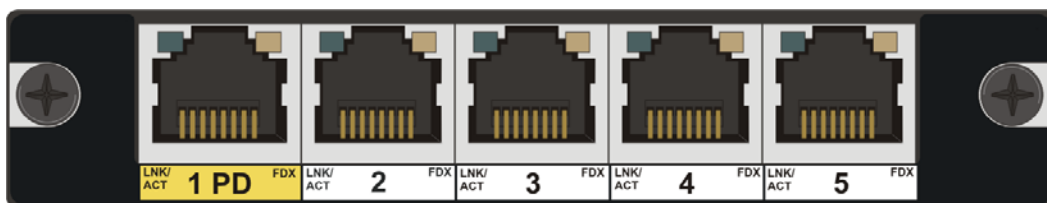

Port	LED Name	Color	Function
TX	LNK/ACT	OFF	No link signal detected on copper port
		GREEN	Glow green when a twisted pair link is established
		Flash GREEN	Activity is detected on the port
	FDX	OFF	Port is operating in Half Duplex
		AMBER	Port is operating in Full Duplex

PD-Switch-TX/3+FX

On units with a 1x9 fiber port, the FDX LED of port 3 has been re-defined as the “FX-LNK/ACT” LED for the fiber port. Note that the “LNK” LED requires a valid Link signal and no Far-End-Fault (FEF) from the fiber line.

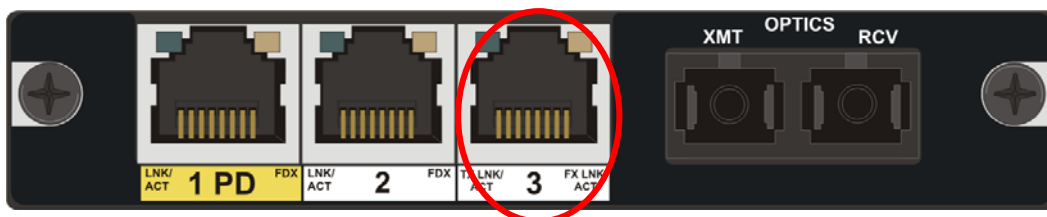

Port	LED Name	Color	Function
1X9	LNK/ACT	OFF	FEF or no link signal detected on FX port
		AMBER	Glow amber when the fiber link is established
		Flash AMBER	Activity is detected on the port

PD-Switch-TX/4+SFP

On units with an SFP transceiver at Port 5, the FDX LED of port 4 has been re-defined as the “FX-LNK/ACT” LED for the fiber port.

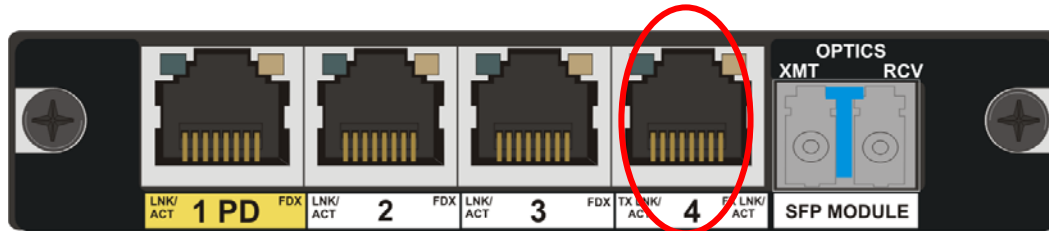

Port	LED Name	Color	Function
SFP	LNK/ACT	OFF	FEF or no link signal detected on SFP port
		AMBER	Glowes amber when the SFP port link is established
		Flash AMBER	Activity is detected on the port

Applications

In the following example, PD-Switches have been connected to a central (PoE) PSE-Switch, extending the range of the network and increasing port density.

One PD-Switch uses the standard four RJ-45 ports to connect to the network, while the other two use the fiber and SFP configurations to extend the network beyond the 200m range.

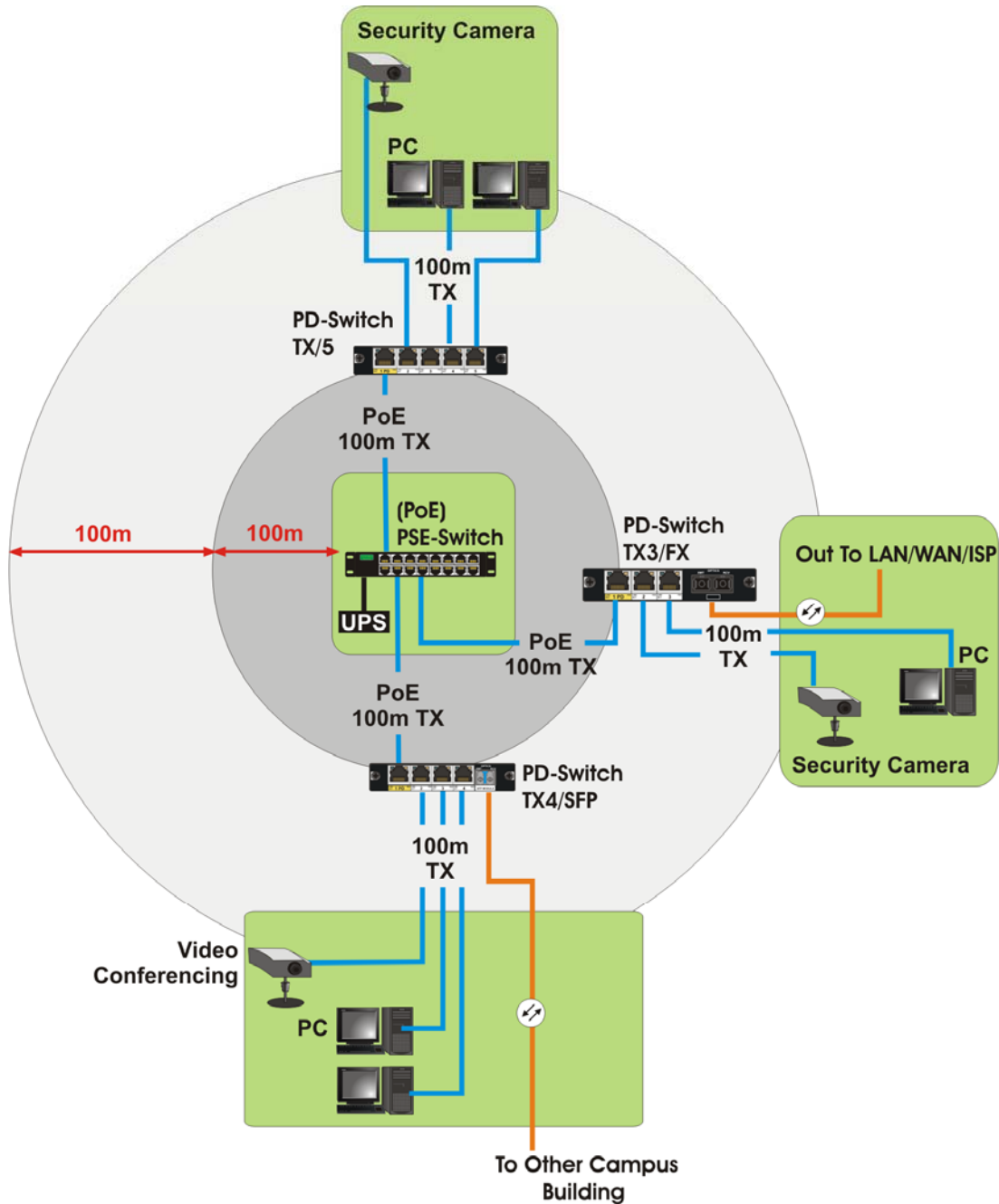

NOTE

This product must be connected to PoE networks and is not intended for connection to outside plant installations.

IMC Networks Technical Support

Tel: (949) 465-3000 or (800) 624-1070 (in the U.S. and Canada);
+32-16-550880 (Europe)

Fax: (949) 465-3020

E-Mail: techsupport@imcnetworks.com

Web: www.imcnetworks.com

Specifications

Key Features

- Broadcast Storm Protection (limited to 1% of total traffic)
- High Priority weighted queuing (10:1) to prevent port blocking
- Auto MDI/MDIX
- Flow Control on all copper ports
- Far End Fault indication on fiber ports
- 1000 MAC address learning bridge with 5 minute aging
- DiffServ/ToS and PRI aware
- Non Blocking full bandwidth Layer 2 switching core
- MAX frame size of 1916 bytes
- High priority port (2)

Industry Standards

IEEE 802.3af compliant power over Ethernet (PoE)

IEEE 802.3x Ethernet Standards

IEEE 802.3u Auto Negotiations Standards

RFC-2474 and RFC-2475 DiffServ QoS

Input Specifications

36 to 50 VDC @ 56-40mA

Operating Temperature

+32°F to +122°F (0°C to +50°C)

Storage Temperature:

-31°F to +158°F (-35°C to +70°C)

Humidity

5 to 90% (non-condensing); 0 to 10,000 ft. altitude

Dimensions

H=0.91" W=4.30" D=4.00" (2.3 x 10.9 x 10.2 cm)

Fiber Optic Cleaning Guidelines

Fiber Optic transmitters and receivers are extremely susceptible to contamination by particles of dirt or dust, which can obstruct the optic path and cause performance degradation. Good system performance requires clean optics and connector ferrules.

1. Use fiber patch cords (or connectors, if you terminate your own fiber) only from a reputable supplier; low-quality components can cause many hard-to-diagnose problems in an installation.
2. Dust caps are installed at IMC Networks to ensure factory-clean optical devices. These protective caps should not be removed until the moment of connecting the fiber cable to the device. Should it be necessary to disconnect the fiber device, reinstall the protective dust caps.
3. Store spare caps in a dust-free environment such as a sealed plastic bag or box so that when reinstalled they do not introduce any contamination to the optics.
4. If you suspect that the optics have been contaminated, alternate between blasting with clean, dry, compressed air and flushing with methanol to remove particles of dirt.

Electrostatic Discharge Precautions

Electrostatic discharge (ESD) can cause damage to any product, add-in modules or stand alone units, containing electronic components. Always observe the following precautions when installing or handling these kinds of products

1. Do not remove unit from its protective packaging until ready to install.
2. Wear an ESD wrist grounding strap before handling any module or component. If the wrist strap is not available, maintain grounded contact with the system unit throughout any procedure requiring ESD protection.
3. Hold the units by the edges; do not touch the electronic components or gold connectors.
4. After removal, always place the boards on a grounded, static-free surface, ESD pad or in a proper ESD bag. Do not slide the modules or stand alone units over any surface.



WARNING! Integrated circuits and fiber optic components are extremely susceptible to electrostatic discharge damage. Do not handle these components directly unless you are a qualified service technician and use tools and techniques that conform to accepted industry practices.

Safety Certifications

UL/CUL: Listed to Safety of Information Technology Equipment, including Electrical Business Equipment.

CE: The products described herein comply with the Council Directive on Electromagnetic Compatibility (2004/108/EC) and the Council Directive on Electrical Equipment Designed for use within Certain Voltage Limits (2006/95/EC). Certified to Safety of Information Technology Equipment, Including Electrical Business Equipment. For further details, contact IMC Networks.



**Class 1 Laser product, Luokan 1 Laserlaite,
Laser Klasse 1, Appareil A' Laser de Classe 1**

European Directive 2002/96/EC (WEEE) requires that any equipment that bears this symbol on product or packaging must not be disposed of with unsorted municipal waste. This symbol indicates that the equipment should be disposed of separately from regular household waste. It is the consumer's responsibility to dispose of this and all equipment so marked through designated collection facilities appointed by government or local authorities. Following these steps through proper disposal and recycling will help prevent potential negative consequences to the environment and human health. For more detailed information about proper disposal, please contact local authorities, waste disposal services, or the point of purchase for this equipment.





19772 Pauling • Foothill Ranch, CA 92610-2611 USA
TEL: (949) 465-3000 • FAX: (949) 465-3020
www.imcnetworks.com

**ISO 9001:2008
REGISTERED**



© 2010 IMC Networks. All rights reserved.

The information in this document is subject to change without notice. IMC Networks assumes no responsibility for any errors that may appear in this document. PD-Switch is a trademark of IMC Networks. Other brands or product names may be trademarks and are the property of their respective companies.

Document Number 52-80440-00 A5

November 2010

Free Manuals Download Website

<http://myh66.com>

<http://usermanuals.us>

<http://www.somanuals.com>

<http://www.4manuals.cc>

<http://www.manual-lib.com>

<http://www.404manual.com>

<http://www.luxmanual.com>

<http://aubethermostatmanual.com>

Golf course search by state

<http://golfingnear.com>

Email search by domain

<http://emailbydomain.com>

Auto manuals search

<http://auto.somanuals.com>

TV manuals search

<http://tv.somanuals.com>