



INSTRUCTION MANUAL

VHF FM REPEATER

IC-FR5100

UHF FM REPEATER

IC-FR6100



Icom Inc.

IMPORTANT

READ THIS INSTRUCTION MANUAL CAREFULLY before attempting to operate the repeater.

SAVE THIS INSTRUCTION MANUAL— This manual contains important safety and operating instructions for the IC-FR5100/IC-FR6100 VHF/UHF FM REPEATERS.

PRECAUTIONS

⚠ **WARNING HIGH VOLTAGE! NEVER** attach an antenna or internal antenna connector during transmission. This may result in an electrical shock or burn.

⚠ **WARNING HIGH VOLTAGE! NEVER** install the antenna at any place that person touch the antenna easily during transmission. This may result in an electrical shock or burn.

⚠ **WARNING! NEVER** apply AC to the DC power receptacle on the repeater rear panel. This could cause a fire or damage the repeater.

⚠ **WARNING! NEVER** apply more than 16 V DC, such as a 24 V battery, to the DC power receptacle on the repeater rear panel. This could cause a fire or damage the repeater.

⚠ **CAUTION! NEVER** let metal, wire or other objects touch any internal part or connectors on the rear panel of the repeater. This may result in an electric shock.

⚠ **CAUTION! NEVER** expose the repeater to rain, snow or any liquids.

DO NOT use or place the repeater in areas with temperatures below -25°C or above $+55^{\circ}\text{C}$. Be aware that temperatures can exceed $+80^{\circ}\text{C}$, resulting in permanent damage to the repeater if left there for extended periods.

DO NOT place the repeater in excessively dusty environments or in direct sunlight.

DO NOT put anything on top of the repeater. This will obstruct heat dissipation.

EXPLICIT DEFINITIONS

WORD	DEFINITION
⚠ WARNING	Personal injury, fire hazard or electric shock may occur.
CAUTION	Equipment damage may occur.
NOTE	If disregarded, inconvenience only. No risk of personal injury, fire or electric shock.

Place the repeater in a secure place to avoid inadvertent use by children.

BE CAREFUL! The heatsink will become hot when operating the repeater continuously for long periods.

BE CAREFUL! If a linear amplifier is connected, set the repeater's RF output power to less than the linear amplifier's maximum input level, otherwise, the linear amplifier will be damaged.

Use Icom microphones only (optional). Other manufacturer's microphones have different pin assignments, and connection to the repeater may damage the repeater.

Icom optional equipment is designed for optimal performance when used with this repeater. We are not responsible for the repeater being damaged or any accident caused when using non-Icom optional equipment.

Icom, Icom Inc. and the  logo are registered trademarks of Icom Incorporated (Japan) in the United States, the United Kingdom, Germany, France, Spain, Russia and/or other countries.

FORWARD

Thank you for purchasing this Icom repeater. The IC-FR5100/IC-FR6100 VHF/UHF FM REPEATERS is designed and built with Icom's state of the art technology and craftsmanship. With proper care, this product should provide you with years of trouble-free operation.

We want to take a couple of moments of your time to thank you for making the IC-FR5100/IC-FR6100 your repeater of choice, and hope you agree with Icom's philosophy of "technology first." Many hours of research and development went into the design of your IC-FR5100/IC-FR6100.

◆ FEATURES

○ Up to 2 channels operation

You can install a channel extension module (optional UR-FR5100/UR-FR6100) into a repeater. 2 channels can be operated as the repeater when a channel extension module is installed.

○ Built-in 5-Tone, DTMF encoder & decoder

Multiple signaling systems are equipped as standard. These systems are fully compatible with Icom F-series radios.

○ DTMF remote control capability

You can control the repeater from a remote location over the air or over a phone line with DTMF.

○ D-Sub 25 pin ACC port equipped

You can use the optional equipment via the D-sub 25 pin ACC port equipped on the repeater's rear panel.

○ Other features

- Wide frequency coverage
(136 to 174 MHz, 400 to 470 MHz)
- PC programmable
- 19 inch rack mount
- Optional Voice Scrambler Unit (UT-109R/UT-110R) for base operating mode

VOICE CODING TECHNOLOGY

The AMBE+2™ voice coding Technology embodied in this product is protected by intellectual property rights including patent rights, copyrights and trade secrets of Digital Voice Systems, Inc. This voice coding Technology is licensed solely for use within this Communications Equipment. The user of this Technology is explicitly prohibited from attempting to extract, remove, decompile, reverse engineer, or disassemble the Object Code, or in any other way convert the Object Code into a human-readable form. U.S. Patent Nos. #5,870,405, #5,826,222, #5,754,974, #5,701,390, #5,715,365, #5,649,050, #5,630,011, #5,581,656, #5,517,511, #5,491,772, #5,247,579, #5,226,084 and #5,195,166.

SUPPLIED ACCESSORIES

The following accessories are supplied.

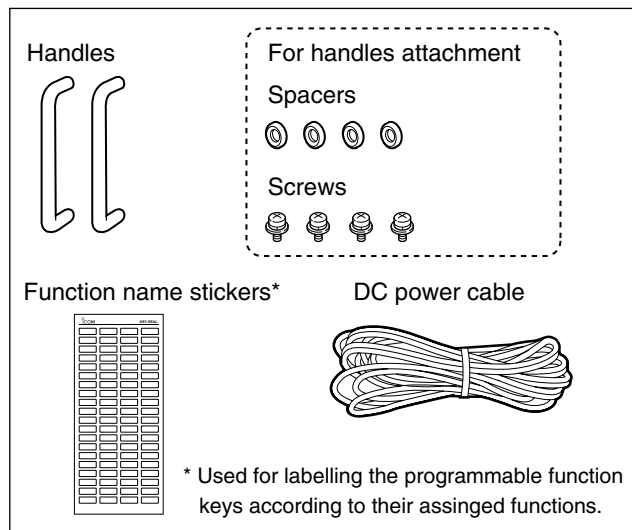
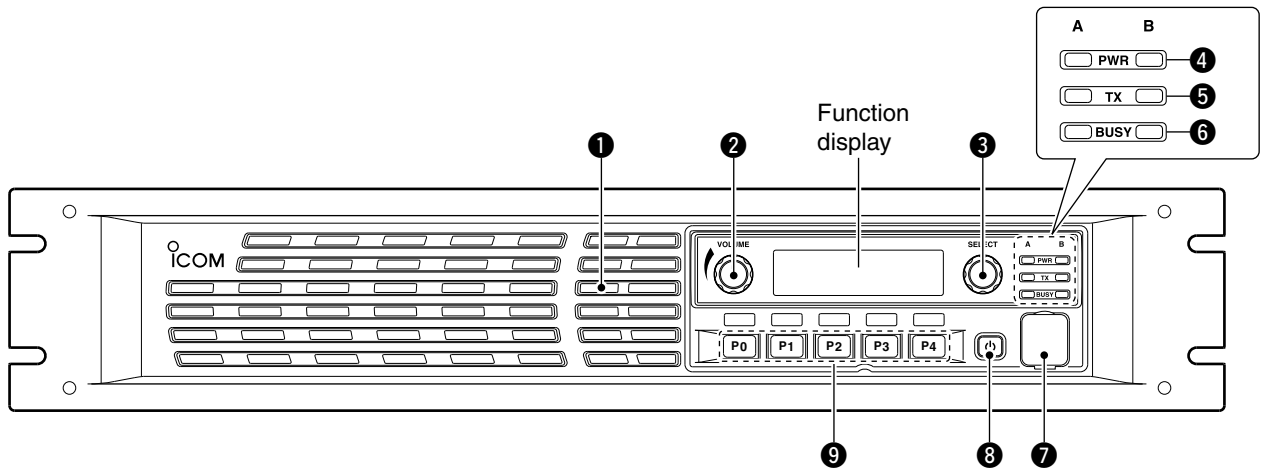

TABLE OF CONTENTS

IMPORTANT.....	i
EXPLICIT DEFINITIONS.....	i
PRECAUTIONS.....	i
FORWARD	ii
VOICE CODING TECHNOLOGY	ii
SUPPLIED ACCESSORIES.....	ii
TABLE OF CONTENTS	ii
1 PANEL DESCRIPTION.....	1-3
■ Front panel	1
◇ Function display	2
■ Rear panel.....	2
◇ Accessory connector	3
2 INSTALLATION AND CONNECTIONS.....	4-6
■ Unpacking	4
■ Selecting a location	4
■ Antenna connection	4
■ Front panel connection.....	5
■ Rear panel connection	5
■ Power supply connection	6
■ Mounting the repeater	6
◇ Using the supplied handle.....	6
3 OPERATION	7
■ Receiving and transmitting	7
◇ Repeater operation	7
◇ Base station operation	7
4 MAINTENANCE	8
■ Troubleshooting	8
■ Fuse replacement	8
◇ Line fuse replacement.....	8
5 OPTIONS.....	9
6 ABOUT CE	10-12

Front panel



1 INTERNAL SPEAKER

Monitors received signals.

2 VOLUME CONTROL [VOLUME] (p. 7)

Adjusts the audio output level.

3 SELECTOR DIAL [SELECT]

Rotate to adjust the squelch threshold level, select the operating channel. (Depending on the pre-programmed condition.)

4 POWER INDICATOR [POWER]

➔ Lights green at 'A' module's indicator while the repeater power is turned ON.

When a channel extension module is installed:

➔ Lights green at the selected module indicator ('A' or 'B') while the repeater power is turned ON.

➔ Lights orange at the un-selected module indicator ('A' or 'B') while the repeater power is turned ON.

5 TRANSMIT INDICATOR [TX]

Lights red while transmitting.

6 BUSY INDICATOR [BUSY]

Lights green while receiving a signal or when the noise squelch is open.

About [PWR], [TX] and [BUSY] indicators:

'A' and 'B' modules indicators are available for these indications. 'A' module's indicator correspond to the original module, and 'B' module's indicator correspond to an extended module.

7 MICROPHONE CONNECTOR [MIC]

This 8-pin modular jack accepts the optional microphone.

KEEP the [MIC] connector cover attached to the repeater when the optional microphone is not used.

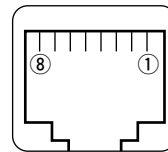

- ① +8 V DC output (Max. 15 mA)
- ② Output port for PC programming
- ③ NC
- ④ M PTT (Input port for TX control)
- ⑤ Microphone ground
- ⑥ Microphone input
- ⑦ Ground
- ⑧ Input port for PC programming

8 POWER SWITCH [POWER]

➔ Push to turn the repeater power ON.

➔ Push and hold for 3 sec. to turn the repeater power OFF.

When a channel extension module is installed:

➔ While the repeater power is turned ON, push to select the desired module to operate the repeater as the base station.

- The power indicator of the selected module unit lights green.

9 DEALER-PROGRAMMABLE KEYS

Desired functions can be programmed independently by your dealer.

Ask your dealer for details.

- Because these keys are programmable, the functions of these keys are unique to each unit.

◇ Function display

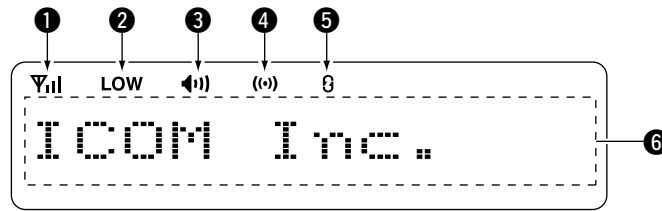

❶ SIGNAL STRENGTH INDICATOR

Indicates relative signal strength level.

❷ LOW POWER INDICATOR

Appears when low output power is selected.

❸ AUDIBLE INDICATOR

Appears when the channel is in the 'audible' (unmute) condition.

❹ COMPANDER INDICATOR

Appears when the compander function is activated.

❺ SCRAMBLER/ENCRYPTION INDICATOR

Appears when the voice scrambler/encryption function is activated.

❻ ALPHANUMERIC DISPLAY

Shows a variety of text or code information.

■ Rear panel

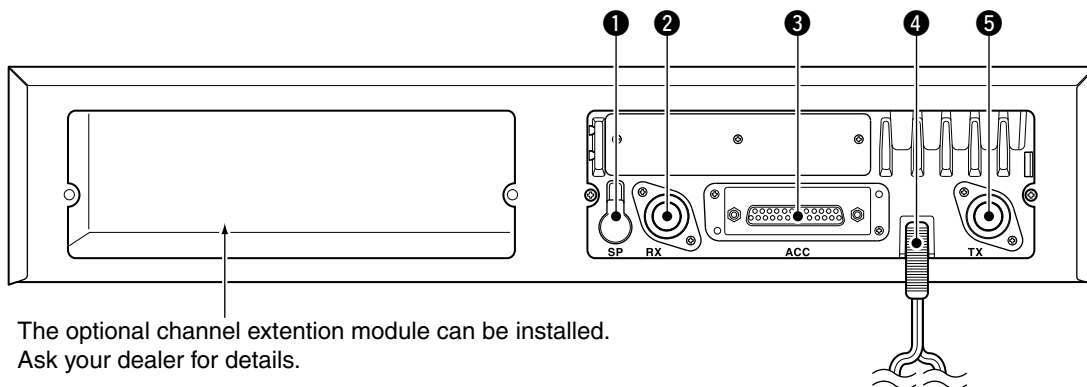

The optional channel extension module can be installed. Ask your dealer for details.

❶ EXTERNAL SPEAKER CONNECTOR [SP]

Connect the optional SP-22.

❷ RECEIVE ANTENNA CONNECTOR [RX]

Connects a receive antenna (impedance: 50 Ω) and inputs receiving signals.

❸ ACCESSORY CONNECTOR [ACC]

Connects to the accessory connector.
• See pgs. 3 for accessory connector information.

❹ DC POWER RECEPTACLE

Connects the supplied DC power cable from this connector to an external 13.2 V DC power supply.

❺ TRANSMIT ANTENNA CONNECTOR [TX]

Connects a transmit antenna (impedance: 50 Ω) and outputs transmit signals.

1 PANEL DESCRIPTION

◆ Accessory connector

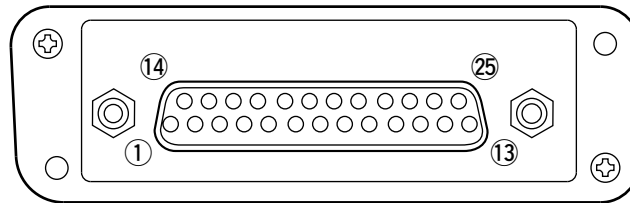

Pin No.	Pin Name	Description	Specification
1	NC	No connection	—
2	TXD	Output terminal for serial communication data.	—
3	RXD	Input terminal for serial communication data.	—
4	RTS	Output terminal for request-to-send data.	—
5	CTS	Input terminal for clear-to-send data.	—
6	NC	No connection	—
7	GND	Serial/digital signal ground	—
8	MOD IN	Modulator input from an external terminal unit.	Input level: 300 mV rms
9	DISC OUT	Output terminal for AF signals from the AF detector circuit. Output level is fixed, regardless of [AF] control.	Output level: 300 mV rms
10	EXT. D/A	The desired function can be assigned.* (Default: Null)	—
11	VCC	13.2 V DC output	Output current: Less than 1 A
12	EXT. A/D	Customize A/D input (Not used)	—
13	NC	No connection	—
14	GND	Ground	—
15	EXT./O 15	The desired function can be assigned.* (Default: Null)	+5 V pull up, Active=L
16	EXT./O 16	The desired function can be assigned.* (Default: P0 Monitor Output)	+5 V pull up, Active=L
17	EXT./O 17	The desired function can be assigned.* (Default: Busy Output)	+5 V pull up, Active=L
18	EXT./O 18	The desired function can be assigned.* (Default: Null)	+5 V pull up, Active=L
19	EXT./O 19	The desired function can be assigned.* (Default: EPTT Input)	+5 V pull up, Active=L
20	DATA IN	Input terminal for data.	—
21	EXT./O 21	The desired function can be assigned.* (Default: Analog Audible Output)	+5 V pull up, Active=L
22	AF OUT	The AF detector Output.	—
23	EXT./O 23	The desired function can be assigned.* (Default: Mic Mute Output)	+5 V pull up, Active=L
24	EXT./O 24	The desired function can be assigned.* (Default: Null)	+5 V pull up, Active=L
25	EXT./O 25	The desired function can be assigned.* (Default: Mic Hanger Output)	+5 V pull up, Active=L

* The desired function can be assigned using the optional CS-FR5000 CLONING SOFTWARE. Ask your dealer for details.

■ Unpacking

After unpacking, immediately report any damage to the delivering carrier or dealer. Keep the shipping cartons.

For a description and a diagram of accessory equipment included with the repeater, see 'SUPPLIED ACCESSORIES' on p. ii of this manual.

■ Selecting a location

Select a location for the repeater that allows adequate air circulation, free from extreme heat, cold, or vibrations, and away from TV sets, TV antenna elements, radios and other electromagnetic sources.

■ Antenna connection

For radio communications, the antenna is a critical component, along with output power and sensitivity. Select antenna(s), such as a well-matched 50 Ω antenna, and feedline. 1.5:1 or better of Voltage Standing Wave Ratio (VSWR) is recommended for desired band. Of course, the transmission line should be a coaxial cable.

CAUTION: Protect repeater from lightning by using a lightning arrestor.

NOTE: There are many publications that describe proper antennas and their installation. Check with your local dealer for more information and recommendations.

1
2

TYPE-N CONNECTOR INSTALLATION EXAMPLE

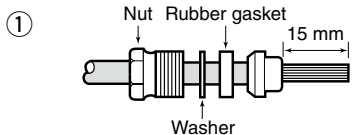

Slide the nut, flat washer, rubber gasket and clamp over the coaxial cable, then cut the end of the cable evenly.

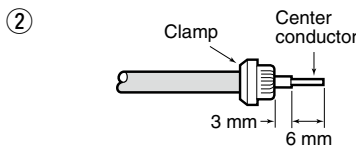

Strip the cable and fold the braid back over the clamp.

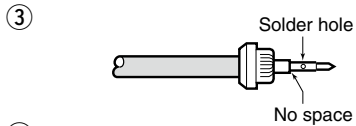

Soft solder the center conductor. Install the center conductor pin and solder it.

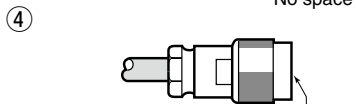

Carefully slide the plug body into place aligning the center conductor pin on the cable. Tighten the nut onto the plug body.

Be sure the center conductor is the same height as the plug body.

15 mm (19/32 in) 6 mm (1/4 in) 3 mm (1/8 in)

■ Front panel connection

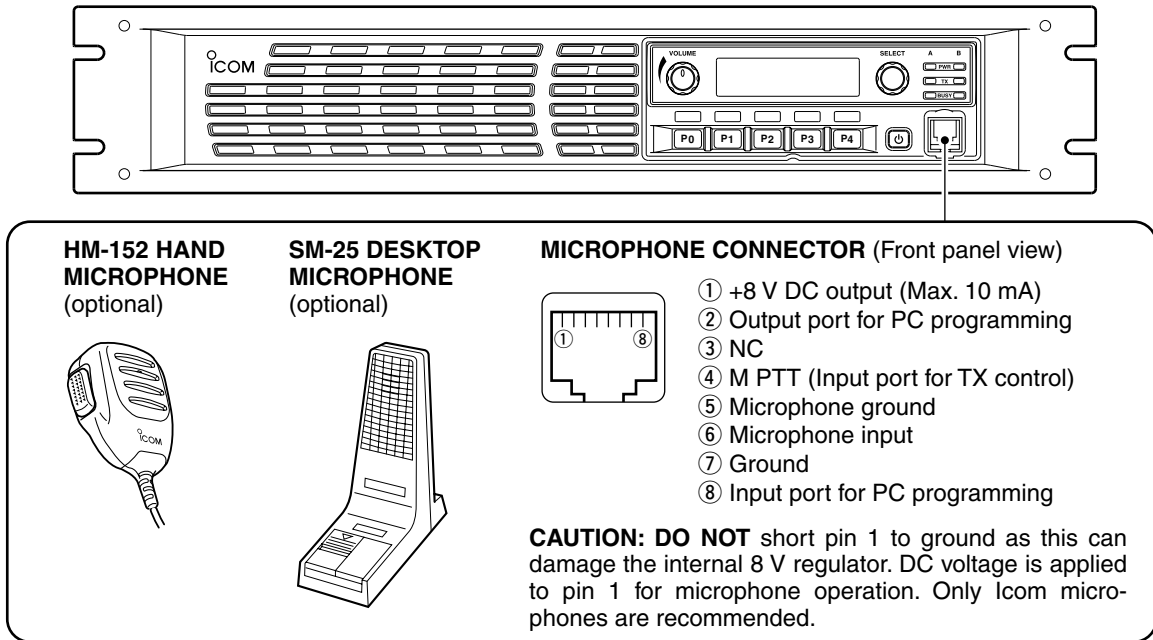

■ Rear panel connection

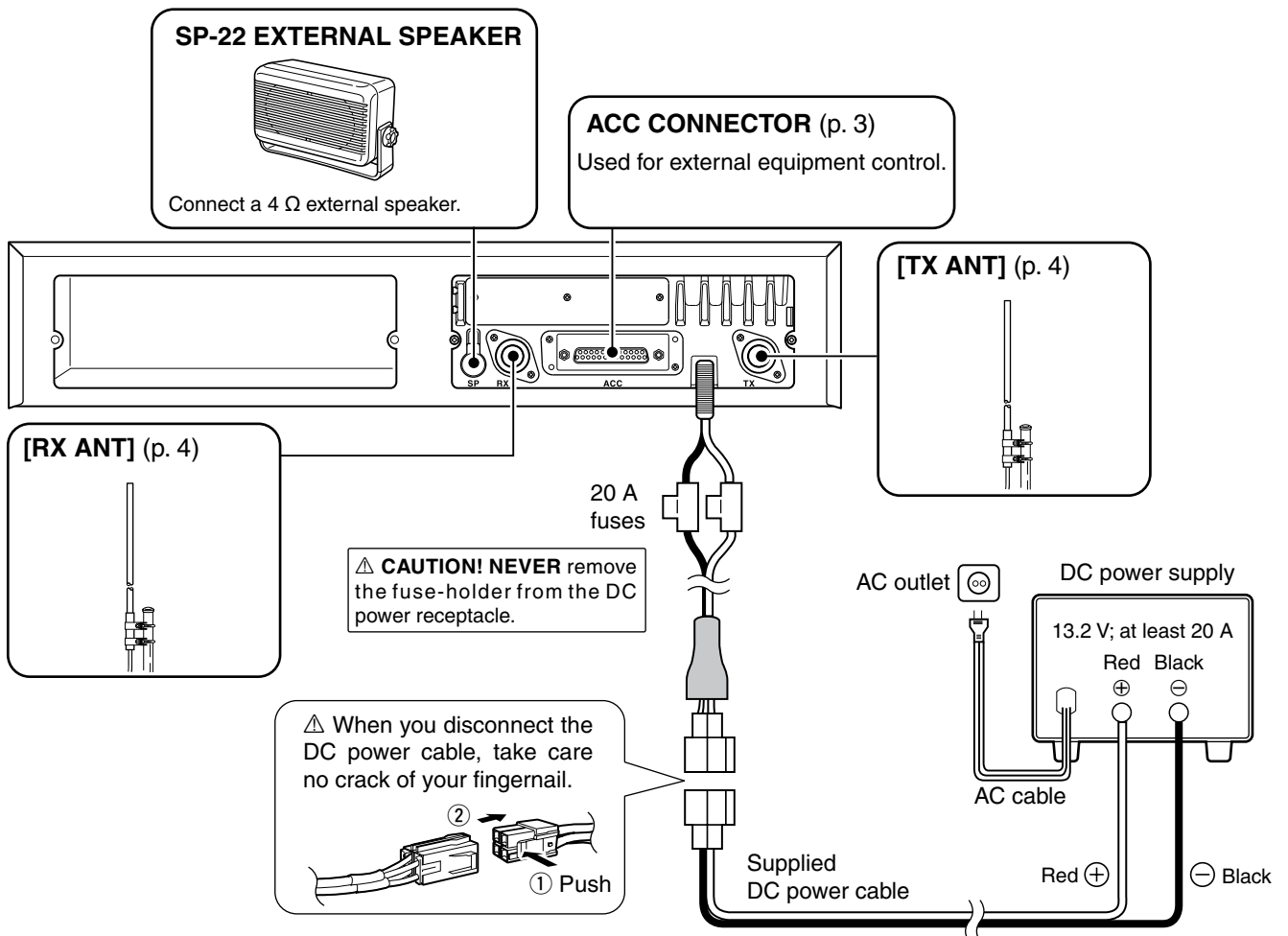

■ Power supply connection

Make sure the repeater's power is turned OFF when connecting a DC power cable.

CAUTION: Voltages greater than 16 V DC will damage the repeater. Check the source voltage before connecting the power cable.

■ Mounting the repeater

◇ Using the supplied handle

The supplied handles are available for mounting the repeater into a 19 inch rack. The handles can be installed to the repeater's front panel.

- ① Attach the supplied handles to both sides of the repeater's front panel with the spacers, then tighten the screws as below.

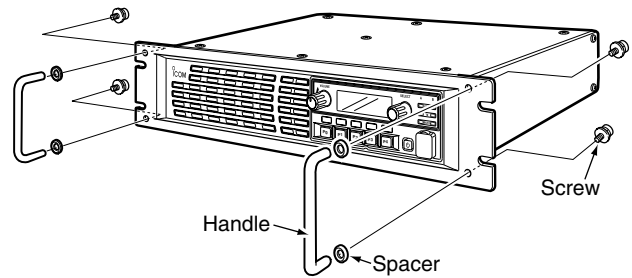

- ② The completed installation should look like as below.

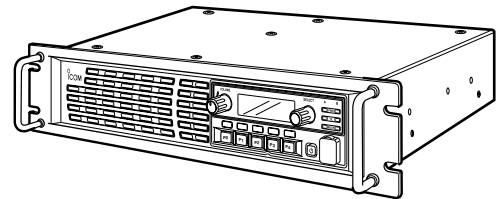

■ Receiving and transmitting

◇ Repeater operation

Ask your dealer for details of the repeater's programming.

- When the power is turned ON, the **[PWR]** indicator lights green. (p. 1)
- The **[TX]** and **[BUSY]** indicators light simultaneously while transmitting/receiving a signal.
 - The **[TX]** indicator lights red.
 - The **[BUSY]** indicator lights green.

NOTE: A power amplifier protector is built-in to the repeater. The protector is activated when the repeater temperature becomes extremely high due to the frequently access to the repeater to reduce the transmit output power level. The output power will return to the normal level when the repeater has cooled down.

◇ Base station operation

Receiving

- ① Push **[POWER]** to turn the power ON.
- ② Set the audio and squelch levels.
 - Rotate **[SELECT]***¹ fully counterclockwise in advance.
 - Rotate **[VOLUME]** to adjust the audio output level.
 - Rotate **[SELECT]***¹ clockwise until the noise disappears.
- ③ Push **[CH Up]***² or **[CH Down]***² to select the desired channel.
 - When receiving a signal, the **[BUSY]** indicator lights green and audio is emitted from the speaker.
 - Further adjustment of **[VOLUME]** to a comfortable listening level may be necessary at this point.

*¹ When the [SQL Level Up/Down] key function is assigned to [SELECT].

*² When the [CH Up]/[CH Down] key functions are assigned.

Transmitting

- ① Take the microphone off hook.
- ② Wait for the channel to become clear.
- ③ Push and hold **[PTT]** to transmit, then speak into the microphone at your normal voice level.
- ④ Release **[PTT]** to receive.

IMPORTANT:

To maximize the audio quality of the transmitted signal:

- (1) Pause briefly after pushing **[PTT]**.
- (2) Hold the microphone 1 to 2 inch (2.5 to 5 cm) from your mouth, then speak into the microphone at a normal voice level.

■ Troubleshooting

The following chart is designed to help correct problems which are not equipment malfunctions.

If you are unable to locate the cause of a problem or solve it through the use of this chart, contact the nearest Icom Dealer or Service Center.

PROBLEM	POSSIBLE CAUSE	SOLUTION	REF.
Power does not come on when [POWER] is pushed.	<ul style="list-style-type: none"> • DC power cable is improperly connected. • Fuse is blown. 	<ul style="list-style-type: none"> • Re-connect the DC power cable correctly. • Check the cause, then replace the fuse with a spare one. 	pgs. 5, 6 p. 8
No sounds from the speaker.	<ul style="list-style-type: none"> • Volume level is too low. • The squelch is closed. • The audio mute function is activated. • A selective call or squelch function is activated such as 5 tone call or tone squelch. • The front speaker is set to OFF. 	<ul style="list-style-type: none"> • Rotate [VOLUME] clockwise to obtain a suitable listening level. • While in base operating mode, rotate [SELECT] to counterclockwise to open the squelch. (When the [SQL Level Up/Down] key function is assigned to [SELECT].) • Push [MONI] (if assigned) to the audio mute function OFF. • Turn the appropriate function OFF. • Turn the front speaker ON using the optional CS-FR5000 CLONING SOFTWARE. Ask your dealer for details. 	p. 7 p. 7 — — —
Sensitivity is low and only strong signals are audible.	<ul style="list-style-type: none"> • Antenna feedline or the antenna connector has a poor contact or is short-circuited. 	<ul style="list-style-type: none"> • Check and re-connect (or replace if necessary), the antenna feedline or antenna connector. 	p. 5
Received signal cannot be understood.	<ul style="list-style-type: none"> • Optional voice scrambler is turned OFF. • Scrambler code is not set correctly. 	<ul style="list-style-type: none"> • Turn the optional voice scrambler ON. • Reset the scrambler code. 	— —
Output power is too low.	<ul style="list-style-type: none"> • Output power is set to Low. • Power amplifier protection circuit is activated. 	<ul style="list-style-type: none"> • Push [HIGH/LOW] (if assigned) to select the High power. • Cool down the repeater or stop accessing to the repeater until it has cooled down. 	— —
No contact possible with another station.	<ul style="list-style-type: none"> • The other station is using tone squelch. • While in base operating mode, the repeater is set to duplex. 	<ul style="list-style-type: none"> • Turn the tone squelch function ON. • Set the repeater to simplex, when other transceiver is set to simplex. 	— —

■ Fuse replacement

If a fuse blows or the repeater stops functioning, try to find the source of the problem, and then replace the damaged fuse with a new, rated fuse.

CAUTION: DISCONNECT the DC power cable from the repeater. Otherwise, there is danger of electric shock and/or equipment damage.

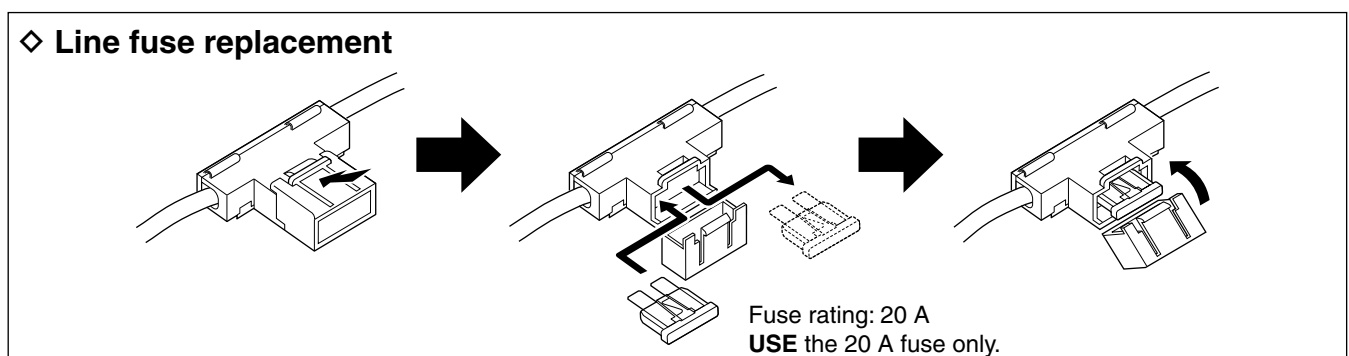

- **SP-22** EXTERNAL SPEAKER

Compact and easy-to-install.

Input impedance : 4 Ω

Max. input power : 5 W

- **HM-152** HAND MICROPHONE

- **SM-25** DESKTOP MICROPHONE

- **UR-FR5100/UR-FR6100** CHANNEL EXTENSION MODULES

- **UT-109R** VOICE SCRAMBLER UNIT

Non-rolling type (max. 32 codes).

- **UT-110R** VOICE SCRAMBLER UNIT

Rolling type (max. 1020 codes).

* The scrambler systems of the UT-109R and UT-110R are not compatible with each other.

Some options may not available in some countries.
Please ask your dealer for details.

INSTALLATION NOTES

• **Compliance of base station transmitter installations with EN50385**

The installation of this equipment and its associated antenna should be made in such a manner as to respect the EC recommended electromagnetic (EM) field exposure limits. (1999/519/EC)

In order not to exceed these exposure limits it is necessary to determine the 'Compliance Boundary,' that means the volume within which the EM field radiated by the transmitter/antenna installation may exceed the 1999/519/EC limits. You will then need to ensure that members of the general public do not have access within this area. The actual Compliance Boundary for this repeater will be totally dependant on the antenna, feeder, RF amplifier and other passive or active devices used in the installation.

The RF output power of this repeater is 25 watts.

The figures contained in this guide are based on the recommended limits for the general public and are obtained by 'worst case' numerical analysis. For a definitive evaluation of any given installation, measurements should be made with an EM field meter and a broadband calibrated probe.

• **Installation**

The antenna should be installed as high as possible for maximum efficiency and minimum EM field at ground-level. The evaluation of radiated field should take into account any additional RF amplifiers used, any loss in the antenna feeder cable and the gain of the antenna used as well as its polar radiation pattern.

If there are any objects or structures larger than half a wavelength close to the antenna, or within the clearance distances specified, then these can cause reflections which will have an effect on the overall radiation pattern.

For any installation you need to consider 'height clearance' (i.e. the height above any place where persons may have access) and 'front clearance' (i.e. the distance in front of the antenna where the radiated field may exceed the recommended limits). Normally with an antenna installed on a reasonably high mast or tower, there will not be any access point directly in front but care should be exercised when there are other buildings higher than the antenna within the vicinity.

• **Installation with a vertical type antenna at VHF-UHF**

You need to consider the distances between the antenna and any point where persons may have access. Allowing an average height of 1.8 m for a person in the vicinity of the antenna the clearance distances can be evaluated as follows. For the antenna a forward gain of 1.6 and downward gain of unity has been assumed.

Power	EIRP	Distance	Height clearance	Front clearance
1 watt	1.6 watts	0.32 m	2.1 m	0.4 m
10 watts	16 watts	1 m	2.8 m	1.3 m
25 watts	40 watts	1.6 m	3.4 m	2 m
100 watts	160 watts	3.2 m	5 m	4 m
1 kW	1600 watts	10 m	12 m	13 m

• **Installation with a yagi or directive type antenna**

Exposure distance assumes that the predominant radiation pattern is forwards and that radiation vertically downwards is at unity gain (sidelobe suppression is equal to main lobe gain). This is true of almost every gain antenna today. Exposed persons are assumed to be beneath the antenna array and have a typical height of 1.8 m.

The figures assume the worst case emission of constant carrier.

RF power Clearance heights by frequency band

Watts	10-2 m	70 cm	23 cm	13 cm and above
1	2.1 m	2 m	2 m	2 m
10	2.8 m	2.7 m	2.5 m	2.3 m
25	3.4 m	3.3 m	2.7 m	2.5 m
100	5 m	4.7 m	3.6 m	3.2 m
1000	12 m	11.5 m	7.3 m	6.3 m

EIRP Forward clearance, EIRP by frequency band

Watts	10-2 m	70 cm	23 cm	13 cm and above
100	2 m	2 m	1.1 m	0.7 m
1000	6.5 m	6 m	3.5 m	3 m
10,000	20 m	18 m	11 m	7 m
100,000	65 m	60 m	35 m	29 m

5
6

• Typical installation example

A UHF base station transmitter is to be installed on the roof of an office.

The transmit power is 25 watts, there is 20 m of RG-213 coaxial cable and the antenna is vertically polarised dipole.

The specification of the RG-213 cable gives a loss of 1.5 dB/10 m. There will be 3 dB loss for the 20 m length used.

The RF power at the antenna input will be 12.5 watts.

The dipole antenna has a forward gain of 0 dBd or 1.6, giving an EIRP of 20 watts.

Referring to the table above for VHF/UHF vertical antennas, this gives a front clearance distance of approx. 1.5 m and a height clearance of 3 m.

The antenna installation needs to ensure that the lowest part of the antenna is at least 3 m above any point where the general public may gain access and that they cannot pass within 1.5 m in front of the antenna.

If there is no general public access to the roof in question then the antenna could be mounted on a short stub mast. If there is such access to the roof then the antenna could be mounted on top of a short mast of 3.2 m high. The mast position should be such that the antenna can radiate clearly i.e. no other object or structure is within 1.5 m (preferably more).

It should be relatively easy to fulfil all these recommendations.

If for any reason such minimum distances are impossible to guarantee then some type of access control fence or barrier around the antenna installation should be provided.

Should a Yagi type antenna be used then you will have to obtain a 3 dimensional polar plot of the radiation characteristic from the manufacturer and evaluate the clearance distances in both vertical and horizontal planes.

• Operating Notes

All of the above comments on RF safety assume that the radio is transmitting continuously in a constant carrier mode such as FM or RTTY etc.

The RF exposure limits recommended by the EC are based on the mean power averaged over a 6 minute period.



Therefore if the total transmit time during any 6 minute period is reduced, then the installation will be even further within the recommended limits.

 CE Versions of the IC-FR5100/IC-FR6100 which display the “CE” symbol on the serial number seal, comply with the essential requirements of the European Radio and Telecommunication Terminal Directive 1999/5/EC.



 This warning symbol indicates that this equipment operates in non-harmonised frequency bands and/or may be subject to licensing conditions in the country of use. Be sure to check that you have the correct version of this radio or the correct programming of this radio, to comply with national licensing requirement.

• List of Country codes (ISO 3166-1)

	Country	Codes		Country	Codes
1	Austria	AT	18	Liechtenstein	LI
2	Belgium	BE	19	Lithuania	LT
3	Bulgaria	BG	20	Luxembourg	LU
4	Croatia	HR	21	Malta	MT
5	Czech Republic	CZ	22	Netherlands	NL
6	Cyprus	CY	23	Norway	NO
7	Denmark	DK	24	Poland	PL
8	Estonia	EE	25	Portugal	PT
9	Finland	FI	26	Romania	RO
10	France	FR	27	Slovakia	SK
11	Germany	DE	28	Slovenia	SI
12	Greece	GR	29	Spain	ES
13	Hungary	HU	30	Sweden	SE
14	Iceland	IS	31	Switzerland	CH
15	Ireland	IE	32	Turkey	TR
16	Italy	IT	33	United Kingdom	GB
17	Latvia	LV			

 <p style="margin-top: 20px;">We Icom Inc. Japan 1-1-32, Kamiminami, Hirano-ku Osaka 547-0003, Japan</p> <p>Declare on our sole responsibility that this equipment complies with the essential requirements of the Radio and Telecommunications Terminal Equipment Directive, 1999/5/EC, and that any applicable Essential Test Suite measurements have been performed.</p> <p>Kind of equipment: VHF REPEATER</p> <hr/> <p>Type-designation: IC-FR5100/UR-FR5100</p> <p style="text-align: right; margin-right: 20px;">136-174 MHz 6.25 kHz/12.5 kHz/25 kHz 136-174 MHz 6.25 kHz/12.5 kHz/20 kHz</p> <p>Version (where applicable):</p> <p>This compliance is based on conformity with the following harmonised standards, specifications or documents:</p> <ul style="list-style-type: none"> i) <u>EN 301 489-1 v1.4.1 (August 2002)</u> ii) <u>EN 301 489-5 v1.3.1 (August 2002)</u> iii) <u>EN 300 086-2 v1.1.1 (March 2001)</u> iv) <u>EN 301 166-2 v1.1.1 (December 2001)</u> v) <u>EN 300 219-2 v1.1.1 (March 2001)</u> vi) <u>EN 300 113-2 v1.3.1 (December 2003)</u> vii) <u>EN 60950-1: 2001</u> viii) <u>EN 50385: 2002</u> 	<div style="background-color: #cccccc; padding: 5px; text-align: center; font-weight: bold; font-size: 1.2em;">DECLARATION OF CONFORMITY</div> <div style="margin-top: 20px; font-size: 2em; font-weight: bold;">C €0168</div> <div style="font-size: 1.5em; font-weight: bold;">!</div> <p style="font-size: 0.8em; margin-top: 10px;"><u>Düsseldorf 16th Apr. 2008</u> Place and date of issue</p> <p style="font-size: 0.8em; margin-top: 10px;">Icom (Europe) GmbH Himmelgeister straÙe 100 D-40225 Düsseldorf Authorized representative name</p> <p style="font-size: 0.8em; margin-top: 10px;">Y. Furukawa General Manager</p> <div style="margin-top: 10px;">  <p style="font-size: 0.8em; margin-top: 5px;">Signature</p> </div> <p style="font-size: 1.2em; font-weight: bold; margin-top: 10px;">Icom Inc.</p>
---	---

6

 <p style="margin-top: 20px;">We Icom Inc. Japan 1-1-32, Kamiminami, Hirano-ku Osaka 547-0003, Japan</p> <p>Declare on our sole responsibility that this equipment complies with the essential requirements of the Radio and Telecommunications Terminal Equipment Directive, 1999/5/EC, and that any applicable Essential Test Suite measurements have been performed.</p> <p>Kind of equipment: UHF REPEATER</p> <hr/> <p>Type-designation: IC-FR6100/UR-FR6100</p> <p style="text-align: right; margin-right: 20px;">400-470 MHz 6.25 kHz/12.5 kHz/25 kHz 400-470 MHz 6.25 kHz/12.5 kHz/20 kHz</p> <p>Version (where applicable):</p> <p>This compliance is based on conformity with the following harmonised standards, specifications or documents:</p> <ul style="list-style-type: none"> i) <u>EN 301 489-1 v1.4.1 (August 2002)</u> ii) <u>EN 301 489-5 v1.3.1 (August 2002)</u> iii) <u>EN 300 086-2 v1.1.1 (March 2001)</u> iv) <u>EN 301 166-2 v1.1.1 (December 2001)</u> v) <u>EN 300 219-2 v1.1.1 (March 2001)</u> vi) <u>EN 300 113-2 v1.3.1 (December 2003)</u> vii) <u>EN 60950-1: 2001</u> viii) <u>EN 50385: 2002</u> 	<div style="background-color: #cccccc; padding: 5px; text-align: center; font-weight: bold; font-size: 1.2em;">DECLARATION OF CONFORMITY</div> <div style="margin-top: 20px; font-size: 2em; font-weight: bold;">C €0168</div> <div style="font-size: 1.5em; font-weight: bold;">!</div> <p style="font-size: 0.8em; margin-top: 10px;"><u>Düsseldorf 25th Feb. 2008</u> Place and date of issue</p> <p style="font-size: 0.8em; margin-top: 10px;">Icom (Europe) GmbH Himmelgeister straÙe 100 D-40225 Düsseldorf Authorized representative name</p> <p style="font-size: 0.8em; margin-top: 10px;">Y. Furukawa General Manager</p> <div style="margin-top: 10px;">  <p style="font-size: 0.8em; margin-top: 5px;">Signature</p> </div> <p style="font-size: 1.2em; font-weight: bold; margin-top: 10px;">Icom Inc.</p>
---	---

Count on us!

< Intended Country of Use >

AT BE CY CZ DK EE
FI FR DE GR HU IE
IT LV LT LU MT NL
PL PT SK SI ES SE
GB IS LI NO CH BG
RO TR HR

Free Manuals Download Website

<http://myh66.com>

<http://usermanuals.us>

<http://www.somanuals.com>

<http://www.4manuals.cc>

<http://www.manual-lib.com>

<http://www.404manual.com>

<http://www.luxmanual.com>

<http://aubethermostatmanual.com>

Golf course search by state

<http://golfingnear.com>

Email search by domain

<http://emailbydomain.com>

Auto manuals search

<http://auto.somanuals.com>

TV manuals search

<http://tv.somanuals.com>