

AQ5311D

AQ5311D BK

USER MANUAL

TABLE OF CONTENTS

FOR YOUR SAFETY	1
SAFETY PRECAUTIONS	1
SPECIAL NOTES ON LCD MONITORS	3
CUSTOMER SERVICE	3
CLEANING	3
BEFORE YOU OPERATE THE MONITOR	4
FEATURES	4
CHECKING THE CONTENTS OF THE PACKAGE	4
CONTROLS AND CONNECTORS	5
CONNECTING YOUR MONITOR	6
COMPUTER SETTING	8
ADJUSTING THE HEIGHT AND THE VIEWING ANGLE	9
PANEL ROTATION	9
OPERATING THE MONITOR	10
ADJUSTMENT MENU CONTENTS	11
SCREEN ADJUSTMENTS	14
POWER MANAGEMENT FEATURE	17
TROUBLE SHOOTING	18
APPENDIX	19
SPECIFICATIONS	19
COMPLIANT TIMING	20
CONNECTOR PIN ASSIGNMENT	21

ENGLISH

DEUTSCH

FRANCAIS

NEDERLANDS

SVENSKA

ITALIANO

日本語

Thank you very much for choosing the iiyama LCD monitor.

We recommend that you take a few minutes to read carefully through this brief but comprehensive manual before installing and switching on the monitor. Please keep this manual in a safe place for your future reference.

FCC DECLARATION OF CONFORMITY

Model Number: AQ5311D / AQ5311D BK
Trade Name: iiyama
Responsible party: IYAMA North America, Inc.
Address: 1560 Brookhollow Drive, Suite 208, Santa Ana, CA 92705 U.S.A.
Telephone number: 714-437-5111

This device complies with Part 15 of the FCC Rules. Operation is subject to the following two conditions: (1) This device may not cause harmful interference, and (2) this device must accept any interference received, including interference that may cause undesired operation.

This device has been tested and found to comply with the limits for Class B Personal Computers and peripherals, pursuant to Part 15 of the FCC Rules. These limits are designed to provide reasonable protection against harmful interference when the device is operated in a residential environment. This device generates, uses and can radiate radio frequency energy, and if not installed and used in accordance with the instructions, may cause harmful interference to radio communications. However, there is no guarantee that interference will not occur in a particular installation. If you determine the device does cause harmful interference to radio or television reception (this may be determined by monitoring the interference while turning the device off and on), you are encouraged to try to correct the interference by one of the following measures:

- Reorient or relocate the receiving antenna.
- Increase the separation between the device and receiver.
- Connect the device into an outlet on a circuit different from that to which the receiver is connected.
- Consult the dealer or an experienced radio or TV technician for help.

To meet the FCC requirements, you should use a signal cable with ferrite core at both ends.

CAUTION

Changes or modifications not expressly approved by iiyama could void the users authority to operate the device under FCC compliance regulations.

CANADIAN DEPARTMENT OF COMMUNICATIONS COMPLIANCE STATEMENT

This digital apparatus does not exceed the Class B limits for radio noise emissions from digital apparatus as set out in the radio interference regulation of the Canadian department of communications.

CE MARKING DECLARATION OF CONFORMITY

This LCD monitor complies with the requirements of the EC Directive 89/336/EEC "EMC Directive" and 73/23/EEC "Low Voltage Directive" as amended by Directive 93/68/EEC.

The electro-magnetic susceptibility has been chosen at a level that gives correct operation in residential areas, business and light industrial premises and small-scale enterprises, inside as well as outside of the buildings. All places of operation are characterised by their connection to the public low voltage power supply system.

- We reserve the right to change specifications without notice.
- All trademarks used in this user manual are the property of their respective owners.
- This manual is printed on recycled paper.

FOR YOUR SAFETY

SAFETY PRECAUTIONS

WARNING

STOP OPERATING THE MONITOR WHEN YOU SENSE TROUBLE

If you notice any abnormal phenomena such as smoke, strange sounds or fumes, unplug the monitor and contact your dealer or iiyama service center immediately. Further use may be dangerous and can cause fire or electric shock.

NEVER REMOVE THE CABINET

High voltage circuits are inside the monitor. Removing the cabinet may expose you to the danger of fire or electric shock.

DO NOT PUT ANY OBJECT INTO THE MONITOR

Do not put any solid objects or liquids such as water into the monitor. In case of an accident, unplug your monitor immediately and contact your dealer or iiyama service center. Using the monitor with any object inside may cause fire, electric shock or damage.

INSTALL THE MONITOR ON A FLAT, STABLE SURFACE

The monitor may cause an injury if it falls or is dropped.

DO NOT USE THE MONITOR NEAR WATER

Do not use where water may be splashed or spilt onto the monitor as it may cause fire or electric shock.

OPERATE UNDER THE SPECIFIED POWER SUPPLY

Be sure to operate the monitor only with the specified power supply. Use of an incorrect voltage will cause malfunction and may cause fire or electric shock.

PROTECT THE CABLES

Do not pull or bend the power cable and signal cable. Do not place the monitor or any other heavy objects on the cables. If damaged, the cables may cause fire or electric shock.

ADVERSE WEATHER CONDITIONS

It is advisable not to operate the monitor during a heavy thunder storm as the continual breaks in power may cause malfunction. It is also advised not to touch the plug in these circumstances as it may cause electric shock.

CAUTION

INSTALLATION LOCATION

Do not install the monitor where sudden temperature changes may occur, or in humid, dusty or smoky areas as it may cause fire, electric shock or damage. You should also avoid areas where the sun shines directly on the monitor.

DO NOT PLACE THE MONITOR IN A HAZARDOUS POSITION

The monitor may topple and cause injury if not suitably located. Please also ensure that you do not place any heavy objects on the monitor, and that all cables are routed such that children may not pull the cables and possibly cause injury.

MAINTAIN GOOD VENTILATION

Ventilation slots are provided to keep the monitor from overheating. Covering the slots may cause fire. To allow adequate air circulation, place the monitor at least 10 cm (or 4 inches) from any walls.

Do not remove the tilt stand when operating the monitor. Ventilation slots on the back of the cabinet will be blocked and the monitor may overheat if the stand is removed. This may cause fire or damage. Operating the monitor on its back, side, upside down or on a carpet or any other soft material may also cause damage.

DISCONNECT THE CABLES WHEN YOU MOVE THE MONITOR

When you move the monitor, turn off the power switch, unplug the monitor and be sure the signal cable is disconnected. If you do not disconnect them, it may cause fire or electric shock.

UNPLUG THE MONITOR

If the monitor is not in use for a long period of time it is recommended that it is left unplugged to avoid accidents.

HOLD THE PLUG WHEN DISCONNECTING

To disconnect the power cable or signal cable, always pull it by the plug. Never pull on the cable itself as this may cause fire or electric shock.

DO NOT TOUCH THE PLUG WITH WET HANDS

Pulling or inserting the plug with wet hands may cause electric shock.

WHEN YOU INSTALL THE MONITOR ON YOUR COMPUTER

Be sure the computer is strong enough to hold the weight of the monitor, otherwise, you may damage your computer.

OTHERS

ERGONOMIC RECOMMENDATIONS

To eliminate eye fatigue, do not operate the monitor against a bright background or in a dark room. For optimal viewing comfort, the monitor should be just below eye level and 40-60 cm (16-24 inches) away from your eyes. When using the monitor over a prolonged time, a ten minute break every hour is recommended as looking at the screen continuously can cause eye strain.

SPECIAL NOTES ON LCD MONITORS

The following symptoms are normal with LCD monitors and do not indicate a problem.

NOTE

- When you first turn on the LCD monitor, the picture may not fit in the display area because of the type of computer that is used. In this case, adjust the picture position to its correct position.
- Due to the nature of the backlight, the screen may flicker during initial use. Turn off the Power Switch and then turn it on again to make sure the flicker disappears.
- You may find slightly uneven brightness on the screen depending on the desktop pattern you use.
- Due to the nature of the LCD screen, an afterimage of the previous screen may remain after switching the image, when the same image is displayed for hours. In this case, the screen is recovered slowly by changing the image or turning off the Power Switch for hours.
- Contact your dealer or iiyama service center for the backlight replacement when the screen is dark, flickering or not lighting up. Never attempt to replace it by yourself.

CUSTOMER SERVICE

NOTE

- The fluorescent light used in the LCD monitor may have to be periodically replaced. For the warranty coverage on this component, please check with local iiyama service center. If you have to return your unit for service and the original packaging has been discarded, please contact your dealer or iiyama service center for advice or replacement packaging.

CLEANING

WARNING

- If you drop any materials or liquids such as water into the monitor when cleaning, unplug the power cable immediately and contact your dealer or iiyama service center.

CAUTION

- For safety reasons, turn off the power switch and unplug the monitor before you clean it.

NOTE

- To protect the LCD panel, do not scratch or rub the screen with a hard object.
- Never use any of the following strong solvents. These will damage the cabinet and the LCD screen.

Thinner	Spray-type cleaner
Benzine	Wax
Abrasive cleaner	Acid or Alkaline solvent

- Touching the cabinet with any product made from rubber or plastic for a long time may cause degeneration or loss of paint on the cabinet.

CABINET

Stains can be removed with a cloth lightly moistened with a mild detergent solvent. Then wipe the cabinet with a soft dry cloth.

LCD

Periodic cleaning with a soft dry cloth is recommended.

SCREEN

Don't use tissue paper etc. because these will damage the LCD screen.

BEFORE YOU OPERATE THE MONITOR

Please remove the stopper pin on the back of the stand before you install the monitor. Careful attention is required as the monitor is sprung loaded and may expand quickly when removing it.

FEATURES

- ◆ 52.8cm (20.8") TFT Color LCD Monitor
- ◆ Supports Resolutions up to 2048 × 1536 (QXGA)
- ◆ Super Wide Viewing Angle and High Resolution
- ◆ Digital Character Smoothing
- ◆ Automatic Set-up
- ◆ Plug & Play VESA DDC2B Compliant
Windows® 95/98/2000/Me/XP Compliant
- ◆ Power Management
- ◆ Ergonomic Design: MPR III Approved
- ◆ Digital Input (DVI-I) for Clear Display
- ◆ 90° Panel Rotation Design
- ◆ VESA Standard (100mm×100mm) Compliant

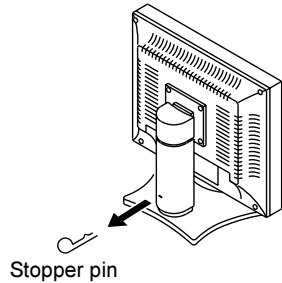

CHECKING THE CONTENTS OF THE PACKAGE

The following accessories are included in your package. Check to see if they are enclosed with the monitor. If anything is missing or damaged, please contact your local iiyama dealer or regional iiyama office.

- Power Cable*1
- AC Adapter
- D-Sub Signal Cable MB32*2, MB36*3
- DVI-D Signal Cable DV65*2, DV64*3
- Cable Cover
- AC Adapter Holder
- Band
- Screw
- User Manual

CAUTION

*1 TO USERS IN 120V AREA

The rating of the Power Cable enclosed in 120V area is 10A/125V. If you are using a power supply higher than this rating, then a power cable with a rating of 10A/250V must be used.

*2 Accessory for AQ5311D

*3 Accessory for AQ5311D BK (Cabinet color: Black)

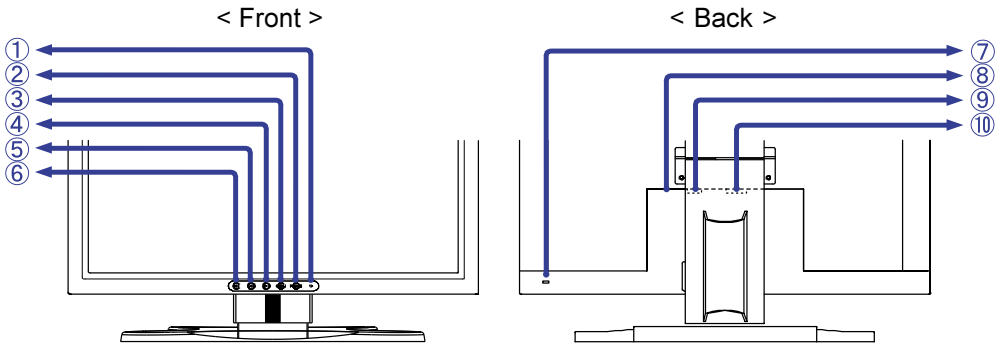

① Power Indicator

NOTE Green: Normal operation
Orange: Power Management

The monitor enters into power management mode which reduces the power consumption to less than 13.5W when receiving no horizontal and/or vertical sync signal.

② Power Switch

③ Menu Button

④ ► / Contrast Button

⑤ ◀ / Brightness Button

⑥ Exit Button

⑦ Keyhole for Security Lock

NOTE You can fasten a security lock and cable to prevent the monitor from being removed without your permission.

⑧ Connector for AC Adapter (DC-IN)

⑨ D-Sub mini 15pin Connector (ANALOG RGB)

⑩ DVI-I 29pin Connector (DVI)

CONNECTING YOUR MONITOR

- ① Ensure that both the computer and the monitor are switched off.
- ② Connect the computer to the monitor with the signal cable. (See page 21 for CONNECTOR PIN ASSIGNMENT.)
- ③ Connect the AC Adapter to the Connector for AC Adapter of the monitor.
- ④ Connect the Power Cable to the AC Adapter first and then to the power supply.

NOTE

- The signal cables used for connecting the computer and monitor vary by the type of computer used. An incorrect connection may cause serious damage to both the monitor and the computer. The cable supplied with the monitor is for a standard 15 pin D-Sub connector. If a special cable is required please contact your local iiyama dealer or regional iiyama office.
- For connection to Macintosh computers, contact your local iiyama dealer or regional iiyama office for a suitable adaptor.
- Make sure you tighten the finger screws at each end of the signal cable.
- Cables are connected easily by rotating the panel 90 degrees. (See page 9 for PANEL ROTATION.)
- Cables can be bundled together inside the Cable Cover at the back of the stand. See next page for cable wiring.
- AC Adapter can be fastened on the back of the monitor with the AC Adapter Holder. See next page for AC Adapter installation.

[Example of Connection]

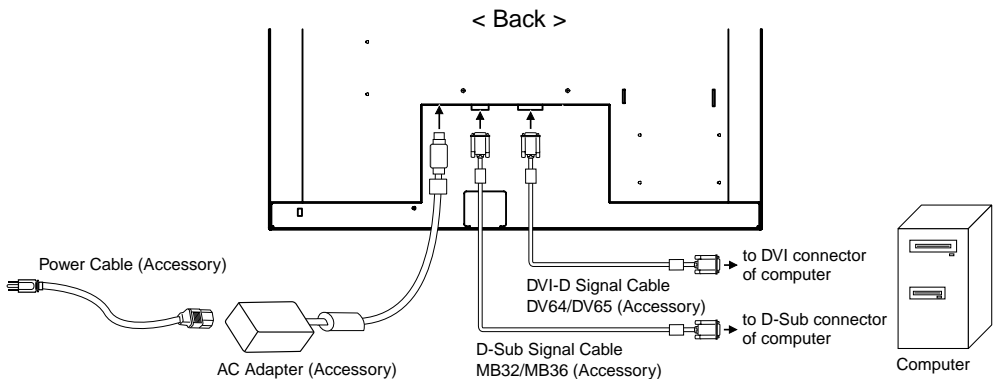

[Cable Wiring]

- ① Collect cables at the back of the stand.
- ② Place the Cable Cover by inserting the tabs into guide holes and then sliding the cover downward.

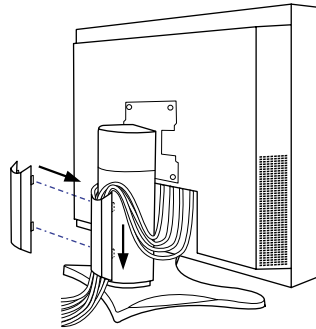

[AC Adapter Installation]

- ① Attach the AC Adapter Holder to the AC Adapter.
- ② Place the AC Adapter Holder by inserting the tabs into the cavities on the back of the monitor.
- ③ Tighten the Screw to fasten the AC Adapter Holder.
- ④ Bundle up the adapter cable with the Band.

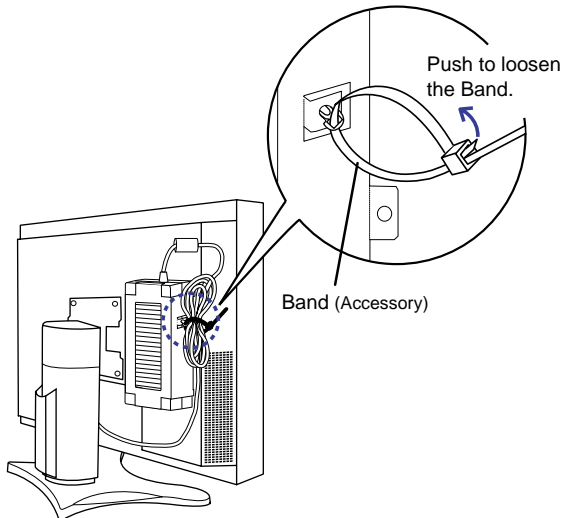
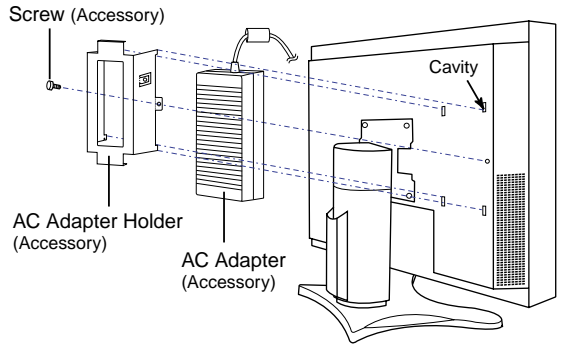

COMPUTER SETTING

■ Signal Timing

When you connect the monitor to the computer for the first time, set the signal timing of the computer to VGA before connection. Change to the desired signal timings listed on page 20 in COMPLIANT TIMING, after you confirm that the picture appears normally at VGA.

■ Windows 95/98/2000/Me/XP Plug & Play

The iiyama LCD monitor complies with DDC2B of VESA standard. The Plug & Play function runs on Windows 95/98/2000/Me/XP by connecting the monitor to DDC2B compliant computer with the Signal Cable supplied. Windows 95/98/2000/Me/XP Monitor Information File for iiyama monitors may be necessary for your computer and obtained via the Internet, using the address:

<http://www.iiyama.com> (U.S.A.)

<http://www.iiyama.co.uk> (U.K.)

NOTE

- For additional information on how to download the driver for your monitor, please access one of the internet sites noted above.
- Monitor Drivers are not required in most cases for Macintosh or Unix operating systems. For further information, please contact your computer dealer first for advice.

ADJUSTING THE HEIGHT AND THE VIEWING ANGLE

- For optimal viewing it is recommended to look at the full face of the monitor, then adjust the monitor's height and angle to your own preference.
- Hold the panel so that the monitor does not topple when you change the monitor's height or angle.
- You are able to adjust the monitor's height up to 110 mm, angle up to 35 degrees right and left, 35 degrees upward.

- NOTE**
- Do not touch the LCD screen when you change the height or the angle. It may cause damage or break the LCD screen.
 - Careful attention is required not to catch your fingers or hands when you change the height or the angle.

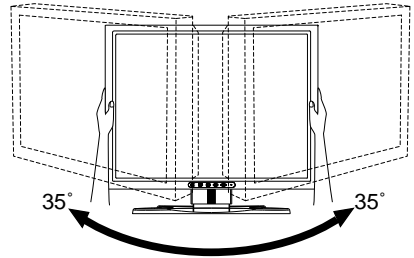
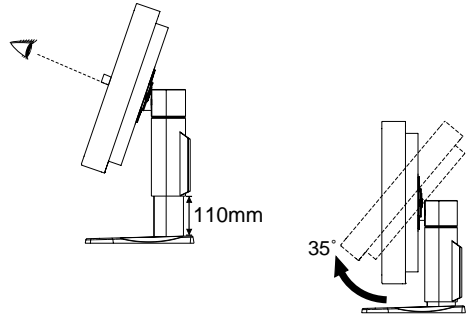

PANEL ROTATION

① Adjust the monitor's height to the maximum.

② Rotate the panel 90 degrees.

Portrait: Turn clockwise.

Landscape: Turn counter clockwise.

NOTE Attempting to rotate without fully extending upward may cause damage to stand.

③ Adjust the monitor's angle to your preference.

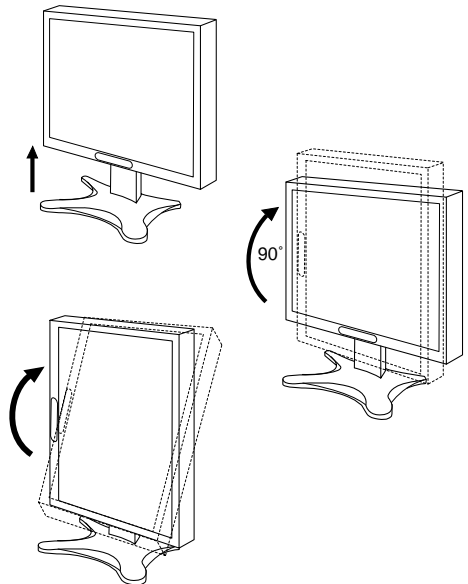

OPERATING THE MONITOR

To create the best picture, your iiyama LCD monitor has been preset at the factory with the COMPLIANT TIMING shown on page 20. You are also able to adjust the picture by following the button operation shown below. For more detailed adjustments, see page 14 for SCREEN ADJUSTMENTS.

- ① Press the Menu Button to start the On Screen Display feature. Move the cursor by using the ◀ / ▶ Buttons.
- ② Select the adjustment icon relating to the adjustment you want to make by using the ◀ / ▶ Buttons. Press the Menu Button again.
- ③ Use the ◀ / ▶ Buttons to make the appropriate adjustment or setting.
- ④ Press the Exit Button to return to the previous display. Any changes are automatically saved in the memory.

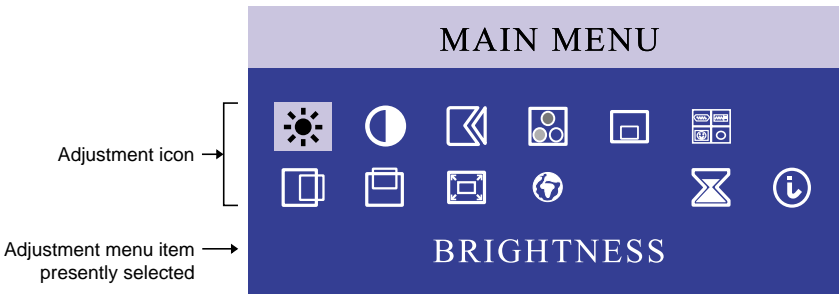

NOTE

- The On Screen Display disappears in optional setting seconds after you stop pressing the buttons while performing an adjustment. (See pages 12 and 13 for OSD TIME.)
- Any changes are automatically saved in the memory when the On Screen Display disappears. Turning off the power should be avoided while using the Menu.
- Adjustments for FINE, COARSE and POSITION are saved for each signal timing. Except for these adjustments, all other adjustments have only one setting which applies to all signal timings.















ADJUSTMENT MENU CONTENTS

Direct

You can skip the Menu display and perform an adjustment immediately by using the following button operations.



















- Brightness: Press the Brightness Button when the Menu is not displayed.
- Contrast: Press the Contrast Button when the Menu is not displayed.
- Automatic set-up: Press the ◀ and ▶ Buttons at the same time when the Menu is not displayed.

Analog / DVI-Analog Input

Adjustment Item		Problem / Option	Button to Press
	BRIGHTNESS *1 Direct	Too dark Too bright	
	CONTRAST Direct	Too dull Too intense	
	IMAGE SET-UP	AUTO *2 Direct	Adjust FINE, COARSE, H-POSITION and V-POSITION automatically.
		MANUAL	
	COLOR	PRESET1	9300K
		PRESET2	6500K
		PRESET3	5500K
		USER MODE	RED GREEN BLUE
	OSD POSITION	H-POS	 Too far to the left  Too far to the right 
		V-POS	 Too low  Too high 
	INPUT SELECTION	ANALOG	Select the Analog RGB input.
		DVI-ANALOG	Select the DVI-Analog input.
		DVI-DIGITAL	Select the DVI-Digital input.





























*1 Adjust the Brightness when you are using the monitor in a dark room and feel the screen is too bright.

*2 See page 14 for SCREENADJUSTMENTS.

Adjustment Item		Problem / Option	Button to Press
 H-POSITION		 Too far to the left  Too far to the right	   
 V-POSITION		 Too low  Too high	   
 IMAGE SIZE * ³	NORMAL	The picture is displayed at the optimum resolution.	
	EXPANDED	Stretch the picture to fit the full screen.	
 LANGUAGE	ENGLISH	English	
	FRANCAIS	French	
	DEUTSCH	German	
	ITALIANO	Italian	
	ESPANOL	Spanish	
	JAPANESE	Japanese	
 OSD TIME		You can set the OSD display duration time between 5 and 60 seconds.	
 INFORMATION		The model name, year of manufacture, the current horizontal scan frequency and vertical refresh rate are displayed.	

*³ Main Menu does not appear on the screen if you press the Menu Button while you select NORMAL at resolution of less than XGA (1024×768). Select EXPANDED temporarily to display the Main Menu.

DVI-Digital Input

Adjustment Item		Problem / Option	Button to Press
 BRIGHTNESS *1	Direct	Too dark Too bright	   
 CONTRAST	Direct	Too dull Too intense	   
 COLOR	PRESET1	9300K	
	PRESET2	6500K	
	PRESET3	5500K	
	USER MODE	RED GREEN BLUE	Too weak Too strong
 OSD POSITION	H-POS	 Too far to the left  Too far to the right	   
	V-POS	 Too low  Too high	   
 INPUT SELECTION	ANALOG	Select the Analog RGB input.	
	DVI-ANALOG	Select the DVI-Analog input.	
	DVI-DIGITAL	Select the DVI-Digital input.	
 IMAGE SIZE *2	NORMAL	The picture is displayed at the optimum resolution.	
	EXPANDED	Stretch the picture to fit the full screen.	
 LANGUAGE	ENGLISH	English	
	FRANCAIS	French	
	DEUTSCH	German	
	ITALIANO	Italian	
	ESPANOL	Spanish	
	JAPANESE	Japanese	
 OSD TIME		You can set the OSD display duration time between 5 and 60 seconds.	
 INFORMATION		The model name, year of manufacture, the current horizontal scan frequency and vertical refresh rate are displayed.	

- *1 Adjust the Brightness when you are using the monitor in a dark room and feel the screen is too bright.
- *2 Main Menu does not appear on the screen if you press the Menu Button while you select NORMAL at resolution of less than XGA (1024×768). Select EXPANDED temporarily to display the Main Menu.

SCREEN ADJUSTMENTS

Adjust the image by following the procedure below to get the desired picture when selecting Analog input.

- The screen adjustments described in this manual are designed to set image position and minimize flicker or blur for the particular computer in use. They are unlike the adjustments you would make on a CRT monitor.
- The monitor is designed to provide the best performance at resolution of 2048 × 1536, but can not provide the best at resolutions of less than 2048 × 1536 because the picture is automatically stretched to fit the full screen or displayed at optimum resolution. It is recommended to operate at resolution of 2048 × 1536 in normal use.
- Displayed text or lines will be blurred or irregular in thickness when the picture is stretched due to the screen enlargement process.
- It is preferable to adjust the image position and frequency with the monitor controls, rather than the computer software or utilities.
- Perform adjustments after a warm-up period of at least thirty minutes.
- Additional adjustments may be required after the Automatic set-up depending on the resolution or signal timing.
- The Automatic set-up may not work correctly when displaying the picture other than the Test.bmp (screen adjustment pattern). In this case, manual adjustments are required.

There are two ways to adjust the screen. One way is automatic adjustment for FINE, COARSE and POSITION. Another way is performing each adjustment manually.

Perform the Automatic set-up first when the monitor is connected to a new computer, or resolution is changed. If the screen has a flicker or blur, or the picture does not fit in the display area after performing the Automatic set-up, manual adjustments are required. Both adjustments should be made by using the screen adjustment pattern (Test.bmp) obtained via the iiyama web site (<http://www.iiyama.com> or <http://www.iiyama.co.uk>).

This manual explains adjustment under Windows 95/98/2000/Me/XP.

- ① **Set the IMAGE SIZE feature to NORMAL and display the picture at the optimum resolution.**
- ② **Enter the Test.bmp (screen adjustment pattern) to wallpaper.**

NOTE

- Consult the appropriate documentation for doing this.
- Test.bmp is made at resolution of 2048 × 1536. Set the display position to center in the wallpaper setting dialogue box. If you use Microsoft® PLUS! 95/98 cancel the setting of "Stretch desktop wallpaper to fit the screen".

[Adjustment pattern]

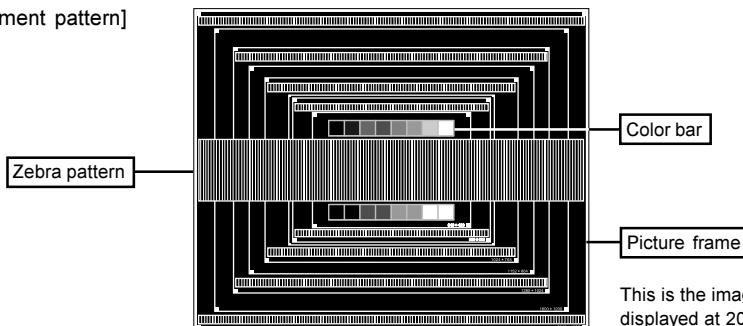

- ③ Select **AUTO** in **IMAGE SET-UP** and perform the Automatic set-up.
Or press the ◀ and ▶ Buttons at the same time when the Menu is not displayed.
(Direct adjustment)
- ④ Adjust the image manually by following procedure below when the screen has a flicker or blur, or the picture does not fit in the display area after performing the Automatic set-up.
- ⑤ Adjust the **V-POSITION** so that the top and bottom of the picture frame will fit to the display area.

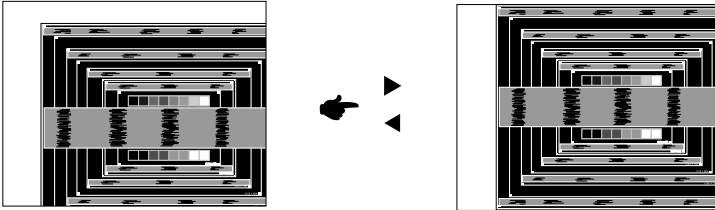

- ⑥ 1) Adjust the **H-POSITION** so that the left side of the picture frame will move to the left edge of the display area.

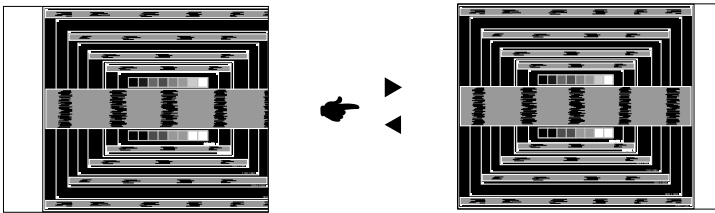

- 2) Stretch the right side of the picture frame to the right edge of the display area by adjusting the **COARSE** in **IMAGE SET-UP**.

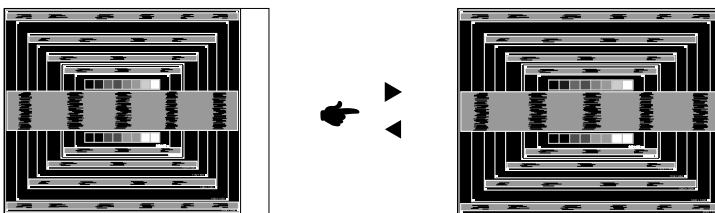

- NOTE**
- When the left side of the picture frame moves apart from the left edge of the display area during the **COARSE** adjustment, adjust steps 1) and 2).
 - Another way to make the **COARSE** adjustment is to correct the vertical wavy lines in the zebra pattern.
 - The picture may flicker during the **COARSE**, **H-POSITION** and **V-POSITION** adjustment.
 - In case the picture frame is bigger or smaller than the data display area after the **COARSE** adjustment, repeat steps from ③.

- ⑦ Adjust the FINE in IMAGE SET-UP to correct horizontal wavy noise, flicker or blur in the zebra pattern.

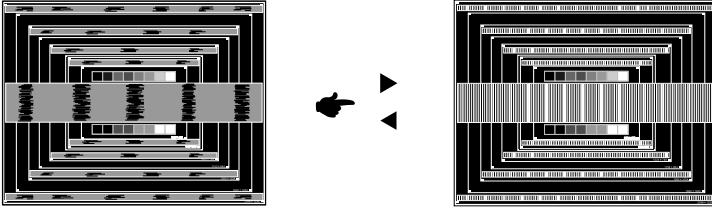

- NOTE**
- In case the strong flicker or blurs remain on a part of the screen, repeat steps ⑥ and ⑦ because the COARSE may not be adjusted correctly. If the flicker or blurs still remain, set the refresh rate of computer to low (60Hz) and repeat steps from ③ again.
 - Adjust the H-POSITION after the FINE adjustment if the horizontal position moves during the adjustment.

- ⑧ Adjust the BRIGHTNESS and COLOR to get the desired picture after you complete the FINE and COARSE adjustments.
Put back your favorite wallpaper.

POWER MANAGEMENT FEATURE

The power management feature of this product automatically reduces unnecessary power consumption of the monitor when your computer is not in use.

To use the feature, the monitor needs to be connected to a VESA DPMS compliant computer. There is a power management step the monitor takes as described below. The power management function, including any timer settings is configured by the operating system. Check your operating system manual for information on how this can be configured.

■ Power Management Mode

When the H-sync signal / V-sync signal / H and V sync signals from the computer are off, the monitor enters into Power Management Mode which reduces the power consumption to less than 13.5W. The screen becomes dark, and the power indicator turns to orange. From Power Management Mode, the image reappears in several seconds when either the keyboard or the mouse are touched again.

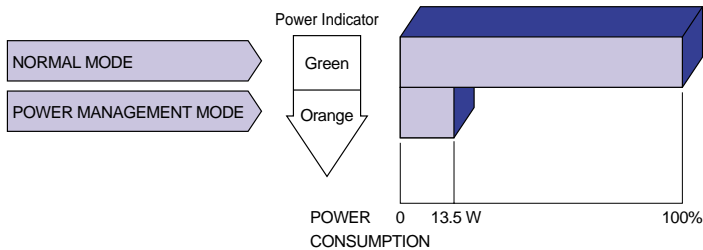

NOTE

- Even when using the power management mode, the monitor consumes electricity. Turn off the Power Switch whenever the monitor is not in use, during the night and weekends, to avoid unnecessary power consumption.
- It is possible that the video signal from the computer may be on while the H or V sync signal is missing. In this instance, the POWER MANAGEMENT feature may not work properly.

TROUBLE SHOOTING

If the monitor fails to operate correctly, please follow the steps below for a possible solution.

1. Perform the adjustments described in OPERATING THE MONITOR, depending on the problem you have.
2. Consult the following items if you cannot find an appropriate adjustment item in OPERATING THE MONITOR or if the problem persists.
3. If you are experiencing a problem which is not described below or you cannot correct the problem, discontinue using the monitor and contact your dealer or iiyama service center for further assistance.

Problem

Check

- ① The picture does not appear.

(Power indicator does not light up.)

- The AC Adapter cable is firmly connected.
- The Power Cable is firmly seated in the socket.
- The Power Switch is turned ON.
- The AC socket is live. Please check with another piece of equipment.

(Power indicator is green.)

- If the blank screen saver is in active mode, touch the keyboard or the mouse.
- Increase the Contrast and/or Brightness.
- The computer is ON.
- The Signal Cable is properly connected.
- The signal timing of the computer is within the specification of the monitor.

(Power indicator is orange.)

- If the monitor is in power management mode, touch the keyboard or the mouse.
- If the input signal selection is different, switch the INPUT SELECTION.
- The computer is ON.
- The Signal Cable is properly connected.
- The signal timing of the computer is within the specification of the monitor.

- ② The screen is not synchronized.

- The Signal Cable is properly connected.
- The signal timing of the computer is within the specification of the monitor.
- The video output level of the computer is within the specification of the monitor.

- ③ The screen position is not in the center.

- The signal timing of the computer is within the specification of the monitor.

- ④ The screen is too bright or too dark.

- The video output level of the computer is within the specification of the monitor.

- ⑤ The screen is shaking.

- The power voltage is within the specification of the monitor.
- The signal timing of the computer is within the specification of the monitor.

APPENDIX

SPECIFICATIONS

LCD Panel	Driving system	TFT
	Size	Diagonal: 52.8cm / 20.8"
	Pixel pitch	0.207mm H × 0.207mm V
	Brightness	235cd/m ² (Typical)
	Contrast ratio	300 : 1 (Typical)
	Viewable angle	Right / Left / Up / Down: 85 degrees each (Typical)
	Response time	50ms typical, 68ms maximum (Black, white, black)
Display Colors		16,777,216 maximum
Sync Frequency		Horizontal: 31.5-96.0kHz, Vertical: 60-75Hz
Dot Clock		239MHz maximum
Maximum Resolution		2048 × 1536
Input Connector		D-Sub mini 15pin DVI-I 29pin
Plug & Play		VESA DDC2B™
Input Sync Signal		Separate sync: TTL, Positive or Negative Composite sync: TTL, Positive or Negative
Input Video Signal		Analog: 0.7Vp-p (Standard), 75Ω, Positive Digital: DVI (Digital Visual Interface standard Rev.1.0) compliance
Maximum Screen Size		423.9mm W × 318.0mm H / 16.7" W × 12.5" H
Power Source		AC Adapter (Accessory): 100-230VAC, 50/60Hz, 2.5A (Output: 12VDC, 8.33A) Monitor: 12VDC, 6.9A
Power Consumption		100W maximum Power management mode: 13.5W maximum
Dimensions / Net Weight		472 × 419-529 × 241mm / 18.6 × 16.5-20.8 × 9.5" (W×H×D), 9.5kg / 20.9lbs
Tilt Angle		Right / Left: 35 degrees each, Up: 35 degrees
Environmental Considerations		Operative temperature: 10 to 35°C / 50 to 95°F Storage temperature: -20 to 60°C / -4 to 140°F Humidity (-20 to under 50°C / -4 to under 122°F) : 20 to 80% (No condensation) Humidity (50 to 60°C / 122 to 140°F) : 20 to 55% (No condensation)
Approvals		CE, TÜV-GS / MPR III (prEN50279) / ISO 13406-2, FCC-B, UL / C-UL, VCCI-B

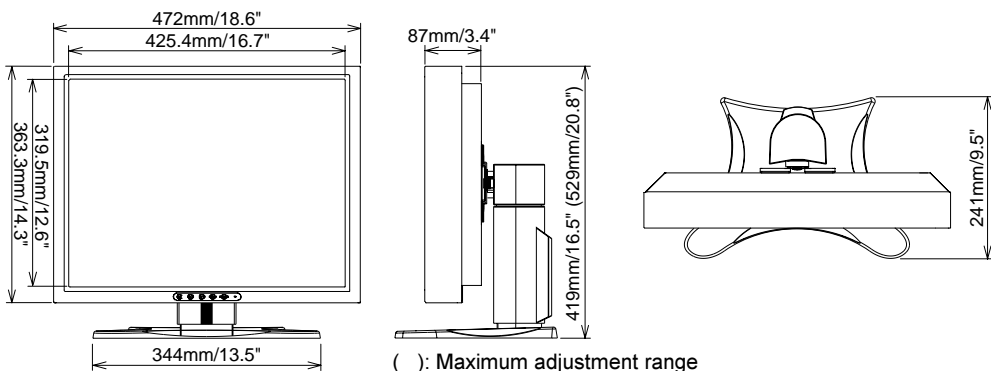

() : Maximum adjustment range

COMPLIANT TIMING

Video Mode		Horizontal Frequency	Vertical Frequency	Dot Clock	
DOS	640 × 350*1,2		31.47kHz	70.00Hz	25.17MHz
	640 × 480		31.47kHz	60.00Hz	25.18MHz
	720 × 400*2		31.47kHz	70.08Hz	28.32MHz
VESA	VGA	640 × 480	37.86kHz	72.80Hz	31.50MHz
			37.50kHz	75.00Hz	31.50MHz
	SVGA	800 × 600	37.88kHz	60.32Hz	40.00MHz
			48.08kHz	72.19Hz	50.00MHz
			46.86kHz	75.00Hz	49.50MHz
	XGA	1024 × 768	48.36kHz	60.00Hz	65.00MHz
			56.48kHz	70.10Hz	75.00MHz
			60.02kHz	75.00Hz	78.75MHz
	SXGA	1152 × 864 1280 × 1024	67.50kHz	75.00Hz	108.00MHz
			64.00kHz	60.00Hz	108.00MHz
			80.00kHz	75.00Hz	135.00MHz
	UXGA	1600 × 1200	75.00kHz	60.00Hz	162.00MHz
87.50kHz			70.00Hz	189.00MHz	
93.75kHz			75.00Hz	202.50MHz	
Macintosh	640 × 480		35.00kHz	67.00Hz	30.24MHz
	832 × 624		49.72kHz	74.55Hz	57.29MHz
	1024 × 768		60.24kHz	74.93Hz	80.00MHz
	1152 × 870		68.68kHz	75.06Hz	100.00MHz
SUN66	1152 × 900		61.84kHz	66.00Hz	94.50MHz
SXGA	1280 × 1024		75.83kHz	71.53Hz	128.00MHz
			81.18kHz	76.16Hz	135.09MHz
QXGA	2048 × 1536		96.00kHz	60.00Hz	238.85MHz

NOTE *1 The vertical screen size cannot be adjusted to the full screen.

*2 The screen is stretched vertically because the screen size ratio is not 4:3.

CONNECTOR PIN ASSIGNMENT

■ D-Sub mini 15pin Connector

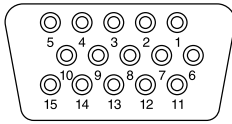

D-SUB

Pin	Input Signal	Pin	Input Signal
1	Red video	9	+5V
2	Green video	10	Ground
3	Blue video	11	Ground
4	Ground	12	Data line (SDA)*
5	Ground	13	H-Sync / HV-Sync
6	Red video ground	14	V-Sync
7	Green video ground	15	Clock line (SCL)*
8	Blue video ground		* Compliant to VESA DDC.

■ DVI-I 29pin Connector

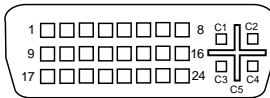

DVI-I

Pin	Input Signal	Pin	Input Signal
1	T.M.D.S Data 2-	16	Hot Plug Detect
2	T.M.D.S Data 2+	17	T.M.D.S Data 0-
3	T.M.D.S Data 2/4 Ground	18	T.M.D.S Data 0+
4	T.M.D.S Data 4-	19	T.M.D.S Data 0/5 Ground
5	T.M.D.S Data 4+	20	T.M.D.S Data 5-
6	Clock line (SCL) *	21	T.M.D.S Data 5+
7	Data line (SDA) *	22	T.M.D.S Clock Ground
8	Analog V-Sync	23	T.M.D.S Clock +
9	T.M.D.S Data 1-	24	T.M.D.S Clock -
10	T.M.D.S Data 1+	C1	Analog Red
11	T.M.D.S Data 1/3 Ground	C2	Analog Green
12	T.M.D.S Data 3-	C3	Analog Blue
13	T.M.D.S Data 3+	C4	Analog H-Sync
14	+5V Power	C5	Analog Ground
15	Ground		* Compliant to VESA DDC.

Free Manuals Download Website

<http://myh66.com>

<http://usermanuals.us>

<http://www.somanuals.com>

<http://www.4manuals.cc>

<http://www.manual-lib.com>

<http://www.404manual.com>

<http://www.luxmanual.com>

<http://aubethermostatmanual.com>

Golf course search by state

<http://golfingnear.com>

Email search by domain

<http://emailbydomain.com>

Auto manuals search

<http://auto.somanuals.com>

TV manuals search

<http://tv.somanuals.com>