



# IHS1 *IHT3807DT* INSTRUCTION MANUAL



# Warnings and Precautions

---

TO PREVENT FIRE OR SHOCK HAZARDS, DO NOT EXPOSE THIS UNIT TO RAIN OR MOISTURE. DO NOT EXPOSE TO DRIPPING OR SPLASHING. NEVER PLACE LIQUID FILLED OBJECTS, SUCH AS VASES, ON THE UNIT.



This symbol, located on back or bottom of the unit, is intended to alert the user to the presence of uninsulated “dangerous voltage” within the product’s enclosure that may be of sufficient magnitude to constitute a risk of electric shock to persons.



This symbol, located on back or bottom of the unit, is intended to alert the user to the presence of important operating and maintenance (servicing) instructions in the literature accompanying the appliance.

**CAUTION:** TO PREVENT ELECTRIC SHOCK, MATCH WIDE BLADE OF PLUG TO WIDE SLOT, FULLY INSERT.

To reduce the risk of electric shock, do not remove cover (or back). There are no user-serviceable parts inside. Please refer any servicing to qualified service personnel.

**CAUTION:** FOR CONTINUED PROTECTION AGAINST RISK OF FIRE, ONLY REPLACE T1.6L/250V FUSE WITH EQUIVALENT TYPE AND VOLTAGE.

**WARNING:** Changes or modifications to this unit not expressly approved by the party responsible for compliance could void the user’s authority to operate the equipment.

**WARNING:** Use of this unit near fluorescent lighting may cause interference regarding use of the remote. If the unit is displaying erratic behavior move away from any fluorescent lighting, as it may be the cause.

**NOTE:** This equipment has been tested and found to comply with the limits for a Class B digital device, pursuant to Part 15 of the FCC Rules. These limits are designed to provide reasonable protection against harmful interference in a residential installation. This equipment generates, uses, and can radiate radio frequency energy and, if not installed and used in accordance with the instructions, may cause harmful interference to radio communications. However, there is no guarantee that interference will not occur in a particular installation. If this equipment does cause harmful interference to radio or television reception, which can be determined by turning the equipment off and on, the user is encouraged to try to correct the interference by one or more of the following measures:

- Reorient or relocate the receiving antenna.
- Increase the separation between the equipment and receiver.
- Connect the equipment into an outlet on a circuit different from that to which the receiver is connected.
- Consult the dealer or an experienced radio/TV technician for help.

Operation of this device is subject to the following two conditions. (1) This device may not cause harmful interference, and (2) this device must accept any interference received, including interference that may cause undesired operation.

# Important Safety Instructions

---

1. Read these instructions.
2. Keep these instructions.
3. Heed all warnings.
4. Follow all instructions.
5. Do not use this apparatus near water.
6. Clean only with dry cloth.
7. Do not block any ventilation openings. Install in accordance with the manufacturer's instructions.
8. Do not install near any heat sources such as radiators, heat registers, stoves, or other apparatus (including amplifiers) that produce heat.
9. Do not defeat the safety purpose of the polarized or grounding-type plug. A polarized plug has two blades with one wider than the other. A grounding type plug has two blades and a third grounding prong. The wide blade or the third prong is provided for your safety. If the provided plug does not fit into your outlet, consult an electrician for replacement of the obsolete outlet.
10. Protect the power cord from being walked on or pinched particularly at plugs, convenience receptacles, and the point where they exit from the apparatus.
11. Only use attachments/accessories specified by the manufacturer.
12. Use only with the cart, stand, tripod, bracket, or table specified by the manufacturer, or sold with the apparatus. When a cart is used, use caution when moving the cart/apparatus combination to avoid injury from tip-over.



13. Unplug this apparatus during lightning storms or when unused for long periods of time.
14. Refer all servicing to qualified service personnel. Servicing is required when the apparatus has been damaged in any way, such as power-supply cord or plug is damaged, liquid has been spilled or objects have fallen into the apparatus, the apparatus has been exposed

---

*continued*

# Important Safety Instructions

---

15. Only connect to the type of house-hold power supply as indicated in the operating instructions and rating label.
16. Do not overload wall outlets or extension cords as this can result in a risk of fire or electric shock.
17. Never push objects of any kind or spill liquid into this product through openings as this could result in a risk of fire or electric shock.
18. When replacement parts are required, be sure the service technician has used replacement parts specified by the manufacturer. Ask the service technician to perform safety checks to ensure proper operation to avoid possible fire, electric shock, or other hazards.
19. If an outside antenna or cable system is connected to the product, be sure the antenna or cable system is grounded so as to provide some protection against voltage surges and built-up static charges. Article 810 of the National Electrical Code, ANSI/NFPA 70, provides information with regard to proper grounding of the mast and supporting structure, grounding of the lead-in wire to an antenna connection to grounding electrodes, and requirements for the grounding electrode.

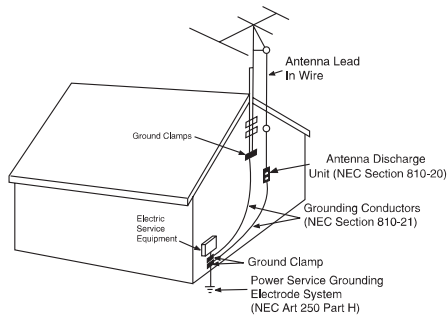

20. The product should be mounted to a wall or ceiling only as recommended by the manufacturer.
21. Where the AC plug or an appliance coupler is used as the disconnect device, the disconnect device shall remain readily operable.

# Features

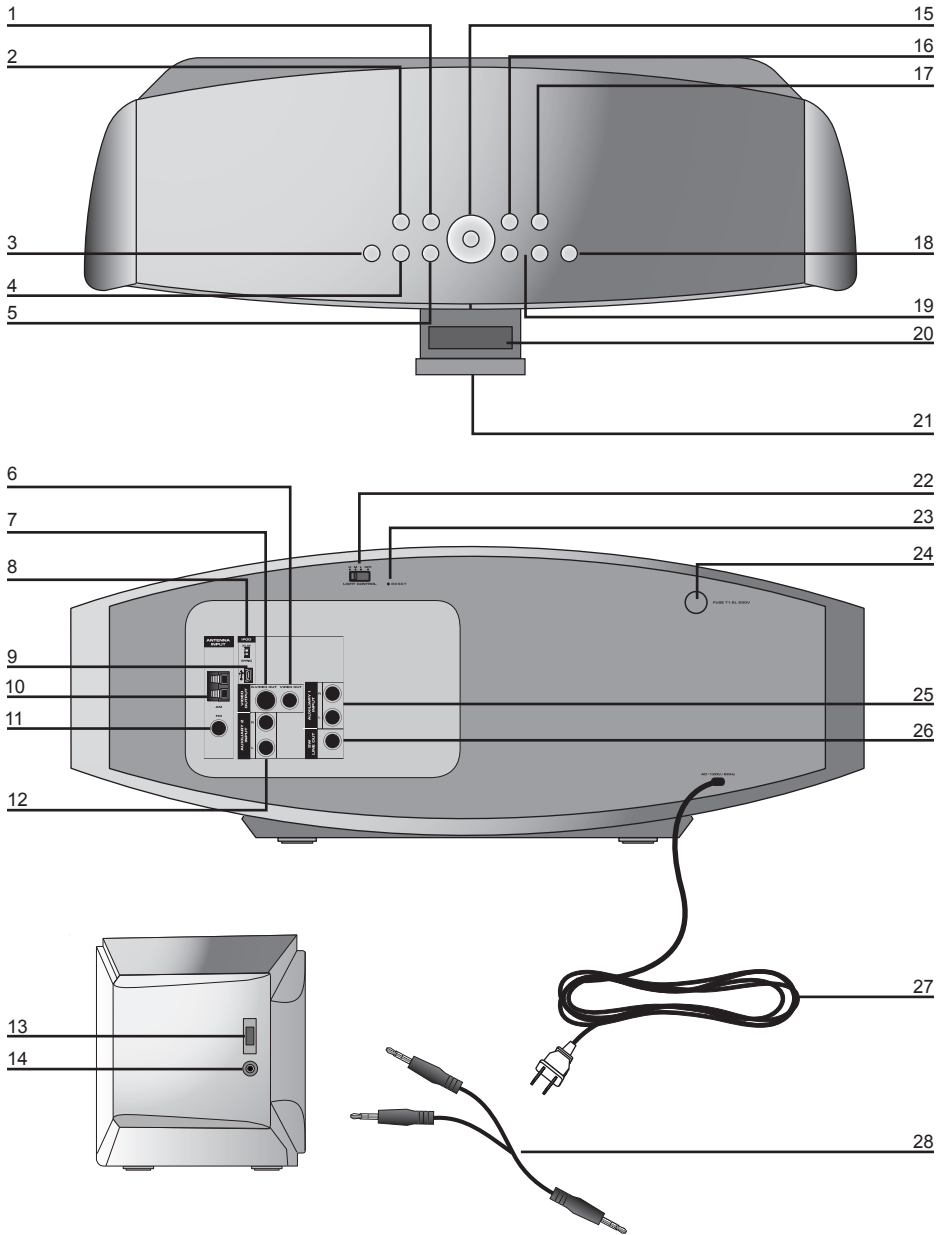

# Features

---

- 1 **MENU** Press the M button to enter the menu on an iPod.

---

- 2 **FUNCTION** Press the F button to switch between iPod, radio, and aux input control.

---

- 3 **POWER** Press the POWER button to turn the player on or off.

---

- 4 **PLAY/PAUSE** Press the PLAY/PAUSE button to play or pause an iPod.

---

- 5 **EQ** Press the EQ button to switch equalizer modes between Classic, Jazz, Rock, Pop, Flat, SRS TruBass®, 3D.

---

- 6 **Video Out** Connect a video cable to the Video Output connection to send a video signal from a Video iPod to a display (TV) with a Video Input. (video cable not included)

---

- 7 **S-Video Output** The S-Video Output is an analog video output which allows the video data to be split into two separate signals, brightness and color.

---

- 8 **iPod** When the included USB cord is connected, use this toggle switch to change control between the unit (PLAY) and a computer (SYNC).

---

- 9 **Mini-USB** Use this Mini-USB port to connect the unit to a computer and syncs your iPod directly from the player's docking station.

---

- 10 **AM Antenna Port** Connection for the AM detachable antenna, which provides flexibility and range when adjusting the AM reception.

---

- 11 **FM Antenna Port** Connection for the FM detachable and extendable antenna, which provides flexibility and range when adjusting the FM reception.

---

- 12 **AUX 2** Use the AUX 2 jack to connect an audio device to the player.

---

- 13 **iPOD SHUFFLE** Use the iPOD SHUFFLE port to connect a first generation iPod shuffle to the player.

---

- 14 **Headphone Jack** Use the Headphone Jack to plug in a set of headphones (not included).

---

- 15 **Navigation Controls/SELECT** Use the Navigation Controls to move through an iPod menu system, or change the radio station. Press the center SELECT button to select a song, photo, or video on your iPod, or when the power is off, use the SELECT button to set the clock.





---

# Features

---

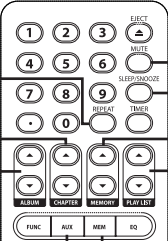
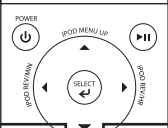
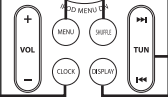
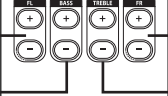
- 16 TIMER** Press the T button to set the player to turn on or off at a certain time.
- 
- 17 SLEEP** Press the S button have the player turn off after an elapsed period of time. (5 to 90 minutes)
- 
- 18 OPEN/CLOSE** Press the OPEN/CLOSE button to extend and retract the motorized iPod dock.
- 
- 19 VOLUME** Press the (+) button to increase the volume and the (-) button to decrease the volume.
- 
- 20 iPod Motorized Docking Station** Select the correct insert and connect your iPod, iPod mini, or iPod nano.
- 
- 21 LCD Display** View the Time, PM Indicator, iPod Indicator, Aux Indicator and Radio Frequency through this Liquid Crystal Display.
- 
- 22 Light Control** Switch to adjust the button lights between Hi, Medium, Low, and Off.
- 
- 23 Reset** Press the RESET button using a paperclip or like object to restore factory default settings on the unit.
- 
- 24 Fuse** (T1.6L/250V Fuse) If this fuse is blown, unplug the unit and replace it with an equivalent type.
- 
- 25 AUX 1** Use the AUX 1 (auxiliary) jack to connect an iPod shuffle or other audio devices to the player.
- 
- 26 Sub-Woofers Line Out** Use the SW Line-out to connect the unit to an external Subwoofer.
- 
- 27 AC Cord** (AC 120V / 60 Hz) The attached AC Cord provides power to the player.
- 
- 28 Line-In Cord** Use the Line-In Cord to connect the unit to external audio devices.
-

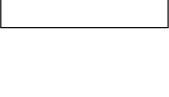
# Peripherals

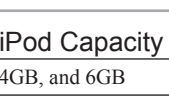
29		37
30		38
31		39
32		40
33		41
34		42
35		43
36		44
		45
		46

# iPod Inserts

Model	#	iPod Capacity
iPod mini	3	4GB, and 6GB
iPod	4	20GB, and U2 Special Edition
	5	40GB
iPod with color display	6	20GB, 30GB, and U2 Special Edition
	7	40GB
iPod nano	8	1GB, 2GB, and 4GB
	9	30GB
iPod with video	10	60GB, and 80GB
	11	2GB, 4GB, and 8GB



## Peripherals Defined

---

- 29 REPEAT** Press the REPEAT button to set an iPod to repeat one song, or all songs.
- 
- 30 CHAPTER** Press up on the CHAPTER button to increase the chapter number, or press down on the CHAPTER button to decrease the chapter number.
- 
- 31 ALBUM** Press up or down on the ALBUM button to cycle through the iPod's albums.
- 
- 32 AUX** Press the AUX button to switch the player to AUX mode.
- 
- 33 MENU** Press the MENU button to enter the menu on an iPod.
- 
- 34 CLOCK** With the power off, press the CLOCK button to set the clock.
- 
- 35 FL** Press the FL buttons to adjust the volume of the player's left speaker.
- 
- 36 BASS** Press the BASS buttons to adjust the bass level.
- 
- 37 MUTE** Press the MUTE button to decrease the volume entirely.
- 
- 38 SLEEP/SNOOZE** Press the SLEEP/SNOOZE button to set the sleep timer (5 - 90 minutes), or activate the snooze (5 minutes) after the alarm has gone off.
- 
- 39 MEMORY** Press the MEMORY buttons to cycle up and down through preset radio stations.
- 
- 40 PLAYLIST** Press up on the PLAYLIST button to cycle up through the playlists on an iPod, or press down on the PLAYLIST button to cycle down through the playlists on an iPod.
- 
- 41 MEM** Press the MEM button and select a preset to save stations to the unit's memory.
- 
- 42 SHUFFLE** Press the SHUFFLE button to randomly play songs on an iPod.
- 
- 43 TUN** Press the TUN button to cycle up or down through AM or FM radio frequencies.
- 
- 44 DISPLAY** Press the display button to cycle through the different items on the LCD Display.
- 
- 45 FR** Press the FR buttons to adjust the volume of the player's right speaker.
- 
- 46 TREBLE** Press the TREBLE buttons to adjust the treble level.
- 

*Buttons that are not defined in the Peripherals Defined section, are defined in the Features Defined section.*

---

# Operations

---

## Setting the Clock

- a. With the player off, press the SELECT button in the Navigation Controls.
- b. When the time begins to blink on the LCD Display, press the right button to cycle up through the hour and press the left button to cycle up through the minute.
- c. Wait 5 seconds, and the clock will be set with the specified time.

## Setting the Timer

- a. With the player off, press the TIMER button. Press the TIMER button again to cycle through the different timer options (timer ON, timer OFF, ON, and OFF).
- b. At the “timer on” or “timer off” functions (indicated by “ON” or “OFF” followed by a time) press the right button to cycle up through the hour and press the left button to cycle up through the minute.
- c. After the “timer on” and/or “timer off” functions are set, press the TIMER button until the LCD Display reads “ON” by itself. (“OFF” by itself indicates that the timer is deactivated)
- d. Wait for 5 seconds and the timer functions will be set with the specified time.

## Tuning the Radio

- a. Press the FUNCTION button consecutively to select the FM or AM radio mode.
- b. Tune to the desired station using the Navigation Controls on the unit or the TUN button on the remote.

## Saving Radio Stations to the Memory

- a. Press the FUNCTION button consecutively to select the FM or AM radio mode.
- b. Tune to the desired station using the Navigation Controls on the unit or the TUN button on the remote.
- c. Press the MENU button on the unit or the MEM button on the remote control.
- d. Press the Navigation Controls or the IPOD FWD/HR. and IPOD REV/MIN buttons to select a Preset to save the current station under.
- e. After the preset has been selected press the MENU or MEM button. The current radio frequency is now saved to the selected preset.

- *There are 20 FM and 10 AM memory presets on this unit.*

*Operations that are not listed in the operations section, are explained in the Features Defined or Peripherals Defined sections.*

---

# Operations

---

## Viewing Video or Photos from your iPod on an External Device

- a.** Connect a composite video cable from the player's video out jack to a composite video input jack on a TV. You can also connect the player to a TV with an S-Video cable.
- b.** Insert your iPod Video into the player and navigate to either the Photos or Videos on the iPod.
- c.** On the iPod, select either Slideshow Settings in Photos or Video Settings in Videos.
- d.** On the iPod, set the TV Out setting to On.
- e.** Press the FUNCTION button until the player's mode is set to IPOD, as indicated on the LCD Display.
- f.** Make sure your external viewing device is set to the proper input. You will now be able to control your iPod from the player's control panel and remote, and view your iPod on a video display.

## Connecting other Digital Audio Devices

- a.** Connect an audio device to the AUX 1 or AUX 2 inputs.
- b.** Press the FUNCTION button to set the unit to AUX 1 or AUX 2 mode, as indicated by the LCD Display.
- c.** The audio device will now play through the speakers of the player.



## Service Information

**Address** 2116 Carr Street, St. Louis MO, 63106

**Phone** 1-314-621-2881

**Fax** 1-314-588-1805

**Email** [customerservice@ilive.net](mailto:customerservice@ilive.net)

**Website** [www.ilive.net](http://www.ilive.net)

---

To download this Instruction Manual in English, Spanish, or French visit the Support section at [www.ilive.net](http://www.ilive.net).

Para descargar este manual de instrucción en inglés, español, o francés visite la sección de la ayuda en [www.ilive.net](http://www.ilive.net).

Pour télécharger ce manuel d'instruction en anglais, espagnol, ou le Français visitez la section de soutien à [www.ilive.net](http://www.ilive.net).

## Free Manuals Download Website

<http://myh66.com>

<http://usermanuals.us>

<http://www.somanuals.com>

<http://www.4manuals.cc>

<http://www.manual-lib.com>

<http://www.404manual.com>

<http://www.luxmanual.com>

<http://aubethermostatmanual.com>

Golf course search by state

<http://golfingnear.com>

Email search by domain

<http://emailbydomain.com>

Auto manuals search

<http://auto.somanuals.com>

TV manuals search

<http://tv.somanuals.com>