

# 1200S Network Series Portable Dryers

## Parts Manual

**PNEG-1447**  
Date: 10-12-2006



## Table of Contents

---

<b>MAIN STRUCTURE ASSEMBLY.....</b>	<b>5</b>
FRAME ASSEMBLY.....	5
FRAME, LOWER BASKET, AND METERING ROLLS.....	8
PLENUM (INSIDE) SCREENS AND METER ROLL UPPER SHIELD.....	12
OUTER SCREENS AND PLENUM DIVIDER.....	14
CLEAN OUT DOORS.....	16
FRONT AND REAR PLENUM END PANELS AND REAR ACCESS DOORS.....	18
LADDER ASSEMBLIES.....	20
BOTTOM AUGER.....	22
TOP AUGER WITH WET BIN.....	24
<b>AUGER AND METER ROLL DRIVE TRAINS.....</b>	<b>26</b>
BOTTOM AUGER DRIVE.....	26
TOP AUGER DRIVE.....	28
METER ROLL DRIVE.....	30
<b>FAN HEATERS.....</b>	<b>32</b>
FAN HOUSING ASSEMBLIES.....	32
FAN MOTOR, MOTOR MOUNT, AND FAN BLADE.....	34
AIR MIXERS.....	35
FLAME PROBE, IGNITOR, AND BURNER ASSEMBLIES.....	36
LP PIPE TRAIN ASSEMBLIES.....	38
NG PIPE TRAIN ASSEMBLIES.....	44
FAN HEATER ORIFICES.....	47
LP SUPPLY LINE.....	48
NG SUPPLY LINE.....	49
<b>DRYER ELECTRICAL CONDUITS.....</b>	<b>50</b>
RIGHT AND LEFT GRAIN, AND PLENUM HIGH LIMITS.....	50
LOWER JUNCTION BOXES, METER ROLL MOTOR CONDUIT, AND REAR DISCHARGE CONDUIT.....	52
UPPER JUNCTION BOX, TOP AUGER MOTOR CONDUIT, AND OPERATOR LIGHT.....	54
AIR SWITCH ASSEMBLY.....	55
<b>CONTROL BOXES.....</b>	<b>56</b>
NETWORK CONTROL BOX.....	56
FAN HEATER CONTROL BOX.....	58
LOWER CONTROL BOX CONTROL PANEL.....	60
LOWER CONTROL BOX CONTROL PANEL (INSIDE).....	61
LOWER CONTROL BOX BACK PANEL.....	62
UPPER CONTROL BOX.....	63
<b>NOTES.....</b>	<b>67</b>



Frame Assembly (view from fan/heater end with hitch weldment removed).

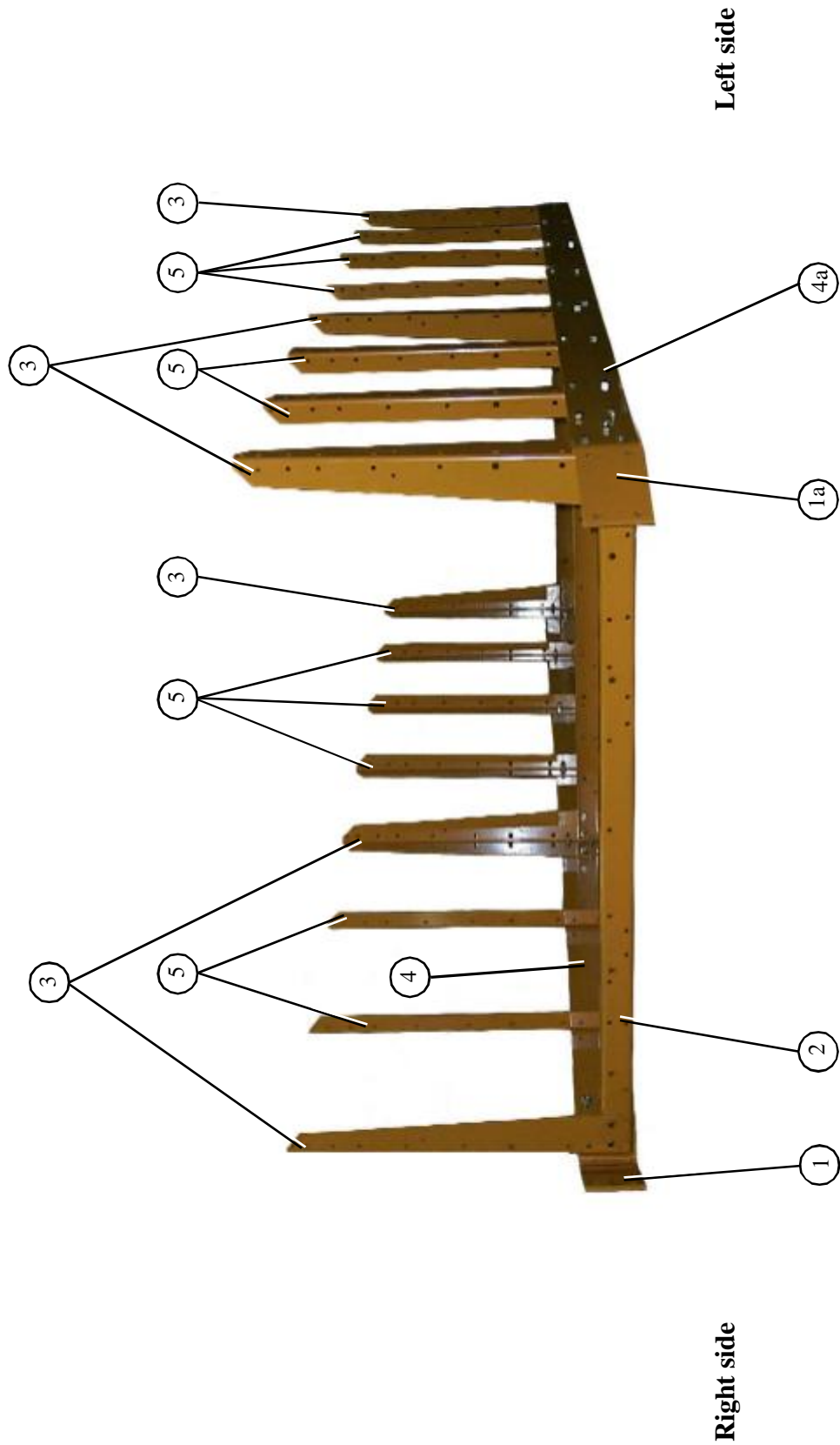

The fan heater end of the dryer is considered by GSI as the front end of the dryer (the foreground of this photograph is the front end. Right and left sides are labeled above).

**\*\*NOTE:** The parts pointed out on this page are listed on page 7.

## Frame

Right front corner of frame.

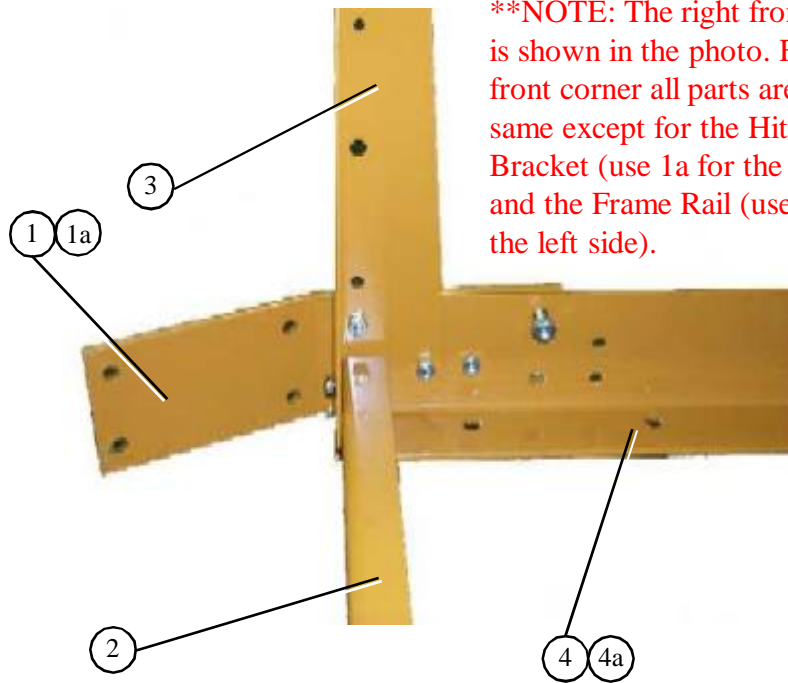

**\*\*NOTE:** The right front corner is shown in the photo. For left front corner all parts are the same except for the Hitch Bracket (use 1a for the left side), and the Frame Rail (use 4a for the left side).

Left rear corner of frame.

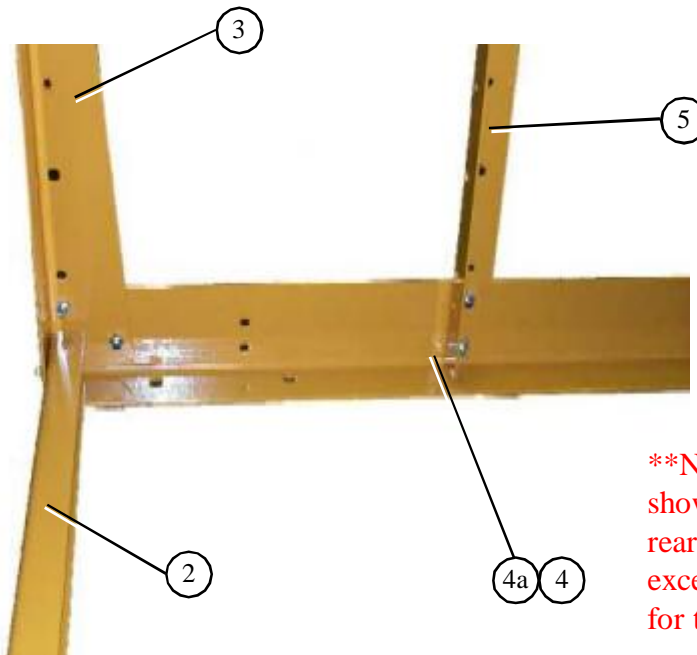

**\*\*NOTE:** The left rear corner is shown in the photo. For right rear corner all parts are the same except for the Frame Rail (use 4 for the right side).

## Frame

Center cross ties.

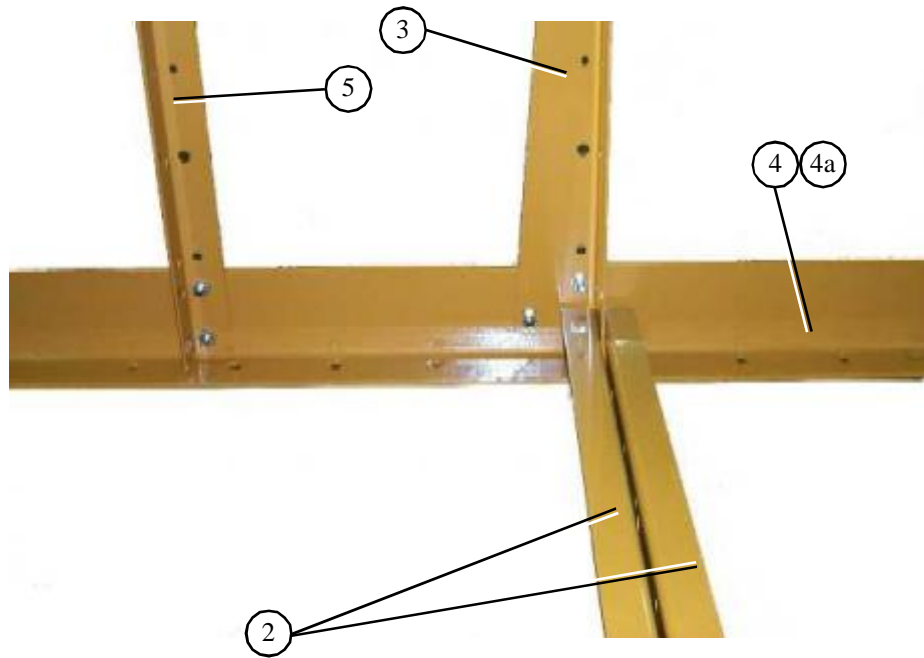

ITEM NUMBER	PART NUMBER	DESCRIPTION	1214S	1218S	1220S	1222S	1226S
1	D01-0012	HITCH BRACKET RIGHT	1	1	1	1	1
1a	D01-0011	HITCH BRACKET LEFT	1	1	1	1	1
2	D01-0008	FRONT & REAR FRAME TIE CHANNEL	4	4	4	6	6
3	D01-0007	CORNER LEG PORTABLE DRYER	6	6	6	8	8
4	D21-0011	FRAME RAIL, 14' RIGHT	1				
4a	D21-0010	FRAME RAIL, 14' LEFT	1				
4	D31-0044	FRAME RAIL, 18' RIGHT		1			
4a	D31-0043	FRAME RAIL, 18' LEFT		1			
4	D61-0002	FRAME RAIL, 20' RIGHT			1		
4a	D61-0001	FRAME RAIL, 20' LEFT			1		
4	D101-0002	FRAME RAIL, 22' RIGHT				1	
4a	D101-0001	FRAME RAIL, 22' LEFT				1	
4	D71-0001	FRAME RAIL, 26' RIGHT					1
4a	D71-0002	FRAME RAIL, 26' LEFT					1
5	D01-0005	SIDE LEG PORTABLE DRYER	10	14	16	16	20

Dryer frame and lower basket assembly (view from the front end of the dryer looking down the left side).

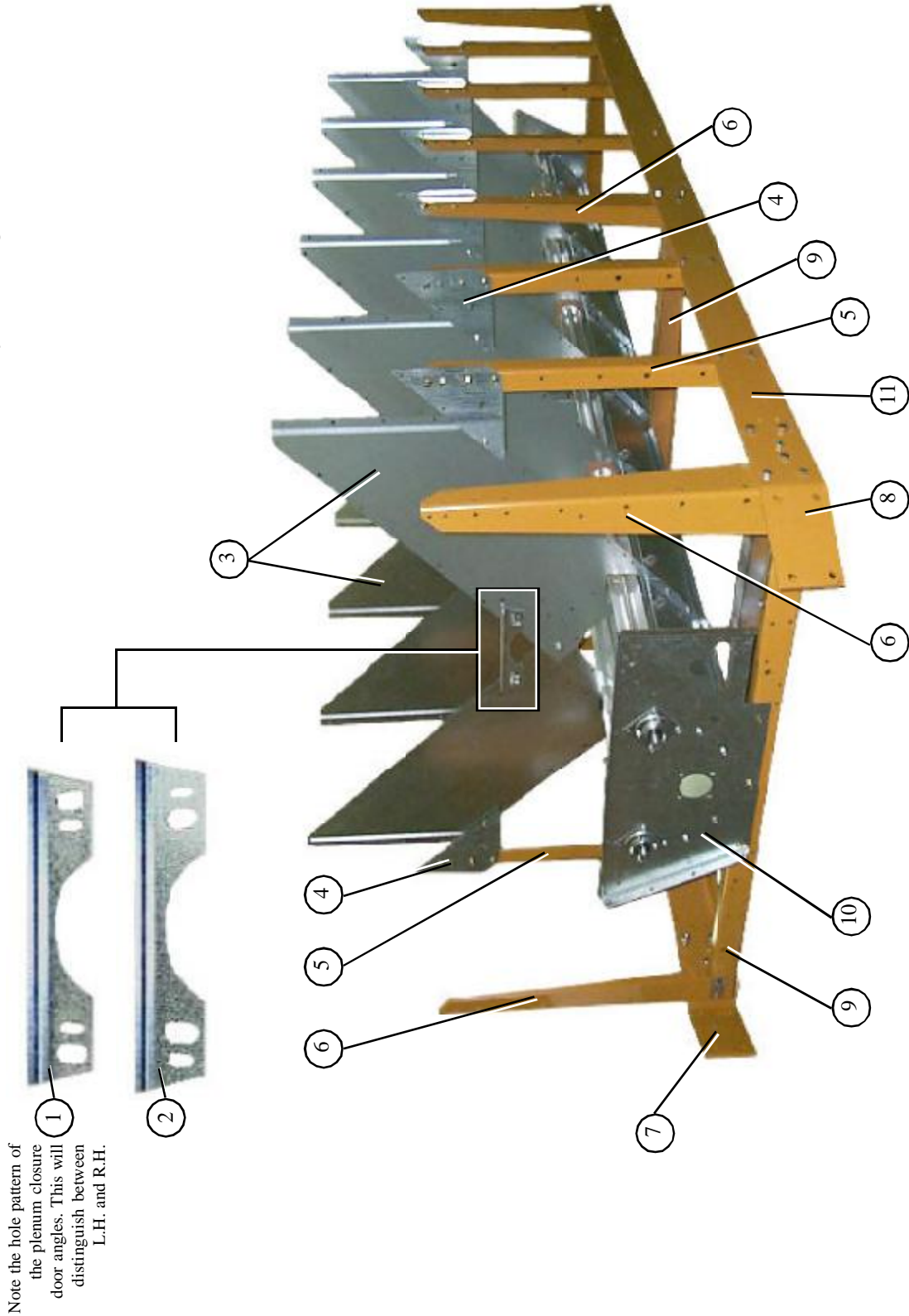

**\*\*NOTE:** The parts pointed out on this page are listed on page 11.

# Frame, Auger Trough, & Hopper Bulkheads

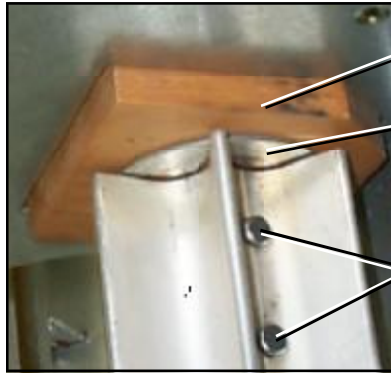

Wooden meter roll support bearing. The meter roll sections are spliced together with a meter roll splice shaft (part no. D31-0046) that passes through the support bearing assembly.

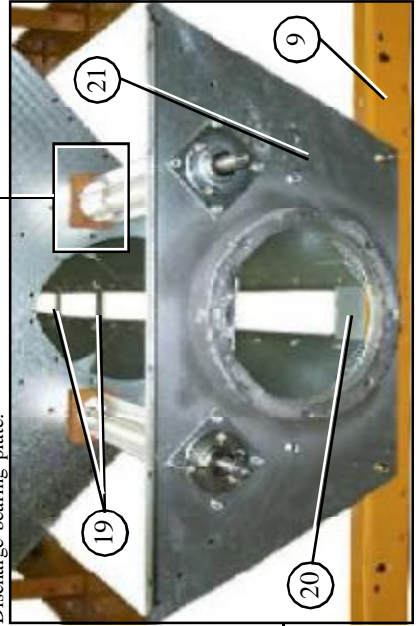

Discharge bearing plate.

Center hanger bearing support and cross channel seal plate.

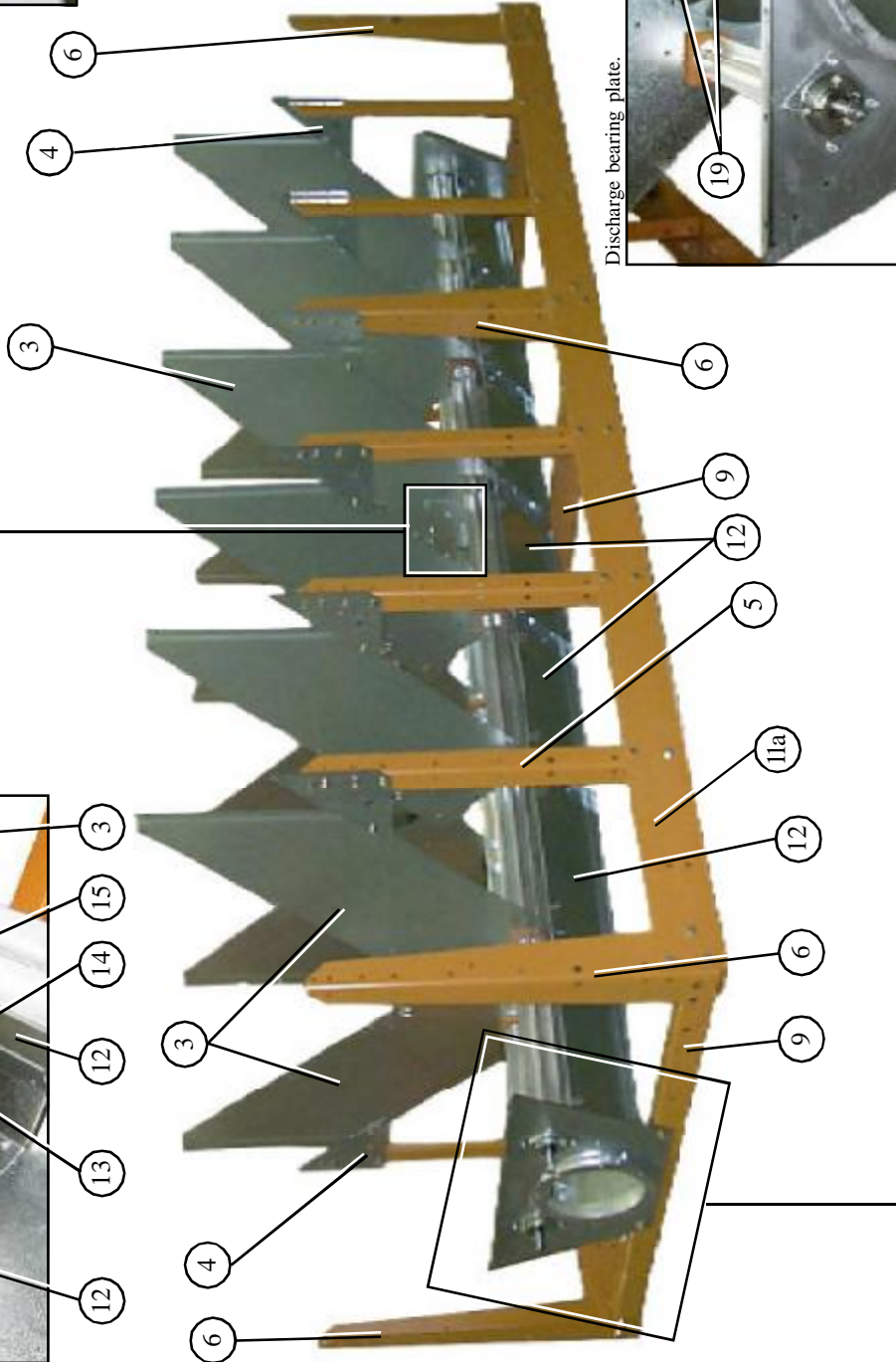
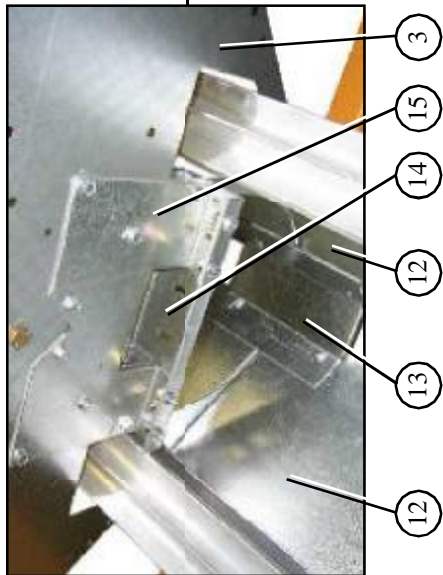

Dryer frame and lower basket assembly (view from the rear end of the dryer looking up the right side).

**\*\*NOTE: The parts pointed out on this page are listed on page 11.**



## Meter Rolls and Their Placement in the Dryer

Metering Rolls and their placement in the dryer.

**NOTE:** Item 22 at the rear of dryer is a front section meter roll that is used as a rear section on 16 and 20 foot dryers only.

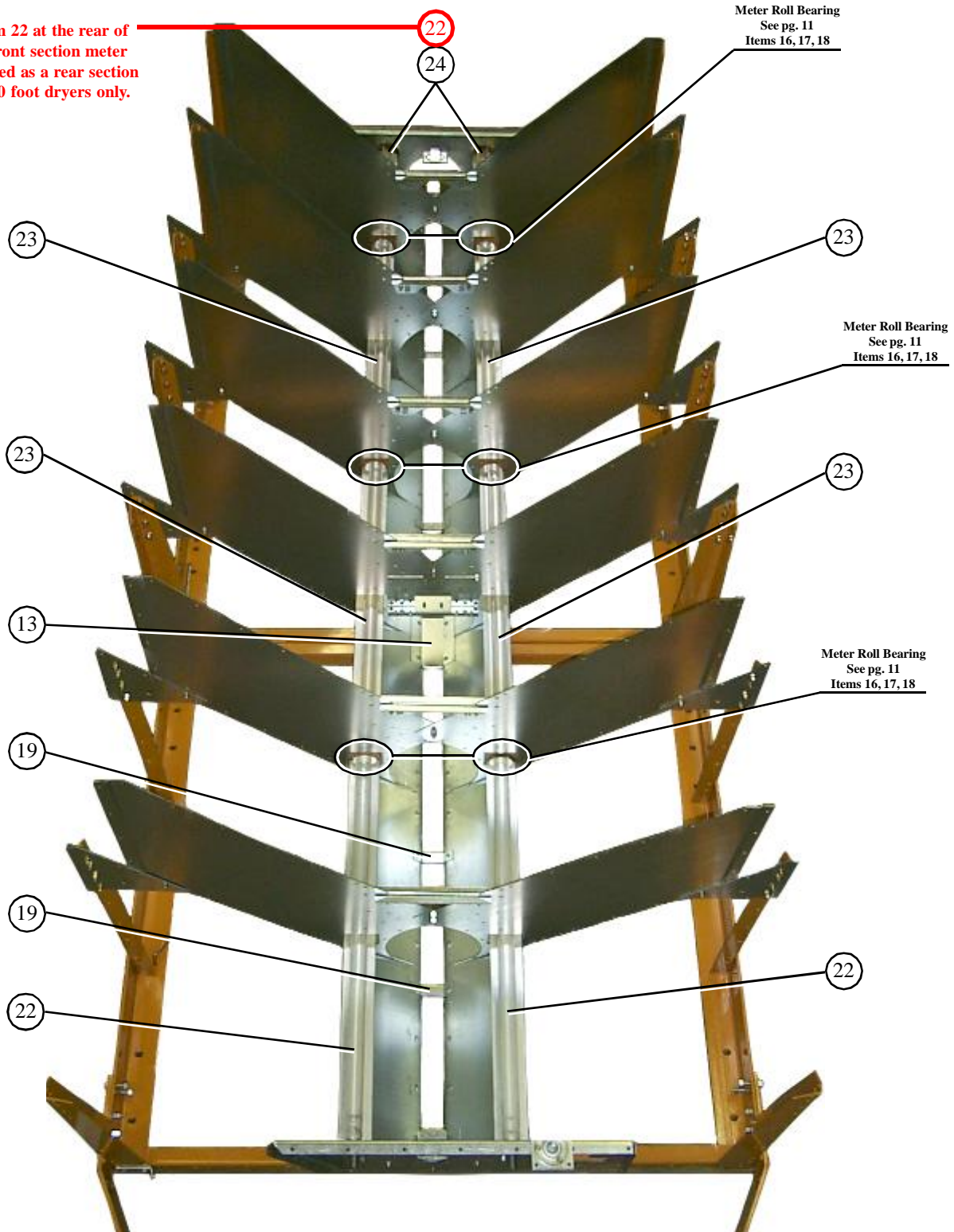

**This end is the front (fan/heater) end of the dryer.**

## Meter Rolls and Their Placement in the Dryer

ITEM NUMBER	PART NUMBER	DESCRIPTION	1214S	1218S	1220S	1222S	1226S
1	D01-1136Y	PLENUM CLOSURE DOOR ANGLE, RH	6	8	9	10	12
2	D01-1136X	PLENUM CLOSURE DOOR ANGLE, LH	7	9	10	11	13
3	D01-0109	HOPPER BULKHEAD	12	16	18	20	24
4	D01-0004	GUSSET PLATE	16	20	22	24	28
5	D01-0005	SIDE LEG	10	14	16	16	20
6	D01-0007	CORNER LEG	6	6	6	8	8
7	D01-0011	HITCH BRACKET, LH	1	1	1	1	1
8	D01-0012	HITCH BRACKET, RH	1	1	1	1	1
9	D01-0008	FRONT & REAR FRAME TIE CHANNEL	4	4	4	6	6
10	D01-1374	BOTTOM AUGER BEARING PLATE	1	1	1	1	1
11	D21-0011	FRAME RAIL, 14' RIGHT	1				
11	D31-0044	FRAME RAIL, 18' RIGHT		1			
11	D61-0002	FRAME RAIL, 20' RIGHT			1		
11	D101-0002	FRAME RAIL, 22' RIGHT				1	
11	D71-0001	FRAME RAIL, 26' RIGHT					1
11A	D21-0010	FRAME RAIL, 14' LEFT	1				
11A	D31-0043	FRAME RAIL, 18' LEFT		1			
11A	D61-0001	FRAME RAIL, 20' LEFT			1		
11A	D101-0001	FRAME RAIL, 22' LEFT				1	
11A	D71-0002	FRAME RAIL, 26' LEFT					1
12	D01-0048	TROUGH PANEL	14	18	20	22	26
13	D01-1512	PLATE, CROSS CHANNEL SEAL W/TABS	1	1	1	2	2
14	D01-1291	HANGER BEARING "C" CHANNEL	1	1	1	2	2
15	D01-1290	HANGER BEARING "J" PLATE	2	2	2	4	4
16	D02-0028	CLEVIS PIN 5/16" x 1 3/4"	32	40	40	48	56
17	D31-0148	METER ROLL WASHER	16	20	20	24	28
18	D02-0061	METER ROLL SUPPORT BEARING	6	8	8	10	12
19	D01-0177	SUPPORT STRAP	7	9	10	11	13
20	D01-1511	PLATE, END CHANNEL SEAL W/TAB	2	2	2	2	2
21	D31-0120	DISCHARGE PLATE	1	1	1	1	1
22	D31-0031	METER ROLL, FRONT	2	2	4	2	2
23	D31-0030	METER ROLL, INTERMEDIATE	4	6	6	8	10
24	D31-0029	METER ROLL, REAR	2	2		2	2

**The part number list above covers all parts pointed out on pages 8, 9, and 10.**

## Inside (Plenum) Screens, Plenum Closure Doors

Plenum screens and bulkheads (view from front end).

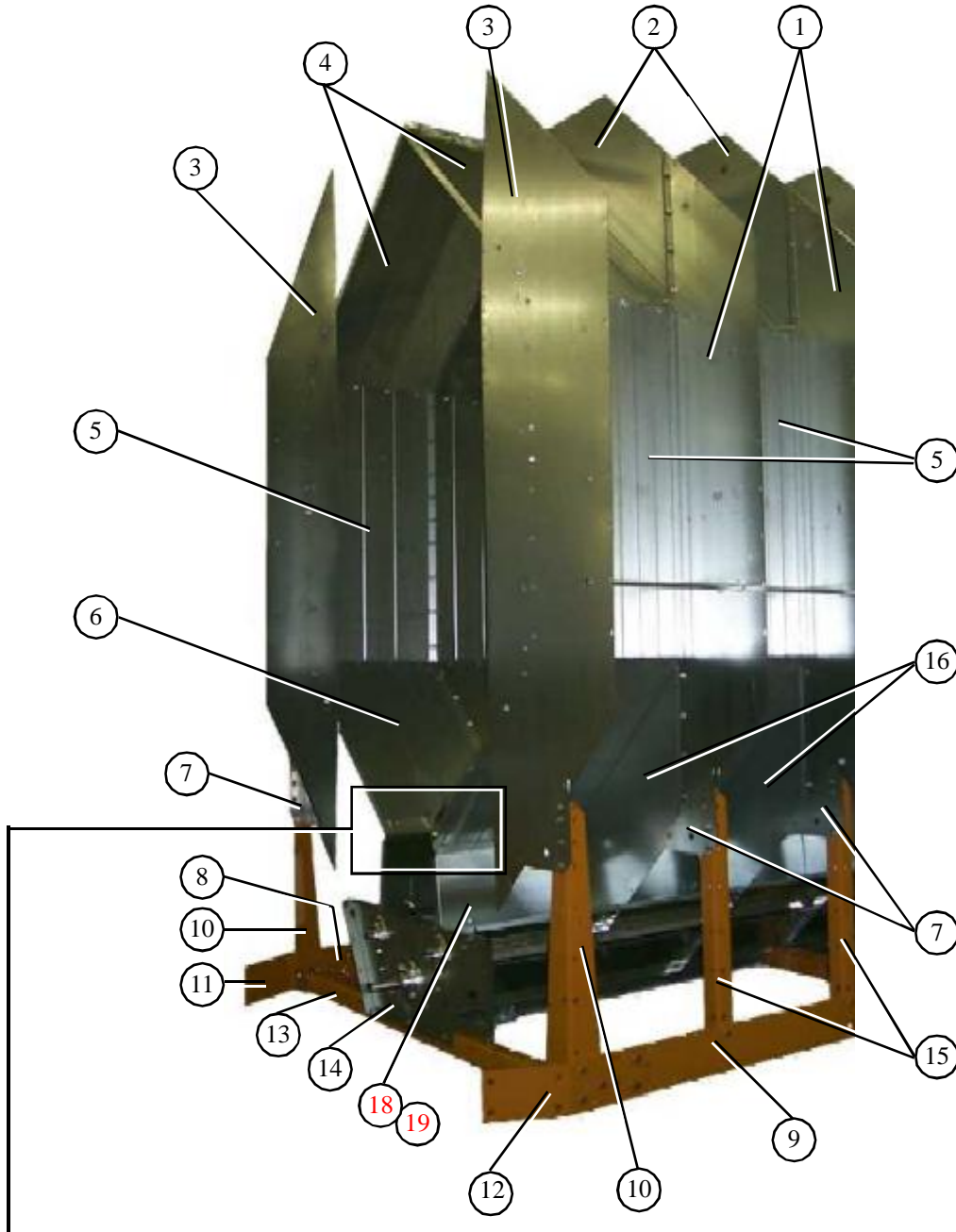

This photograph was taken before the front plenum end panel and outer screens were installed in order to get a good view of the inside screens and bulkheads.

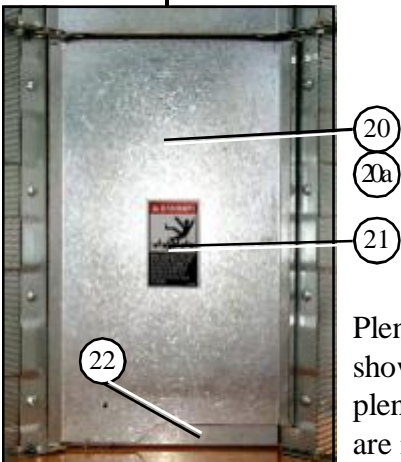

Plenum closure door. There are two different plenum closure doors. The door shown in the photograph is the rear plenum closure door and is the rear most plenum closure door, item no. 20 (just inside the rear access door), all others are item no. 20a. NOTE: Item 22 is the plenum closure door rear frame angle.

## Meter Roll Upper Shield Assembly

Close up of of meter roll upper shield assembly.

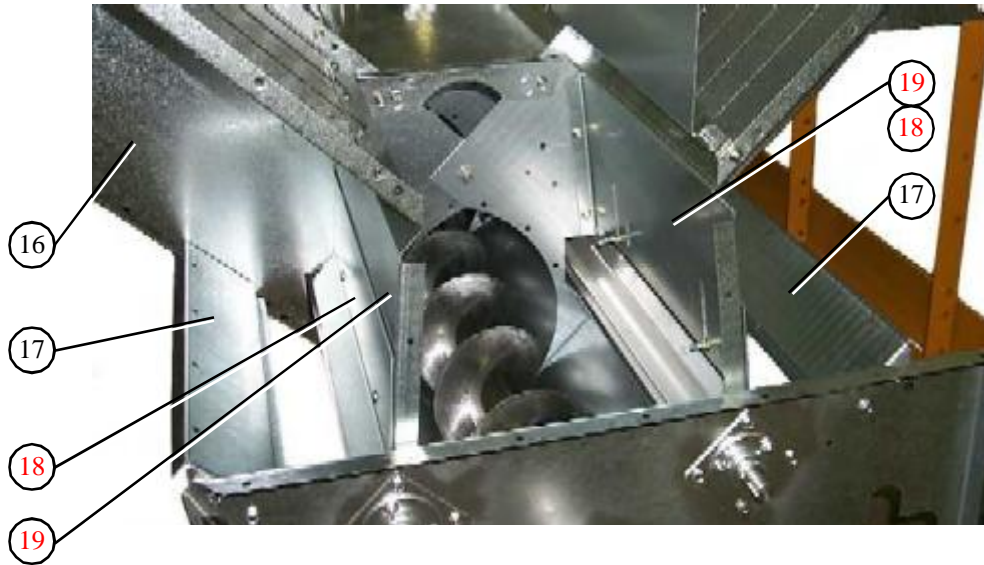

ITEM NUMBER	PART NUMBER	DESCRIPTION	1214S	1218S	1220S	1222S	1226S	
1	D31-0055	COLUMN BULK HEAD	12	16	18	20	24	
2	D01-0101	GARNER BULKHEAD	12	16	18	20	24	
3	D31-0307	COLUMN END PANEL	4	4	4	4	4	
4	D01-0126	SCREEN,PLENUM TOP,GA,094	14	18	20	22	26	
5	D31-0012	SCREEN,PLENUM WALL,GA,094	14	18	20	22	26	
6	D01-1225	SCREEN,PLENUM BOTTOM,GA,094	14	18	20	22	26	
7	D01-0004	GUSSET PLATE	16	20	22	24	28	
8	D21-0011	FRAME RAIL, 14' RIGHT	1					
8	D31-0044	FRAME RAIL, 18' RIGHT		1				
8	D61-0002	FRAME RAIL, 20' RIGHT			1			
8	D101-0002	FRAME RAIL, 22' RIGHT				1		
8	D71-0001	FRAME RAIL, 26' RIGHT					1	
9	D21-0010	FRAME RAIL, 14' LEFT	1					
9	D31-0043	FRAME RAIL, 18' LEFT		1				
9	D61-0001	FRAME RAIL, 20' LEFT			1			
9	D101-0001	FRAME RAIL, 22' LEFT				1		
9	D71-0002	FRAME RAIL, 26' LEFT					1	
10	D01-0007	CORNER LEG PORTABLE DRYER	6	6	6	8	8	
11	D01-0012	HITCH BRACKET RIGHT	1	1	1	1	1	
12	D01-0011	HITCH BRACKET LEFT	1	1	1	1	1	
13	D01-0008	FRONT & REAR FRAME TIE CHANNEL	4	4	4	6	6	
14	D01-1374	BOTTOM AUGER BEARING PLATE	1	1	1	1	1	
15	D01-0005	SIDE LEG PORTABLE DRYER	10	14	16	16	20	
16	D01-0109	HOPPER BULKHEAD	12	16	18	20	24	
17	D01-0050P	CONNECTOR SHEET, PERFORATED	14	18	20	22	26	
*18&19	D01-1180	METER ROLL UPPER SHIELD ASSY.	14	18	20	22	26	
18	D01-0431	METER ROLL STRIKE OFF PLATE	1 PER ASSEMBLY					
19	D01-1226	METER ROLL SHIELD 1995 STYLE	1 PER ASSEMBLY					
20	D01-1214	PLENUM CLOSURE DOOR, REAR	1	1	1	1	1	
20a	D01-1134	PLENUM CLOSURE DOOR	6	8	9	10	12	
21	DC-974	DANGER FOOT IN AUGER DECAL	2	2	2	2	2	
22	D01-1217	PLENUM CLOSURE DOOR REAR FRAME ANGLE	1	1	1	1	1	

\*ITEM NUMBERS 18 AND 19 TOGETHER MAKE UP THE METER ROLL UPPER SHIELD ASSEMBLY

## Outside Screens / Meter Roll Access Door

\*Note: Item 4 is pointing to the top edge angle gusset. There are two types of gusset on the dryer. The photo right will help distinguish the difference between the two. The arrows are pointing to a tab on the gusset that makes them different (tabs are "bent" up in photo). Item 4a is used in two places only; 1.) front right of dryer 2.) rear left of dryer, all others are item 4.

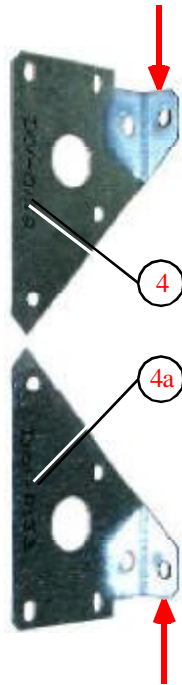

Meter roll access door.

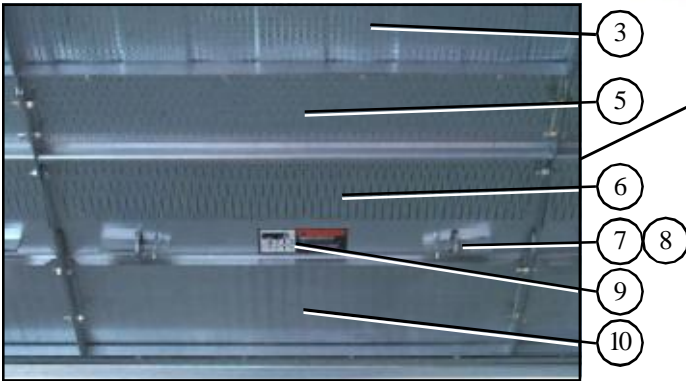

ITEM NUMBER	PART NUMBER	DESCRIPTION	1214S	1218S	1220S	1222S	1226S
1	D01-0127	SCREEN,ROOF,GA,094	14	18	20	22	26
2	D31-0013	SCREEN,OUTSIDE WALL,GA,094	14	18	20	22	26
3	D01-0128	SCREEN,HOPPER,GA,094	14	18	20	22	26
4	D01-0152	LH TOP ANGLE GUSSET	12	16	18	20	24
4a	D01-0153	RH TOP ANGLE GUSSET	2	2	2	2	2
5	D01-0050P	CONNECTOR SHEET, PERFORATED	14	18	20	22	26
6	D01-0045P	ACCESS DOOR, PERFORATED	14	18	20	22	26
7	D01-0039	DOOR LATCH	28	36	40	44	52
8	S-6552	PIN HAIR CLIP 3/32 ZN PLATED	28	36	40	44	52
9	DC-1229	DECAL, WARNING METER ROLL ROT.	14	18	20	22	26
10	D01-0048	TROUGH PANEL WELDMENT	14	18	20	22	26

## Plenum Divider

Right rear plenum divider section with clean-out door.

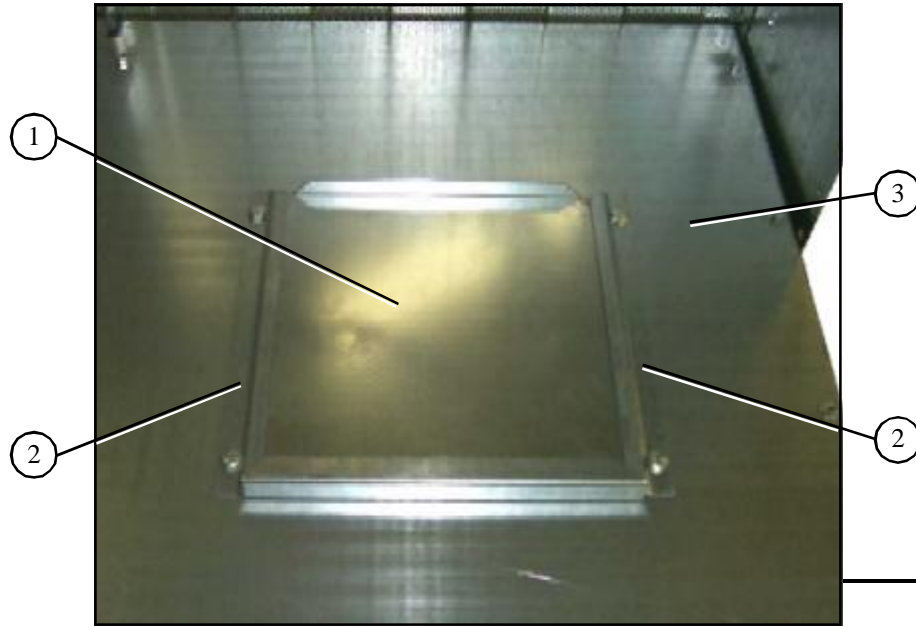

Plenum divider floor sections.

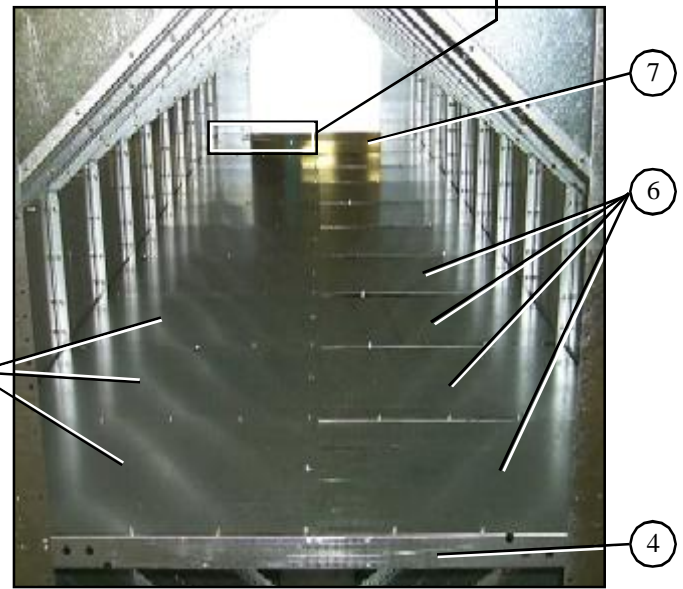

Plenum divider support channels.

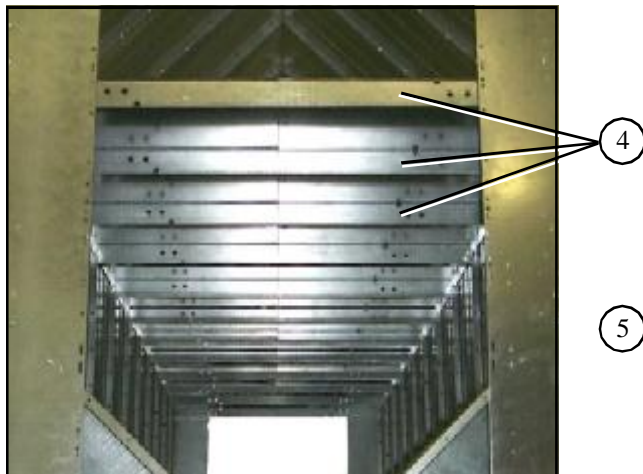

ITEM NUMBER	PART NUMBER	DESCRIPTION	1214S	1218S	1220S	1222S	1226S
1	D31-0259	PLENUM DIVIDER CLEAN-OUT DOOR	1	1	1	1	1
2	D31-0260	CLEAN-OUT DOOR GUIDE PLENUM	2	2	2	2	2
3	D61-0028	PLENUM DIVIDER RH: REAR	1	1	1	1	1
4	D61-0024	PLENUM SUPPORT CHANNEL	8	10	11	12	14
5	D61-0026	PLENUM DIVIDER RH	6	8	9	10	12
6	D61-0025	PLENUM DIVIDER LH	6	8	9	10	12
7	D61-0027	PLENUM DIVIDER LH: REAR	1	1	1	1	1

**NOTE: The quantities listed for the parts above are for one module only. The plenum divider components shown are the same for both modules.**

## Clean Out Doors

Front and rear handle mechanisms (rear shown in photo).

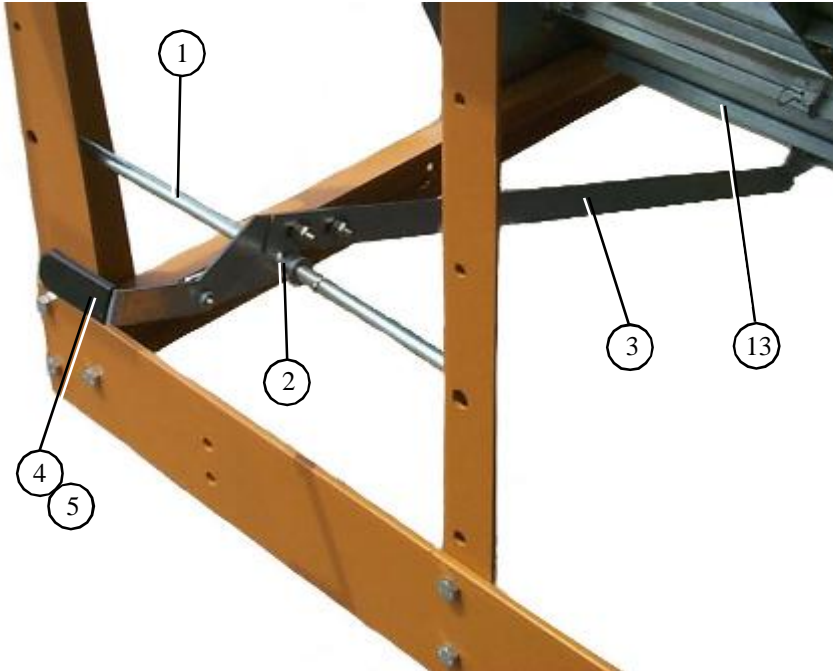

\*Note: Items 9, 10, & 11 together create the clean out door assembly. There are three different clean out door assemblies that are used on GSI Network dryers:

1.) 3 column clean out door Assy. (D51-0077). Item **8a** on the part no. listing (pg 17).

2.) 4 column clean out door Assy. (D11-0032). Item **8b** on the part no. listing (pg 17).

3.) 5 column clean out door Assy. (D01-0349). Item **8c** on the part no. listing (pg 17).

A 5 column clean out door Assy (D01-0349) is shown in the photograph below.

Clean out door handle mechanism.

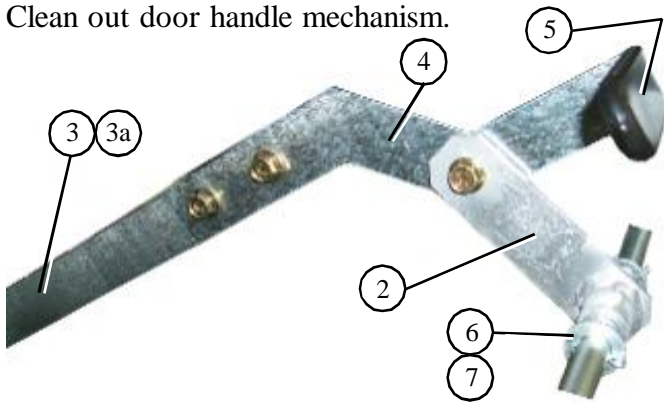

Clean out door hinge.

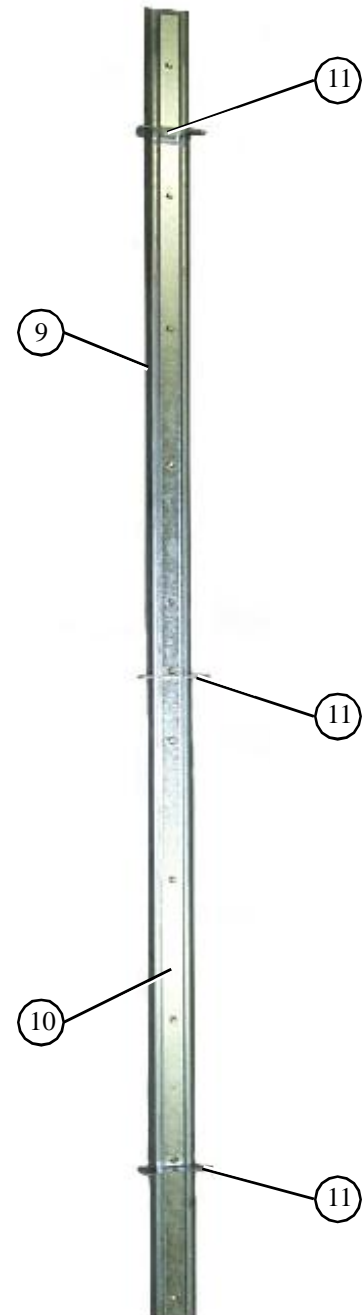
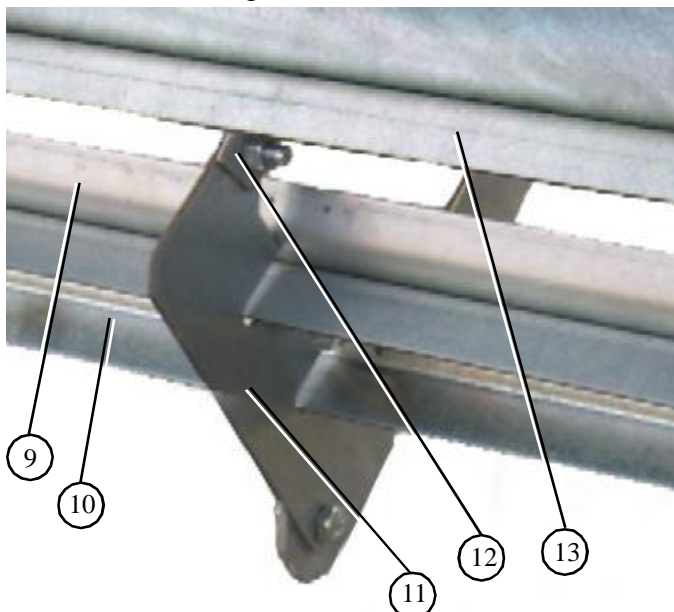

## Clean Out Doors

Center handle mechanisms (this handle mechanism straddles the center cross channels).

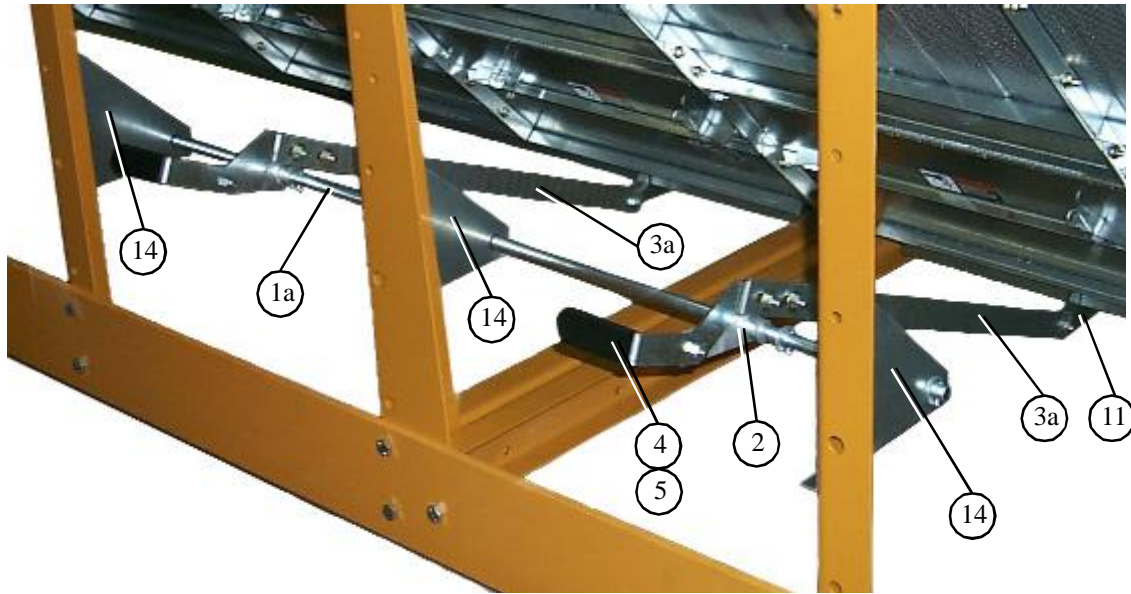

ITEM NUMBER	PART NUMBER	DESCRIPTION	1214S	1218S	1220S	1222S	1226S		
1	D01-0264	PIVOT ROD 25.188"	2	2	2	2	2		
1a	D31-0162	PIVOT ROD 49.625"	1	1	1	2	2		
2	D01-0296	LINKAGE BAR WELDMENT	4	4	4	6	6		
3	D01-0261	LINKAGE BAR, 37" LONG	2	2	2	2	2		
3a	D01-0293	LINKAGE BAR, 30" LONG	2	2	2	4	4		
4	D01-0294	CLEAN OUT DOOR HANDLE	4	4	4	6	6		
5	S-4378	PLASTIC GRIP	4	4	4	6	6		
6	S-248	WASHER, FLAT 3/8 USS ZN	8	8	8	12	12		
7	S-7241	COTTER PIN, 1/8 x 1 1/4	8	8	8	12	12		
8a	D51-0077	CLEAN OUT DOOR ASSY, 3 COLUMN	1			1			
9	D21-0005	CLEAN OUT DOOR, 67"	1 PER ASSEMBLY						
10	D21-0012	SUPPORT CHANNEL, CLEAN OUT DOOR	1 PER ASSEMBLY						
11	D01-0308	CLEAN OUT DOOR HINGE	2 PER ASSEMBLY						
8b	D11-0032	CLEAN OUT DOOR ASSY, 4 COLUMN	1	1		2	2		
9	D31-0021	CLEAN OUT DOOR, 91"	1 PER ASSEMBLY						
10	D31-0130	SUPPORT CHANNEL, CLEAN OUT DOOR	1 PER ASSEMBLY						
11	D01-0308	CLEAN OUT DOOR HINGE	2 PER ASSEMBLY						
8c	D01-0349	CLEAN OUT DOOR ASSY, 5 COLUMN		1	2		1		
9	D01-0180	CLEAN OUT DOOR, 115"	1 PER ASSEMBLY						
10	D01-0307	SUPPORT CHANNEL, CLEAN OUT DOOR	1 PER ASSEMBLY						
11	D01-0308	CLEAN OUT DOOR HINGE	3 PER ASSEMBLY						
12	D01-0175	HINGE BRACKET	4	5	6	6	7		
13	D01-0181	CLEAN OUT EXTENSION, 119.75"		2	4		2		
13	D31-0023	CLEAN OUT EXTENSION, 90.75"	2	2		4	4		
13	D21-0006	CLEAN OUT EXTENSION, 66.75"	2			2			
14	D01-0299	PIVOT ROD BRACKET	3	3	3	6	6		



## Front End Panels / Fan Support / grill guards

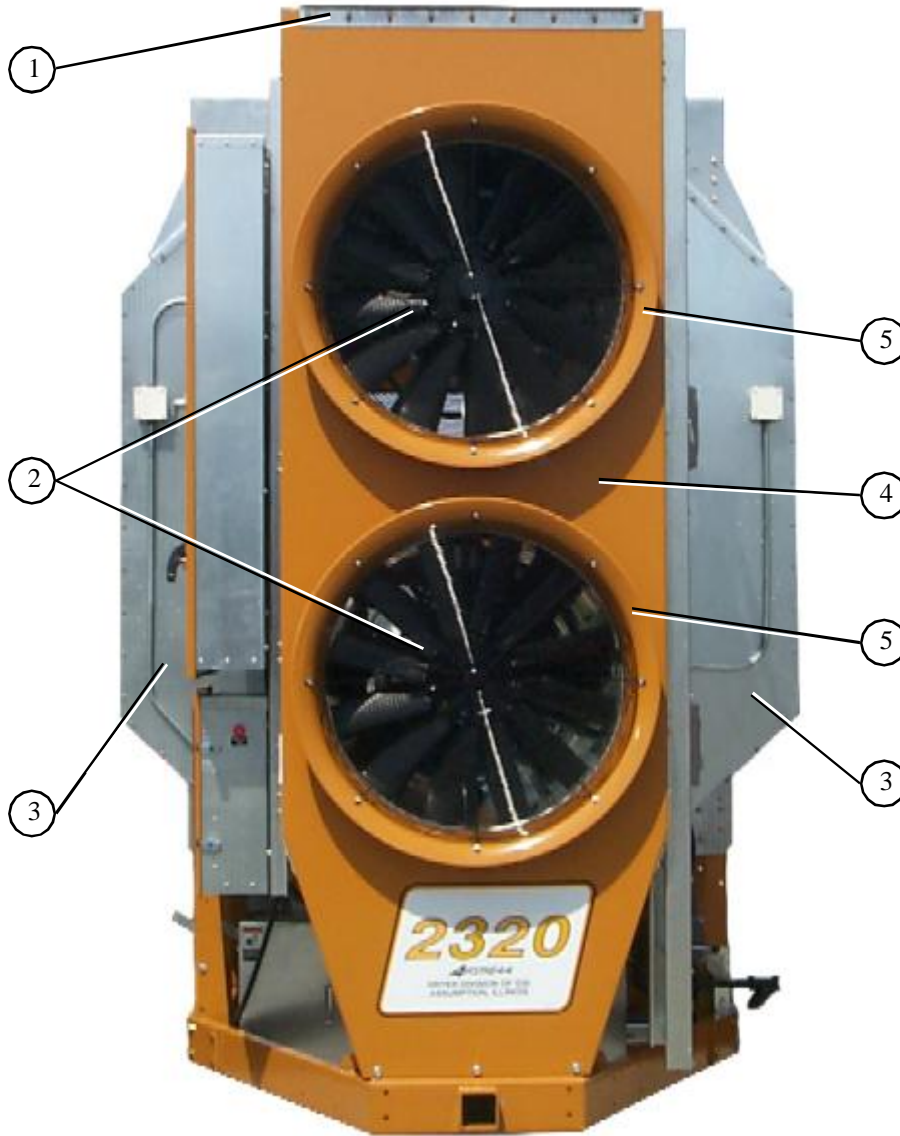

ITEM NUMBER	PART NUMBER	DESCRIPTION	1214S	1218S	1220S	1222S	1226S
1	D61-0023	TOP ANGLE, FAN SUPPORT PANEL	1	1	1	1	1
2	CD-0576	GRILL GUARD: CD-28 BLACK	2				
2	CD-0544	GRILL GUARD: 36" BLACK		2	2	2	
2	CD-0547	GRILL GUARD: 40&42" BLACK					2
3	D31-0307	COLUMN END PANEL	4	4	4	4	4
4	D01-0593	FRONT FAN SUPPORT 2-28"	1				
4	D61-0041	FRONT FAN SUPPORT 2-36"		1	1	1	
4	D71-0008	FRONT FAN SUPPORT 2-40"					1
5	F-7060-Y	VENTURI: 28" YEL/OCHRE	2				
5	CD-0543-Y	VENTURI: 36" OCHRE		2	2	2	
5	CD-0545-Y	VENTURI: 40" OCHRE					2
NOT SHOWN	D01-0594	FRONT END PANEL 2-28"	1				
NOT SHOWN	D61-0018	FRONT END PANEL 2-36"		1	1	1	
NOT SHOWN	D71-0006	FRONT END PANEL 2-40"					1

## Rear End Panels / Rear Access Door

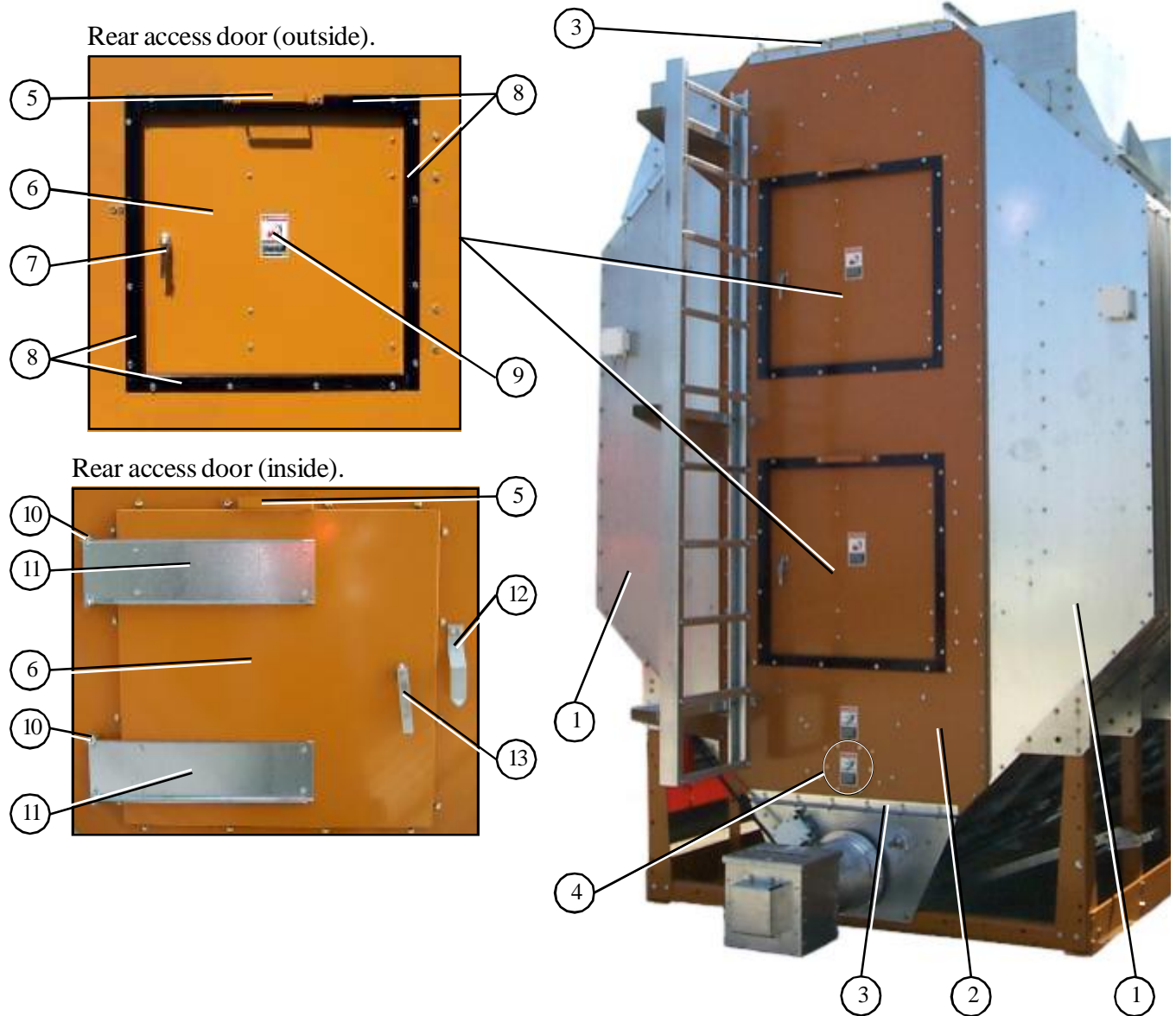

ITEM NUMBER	PART NUMBER	DESCRIPTION	1214S	1218S	1220S	1222S	1226S	
1	D31-0307	COLUMN END PANEL	4	4	4	4	4	
2	D01-1800-Y	REAR END PANEL 50/50 29" DOORS	1	1	1	1	1	
3	D01-0044	TOP ANGLE BRACKET FRONT & REAR	3	3	3	3	3	
4	D01-1510	ASPIRATOR END CAP	1	1	1	1	1	
5-13	RDA-29-Y	REAR DOOR ASSEMBLY 29"SQ OCHR	2	2	2	2	2	
5	D01-1783-Y	ASSIST HANDLE 29" SQ. DOOR						2/ASSEMBLY
6	D01-1781-Y	DOOR 29" SQUARE OCHRE						1/ASSEMBLY
7	D03-0512	DOOR HANDLE, LOCKING CCW						1/ASSEMBLY
8	D01-1782-BLK	FRAME ANGLE 29" DOOR						4/ASSEMBLY
9	DC-973	DECAL, DANGER FIRE HAZARD						2/ASSEMBLY
10	401-4630-0	HINGE BRACKET-SQUARE DOOR						2/ASSEMBLY
11	401-4669-8	HINGE-REAR ACCESS SQ DOOR						2/ASSEMBLY
12	D01-0397	LATCH BRACKET						1/ASSEMBLY
13	D01-1792	LATCH BAR 29" SQUARE DOOR						1/ASSEMBLY

## Front Ladder Assembly

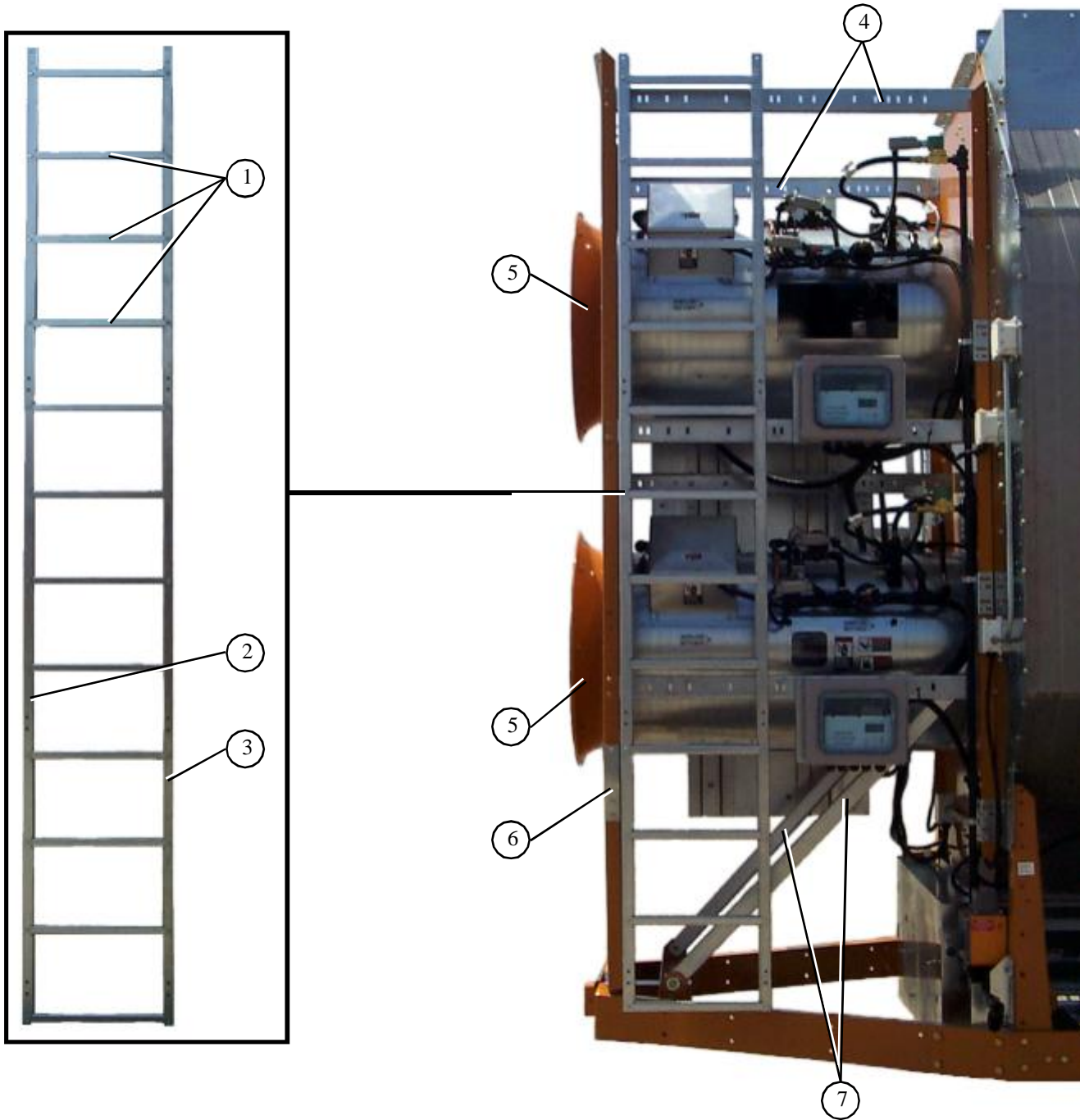

ITEM NUMBER	PART NUMBER	DESCRIPTION	1214S	1218S	1220S	1222S	1226S	
1-3	D01-1220	LADDER ASSY. STACK DRYER FRONT	1	1	1	1	1	
1	D61-0096	LADDER RUNG	12/ASSEMBLY					
2	D61-0094	LADDER SIDE RAIL-LH	1/ASSEMBLY					
3	D61-0095	LADDER SIDE RAIL-RH	1/ASSEMBLY					
4	D51-0022	SUPPORT, CONTROL PANEL	7	7	7	7	7	
5	F-7060-Y	VENTURI: 28" YEL/OCHRE	2					
5	CD-0543-Y	VENTURI: 36" OCHRE		2	2	2		
5	CD-0545-Y	VENTURI: 40" OCHRE					2	
6	D51-0021	STIFFENER, FRONT FAN SUPPORT	2	2	2	2	2	
7	D31-0082	FRONT DIAGONAL SUPPORT CHANNEL	2	2	2	2	2	

## Rear Ladder Assembly

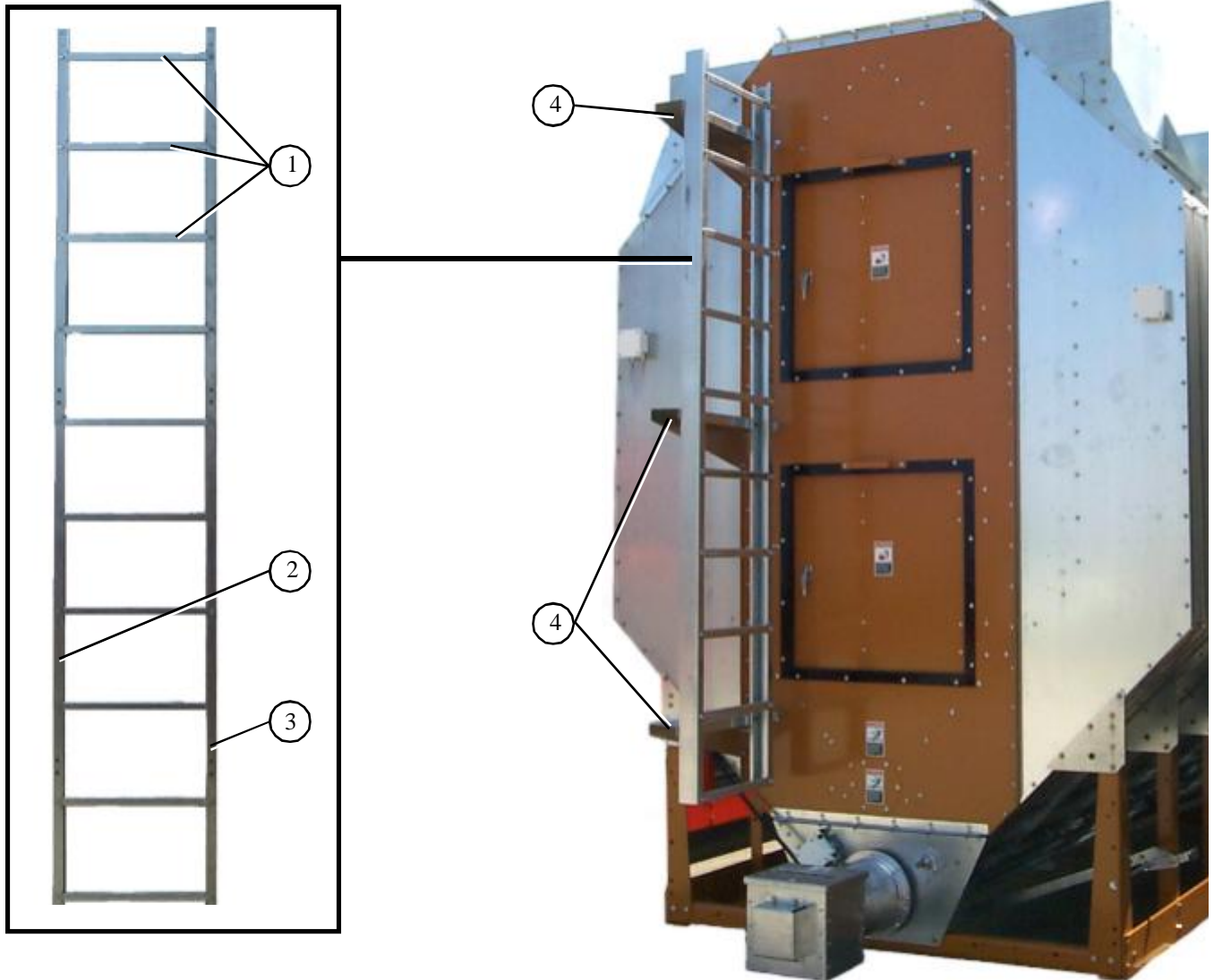

ITEM NUMBER	PART NUMBER	DESCRIPTION	1214S	1218S	1220S	1222S	1226S	
1-3	D04-0388	LADDER ASSEMBLY	1	1	1	1	1	
1	D61-0096	LADDER RUNG	10/ASSEMBLY					
2	D61-0092	LADDER SIDE RAIL-LH	1/ASSEMBLY					
3	D61-0093	LADDER SIDE RAIL-RH	1/ASSEMBLY					
4	D61-0097	LADDER MOUNTING BRACKET, REAR	3	3	3	3	3	

## Bottom Auger

Bottom Auger (view from center of dryer to the forward end).

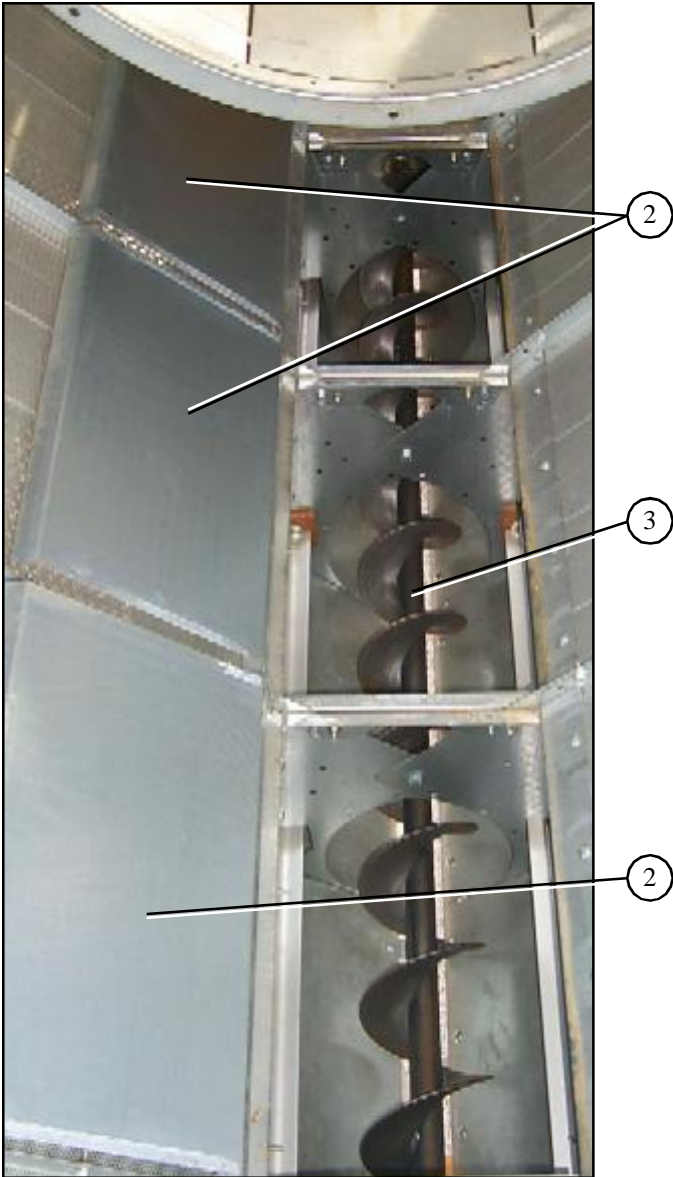

Bottom Auger (view from center of dryer to the rear end).

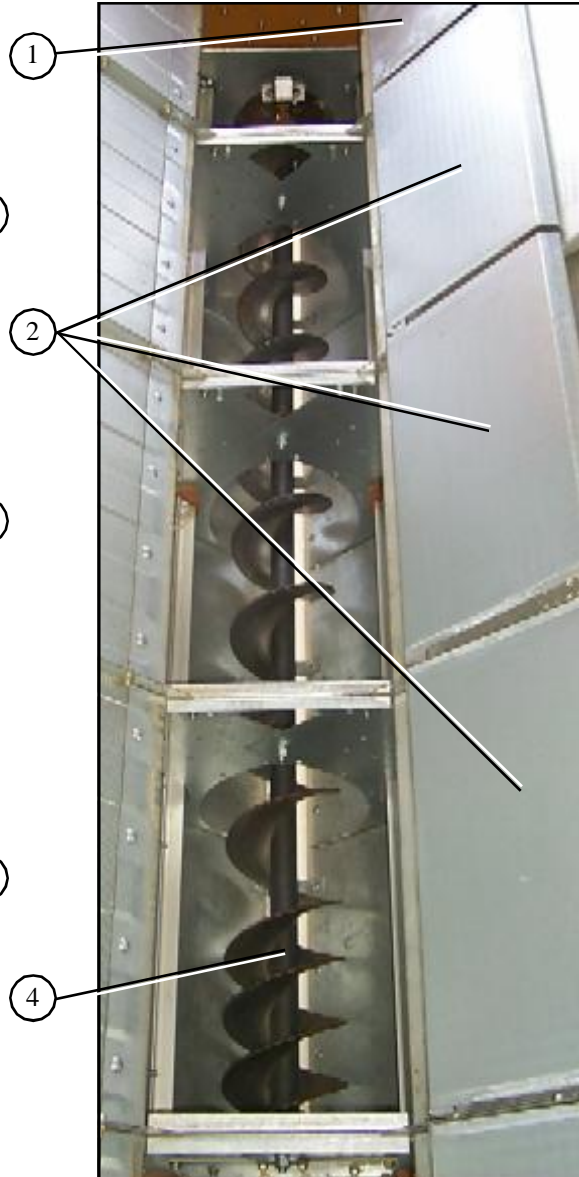

Bottom Auger center bearing and support.

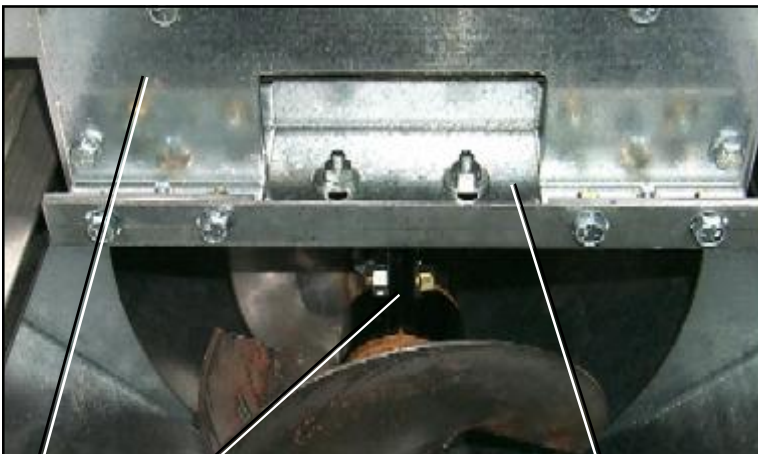

Bottom Auger rear bearing.

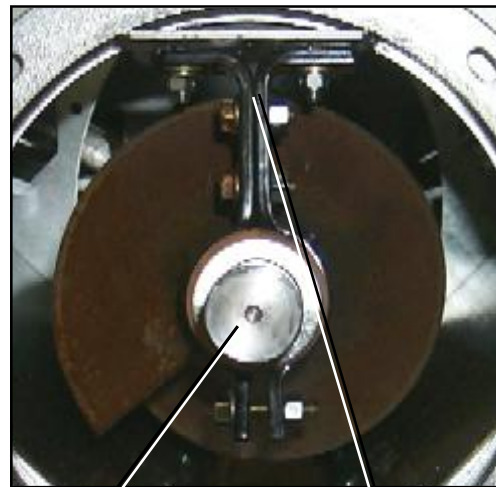

5

7

6

8

7

## Bottom Auger

Rear Discharge Box.

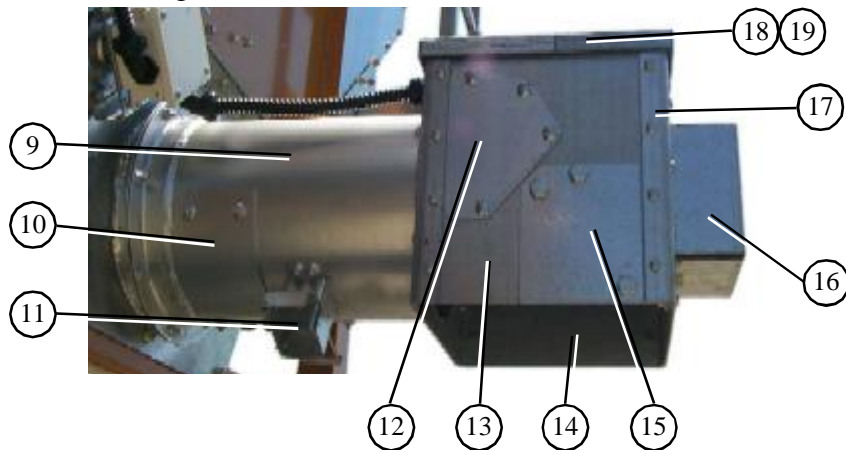

Auger bearing.

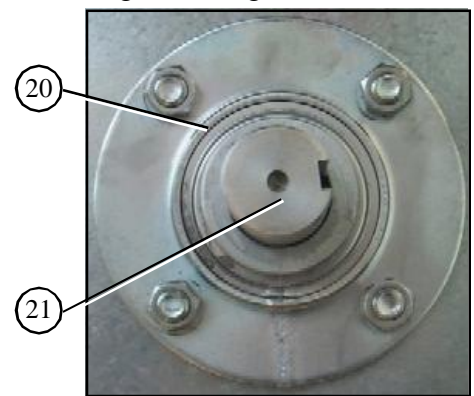

ITEM NUMBER	PART NUMBER	DESCRIPTION	1214S	1218S	1220S	1222S	1226S
1	D01-1214	PLENUM CLOSURE DOOR, REAR	1	1	1	1	1
2	D01-1134	PLENUM CLOSURE DOOR	6	8	9	10	12
3	D21-0017	AUGER BOTTOM FRONT WELDMENT	1			1	
3	D31-0092	AUGER BOTTOM FRONT WELDMENT		1			1
3	D31-0092	AUGER BOTTOM FRONT WELDMENT (116 3/8" LONG)			1		
4	D31-0267	AUGER BOTTOM REAR WELDMENT	1	1		2	2
4	D61-0184	AUGER BOTTOM REAR WELDMENT (117 7/8" LONG)			1		
5	D01-1290	HANGER BEARING BOTTOM J-PLATE	2	2	2	4	4
6	D01-1291	HANGER BEARING BOTTOM C-CHANNEL	1	1	1	2	2
7	D01-1246	HANGER BEARING ASSEMBLY (SHORT)	2	2	2	3	3
8	D31-0076	SHAFT, AUGER SPLICE	2	2	2	3	3
9-19	D01-0481-MS	DISCHARGE BOX ASSEMBLY	1	1	1	1	1
9	D01-1884	DISCHARGE WELDMENT			1/ASSEMBLY		
10	D01-1886	MOIST. SAMPLER TUBE COVER PLATE			1/ASSEMBLY		
11	D01-0405	GRAIN SAMPLER ASSEMBLY			1/ASSEMBLY		
12	D01-1752	DISCHARGE SIDE COVER			1/ASSEMBLY		
13	D01-1751	DISCHARGE SICE PANEL MC			1/ASSEMBLY		
14	D31-0298	DISCHARGE SIDE PANEL			1/ASSEMBLY		
15	D01-1885	MOIST. SAMPLER COVER PLATE			1/ASSEMBLY		
16	D01-1650	REAR AUGER BEARING SHIELD			1/ASSEMBLY		
17	D31-0299	DISCHARGE BOX BEARING PLATE			1/ASSEMBLY		
18	D01-0466	DISCHARGE TOP PANEL			1/ASSEMBLY		
19	D01-0467	DISCHARGE TOP FLAPPER			1/ASSEMBLY		
20	D32-0001	FLANGETTE BEARING	1	1	1	1	1
21	D31-0005	SHAFT, TOP & BOT AUGER STUB	1	1	1	1	1
NOT SHOWN	D31-0079	DISCHARGE AUGER WELDMENT	1	1	1	1	1

# Top Auger With Wet Bin Assembly

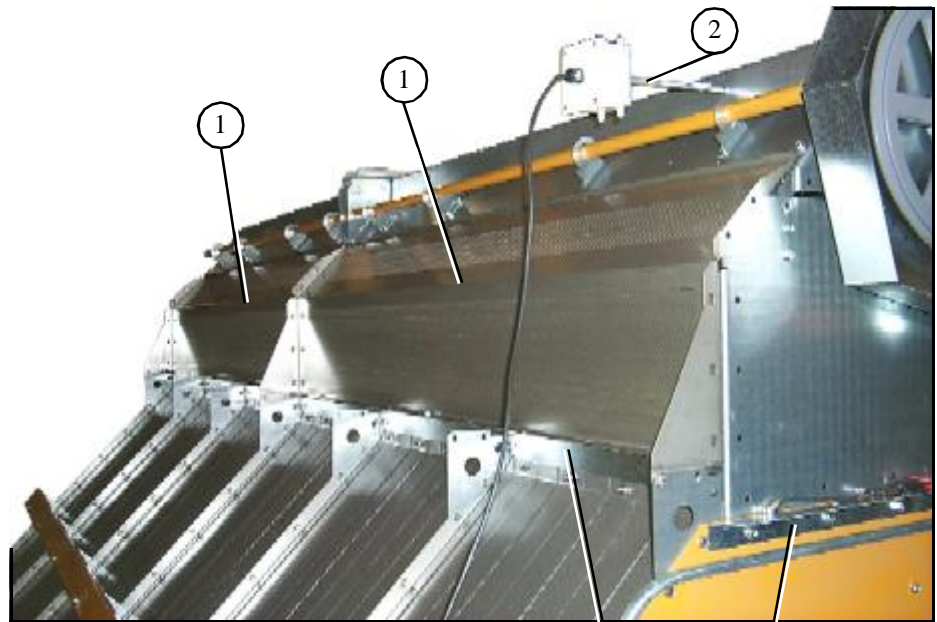

Top Auger with wet bin (switch paddle end).

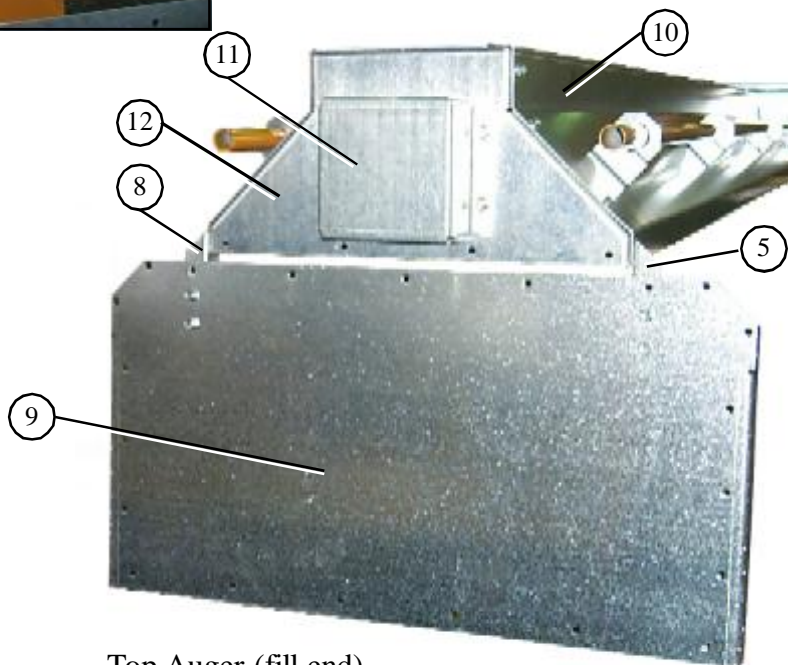
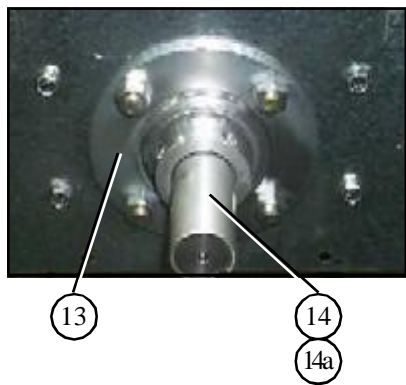
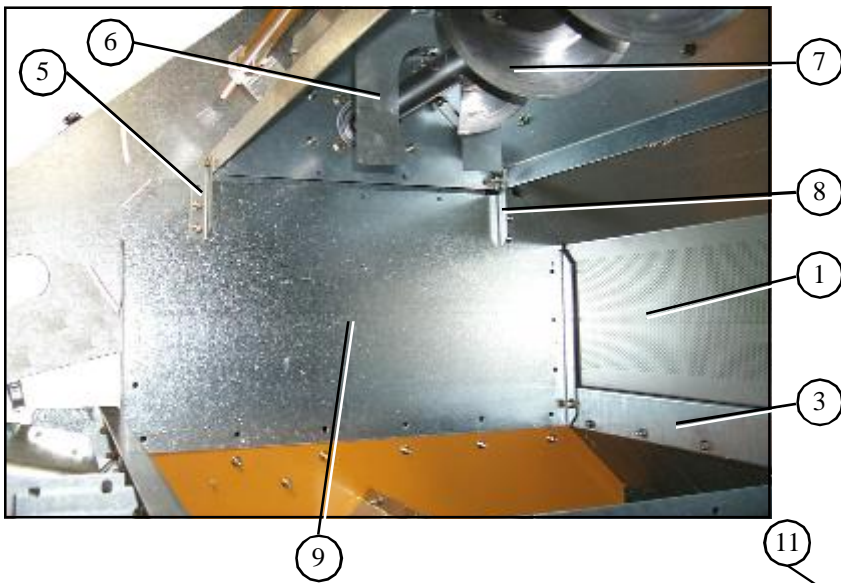

Top Auger (fill end).

## Top Auger With Wet Bin Assembly

Top Auger bearing support.

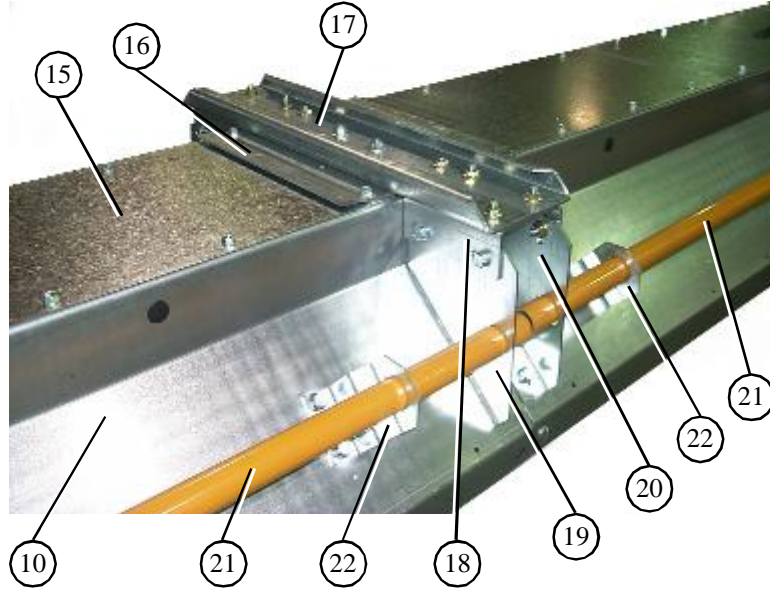

Top Auger bearing support (inside view).

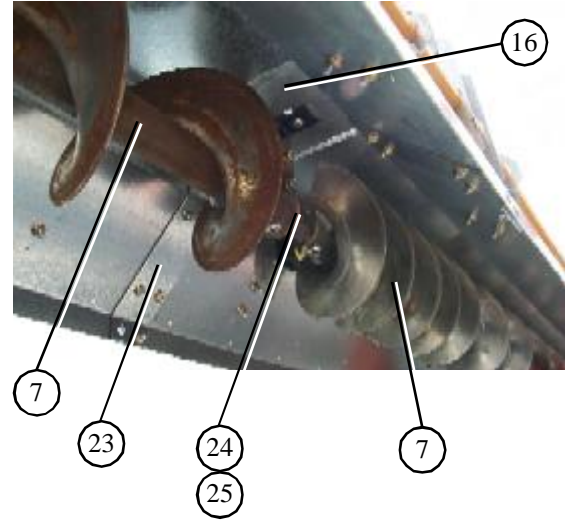

ITEM NUMBER	PART NUMBER	DESCRIPTION	1214S	1218S	1220S	1222S	1226S
1	D01-1521	WET BIN SIDE,4'SIDE GALV. PERF	4		4	2	4
1	D01-1522	WET BIN SIDE,6'SIDE GALV. PER	2	6	4	6	6
2	D01-0103	MERCURY SWITCH SHAFT	1	1	1	1	1
3	D21-0003	TOP EDGE ANGLE 71.875"	2			2	
3	D31-0004	TOP EDGE ANGLE 95.875"	2	2		4	4
3	D01-0168	TOP EDGE ANGLE 119.875"		2	4		2
3a	D31-0003	TOP EDGE ANGLE SPLICE	2	2	2	4	4
5	D01-0147	TOP AUGER HOUSING HINGE L.H.	2	2	2	2	2
6	D01-0167	MERCURY SWITCH PADDLE WELDMENT	1	1	1	1	1
7	D21-0015	AUGER TOP FRONT WELDMENT	1			1	
7	D31-0091	AUGER TOP FRONT WELDMENT		1	1		1
7	D31-0267	AUGER TOP & BOTTOM WELDMENT	1	1		2	2
7	D61-0184	AUGER WELDMENT 117 7/8"			1		
8	D01-0148	TOP AUGER HOUSING HINGE R.H.	2	2	2	2	2
9	D01-1525	WET BIN END	2	2	2	2	2
10	D21-0002	TOP AUGER TROUGH SIDE/6'	2			2	
10	D31-0010	TOP AUGER TROUGH SIDE/8'	2	2		4	4
10	D01-0161	TOP AUGER TROUGH SIDE/10'		2	4		2
11	D01-1650	REAR AUGER BEARING COVER	1	1	1	1	1
12	D31-0028	TOP AUGER HOUSING END	2	2	2	2	2
13	D32-0001	BEARING 1 1/2" DIA W/FLANGETTE	2	2	2	2	2
14	D31-0090	SHAFT, TOP AUGER FRONT	1	1	1	1	1
14a	D31-0005	SHAFT, TOP AUGER STUB REAR	1	1	1	1	1
15	D01-1123	TOP AUGER COVER, 30.25"	1	1	1	1	1
15	D01-1124	TOP AUGER COVER, 24.25"	3	5	7	5	7
15	D01-1125	TOP AUGER COVER, 20.25"	2	2	2	4	4
16	D31-0015	TOP AUGER BEARING SUPPORT	1	1	1	2	2
17	D31-0011	CENTER STABILIZER BEAM	1	1	1	2	2
18	D31-0009	GUSSET ATTACH BRACKET	2	2	2	4	4
19	D31-0001	CENTER HANDRAIL GUSSET L.H.	2	2	2	4	4
20	D31-0002	CENTER HANDRAIL GUSSET R.H.	2	2	2	4	4
21	D21-0001-Y	HAND RAIL-SUPPORT,1"EMTX71.75"	2			2	
21	D31-0006-Y	HAND RAIL SUPPORT,1"EMTX95.75"	2	2		4	4
21	D01-0151-Y	HAND RAIL, 1"EMT X119.75"LONG		2	4		2
22	D01-0140	HANGER BRACKET-HANDRAIL GALV.	16	16	16	24	24
23	D31-0008	TOP AUGER TROUGH SPLICE	2	2	2	4	4
24	D01-1245	TOP AUGER BEARING HANGER ASSY.	1	1	1	2	2
25	D31-0076	SHAFT, AUGER SPLICE	1	1	1	2	2



# Bottom Auger Drive

Bottom Auger drive components



Bottom Auger motor and motor mount.

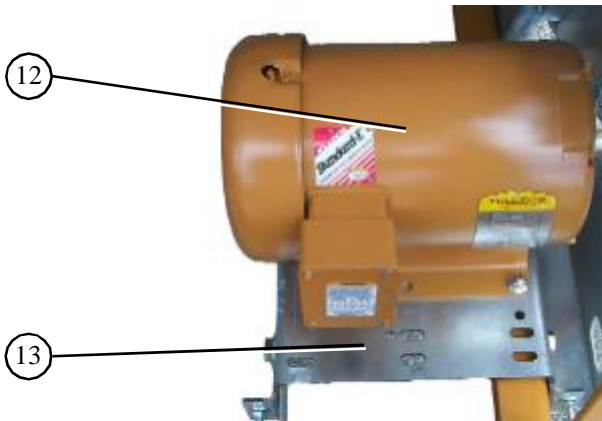

Forward drive tension adjustment.

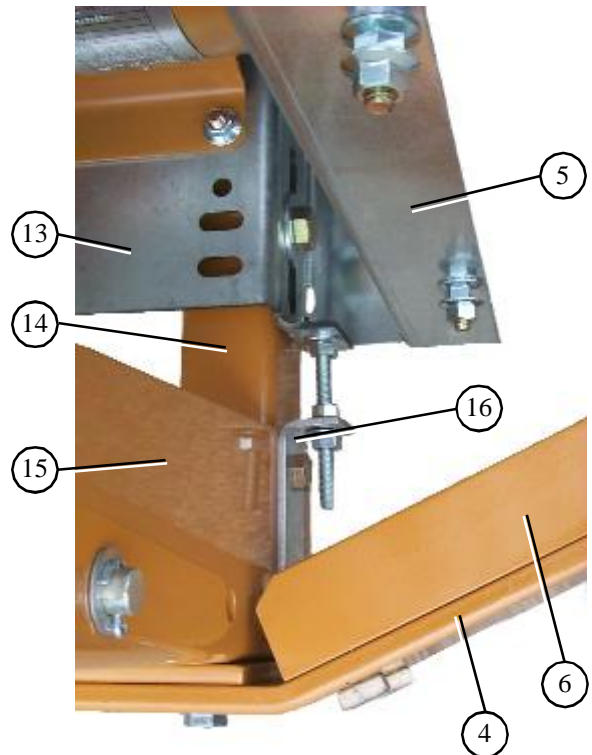

Rear drive tension adjustment.

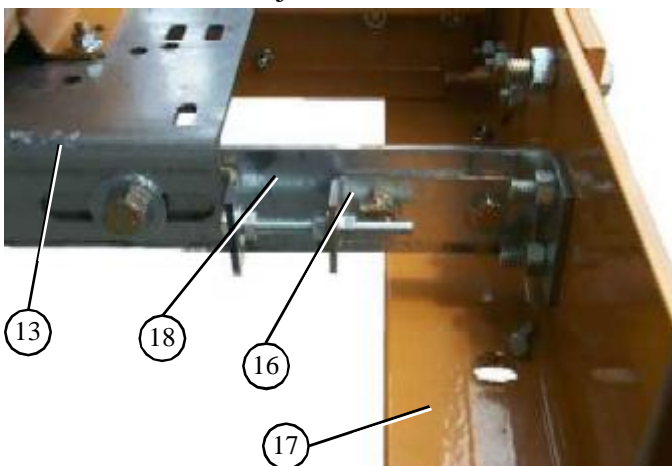

## Bottom Auger Drive

Bottom auger and metering roll drive guard.

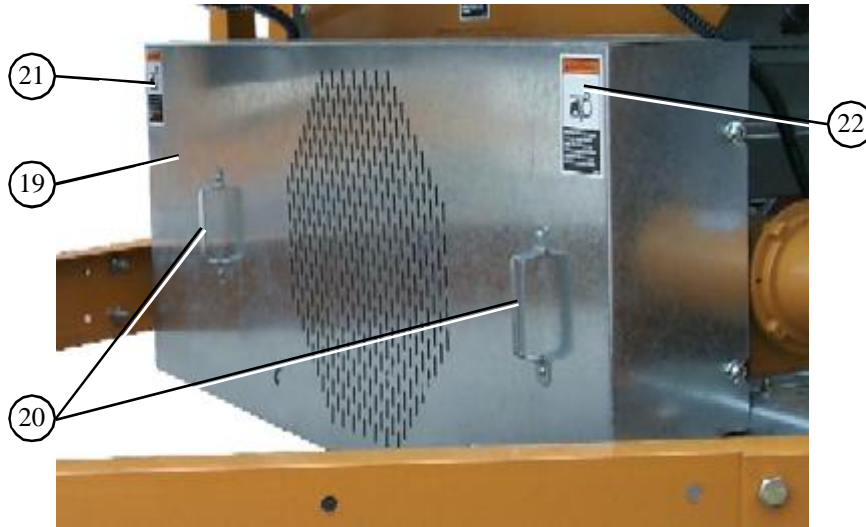

ITEM NUMBER	PART NUMBER	DESCRIPTION	1214S	1218S	1220S	1222S	1226S
1	D01-1376	BOTTOM FRONT ANGLE BRACKET	1	1	1	1	1
2	MHC00490	BELT-V BX82	2	2	2	2	2
3	2818-2	SHEAVE 2GR 3.35Dx1 1/8"	1	1			
3	D62-0003	SHEAVE 2GR 4.25Dx1 3/8"			1	1	1
4	D01-0012	HITCH BRACKET, RIGHT	1	1	1	1	1
5	D01-1373	BELTGUARD, UNLOAD MOTOR SHROUD	1	1	1	1	1
6	D01-0029	HITCH WELDMENT	1	1	1	1	1
7	D01-0011	HITCH BRACKET, LEFT	1	1	1	1	1
8	D01-1374	BOTTOM AUGER BEARING PLATE	1	1	1	1	1
9	D03-0304	SHEAVE 2GR 20" GRIPBELT	1	1	1	1	1
10	D32-0019	BUSHING Q1-1 1/2" SPLIT TAPER	1	1	1	1	1
11	D01-0065	SPACER, BEARING SHIELD	2	2	2	2	2
*12	500-1	MOTOR 5HP 1PH 1800RPM	1	1			
12	500-3	MOTOR 5HP 3PH 1800RPM	1	1			
*12	712-1	MOTOR 7.5HP 1PH 1800RPM			1		
12	712-3	MOTOR 7.5HP 3PH 1800RPM			1	1	
12	1000-3	MOTOR 10HP 3PH 1800RPM					1
13	D01-0081	MOTOR MOUNT - BOTTOM AUGER	1	1	1	1	1
14	D01-0008	FRONT & REAR FRAME TIE CHANNEL	4	4	4	6	6
15	D01-0007	CORNER LEG	6	6	6	8	8
16	D01-0017	MOTOR ADJUSTMENT BRACKET	2	2	2	2	2
17	D21-0011	FRAME RAIL, 14' R.H.	1				
17	D31-0044	FRAME RAIL, 18' R.H.		1			
17	D61-0002	FRAME RAIL, 20' R.H.			1		
17	D101-0002	FRAME RAIL, 22' R.H.				1	
17	D71-0002	FRAME RAIL, 26' R.H.					1
18	D01-0016	MOTOR MOUNT SUPPORT BRACKET	1	1	1	1	1
19	D01-1372	BELTGUARD, UNLOAD FRONT SHIELD	1	1	1	1	1
20	PR-331	PEAK CAP HANDLE	2	2	2	2	2
21	DC-971	DECAL, BELT DRIVE WARNING	2	2	2	2	2
22	DC-972	DECAL, CHAIN WARNING	2	2	2	2	2

\*ITEM 12, PART Nos 500-1 & 712-1 ARE SINGLE PHASE MOTORS

## Top Auger Drive

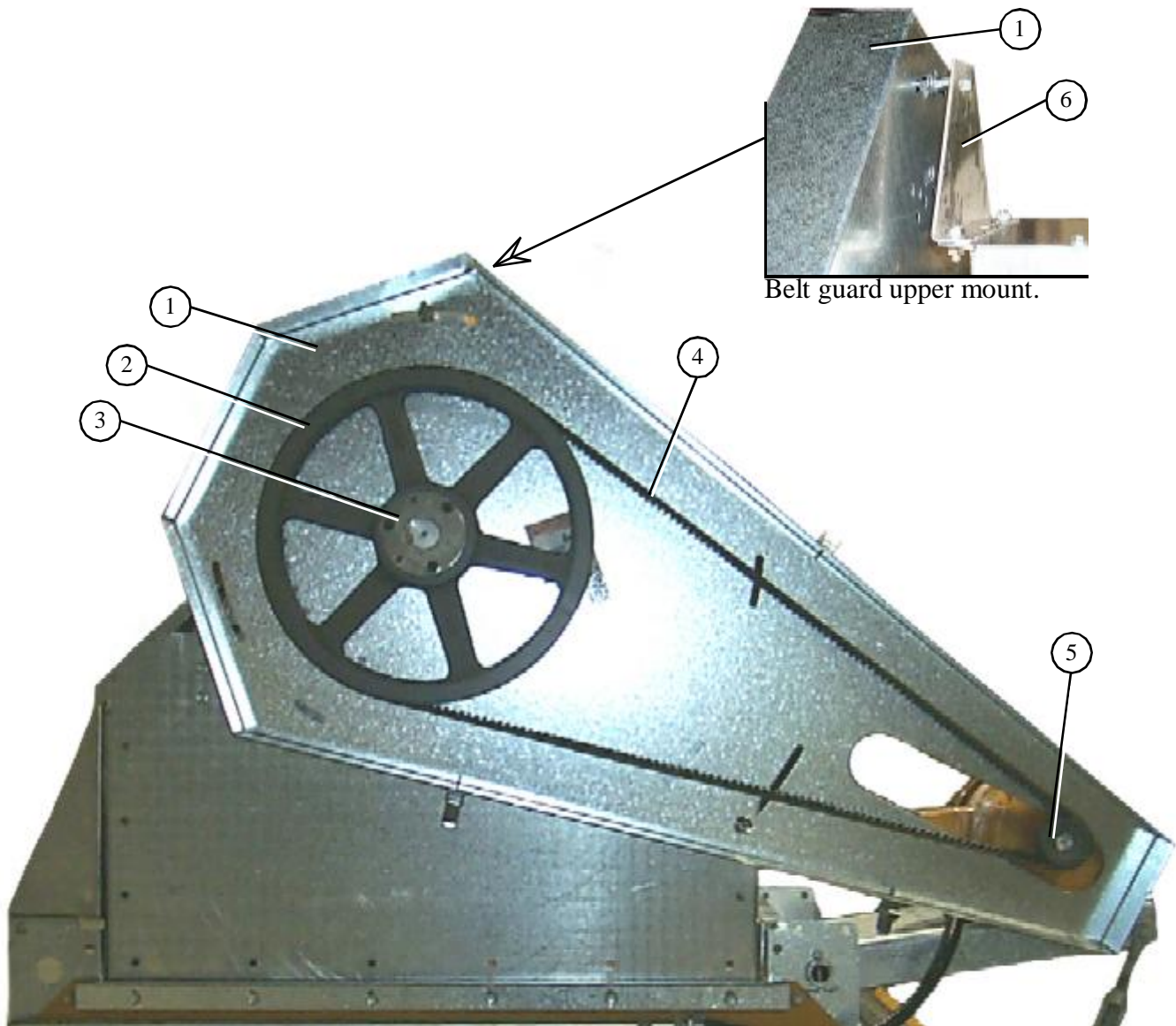

Belt guard upper mount.

Top Auger drive components.

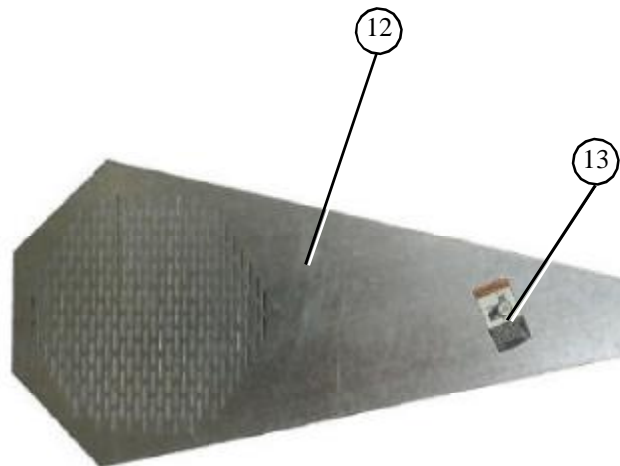

Top Auger belt guard cover.

## Top Auger Drive

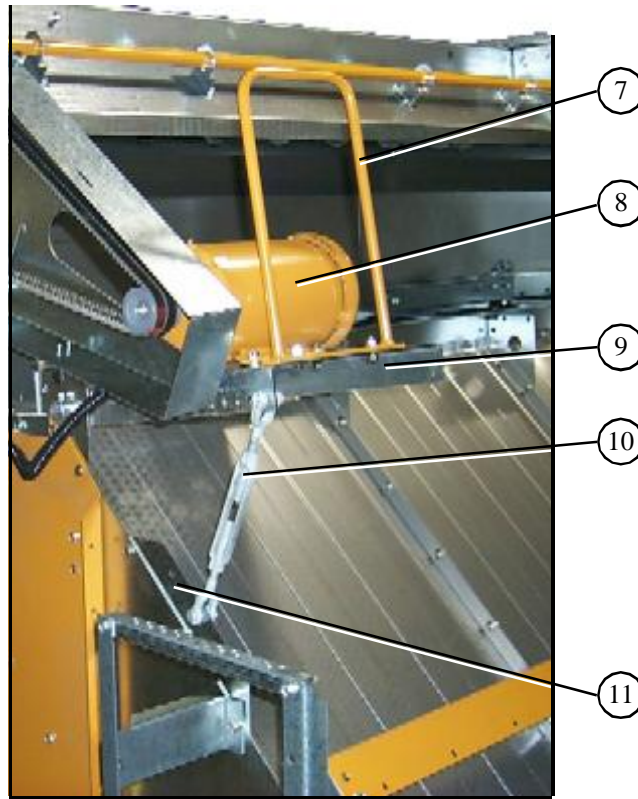

Top Auger motor and motor mount.

ITEM NUMBER	PART NUMBER	DESCRIPTION	1214S	1218S	1220S	1222S	1226S
1	D01-0453	TOP AUGER BELTGARD BODY	1	1	1	1	1
2	D52-0001	SHEAVE 2GR 16" GRIPBELT	1	1	1	1	1
3	D32-0019	BUSHING Q1-1 1/2" SPLIT TAPER	1	1	1	1	1
4	D01-0464	BELT-V BX97	2	2	2	2	2
5	2818-2	SHEAVE 2GR 3.35Dx1 1/8" BORE	1	1			
5	D62-0003	SHEAVE 2GR 4.25Dx1 3/8"			1	1	1
6	D01-0155	MOUNTING BRACKET-BELT GD SPCR	1	1	1	1	1
7	D01-0424	DRYER TOP HAND HOLD	1	1	1	1	1
* 8	500-1	MOTOR 5HP 1PH 1800RPM	1	1			
8	500-3	MOTOR 5HP 3PH 1800RPM	1	1			
* 8	712-1	MOTOR 7.5HP 1PH 1800RPM			1		
8	712-3	MOTOR 7.5HP 3PH 1800RPM			1	1	
8	1000-3	MOTOR 10HP 3PH 1800RPM					1
9	D01-0173	TOP MOTOR MOUNT WELDMENT	1	1	1	1	1
10	D01-0465	TURNBUCKLE 1/2" X 6" PLATED	1	1	1	1	1
11	D01-0170	ANCHOR BRACKET-MOTOR MOUNT	1	1	1	1	1
12	D01-0452-Y	TOP AUGER BELTGUARD COVER OCHR	1	1	1	1	1
13	DC-971	DECAL, BELT DRIVE WARNING	2	2	2	2	2

\*ITEM 8, PART Nos 500-1 & 712-1 ARE SINGLE PHASE MOTORS

SCR Motor/Reduction drive and motor mount assembly.

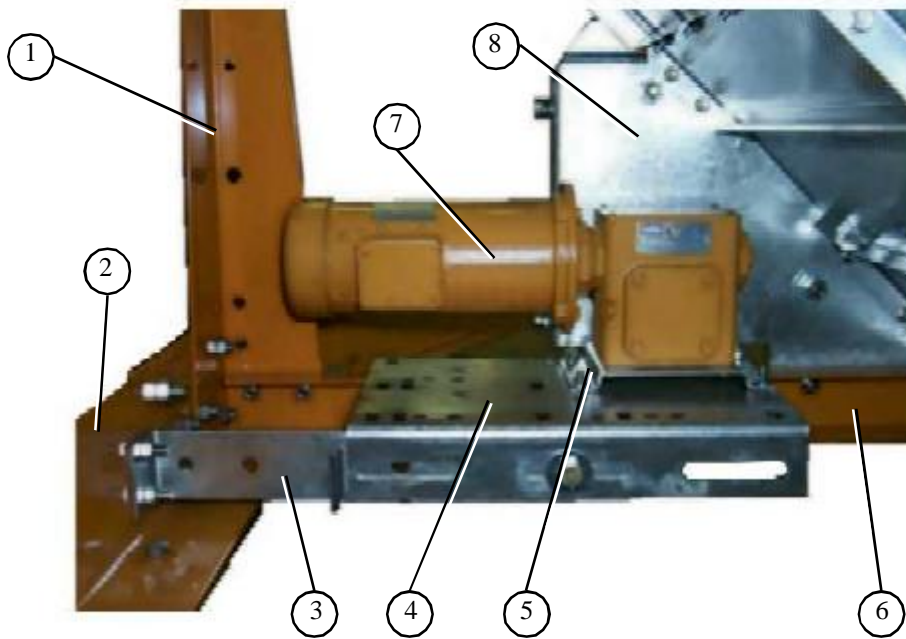

Meter roll drive train components.

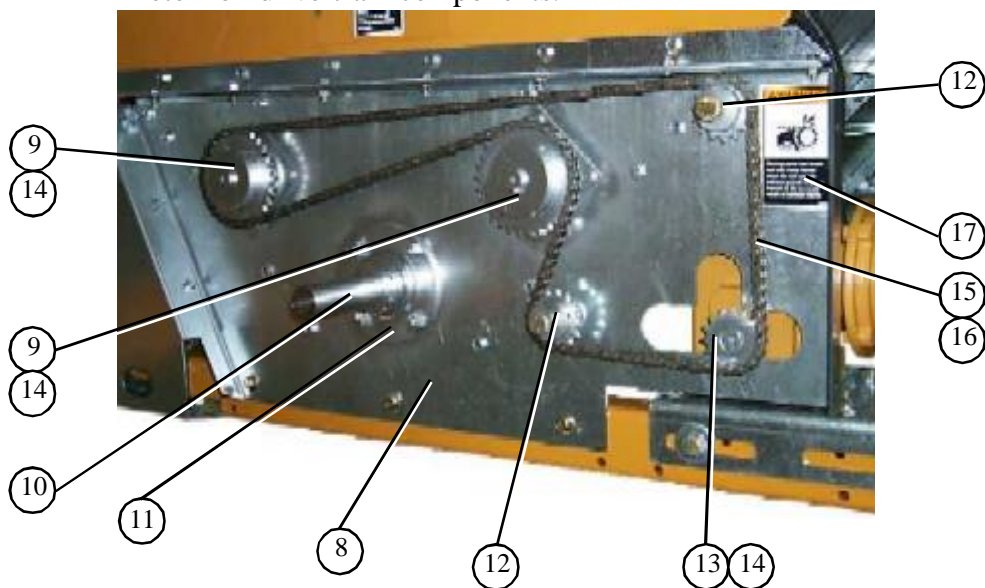

## Metering Roll Drive

Front meter roll bearing.

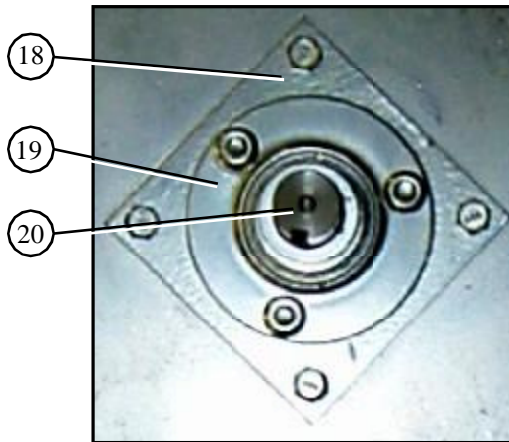

Rear meter roll bearing.

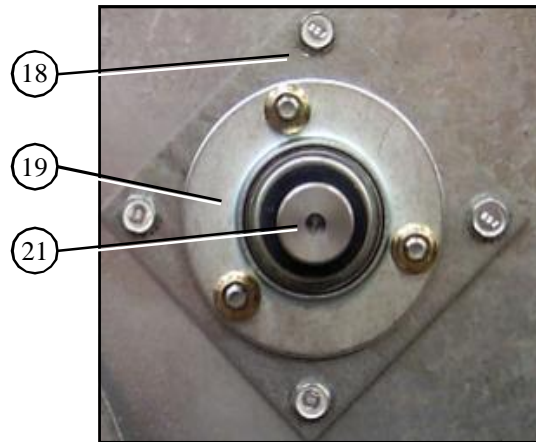

ITEM NUMBER	PART NUMBER	DESCRIPTION	1214S	1218S	1220S	1222S	1226S
1	D01-0007	CORNER LEG PORTABLE DRYER	6	6	6	8	8
2	D21-0010	FRAME RAIL, 14' LEFT	1				
2	D31-0043	FRAME RAIL, 18' LEFT		1			
2	D61-0001	FRAME RAIL, 20' LEFT			1		
2	D101-0001	FRAME RAIL, 22' LEFT				1	
2	D71-0002	FRAME RAIL, 26' LEFT					1
3	D01-0016	MOTOR MOUNT SUPPORT BRACKET	1	1	1	1	1
4	D01-0081	MOTOR MOUNT	1	1	1	1	1
5	D01-0704	SCR MOTOR GEARBOX MOUNT	1	1	1	1	1
6	D01-0008	FRONT & REAR FRAME TIE CHANNEL	4	4	4	6	6
7	D03-0232	MOTOR 3/4 HP DC W/GEAR BOX 50:1	1	1	1	1	1
8	D01-1374	BOTTOM AUGER BEARING PLATE	1	1	1	1	1
9	D02-0029	SPROCKET 40H30	2	2	2	2	2
10	D31-0316	FRONT BOTTOM AUGER SHAFT	1	1	1	1	1
11	D32-0001	FLANGETTE BEARING 1 1/2"	2	2	2	2	2
12	D01-0196	SPROCKET IDLER ASSEMBLY	2	2	2	2	2
13	D03-0257	SPROCKET 4015 x 7/8" BORE W/KEYWAY	1	1	1	1	1
14	S-9168	KEY SQ. 1/4" x 1"	3	3	3	3	3
15	S-6290	CHAIN #40 ROLLER CHAIN	6ft	6ft	6ft	6ft	6ft
16	D02-0031	#40 CHAIN CONNECTING LINK	1	1	1	1	1
17	DC-972	DECAL. CHAIN WARNING	2	2	2	2	2
18	D01-0003	ADAPTOR PLATE	4	4	4	4	4
19	GK1583	FLANGETTE BEARING 1", W/LOCK COLLAR	4	4	4	4	4
20	D01-0006	METER ROLL DRIVE SHAFT (front)	2	2	2	2	2
21	D01-0272	METER ROLL SHAFT STUB (rear)	2	2	2	2	2

## Fan Heater Housing Assembly

Fan Heater housing assembly.

28" burner support and collector cup.

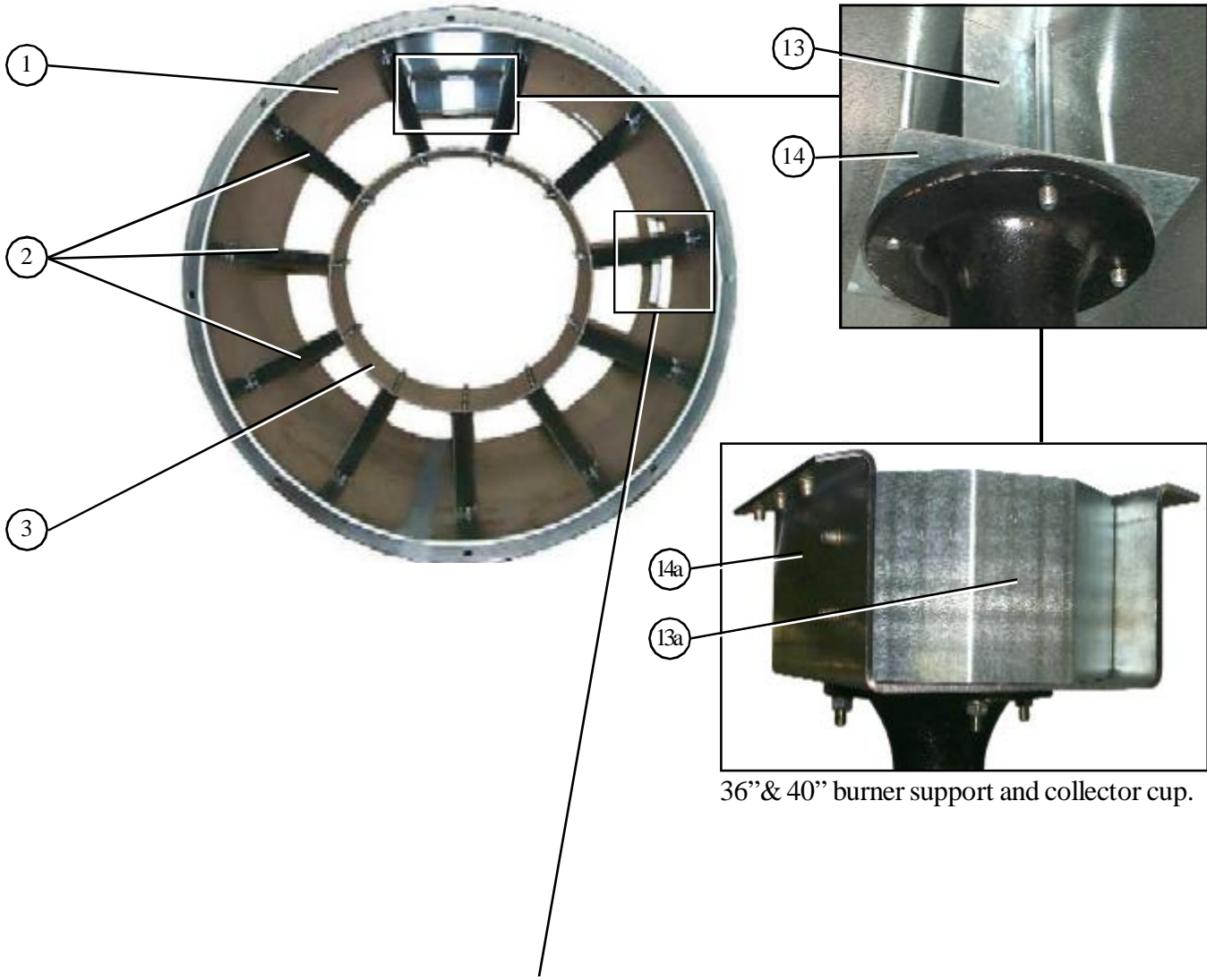

36" & 40" burner support and collector cup.



## Fan Heater Housing Assembly

ITEM NUMBER	PART NUMBER	DESCRIPTION	2812	3612	3615	4025
1	D01-1996	WRAPPER, 28" FAN HEATER	1			
1	D01-1963	WRAPPER, 36" FAN HEATER		1	1	
1	D01-1997	WRAPPER, 40" FAN HEATER				1
2	D01-0529	STRAIGHTENING VANE, 28" F/H	11			
2	D01-1452	STRAIGHTENING VANE, 36-42" F/H		11	11	11
3	D01-0528	INNER CAN, 26" & 28" F/H	1			
3	D01-1480	INNER CAN, 36" F/H		1	1	
3	D01-1479	INNER CAN, 40" F/H				1
4	401-5759-6-B	ACCESS DOOR-GALV FAN BLACK	1	1	1	1
5	069-1303-2	SIGHT GLASS	1	1	1	1
6	DC-1224	DECAL, DANGER HI-VOLTAGE	1	1	1	1
7	DC-1225	DECAL, WARNING ROTATING BLADE	1	1	1	1
8	DC-1227	DECAL, WARNING FIRE	1	1	1	1
9	HF-983	COLLECTOR CUP, 28" FAN HEATER	1			
9a	D01-1484	COLLECTOR CUP, 36" FAN HEATER		1	1	
9a	D01-1485	COLLECTOR CUP, 40" FAN HEATER				1
10	HF-7092	SUPPORT PLATE, 28" FAN HEATER	1			
10a	D01-1482	SUPPORT BRACKET, 36" FAN HEATER		1	1	
10a	D01-1483	SUPPORT BRACKET, 40" FAN HEATER				1

**Matching the right size fan heater to the model number of the dryer.**

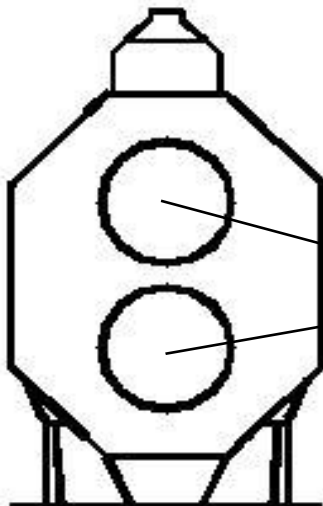

Fan Heater		Dryer Model No.				
		1214S	1218S	1220S	1222S	1226S
28", 10 - 12 hp	(2812)	x				
36", 10 - 12 hp	(3612)		x			
36", 10 - 16 hp	(3615)			x	x	
40", 25 hp	(4025)					x



## Fan Motor, Motor Mount, & Fan Blade

Fan motor and motor mount.

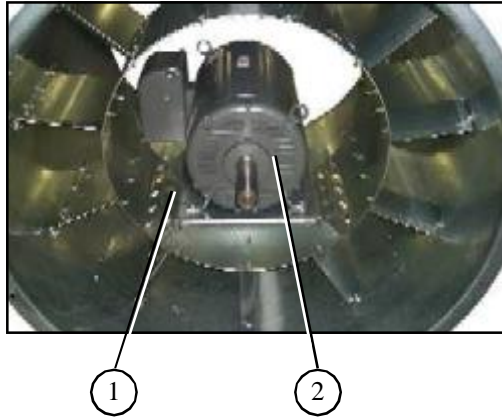

Fan blade and bushing.

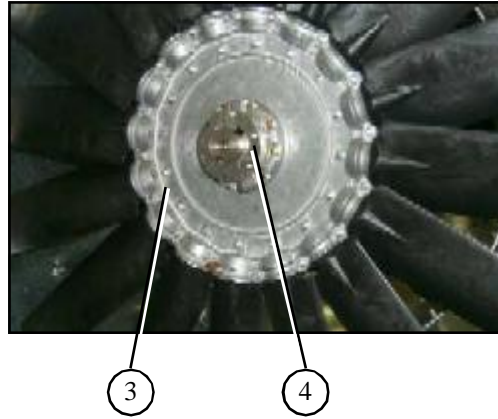

FAN HEATER; (Dia., HP)	ITEM NUMBER	DESCRIPTION	PART NUMBER				
			220V 1Ph	208V 3Ph	220V 3Ph	440V 3Ph	575V Ph
28" 12Hp	1	MOTOR MOUNT	D01-0530	D01-0530	D01-0530	D01-0530	D01-0530
	2	MOTOR	CD-0110	CD-0239	CD-0239	CD-0239	D03-0193
	3	FAN BLADE	D03-0302	D03-0302	D03-0302	D03-0302	D03-0302
	4	BUSHING	PT0778	PT0778	PT0778	PT0778	PT0778
36" 12Hp	1	MOTOR MOUNT	D01-1478	D01-1478	D01-1478	D01-1478	D01-1478
	NOT SHOWN	MOTOR MOUNT ADAPTER	CD-0233	CD-0233	CD-0233	CD-0233	CD-0233
	2	MOTOR	CD-0110	CD-0239	CD-0239	CD-0239	CH-6819
	3	FAN BLADE	D01-0468	D01-0468	D01-0468	D01-0468	D01-0468
36" 15Hp	4	BUSHING	FH-1009	FH-1009	FH-1009	FH-1009	FH-1009
	1	MOTOR MOUNT	D01-1478	D01-1478	D01-1478	D01-1478	D01-1478
	2	MOTOR	002-1073-2	CH-1050	CH-1050	CH-1050	CH-6820
	3	FAN BLADE	D82-0002	D82-0002	D82-0002	D82-0002	D82-0002
40" 25Hp	4	BUSHING	FH-1009	FH-6963	FH-6963	FH-6963	FH-6963
	1	MOTOR MOUNT	N/A	D01-1477	D01-1477	D01-1477	D01-1477
	2	MOTOR	N/A	C-2049	C-2049	C-2049	CH-6692
	3	FAN BLADE	N/A	D72-0003-25	D72-0003-25	D72-0003-25	D72-0003-25
	4	BUSHING	N/A	CE-00617	CE-00617	CE-00617	CE-00617

## Air Mixer Assemblies

Air mixer assemblies (36" air mixer shown in photo).

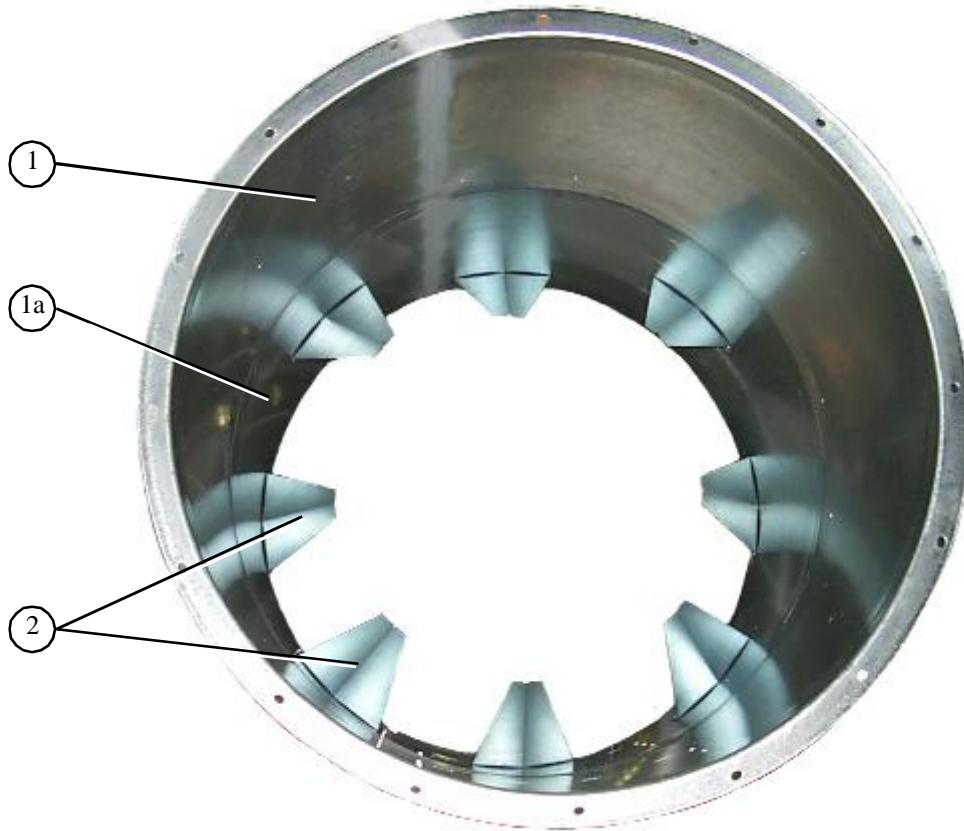

ITEM NUMBER	PART NUMBER	DESCRIPTION	28" F/H	36" F/H	40" F/H
1-2	D01-0955	AIR MIXER ASSEMBLY, 28"	1		
1	D01-0951	AIRMIXER CAN, 28" x 15" LONG		1/ASSEMBLY	
1a	D01-0950	AIRMIXER CAN, 28" x 8" SHORT		1/ASSEMBLY	
2	CD-0228	SMALL DIA. CAN AIR MIXER VANE		6/ASSEMBLY	
1-2	CD-0113	AIR MIXER ASSEMBLY, 36"		1	
1&1a	D01-1303	AIRMIXER CAN, 36" W/ACCESS		2/ASSEMBLY	
2	CD-0083	AIR MIXER VANE		8/ASSEMBLY	
1-2	CD-0117	AIR MIXER ASSEMBLY, 40"			1
1&1a	D01-1218	AIRMIXER CAN, 40" W/ACCESS		2/ASSEMBLY	
2	CD-0083	AIR MIXER VANE		8/ASSEMBLY	

## Flame Probe, Ignitor, Vaporizer Coil, and Burner Assemblies

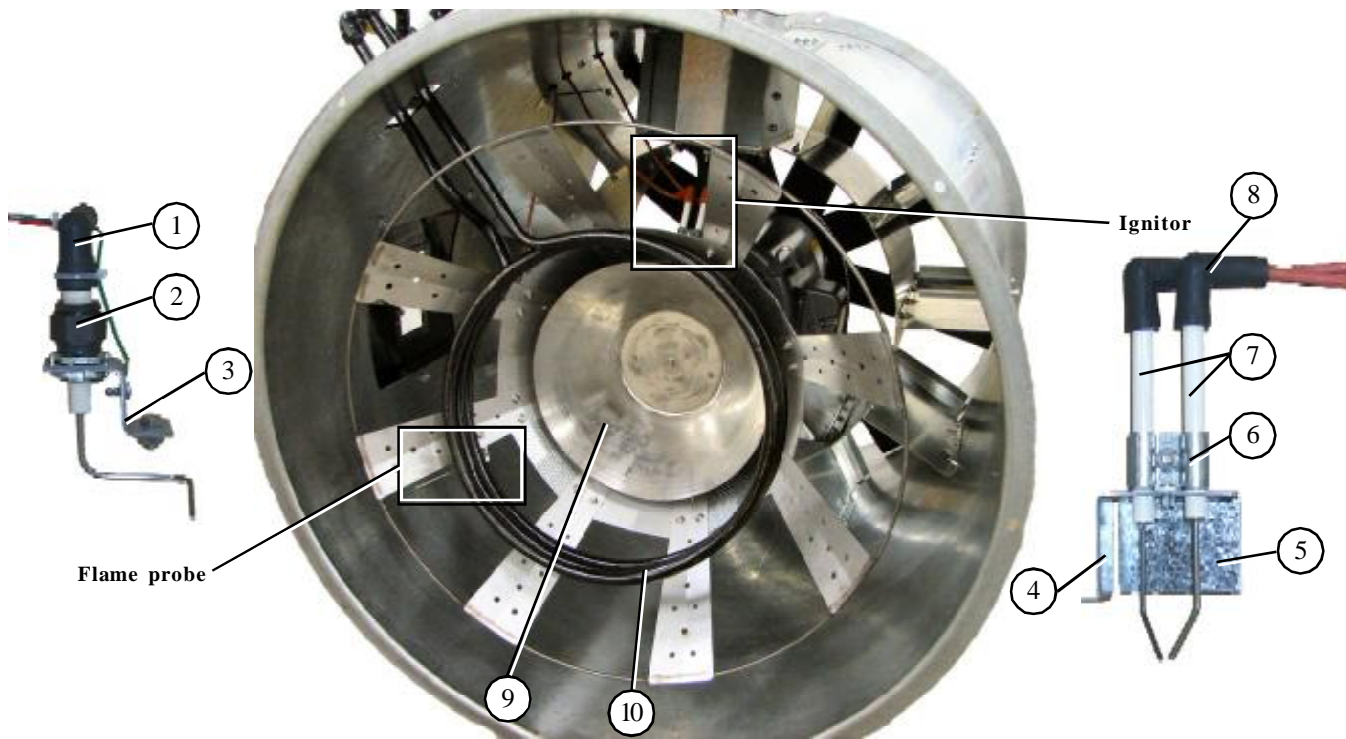

Items 9 and 10 are used in LP Fan/Heaters only.

ITEM	PART No.	DESCRIPTION	2812	3612	3615	4025
10	CD-0414	VAPORIZOR COIL 26 28" 3 WRAP	1			
10	HF-7207	VAPORIZOR COIL 36-42"10-17HP		1	1	
10	HF-7251	VAPORIZOR 3/4" 3 WRAP 36-42"				1
10	HF-7319	VAPOR COIL (SPIRAL) 42" 40HP				

Burner housing high limit switch.

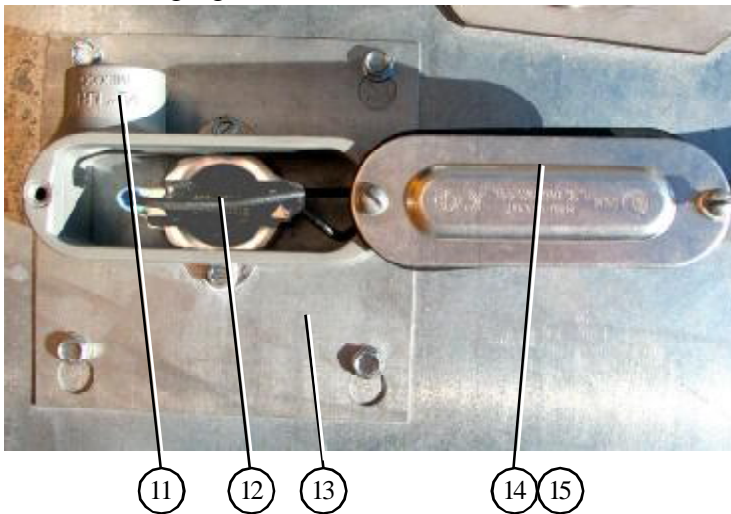

28" Fan heater burner assembly.

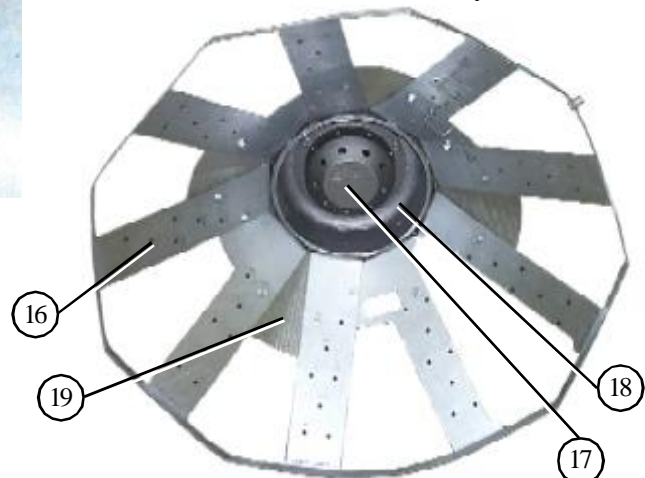

## Flame Probe, Ignitor, Vaporizer Coil, and Burner Assemblies

36" Fan heater burner assembly.

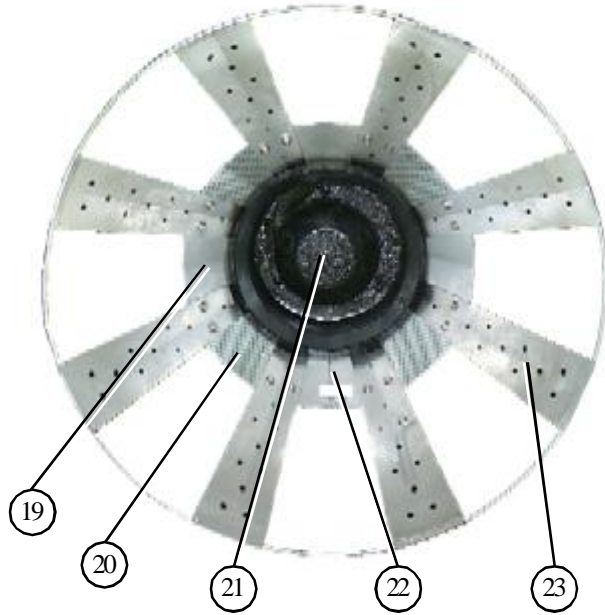

40" & 42" Fan heater burner assembly.

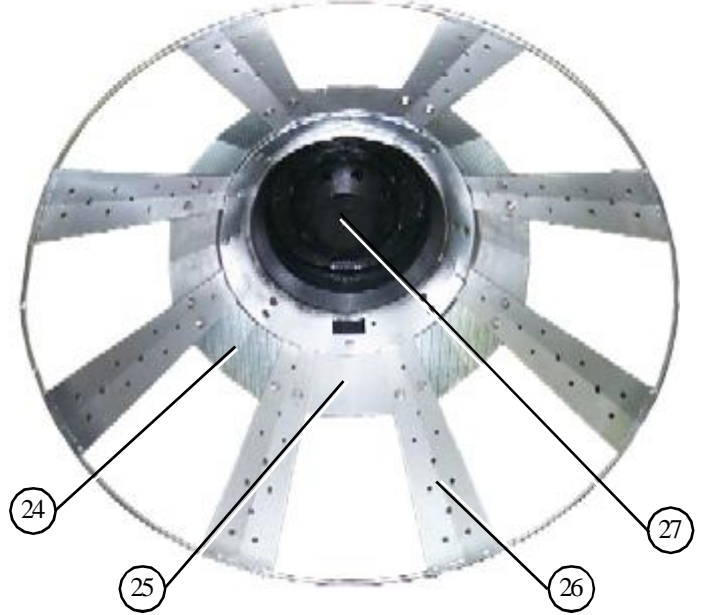

ITEM	PART NUMBER	DESCRIPTION	28" F/H	36" F/H	40" F/H
1-3	TF-1559-N	FLAME PROBE ASSY NETWK	1	1	1
1	HH-7025	BOOT 8MM SILICONE 90DEGREE	1/ASSEMBLY		
2	THH-4179	FLAME SENSOR 6" LONG ROD	1/ASSEMBLY		
3	CD-0187	FLAME SENSOR BRACKET	1/ASSEMBLY		
4-8	TF-1558	IGNITOR ASSEMBLY	1	1	1
4	HF-7204	DUAL PROBE IGNITOR BRACKET	1/ASSEMBLY		
5	D01-0878	IGNITOR AIR DEFLECTOR ANGLE	1/ASSEMBLY		
6	HF-7201	IGNITOR HALF CLAMP	2/ASSEMBLY		
7	CD-0238	IGNITOR FLAME	2/ASSEMBLY		
8	TF-1876	IGNITION WIRE ASSY (includes both wires)	1/ASSEMBLY		
9	HH-7054	CONE 26/28" BURNER S.S.	1		
9	HH-7056	CONE 36/42" BURNER S.S.		1	1
10	SEE CHART ON PAGE 36				
11	THH-4064	UNILET TYPE LRL CONDUITBX1/2"	1	1	1
12	027-1006-9	THERMOSTAT - HI LIMIT 200F AUT	1	1	1
13	D01-1473	HOUSING HI LIMIT PLATE	1	1	1
14	No Number	LID FOR LRL CONDUIT BOX IS PART OF ITEM 11	NOT APPLICABLE		
15	TFC-0076	NEOPRENE GASKET, CONDUIT BODY	1	1	1
15-18	BA-28	28" BURNER ASSEMBLY	1		
15	HF-7629	DIVERTER WELDMENT 28"	1/ASSEMBLY		
16	THF-3144	FLAME SPREADER 28"	1/ASSEMBLY		
17	THF-3141	HEATER GUN MACHINED 28"	1/ASSEMBLY		
18	THF-3113	28" DIVERTER BRACKET	1/ASSEMBLY		
19-23	BA-36	36" BURNER ASSEMBLY		1	
19	THF-3038	DIVERTER BRACKET 36" & 40"	3/ASSEMBLY		
20	THF-3038P	DIVERTER BRACKET 36" & 40" PERFD	4/ASSEMBLY		
21	THF-3039	DIVERTER BRACKET 36" & 40" W/HOLE	1/ASSEMBLY		
22	THF-3057	FLAME SPREADER 36-42"	1/ASSEMBLY		
23	CD-0091	BURNER WELDMENT CD 36" & 40"	1/ASSEMBLY		
24-27	BA-40-2	40" BURNER ASSEMBLY			1
24	CD-0448P	DIVERTER BRACKET 42" PERFD	4/ASSEMBLY		
25	CD-0448	DIVERTER BRACKET 42"	4/ASSEMBLY		
26	CD-0208	BURNER WELDMENT CD 42"	1/ASSEMBLY		
27	THF-3057	FLAME SPREADER 36-42"	1/ASSEMBLY		

## LP Pipe Train Assemblies

26" & 28" Fan heater LP pipe train assembly.

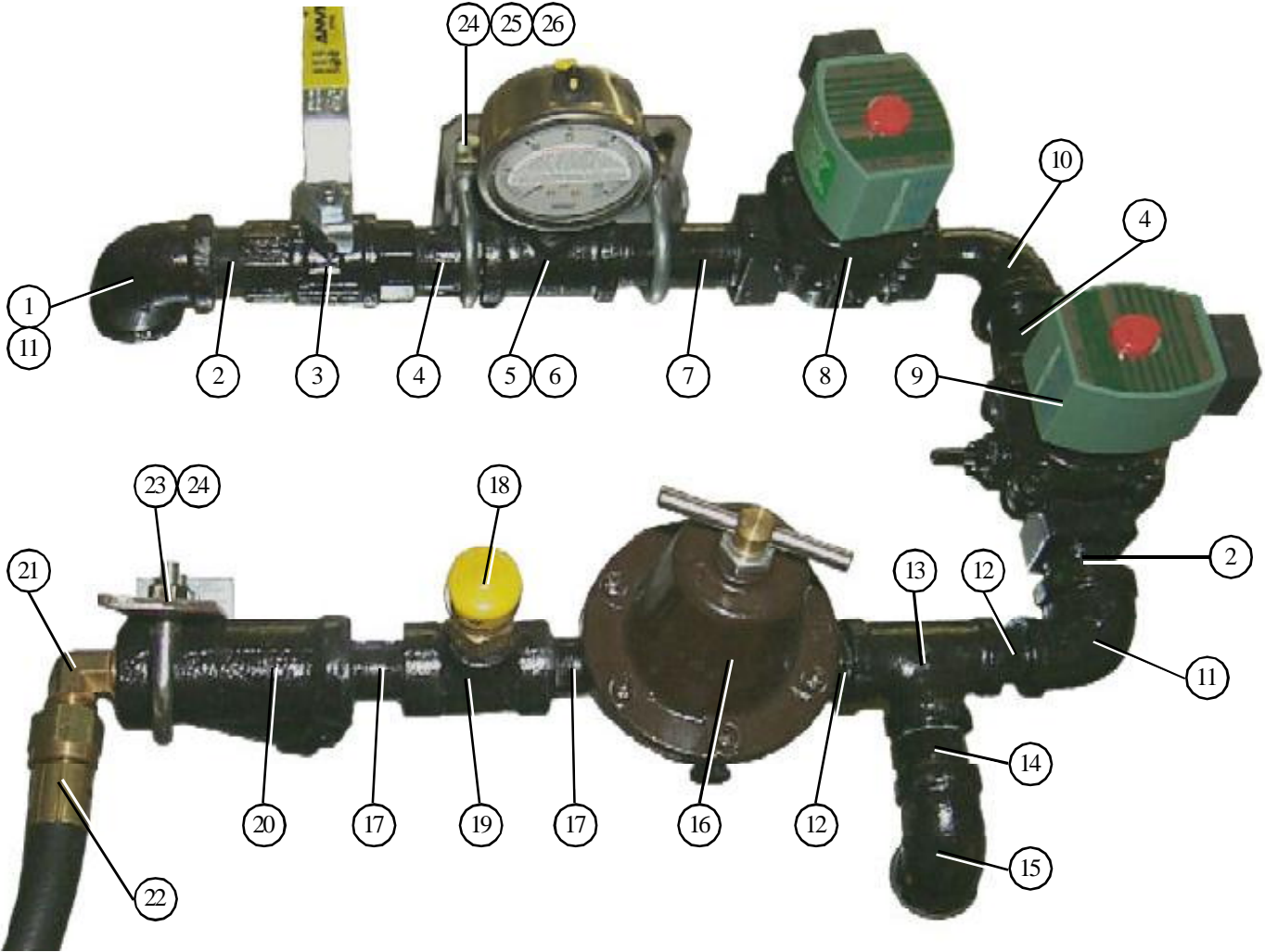

26" & 28" Vaporizer coil connection and adjustment brackets.

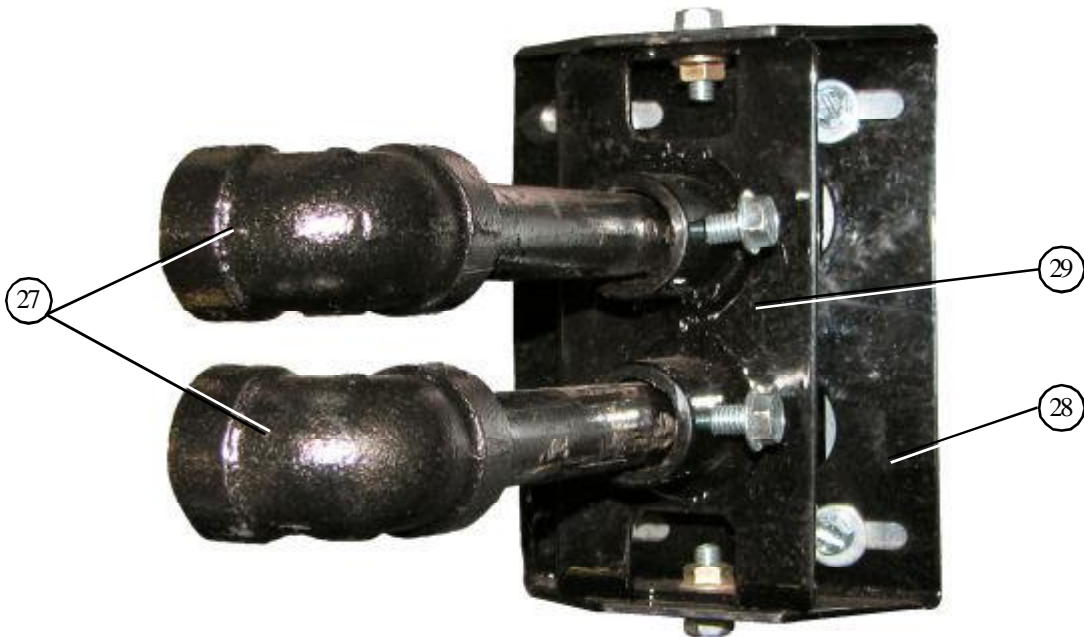

## LP Pipe Train Assemblies

---

ITEM NUMBER	PART NUMBER	DESCRIPTION	28" FAN
1	THH-4120	ELBOW, 3/4" - 90 DEG SCH 40	1
2	THH-4121	NIPPLE, 3/4" CLOSE SCH 40	2
3	007-1048-3	BALL VALVE, 3/4" W/LEVER HANDLE	1
4	THH-4125	NIPPLE, 3/4" x 2 SCH 40	2
5	THH-4154	TEE, 3/4" x 3/4" x 1/4" SCH 40	1
6	HH-2984	GUAGE, PRESSURE 0-30# LP	1
7	THH-4136	NIPPLE, 3/4" x 3" SCH 40	1
8	056-2223-8	VALVE, SOLENOID 3/4"NPT 115V DIN	1
9	056-2228-7	VALVE, SOLENOID 3/4"NPT 115V BYP	1
10	THH-4066	ELBOW 3/4-90 STREET SCH 40	1
11	THH-4149	ELBOW, 3/4"-1/2" REDUCER SCH 40	1
12	HH-2029	NIPPLE, 1/2" x 1 1/2" SCH 40	2
13	HH-1453	TEE, 1/2" x 1/2" x 1/2" SCH 40	1
14	HH-7013	SWITCH SCREW-IN VAPOR HI-LIMIT	1
15	THH-4071	ELBOW 1/2"-90 SCH 40	1
16	TFC-0023-50	REGULATOR, 1/2" NPT 50PSI	1
17	D07-0019	NIPPLE, 1/2" x 1 1/2" SCH 80	2
18	031-1008-7	PRESSURE RELIEF VALVE 300PSI	1
19	HH-4846	TEE, 1/2" x 1/2" x 1/4" SCH 80	1
20	HH-1251	STRAINER, 1/2" "Y" SCH 80	1
21	HH-1932	ELBOW, 1/2" PIPE - 1/2" FLARE BRASS	1
22	TFC-0095	HOSE, 1/2" x 24" LP GAS	2
23	TF-1227	PIPETRAIN BRACKET FOR 36 & 42"	1
24	326-1047-9	U-BOLT 5/16-18 X 1-3/8 X 2-3/16	3
25	401-5503-8	PLUMBG MTG BRKT	1
26	401-5255-5	PLUMBG MTG BASE BRKT	1
27	HH-4847	ELBOW, 1/2"-90 SCH 80	2
28	D01-2217	VAPORIZER SUPPORT PLATE BLACK	1
29	410-1783-1-B	VAPORIZER ADJUSTING WELD 1/2"	1

## LP Pipe Train Assemblies

36" Fan heater LP pipe train assembly.

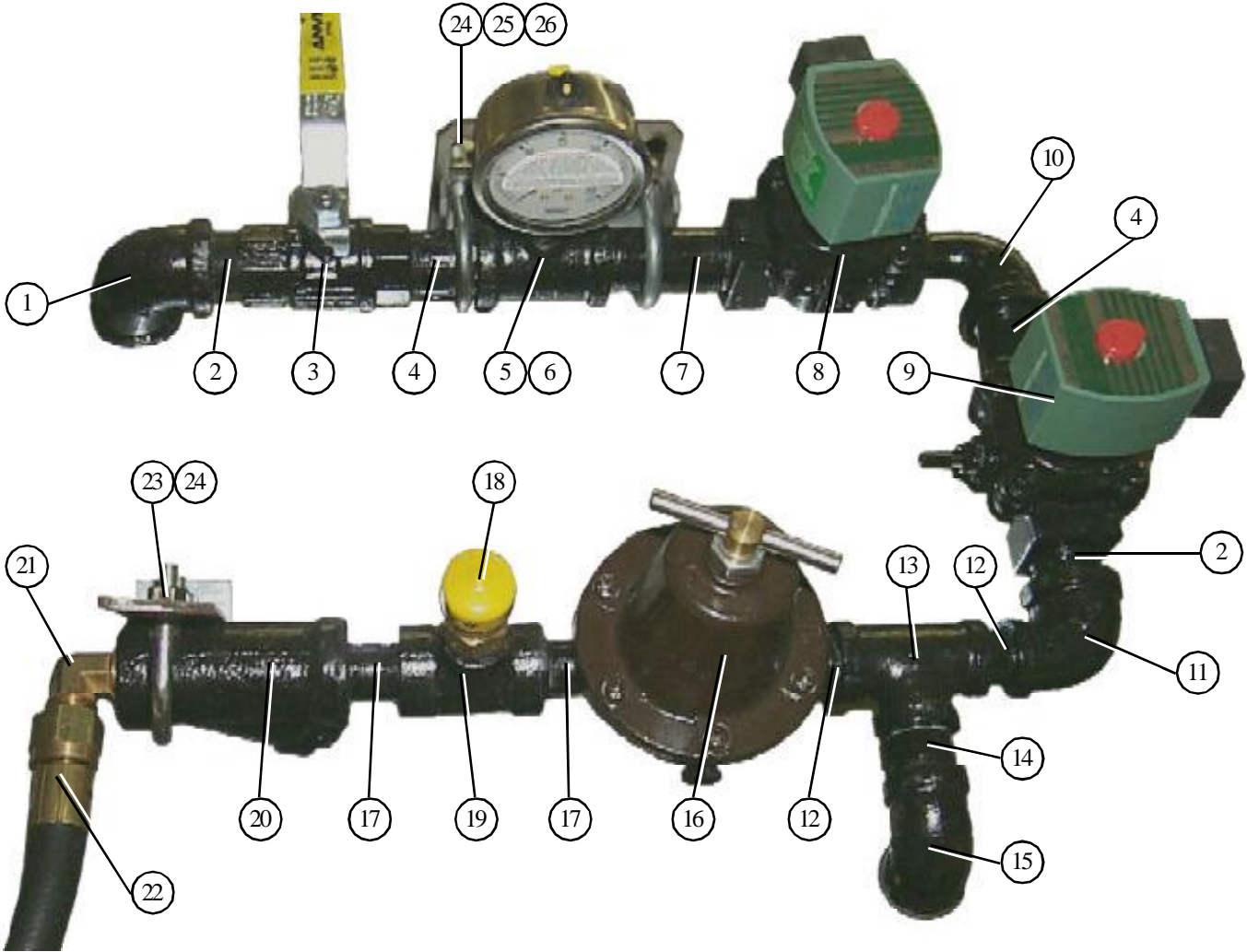

36" Vaporizer coil connection and adjustment brackets.

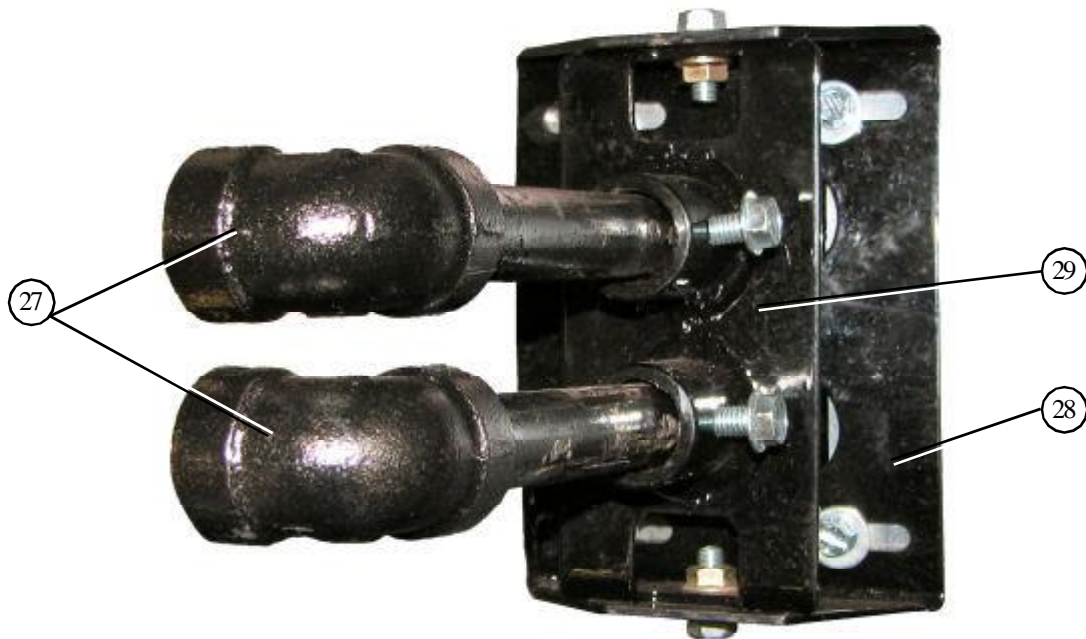

## LP Pipe Train Assemblies

---

ITEM NUMBER	PART NUMBER	DESCRIPTION	36" LP F/H
1	THH-4120	ELBOW, 3/4" - 90 DEG SCH 40	1
2	THH-4121	NIPPLE, 3/4" CLOSE SCH 40	2
3	007-1048-3	BALL VALVE, 3/4" W/LEVER HANDLE	1
4	THH-4125	NIPPLE, 3/4" x 2 SCH 40	2
5	THH-4154	TEE, 3/4" x 3/4" x 1/4" SCH 40	1
6	HH-2984	GUAGE, PRESSURE 0-30# LP	1
7	THH-4136	NIPPLE, 3/4" x 3" SCH 40	1
8	056-2223-8	VALVE, SOLENOID 3/4"NPT 115V DIN	1
9	056-2228-7	VALVE, SOLENOID 3/4"NPT 115V BYP	1
10	THH-4066	ELBOW 3/4-90 STREET SCH 40	1
11	THH-4149	ELBOW, 3/4"-1/2" REDUCER SCH 40	1
12	HH-2029	NIPPLE, 1/2" x 1 1/2" SCH 40	2
13	HH-1453	TEE, 1/2" x 1/2" x 1/2" SCH 40	1
14	HH-7013	SWITCH SCREW-IN VAPOR HI-LIMIT	1
15	THH-4071	ELBOW 1/2"-90 SCH 40	1
16	TFC-0023-50	REGULATOR, 1/2" NPT 50PSI	1
17	D07-0019	NIPPLE, 1/2" x 1 1/2" SCH 80	2
18	031-1008-7	PRESSURE RELIEF VALVE 300PSI	1
19	HH-4846	TEE, 1/2" x 1/2" x 1/4" SCH 80	1
20	HH-1251	STRAINER, 1/2" "Y" SCH 80	1
21	HH-1932	ELBOW, 1/2" PIPE - 1/2" FLARE BRASS	1
22	TFC-0095	HOSE, 1/2" x 24" LP GAS	2
23	TF-1227	PIPETRAIN BRACKET FOR 36 & 42"	1
24	326-1047-9	U-BOLT 5/16-18 X 1-3/8 X 2-3/16	3
25	401-5503-8	PLUMBG MTG BRKT	1
26	401-5255-5	PLUMBG MTG BASE BRKT	1
27	HH-4847	ELBOW, 1/2"-90 SCH 80	2
28	D01-2217	VAPORIZER SUPPORT PLATE BLACK	1
29	410-1783-1-B	VAPORIZER ADJUSTING WELD 1/2"	1



## LP Pipe Train Assemblies

40" LP pipe train assemblies.

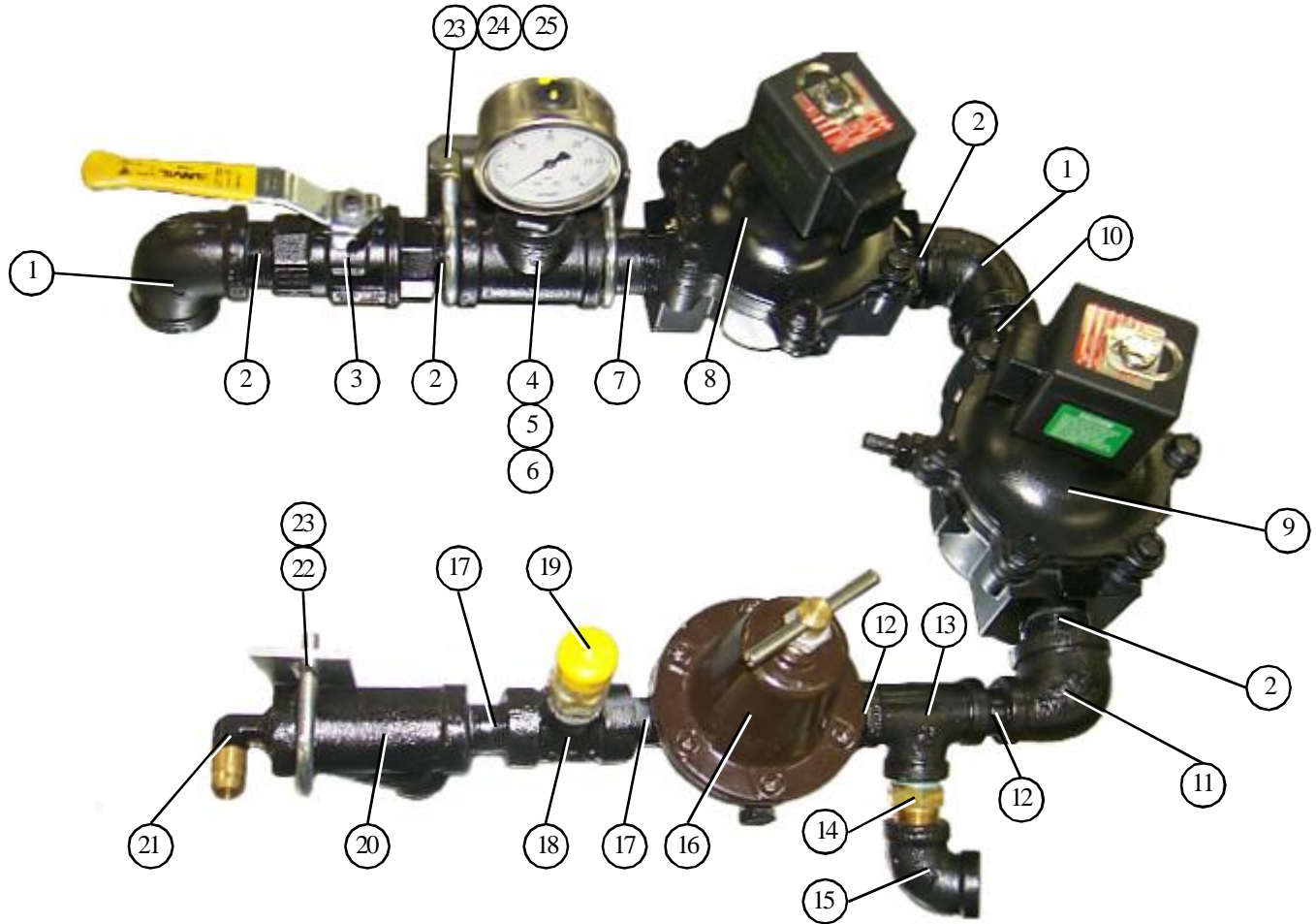

40" with 25hp and larger motors vaporizer coil connection and adjustment brackets.

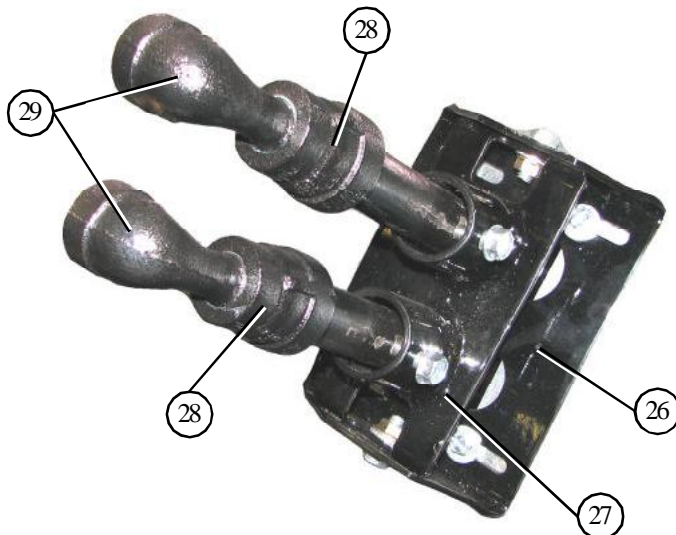

## LP Pipe Train Assemblies

---

ITEM NUMBER	PART NUMBER	DESCRIPTION	40" LP
1	THH-4115	ELBOW, 1" -90 DEG SCH 40	2
2	007-1104-4	NIPPLE, CLOSE 1"	4
3	007-1296-8	BALL VALVE, 1" WITH LEVER HANDLE	1
4	007-1106-9	TEE, 1" x 1" x 3/4"	1
5	D07-0027	REDUCER, 3/4"-1/4" HEX BUSHING	1
6	HH-2984	PRESSURE GUAGE, 0-30# LP	1
7	THH-4037	NIPPLE, 1" x 2 1/2" SCH 40	1
8	056-2224-6	VALVE, SOLENOID 1" NPT 115V DIN	1
9	056-2230-3	VALVE, SOLENOID 1" NPT 115V BYPASS	1
10	007-1242-2	NIPPLE, 1" x 2" SCH 40	1
11	007-1288-5	ELBOW, 1" - 1/2" SCH 40	1
12	HH-2029	NIPPLE, 1/2" x 1 1/2" SCH 40	2
13	HH-1453	TEE, 1/2" x 1/2" x 1/2" SCH 40	1
14	HH-7013	SWITCH SCREW-IN VAPOR HI-LIMIT	1
15	THH-4071	ELBOW 1/2"-90 SCH 40	1
16	TFC-0023-50	REGULATOR, 1/2" NPT - CSA 50PSI	1
17	D07-0019	NIPPLE, 1/2" x 1 1/2" SCH 80	2
18	HH-4846	TEE, 1/2" x 1/2" x 1/4" SCH 80	1
19	031-1008-7	PRESSURE RELIEF VALVE 300 PSI	1
20	HH-1251	STRAINER, 1/2" "Y" SCH 80	1
21	HH-1932	ELBOW, 1/2" PIPE - 1/2" FLARE BRASS	1
22	TF-1227	PIPETRAIN BRACKET FOR 36 & 42"	1
23	326-1047-9	U-BOLT 5/16-18 X 1-3/8 X 2-3/16	3
24	401-5503-8	PLUMBG MTG BRKT	1
25	401-5255-5	PLUMBG MTG BASE BRKT	1
26	D01-2217	VAPORIZER SUPPORT PLATE BLACK	1
27	D01-2220	VAPORIZER ADJUSTING WELD 3/4"	1
28	007-1930-2	REDUCER, BELL 3/4" - 1/2" SCH 80	2
29	HH-1082	ELBOW, 1/2"-90 DEG STREET SCH 80	2

## NG Pipe Train Assemblies

26" & 28" Fan heater NG pipe train assembly.

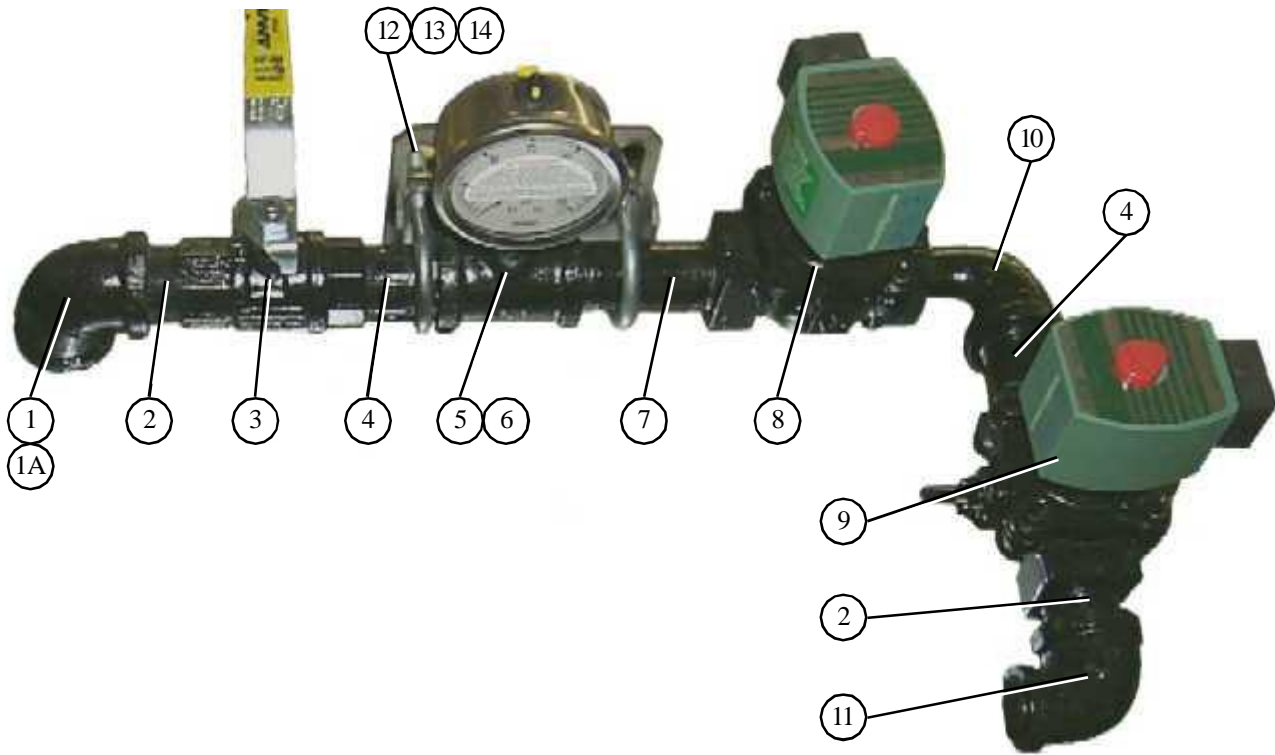

ITEM NUMBER	PART NUMBER	DESCRIPTION	28" FANS
1	THH-4120	ELBOW, 3/4" -90 SCH 40	1
2	THH-4121	NIPPLE, 3/4" CLOSE SCH 40	2
3	007-1048-3	BALL VALVE, 3/4" W/LEVER HANDLE	1
4	THH-4125	NIPPLE, 3/4" x 2" SCH 40	2
5	THH-4154	TEE, 3/4" x 3/4" x 1/4" SCH 40	1
6	D08-0022	GAUGE, PRESSURE 0-15#	1
7	THH-4136	NIPPLE, 3/4" x 3" SCH 40	1
8	056-2223-8	VALVE, SOLENOID 3/4"NPT 115V DIN	1
9	056-2228-7	VALVE, SOLENOID 3/4"NPT 115V BYP	1
10	THH-4066	ELBOW, 3/4" x 90 DEG STREET SCH 40	1
11	007-1307-3	ELBOW, 1 - 3/4" REDUCER SCH 40	1
12	326-1047-9	U-BOLT 5/16-18 X 1-3/8 X 2-3/16	2
13	401-5503-8	PLUMBG MTG BRKT	1
14	401-5255-5	PLUMBG MTG BASE BRKT	1

## NG Pipe Train Assemblies

36" Fan heater NG pipe train assembly.

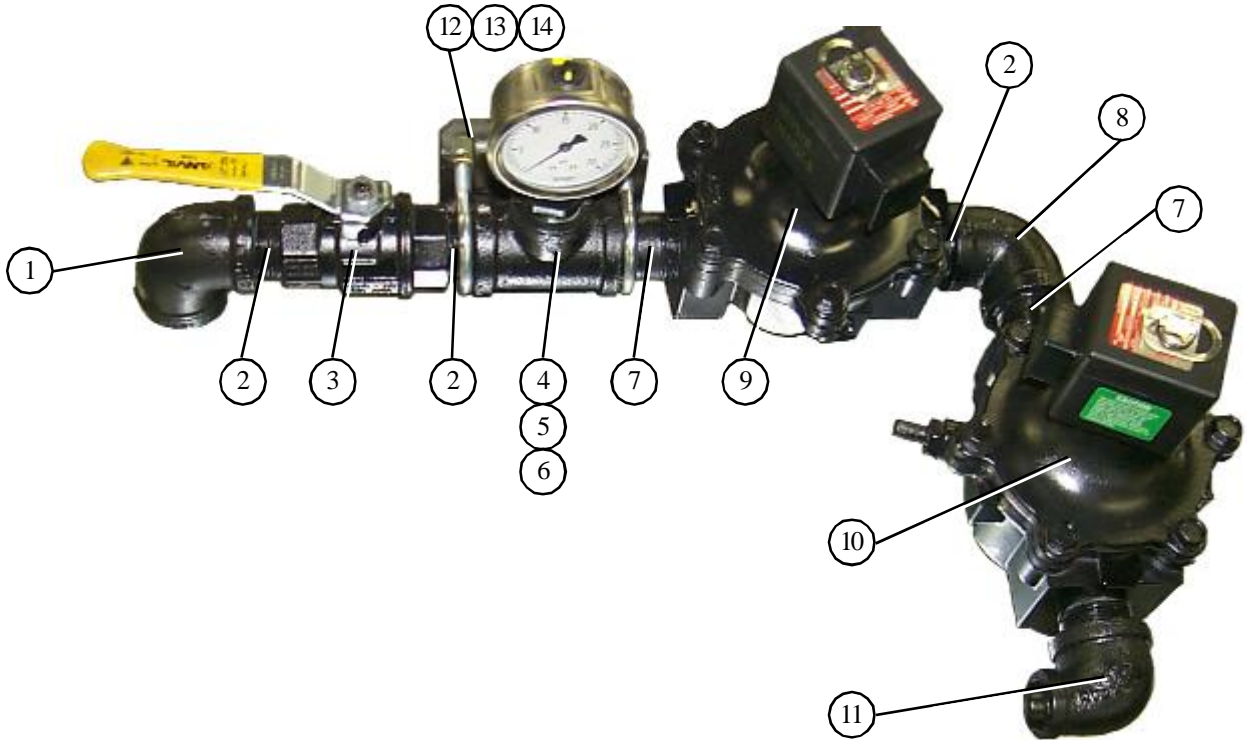

ITEM NUMBER	PART NUMBER	DESCRIPTION	36" FAN
1	007-1307-3	ELBOW, 1" - 3/4"	1
2	007-1104-4	NIPPLE, CLOSE 1"	3
3	007-1296-8	BALL VALVE, 1" W/LEVER HANDLE	1
4	007-1106-9	TEE, 1" x 1" x 3/4"	1
5	D07-0027	REDUCER, 3/4" - 1/4" HEX BUSHING	1
6	D08-0022	GAUGE, PRESSURE 0-15#	1
7	007-1242-2	NIPPLE, 1" x 2" SCH 40	2
8	THH-4115	ELBOW, 1"-90 DEG. SCH 40	1
9	056-2224-6	VALVE, SOLENOID 1"NPT 115V DIN	1
10	056-2230-3	VALVE, SOLENOID 1"NPT 115V W/BYP	1
11	THH-4164	ELBOW, 1"-90 DEG. STREET SCH 40	1
12	326-1047-9	U-BOLT 5/16-18 X 1-3/8 X 2-3/16	2
13	401-5503-8	PLUMBG MTG BRKT	1
14	401-5255-5	PLUMBG MTG BASE BRKT	1

## NG Pipe Train Assemblies

40" & 42" Fan heater NG pipe train assembly.

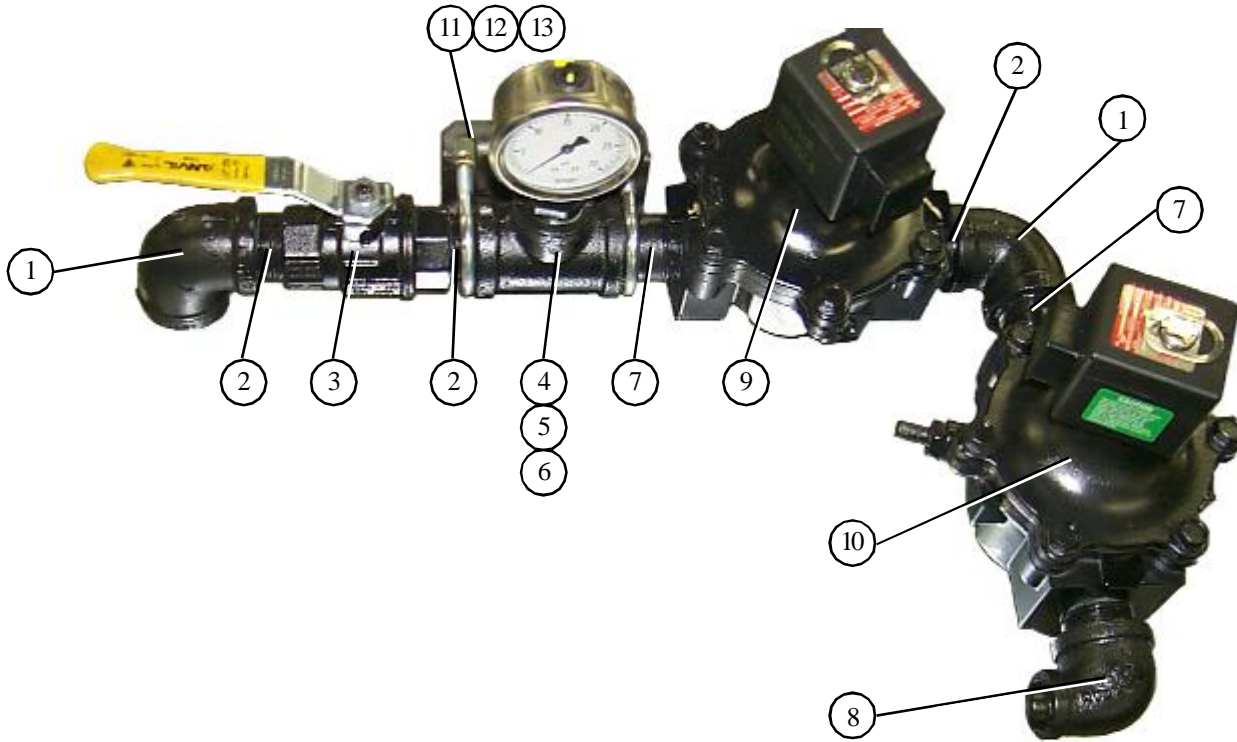

ITEM NUMBER	PART NUMBER	DESCRIPTION	40" FANS
1	THH-4115	ELBOW, 1" - 90 DEG SCH 40	2
2	007-1104-4	NIPPLE, CLOSE 1"	3
3	007-1296-8	BALL VALVE, 1" W/LEVER HANDLE	1
4	007-1106-9	TEE, 1" x 1" x 3/4"	1
5	D07-0027	REDUCER, 3/4" - 1/4" HEX BUSHING	1
6	D08-0022	GAUGE, PRESSURE 0-15#	1
7	007-1242-2	NIPPLE, 1" x 2" SCH 40	2
8	THH-4164	ELBOW, 1"-90 DEG. STREET SCH 40	1
9	056-2224-6	VALVE, SOLENOID 1"NPT 115V DIN	1
10	056-2230-3	VALVE, SOLENOID 1"NPT 115V W/BYP	1
11	326-1047-9	U-BOLT 5/16-18 X 1-3/8 X 2-3/16	2
12	401-5503-8	PLUMBG MTG BRKT	1
13	401-5255-5	PLUMBG MTG BASE BRKT	1

LIQUID PROPANE ORIFICES

FAN HEATER	ORIFICE SIZE	PART NUMBER	ITEM NO.
28"12hp	.25"	THF-3241	3
36"12hp	.2813"	THF-3242	3
36"15hp	.3281"	CD-0150	3
40"25hp	.3438"	THF-3058	3

NATURAL GAS ORIFICES

FAN HEATER	ORIFICE SIZE	PART NUMBER	ITEM NO.
28"12hp	.375"	THF-3140	3
36"12hp	.4063"	THF-3243	3
36"15hp	.5"	THF-3244	3
40"25hp	.5156"	THF-3246	3

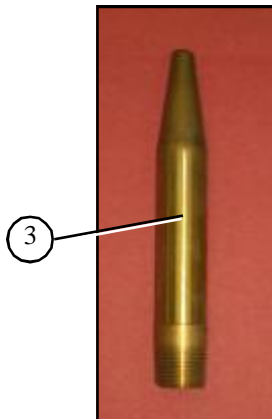

## LP Supply Line

Liquid propane fuel supply line.

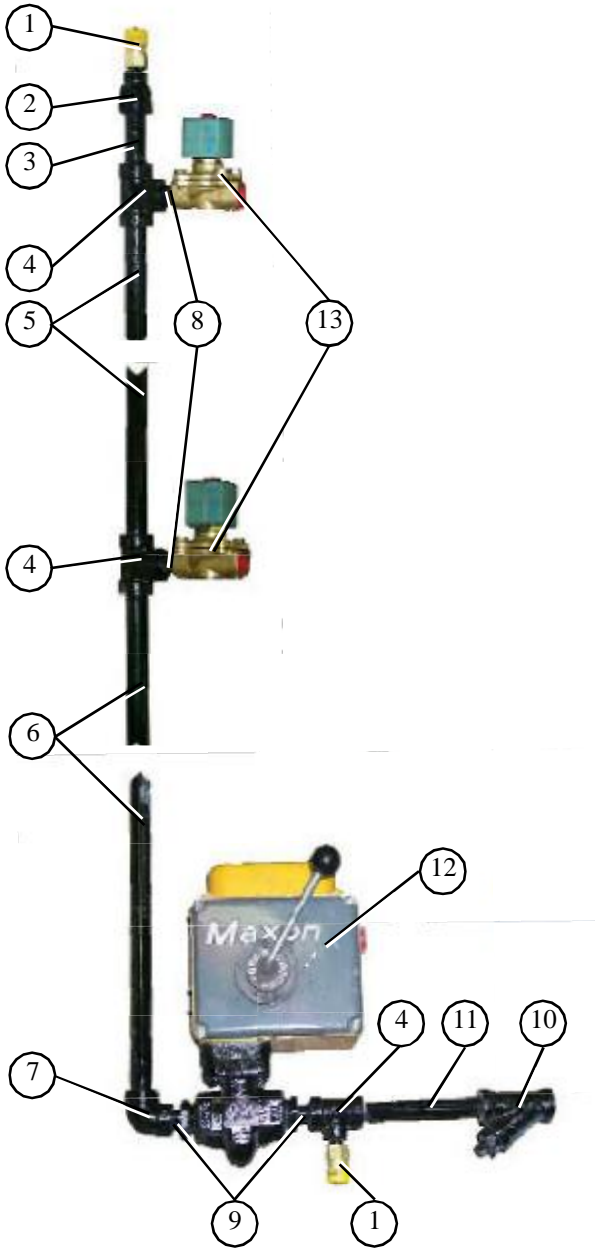

Supply line mounting brackets.



ITEM No.	PART No.	DESCRIPTION	1214S-22S	1226S
1	TFC-0027	VALVE, 1/4" NPT 250 PSI RELIEF	2	2
2	D67-0015	RDCR 3/4" x 1/4" BELL SCH 80	1	1
3	D67-0016	NIPPLE, 3/4" x 8" SCH 80	1	1
4	HH-7036	TEE, 3/4" x 3/4" x 1/2" SCH 80	2	2
5	D67-0019	NIPPLE, 3/4" x 42" SCH 80	1	
5	D01-1011	NIPPLE, 3/4" x 46" SCH 80		1
6	D67-0018	NIPPLE, 3/4" x 68"	1	
6	D01-1018	NIPPLE, 3/4" x 68"		1
7	D67-0011	ELBOW, 3/4"-90 SCH 80	1	1
8	D07-0019	NIPPLE, 1/2" x 1 1/2" SCH 80	2	2
9	D67-0021	NIPPLE, 3/4" CLOSE SCH 80	2	2
10	D67-0008	STRAINER, "Y" SCH 80	1	1
11	D67-0016	NIPPLE, 3/4" x 8" SCH 80	1	1
12	D28-0001	VALVE, 3/4" NPT ELECT SHUTOFF	1	1
13	TFC-0092	VALVE, 1/2" NPT SOLENOID LP GAS	2	2
14	D31-0074	GAS MANIFOLD MOUNTING BRACKET	3	3
15	HH-1096	CLAMP, 1/2"	3	3
16	D31-0075	GAS MANIFOLD CARRIER BRACKET	1	1

## NG Supply Line

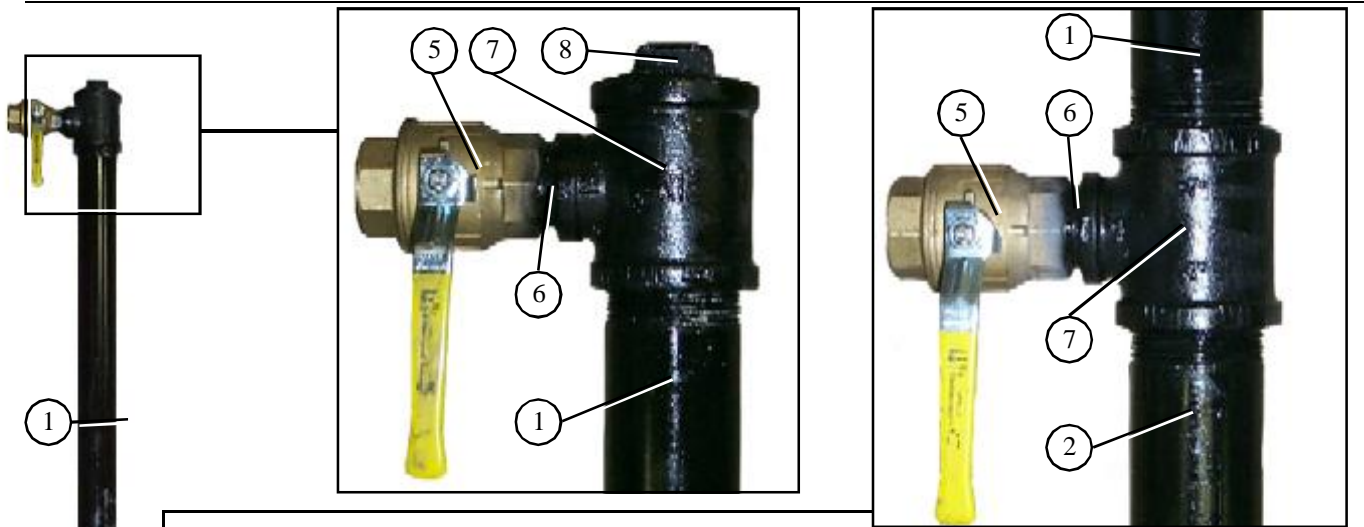

ITEM No.	PART NUMBER	DESCRIPTION	1214S	1218S-26S
1	D01-1013	NIPPLE 2 1/2" x 45" SCH 40	1	1
2	D01-1015	NIPPLE 2 1/2" x 34" SCH 40	1	1
3	D68-0016	NIPPLE 2 1/2" x 26" SCH 40	1	1
4	D68-0004	UNION 2 1/2" FEMALE SCH 40	1	1
5	D08-0023	VALVE 1" NPT B-COCK	2	
5	D08-0008	VALVE 1 1/2" NPT B-COCK		2
6	THH-4117	NIPPLE 1" CLOSE SCH 40	2	
6	D08-0009	NIPPLE 1 1/2" CLOSE SCH 40		2
7	HH-7087	TEE 2 1/2" x 2 1/2" x 1" SCH 40	2	
7	D68-0002	TEE 2 1/2" x 2 1/2" x 1 1/2" SCH 40		2
8	D68-0010	PLUG 2 1/2" SQUARE SCH 40	1	1
9	D68-0015	VALVE 2 1/2" NPT ELECT SHUTOFF	1	1
10	D68-0014	ELBOW 2 1/2"-90 SCH 40	1	1
11	D68-0012	NIPPLE 2 1/2" x 4" SCH 40	1	1
12	D68-0018	NIPPLE 2 1/2" x 9" SCH 40	1	1
13	D68-0011	STRNR 2 1/2" Y SCH 40	1	1

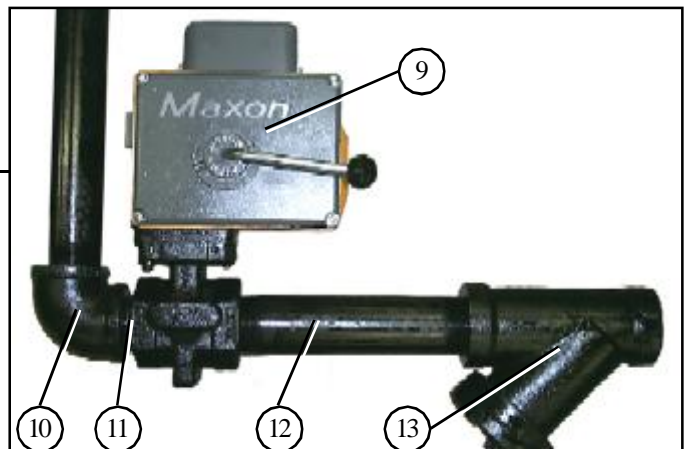



## Right & Left Grain and Plenum High Limits

Right grain high limit thermostat enclosures.

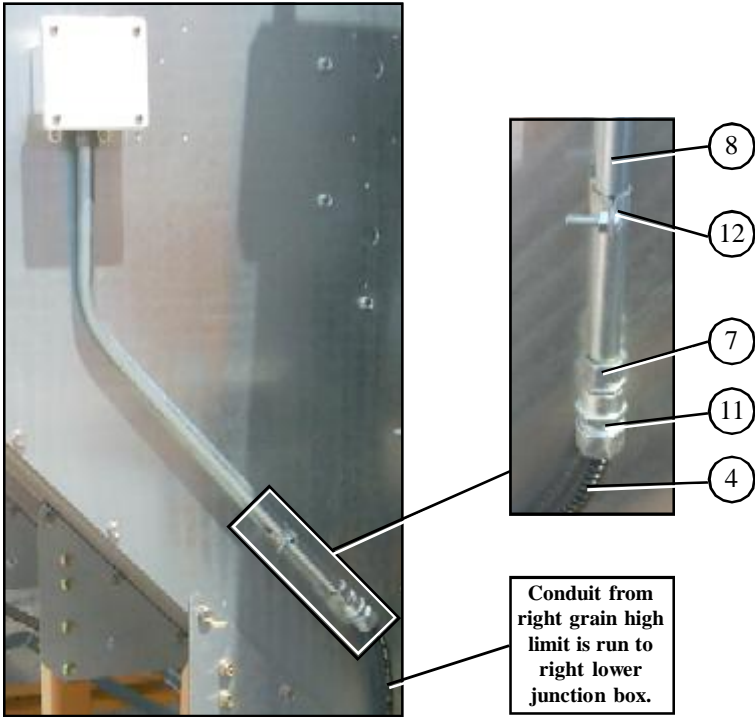

Left grain and plenum high limit thermostat enclosures.

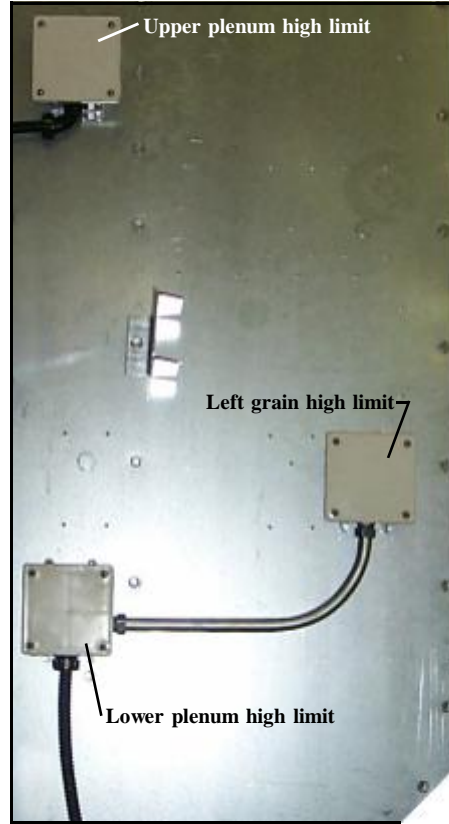

Upper plenum high limit thermostat.

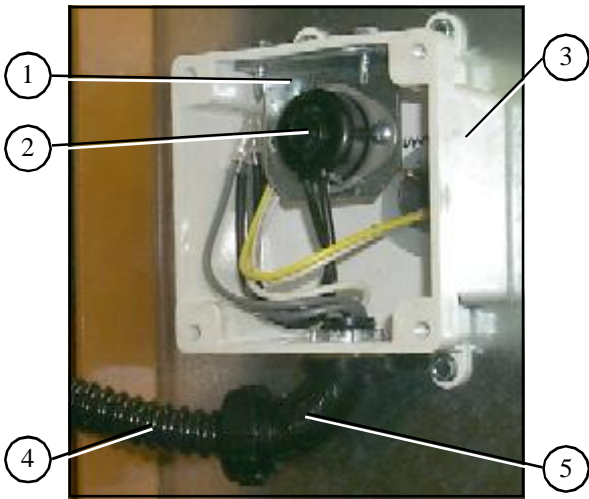

Grain temperature thermister. There are 2 thermisters in each (right & left) grain high limit thermostat assemblies.



Lower plenum high limit thermostat.

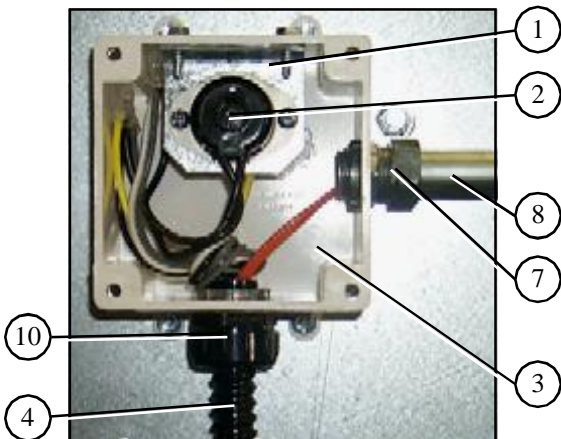

Right & left grain high limit thermostat.

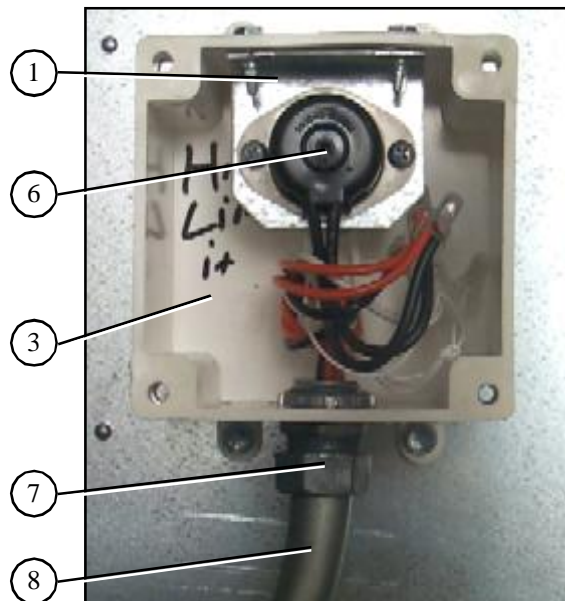

## Right & Left Grain and Plenum High Limits

Upper plenum high limit thermostat conduit.

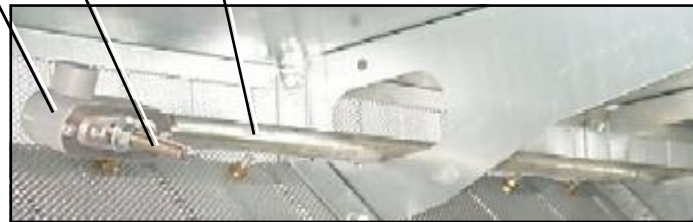
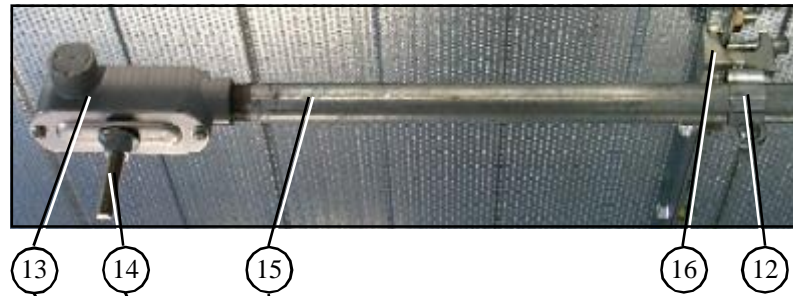

Lower plenum high limit thermostat conduit.

ITEM No.	DESCRIPTION	PART No.
1	HIGH LIMIT MOUNTING BRACKET	D01-0254
2	plenum-thermostat 10' 300deg (for 14' dryers only)	D03-0004
2	PLENUM-THERMOSTAT 24' 300DEG (for dryers that are 16' and longer)	D03-0377
3	ENCLOSURE 4x4x2.5 WHITE PVC	FH-6972
4	SEALTITE PVC 3/8"	FH-7038
5	ELBOW 3/8" 90 DEGREE PVC W/NUT	FH-7050
6	grain thermo hi-lmt 10' 210deg (for 14' dryers only)	D03-0005
6	GRAIN THERMO HI-LMT 24' 210DEG (for dryers that are 16' and longer)	D03-0378
7	CONNECTOR 1/2" EMT COMPRESSION	D03-0054
8	CONDUIT 1/2" EMT METALLIC	D03-0057
9	GRAIN TEMP THERMISTOR SER2000	D03-0258
10	SEAL 3/8 STRAIGHT PVC W/NUT	FH-7049
11	CONNECTOR 3/8" LIQUID-TITE TO 1/2" EMT	D03-0060
12	CLAMP 1/2" CONDUIT	HH-1096
13	CONDUIT BODY, LL TYPE	D03-0375
13	COVER ALUMINUM, CONDUIT BODY	TFC-0075
14	PLENUM THERMISTOR BOLT	HF-7236
15	PIPE SCH 40 1/2"	DM60001
16	CLAMP, BEAM 1/2"	GT3-0241
the following components make up the grain high limit conduits that run through the grain columns. The conduit assemblies are not shown in the photos.		
not shown	conduit 1/2" emt metallic	D03-0057
not shown	connector 1/2" emt compression (2/conduit; 1 at each end of the dryer.)	D03-0054
not shown	coupler 1/2" emt compression (couples the lengths of 1/2" emt)	D33-0002
not shown	enclosure 4x4x2.5 white pvc (as of 2003 a 4x4 enclosure has been added to these assemblies and is mounted on the rear column end panels into which thr grain high limit thermostat conduits now terminate.)	FH-6972

Lower Junction Box, Meter Roll Motor Conduit, Rear Discharge Conduit

Lower junction box (right).

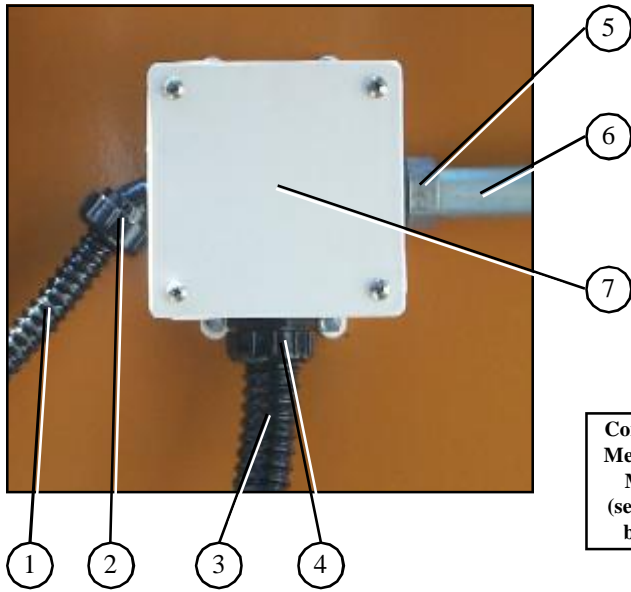

Lower junction box (left).

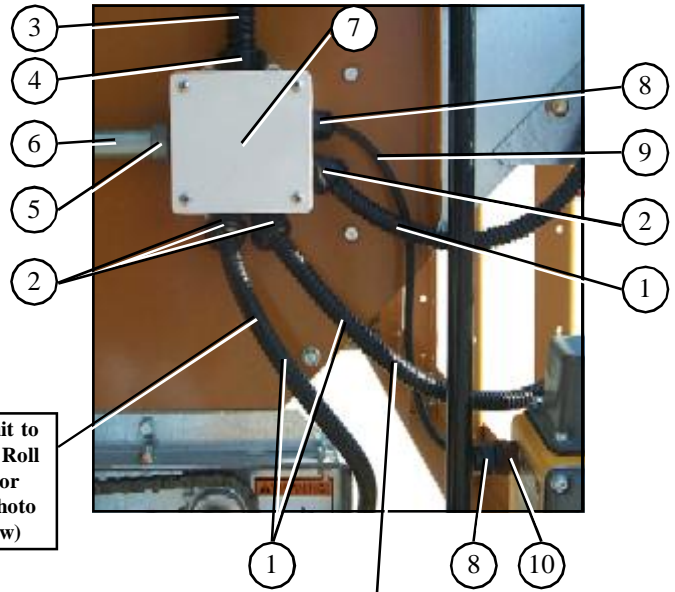

Conduit to Meter Roll Motor (see photo below)

Conduit to Meter Roll Speed Sensor & Rear Discharge Switch (see photos below & on next page)

Meter roll motor conduit connection.



Meter roll speed sensor and rear discharge switch conduit. This is a photo of the front section of the conduit that runs through the gussets on the left side of the dryer.

Rear discharge switch conduit at rear left gusset where 1/2" EMT conduit terminates.

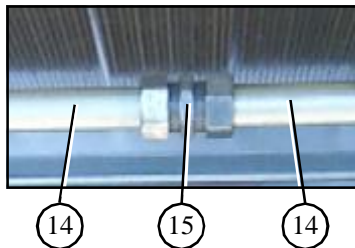
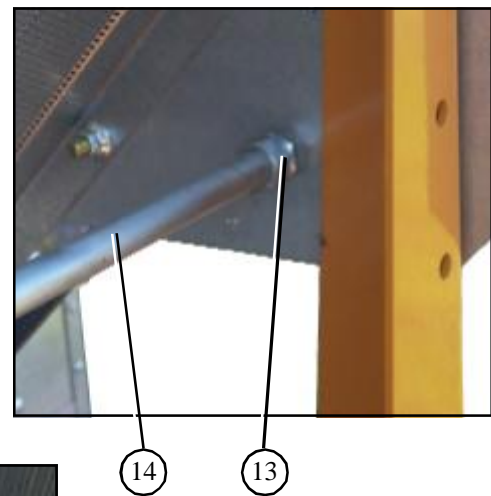
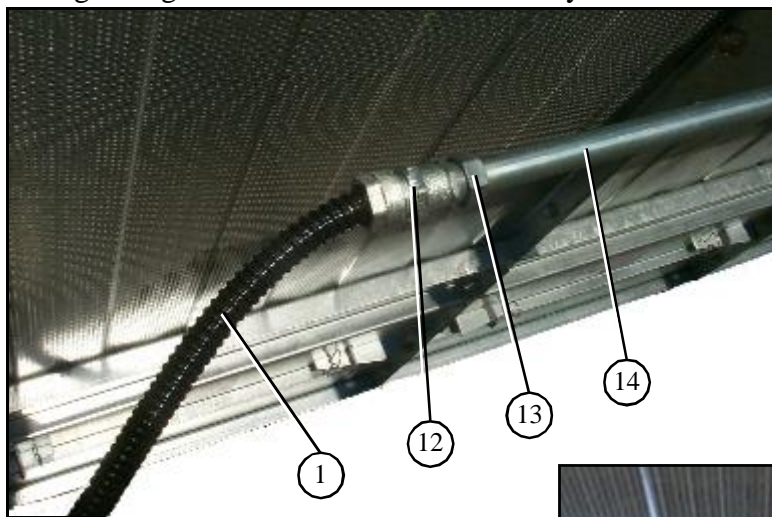

Coupler for 1/2" EMT conduit.

## Lower Junction Box, Meter Roll Motor Conduit, Rear Discharge Conduit

Rear discharge switch conduit at rear left gusset.

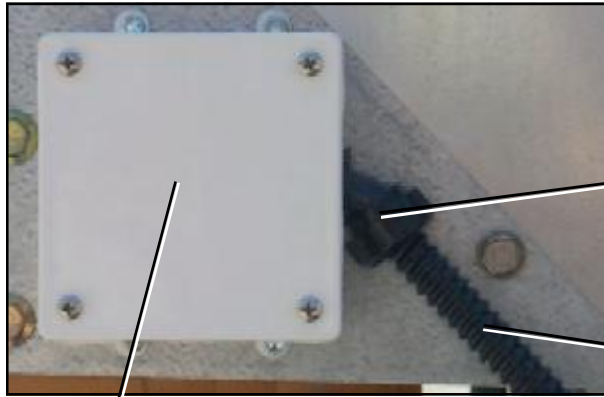

7

Meter roll speed sensor.

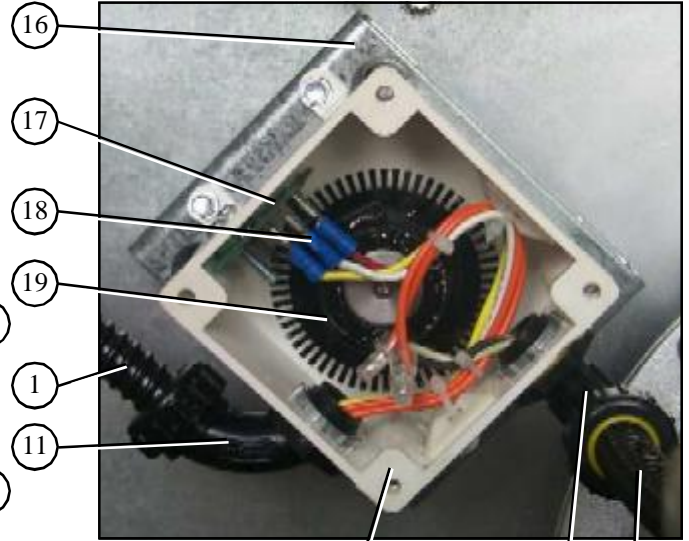

16

17

18

19

11

1

7

11

1

Rear discharge switch (open to show mercury switch).

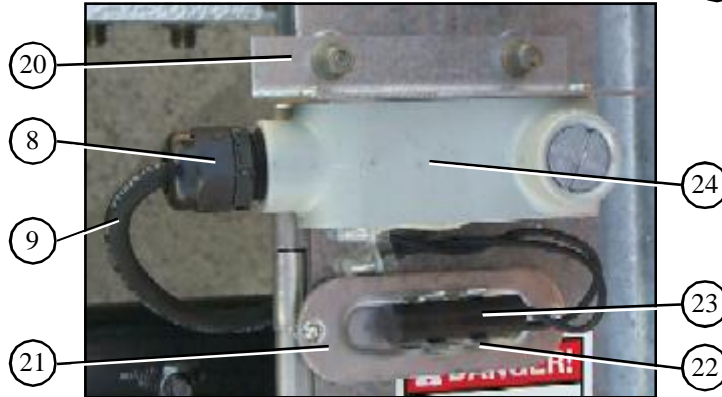

20

8

9

21

24

23

22

ITEM No.	DESCRIPTION	PART No.
1	SEALTITE PVC 3/8"	FH- 7038
2	CONNECTOR PVC 3/8" 45' W/NUT	F- 6913
3	SEALTITE PVC 3/4"	FH- 7063
4	STRAIGHT PVC W/LOCKNUT 3/4"	FH- 7053
5	FITTING COMPRESSION 3/4- TO BOX	D03- 0199
6	CONDUIT 3/4" EMT	D03- 0086
7	ENCLOSURE 4x4x2.5 WHITE PVC	FH- 6972
8	CONNECTOR 1/2"	FH- 1310
9	WIRE 18/2 TYPE SJOW-A BLACK	WR- 182SJOWA
10	RDCR 3/4" X1/2" HEX BUSHING	D07- 0028
11	ELBOW 3/8" 90 DEGREE PVC W/NUT	FH- 7050
12	CONNECTOR 3/8" LIQUID-TITE TO 1/2" EMT	D03- 0060
13	CONNECTOR 1/2" EMT COMPRESSION	D03- 0054
14	CONDUIT 1/2" EMT METALLIC	D03- 0057
15	CONNECTOR 1/2" EMT COMPRESSION	D33- 0002
16	SPEED SENSOR BOX BRACKET	D01- 0462
17	SCR METER ROLL SPEED SENSOR	D01- 0527
18	DISCONNECT .187 FEM	HH- 7046
19	METERING ROLL TIMING GEAR ASSB	D01- 0687
20	DISCHARGE SWITCH MOUNTING PLATE	D01- 1105
21	COVER ALUMINUM, CONDUIT BODY	TFC- 0075
22	CLIP, MERCURY SWITCH	SPD- 2098
23	MERCURY SWITCH	D03- 0010
24	CONDUIT BODY, LL TYPE	D03- 0375

## Upper Junction Box, Top Auger Motor Conduit, & Operator Light

Upper junction box.

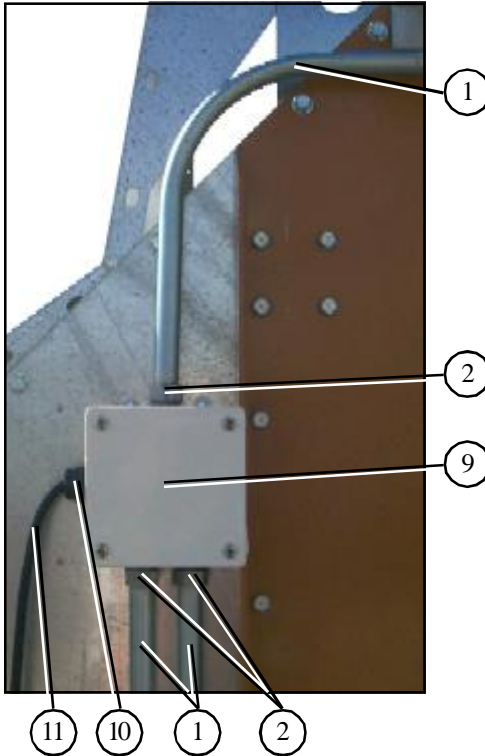

Top auger motor conduit.

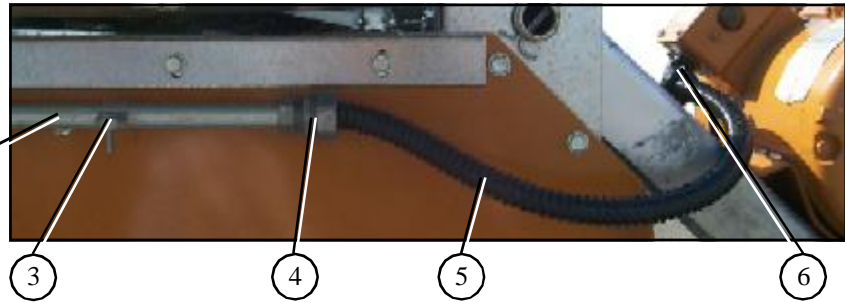

Operator light.

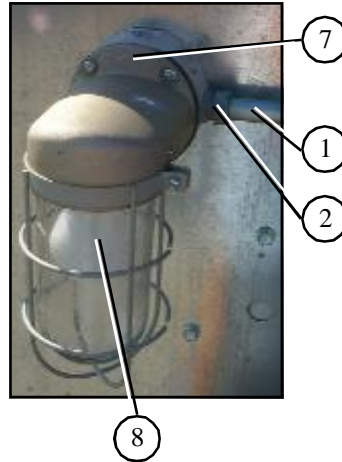

Fill switch assembly (installed).

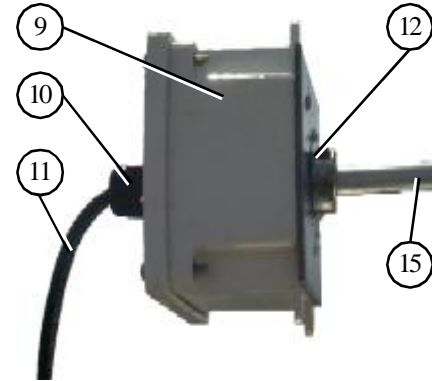

Fill switch assembly (opened).

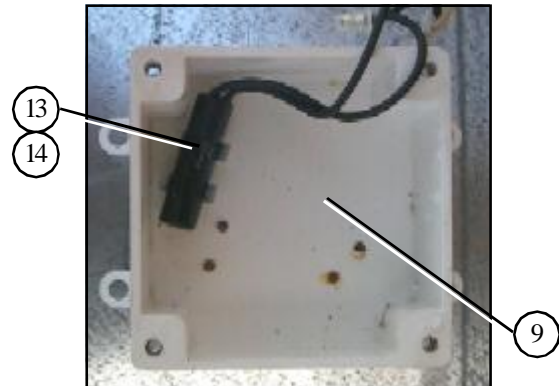

Items 9 - 14 are components of the mercury switch box assembly (fill switch assembly) part no. D01-0192.

ITEM No.	DESCRIPTION	PART No.
1	CONDUIT 1/2" EMT METALLIC	D03-0057
2	CONNECTOR 1/2" EMT COMPRESSION	D03-0054
3	CLAMP 1/2" CONDUIT	HH-1096
4	CONNECTOR 1/2" EMT TO SEALTITE	D03-0075
5	SEALTITE PVC 1/2"	FH-7039
6	ELBOW 1/2" 90 DEGREE PVC WITH	FH-7052
7	LAMP 90 DEGREE W/JUNC.BOX	D03-0117
8	BULB, 100W 130V ROUGH SERVICE	D03-0575
9	ENCLOSURE 4x4x2.5 WHITE PVC	FH-6972
10	CONNECTOR 1/2"	FH-1310
11	WIRE 18/2 TYPE SJOW-A BLACK	WR-182SJOWA
12	MOUNTING PLATE W/LDMNT, MERC.BX	D01-0358
13	MERCURY SWITCH 6-DEG. 6" LEADS	D03-0010
14	CLIP MERCURY SWITCH	SPD-2098
15	MERCURY SWITCH SHAFT	D01-0103

## Air Switch Assembly

Air switch assembly (part # D01-0672).

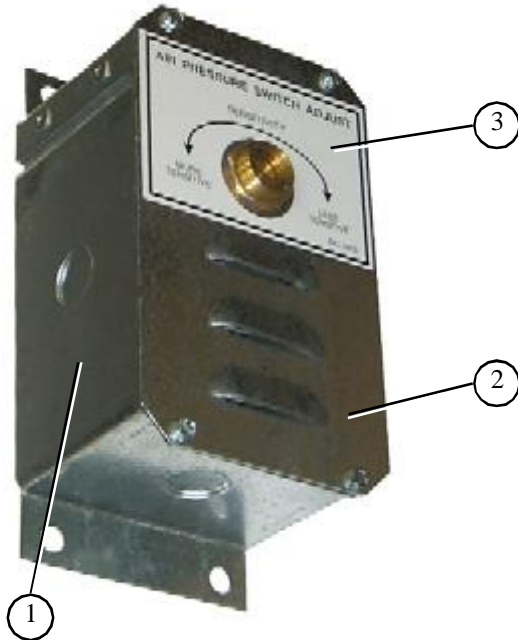

Air switch assembly (internal parts).

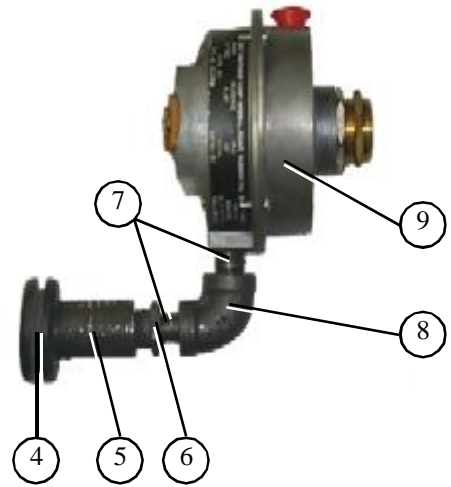

Upper air switch assembly (installed).

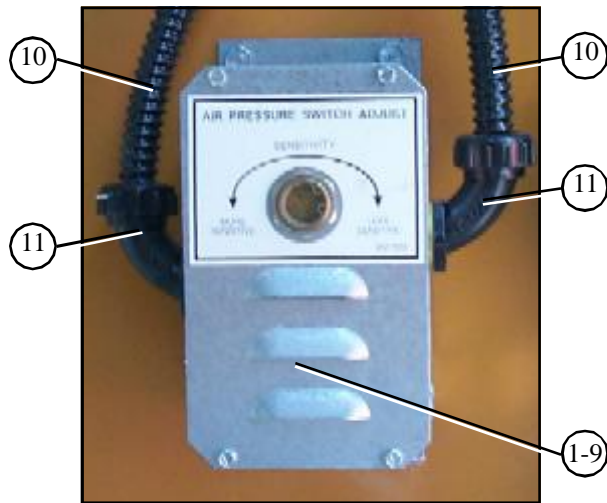

Lower air switch assembly (installed).

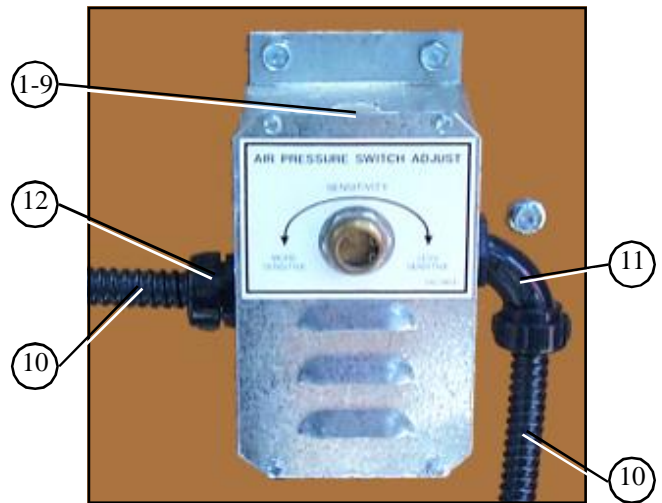

ITEM No.	PART No.	DESCRIPTION	QUANTITY
1-9	D01-0672	AIR SWITCH ASSEMBLY	2/DRYER
1	D01-0671	AIR SWITCH BOX CONDUIT HALF	2/ASSEMBLY
2	D01-0670	AIR SWITCH BOX FACE PLATE	1/ASSEMBLY
3	DC-1103	DECAL, AIR PRESSURE ADJUSTMENT	1/ASSEMBLY
4	D03-0177	GROMMET, 11/16" ID x 1" OD	1/ASSEMBLY
5	HF-7227	COUPLING, 1/4" STD BLACK STEEL	1/ASSEMBLY
6	HF-7228	BUSHING, 1/4" - 1/8" HEX	1/ASSEMBLY
7	HF-7226	NIPPLE, 1/8" CLOSE	2/ASSEMBLY
8	HF-7229	ELBOW, 1/8" - 90 SCH 40	1/ASSEMBLY
9	D03-0167	AIR PRESSURE SWITCH	1/ASSEMBLY

ITEM No.	DESCRIPTION	PART No.
10	CONDUIT, 3/8" SEALTITE	FH-7038
11	CONNECTOR, 3/8" x 90	FH-7050
12	CONNECTOR, 3/8" STRAIGHT	FH-7049

## Network Control Box

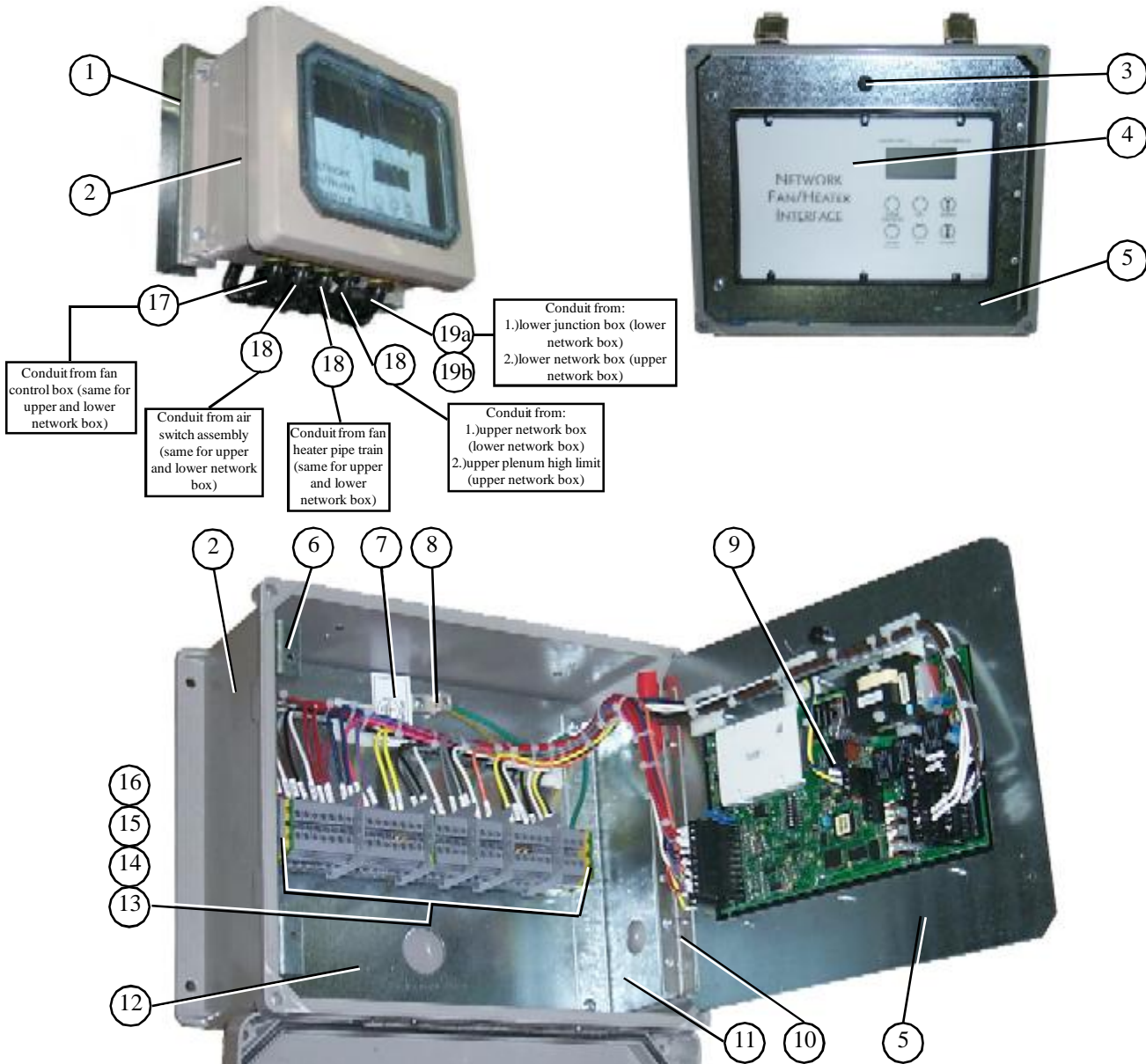

ITEM No.	DESCRIPTION	PART No.
1	NETWORK BOX MOUNTING CHANNEL	D01-1664
2	ENCLOSURE, 12" x 10" x 5.25"	TF-1439
3	PLASTIC HOLE PLUG 1/2" DIA	HH-2833
4	DECAL, NETWORK FAN/HEATER	DC-1513
5	CONTROL BOARD MOUNTING PLATE	TF-1426
6	CONTROL BOARD REST	TF-1429A
7	DECAL, GROUND	DC-1254
8	GROUND LUG	FH-6634
9	FAN/HEATER NETWORK CONTROL BOARD	HF-7276
10	HINGE, ALUMINUM	D02-0037
11	CONTROL BOARD REST	TF-1429
12	NETWORK BOX BACK PANEL	TF-1428
13	TERMINAL-BLOCK ENTRELEC 4MM	D01-0531
14	TERMINAL-BLANK END PROTECTOR	D01-0532
15	TERMINAL-ENTRELEC END STOP	D01-0533
16	TERMINAL-ENTRELEC GROUND BLOCK	D01-0534
17	elbow 1/2" 90deg pvc	FH-7052
18	elbow 3/8" 90deg pvc	FH-7050
19a	elbow 3/4" 90deg pvc (lower network control box only)	FH-7054
19b	elbow 3/8" 90deg pvc (upper network control box only)	FH-7050

## Fan Heater Electrical Box

Fan Heater control box and electrical components.

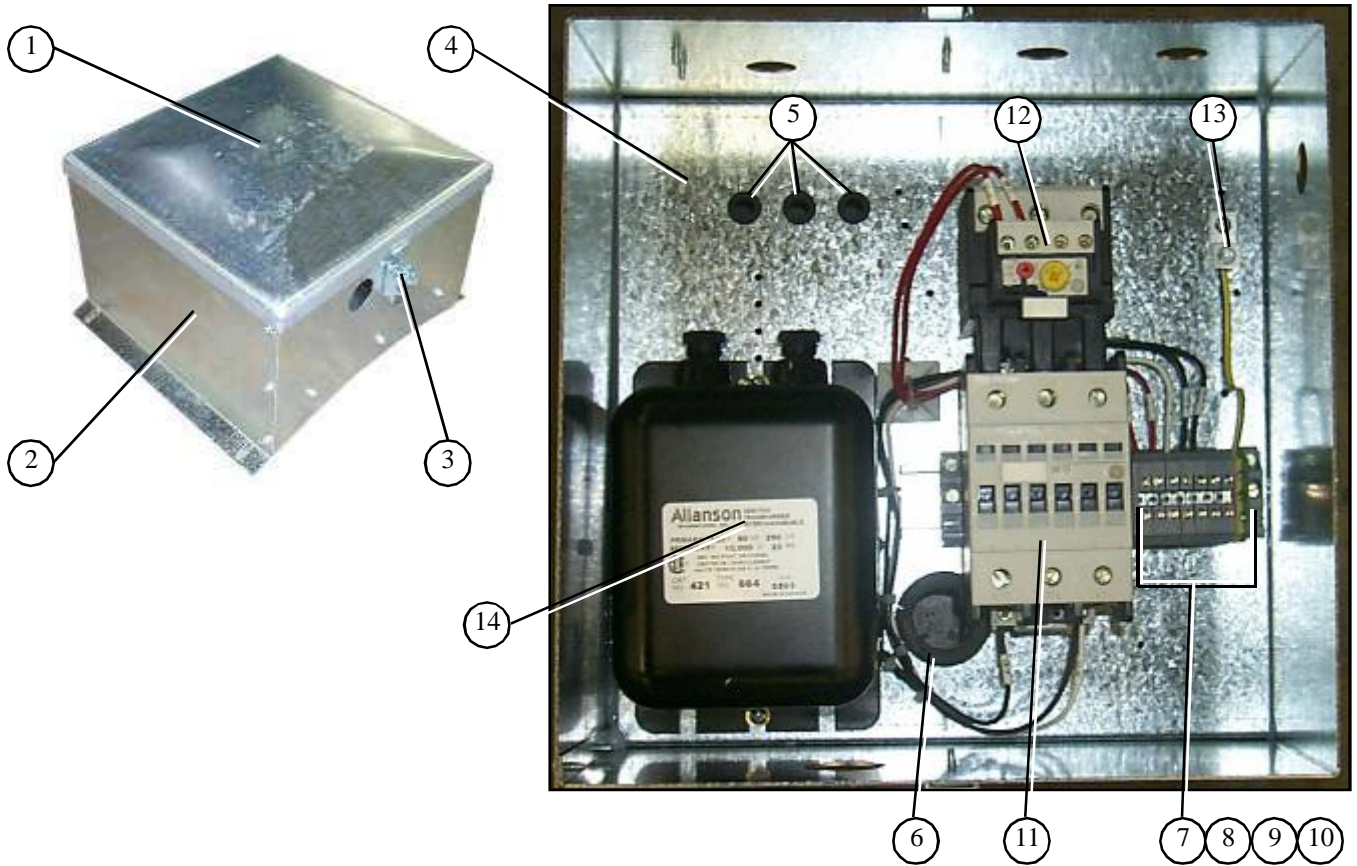

ITEM NUMBER	PART NUMBER	DESCRIPTION	28" FAN HEATERS	36" FAN HEATERS	40" FAN HEATERS	
1	F-942	ELECT. CONTROL BOX LID	1	1	1	
2	CD-0005	FAN CONTROL BOX WRAPPER 26-28"	1			
2	CD-0065	FAN CONTROL BOX WRAPPER 36"		1		
2	CD-0193	FAN CONTROL BOX WRAPPER 40-42"			1	
3	FH-4429-1	LATCH CONTROL BOX	2	2	2	
4	CD-0202	FAN CONTROL BOX BOTTOM 26-28"	1			
4	CD-0203	FAN CONTROL BOX BOTTOM 36-42"				
5	HH-7048	GROMMET 1/2" OD, 3/8" ID	3	3	3	
6	HH-7016	GROMMET 1 1/2" ID	1	1	1	
ITEM NUMBER	DESCRIPTION	10-12 HP FAN MOTORS (2812, 3612 FAN HEATERS)				
		220V 1Ph	208V 3Ph	220V 3Ph	440V 3Ph	575V 3Ph
7	TERMINAL-BLOCK ENTRELEC 4MM	D01-0531	D01-0531	D01-0531	D01-0531	D01-0531
8	TERMINAL-BLANK END PROTECTOR	D01-0532	D01-0532	D01-0532	D01-0532	D01-0532
9	TERMINAL-ENTRELEC END STOP	D01-0533	D01-0533	D01-0533	D01-0533	D01-0533
10	TERMINAL-ENTRELEC GRND BLOCK	D01-0534	D01-0534	D01-0534	D01-0534	D01-0534
11	CONTACTOR	D03-0495	D03-0494	D03-0494	D03-0492	D03-0490
12	OVERLOAD	D03-0483	D03-0482	D03-0482	D03-0476	D03-0475
13	LUG GROUND,#TA-2	E160-1137	E160-1137	E160-1137	E160-1137	E160-1137
14	GRP-TRANSFORMER 2POLE IGNITION	HH-1093-GRP	HH-1093-GRP	HH-1093-GRP	HH-1093-GRP	HH-1093-GRP
		10-16 HP FAN MOTORS (3615 FAN HEATERS)				
		220V 1Ph	208V 3Ph	220V 3Ph	440V 3Ph	575V 3Ph
7	TERMINAL-BLOCK ENTRELEC 4MM	D01-0531	D01-0531	D01-0531	D01-0531	D01-0531
8	TERMINAL-BLANK END PROTECTOR	D01-0532	D01-0532	D01-0532	D01-0532	D01-0532
9	TERMINAL-ENTRELEC END STOP	D01-0533	D01-0533	D01-0533	D01-0533	D01-0533
10	TERMINAL-ENTRELEC GRND BLOCK	D01-0534	D01-0534	D01-0534	D01-0534	D01-0534
11	CONTACTOR	D03-0497	D03-0494	D03-0494	D03-0492	D03-0491
12	OVERLOAD	D03-0485	D03-0483	D03-0483	D03-0477	D03-0478
13	LUG GROUND,#TA-2	E160-1137	E160-1137	E160-1137	E160-1137	E160-1137
14	GRP-TRANSFORMER 2POLE IGNITION	HH-1093-GRP	HH-1093-GRP	HH-1093-GRP	HH-1093-GRP	HH-1093-GRP
		25 HP FAN MOTORS (4025 FAN HEATERS)				
		220V 1Ph	208V 3Ph	220V 3Ph	440V 3Ph	575V 3Ph
7	TERMINAL-BLOCK ENTRELEC 4MM	N/A	D01-0531	D01-0531	D01-0531	D01-0531
8	TERMINAL-BLANK END PROTECTOR	N/A	D01-0532	D01-0532	D01-0532	D01-0532
9	TERMINAL-ENTRELEC END STOP	N/A	D01-0533	D01-0533	D01-0533	D01-0533
10	TERMINAL-ENTRELEC GRND BLOCK	N/A	D01-0534	D01-0534	D01-0534	D01-0534
11	CONTACTOR	N/A	D03-0496	D03-0496	D03-0494	D03-0492
12	OVERLOAD	N/A	D03-0485	D03-0485	D03-0482	D03-0479
13	LUG GROUND,#TA-2	N/A	E160-1137	E160-1137	E160-1137	E160-1137
14	GRP-TRANSFORMER 2POLE IGNITION	N/A	HH-1093-GRP	HH-1093-GRP	HH-1093-GRP	HH-1093-GRP



## Control Box Control Panel

Network control panel (front).

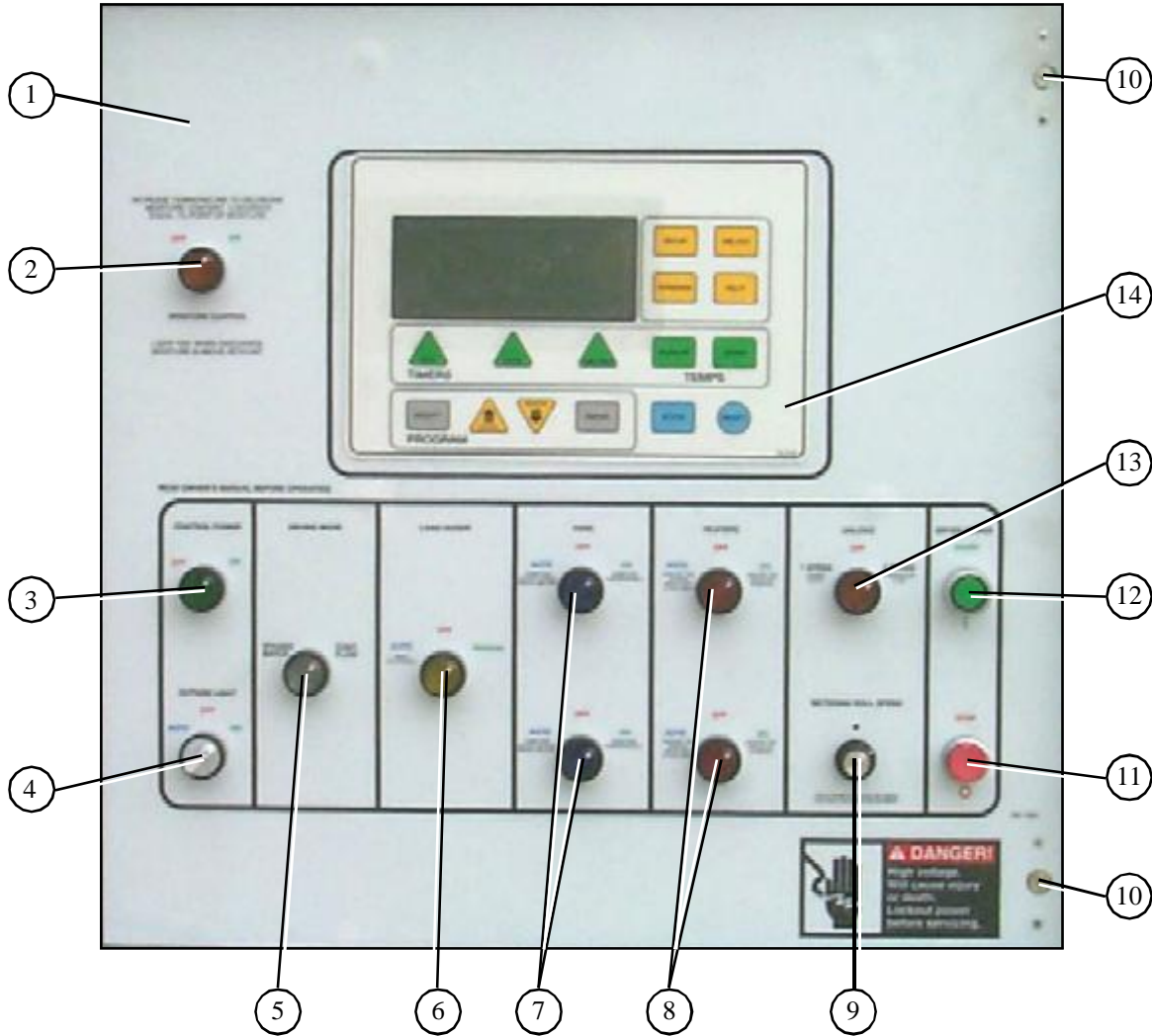

ITEM NUMBER	DESCRIPTION	CIRCUIT	PART NUMBER
1	DECAL, NETWORK DRYER 2 FAN	MISC.	DC-1521
2	SWITCH 2 POS. SELECTOR AMBER	CONTROL	D01-0444
3	SWITCH 2 POS. SELECTOR GREEN	CONTROL	D01-0446
4	SWITCH 3 POS. SELECTOR WHITE	CONTROL	D03-0182
5	SWITCH 2 POS. SELECTOR CLEAR	CONTROL	D01-0448
6	3 POS. SELECTOR SWITCH YELLOW	CONTROL	D01-0579
7	SWITCH 3 POS. SELECTOR BLUE	CONTROL	D01-0449
8	SWITCH 3 POS. SELECTOR RED	CONTROL	D01-0447
9	KNOB, AUGAT #PK-70B-1/4	MISC.	E115-1060
10	LATCH, SOUTHCO SLOTTED	MISC.	TF-1519
11	SWITCH STOP BLOCK (RED)	CONTROL	D03-0020
12	SWITCH START N.O.(ILLUMINATED)	CONTROL	D03-0017
13	SWITCH 3 POS. SELECTOR AMBER	CONTROL	D01-0445
14	TOUCH PANEL TOP DRY AUTO	MISC.	TAF-6150

## Control Box Control Panel (Inside)

Network control panel (rear).

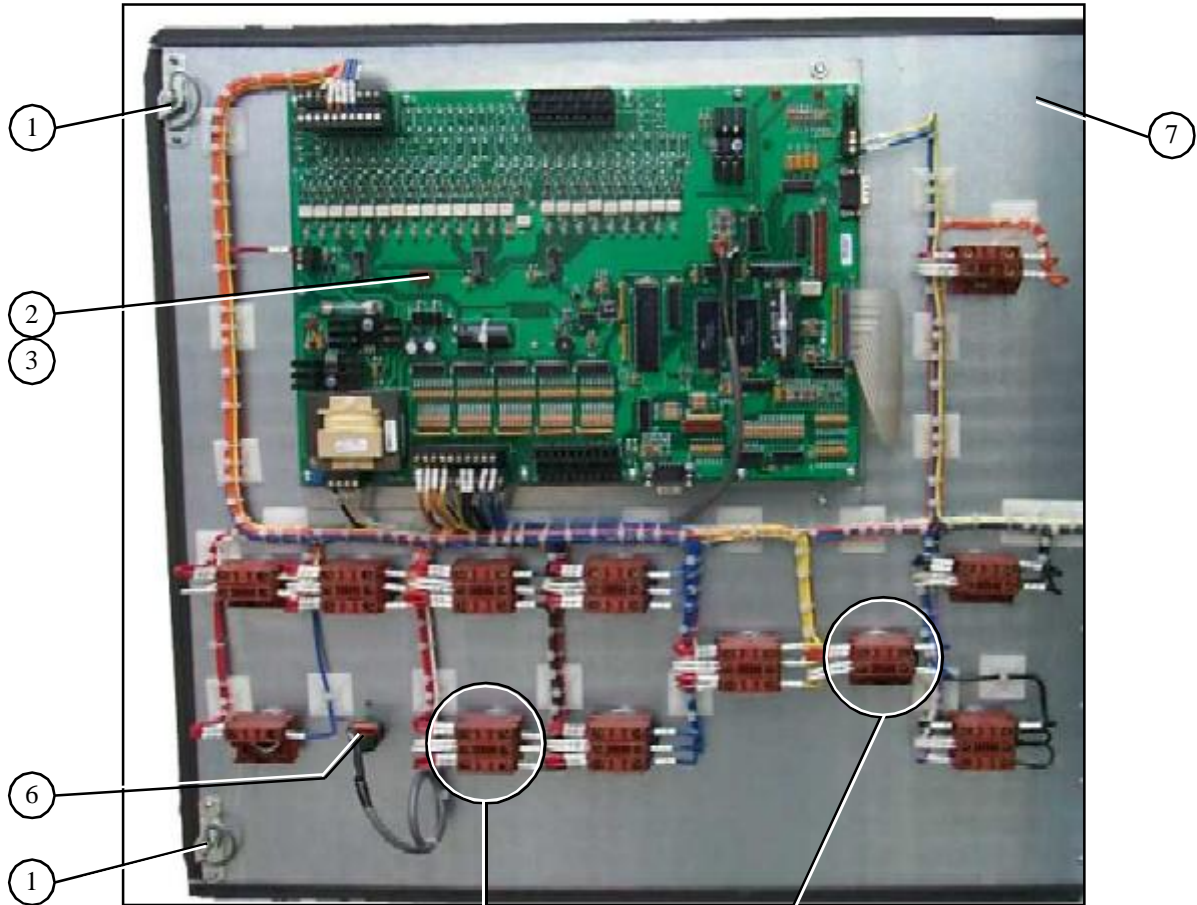

Detailed view of a two position switch.



Detailed view of a single position switch.

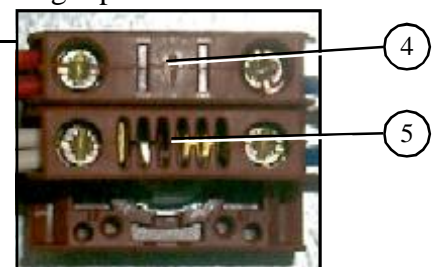

ITEM NUMBER	DESCRIPTION	CIRCUIT	PART NUMBER
1	LATCH, SOUTHCO SLOTTED	MISC.	TF-1519
2	NETWORK DRYER DISPLAY BOARD	CONTROL	D03-0593
3	COMPUTER MOUNTING PLATE	MISC.	TF-1544
4	BLOCK, CONTACT N/O	CONTROL	D63-0006
5	BLOCK, LIGHT 12/24/120V LAMPS	CONTROL	D01-0455
6	SCR POTENTIOMETER 10K	CONTROL	D03-0595
7	NETWORK SWITCH PANEL	MISC.	D01-1666

## Lower Control Box Back Panel

Lower control box back panel.

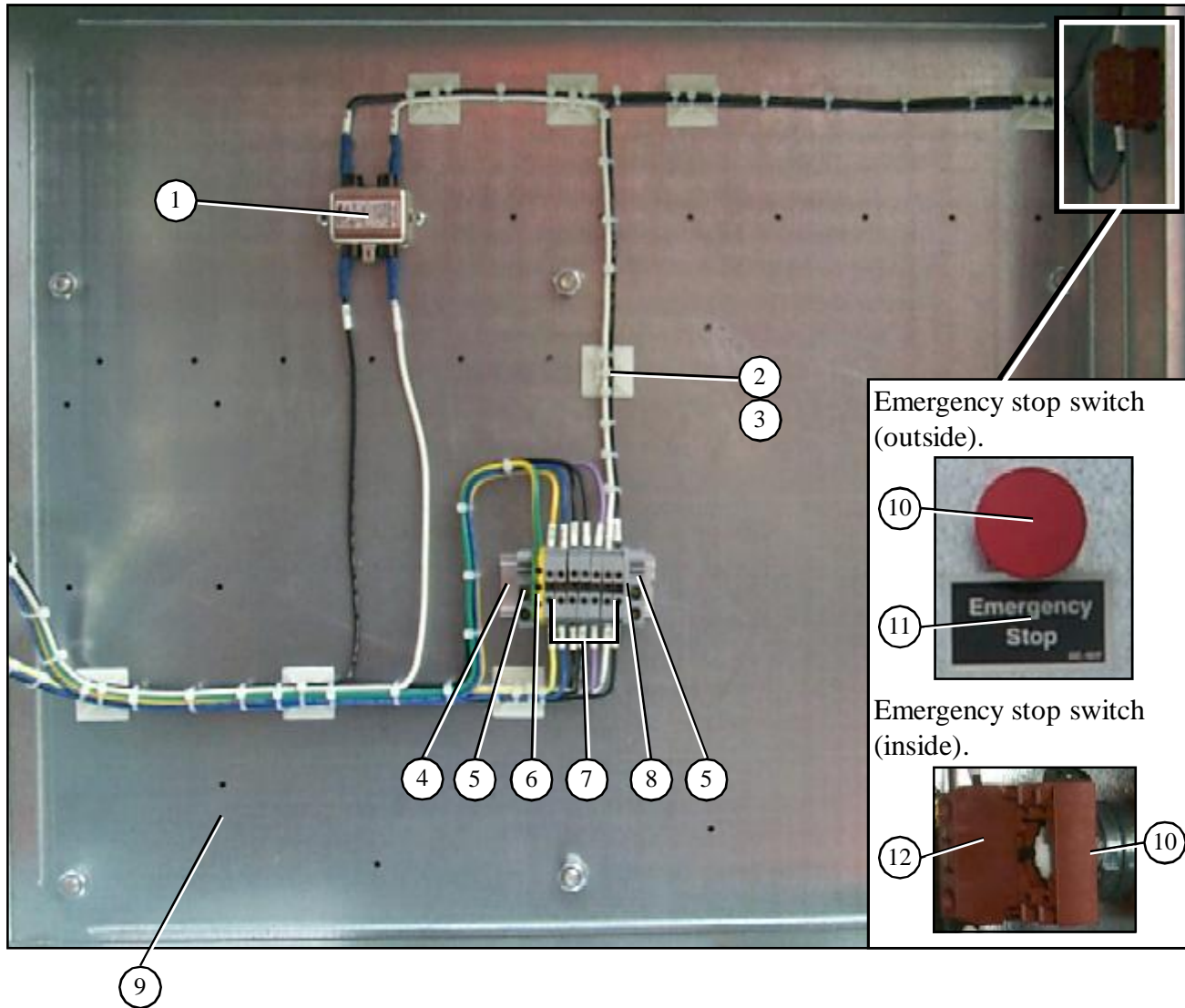

ITEM NUMBER	DESCRIPTION	CIRCUIT	PART NUMBER
1	FILTER RFI "B" SERIES	CONTROL	D03-0181
2	WIRE TIE ANCHOR	MISC.	D02-0039
3	WIRE TIE, 5" PANDUIT	MISC.	D03-0247
4	DIN RAIL, TERMINAL BLOCK MOUNTING	MISC.	D03-0013
5	TERMINAL - ENTRELEC END STOP	MISC.	D01-0533
6	TERMINAL - ENTRELEC GROUND BLOCK	MISC.	D01-0534
7	TERMINAL - BLOCK ENTRELEC 4MM	MISC.	D01-0531
8	TERMINAL - END PROTECTOR	MISC.	D01-0532
9	LOWER CONTROL BOX BACK PANEL	MISC.	D01-0486
10	EMERGENCY STOP SWITCH	SAFETY	TF-1279
11	DECAL, EMERGENCY STOP	MISC.	DC-1317
12	BLOCK, CONTACT N/C	SAFETY	D63-0013

# Upper Control Box

Upper control box power distribution panel.

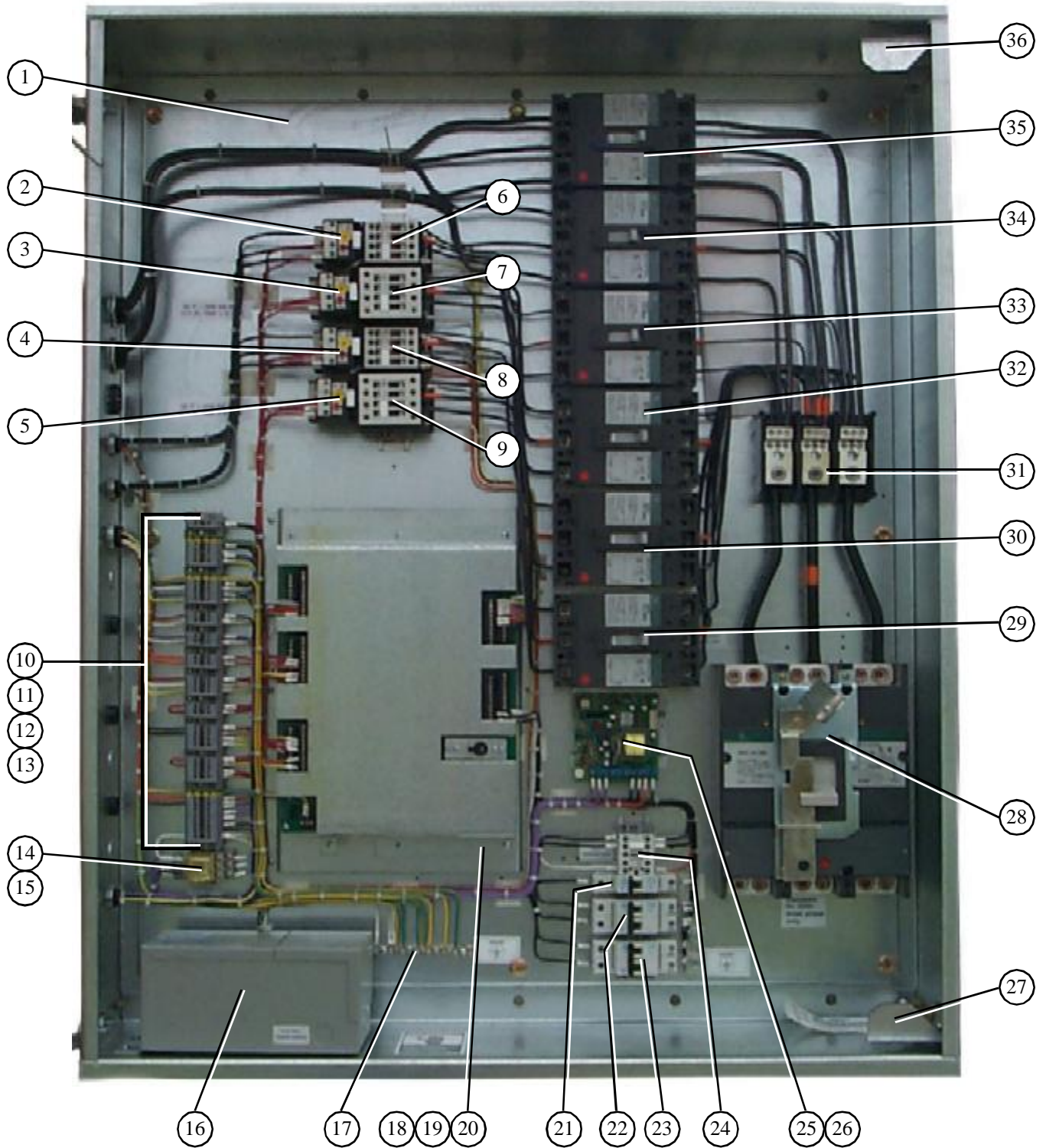

## 1214 Upper Control Box Component Part Numbers

1214S Upper control box power distribution panel parts listing.

ITEM NUMBER	DESCRIPTION	CIRCUIT	1214S PART NUMBER				
			220V 1Ph	208V 3Ph	220V 3Ph	440V 3Ph	575V 3Ph
1	POWER BOX BOCK PANEL	N/A	D01-0480	D01-0480	D01-0480	D01-0480	D01-0480
2	OVERLOAD	LOAD	D03-0487	D03-0477	D03-0475	D03-0473	D03-0472
3	OVERLOAD	LOAD AUX.	D03-0482	D03-0480	D03-0479	D03-0475	D03-0475
4	OVERLOAD	UNLOAD	D03-0487	D03-0477	D03-0475	D03-0473	D03-0472
5	OVERLOAD	UNLOAD AUX.	D03-0482	D03-0480	D03-0479	D03-0475	D03-0475
6	CONTACTOR	LOAD	D03-0492	D03-0491	D03-0490	D03-0488	D03-0488
7	CONTACTOR	LOAD AUX.	D03-0494	D03-0493	D03-0492	D03-0490	D03-0489
8	CONTACTOR	UNLOAD	D03-0492	D03-0491	D03-0490	D03-0488	D03-0488
9	CONTACTOR	UNLOAD AUX.	D03-0494	D03-0493	D03-0492	D03-0490	D03-0489
10	TERMINAL-BLOCK ENTRELEC 4MM	CONTROL	D01-0531	D01-0531	D01-0531	D01-0531	D01-0531
11	TERMINAL-BLANK END PROTECTOR	CONTROL	D01-0532	D01-0532	D01-0532	D01-0532	D01-0532
12	TERMINAL-ENTRELEC END STOP	CONTROL	D01-0533	D01-0533	D01-0533	D01-0533	D01-0533
13	TERMINAL-ENTRELEC GRND BLOCK	CONTROL	D01-0534	D01-0534	D01-0534	D01-0534	D01-0534
14	RELAY, 3PDT 120V RH3B-U IDEC	CONTROL	HF-7203	HF-7203	HF-7203	HF-7203	HF-7203
15	RELAY BASE, 3PDT	CONTROL	07097555	070975553	07097555	07097555	07097555
16	TRANSFORMER	CONTROL	FH-3807	FH-3807	FH-3807	FH-3807	FH-3807
17	TERMINAL GROUND BAR	GROUND	006-1184-8	006-1184-8	006-1184-8	006-1184-8	006-1184-8
18	NETWORK DRYER CONTROL BOARD MOUNT PLATE	N/A	TF-1713	TF-1713	TF-1713	TF-1713	TF-1713
19	NETWORK DRYER CONTROL BOARD	CONTROL	D03-0587	D03-0587	D03-0587	D03-0587	D03-0587
20	NETWORK DRYER CONTROL BOARD COVER PLATE	N/A	D01-1710	D01-1710	D01-1710	D01-1710	D01-1710
21	BREAKER 6 AMP 1 POLE 110VAC	CONTROL	D03-0661	D03-0661	D03-0661	D03-0661	D03-0661
22	BREAKER 10 AMP 2 POLE DELAYED	METER ROLL	D03-0660	D03-0660	D03-0660	D03-0660	D03-0660
23	BREAKER 3 AMP 2 POLE DELAYED	CONTROL	D03-0726	D03-0728	D03-0726	D03-0726	D03-0726
24	SCR CONTACTOR 15 AMP 3 POLE	METER ROLL	D03-0106	D03-0108	D03-0106	D03-0106	D03-0106
25	SCR DRIVE BOARD BASE UNIT	METER ROLL	D03-0711	D03-0711	D03-0711	D03-0711	D03-0711
26	SCR ISOLATED TERMINAL BOARD	METER ROLL	D03-0592	D03-0592	D03-0592	D03-0592	D03-0592
27	POWER BOX CATCH ANGLE, BOTTOM	N/A	D01-0550	D01-0550	D01-0550	D01-0550	D01-0550
28	MAIN BREAKER	POWER	D01-0493	D01-0503	D01-0450	D03-0271	D03-0175
29	BREAKER	UNLOAD AUX.	D03-0460	D03-0461	D03-0461	D03-0545	D03-0395
30	BREAKER	UNLOAD	D03-0460	D03-0453	D03-0451	D03-0389	D03-0531
31	DISTRIBUTION BLOCK	POWER	D03-0300	D03-0293	D03-0293	D35-0001	D35-0001
32	BREAKER	LOAD AUX.	D03-0460	D03-0461	D03-0461	D03-0545	D03-0395
33	BREAKER	LOAD	D03-0460	D03-0453	D03-0451	D03-0389	D03-0531
34	BREAKER	FAN 1	D03-0466	D03-0461	D03-0461	D03-0545	D03-0395
35	BREAKER	FAN 2	D03-0466	D03-0461	D03-0461	D03-0545	D03-0395
36	POWER BOX CATCH ANGLE, TOP	N/A	D01-0551	D01-0551	D01-0551	D01-0551	D01-0551

## 1218 Upper Control Box Component Part Numbers

1218S Upper control box power distribution panel parts listing.

ITEM NUMBER	DESCRIPTION	CIRCUIT	1218S PART NUMBER				
			220V 1Ph	208V 3Ph	220V 3Ph	440V 3Ph	575V 3Ph
1	POWER BOX BOCK PANEL	N/A	D01-0480	D01-0480	D01-0480	D01-0480	D01-0480
2	OVERLOAD	LOAD	D03-0478	D03-0477	D03-0475	D03-0473	D03-0472
3	OVERLOAD	LOAD AUX.	D03-0482	D03-0480	D03-0479	D03-0475	D03-0475
4	OVERLOAD	UNLOAD	D03-0478	D03-0477	D03-0475	D03-0473	D03-0472
5	OVERLOAD	UNLOAD AUX.	D03-0482	D03-0480	D03-0479	D03-0475	D03-0475
6	CONTACTOR	LOAD	D03-0492	D03-0491	D03-0490	D03-0488	D03-0488
7	CONTACTOR	LOAD AUX.	D03-0494	D03-0493	D03-0492	D03-0490	D03-0489
8	CONTACTOR	UNLOAD	D03-0492	D03-0491	D03-0490	D03-0488	D03-0488
9	CONTACTOR	UNLOAD AUX.	D03-0494	D03-0493	D03-0492	D03-0490	D03-0489
10	TERMINAL-BLOCK ENTRELEC 4MM	CONTROL	D01-0531	D01-0531	D01-0531	D01-0531	D01-0531
11	TERMINAL-BLANK END PROTECTOR	CONTROL	D01-0532	D01-0532	D01-0532	D01-0532	D01-0532
12	TERMINAL-ENTRELEC END STOP	CONTROL	D01-0533	D01-0533	D01-0533	D01-0533	D01-0533
13	TERMINAL-ENTRELEC GRND BLOCK	CONTROL	D01-0534	D01-0534	D01-0534	D01-0534	D01-0534
14	RELAY, 3PDT 120V RH3B-U IDEC	CONTROL	HF-7203	HF-7203	HF-7203	HF-7203	HF-7203
15	RELAY BASE, 3PDT	CONTROL	07097555	070975553	07097555	07097555	07097555
16	TRANSFORMER	CONTROL	FH-3807	FH-3807	FH-3807	FH-3807	FH-3807
17	TERMINAL GROUND BAR	GROUND	006-1184-8	006-1184-8	006-1184-8	006-1184-8	006-1184-8
18	NETWORK DRYER CONTROL BOARD MOUNT PLATE	N/A	TF-1713	TF-1713	TF-1713	TF-1713	TF-1713
19	NETWORK DRYER CONTROL BOARD	CONTROL	D03-0587	D03-0587	D03-0587	D03-0587	D03-0587
20	NETWORK DRYER CONTROL BOARD COVER PLATE	N/A	D01-1710	D01-1710	D01-1710	D01-1710	D01-1710
21	BREAKER 6 AMP 1 POLE 110VAC	CONTROL	D03-0661	D03-0661	D03-0661	D03-0661	D03-0661
22	BREAKER 10 AMP 2 POLE DELAYED	METER ROLL	D03-0660	D03-0660	D03-0660	D03-0660	D03-0660
23	BREAKER 3 AMP 2 POLE DELAYED	CONTROL	D03-0726	D03-0728	D03-0726	D03-0726	D03-0726
24	SCR CONTACTOR 15 AMP 3 POLE	METER ROLL	D03-0106	D03-0108	D03-0106	D03-0106	D03-0106
25	SCR DRIVE BOARD BASE UNIT	METER ROLL	D03-0711	D03-0711	D03-0711	D03-0711	D03-0711
26	SCR ISOLATED TERMINAL BOARD	METER ROLL	D03-0592	D03-0592	D03-0592	D03-0592	D03-0592
27	POWER BOX CATCH ANGLE, BOTTOM	N/A	D01-0550	D01-0550	D01-0550	D01-0550	D01-0550
28	MAIN BREAKER	POWER	D01-0493	D01-0503	D01-0450	D03-0271	D03-0533
29	BREAKER	UNLOAD AUX.	D03-0464	D03-0461	D03-0461	D03-0545	D03-0395
30	BREAKER	UNLOAD	D03-0460	D03-0453	D03-0451	D03-0389	D03-0531
31	DISTRIBUTION BLOCK	POWER	D03-0300	D03-0293	D03-0293	D35-0001	D35-0001
32	BREAKER	LOAD AUX.	D03-0464	D03-0461	D03-0461	D03-0545	D03-0395
33	BREAKER	LOAD	D03-0460	D03-0453	D03-0451	D03-0389	D03-0531
34	BREAKER	FAN 1	D03-0466	D03-0461	D03-0465	D03-0529	D03-0532
35	BREAKER	FAN 2	D03-0466	D03-0461	D03-0465	D03-0529	D03-0532
36	POWER BOX CATCH ANGLE, TOP	N/A	D01-0551	D01-0551	D01-0551	D01-0551	D01-0551

## 1220 Upper Control Box Components Part Numbers

1220S Upper control box power distribution panel parts listing.

ITEM NUMBER	DESCRIPTION	CIRCUIT	1220S PART NUMBER				
			220V 1Ph	208V 3Ph	220V 3Ph	440V 3Ph	575V 3Ph
1	POWER BOX BOCK PANEL	N/A	D01-0480	D01-0480	D01-0480	D01-0480	D01-0480
2	OVERLOAD	LOAD	D03-0482	D03-0479	D03-0477	D03-0474	D03-0473
3	OVERLOAD	LOAD AUX.	D03-0482	D03-0483	D03-0483	D03-0477	D03-0476
4	OVERLOAD	UNLOAD	D03-0482	D03-0479	D03-0477	D03-0474	D03-0473
5	OVERLOAD	UNLOAD AUX.	D03-0482	D03-0483	D03-0483	D03-0477	D03-0476
6	CONTACTOR	LOAD	D03-0494	D03-0492	D03-0491	D03-0489	D03-0489
7	CONTACTOR	LOAD AUX.	D03-0494	D03-0494	D03-0494	D03--0492	D03-0490
8	CONTACTOR	UNLOAD	D03-0494	D03-0492	D03-0491	D03-0489	D03-0489
9	CONTACTOR	UNLOAD AUX.	D03-0494	D03-0494	D03-0494	D03-0492	D03-0490
10	TERMINAL-BLOCK ENTRELEC 4MM	CONTROL	D01-0531	D01-0531	D01-0531	D01-0531	D01-0531
11	TERMINAL-BLANK END PROTECTOR	CONTROL	D01-0532	D01-0532	D01-0532	D01-0532	D01-0532
12	TERMINAL-ENTRELEC END STOP	CONTROL	D01-0533	D01-0533	D01-0533	D01-0533	D01-0533
13	TERMINAL-ENTRELEC GRND BLOCK	CONTROL	D01-0534	D01-0534	D01-0534	D01-0534	D01-0534
14	RELAY, 3PDT 120V RH3B-U IDEC	CONTROL	HF-7203	HF-7203	HF-7203	HF-7203	HF-7203
15	RELAY BASE, 3PDT	CONTROL	07097555	070975553	07097555	07097555	07097555
16	TRANSFORMER	CONTROL	FH-3807	FH-3807	FH-3807	FH-3807	FH-3807
17	TERMINAL GROUND BAR	GROUND	006-1184-8	006-1184-8	006-1184-8	006-1184-8	006-1184-8
18	NETWORK DRYER CONTROL BOARD MOUNT PLATE	N/A	TF-1713	TF-1713	TF-1713	TF-1713	TF-1713
19	NETWORK DRYER CONTROL BOARD	CONTROL	D03-0587	D03-0587	D03-0587	D03-0587	D03-0587
20	NETWORK DRYER CONTROL BOARD COVER PLATE	N/A	D01-1710	D01-1710	D01-1710	D01-1710	D01-1710
21	BREAKER 6 AMP 1 POLE 110VAC	CONTROL	D03-0661	D03-0661	D03-0661	D03-0661	D03-0661
22	BREAKER 10 AMP 2 POLE DELAYED	METER ROLL	D03-0660	D03-0660	D03-0660	D03-0660	D03-0660
23	BREAKER 3 AMP 2 POLE DELAYED	CONTROL	D03-0726	D03-0728	D03-0726	D03-0726	D03-0726
24	SCR CONTACTOR 15 AMP 3 POLE	METER ROLL	D03-0106	D03-0108	D03-0106	D03-0106	D03-0106
25	SCR DRIVE BOARD BASE UNIT	METER ROLL	D03-0711	D03-0711	D03-0711	D03-0711	D03-0711
26	SCR ISOLATED TERMINAL BOARD	METER ROLL	D03-0592	D03-0592	D03-0592	D03-0592	D03-0592
27	POWER BOX CATCH ANGLE, BOTTOM	N/A	D01-0550	D01-0550	D01-0550	D01-0550	D01-0550
28	MAIN BREAKER	POWER	D01-0504	D01-0497	D01-0475	D03-0271	D03-0175
29	BREAKER	UNLOAD AUX.	D03-0464	D03-0468	D03-0465	D03-0529	D03-0532
30	BREAKER	UNLOAD	D03-0464	D03-0459	D03-0457	D03-0528	D03-0531
31	DISTRIBUTION BLOCK	POWER	D03-0300	D03-0293	D03-0293	D35-0001	D35-0001
32	BREAKER	LOAD AUX.	D03-0464	D03-0468	D03-0465	D03-0529	D03-0532
33	BREAKER	LOAD	D03-0464	D03-0459	D03-0457	D03-0528	D03-0531
34	BREAKER	FAN 1	D03-0510	D03-0468	D03-0461	D03-0529	D03-0395
35	BREAKER	FAN 2	D03-0510	D03-0468	D03-0461	D03-0529	D03-0395
36	POWER BOX CATCH ANGLE, TOP	N/A	D01-0551	D01-0551	D01-0551	D01-0551	D01-0551

## 1222 Upper Control Box Component Part Numbers

1222S Upper control box power distribution panel parts listing.

ITEM NUMBER	DESCRIPTION	CIRCUIT	1222S PART NUMBER			
			208V 3Ph	220V 3Ph	440V 3Ph	575V 3Ph
1	POWER BOX BOCK PANEL	N/A	D01-0480	D01-0480	D01-0480	D01-0480
2	OVERLOAD	LOAD	D03-0479	D03-0477	D03-0474	D03-0473
3	OVERLOAD	LOAD AUX.	D03-0483	D03-0483	D03-0477	D03-0476
4	OVERLOAD	UNLOAD	D03-0479	D03-0477	D03-0474	D03-0473
5	OVERLOAD	UNLOAD AUX.	D03-0483	D03-0483	D03-0477	D03-0476
6	CONTACTOR	LOAD	D03-0492	D03-0491	D03-0489	D03-0489
7	CONTACTOR	LOAD AUX.	D03-0494	D03-0494	D03-0492	D03-0490
8	CONTACTOR	UNLOAD	D03-0492	D03-0491	D03-0489	D03-0489
9	CONTACTOR	UNLOAD AUX.	D03-0494	D03-0494	D03-0492	D03-0490
10	TERMINAL-BLOCK ENTRELEC 4MM	CONTROL	D01-0531	D01-0531	D01-0531	D01-0531
11	TERMINAL-BLANK END PROTECTOR	CONTROL	D01-0532	D01-0532	D01-0532	D01-0532
12	TERMINAL-ENTRELEC END STOP	CONTROL	D01-0533	D01-0533	D01-0533	D01-0533
13	TERMINAL-ENTRELEC GRND BLOCK	CONTROL	D01-0534	D01-0534	D01-0534	D01-0534
14	RELAY, 3PDT 120V RH3B-U IDEC	CONTROL	HF-7203	HF-7203	HF-7203	HF-7203
15	RELAY BASE, 3PDT	CONTROL	070975553	07097555	07097555	07097555
16	TRANSFORMER	CONTROL	FH-3807	FH-3807	FH-3807	FH-3807
17	TERMINAL GROUND BAR	GROUND	006-1184-8	006-1184-8	006-1184-8	006-1184-8
18	NETWORK DRYER CONTROL BOARD MOUNT PLATE	N/A	TF-1713	TF-1713	TF-1713	TF-1713
19	NETWORK DRYER CONTROL BOARD	CONTROL	D03-0587	D03-0587	D03-0587	D03-0587
20	NETWORK DRYER CONTROL BOARD COVER PLATE	N/A	D01-1710	D01-1710	D01-1710	D01-1710
21	BREAKER 6 AMP 1 POLE 110VAC	CONTROL	D03-0661	D03-0661	D03-0661	D03-0661
22	BREAKER 10 AMP 2 POLE DELAYED	METER ROLL	D03-0660	D03-0660	D03-0660	D03-0660
23	BREAKER 3 AMP 2 POLE DELAYED	CONTROL	D03-0728	D03-0726	D03-0726	D03-0726
24	SCR CONTACTOR 15 AMP 3 POLE	METER ROLL	D03-0108	D03-0106	D03-0106	D03-0106
25	SCR DRIVE BOARD BASE UNIT	METER ROLL	D03-0711	D03-0711	D03-0711	D03-0711
26	SCR ISOLATED TERMINAL BOARD	METER ROLL	D03-0592	D03-0592	D03-0592	D03-0592
27	POWER BOX CATCH ANGLE, BOTTOM	N/A	D01-0550	D01-0550	D01-0550	D01-0550
28	MAIN BREAKER	POWER	D01-0497	D01-0475	D03-0271	D03-0175
29	BREAKER	UNLOAD AUX.	D03-0468	D03-0465	D03-0529	D03-0532
30	BREAKER	UNLOAD	D03-0459	D03-0457	D03-0528	D03-0531
31	DISTRIBUTION BLOCK	POWER	D03-0293	D03-0293	D35-0001	D35-0001
32	BREAKER	LOAD AUX.	D03-0468	D03-0465	D03-0529	D03-0532
33	BREAKER	LOAD	D03-0459	D03-0457	D03-0528	D03-0531
34	BREAKER	FAN 1	D03-0468	D03-0461	D03-0529	D03-0395
35	BREAKER	FAN 2	D03-0468	D03-0461	D03-0529	D03-0395
36	POWER BOX CATCH ANGLE, TOP	N/A	D01-0551	D01-0551	D01-0551	D01-0551



## 1226 Upper Control Box Component Part Numbers

1226S Upper control box power distribution panel parts listing.

ITEM NUMBER	DESCRIPTION	CIRCUIT	1226S PART NUMBER			
			208V 3Ph	220V 3Ph	440V 3Ph	575V 3Ph
1	POWER BOX BOCK PANEL	N/A	D01-0480	D01-0480	D01-0480	D01-0480
2	OVERLOAD	LOAD	D03-0480	D03-0479	D03-0475	D03-0475
3	OVERLOAD	LOAD AUX.	D03-0483	D03-0483	D03-0477	D03-0476
4	OVERLOAD	UNLOAD	D03-0480	D03-0479	D03-0475	D03-0475
5	OVERLOAD	UNLOAD AUX.	D03-0483	D03-0483	D03-0477	D03-0476
6	CONTACTOR	LOAD	D03-0493	D03-0492	D03-0490	D03-0489
7	CONTACTOR	LOAD AUX.	D03-0494	D03-0494	D03-0492	D03-0490
8	CONTACTOR	UNLOAD	D03-0493	D03-0492	D03-0490	D03-0489
9	CONTACTOR	UNLOAD AUX.	D03-0494	D03-0494	D03-0492	D03-0490
10	TERMINAL-BLOCK ENTRELEC 4MM	CONTROL	D01-0531	D01-0531	D03-0493	D01-0531
11	TERMINAL-BLANK END PROTECTOR	CONTROL	D01-0532	D01-0532	D03-0494	D01-0532
12	TERMINAL-ENTRELEC END STOP	CONTROL	D01-0533	D01-0533	D03-0495	D01-0533
13	TERMINAL-ENTRELEC GRND BLOCK	CONTROL	D01-0534	D01-0534	D03-0496	D01-0534
14	RELAY, 3PDT 120V RH3B-U IDEC	CONTROL	HF-7203	HF-7203	D03-0497	HF-7203
15	RELAY BASE, 3PDT	CONTROL	070975553	07097555	D03-0498	07097555
16	TRANSFORMER	CONTROL	FH-3807	FH-3807	D03-0499	FH-3807
17	TERMINAL GROUND BAR	GROUND	006-1184-8	006-1184-8	D03-0500	006-1184-8
18	NETWORK DRYER CONTROL BOARD MOUNT PLATE	N/A	TF-1713	TF-1713	D03-0501	TF-1713
19	NETWORK DRYER CONTROL BOARD	CONTROL	D03-0587	D03-0587	D03-0502	D03-0587
20	NETWORK DRYER CONTROL BOARD COVER PLATE	N/A	D01-1710	D01-1710	D03-0503	D01-1710
21	BREAKER 6 AMP 1 POLE 110VAC	CONTROL	D03-0661	D03-0661	D03-0504	D03-0661
22	BREAKER 10 AMP 2 POLE DELAYED	METER ROLL	D03-0660	D03-0660	D03-0505	D03-0660
23	BREAKER 3 AMP 2 POLE DELAYED	CONTROL	D03-0728	D03-0726	D03-0506	D03-0726
24	SCR CONTACTOR 15 AMP 3 POLE	METER ROLL	D03-0108	D03-0106	D03-0507	D03-0106
25	SCR DRIVE BOARD BASE UNIT	METER ROLL	D03-0711	D03-0711	D03-0508	D03-0711
26	SCR ISOLATED TERMINAL BOARD	METER ROLL	D03-0592	D03-0592	D03-0509	D03-0592
27	POWER BOX CATCH ANGLE, BOTTOM	N/A	D01-0550	D01-0550	D03-0510	D01-0550
28	MAIN BREAKER	POWER	D03-0657	D01-0505	D03-0535	D03-0175
29	BREAKER	UNLOAD AUX.	D03-0468	D03-0465	D03-0529	D03-0532
30	BREAKER	UNLOAD	D03-0461	D03-0461	D03-0545	D03-0395
31	DISTRIBUTION BLOCK	POWER	D03-0293	D03-0293	D35-0001	D35-0001
32	BREAKER	LOAD AUX.	D03-0468	D03-0465	D03-0529	D03-0532
33	BREAKER	LOAD	D03-0461	D03-0461	D03-0545	D03-0395
34	BREAKER	FAN 1	D03-0144	D03-0467	D03-0547	D03-0141
35	BREAKER	FAN 2	D03-0144	D03-0467	D03-0547	D03-0141
36	POWER BOX CATCH ANGLE, TOP	N/A	D01-0551	D01-0551	D01-0551	D01-0551



---

**This Equipment shall be installed in accordance with the current installation codes and applicable regulations which should be carefully followed in all cases. Authorities having jurisdiction should be consulted before installation occurs.**



The GSI Group, Inc.  
1004 E. Illinois St.  
Assumption, IL 62510-0020  
Phone: 217-226-4421  
Fax: 217-226-4420  
e-mail: [gsisales@grainsystems.com](mailto:gsisales@grainsystems.com)  
internet: <http://www.grainsystems.com>

## Free Manuals Download Website

<http://myh66.com>

<http://usermanuals.us>

<http://www.somanuals.com>

<http://www.4manuals.cc>

<http://www.manual-lib.com>

<http://www.404manual.com>

<http://www.luxmanual.com>

<http://aubethermostatmanual.com>

Golf course search by state

<http://golfingnear.com>

Email search by domain

<http://emailbydomain.com>

Auto manuals search

<http://auto.somanuals.com>

TV manuals search

<http://tv.somanuals.com>