

Grizzly **Industrial, Inc.**®

MODEL G0440/G0441

2 HP & 3 HP

CYCLONE DUST COLLECTORS

OWNER'S MANUAL

(For models manufactured since 03/12)



Model G0441 Shown
With Optional Stand



COPYRIGHT © APRIL, 2005 BY GRIZZLY INDUSTRIAL, INC. REVISED OCTOBER, 2013 (TS)

**WARNING: NO PORTION OF THIS MANUAL MAY BE REPRODUCED IN ANY SHAPE
OR FORM WITHOUT THE WRITTEN APPROVAL OF GRIZZLY INDUSTRIAL, INC.**

#TR7027 PRINTED IN TAIWAN

V6.10.13



WARNING!

This manual provides critical safety instructions on the proper setup, operation, maintenance, and service of this machine/tool. Save this document, refer to it often, and use it to instruct other operators.

Failure to read, understand and follow the instructions in this manual may result in fire or serious personal injury—including amputation, electrocution, or death.

The owner of this machine/tool is solely responsible for its safe use. This responsibility includes but is not limited to proper installation in a safe environment, personnel training and usage authorization, proper inspection and maintenance, manual availability and comprehension, application of safety devices, cutting/sanding/grinding tool integrity, and the usage of personal protective equipment.

The manufacturer will not be held liable for injury or property damage from negligence, improper training, machine modifications or misuse.



WARNING!

Some dust created by power sanding, sawing, grinding, drilling, and other construction activities contains chemicals known to the State of California to cause cancer, birth defects or other reproductive harm. Some examples of these chemicals are:

- **Lead from lead-based paints.**
- **Crystalline silica from bricks, cement and other masonry products.**
- **Arsenic and chromium from chemically-treated lumber.**

Your risk from these exposures varies, depending on how often you do this type of work. To reduce your exposure to these chemicals: Work in a well ventilated area, and work with approved safety equipment, such as those dust masks that are specially designed to filter out microscopic particles.

Table of Contents

INTRODUCTION	2	SECTION 4: DESIGNING THE SYSTEM	26
Machine Description	2	General	26
Contact Info.....	2	Duct Material.....	26
Manual Accuracy	2	Metal Duct	27
Identification.....	3	Flexible Duct.....	27
G0440 Machine Data Sheet	4	System Design.....	28
G0441 Machine Data Sheet	6	Step 1. Decide Who Will Design	28
SECTION 1: SAFETY	8	Step 2. Sketch Your Shop Layout.....	28
Safety Instructions for Machinery	8	Step 3. Sketch a Basic Duct Layout.....	28
Additional Safety for Dust Collectors	10	Step 4. Determine Required CFMs	29
SECTION 2: POWER SUPPLY	11	Determining Main Line Duct Size.....	30
Availability.....	11	Determining Branch Line Duct Size	30
Full-Load Current Rating	11	Planning Drop Downs.....	30
Circuit Requirements	11	Multiple Dust Ports	31
G0440 Circuit Requirements	11	Two Machines on Same Branch Line	31
G0441 Circuit Requirements	11	Calculating Duct Resistance	31
Connection Type	12	Example Materials List	33
Grounding Instructions	12	System Grounding	34
Extension Cords	12	SECTION 5: OPERATIONS	35
SECTION 3: SETUP	13	Remote Control.....	35
Unpacking	13	General	35
Needed for Setup.....	13	SECTION 6: ACCESSORIES	36
G0440 Inventory	14	SECTION 7: MAINTENANCE	38
G0441 Inventory	15	Emptying Drum	38
Site Considerations.....	16	Cleaning Filter.....	38
Wall Mounting	17	Rinsing Filter.....	38
Materials Needed for Standard Wood		Removing/Replacing Filter.....	39
Framed Walls	17	SECTION 8: SERVICE	41
Materials Needed for Concrete/Masonry		Troubleshooting	41
Wall.....	18	SECTION 9: WIRING	42
Assembly	19	Wiring Safety Instructions	42
Test Run	25	G0440 Wiring Diagram	43
		G0441 Wiring Diagram	44
		G0440/G0441 Electrical Components	45
		SECTION 10: PARTS	46
		G0440 Main	46
		G0441 Main	48
		WARRANTY AND RETURNS	53

INTRODUCTION

Machine Description

The Model G0440/G0441 is a 2-stage cyclone wood dust collector capable of collecting dust from multiple machines running simultaneously.

Cyclonic action separates the heavy dust and chips from the fine particles and drops them into the steel collection drum. Any remaining fine dust travels past the impeller and is trapped by the pleated cartridge filter. With the use of the cable and pulley system on the outside of the filter assembly, the caked dust is brushed down into the collection bag.

The machine is controlled by the remote magnetic switch mounted to it or by the IR remote controller—each control includes timer options.

Contact Info

We stand behind our machines. If you have any questions or need help, use the information below to contact us. Before contacting, please get the serial number and manufacture date of your machine. This will help us help you faster.

Grizzly Technical Support
1203 Lycoming Mall Circle
Muncy, PA 17756
Phone: (570) 546-9663
Email: techsupport@grizzly.com

We want your feedback on this manual. What did you like about it? Where could it be improved? Please take a few minutes to give us feedback.

Grizzly Documentation Manager
P.O. Box 2069
Bellingham, WA 98227-2069
Email: manuals@grizzly.com

Manual Accuracy

We are proud to provide a high-quality owner's manual with your new machine!

We made every effort to be exact with the instructions, specifications, drawings, and photographs contained inside. Sometimes we make mistakes, but our policy of continuous improvement also means that **sometimes the machine you receive will be slightly different than what is shown in the manual.**

If you find this to be the case, and the difference between the manual and machine leaves you confused about a procedure, check our website for an updated version. We post current manuals and manual updates for free on our website at www.grizzly.com.

Alternatively, you can call our Technical Support for help. Before calling, please write down the **Manufacture Date** and **Serial Number** stamped into the machine ID label (see below). This information helps us determine if updated documentation is available for your machine.

Grizzly Industrial MODEL GXXXX
MACHINE NAME

WARNING!

To reduce risk of serious injury when using this machine:

1. Read manual before operation.
2. Wear safety glasses and respirator.
3. Make sure safety glasses and respirator are properly adjusted/setup and used.

4. Make sure the motor has stopped and disconnect power before adjustments, maintenance, or service.
5. DO NOT expose to rain or dampness.
6. DO NOT modify this machine in any way.
7.
8.
9. Do not use alcohol, gasoline, or other flammable liquids.
10. Maintain machine carefully to prevent accidents.

Manufacture Date: []
Serial Number: []



Identification

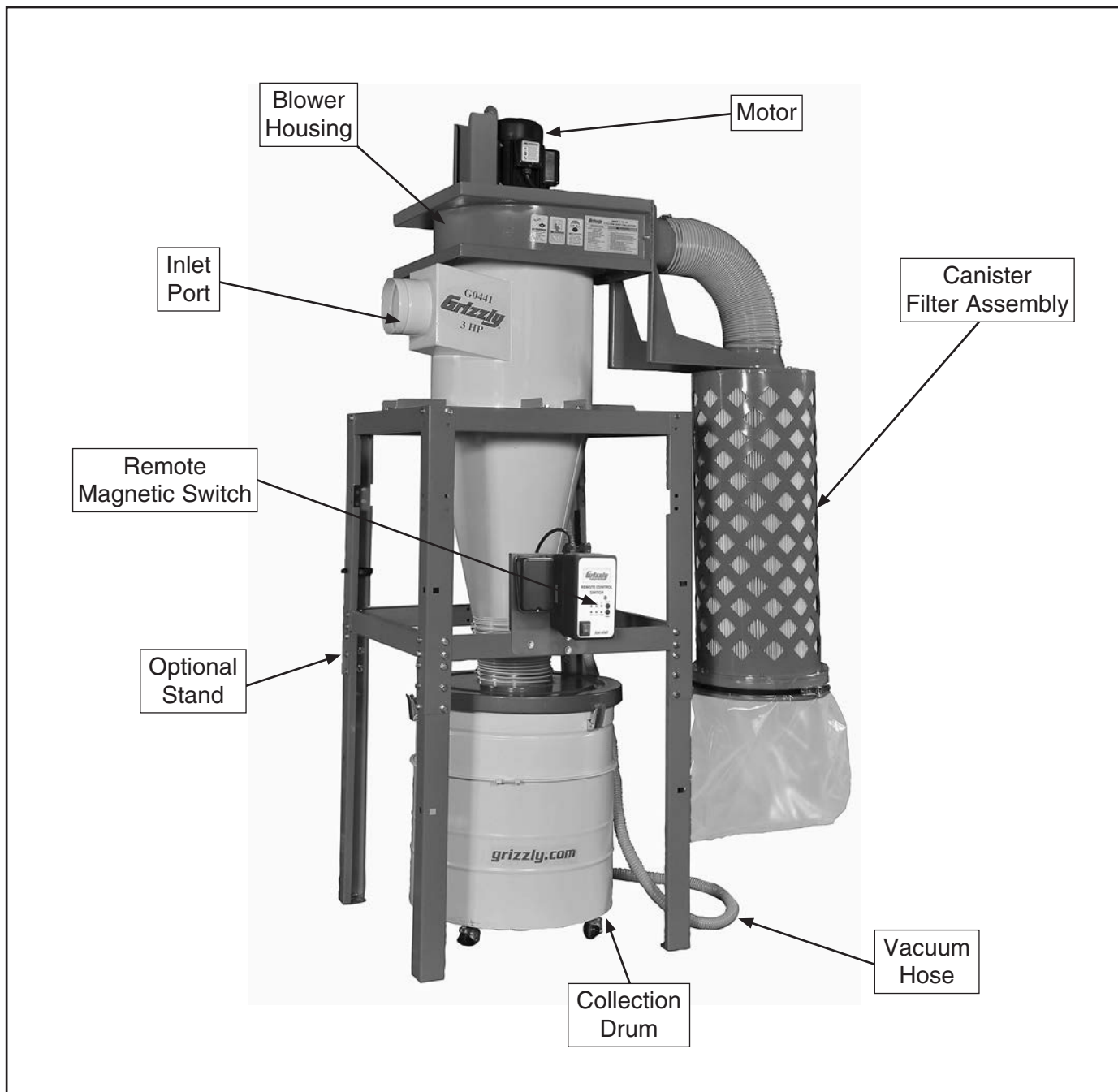

Figure 1. Identification (Model G0441 shown with optional stand).

	<p>⚠ WARNING</p> <p>To reduce the risk of serious injury when using this machine, read and understand this entire manual before beginning any operations.</p>
--	--





MACHINE DATA SHEET

Customer Service #: (570) 546-9663 · To Order Call: (800) 523-4777 · Fax #: (800) 438-5901

MODEL G0440 2 HP CYCLONE DUST COLLECTOR

Product Dimensions:

Weight..... 287 lbs.
 Width (side-to-side) x Depth (front-to-back) x Height..... 59 x 37-3/4 x 93-1/4 in.
 Footprint (Length x Width)..... 37-3/4 x 59 in.

Shipping Dimensions:

Carton #1

Type..... Cardboard Box
 Content..... Machine
 Weight..... 314 lbs.
 Length x Width x Height..... 54 x 28 x 35 in.
 Must Ship Upright..... Yes

Carton #2

Type..... Cardboard Box
 Content..... Canister Filter
 Weight..... 38 lbs.
 Length x Width x Height..... 49 x 18 x 18 in.
 Must Ship Upright..... No

Electrical:

Power Requirement..... 220V, Single-Phase, 60 Hz
 Prewired Voltage..... 220V
 Full-Load Current Rating..... 14A
 Minimum Circuit Size..... 20A
 Connection Type..... Permanent Hardwire
 Switch Type..... Remote Control Magnetic Switch w/Overload Protection

Motors:

Main

Type..... TEFC Capacitor-Start Induction (Class F)
 Horsepower..... 2 HP
 Phase..... Single-Phase
 Amps..... 14A
 Speed..... 3450 RPM
 Power Transfer..... Direct Drive
 Bearings..... Shielded & Permanently Lubricated



Main Specifications:

Operation

Dust Collector Type..... Two-Stage (Cyclone)
Approved Dust Types..... Wood
Filter Type..... Pleated Cartridge
Airflow Capacity..... 1354 CFM @ 2.5 in. SP
Max Static Pressure (at 0 CFM)..... 10.4 in.
Main Inlet Size..... 7 in.
Inlet Adapter Included..... No
Machine Collection Capacity At One Time..... 3 Machines
Maximum Material Collection Capacity..... 4.7 cu. ft.
Filtration Rating..... 0.2 – 2 Micron
Filter Surface Area..... 96 sq. ft.

Bag Information

No of Lower Bags..... 1
Lower Bag Diameter..... 15-3/4 in.

Canister Information

No of Canister Filters..... 1
Canister Filter Diameter..... 15-3/4 in.
Canister Filter Length..... 46-3/4 in.
Collection Drum Size..... 35 Gallons

Impeller Information

Impeller Type..... Radial Fin
Impeller Size..... 14-1/2 in.

Construction

Lower Bag..... Clear Plastic
Canister..... Spun Bond Polyester
Frame..... Steel Sheet Metal (14 ga.)
Impeller..... Steel
Paint..... Powder Coated
Blower Housing..... 11 Gauge Steel
Body..... 14 Gauge Steel
Collection Drum..... Steel

Other

Optional Stand..... H7499

Other Specifications:

Country Of Origin Taiwan
Warranty 1 Year
Approximate Assembly & Setup Time 3 Hours
Serial Number Location ID Label
Sound Rating 83 – 85 dB
ISO 9001 Factory No
CSA Certified Yes
Awards American Woodworker Editor's Pick 2006





MACHINE DATA SHEET

Customer Service #: (570) 546-9663 · To Order Call: (800) 523-4777 · Fax #: (800) 438-5901

MODEL G0441 3 HP CYCLONE DUST COLLECTOR

Product Dimensions:

Weight..... 347 lbs.
 Width (side-to-side) x Depth (front-to-back) x Height..... 60-1/4 x 38-1/2 x 109 in.
 Footprint (Length x Width)..... 32-7/8 x 32-7/8 in.

Shipping Dimensions:

Carton #1

Type..... Cardboard Box
 Content..... Machine
 Weight..... 354 lbs.
 Length x Width x Height..... 53 x 28 x 34 in.
 Must Ship Upright..... Yes

Carton #2

Type..... Cardboard Box
 Content..... Canister Filter
 Weight..... 46 lbs.
 Length x Width x Height..... 49 x 22 x 22 in.
 Must Ship Upright..... No

Electrical:

Power Requirement..... 220V, Single-Phase, 60 Hz
 Rewired Voltage..... 220V
 Full-Load Current Rating..... 22A
 Minimum Circuit Size..... 40A
 Connection Type..... Permanent Hardwire
 Switch Type..... Remote Control Magnetic Switch w/Overload Protection

Motors:

Main

Type..... TEFC Capacitor-Start Induction (Class F)
 Horsepower..... 3 HP
 Phase..... Single-Phase
 Amps..... 22A
 Speed..... 3450 RPM
 Power Transfer..... Direct Drive
 Bearings..... Shielded & Permanently Lubricated



Main Specifications:

Operation

Dust Collector Type..... Two-Stage (Cyclone)
Approved Dust Types..... Wood
Filter Type..... Pleated Cartridge
Airflow Capacity..... 1654 CFM @ 2.0 in. SP
Max Static Pressure (at 0 CFM)..... 14.2 in.
Main Inlet Size..... 8 in.
Inlet Adapter Included..... No
Machine Collection Capacity At One Time..... 3
Maximum Material Collection Capacity..... 7.4 cu. ft.
Filtration Rating..... 0.2 – 2 Micron
Filter Surface Area..... 113 sq. ft.

Bag Information

No of Lower Bags..... 1
Lower Bag Diameter..... 19-3/4 in.

Canister Information

No of Canister Filters..... 1
Canister Filter Diameter..... 19-11/16 in.
Canister Filter Length..... 46-1/4 in.
Collection Drum Size..... 55 Gallons

Impeller Information

Impeller Type..... Radial Fin
Impeller Size..... 15-1/2 in.

Construction

Lower Bag..... Clear Plastic
Canister..... Spun Bond Polyester
Frame..... Steel Sheet Metal (14 ga.)
Impeller..... Steel
Paint..... Powder Coated
Blower Housing..... 11 Gauge Steel
Body..... 14 Gauge Steel
Collection Drum..... Steel

Other

Optional Stand..... H7509

Other Specifications:

Country Of Origin Taiwan
Warranty 1 Year
Approximate Assembly & Setup Time 3 Hours
Serial Number Location ID Label
Sound Rating 83 – 85 dB
ISO 9001 Factory No
CSA Certified Yes
Awards American Woodworker Editor's Pick 2006



SECTION 1: SAFETY

For Your Own Safety, Read Instruction Manual Before Operating This Machine

The purpose of safety symbols is to attract your attention to possible hazardous conditions. This manual uses a series of symbols and signal words intended to convey the level of importance of the safety messages. The progression of symbols is described below. Remember that safety messages by themselves do not eliminate danger and are not a substitute for proper accident prevention measures. Always use common sense and good judgment.



Indicates an imminently hazardous situation which, if not avoided, **WILL** result in death or serious injury.



Indicates a potentially hazardous situation which, if not avoided, **COULD** result in death or serious injury.



Indicates a potentially hazardous situation which, if not avoided, **MAY** result in minor or moderate injury. It may also be used to alert against unsafe practices.

NOTICE

This symbol is used to alert the user to useful information about proper operation of the machine.

Safety Instructions for Machinery



OWNER'S MANUAL. Read and understand this owner's manual **BEFORE** using machine.

TRAINED OPERATORS ONLY. Untrained operators have a higher risk of being hurt or killed. Only allow trained/supervised people to use this machine. When machine is not being used, disconnect power, remove switch keys, or lock-out machine to prevent unauthorized use—especially around children. Make workshop kid proof!

DANGEROUS ENVIRONMENTS. Do not use machinery in areas that are wet, cluttered, or have poor lighting. Operating machinery in these areas greatly increases the risk of accidents and injury.

MENTAL ALERTNESS REQUIRED. Full mental alertness is required for safe operation of machinery. Never operate under the influence of drugs or alcohol, when tired, or when distracted.

ELECTRICAL EQUIPMENT INJURY RISKS. You can be shocked, burned, or killed by touching live electrical components or improperly grounded machinery. To reduce this risk, only allow qualified service personnel to do electrical installation or repair work, and always disconnect power before accessing or exposing electrical equipment.

DISCONNECT POWER FIRST. Always disconnect machine from power supply **BEFORE** making adjustments, changing tooling, or servicing machine. This prevents an injury risk from unintended startup or contact with live electrical components.

EYE PROTECTION. Always wear ANSI-approved safety glasses or a face shield when operating or observing machinery to reduce the risk of eye injury or blindness from flying particles. Everyday eyeglasses are not approved safety glasses.



WARNING

WEARING PROPER APPAREL. Do not wear clothing, apparel or jewelry that can become entangled in moving parts. Always tie back or cover long hair. Wear non-slip footwear to avoid accidental slips, which could cause loss of workpiece control.

HAZARDOUS DUST. Dust created while using machinery may cause cancer, birth defects, or long-term respiratory damage. Be aware of dust hazards associated with each workpiece material, and always wear a NIOSH-approved respirator to reduce your risk.

HEARING PROTECTION. Always wear hearing protection when operating or observing loud machinery. Extended exposure to this noise without hearing protection can cause permanent hearing loss.

REMOVE ADJUSTING TOOLS. Tools left on machinery can become dangerous projectiles upon startup. Never leave chuck keys, wrenches, or any other tools on machine. Always verify removal before starting!

INTENDED USAGE. Only use machine for its intended purpose and never make modifications not approved by Grizzly. Modifying machine or using it differently than intended may result in malfunction or mechanical failure that can lead to serious personal injury or death!

AWKWARD POSITIONS. Keep proper footing and balance at all times when operating machine. Do not overreach! Avoid awkward hand positions that make workpiece control difficult or increase the risk of accidental injury.

CHILDREN & BYSTANDERS. Keep children and bystanders at a safe distance from the work area. Stop using machine if they become a distraction.

GUARDS & COVERS. Guards and covers reduce accidental contact with moving parts or flying debris. Make sure they are properly installed, undamaged, and working correctly.

FORCING MACHINERY. Do not force machine. It will do the job safer and better at the rate for which it was designed.

NEVER STAND ON MACHINE. Serious injury may occur if machine is tipped or if the cutting tool is unintentionally contacted.

STABLE MACHINE. Unexpected movement during operation greatly increases risk of injury or loss of control. Before starting, verify machine is stable and mobile base (if used) is locked.

USE RECOMMENDED ACCESSORIES. Consult this owner's manual or the manufacturer for recommended accessories. Using improper accessories will increase the risk of serious injury.

UNATTENDED OPERATION. To reduce the risk of accidental injury, turn machine **OFF** and ensure all moving parts completely stop before walking away. Never leave machine running while unattended.

MAINTAIN WITH CARE. Follow all maintenance instructions and lubrication schedules to keep machine in good working condition. A machine that is improperly maintained could malfunction, leading to serious personal injury or death.

CHECK DAMAGED PARTS. Regularly inspect machine for any condition that may affect safe operation. Immediately repair or replace damaged or mis-adjusted parts before operating machine.

MAINTAIN POWER CORDS. When disconnecting cord-connected machines from power, grab and pull the plug—NOT the cord. Pulling the cord may damage the wires inside. Do not handle cord/plug with wet hands. Avoid cord damage by keeping it away from heated surfaces, high traffic areas, harsh chemicals, and wet/damp locations.

EXPERIENCING DIFFICULTIES. If at any time you experience difficulties performing the intended operation, stop using the machine! Contact our Technical Support at (570) 546-9663.



Additional Safety for Dust Collectors

WARNING

INTENDED USE. This dust collector is designed for collecting wood dust and chips from wood-working machines. DO NOT use it to collect metal, dirt, drywall, asbestos, lead paint, silica, liquids, aerosols, biohazards, or explosive materials. Collecting the wrong materials can result in serious inhalation hazards, fire, or machine damage.

HAZARDOUS DUST. Dust created while using machinery may cause cancer, birth defects, or long-term respiratory damage. Be aware of dust hazards associated with each workpiece material, and always wear a NIOSH-approved respirator to reduce your risk.

WEAR A RESPIRATOR. Fine dust that is too small to be caught in the filter will be blown into the ambient air during operation. To reduce your risk of respiratory damage from this fine dust, always wear a NIOSH approved respirator during operation and for a short time after. Also, never collect dust from any type of hazardous material.

IMPELLER HAZARDS. All objects collected by this machine can strike the rotating impeller. DO NOT place hands, hair, clothing, or tools near the open inlet during operation. The powerful suction could easily pull them into the impeller, which will cause serious personal injury or damage to the machine. Always keep small animals and children away from open dust collection inlets.

DISCONNECTING POWER SUPPLY. Turn the switch **OFF**, disconnect the dust collector from the power supply, and allow the impeller to come to a complete stop before leaving the machine unattended or doing any service, cleaning, maintenance, or adjustments.

REGULAR CLEANING. Regularly check/empty the collection bags or drum to avoid the buildup of fine dust that can increase the risk of fire. Make sure to regularly clean the surrounding area where the machine is operated—excessive dust buildup on overhead lights, heaters, electrical panels, or other heat sources will increase the risk of fire.

SUSPENDED DUST PARTICLES AND IGNITION SOURCES. DO NOT operate the dust collector in areas where explosion risks are high. Areas of high risk include, but are not limited to, areas near pilot lights, open flames, or other ignition sources.

AVOIDING SPARKS. Avoid collecting steel fragments or stones. These items can produce sparks when they strike the impeller, which can smolder in wood dust for a long time before a fire is detected. If you accidentally cut into wood containing tramp metal (nails, staples, spikes, etc.), immediately turn **OFF** the dust collector, disconnect it from power, and wait for the impeller to stop—then empty the collection container into an approved airtight metal container.

OPERATING LOCATION. To reduce respiratory exposure to fine dust, locate permanently installed dust collectors away from the working area or in another room. DO NOT place the dust collector where it can be exposed to rain or moisture—exposure to water creates a shock hazard and will reduce the life of the machine.

FIRE SUPPRESSION. Only operate the dust collector in locations that contain a fire suppression system or have a fire extinguisher nearby.

STATIC ELECTRICITY. Plastic dust lines generate high amounts of static electricity as dust chips pass through them. Although rare, sparks caused by static electricity can cause explosions or fire. To reduce this risk, make sure all dust lines are thoroughly grounded by using a grounding wire.

EMPTYING DUST. When emptying dust from the collection container, wear a respirator and safety glasses. Empty dust away from ignition sources and into an approved container.

DUST ALLERGIES. Dust from certain woods will cause an allergic reaction. Always make sure you know what type of wood dust you are exposed to in the event that this happens.



SECTION 2: POWER SUPPLY

Availability

Before installing the machine, consider the availability and proximity of the required power supply circuit. If an existing circuit does not meet the requirements for this machine, a new circuit must be installed. To minimize the risk of electrocution, fire, or equipment damage, installation work and electrical wiring must be done by an electrician or qualified service personnel in accordance with all applicable codes and standards.

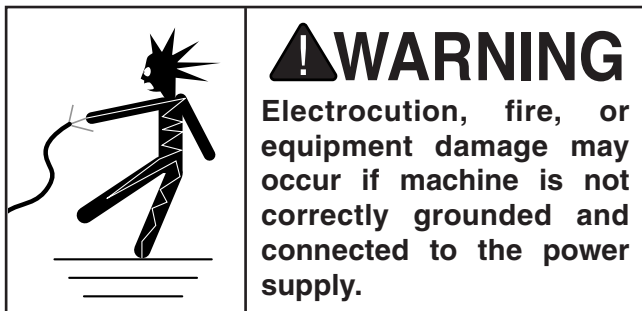

Full-Load Current Rating

The full-load current rating is the amperage a machine draws at 100% of the rated output power. On machines with multiple motors, this is the amperage drawn by the largest motor or sum of all motors and electrical devices that might operate at one time during normal operations.

G0440 Full-Load Current Rating 14 Amps
G0441 Full-Load Current Rating 22 Amps

The full-load current is not the maximum amount of amps that the machine will draw. If the machine is overloaded, it will draw additional amps beyond the full-load rating.

If the machine is overloaded for a sufficient length of time, damage, overheating, or fire may result—especially if connected to an undersized circuit. To reduce the risk of these hazards, avoid overloading the machine during operation and make sure it is connected to a power supply circuit that meets the requirements in the following section.

Circuit Requirements

A power supply circuit includes all electrical equipment between the breaker box or fuse panel in the building and the machine. The power supply circuit used for this machine must be sized to safely handle the full-load current drawn from the machine for an extended period of time. (If this machine is connected to a circuit protected by fuses, use a time delay fuse marked D.)



Note: *The circuit requirements listed in this manual apply to a dedicated circuit—where only one machine will be running at a time. If this machine will be connected to a shared circuit where multiple machines will be running at the same time, consult a qualified electrician to ensure that the circuit is properly sized for safe operation.*

G0440 Circuit Requirements

This machine is prewired to operate on a 220V power supply circuit that has a verified ground and meets the following requirements:

Nominal Voltage 220V/240V
Cycle 60 Hz
Phase Single-Phase
Circuit Rating 20 Amps

G0441 Circuit Requirements

This machine is prewired to operate on a 220V power supply circuit that has a verified ground and meets the following requirements:

Nominal Voltage 220V/240V
Cycle 60 Hz
Phase Single-Phase
Circuit Rating 40 Amps



Connection Type

A permanently connected (hardwired) power supply is typically installed with wires running through mounted and secured conduit. A disconnecting means, such as a locking switch (see following **Figure**), must be provided to allow the machine to be disconnected (isolated) from the power supply when required. This installation must be performed by an electrician in accordance with all applicable electrical codes and ordinances.

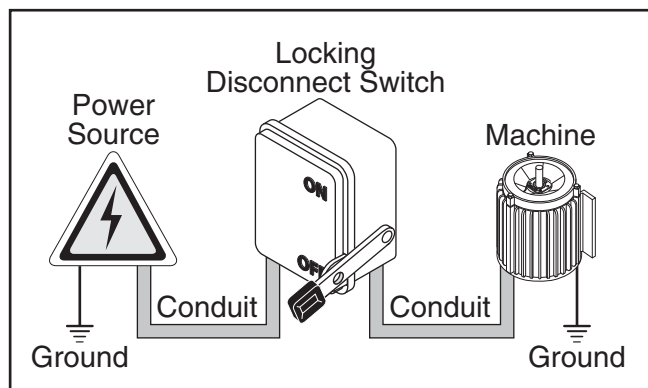

Figure 1. Typical setup of a permanently connected machine.

Grounding Instructions

In the event of a malfunction or breakdown, grounding provides a path of least resistance for electrical current to reduce the risk of electric shock. A permanently connected machine must be connected to a grounded metal permanent wiring system; or to a system having an equipment-grounding conductor. All grounds must be verified and rated for the electrical requirements of the machine. Improper grounding can increase the risk of electric shock!

!WARNING

Serious injury could occur if you connect the machine to power before completing the setup process. DO NOT connect to power until instructed later in this manual.

Extension Cords

Since this machine must be permanently connected to the power supply, an extension cord cannot be used.



SECTION 3: SETUP

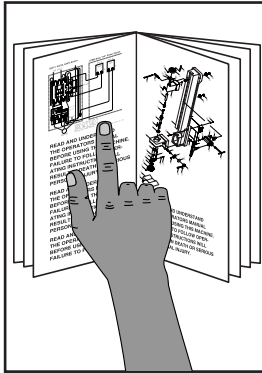

!WARNING
 This machine presents serious injury hazards to untrained users. Read through this entire manual to become familiar with the controls and operations before starting the machine!



!WARNING
 Wear safety glasses during the entire setup process!

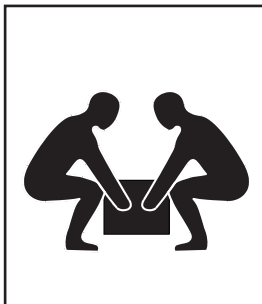

!WARNING
 This machine and its components are very heavy. Get lifting help or use power lifting equipment such as a forklift to move heavy items.

Unpacking

Your machine was carefully packaged for safe transportation. Remove the packaging materials from around your machine and inspect it. If you discover any damage, *please call us immediately at (570) 546-9663 for advice.*

Save the containers and all packing materials for possible inspection by the carrier or its agent. *Otherwise, filing a freight claim can be difficult.*

When you are completely satisfied with the condition of your shipment, inventory the contents.



!WARNING
SUFFOCATION HAZARD!
 Keep children and pets away from plastic bags or packing materials shipped with this machine. Discard immediately.

Needed for Setup

The following are needed to complete the setup process, but are not included with your machine:

Description	Qty
• Assistants for Lifting Help.....	2
• Optional Power Lifting Equipment.....	1
• Wrench or Socket 1/2"	2
• Wrench or Socket 9/16"	2
• Phillips Screwdriver #2	1
• Mounting Hardware (Page 18) ... As Needed	
• Medium-Strength Thread Locking Compound.....	1 Bottle



G0440 Inventory

The following is a list of items shipped with your machine. Before beginning setup, lay these items out and inventory them.

If any non-proprietary parts are missing (e.g. a nut or a washer), we will gladly replace them; or for the sake of expediency, replacements can be obtained at your local hardware store.

Inventory (Figure 2)	Qty
A. Intake Cylinder	1
B. Cyclone Funnel	1
C. Intake Barrel	1
D. Canister/Drum Collection Bags	1 Each
E. Gray Flexible Hose 7" X 32"	1
F. Motor/Blower Housing Assembly	1
G. Collection Drum Lid.....	1
H. Collection Drum.....	1
I. Collection Drum Seal	1
J. Clear Flexible Hose 9" x 8"	1
K. Hose Clamps 9"	2
L. Outlet Port	1
M. Filter L-Braces	2
N. Foam Tape Roll 3 x 6mm	1
O. Hose Clamps 7"	3
P. Hardware Box	
—Phillips Head Screws #10-24 x 3/8"	6
—Hex Nuts #10-24	6
—Drum Latches	3
—Roll of Foam Tape 3 x 15mm	1
Q. Hardware Box	
—Hex Bolts 5/16"-18 x 1"	22
—Hex Bolts 5/16"-18 x 3/4"	24
—Flat Washers 5/16"	64
—Fender Washers 5/16"	4
—Hex Nuts 5/16"-18	22
R. Hardware Box	
—Casters	4
—Hex Nuts 3/8"-16	4
—Lock Washers 3/8"	4
—Flat Washers 3/8"	8
S. Wall Mount Brace	1
T. Barrel Gaskets.....	2
U. Brace Gaskets.....	2
V. Outlet Gasket	1
W. Canister Filter Assembly	1
X. Hose Clamps 1 1/4"	2
Y. Vacuum Hose 1 1/4" x 98"	1
Z. Collection Drum Vacuum Ring	1
AA. Cyclone Vacuum Tube	1

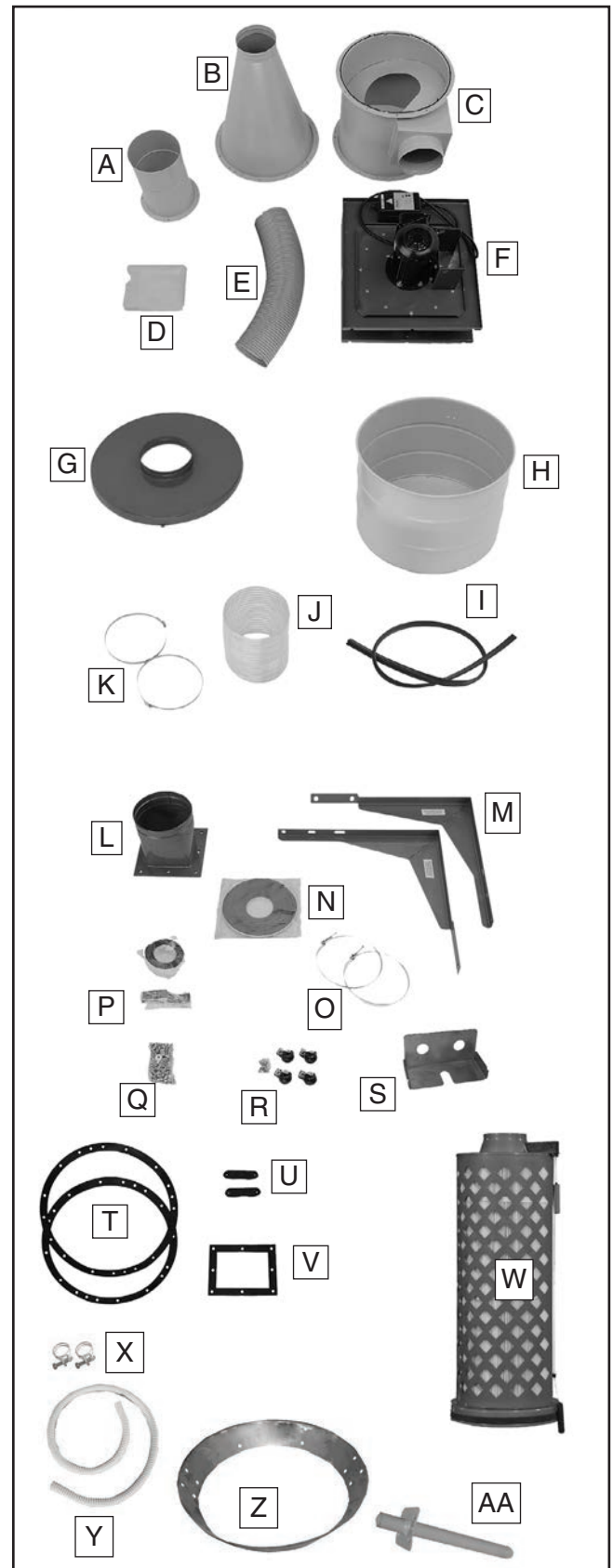

Figure 2. Model G0440 inventory.



G0441 Inventory

The following is a description of the main components shipped with your machine. Lay the components out to inventory them.

Inventory: (Figure 3)	Qty
A. Intake Cylinder	1
B. Cyclone Funnel	1
C. Intake Barrel	1
D. Canister/Drum Collection Bags	1 Each
E. Gray Flexible Hose 8" x 20"	1
F. Motor/Blower Housing Assembly	1
G. Upper Collection Drum	1
H. Muffler	1
I. Gray Flexible Hose 8" x 5"	1
J. Lower Collection Drum	1
K. Clear Flexible Hose 9" x 13"	1
L. Hose Clamps 9"	2
M. Collection Drum Lid	1
N. Collection Drum Seal	1
O. Outlet Port	1
P. Filter L-Braces	2
Q. Foam Tape Roll 3 x 6mm	1
R. Hose Clamps 8"	5
S. Hardware Box	
—Phillips Head Screws #10-24 x 3/8"	12
—Hex Nuts #10-24	12
—Drum Latches	3
—Roll of Foam Tape 3 x 15mm	1
T. Hardware Box	
—Hex Bolts 5/16"-18 x 1"	24
—Hex Bolts 5/16"-18 x 3/4"	24
—Flat Washers 5/16"	68
—Fender Washers 5/16"	4
—Hex Nuts 5/16"-18	24
U. Hardware Box	
—Casters	4
—Hex Nuts 3/8"-16	4
—Lock Washers 3/8"	4
—Flat Washers 3/8"	8
V. Wall Mount Brace	1
W. Barrel Gaskets	2
X. Brace Gaskets	2
Y. Outlet Gasket	1
Z. Canister Filter Assembly	1
AA. Hose Clamps 1 1/4"	2
AB. Vacuum Hose 1 1/4" x 98"	1
AC. Collection Drum Vacuum Ring	1
AD. Cyclone Vacuum Tube	1

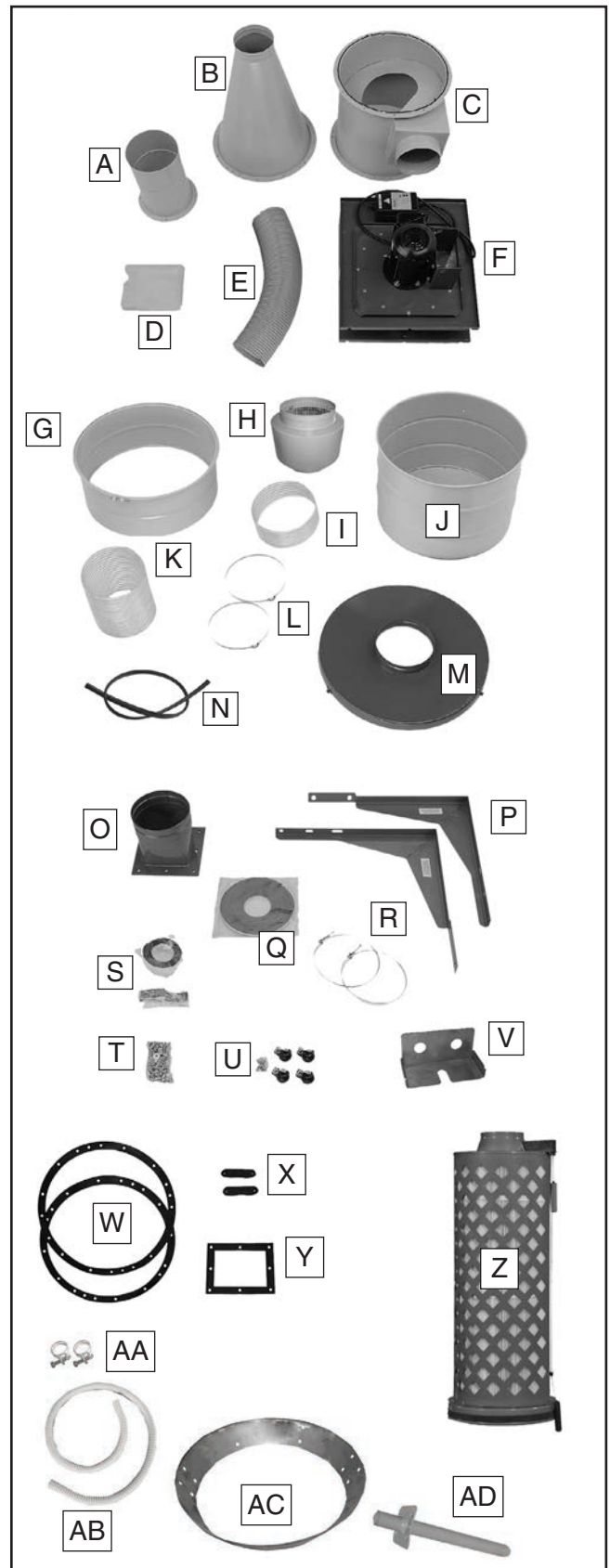

Figure 3. Model G0441 inventory.



Site Considerations

Weight Load

Refer to the **Machine Data Sheet** for the weight of your machine. Make sure that the surface upon which the machine is placed will bear the weight of the machine, additional equipment that may be installed on the machine, and the heaviest workpiece that will be used. Additionally, consider the weight of the operator and any dynamic loading that may occur when operating the machine.

Space Allocation

Consider the largest size of workpiece that will be processed through this machine and provide enough space around the machine for adequate operator material handling or the installation of auxiliary equipment. With permanent installations, leave enough space around the machine to open or remove doors/covers as required by the maintenance and service described in this manual. **See below for required space allocation.**

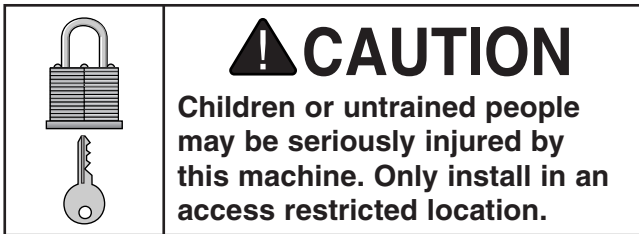

Physical Environment

The physical environment where the machine is operated is important for safe operation and longevity of machine components. For best results, operate this machine in a dry environment that is free from excessive moisture, hazardous chemicals, airborne abrasives, or extreme conditions. Extreme conditions for this type of machinery are generally those where the ambient temperature range exceeds 41°–104°F; the relative humidity range exceeds 20–95% (non-condensing); or the environment is subject to vibration, shocks, or bumps.

Electrical Installation

Place this machine near an existing power source. Make sure all power cords are protected from traffic, material handling, moisture, chemicals, or other hazards. Make sure to leave access to a means of disconnecting the power source or engaging a lockout/tagout device, if required.

Lighting

Lighting around the machine must be adequate enough that operations can be performed safely. Shadows, glare, or strobe effects that may distract or impede the operator must be eliminated.

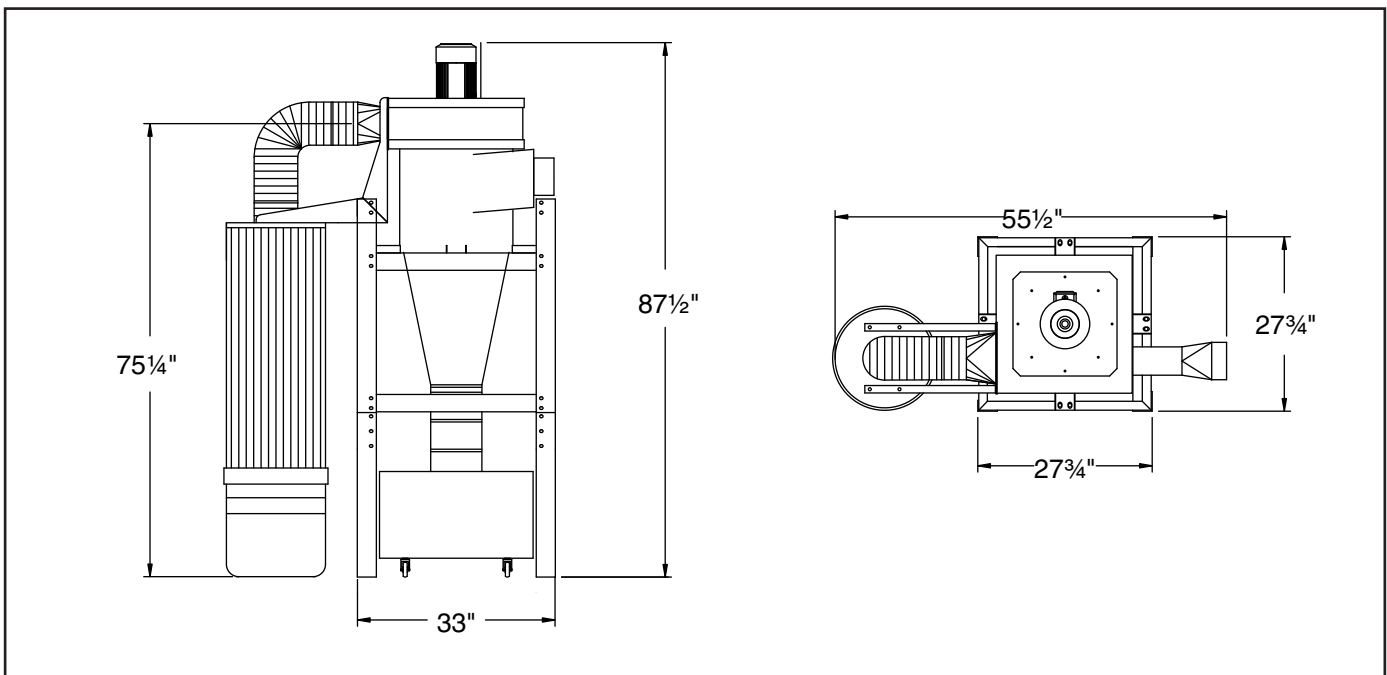

Figure 4. Minimum working clearances.



Wall Mounting

Before mounting, make sure you locate your dust collector away from any open flames or potential ignition sources, as fine dust can easily ignite.

If you are mounting your dust collector to a wood framed wall, you must build and install the wall mounting boards described below to support the heavy weight of the dust collector.

If you are mounting your dust collector to a concrete or masonry wall, skip to **Page 18**.

Materials Needed for Standard Wood Framed Walls

- 2x12 Board 36" Long for Wall Mounting..... 1
- 2x6 Board 36" Long for Wall Mounting 1
- Level 4' 1
- Pencil..... 1
- Measuring Tape..... 1
- Lag Bolts $\frac{3}{8}$ " x 5" (board/wall)..... 16
- Flat Washers $\frac{3}{8}$ " (board/wall)..... 16
- Lag Bolts $\frac{1}{2}$ " x 2" (machine/board)8*
- Flat Washers $\frac{1}{2}$ " (machine/board)8*
- Drill 1
- Drill Bit $\frac{1}{4}$ " (for $\frac{3}{8}$ " predrill)..... 1
- Drill Bit $\frac{3}{8}$ " (for $\frac{1}{2}$ " predrill) 1
- Stud Finder..... 1

**Two of these fastener sets will be used in mounting the intake barrel brace during assembly.*

To mount the motor/impeller housing to a wood framed wall:

1. Secure the wall mounting boards to your wall, using the applicable layout diagrams for your machine and wall type (see **Figures 5–6**).

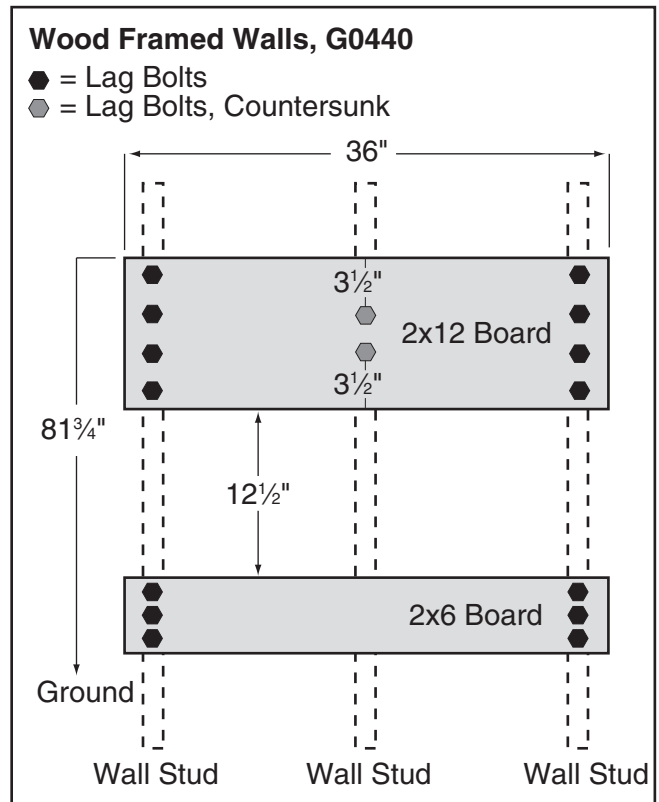

Figure 5. G0440 wall mounting board layout.

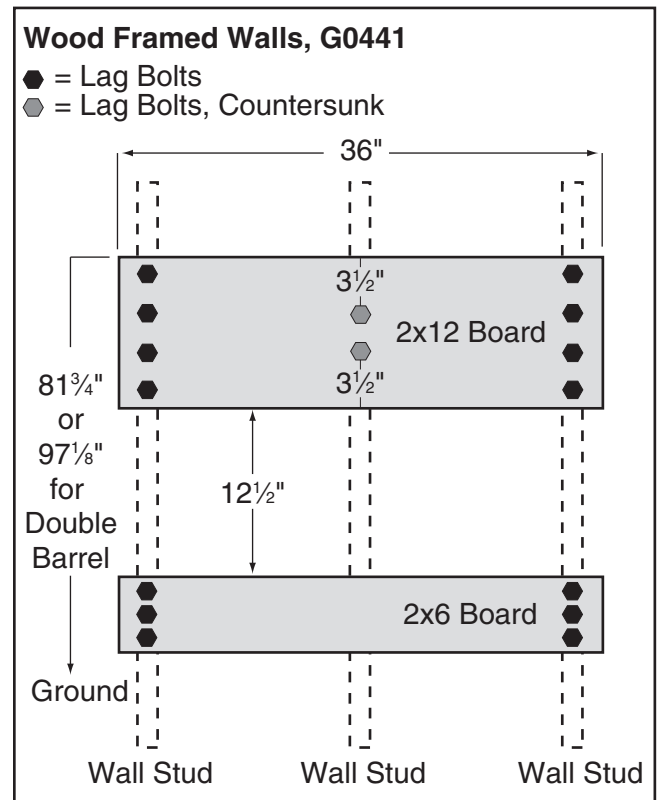

Figure 6. G0441 wall mounting board layout.



- Copy the mounting hole layout pattern from the motor housing (see **Figures 7–8**) to your wall mounting board, making sure the **Top Row Mounting Hole Height** is correct for your dust collector.

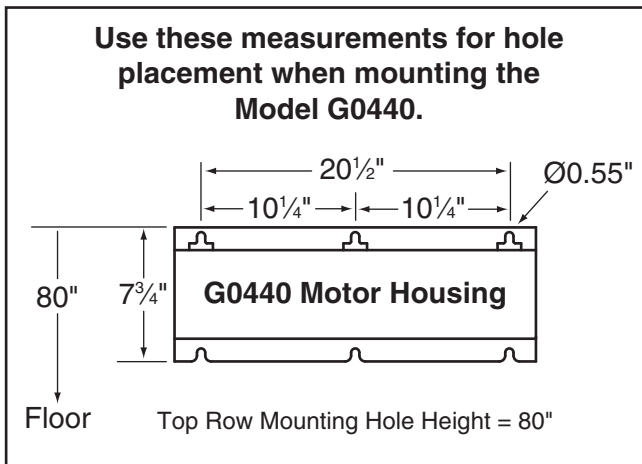

Figure 7. G0440 wall mounting layout.

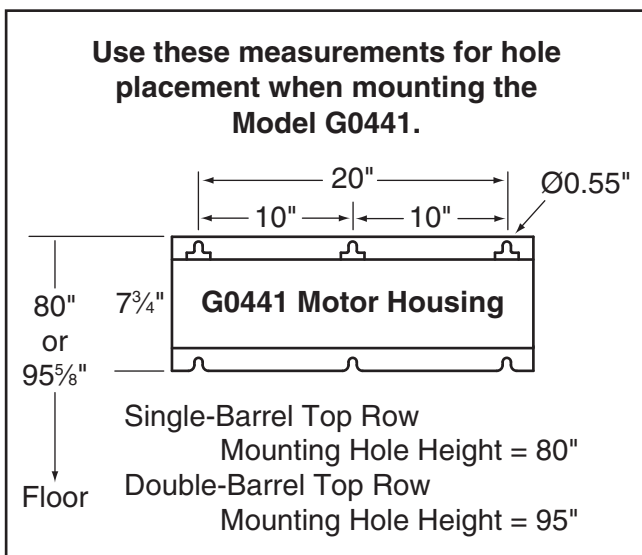

Figure 8. G0441 wall mounting layout.

- Tighten $\frac{1}{2}$ " lag bolts into the mounting locations so they do not poke out more than $\frac{1}{2}$ " from the mounting board to the top of the head, but leave them out enough to slide the housing over. This will prepare you for the mounting instructions described in **Assembly** on **Page 19**.

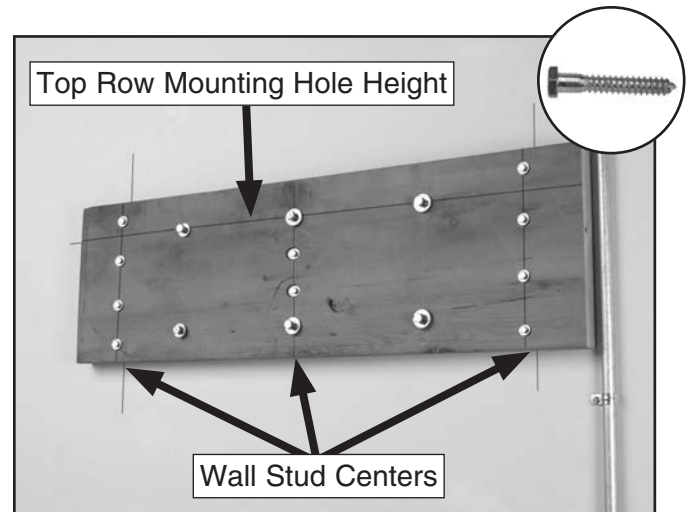

Figure 9. Board fastened to wall and ready for G0440 motor/blower housing assembly.

Materials Needed for Concrete/Masonry Wall

- Concrete Anchor Stud $\frac{1}{2}$ " x $2\frac{3}{4}$ " 8*
- Hex Nuts $\frac{1}{2}$ " 8*
- Flat Washers $\frac{1}{2}$ " 8*
- Hammer Drill 1
- Masonry Drill Bit $\frac{1}{2}$ " 1
- Level 4' 1
- Pencil 1
- Measuring Tape 1

**Two of these fastener sets will be used in mounting the intake barrel brace during assembly.*

To mount the motor/impeller housing to a concrete or masonry wall:

- Copy the mounting hole layout pattern from the motor housing to your wall, making sure the **Top Row Mounting Hole Height** (see **Figures 7–8**) is correct for your dust collector.
- Mount the anchor studs to the wall in the mounting hole locations for the motor/impeller housing. This will prepare you for the mounting instructions described in **Assembly** on **Page 19**.



Assembly

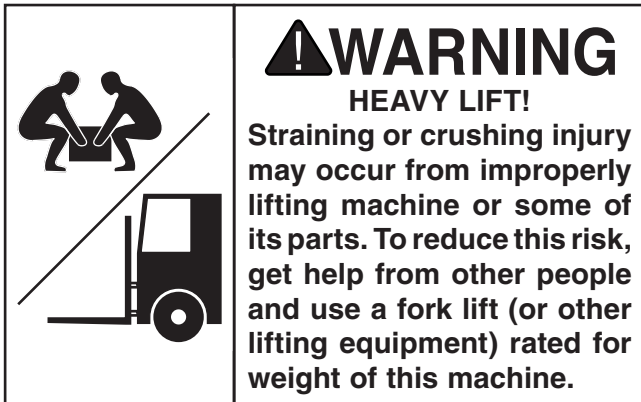

To assemble dust collector:

1. With the help of assistants or power lifting equipment, secure the motor/blower housing assembly onto the hardware you mounted in the **Wall Mounting** section.
2. Attach the 3 x 6mm foam tape to the top of the intake cylinder, as shown in **Figure 10**.

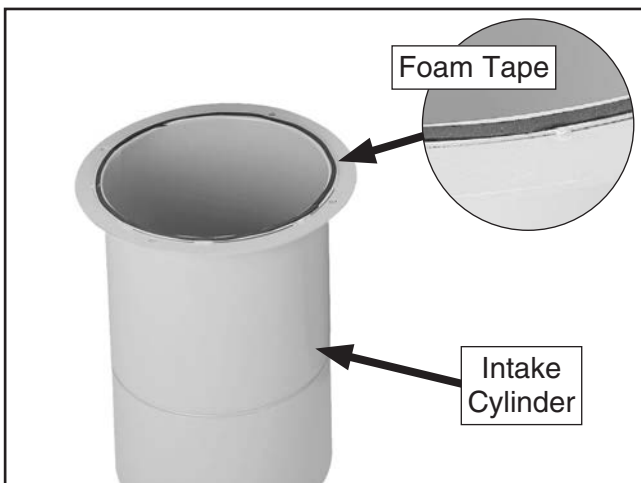

Figure 10. Foam tape stuck on intake cylinder.

3. Attach the intake cylinder to the bottom of the housing, as shown in **Figure 11**, using (4) $\frac{5}{16}$ "-18 x $\frac{3}{4}$ " hex bolts and (4) $\frac{5}{16}$ " flat washers.

Note: Because this part of the dust collector will not be accessible after assembly, consider using medium strength thread locking compound on the bolts that secure the intake cylinder to the motor/blower housing assembly. This added measure will ensure that the fasteners will not come loose from vibration.

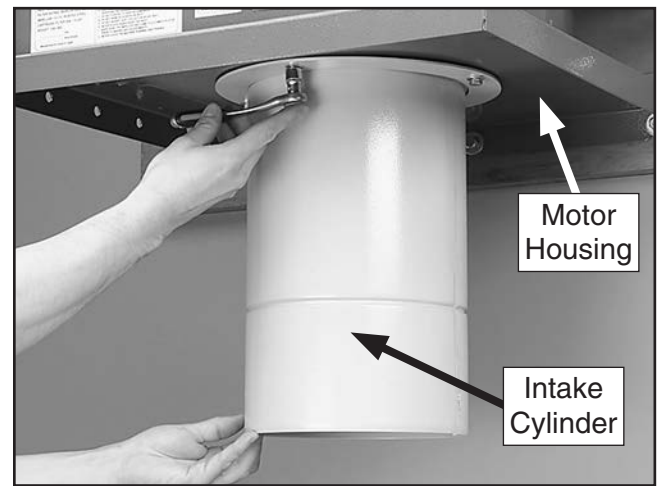

Figure 11. Attaching intake cylinder to the bottom of motor housing.

4. Temporarily attach the intake barrel to the housing with a barrel gasket in between, as shown in **Figure 12**, using (4) $\frac{5}{16}$ "-18 x $\frac{3}{4}$ " hex bolts and (4) $\frac{5}{16}$ " flat washers—and only snug the bolts, rather than fully tighten them.

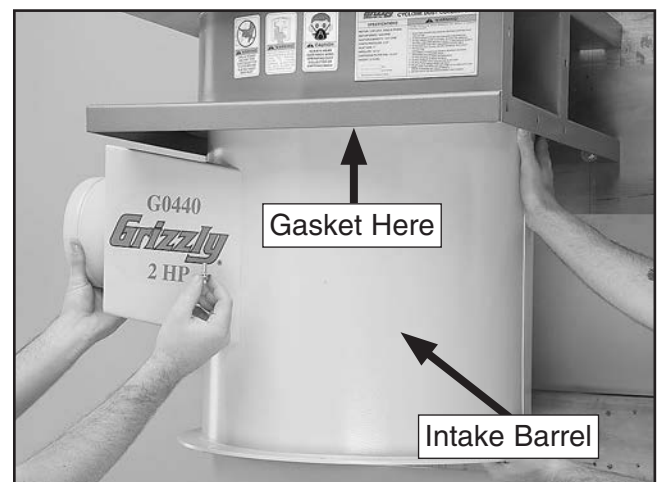

Figure 12. Securing blower on intake barrel.



- Place the intake barrel brace in position and mark the location of the mounting holes (shown in **Figure 13**) with a small pencil, nail, or push pin.

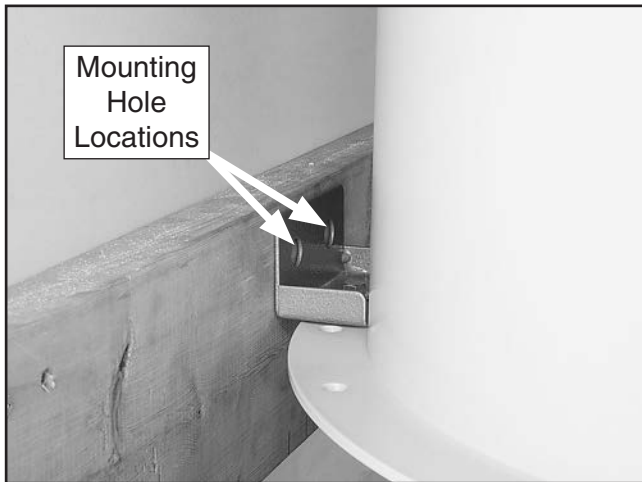

Figure 13. Intake barrel brace positioned to mark the mounting holes.

- Remove the intake barrel you temporarily attached in **Step 4**, drill holes where you marked in **Step 5**, and loosely install the wall mount brace to the wall with the remaining fasteners from the **Wall Mounting** procedure.
- Use the (12) $\frac{5}{16}$ "-18 x $\frac{3}{4}$ " hex bolts and (12) $\frac{5}{16}$ " flat washers to re-install the intake barrel to the housing with a barrel gasket in between, as shown in **Figure 12** on the previous page.

Note: When installing the two bolts above the intake port, use duct tape on the bottom of your wrench to hold the bolts in place, as shown in **Figure 14**, to start the bolts easier.

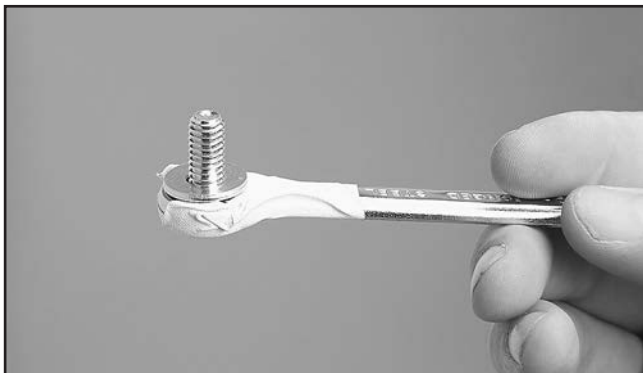

Figure 14. Using tape on wrench in tight spot.

- Attach the cyclone funnel to the intake barrel with a barrel gasket between them, as shown in **Figure 15**, using (12) $\frac{5}{16}$ "-18 x 1" hex bolts, (24) $\frac{5}{16}$ " flat washers, and (12) $\frac{5}{16}$ "-18 hex nuts; also secure the wall mounting brace to the lip of the intake barrel/funnel assembly with the same hardware.

Note: At the places where you see 3 holes in a row, only use the center hole for this step. The two outside holes are only designed for use with the optional stand.

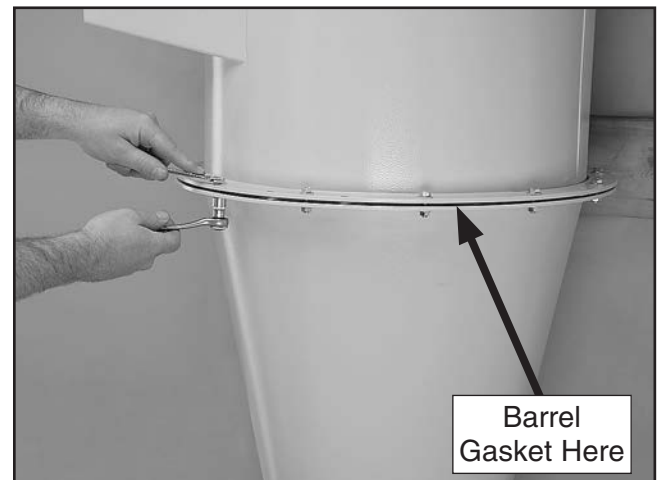

Figure 15. Cyclone funnel attached to intake barrel.

- Tighten the wall mounting brace to the wall.
- Attach the cyclone vacuum tube to the cyclone funnel with (4) $\frac{5}{16}$ "-18 x $\frac{3}{4}$ " hex bolts and (4) $\frac{5}{16}$ " flat washers (see **Figure 16**).



Figure 16. Cyclone vacuum tube and hose attachment.

11. Attach the outlet port and filter L-braces to the blower housing with the outlet gasket between the outlet port and the housing, as shown in **Figures 17–18**, using (8) $\frac{5}{16}$ "-18 x 1" hex bolts, (16) $\frac{5}{16}$ " flat washers, and (8) $\frac{5}{16}$ "-18 hex nuts.

Note: On the G0441, one of the braces attaches directly to the housing with the following extra hardware: (2) $\frac{5}{16}$ "-18 x 1" hex bolts, (4) $\frac{5}{16}$ " flat washers, and (2) $\frac{5}{16}$ "-18 hex nuts.



Figure 17. Model G0440 outlet port and filter L-braces installed.

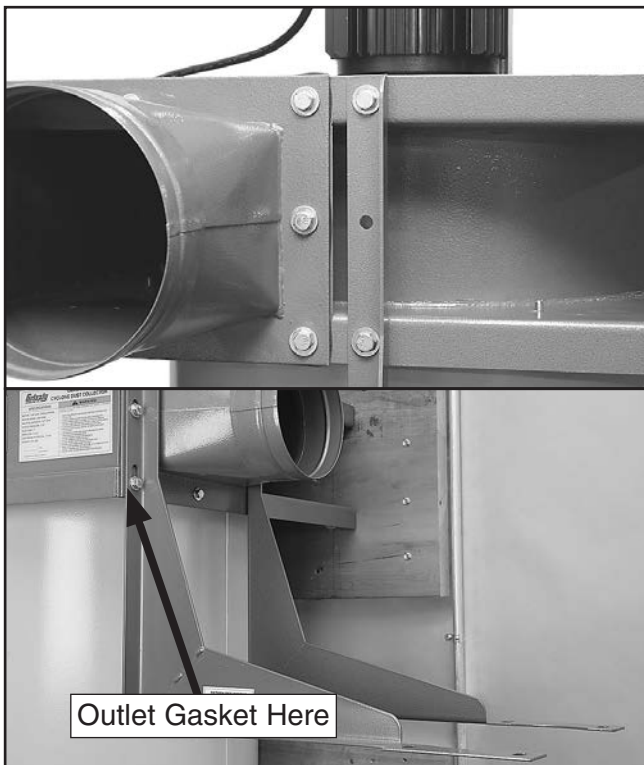

Figure 18. Model G0441 outlet port and filter L-braces installed.

12. Mount the filter to the L-braces with the brace gaskets between them, as shown in **Figure 19**, using (4) $\frac{5}{16}$ "-18 x $\frac{3}{4}$ " hex bolts and (4) $\frac{5}{16}$ " fender washers.



Figure 19. Mounting filters to the braces.

13. Model G0440:

- a. Apply the 3 x 15mm foam tape to the edges of the outlet port and the canister adapter, as shown in **Figure 20**.

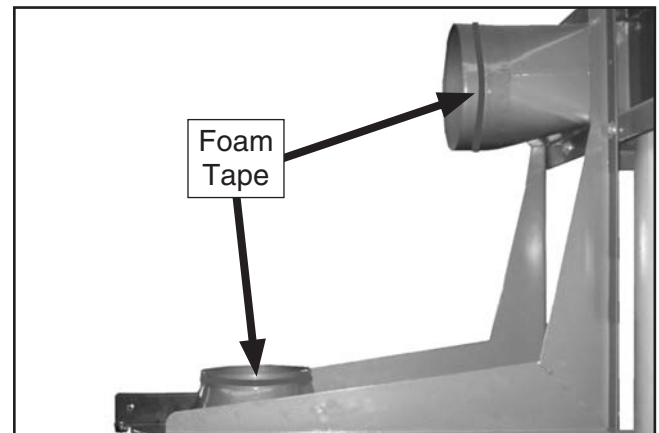

Figure 20. Foam tape applied to the outlet port and canister adapter (Model G0440).



- b. Connect the gray flexible hose from the outlet port to the canister adapter and secure it in place with the two 7" hose clamps, as shown in **Figure 21**.

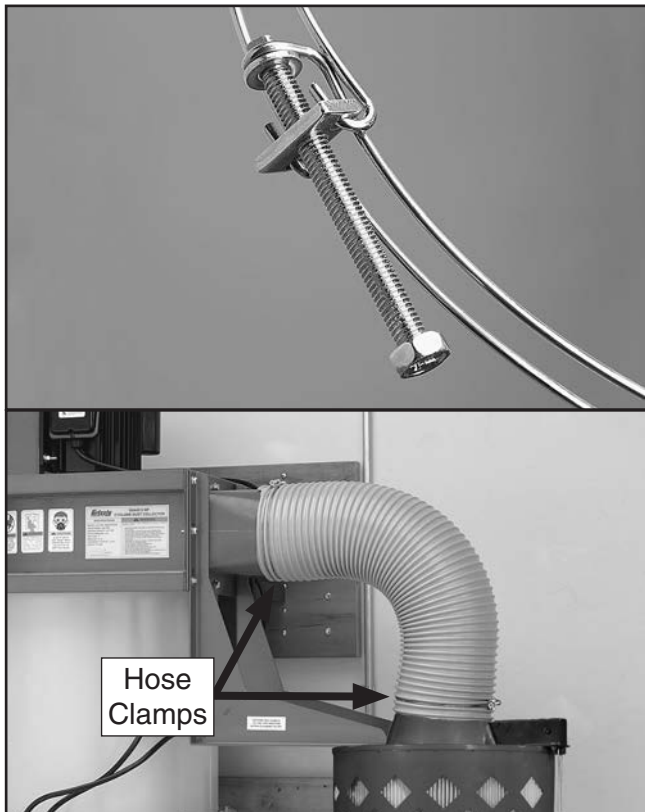

Figure 21. Gray hose properly installed (Model G0440).

Model G0441:

- a. Apply the 3 x 15mm foam tape to the lips of the outlet port, canister adapter, and both ends of the muffler, as shown in **Figure 22**.

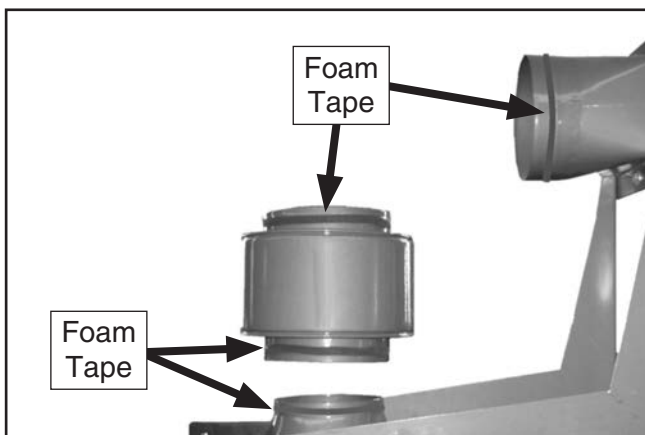

Figure 22. Foam tape applied to upper components (Model G0441).

- b. Attach the 8" x 5" gray flexible hose between the canister adapter and the muffler with two 8" hose clamps, then attach the 8" x 20" gray flexible hose between the muffler and the outlet port with the remaining two 8" hose clamps (see **Figure 23**).

Note: It may be necessary to reposition the canister L-braces down one bolt hole or shorten the length of the longer piece of flexible hose to accommodate the bend in the hose.

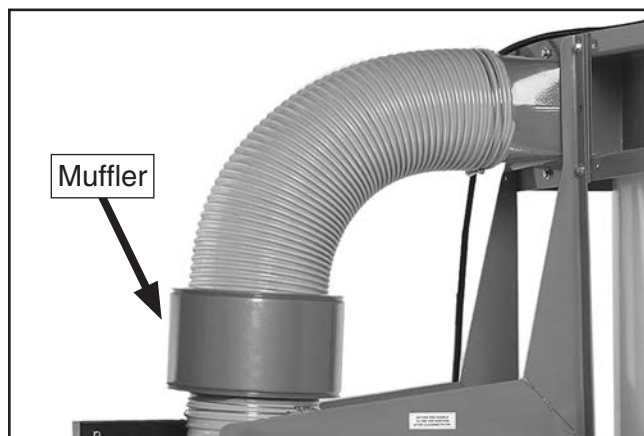

Figure 23. Muffler properly positioned between the two gray flexible hoses (Model G0441).

- 14. Attach the casters to the bottom of the lower collection drum, as shown in **Figure 24**, using the (4) 3/8"-16 hex nuts, (8) 3/8" flat washers, and (4) 3/8" lock washers included in the box with the casters.



Figure 24. Casters attached to the lower collection drum.



Note—For the Model G0441 Only: If you plan to keep your machine under an 8' ceiling, skip **Step 15**.

- 15. Model G0441:** Connect the upper and lower collection drums together and secure them with the included metal clamp and provided fasteners, as shown in **Figure 25**.

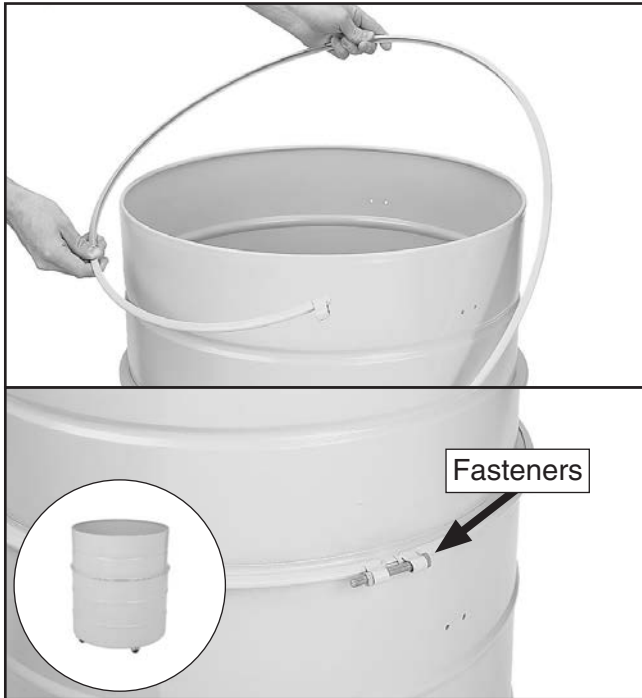

Figure 25. Installing metal clamp around collection drum.

- Install the drum latches, as shown in **Figure 26**, with the (6) #10-24 x $\frac{3}{8}$ " Phillips head screws and (6) #10-24 hex nuts included in the box with the drum latches. Make sure the hex nuts are on the outside of the drum so that they will not snag the plastic collection bag.

Note—For the Model G0441 Only: If you are using the collection drum at full height, use the extra (6) #10-24 Phillips head screws and hex nuts provided to plug the lower latch mounting holes.



Figure 26. Installing drum latches on collector drum.

- Place the collection drum vacuum ring on the bottom of the collection drum (see **Figure 27**).

Note: During operation, this ring and the vacuum connection to the cyclone funnel will prevent the collection bag from collapsing.



Figure 27. Inserting collection drum vacuum ring.



18. Insert the rubber seal over the top lip of the collection drum rim. Pay special attention to the direction of the seal, as shown in the **Figure 28**.

Tip: To keep the seal in place, you can use an adhesive applied to the rubber seal at approximately 1" intervals.

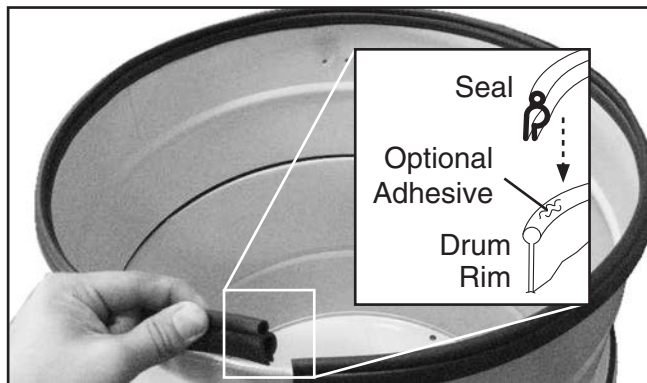

Figure 28. Installing canister seal.

19. Insert the larger of the plastic collection bags into the collection drum, place the lid on the collection drum and hook the latch over the lid, as shown in **Figure 29**, then clamp it in place.



Figure 29. Latch hooked over lid for clamping.

20. Move the collector drum under the dust collector and connect it to the cyclone funnel with the clear flexible hose and the two 9" hose clamps, as shown in **Figure 30**.



Figure 30. Drum attached to cyclone funnel with clear 9" hose.

21. Connect the vacuum hose to the cyclone funnel and collection drum vacuum tubes with (2) 1 1/4" hose clamps (see **Figure 31**).



Figure 31. Connecting the vacuum hose.

22. Fit the plastic canister collection bag over the bottom of the canister filter and clamp in place with the metal bag clamp, as shown in **Figure 32**.



Figure 32. Plastic collection bag clamped in place under filter.

23. Mount the switch on the funnel, as shown in **Figure 33**, with the (2) $\frac{5}{16}$ "-18 x 1" hex bolts, (4) $\frac{5}{16}$ " flat washers, and (2) $\frac{5}{16}$ "-18 hex nuts.



Figure 33. Switch mounted to funnel.

Test Run

Once the assembly is complete, test run your machine to make sure it runs properly and is ready for regular operation.

If, during the test run, you cannot easily locate the source of an unusual noise or vibration, stop using the machine immediately, then review the **Troubleshooting** on **Page 41**.

If you still cannot remedy a problem, contact our Tech Support at (570) 546-9663 for assistance.

To test run the machine:

1. Make sure you have read the safety instructions at the beginning of the manual and that the machine is setup properly.
2. Make sure all tools and objects used during setup are cleared away from the machine.
3. Press the ON/OFF button to turn the machine **ON**.
4. Listen to and watch for abnormal noises or actions. The machine should run smoothly with little or no vibration or rubbing noises.

—Strange or unusual noises should be investigated and corrected before operating the machine further. Always disconnect the machine from power when investigating or correcting potential problems.
5. Press the **TIMER** button and cycle through each of the times to make sure the lights illuminate on the switch.
6. Press the **TIMER** on the remote control and cycle through each of the times in the same manner as **Step 5**.
7. Press the **ON/OFF** button on the remote control to make sure it is working properly.



SECTION 4: DESIGNING THE SYSTEM

General



The Model G0440/G0441 works great as a central system for a small shop or a dedicated dust collector for large production machines.

When installing the dust collector be sure to put it in an out of the way location such as a corner or separate room. The dust collector is capable of collecting dust from up to three machines running simultaneously. Grizzly offers a complete line of dust collection accessories for setting up a stationary system. Additionally, Grizzly offers a complete guide book entitled *Dust Collection Basics*.

Whatever system you choose, always make sure there are no open flames or pilot lights in the same room as the dust collector. There is a risk of explosion if dust is dispersed into the air.

Duct Material

You have many choices regarding main line and branch line duct material. For best results, use metal duct for the main line and branch lines, then use short lengths of flexible hose to connect each machine to the branch lines.

Plastic duct is also a popular material for home shops. However, be aware that there is a fire or explosion hazard if plastic duct material is used for dust collection without being grounded against static electrical charge build-up. This topic will be discussed later in this section. Another problem with using plastic is that it is less efficient per foot than metal.

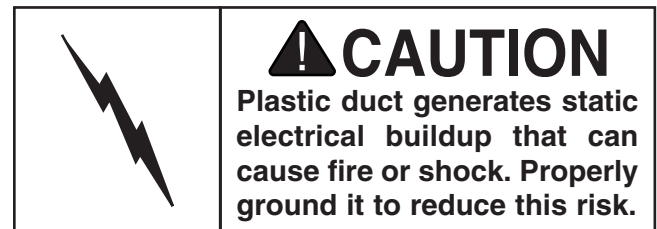

Plastic Duct

The popularity of plastic duct is due to the fact that it is an economical and readily available product. It is also simple to assemble and easily sealed against air loss. The primary disadvantage of plastic duct for dust collection is the inherent danger of static electrical build-up.



Figure 34. Examples of plastic ducting components.



Metal Duct

Advantages of metal duct is its conductivity and that it does not contribute to static electrical charge build-up. However, static charges are still produced when dust particles strike other dust particles as they move through the duct. Since metal duct is a conductor, it can be grounded quite easily to dissipate any static electrical charges.

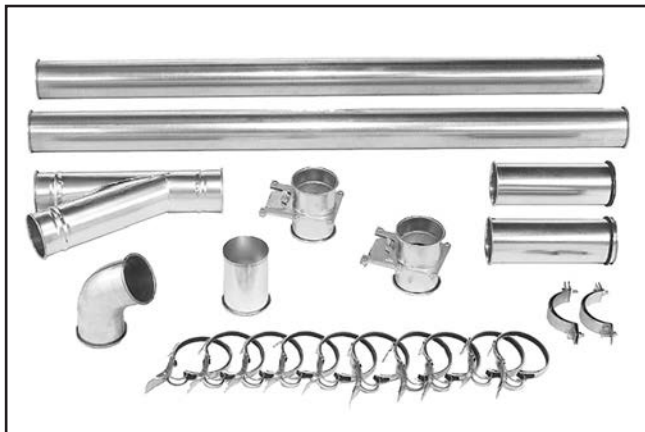

Figure 35. Examples of metal pipe and components.

There are a number of options when it comes to metal duct, but metal duct that is specially manufactured for dust collection is the best choice. When selecting your metal duct, choose high quality metal duct with smooth welded internal seams that will minimize airflow resistance. This type of duct usually connects to other ducts or elbows with a simple, self-sealing clamp, is very quick and easy to assemble, and can be readily dismantled and re-installed. This is especially important if you ever need to change things around in your shop or add more tools.

Avoid inferior metal duct that requires you to cut it to length and snap it together. This type of duct is time consuming to install because it requires you to seal all the seams with silicone and screw the components on the ends with sheet metal screws. Another disadvantage is the rough internal seams and crimped ends that unavoidably increase static pressure loss.

Flexible Duct

Flexible hose is generally used for short runs, small shops and at rigid duct-to-tool connections. There are many different types of flex hose on the market today. These are manufactured from materials such as polyethylene, PVC, cloth hose dipped in rubber and even metal, including steel and aluminum.

The superior choice here is metal flex hose that is designed to be flexible, yet be as smooth as possible to reduce static pressure loss.

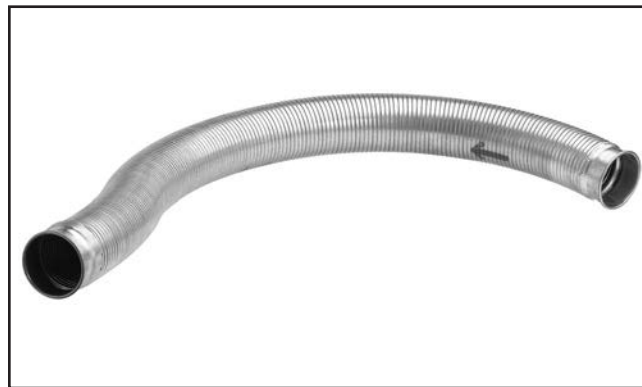

Figure 36. Example of flexible metal duct.

There are also many kinds of pure plastic flexible hose, such as non-perforated drainage type hose and dryer vent hose. Drainage type hose, while being economical, does not quite have the flexibility required for dust collection. The inside of the duct is also deeply corrugated and can increase the static pressure loss by as much as 50% over smooth wall duct. Dryer vent hose, while being completely flexible, is non-resistant to abrasion and has a tendency to collapse in a negative pressure system. We DO NOT recommend using dryer vent hose in your dust collection system.

If using flex-hose, you should choose one of the many types that are designed specifically for the movement of solid particles, i.e. dust, grains, and plastics. However, the cost of specifically designed flexible duct can vary greatly. Grizzly offers polyethylene hose, which is well suited for the removal of particulate matter, especially sawdust, since it is durable and completely flexible. Polyethylene is also very economical and available in a wide variety of diameters and lengths for most applications.



System Design

Step 1. Decide Who Will Design

For most small-to-medium sized shops, you can design and build the dust collection system yourself without hiring engineers or consultants. We have included some basic information here to get you started on a basic design.

If you have a large shop or plan to design a complicated system, we recommend doing additional research beyond this manual or seeking the help of an expert.

Step 2. Sketch Your Shop Layout

When designing a successful dust collection system, planning is the most important step. In this step, sketch a basic layout of your shop, including space requirements of different machines.

Before you get out your pencil and paper, we recommend you visit our **FREE Workshop Planner** available on our website at www.grizzly.com.

Our *Workshop Planner* will allow you to quickly and easily design and print a basic shop layout. Don't worry, non-Grizzly brand machines can be substituted with Grizzly machines for layout purposes. **Note:** After you're finished, make sure to save your layout for later modification.

Your sketch only needs the basic details of the shop layout, similar to the **Figure** below, including all your current/planned machines and your planned placement of the dust collector.

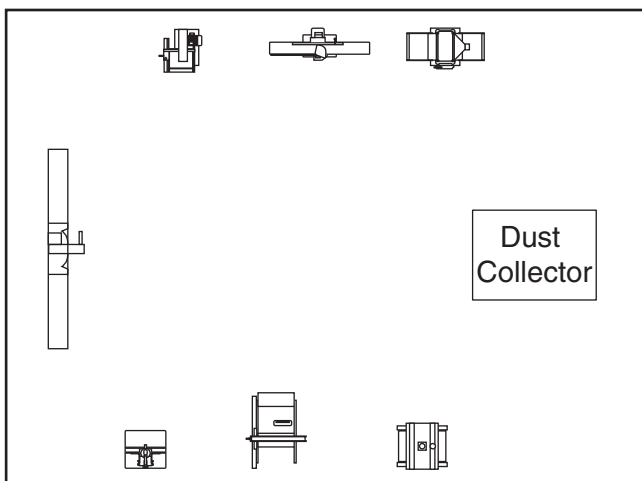

Figure 37. Basic sketch of shop layout.

Step 3. Sketch a Basic Duct Layout

For the next step, sketch how you will connect your machines to the dust collector. Consider these general guidelines for an efficient system:

1. Machines that produce the most saw dust should be placed nearest to the dust collector (i.e. planers and sanders).
2. Ideally, you should design the duct system to have the shortest possible main line and secondary branch ducts. See the figures below for ideas of efficient versus inefficient duct layouts.

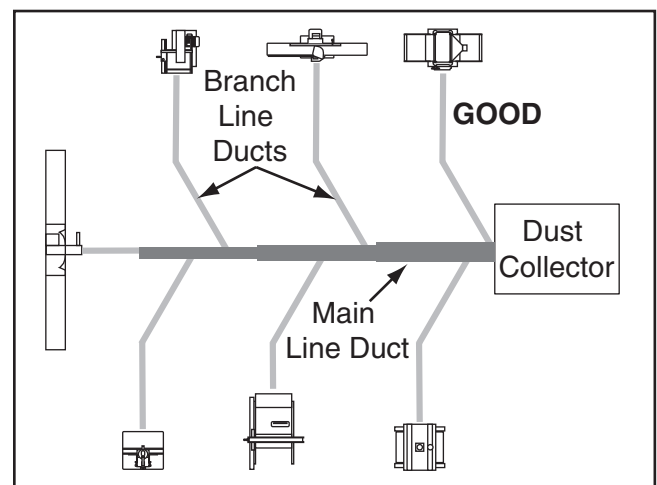

Figure 38. Efficient duct layout.

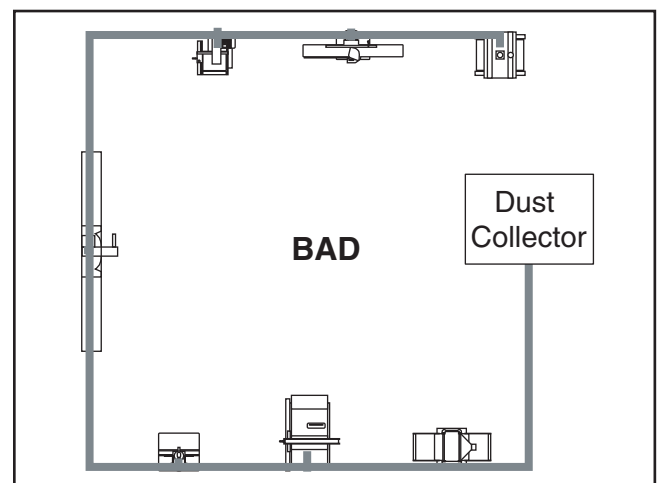

Figure 39. Inefficient duct layout.



3. Directional changes should be kept to a minimum. The more directional change fittings you use directly increases the overall resistance to airflow.
4. Gradual directional changes are more efficient than sudden directional changes (i.e. use the largest corner radius possible when changing hose or pipe direction).
5. Each individual branch line should have a blast gate immediately after the branch to control suction from one machine to another.
6. The simpler the system, the more efficient and less costly it will be.

Step 4. Determine Required CFMs

Since each machine produces a different amount of sawdust, the requirements for the minimum amount of CFM to move that sawdust is unique to the machine (for example, a planer produces more sawdust than a table saw). Knowing this required CFM is important to gauging which size of duct to use.

Refer to the **Figure** below for a close estimation of the airflow each machine requires. Keep in mind that machines that generate the most sawdust should be placed closest to the dust collector. If the machine has multiple dust ports, the total CFM required is the sum of all ports.

Machine Dust Port Size	Approximate Required CFM
2"	98
2.5"	150
3"	220
4"	395
5"	614
6"	884
7"	1203
8"	1570
9"	1990
10"	2456

Figure 40. Approximate required airflow for machines, based on dust port size.

If the machine does not have a built-in dust port, use the following table to determine which size of dust port to install.

Machine	Average Dust Port Size
Table Saw.....	4"
Miter/Radial-Arm Saw.....	2"
Jointer (6" and smaller)	4"
Jointer (8"-12")	5"
Thickness Planer (13" and smaller).....	4"
Thickness Planer (14"-20")	6"
Shaper.....	4"
Router (mounted to table).....	2"
Bandsaw.....	4"
Lathe.....	4"
Disc Sander (12" and smaller).....	2"
Disc Sander (13-18").....	4"
Belt Sander (6" and smaller)	2"
Belt Sander (7"-9")	3"
Edge Sander (6" x 80" and smaller).....	4"
Edge Sander (6" x 80" and larger)	5"
Drum Sander (24" and smaller).....	2 x 4"
Drum Sander (24" and larger)	4 x 4"
Widebelt Sander (18" and smaller).....	5"
Widebelt Sander (24"-37" single head) ...	2 x 6"
Widebelt Sander (24"-51" double head) ..	5 x 4"

Figure 41. Dust port size and quantity per average machine.

Write the required CFM for each machine on your sketch, as shown in the figure below.

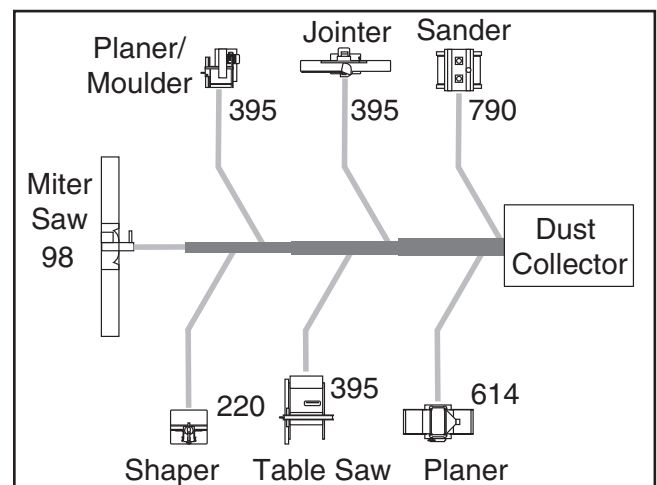

Figure 42. CFM requirements labeled for each machine.



Determining Main Line Duct Size

The general rule of thumb for a main line duct is that the velocity of the airflow must not fall below 3500 FPM.

For small/medium sized shops, using the inlet size of the dust collector as the main line duct size will usually keep the air velocity above 3500 FPM and, depending on your system, will allow you to keep multiple branches open at one time.

Mark your drawing, as shown in the figure below, but using the inlet size for your dust collector as the main line.

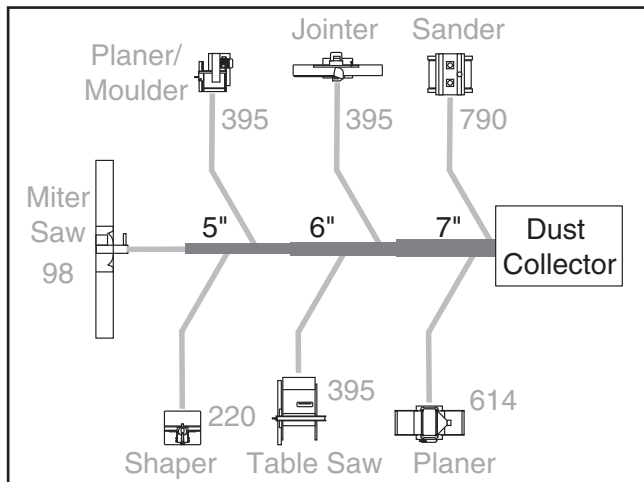

Figure 43. Main line size labeled on sketch.

Determining Branch Line Duct Size

The general rule of thumb for a branch line duct is that the velocity of the airflow must not fall below 4000 FPM.

For small/medium sized shops, using the dust port size from the machine as the branch line duct size will achieve the correct velocity in most applications. However, if the dust port on the machine is smaller than 4", make the branch line 4" and neck the line down right before the dust port.

Note: Systems with powerful dust collectors work better if multiple blast gates are left open. This also allows you to run two machines at once. Experiment with different combinations of blast gates open/closed to find the best results for your system.

Write your determined branch line sizes on your drawing, as shown in the following Figure.

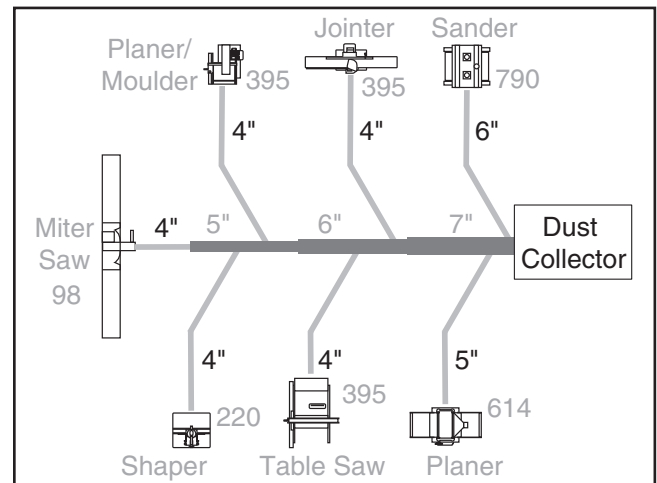

Figure 44. Branch line duct sizes labeled.

Planning Drop Downs

Plan the drop downs for each machine, using blast gates wherever possible to control airflow.

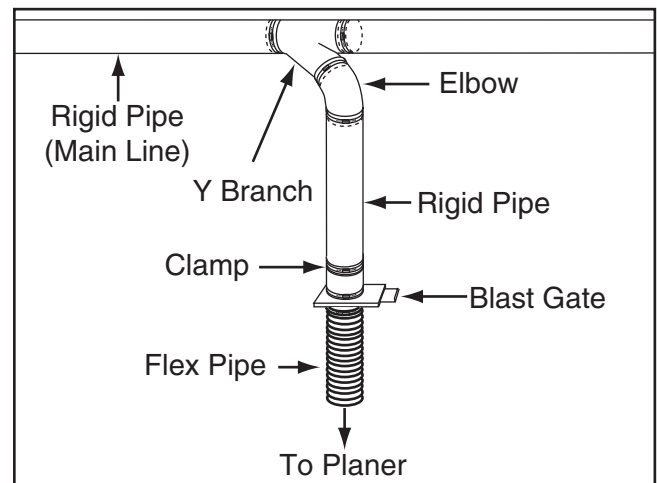

Figure 45. Drop down setup.



Multiple Dust Ports

If your machine has multiple dust ports, add the total CFM given for each dust port size from the table provided in the earlier subsection, **Determine Required CFMs**, then find the closest CFM in the table below to determine the correct branch size. Split the branch line just before the dust ports with matching duct sizes.

Two Machines on Same Branch Line

If two machines will connect to the same branch line and both will operate at the same time, then add the required CFM for each machine together and find the closest total CFM in the table below to determine the correct branch size.

If both machines will never run at the same time, reference the machine with the biggest dust port in the table below and add blast gates after the

Total CFM	Branch Line Size
400	4"
500	4"
600	5"
700	5"
800	6"
900	6"
1000	6"

Calculating Duct Resistance

Adding duct work, elbows, branches and any other components to a duct line increases airflow resistance (static pressure loss). This resistance can be minimized by using rigid (smooth) pipe and gradual curves, as opposed to flexible pipe and 90° elbows.

To help you think about this resistance, imagine riding a bicycle in a tunnel that is an exact replica of your duct work. If the inside of the tunnel is very bumpy (flexible pipe) and has a lot of sharp turns (90° elbows), it will take a lot more effort to travel from one end to the other.

The purpose of calculating the resistance is to determine if it is low enough from the machine to the dust collector to meet the given CFM requirement for the machine. Use the following tables to calculate the resistance of duct work.

Duct Dia.	Approximate Static Pressure Loss Per Foot of Rigid Pipe		Approximate Static Pressure Loss Per Foot of Flex Pipe	
	Main Lines at 3500 FPM	Branch Lines at 4000 FPM	Main Lines at 3500 FPM	Branch Lines at 4000 FPM
2"	0.091	0.122	0.35	0.453
2.5"	0.08	0.107	0.306	0.397
3"	0.071	0.094	0.271	0.352
4"	0.057	0.075	0.215	0.28
5"	0.046	0.059	0.172	0.225
6"	0.037	0.047	0.136	0.18
7"	0.029	0.036	0.106	0.141
8"	0.023	0.027	0.08	0.108
9"	0.017	0.019	0.057	0.079

Fitting Dia.	90° Elbow	45° Elbow	45° Wye(Y)	90° Wye(Y)
3"	0.47	0.235	0.282	0.188
4"	0.45	0.225	0.375	0.225
5"	0.531	0.266	0.354	0.236
6"	0.564	0.282	0.329	0.235
7"	0.468	0.234	0.324	0.216
8"	0.405	0.203	0.297	0.189

Figure 46. Static pressure loss tables.

In most small/medium shops it is only necessary to calculate the line with the longest duct length or the most fittings (operating under the assumption that if the line with the highest resistance works, the others will be fine).

To calculate the static pressure of any given line in the system, follow these steps:

1. Make a list of each size duct in the line, including the length, and multiply those numbers by the static pressure value given in the previous table.
2. List each type of elbow or branch and multiply the quantity (if more than one) by the static pressure loss given in the previous table.



3. Add the additional factors from the following table to your list.

Additional Factors	Static Pressure
Seasoned (well used) Dust Collection Filter	1"
Entry Loss at Large Machine Hood	2"

Figure 47. Additional factors affecting static pressure.

4. Total your list as shown in the example below to come up with your overall static pressure loss number for that line.

Note: Always account for a seasoned filter, so you don't end up with a system that only works right when the filter is clean.

Main Line		
6" Rigid Pipe (0.037) at 20'	0.740
Branch Line		
4" Rigid Pipe (0.075) at 10'	0.750
4" Flex Pipe (0.28) at 5'	1.400
Elbows/Branches		
6" 45° Y-Branch	0.329
4" 45° Elbow	0.225
Additional Factors		
Seasoned Filter	1.000
Total Static Pressure Loss	4.444

Figure 48. Totaling static pressure numbers.

Note: When calculating static pressure loss to determine if multiple lines can be left open at the same time, only include the main line numbers once.

5. Compare the total static pressure loss for that line to the closest CFM given in **Figure 50** for your dust collector on **Page 34**.

Example: A typical **Data Sheet Performance Curve** is illustrated in **Figure 49**. Find 4.4 on the Static Pressure axis (the amount of total static pressure loss calculated in **Figure 48**), then refer to the closest value on the CFM axis—approximately 1120 CFM.

The 1120 CFM for the static pressure loss of the line connected to the router is well above the 220 CFM requirement of that machine.

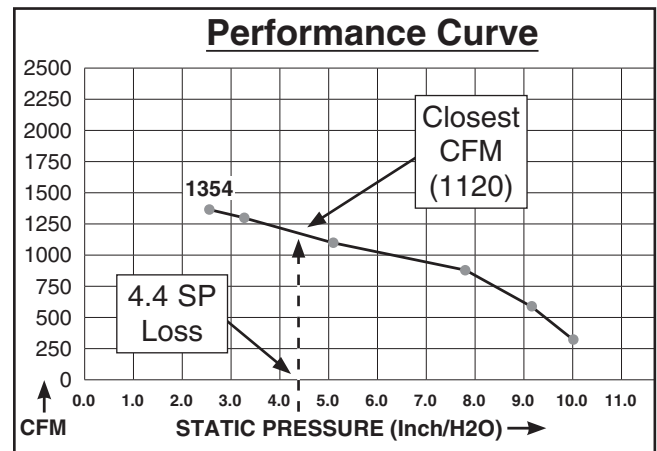

Figure 49. CFM for static pressure loss of line connected to a dust collector & router.

—If the CFM for your static pressure loss is above the requirement of the machine connected to the end of that branch line, then dust collection will most likely be successful. Congratulations! You've just designed your own dust system. Refer to the **Accessories** section on **Page 36** to start buying the components necessary to make your system a reality.

—If the CFM for your static pressure loss is below the requirement of the machine, then that line will not effectively collect the dust. You must then modify some of the factors in that line to reduce the static pressure loss. Some of the ways to do this include 1) installing larger duct, 2) reducing amount of flexible duct used, 3) increasing machine dust port size, 4) moving machine closer to dust collector to eliminate duct length, and 5) reducing 90° elbows or replacing them with 45° elbows.



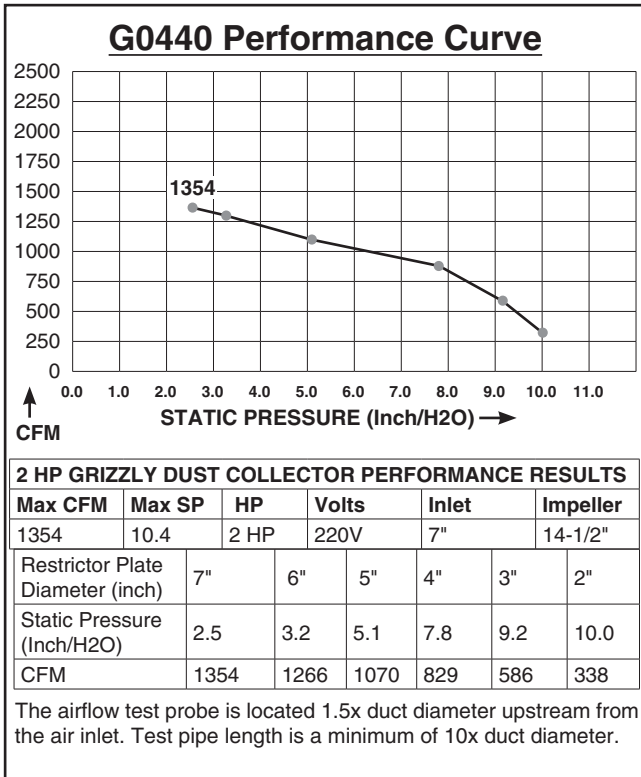

Figure 50. G0440 performance curve chart and data.

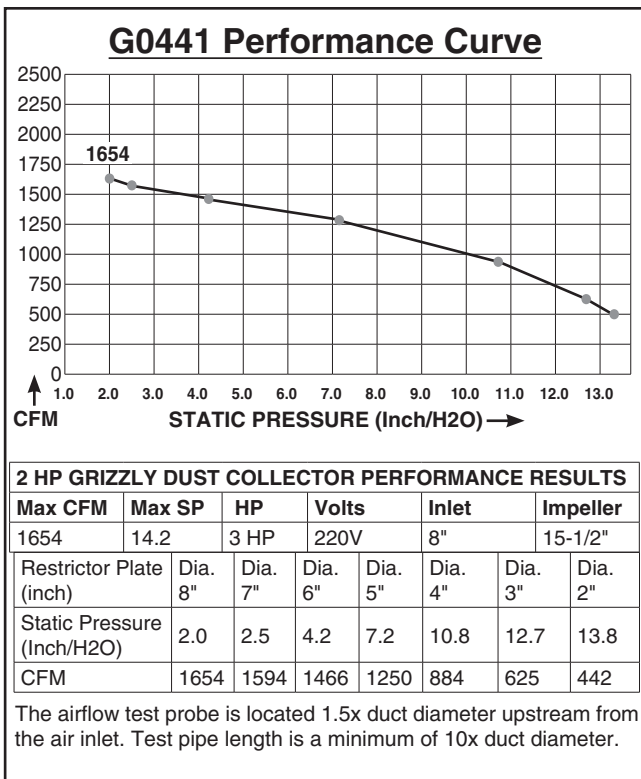

Figure 51. G0441 performance curve chart and data.

Example Materials List

After the system is designed, create a materials list of all the items you will need to build your dust collection system. This will make it easy when it comes time to purchase the materials.

Below is an example of some items that might be needed. Refer to **Accessories** for dust collection components available through *grizzly.com*.

Description	Model	Quantity
6" Rigid Pipe at 20'	G7364	4
4" Rigid Pipe at 10'	G6162	2
4" Flex Hose at 5'	H7215	6
6" 45° Y-Branch	G7353	6
4" 45° Elbow	G6167	6



System Grounding

Since plastic hose is abundant, relatively inexpensive, easily assembled and air tight, it is a very popular material for conveying dust from woodworking machines to the dust collector. We recommend using flexible hose (flex-hose) to connect the woodworking machine to the dust collector. However, plastic flex-hose and plastic duct are an insulator, and dust particles moving against the walls of the plastic duct create a static electrical build up. This charge will build until it discharges to a ground. If a grounding medium is not available to prevent static electrical build up, the electrical charge will arc to the nearest grounded source. This electrical discharge may cause an explosion and subsequent fire inside the system.

To protect against static electrical build up inside a non-conducting duct, a bare copper wire should be placed inside the duct along its length and grounded to the dust collector. You must also confirm that the dust collector is continuously grounded through the electrical circuit to the electric service panel.

If you connect the dust collector to more than one machine by way of a non-conducting branching duct system and blast gates, the system must still be grounded as mentioned above. We recommend inserting a continuous bare copper ground wire inside the entire duct system and attaching the wire to each grounded woodworking machine and dust collector.

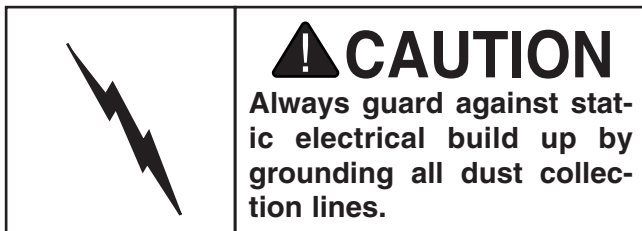

Be sure that you extend the bare copper wire down all branches of the system. Do not forget to connect the wires to each other with wire nuts when two branches meet at a “Y” or “T” connection.

Ensure that the entire system is grounded. If using plastic blast gates to direct air flow, the grounding wire must be jumped (see the **Figure** below) around the blast gate without interruption to the grounding system.

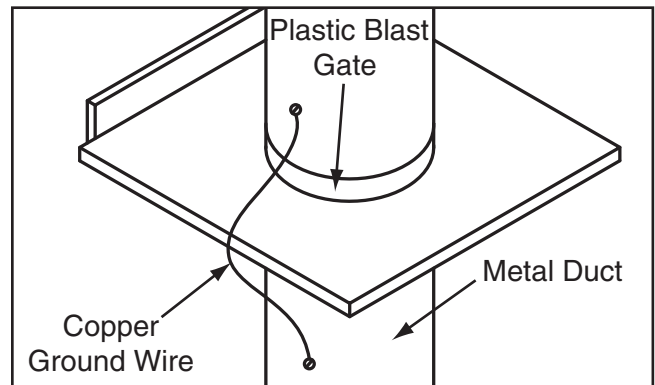

Figure 52. Ground jumper wire when using plastic blast gates and metal duct.

We also recommend wrapping the outside of all plastic ducts with bare copper wire to ground the outside of the system against static electrical build up. Wire connections at Y's and T's should be made with wire nuts.

Attach the bare ground wire to each stationary woodworking machine and attach to the dust collector frame with a ground screw as shown in the **Figure** below. Ensure that each machine is continuously grounded to the grounding terminal in your electric service panel.

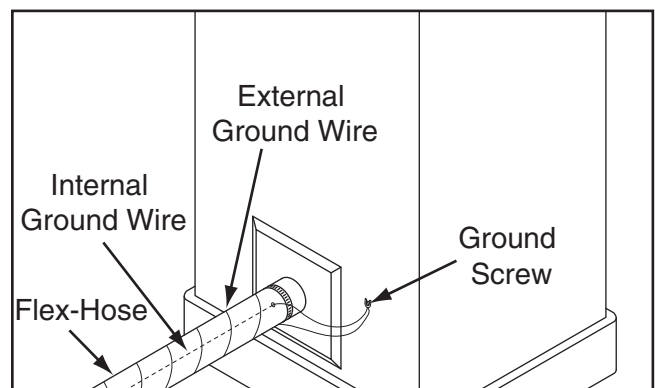
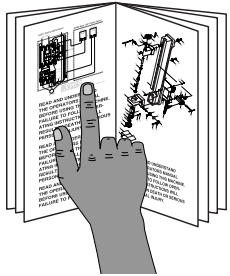

Figure 53. Flex-hose grounded to machine.



SECTION 5: OPERATIONS



!WARNING
To reduce the risk of serious injury when using this machine, read and understand this entire manual before beginning any operations.

!WARNING
Damage to your eyes, lungs, and ears could result from using this machine without proper protective gear. Always wear safety glasses, a respirator, and hearing protection when operating this machine.

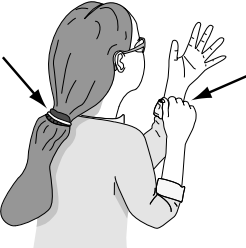

!WARNING
Loose hair, clothing, or jewelry could get caught in machinery and cause serious personal injury. Keep these items away from moving parts at all times to reduce this risk.

NOTICE
If you have never used this type of machine or equipment before, WE STRONGLY RECOMMEND that you read books, trade magazines, or get formal training before beginning any projects. Regardless of the content in this section, Grizzly Industrial will not be held liable for accidents caused by lack of training.

Remote Control

The remote control for the Model G0440/G0441 is IR (infrared) rather than RF (radio frequency) to prevent accidental startups by other common RF items, such as garage door openers.

Because this remote system is IR, you must point the remote control directly at the switch to make it operate.

If you plan on placing your dust collector in a different room or outside of your shop, you must mount the switch in the shop and wire it through the wall to the dust collector to make use of the remote control.

General

Operating the Model G0440/G0441 is simple and straightforward. Turn the dust collector **ON**, then turn the machine **ON**. When you are finished with the machine operation, turn the machine **OFF**, then turn the dust collector **OFF**.

Blast gates can be used at the start of each branch line to control the air flow from the woodworking machine to the dust collector. If a machine is not being used, keep the blast gate closed to maintain higher levels of efficiency throughout the system.



SECTION 6: ACCESSORIES

⚠️ WARNING

Some aftermarket accessories can be installed on this machine that could cause it to function improperly, increasing the risk of serious personal injury. To minimize this risk, only install accessories recommended for this machine by Grizzly.

NOTICE

Refer to the newest copy of the Grizzly Catalog for other accessories available for this machine.

Call 1-800-523-4777 To Order

H7499—Stand for G0440

H7509—Stand for G0441

Mounting your dust collector to a stand expands your layout options, and helps protect the dust collector from getting banged up. Also greatly decreases overall noise and vibration that is an inherent part of wall mounting.



Figure 54. Cyclone mounted on stand.

H5294—4" Metal Duct Machine Addition Kit

H5296—5" Metal Duct Machine Addition Kit

H5298—6" Metal Duct Machine Addition Kit

Save over 20% with this great machine addition kit. Includes: (2) blast gates, (1) machine adapter, (10) pipe clamps, (2) pipe hangers, (2) 5' straight pipes, (2) adjustable nipples, (1) branch, and (1) 60° elbow.

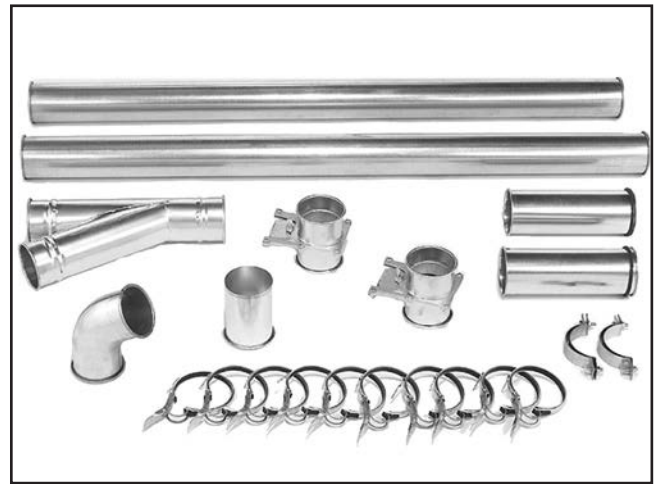

Figure 55. Metal Duct Machine Addition Kit.

H7215—4" x 5' Rigid Metal Flex Hose

H7216—5" x 5' Rigid Metal Flex Hose

H7217—6" x 5' Rigid Metal Flex Hose

H7218—7" x 5' Rigid Metal Flex Hose

H7219—8" x 5' Rigid Metal Flex Hose

This flex hose provides just enough flexibility to make difficult connections while still keeping the inside wall as smooth as possible to minimize static pressure loss.

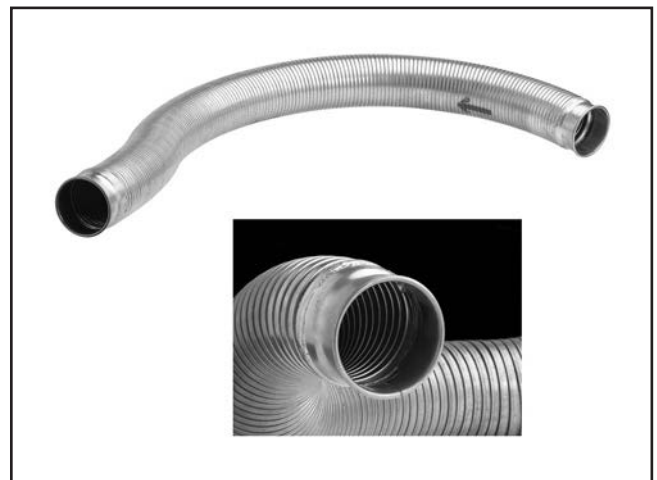

Figure 56. Rigid Metal Flex Hose.



- G6163—4" Clamp**
- G7343—5" Clamp**
- G7361—6" Clamp**
- H5228—7" Clamp**
- H5238—8" Clamp**
- H5253—9" Clamp**

These clamps feature lever latches and foam seals, and secure around the rolled ends of fittings and pipe.



Figure 57. Dust collection pipe clamps.

- G2752—4" Rolling Floor Sweep**
- G2753—4" Bench Dust Collection Attachment**
- G2754—4" Floor Dust Collection Attachment**

These attachments are indispensable for collecting dust at machines without a port. The rolling floor sweep is also a convenient way to keep the shop floor or workbench top clean! Designed for use with 4" flexible hose (not included).



Figure 58. Dust collection attachments.

W1039—Universal Adapter

This seven step adapter provides a multitude of dust collection reducing options. Simply cut away unneeded steps with a hacksaw. Outside diameter step sizes include 1", 2", 2.5", 3", 4", 5", and 6". Wall thickness is 1/8".

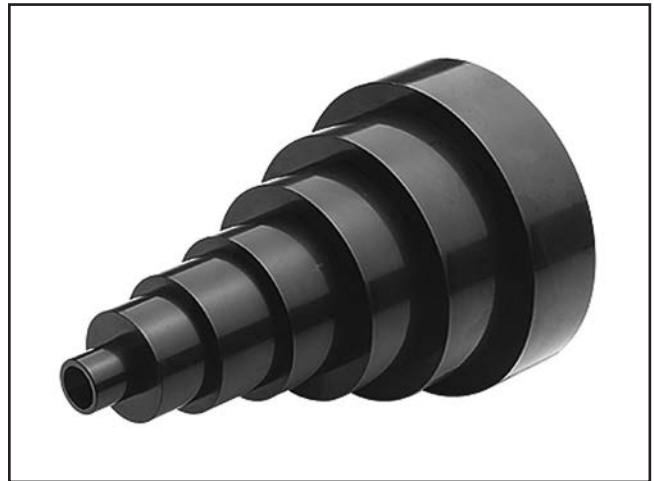

Figure 59. W1039 Universal Adapter.

G0572—Hanging Air Cleaner w/Remote

Unfortunately, not even the best dust collection systems get all the dust. This is why it is extremely important to have one or two air cleaners to claim the fine dust suspended in the air. This model features a convenient remote control, three speeds, an automatic shutoff timer, and a 2-stage filter system (5 micron outer and 1 micron inner). Easily the best value in its class!

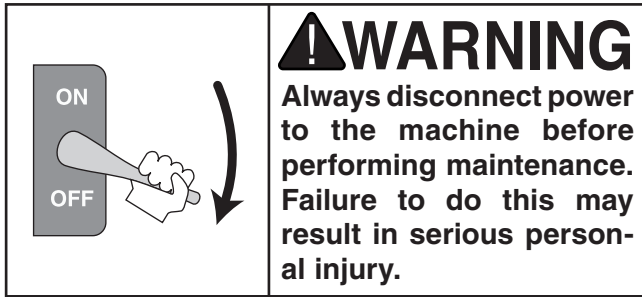

Figure 60. G0572 Hanging Air Cleaner.

Call 1-800-523-4777 To Order



SECTION 7: MAINTENANCE



Emptying Drum

Empty the collection drum when it is no more than $\frac{3}{4}$ full. If the drum is overfilled, dust will be sucked into the inlet cylinder and pass through to the filter.

How quickly the drum fills up is based on the type of work being done at that time.

A machine that produces fine dust, such as a sander or table saw, will slowly fill the drum.

A machine that produces curly shavings, such as a planer or jointer, will quickly fill the drum.

Until you are familiar with long it takes the cyclone to fill the drum, check it regularly to get an idea of how often it needs to be emptied.

Cleaning Filter

Your new cyclone dust collector has a gentle brush system inside the filter for cleaning. This brush system is controlled by the red and black handles shown in **Figure 61**.

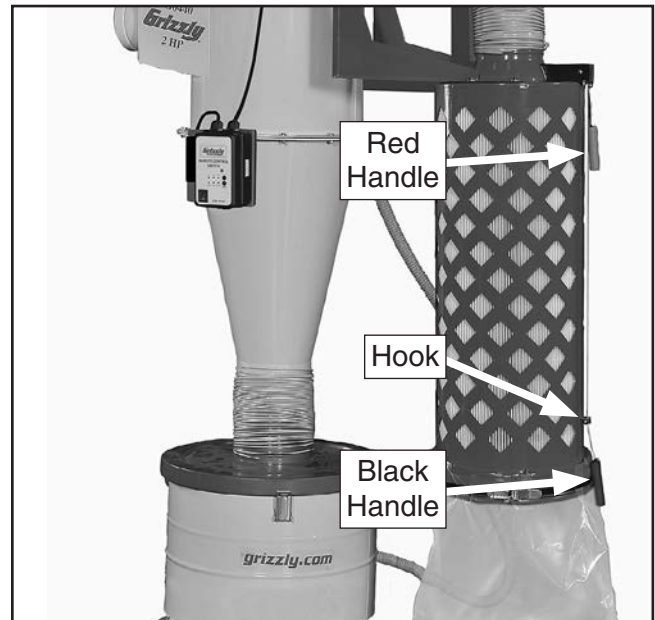

Figure 61. Brush handles for cleaning the filter.

To clean the filter, pull the red handle down all the way, then pull the black handle down and hook it in place.

Always make sure to leave the red handle in the up position to ensure that the brushes return to their proper position and do not restrict the filter.

Rinsing Filter

For a thorough cleaning, the filter can be removed and rinsed off. However, make sure to clean the filter with the brush system first. Allow the filter to air dry, but never leave the filter in the sun to dry or it could become damaged. Refer to **Removing/Replacing Filter** on the next page for detailed instructions in removing the canister filter.



Removing/Replacing Filter

The filter inside the canister assemblies can be removed from the assembly so that it can be replaced or rinsed off.

Removing/installing the filter requires removing the canister filter assembly from the dust collector and disassembling it. Follow the instructions below to perform this procedure.

When replacing the filter for the G0440 ask for part number **P0440032V2-4**. For the G0441, ask for part number **P04410032V2-4** from Grizzly at 800-523-4777.

Tools Needed	Qty
Open-End Wrench 10mm.....	1
Wrench or Socket 12mm.....	2

To replace the canister filter:

1. DISCONNECT MACHINE FROM POWER!
2. Remove the bag clamp and collection bag from the canister assembly.
3. Pull the black handle all the way down and secure the cable into the handle hook at the bottom of the canister assembly, as shown in **Figure 62**, to hold it in place during the following steps.

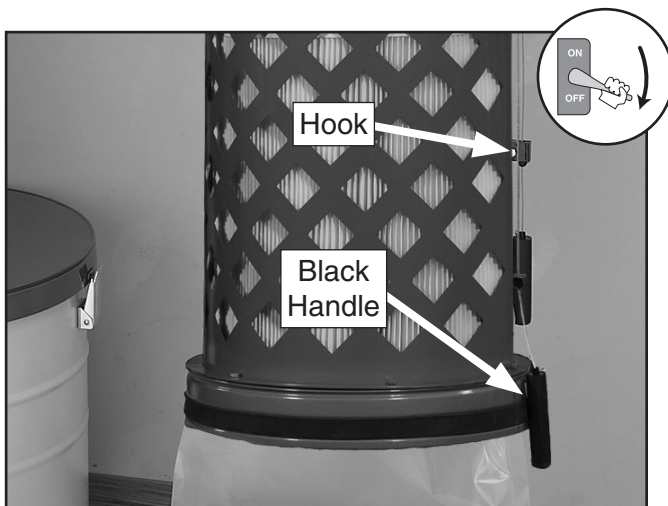

Figure 62. Black handle cable secured in the handle hook.

4. Remove the canister assembly from the dust collector and place it right-side up on a stable, flat surface.
5. Remove the six hex bolts, hex nuts, and flat washers from the rim of the canister base, as shown in **Figure 63**.

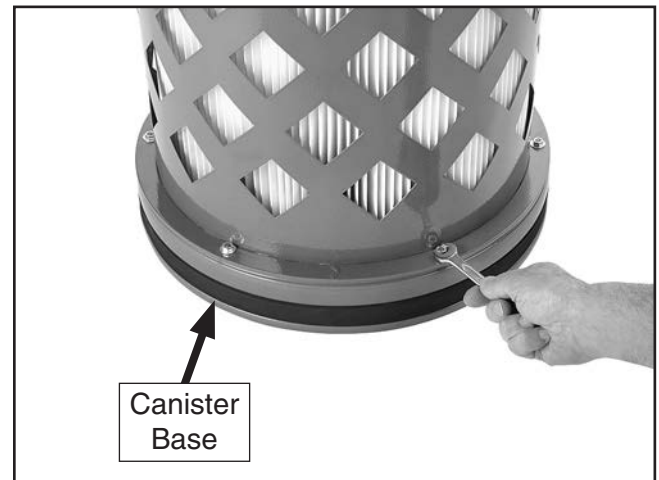

Figure 63. Removing the hex nuts and flat washers from the rim of the canister base.

6. With help from another person to steady the canister assembly, turn it upside down and remove the two hex bolts, hex nuts, and flat washers from the cross support (see **Figure 64**), then remove the canister base from the assembly.



Figure 64. Cross support fasteners.



7. Carefully lift the filter out of the canister assembly, as shown in **Figure 65**.



Figure 65. Removing the filter from the canister assembly.

8. Before re-inserting a filter into the assembly, make sure that the filter brush base is aligned with two of the fastener holes around the base of the assembly (see **Figure 66**). This will allow the canister base to align with the fastener holes around the brush base.



Figure 66. Filter brush base aligned with assembly fastener holes.

9. Re-insert a filter into the canister assembly.

Note: *Make sure the bristles of the brush are straight to ensure efficient cleaning of the filter when needed.*

10. Re-attach the canister base in the reverse order that you removed it.
11. Re-attach the canister assembly to the dust collector, then re-install a fresh collection bag with the bag clamp.



SECTION 8: SERVICE

Review the troubleshooting and procedures in this section to fix or adjust your machine if a problem develops. If you need replacement parts or you are unsure of your repair skills, then feel free to call our Technical Support at (570) 546-9663.

Troubleshooting

Symptom	Possible Cause	Possible Solution
Motor will not start, or it growls on start up.	<ol style="list-style-type: none"> 1. Power supply fuse or circuit breaker has tripped. 2. Toggle switch is broken inside. 3. Start capacitor is at fault. 4. Motor fan cover is dented. 5. Motor is at fault. 	<ol style="list-style-type: none"> 1. Disconnect power, and inspect circuit for electrical shorts and repair; replace circuit breaker 2. Disconnect power, and check/replace switch. 3. Replace start capacitor. 4. Replace motor fan cover (and fan, if damaged). 5. Replace motor.
Motor runs slower than normal.	<ol style="list-style-type: none"> 1. Poor electrical connection. 2. Low power source voltage. 3. Motor is at fault. 	<ol style="list-style-type: none"> 1. Inspect the power supply for loose, corroded, or overheated electrical connections and repair. 2. Have the power source voltage checked; reduce the length of extension cord. 3. Replace the motor.
Loud, repetitious noise, or excessive vibration coming from dust collector.	<ol style="list-style-type: none"> 1. Dust collector is not on a flat surface and wobbles. 2. Impeller fan is damaged and unbalanced. 3. The motor mounting is loose. 4. Impeller is loose on the motor shaft. 5. Motor fan cover is dented, causing the motor fan to hit the cover while spinning. 	<ol style="list-style-type: none"> 1. Stabilize the dust collector. 2. Unplug dust collector, and inspect the impeller for dents, bends, loose fins; replace. 3. Re-tighten all fasteners on the dust collector. 4. Replace the motor and impeller as a set if the motor shaft and the impeller hub is damaged. 5. Replace motor fan cover.
Dust collector does not adequately collect dust or chips; poor performance.	<ol style="list-style-type: none"> 1. Dust collection drum is full. 2. Filter is dirty. 3. Restriction in the duct line. 4. The dust collector is too far away from the point of suction, or there are too many sharp bends in the ducting. 5. The lumber is wet and not flowing through the dust lines smoothly. 6. There is a leak in the ducting, or a series of small leaks, or too many open ports. 7. There are not enough open branch lines at one time, thereby causing a velocity drop in the main line. 8. The ducting and ports are incorrectly sized. 9. The machine dust collection design is inadequate. 10. The dust collector is too small for the dust collection system. 	<ol style="list-style-type: none"> 1. Empty collection drum. 2. Clean filter. 3. Remove dust line from dust collector inlet and unblock the restriction in the duct line. A plumbing snake may be necessary. 4. Relocate the dust collector closer to the point of suction, and rework ducting without sharp bends. Refer to <i>System Design</i>, beginning on Page 27. 5. Process lumber with less than 20% moisture content. 6. Rework the ducting to eliminate all leaks. Close dust ports for lines not being used. Refer to <i>System Design</i> on Page 27 for more solutions. 7. Open 1 or 2 more blast gates to different branch lines to allow the velocity in the main line to increase. 8. Reinstall correctly sized ducts and fittings. Refer to <i>System Design</i> on Page 27 for more solutions. 9. Use a dust collection nozzle on a stand. 10. Install a larger dust collector to power your dust collection system.



SECTION 9: WIRING

These pages are current at the time of printing. However, in the spirit of improvement, we may make changes to the electrical systems of future machines. Study this section carefully. If there are differences between your machine and what is shown in this section, call Technical Support at (570) 546-9663 for assistance BEFORE making any changes to the wiring on your machine.

WARNING

Wiring Safety Instructions

SHOCK HAZARD. Working on wiring that is connected to a power source is extremely dangerous. Touching electrified parts will result in personal injury including but not limited to severe burns, electrocution, or death. Disconnect the power from the machine before servicing electrical components!

MODIFICATIONS. Modifying the wiring beyond what is shown in the diagram may lead to unpredictable results, including serious injury or fire. This includes the installation of unapproved aftermarket parts.

WIRE CONNECTIONS. All connections must be tight to prevent wires from loosening during machine operation. Double-check all wires disconnected or connected during any wiring task to ensure tight connections.

CIRCUIT REQUIREMENTS. You MUST follow the requirements at the beginning of this manual when connecting your machine to a power source.

WIRE/COMPONENT DAMAGE. Damaged wires or components increase the risk of serious personal injury, fire, or machine damage. If you notice that any wires or components are damaged while performing a wiring task, replace those wires or components.

MOTOR WIRING. The motor wiring shown in these diagrams is current at the time of printing but may not match your machine. If you find this to be the case, use the wiring diagram inside the motor junction box.















CAPACITORS/INVERTERS. Some capacitors and power inverters store an electrical charge for up to 10 minutes after being disconnected from the power source. To reduce the risk of being shocked, wait at least this long before working on capacitors.

EXPERIENCING DIFFICULTIES. If you are experiencing difficulties understanding the information included in this section, contact our Technical Support at (570) 546-9663.

NOTICE

The photos and diagrams included in this section are best viewed in color. You can view these pages in color at www.grizzly.com.

COLOR KEY

BLACK 	BLUE 	YELLOW 	LIGHT BLUE 
WHITE 	BROWN 	YELLOW GREEN 	BLUE WHITE 
GREEN 	GRAY 	PURPLE 	TURQUOISE 
RED 	ORANGE 	PINK 	



G0440 Wiring Diagram

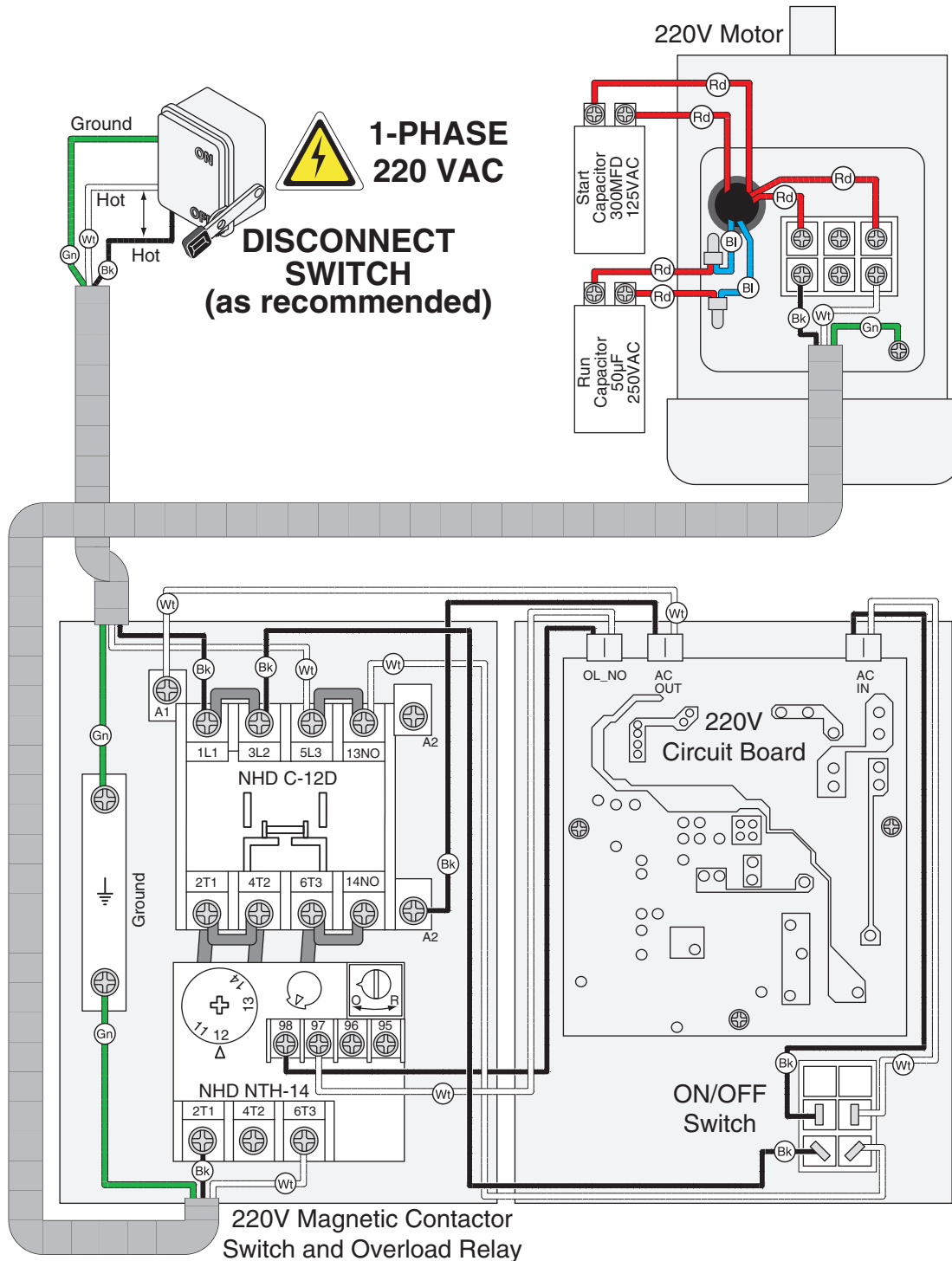

G0441 Wiring Diagram

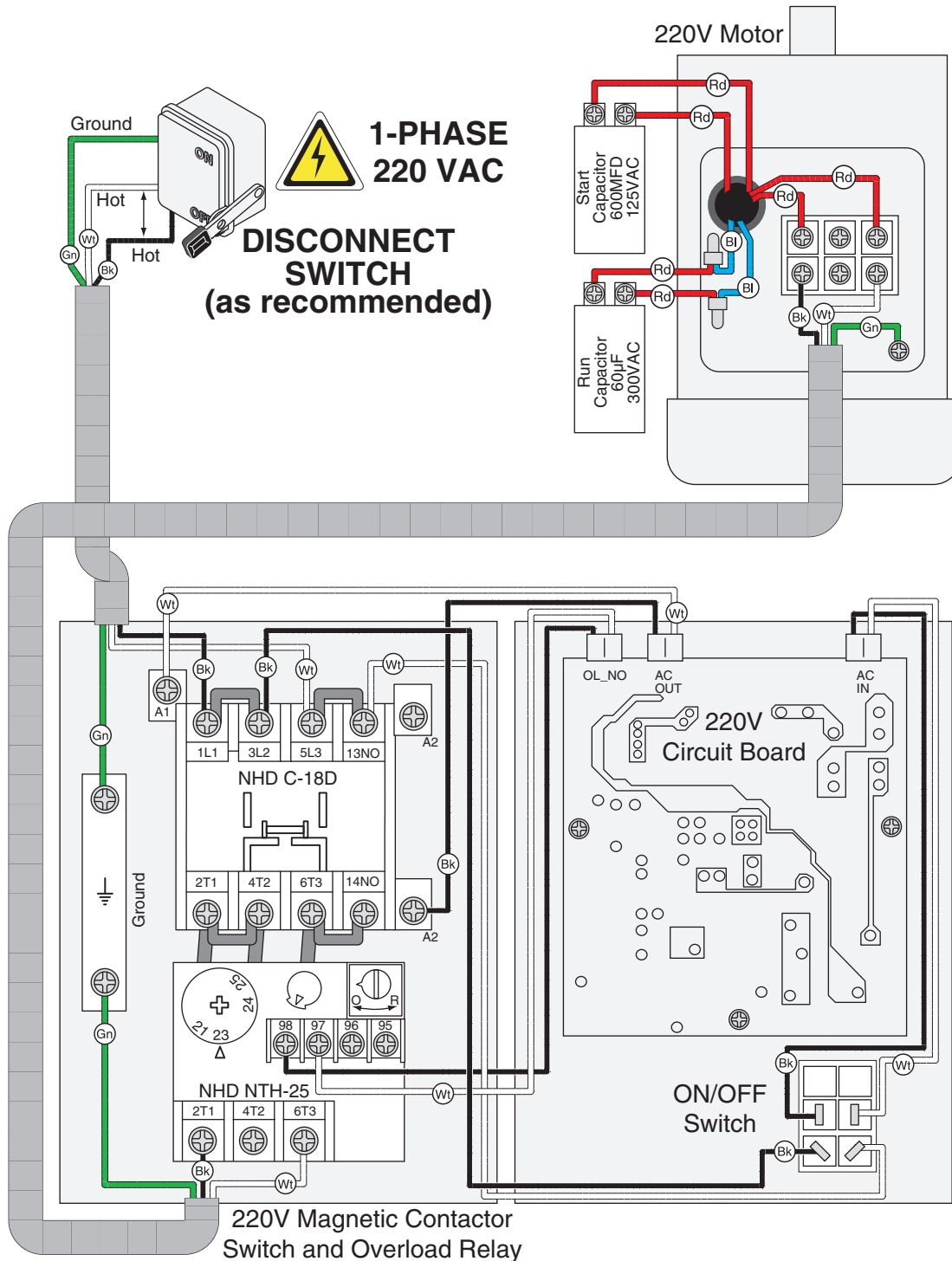

G0440/G0441 Electrical Components

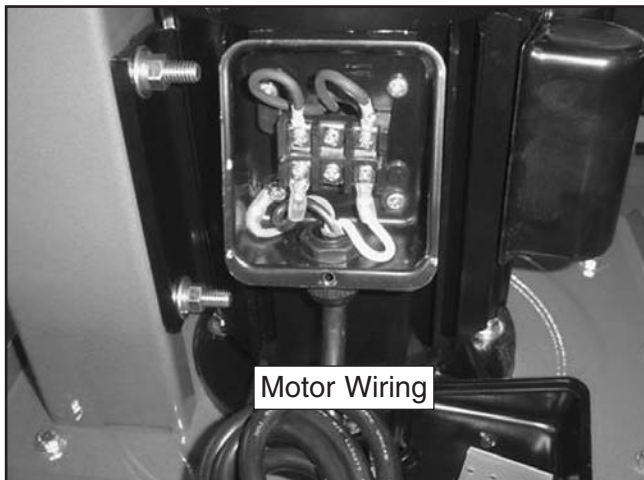

Figure 67. Motor wiring.

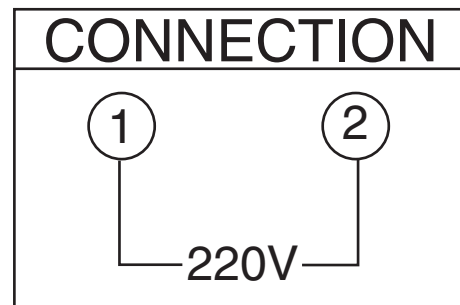

Figure 68. Motor wiring schematic.

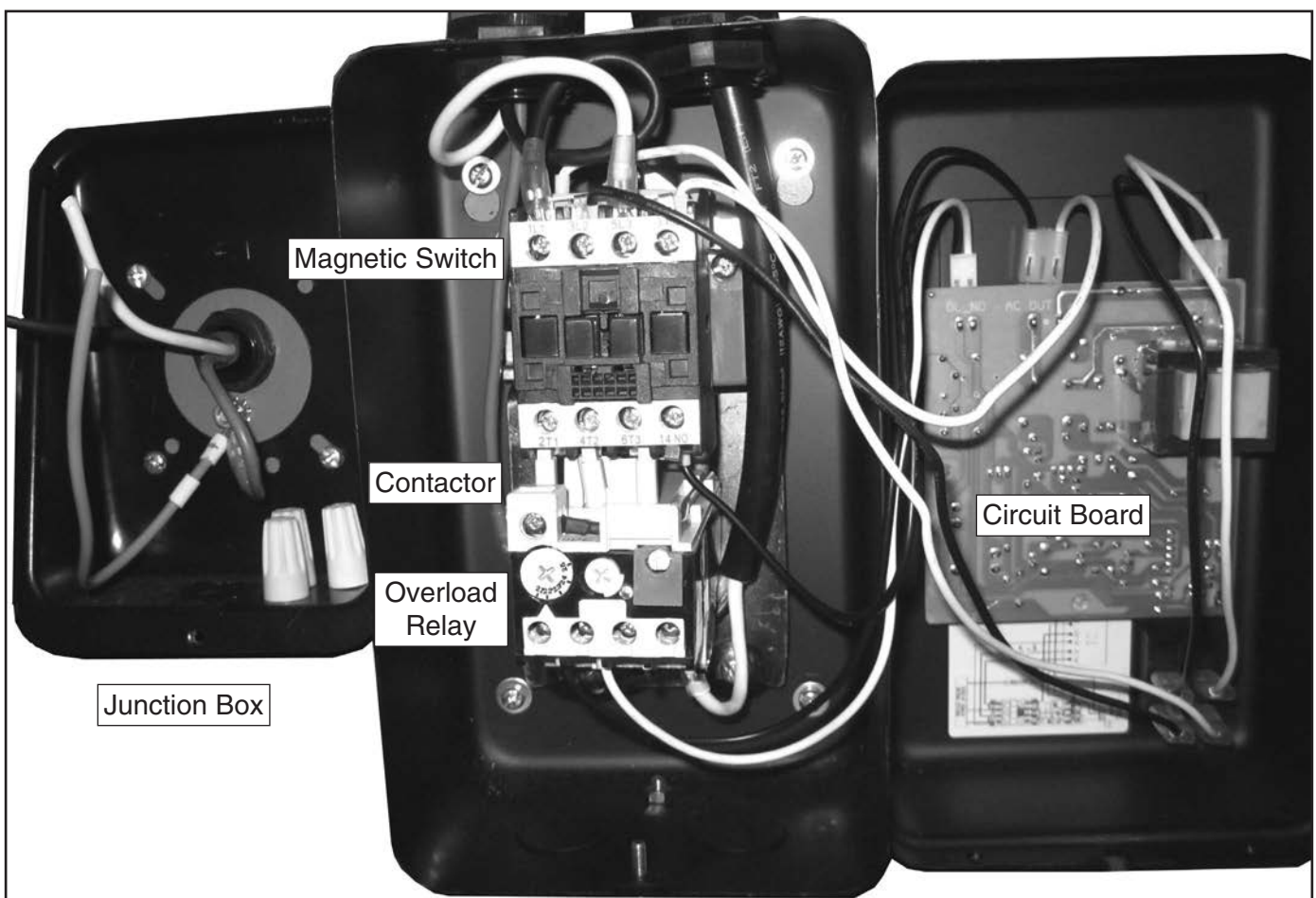
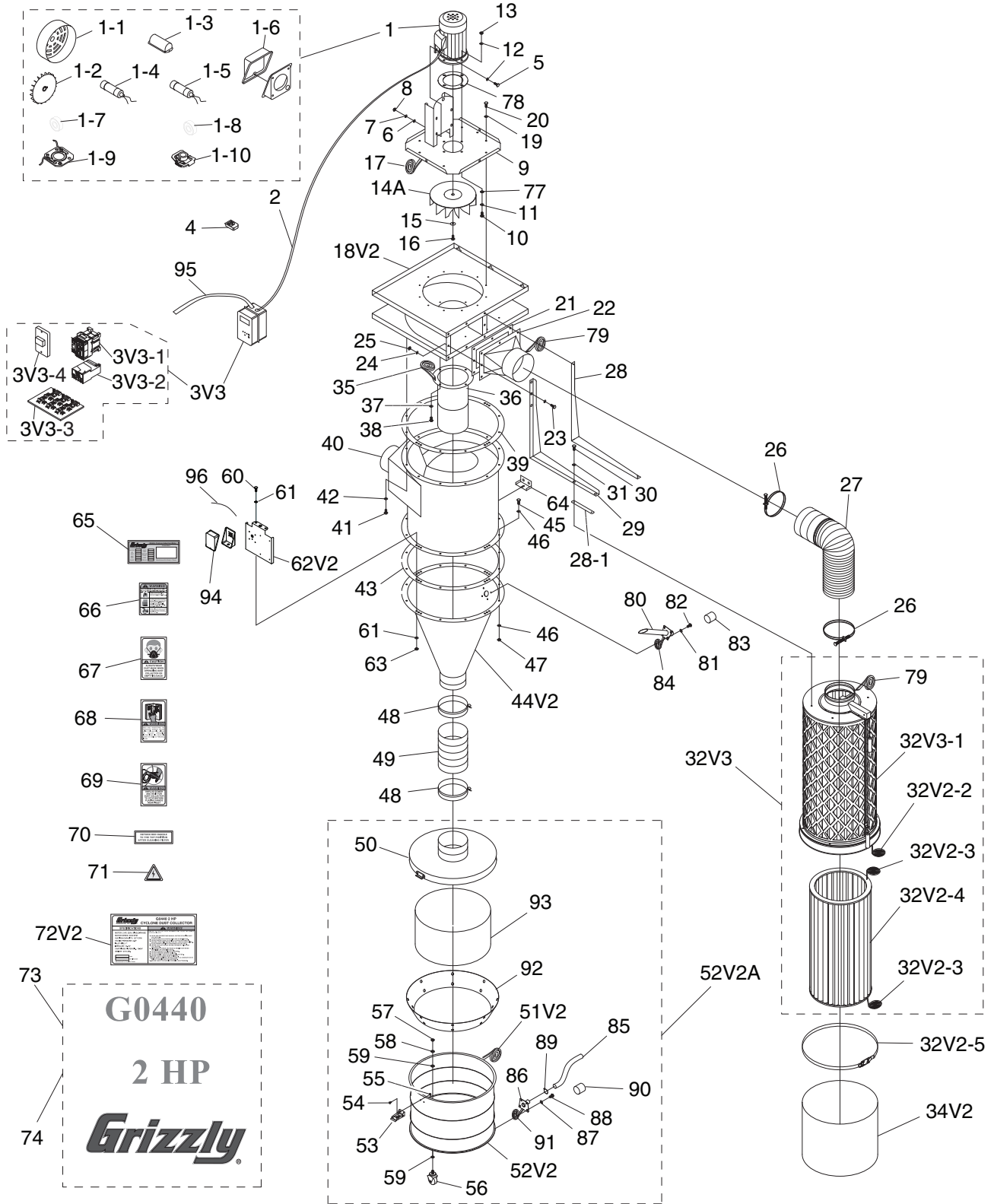

Figure 69. G0441 magnetic switch assembly.



SECTION 10: PARTS

G0440 Main



G0440 Parts List

REF	PART #	DESCRIPTION
1	P0440001	MOTOR 2HP 220V 1-PH
1-1	P0440001-1	MOTOR FAN COVER
1-2	P0440001-2	MOTOR FAN
1-3	P0440001-3	CAPACITOR COVER
1-4	P0440001-4	S CAPACITOR 300M 125V 1-3/4 X 3-3/8
1-5	P0440001-5	R CAPACITOR 50M 250V 1-5/8 X 3-1/2
1-6	P0440001-6	JUNCTION BOX
1-7	P0440001-7	BALL BEARING 6205ZZ
1-8	P0440001-8	BALL BEARING 6203ZZ
1-9	P0440001-9	CONTACT PLATE
1-10	P0440001-10	CENTRIFUGAL SWITCH 3450
2	P0440002	MOTOR CORD 12G 3C
3V3	P0440003V3	REMOTE MAG SWITCH 220V V3.01.12
3V3-1	P0440003V3-1	CONTACTOR NHD C-12D 220V
3V3-2	P0440003V3-2	OL RELAY NHD NTH-14 11-14A
3V3-3	P0440003V3-3	CIRCUIT BOARD 220V W/TRANSFORMER
3V3-4	P0440003V3-4	ON/OFF SWITCH 110V/220V
4	P0440004	REMOTE CONTROLLER
5	P0440005	HEX BOLT 3/8-16 X 1-1/2
6	P0440006	FLAT WASHER 3/8
7	P0440007	LOCK WASHER 3/8
8	P0440008	HEX NUT 3/8-16
9	P0440009	BLOWER COVER
10	P0440010	HEX BOLT 3/8-16 X 1
11	P0440011	FENDER WASHER 3/8
12	P0440012	LOCK WASHER 3/8
13	P0440013	HEX NUT 3/8-16
14A	P0440014A	IMPELLER 14-1/2" V2.02.06
15	P0440015	IMPELLER FENDER WASHER 3/8
16	P0440016	HEX BOLT 3/8-16 X 1 LH
17	P0440017	FOAM TAPE 3 X 6 X 1600MM
18V2	P0440018V2	BLOWER HOUSING 14.5" IMP V2.02.06
19	P0440019	FLAT WASHER 5/16
20	P0440020	HEX BOLT 5/16-18 X 3/4
21	P0440021	OUTLET GASKET 306 X 226MM
22	P0440022	OUTLET PORT
23	P0440023	HEX BOLT 5/16-18 X 1
24	P0440024	FLAT WASHER 5/16
25	P0440025	HEX NUT 5/16-18
26	P0440026	HOSE CLAMP 7"
27	P0440027	GRAY FLEX PIPE 7" X 800MM
28	P0440028	FILTER L-BRACE (LH)
28-1	P0440028-1	BRACE GASKET 155 X 37MM
29	P0440029	FILTER L-BRACE (RH)
30	P0440030	HEX BOLT 5/16-18 X 3/4
31	P0440031	FLAT WASHER 5/16
32V3	P0440032V3	CANISTER ASSEMBLY (BEIGE) V3.07.12
32V3-1	P0440032V3-1	CANISTER CAGE ASSY (BEIGE) V3.07.12
32V2-2	P0440032V2-2	FOAM TAPE 3 X 25 X 1400MM V2.11.09
32V2-3	P0440032V2-3	FOAM TAPE 3 X 35 X 1255MM V2.11.09
32V2-4	P0440032V2-4	CAN FILTER 386MM W/FOAM TAPE V2.11.09
32V2-5	P0440032V2-5	BAG CLAMP 445MM V2.11.09
34V2	P0440034V2	PLASTIC BAG 470 X 600MM V2.11.09
35	P0440035	FOAM TAPE 3 X 6 X 1600MM
36	P0440036	INTAKE CYLINDER 10"
37	P0440037	FLAT WASHER 5/16
38	P0440038	HEX BOLT 5/16-18 X 3/4

REF	PART #	DESCRIPTION
39	P0440039	BARREL GASKET 584MM DIA.
40	P0440040	INTAKE BARREL 20"
41	P0440041	HEX BOLT 5/16-18 X 3/4
42	P0440042	FLAT WASHER 5/16
43	P0440043	BARREL GASKET 584MM DIA.
44V2	P0440044V2	CYCLONE FUNNEL 20" V2.08.10
45	P0440045	HEX BOLT 5/16-18 X 1
46	P0440046	FLAT WASHER 5/16
47	P0440047	HEX NUT 5/16-18
48	P0440048	HOSE CLAMP 9"
49	P0440049	CLEAR FLEX PIPE 9" x 200MM
50	P0440050	COLLECTION DRUM LID V2.08.06
51V2	P0440051V2	DRUM SEAL TYPE-T 2.1M V2.11.09
52V2A	P0440052V2A	COLLECTION DRUM ASSY 35GAL V2.08.10
52V2	P0440052V2	COLLECTION DRUM 35GAL V2.08.10
53	P0440053	DRUM LID LATCH ASSEMBLY
54	P0440054	PHLP HD SCR 10-24 X 3/8
55	P0440055	HEX NUT 10-24
56	P0440056	CASTER 2"
57	P0440057	HEX NUT 3/8-16
58	P0440058	LOCK WASHER 3/8
59	P0440059	FLAT WASHER 3/8
60	P0440060	HEX BOLT 5/16-18 X 1
61	P0440061	FLAT WASHER 5/16
62V2	P0440062V2	SWITCH MOUNTING BRACKET V2.01.12
63	P0440063	HEX NUT 5/16-18
64	P0440064	WALL MOUNTING BRACE
65	P0440065	MOTOR SPEC LABEL
66	P0440066	MOTOR WARNING LABEL
67	P0440067	GLASSES/RESPIRATOR LABEL
68	P0440068	READ MANUAL LABEL
69	P0440069	HANDS/INLET LABEL
70	P0440070	RETURN RED HANDLE LABEL
71	P0440071	ELECTRICITY LABEL
72V2	P0440072V2	MACHINE ID LABEL CSA V2.01.12
73	P0440073	MODEL NO/HP/GRIZZLY LABEL (LARGE)
74	P0440074	MODEL NO/HP/GRIZZLY LABEL (SMALL)
77	P0440077	EXT TOOTH WASHER 3/8
78	P0440078	MOTOR MOUNT GASKET
79	P0440079	FOAM TAPE 3 X 15 X 600MM
80	P0440080	CYCLONE VACUUM TUBE
81	P0440081	FLAT WASHER 5/16
82	P0440082	HEX BOLT 5/16-18 X 3/4
83	P0440083	TUBE PLUG 1-1/4"
84	P0440084	FOAM TAPE 3 X 6 X 300MM
85	P0440085	VACUUM HOSE 1-1/4" X 98"
86	P0440086	COLLECTION DRUM VACUUM TUBE
87	P0440087	FLAT WASHER 5/16
88	P0440088	HEX BOLT 5/16-18 X 3/4
89	P0440089	HOSE CLAMP 1-1/4"
90	P0440090	TUBE PLUG 1-1/4"
91	P0440091	FOAM TAPE 3 X 6 X 300MM
92	P0440092	COLLECTION DRUM VACUUM RING
93	P0440093	DRUM COLLECTION BAG 640 X 1000MM
94	P0440094	JUNCTION BOX
95	P0440095	JUNCTION BOX CORD 12G 3C 12"
96	P0440096	GROUNDING WIRE 12G 6" (GREEN)



G0441 Main

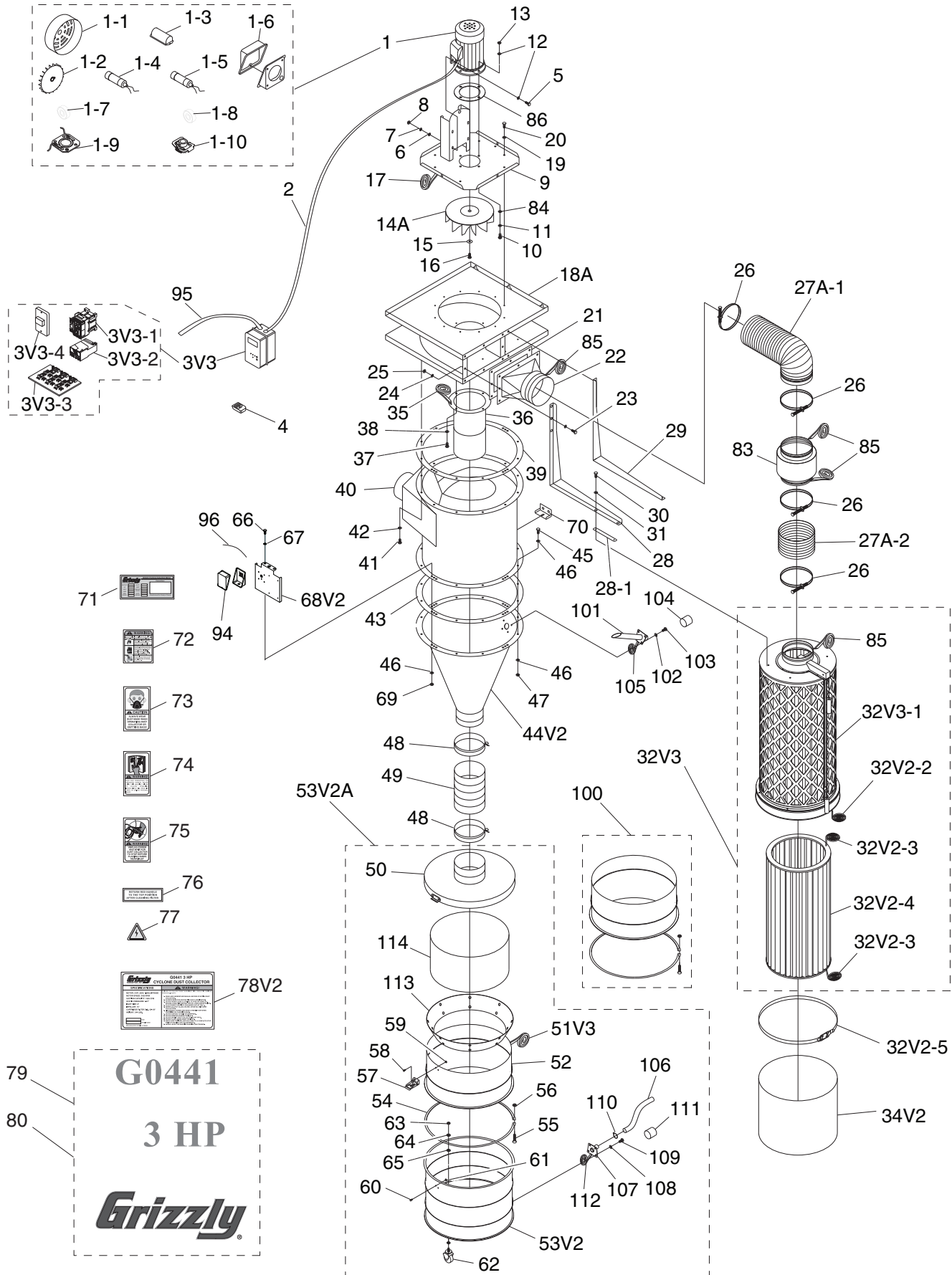

G0441 Parts List

REF	PART #	DESCRIPTION
1	P0441001	MOTOR 3HP 220V 1-PH
1-1	P0441001-1	MOTOR FAN COVER
1-2	P0441001-2	MOTOR FAN
1-3	P0441001-3	CAPACITOR COVER
1-4	P0441001-4	S CAPACITOR 600M 125V 1-3/4 X 3-3/4
1-5	P0441001-5	R CAPACITOR 60M 300V 1-5/8 X 3-1/2
1-6	P0441001-6	JUNCTION BOX
1-7	P0441001-7	BALL BEARING 6205ZZ
1-8	P0441001-8	BALL BEARING 6203ZZ
1-9	P0441001-9	CONTACT PLATE
1-10	P0441001-10	CENTRIFUGAL SWITCH 3450
2	P0441002	MOTOR CORD 12G 3C
3V3	P0441003V3	REMOTE MAG SWITCH 220V V3.01.12
3V3-1	P0440003V3-1	CONTACTOR NHD C-18D 220V
3V3-2	P0440003V3-2	OL RELAY NHD NTH-25 21-25A
3V3-3	P0440003V3-3	CIRCUIT BOARD 220V W/TRANSFORMER
3V3-4	P0440003V3-4	ON/OFF SWITCH 110/220V
4	P0441004	REMOTE CONTROLLER
5	P0441005	HEX BOLT 3/8-16 X 1-1/2
6	P0441006	FLAT WASHER 3/8
7	P0441007	LOCK WASHER 3/8
8	P0441008	HEX NUT 3/8-16
9	P0441009	BLOWER COVER
10	P0441010	HEX BOLT 3/8-16 X 1-1/2
11	P0441011	FLAT WASHER 3/8
12	P0441012	LOCK WASHER 3/8
13	P0441013	HEX NUT 3/8-16
14A	P0441014A	IMPELLER 15-1/2" V2.02.06
15	P0441015	IMPELLER FENDER WASHER 3/8
16	P0441016	HEX BOLT 3/8-16 X 1 LH
17	P0441017	FOAM TAPE 3 X 6 X 1600MM
18A	P0441018A	BLOWER HOUSING 15-1/2" IMP V2.02.06
19	P0441019	FLAT WASHER 5/16
20	P0441020	HEX BOLT 5/16-18 X 3/4
21	P0441021	OUTLET GASKET 326 X 226MM
22	P0441022	OUTLET PORT
23	P0441023	HEX BOLT 5/16-18 X 1
24	P0441024	FLAT WASHER 5/16
25	P0441025	HEX NUT 5/16-18
26	P0441026	HOSE CLAMP 8"
27A-1	P0441027A-1	GREY FLEX PIPE 8" X 500MM V2.04.08
27A-2	P0441027A-2	GREY FLEX PIPE 8" X 120MM V2.04.08
28	P0441028	FILTER L-BRACE (RH)
28-1	P0441028-1	BRACE GASKET 240 X 32MM
29	P0441029	FILTER L-BRACE (LH)
30	P0441030	HEX BOLT 5/16-18 X 3/4
31	P0441031	FLAT WASHER 5/16
32V3	P0441032V3	CANISTER ASSEMBLY (BEIGE) V3.07.12
32V3-1	P0441032V3-1	CANISTER CAGE ASSY (BEIGE) V3.07.12
32V2-2	P0441032V2-2	FOAM TAPE 3 X 25 X 1400MM V2.11.09
32V2-3	P0441032V2-3	FOAM TAPE 38 X 35 X 1460MM V2.11.09
32V2-4	P0441032V2-4	CANISTER FILTER 486MM V2.11.09
32V2-5	P0441032V2-5	BAG CLAMP 545MM V2.11.09
34V2	P0441034V2	PLASTIC BAG 570 X 600MM V2.11.09
35	P0441035	FOAM TAPE 3 X 6 X 1600MM
36	P0441036	INTAKE CYCLINDER 10"
37	P0441037	HEX BOLT 5/16-18 X 3/4
38	P0441038	FLAT WASHER 5/16
39	P0441039	BARREL GASKET 584MM DIA.
40	P0441040	INTAKE BARREL 20"
41	P0441041	HEX BOLT 5/16-18 X 3/4
42	P0441042	FLAT WASHER 5/16

REF	PART #	DESCRIPTION
43	P0441043	BARREL GASKET 584MM DIA.
44V2	P0441044V2	CYCLONE FUNNEL 20" V2.08.10
45	P0441045	HEX BOLT 5/16-18 X 1
46	P0441046	FLAT WASHER 5/16
47	P0441047	HEX NUT 5/16-18
48	P0441048	HOSE CLAMP 9"
49	P0441049	CLEAR FLEX PIPE 9" X 340MM
50	P0441050	COLLECTION DRUM LID V2.08.06
51V3	P0441051V3	DRUM SEAL TYPE-R 2M V3.01.12
52	P0441052	UPPER DRUM 25GAL
53V2A	P0441053V2A	COLLECTION DRUM ASSY 55GAL V2.11.09
53V2	P0441053V2	COLLECTION DRUM 35GAL V2.08.10
54	P0441054	DRUM CLAMP
55	P0441055	HEX BOLT 5/16-18 X 3
56	P0441056	HEX NUT 5/16-18
57	P0441057	DRUM LID LATCH ASSEMBLY
58	P0441058	PHLP HD SCR 10-24 X 3/8
59	P0441059	HEX NUT 10-24
60	P0441060	PHLP HD SCR 10-24 X 3/8
61	P0441061	HEX NUT 10-24
62	P0441062	CASTER 2"
63	P0441063	HEX NUT 3/8-16
64	P0441064	LOCK WASHER 3/8
65	P0441065	FLAT WASHER 3/8
66	P0441066	HEX BOLT 5/16-18 X 1
67	P0441067	FLAT WASHER 5/16
68V2	P0441068V2	SWITCH MOUNTING BRACKET V2.01.12
69	P0441069	HEX NUT 5/16-18
70	P0441070	WALL MOUNT BRACKET
71	P0441071	MOTOR SPEC LABEL
72	P0441072	MOTOR WARNING LABEL
73	P0441073	GLASSES/RESPIRATOR LABEL
74	P0441074	READ MANUAL LABEL
75	P0441075	HANDS/INLET LABEL
76	P0441076	RETURN RED HANDLE LABEL
77	P0441077	ELECTRICITY LABEL
78V2	P0441078V2	MACHINE ID LABEL CSA V2.01.12
79	P0441079	MODEL NO/HP/GRIZZLY LABEL (LARGE)
80	P0441080	MODEL NO/HP/GRIZZLY LABEL (SMALL)
83	P0441083	MUFFLER 8"
84	P0441084	EXT TOOTH WASHER 3/8
85	P0441085	FOAM TAPE 3 X 15 X 700MM
86	P0441086	MOTOR MOUNT GASKET
94	P0441094	JUNCTION BOX
95	P0441095	JUNCTION BOX CORD 12G 3C 12"
96	P0441096	GROUNDING WIRE 12G 6" (GREEN)
100	P0441100	COLLECTION DRUM EXT KIT
101	P0441101	CYCLONE VACUUM TUBE
102	P0441102	FLAT WASHER 5/16
103	P0441103	HEX BOLT 5/16-18 X 3/4
104	P0441104	TUBE PLUG 1-1/4"
105	P0441105	FOAM TAPE 3 X 6 X 300MM
106	P0441106	VACUUM HOSE 1-1/4" X 98"
107	P0441107	COLLECTION DRUM VACUUM TUBE
108	P0441108	FLAT WASHER 5/16
109	P0441109	HEX BOLT 5/16-18 X 3/4
110	P0441110	HOSE CLAMP 1-1/4"
111	P0441111	TUBE PLUG 1-1/4"
112	P0441112	FOAM TAPE 3 X 6 X 300MM
113	P0441113	COLLECTION DRUM VACUUM RING
114	P0441114	DRUM COLLECTION BAG 640 X 1200MM







WARRANTY CARD

Name _____
 Street _____
 City _____ State _____ Zip _____
 Phone # _____ Email _____
 Model # _____ Order # _____ Serial # _____

The following information is given on a voluntary basis. It will be used for marketing purposes to help us develop better products and services. **Of course, all information is strictly confidential.**

1. How did you learn about us?

Advertisement Friend Catalog
 Card Deck Website Other:

2. Which of the following magazines do you subscribe to?

<input type="checkbox"/> Cabinetmaker & FDM	<input type="checkbox"/> Popular Science	<input type="checkbox"/> Wooden Boat
<input type="checkbox"/> Family Handyman	<input type="checkbox"/> Popular Woodworking	<input type="checkbox"/> Woodshop News
<input type="checkbox"/> Hand Loader	<input type="checkbox"/> Precision Shooter	<input type="checkbox"/> Woodsmith
<input type="checkbox"/> Handy	<input type="checkbox"/> Projects in Metal	<input type="checkbox"/> Woodwork
<input type="checkbox"/> Home Shop Machinist	<input type="checkbox"/> RC Modeler	<input type="checkbox"/> Woodworker West
<input type="checkbox"/> Journal of Light Cont.	<input type="checkbox"/> Rifle	<input type="checkbox"/> Woodworker's Journal
<input type="checkbox"/> Live Steam	<input type="checkbox"/> Shop Notes	<input type="checkbox"/> Other:
<input type="checkbox"/> Model Airplane News	<input type="checkbox"/> Shotgun News	
<input type="checkbox"/> Old House Journal	<input type="checkbox"/> Today's Homeowner	
<input type="checkbox"/> Popular Mechanics	<input type="checkbox"/> Wood	

3. What is your annual household income?

\$20,000-\$29,000 \$30,000-\$39,000 \$40,000-\$49,000
 \$50,000-\$59,000 \$60,000-\$69,000 \$70,000+

4. What is your age group?

20-29 30-39 40-49
 50-59 60-69 70+

5. How long have you been a woodworker/metalworker?

0-2 Years 2-8 Years 8-20 Years 20+ Years

6. How many of your machines or tools are Grizzly?

0-2 3-5 6-9 10+

7. Do you think your machine represents a good value? Yes No

8. Would you recommend Grizzly Industrial to a friend? Yes No

9. Would you allow us to use your name as a reference for Grizzly customers in your area?
Note: We never use names more than 3 times. Yes No

10. Comments: _____

CUT ALONG DOTTED LINE

FOLD ALONG DOTTED LINE



Place
Stamp
Here



GRIZZLY INDUSTRIAL, INC.
P.O. BOX 2069
BELLINGHAM, WA 98227-2069



FOLD ALONG DOTTED LINE

Send a Grizzly Catalog to a friend:

Name _____
Street _____
City _____ State _____ Zip _____

TAPE ALONG EDGES--PLEASE DO NOT STAPLE

WARRANTY AND RETURNS

Grizzly Industrial, Inc. warrants every product it sells for a period of **1 year** to the original purchaser from the date of purchase. This warranty does not apply to defects due directly or indirectly to misuse, abuse, negligence, accidents, repairs or alterations or lack of maintenance. This is Grizzly's sole written warranty and any and all warranties that may be implied by law, including any merchantability or fitness, for any particular purpose, are hereby limited to the duration of this written warranty. We do not warrant or represent that the merchandise complies with the provisions of any law or acts unless the manufacturer so warrants. In no event shall Grizzly's liability under this warranty exceed the purchase price paid for the product and any legal actions brought against Grizzly shall be tried in the State of Washington, County of Whatcom.

We shall in no event be liable for death, injuries to persons or property or for incidental, contingent, special, or consequential damages arising from the use of our products.

To take advantage of this warranty, contact us by mail or phone and give us all the details. We will then issue you a "Return Number," which must be clearly posted on the outside as well as the inside of the carton. We will not accept any item back without this number. Proof of purchase must accompany the merchandise.

The manufacturers reserve the right to change specifications at any time because they constantly strive to achieve better quality equipment. We make every effort to ensure that our products meet high quality and durability standards and we hope you never need to use this warranty.

Please feel free to write or call us if you have any questions about the machine or the manual.

Thank you again for your business and continued support. We hope to serve you again soon.

grizzly.com[®]

TOOL WEBSITE

Buy Direct and Save with Grizzly[®] – Trusted, Proven and a Great Value!
~Since 1983~

*Visit Our Website Today For
Current Specials!*

**ORDER
24 HOURS A DAY!
1-800-523-4777**



Free Manuals Download Website

<http://myh66.com>

<http://usermanuals.us>

<http://www.somanuals.com>

<http://www.4manuals.cc>

<http://www.manual-lib.com>

<http://www.404manual.com>

<http://www.luxmanual.com>

<http://aubethermostatmanual.com>

Golf course search by state

<http://golfingnear.com>

Email search by domain

<http://emailbydomain.com>

Auto manuals search

<http://auto.somanuals.com>

TV manuals search

<http://tv.somanuals.com>