

# **Grizzly** **Industrial, Inc.**®

## **MODEL G0443** **1-1/2 HP CYCLONE** **DUST COLLECTOR** **OWNER'S MANUAL**

*(For models manufactured since 11/09)*



COPYRIGHT © MARCH, 2012 BY GRIZZLY INDUSTRIAL, INC.  
**WARNING: NO PORTION OF THIS MANUAL MAY BE REPRODUCED IN ANY SHAPE  
OR FORM WITHOUT THE WRITTEN APPROVAL OF GRIZZLY INDUSTRIAL, INC.**  
#KN14539 PRINTED IN TAIWAN

 **WARNING!**

**This manual provides critical safety instructions on the proper setup, operation, maintenance, and service of this machine/tool. Save this document, refer to it often, and use it to instruct other operators.**

**Failure to read, understand and follow the instructions in this manual may result in fire or serious personal injury—including amputation, electrocution, or death.**

**The owner of this machine/tool is solely responsible for its safe use. This responsibility includes but is not limited to proper installation in a safe environment, personnel training and usage authorization, proper inspection and maintenance, manual availability and comprehension, application of safety devices, cutting/sanding/grinding tool integrity, and the usage of personal protective equipment.**

**The manufacturer will not be held liable for injury or property damage from negligence, improper training, machine modifications or misuse.**

 **WARNING!**

**Some dust created by power sanding, sawing, grinding, drilling, and other construction activities contains chemicals known to the State of California to cause cancer, birth defects or other reproductive harm. Some examples of these chemicals are:**

- **Lead from lead-based paints.**
- **Crystalline silica from bricks, cement and other masonry products.**
- **Arsenic and chromium from chemically-treated lumber.**

**Your risk from these exposures varies, depending on how often you do this type of work. To reduce your exposure to these chemicals: Work in a well ventilated area, and work with approved safety equipment, such as those dust masks that are specially designed to filter out microscopic particles.**

# Table of Contents

<b>INTRODUCTION</b> .....	<b>2</b>	<b>SECTION 4: DESIGNING THE SYSTEM</b> .....	<b>24</b>
Manual Accuracy .....	2	General .....	24
Contact Info.....	2	Duct Material.....	24
Machine Description .....	2	Metal Duct .....	25
Identification.....	3	Flexible Duct.....	25
Machine Data Sheet .....	4	System Design.....	26
<b>SECTION 1: SAFETY</b> .....	<b>6</b>	Step 1. Decide Who Will Design .....	26
Safety Instructions for Machinery .....	6	Step 2. Sketch Your Shop Layout.....	26
Additional Safety for Dust Collectors .....	8	Step 3. Sketch a Basic Duct Layout.....	26
<b>SECTION 2: POWER SUPPLY</b> .....	<b>9</b>	Step 4. Determine Required CFM of Each	
Availability.....	9	Machine .....	27
Full-Load Current Rating .....	9	Determining Main Line Duct Size.....	28
Circuit Information .....	9	Determining Branch Line Duct Size .....	28
Circuit Requirements for 110V .....	9	Drop Downs.....	28
Circuit Requirements for 220V .....	9	Multiple Dust Ports .....	29
Grounding & Plug Requirements.....	10	Two Machines on Same Branch Line .....	29
Extension Cords .....	10	Calculating Duct Resistance .....	29
G0443 Conversion to 220V Operation .....	11	Example Materials List .....	31
<b>SECTION 3: SETUP</b> .....	<b>12</b>	System Grounding .....	32
Unpacking.....	12	<b>SECTION 5: OPERATIONS</b> .....	<b>33</b>
Needed for Setup.....	12	Remote Control.....	33
Inventory .....	13	General .....	33
Site Considerations.....	14	<b>SECTION 6: ACCESSORIES</b> .....	<b>34</b>
Wall Mounting .....	15	<b>SECTION 7: MAINTENANCE</b> .....	<b>36</b>
Materials Needed for Standard Wood		Emptying Drum .....	36
Framed Walls .....	15	Cleaning Filter.....	36
Materials Needed for Concrete/Masonry		Rinsing Filter.....	36
Wall.....	16	Removing/Replacing Filter.....	37
Assembly .....	17	<b>SECTION 8: SERVICE</b> .....	<b>39</b>
Power Connection.....	22	Troubleshooting .....	39
Power Connection .....	22	Motor & Electrical .....	39
Test Run .....	23	Operation.....	39
		Operation (continued).....	40
		<b>SECTION 9: WIRING</b> .....	<b>41</b>
		Wiring Safety Instructions.....	41
		110V (Prewired) Wiring Diagram.....	42
		220V (Rewired) Wiring Diagram.....	43
		<b>SECTION 10: PARTS</b> .....	<b>44</b>
		Main Parts List.....	45
		Labels .....	46
		<b>WARRANTY &amp; RETURNS</b> .....	<b>49</b>


# INTRODUCTION

## Manual Accuracy

We are proud to offer this manual with your new machine! We've made every effort to be exact with the instructions, specifications, drawings, and photographs of the machine we used when writing this manual. However, sometimes we still make an occasional mistake.

Also, owing to our policy of continuous improvement, **your machine may not exactly match the manual**. If you find this to be the case, and the difference between the manual and machine leaves you in doubt, check our website for the latest manual update or call technical support for help.

Before calling, find the manufacture date of your machine by looking at the date stamped into the machine ID label (see below). This will help us determine if the manual version you received matches the manufacture date of your machine.

		<b>MODEL GXXXX</b> <b>MACHINE NAME</b>	
<b>SPECIFICATIONS</b>		<b>WARNING!</b>	
Motor:		<b>Manufacture Date of Your Machine</b> When operating this machine: 1. Always wear eye protection, ear protection, and respirator. 2. Do not drink alcohol, use drugs, or become fatigued before starting. 3. Do not operate the machine if you are tired or under the influence of alcohol or drugs. 4. Make sure the motor has stopped and disconnect power before adjustments, maintenance, or service. 5. DO NOT expose to rain or dampness. 6. DO NOT modify this machine in any way. 7. DO NOT remove safety guards. 8. Never leave machine running unattended. 9. DO NOT operate under the influence of drugs or alcohol. 10. Maintain machine carefully to prevent accidents.	
Specification:			
Specification:			
Specification:			
Weight:			
<input type="text"/>	Date		
<input type="text"/>	Serial Number		
Manufactured for Grizzly in Taiwan			

For your convenience, we post all available manuals and manual updates for free on our website at [www.grizzly.com](http://www.grizzly.com). Any updates to your model of machine will be reflected in these documents as soon as they are complete.

## Contact Info

We stand behind our machines. If you have any questions or need help, use the information below to contact us. Before contacting, please get the serial number and manufacture date of your machine. This will help us help you faster.

Grizzly Technical Support  
1203 Lycoming Mall Circle  
Muncy, PA 17756  
Phone: (570) 546-9663  
Email: [techsupport@grizzly.com](mailto:techsupport@grizzly.com)

We want your feedback on this manual. What did you like about it? Where could it be improved? Please take a few minutes to give us feedback.

Grizzly Documentation Manager  
P.O. Box 2069  
Bellingham, WA 98227-2069  
Email: [manuals@grizzly.com](mailto:manuals@grizzly.com)

## Machine Description

This cyclone dust collector is a two-stage dust collector designed to capture dust and wood chips from woodworking machines, such as table saws, jointers, and planers. Stage one uses the cyclone feature to remove large debris into a separate canister before it passes through the blower, extending the life of the impeller. Stage two passes the fine dust particles, which pose serious long term health hazards, into the filter(s) and cleans the air before it returns to the shop.

A wide variety of accessories for setting up a stationary or mobile dust collection system are available through Grizzly.



# Identification

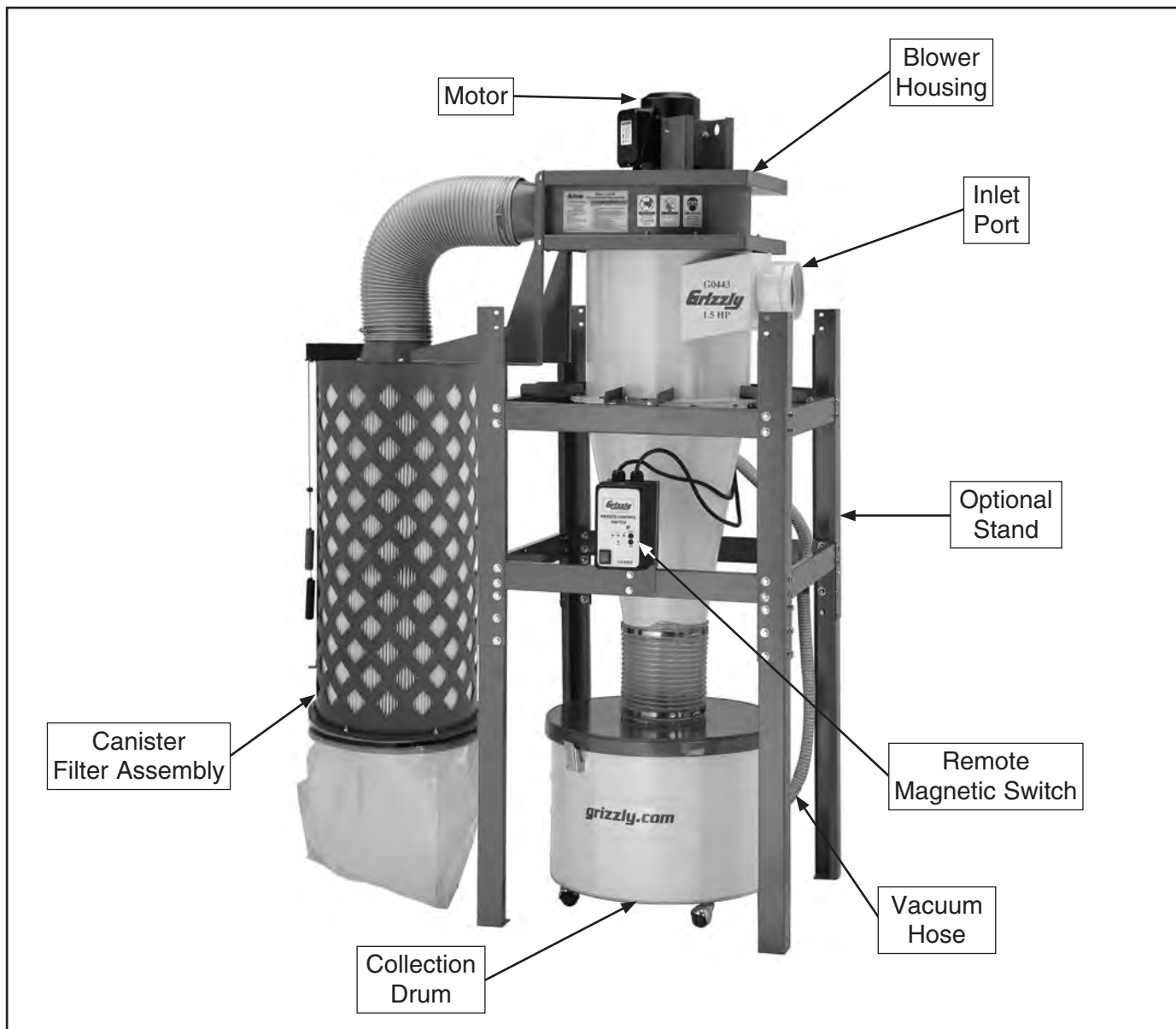


Figure 1. Model G0443 identification (shown with optional stand).

	<p><b>!WARNING</b></p> <p>To reduce the risk of serious injury when using this machine, read and understand this entire manual before beginning any operations.</p>
--	---





# MACHINE DATA SHEET

Customer Service #: (570) 546-9663 · To Order Call: (800) 523-4777 · Fax #: (800) 438-5901

## MODEL G0443 1-1/2 HP CYCLONE DUST COLLECTOR

### Product Dimensions:

Weight..... 251 lbs.  
 Width (side-to-side) x Depth (front-to-back) x Height..... 55-1/2 x 36-1/4 x 87-1/2 in.  
 Footprint (Length x Width)..... 55-1/2 x 36-1/4 in.

### Shipping Dimensions:

#### Carton #1

Type..... Cardboard  
 Content..... Machine  
 Weight..... 227 lbs.  
 Length x Width x Height..... 54 x 28 x 31 in.

#### Carton #2

Type..... Cardboard  
 Content..... Canister  
 Weight..... 46 lbs.  
 Length x Width x Height..... 50 x 20 x 20 in.

### Electrical:

Minimum Circuit Size..... 30 Amps at 110V, 15 Amps at 220V  
 Switch..... Magnetic with Thermal Overload Protection  
 Switch Voltage..... 110V  
 Plug Included..... No  
 Recommended Plug/Outlet Type..... NEMA L5-30 for 110V, NEMA 6-15 for 220V

### Motors:

#### Main

Type..... TEFC Class "F"  
 Horsepower..... 1-1/2 HP  
 Voltage..... 110/220V  
 Prewired..... 110V  
 Phase..... Single  
 Amps..... 18.8/9.4A  
 Speed..... 3450 RPM  
 Cycle..... 60 Hz  
 Number of Speeds..... 1  
 Power Transfer ..... Direct Drive  
 Bearings..... Shielded and Permanently Lubricated

### Main Specifications:

#### Operation

Dust Collector Type..... Cyclone  
 Filter Type..... Pleated Cartridge  
 Airflow Capacity..... 1025 CFM @2.6 in. S.P.  
 Max Static Pressure..... 10.3 in.  
 Main Inlet Size..... 6 in.  
 Manifold Included..... No  
 Maximum Material Collection Capacity..... 4.7 cu. ft.  
 Canister Filtration..... 0.2 – 2 micron



**Bag Information**

No of Lower Bags..... 1

**Canister Information**

No of Canister Filters..... 1  
Canister Filter Diameter..... 15-3/4 in.  
Canister Filter Length..... 46-3/4 in.  
Filter Surface Area..... 96 square ft.  
Collection Drum Size..... 35 gallons

**Impeller Information**

Impeller Type..... Radial Fin  
Impeller Size..... 12-1/2 in.

**Construction**

Lower Bag..... Clear Plastic  
Canister..... Spun Bond Polyester  
Impeller..... Steel, Riveted  
Blower Housing..... 11 Gauge Steel  
Body..... 14 Gauge Steel  
Collection Drum..... Steel

**Other**

Optional Stand..... H7508

**Other Specifications:**

Country Of Origin ..... Taiwan  
Warranty ..... 1 Year  
Serial Number Location ..... ID Label  
Customer Assembly & Setup Time ..... 3 Hours  
Sound Rating ..... 80 – 83 dB

**Features:**

- Reinforced Intake
- Clear Disposable Plastic Collection Bags
- Gentle Brush Cleaning Mechanism Inside Cartridge Filter
- 14 Gauge Steel Stand Available as an Option
- 220V Conversion Kit (Model H7498) Available as an Option
- Remote Control with Programmable Timer
- Casters Mounted on Collection Drum for Easy Moving
- Blower and Barrel Rotate 360 degrees for Inlet and Outlet Positioning
- BIA Certified Cartridge Filter
- Reinforced Motor Mount
- Wall Mountable Blower Design



# SECTION 1: SAFETY

## **WARNING**

### **For Your Own Safety, Read Instruction Manual Before Operating this Machine**

The purpose of safety symbols is to attract your attention to possible hazardous conditions. This manual uses a series of symbols and signal words intended to convey the level of importance of the safety messages. The progression of symbols is described below. Remember that safety messages by themselves do not eliminate danger and are not a substitute for proper accident prevention measures.



Indicates an imminently hazardous situation which, if not avoided, **WILL** result in death or serious injury.



Indicates a potentially hazardous situation which, if not avoided, **COULD** result in death or serious injury.



Indicates a potentially hazardous situation which, if not avoided, **MAY** result in minor or moderate injury. It may also be used to alert against unsafe practices.

### ***NOTICE***

This symbol is used to alert the user to useful information about proper operation of the machine.

## **WARNING**

### **Safety Instructions for Machinery**

**OWNER'S MANUAL.** Read and understand this owner's manual **BEFORE** using machine. Untrained users can be seriously hurt.

**EYE PROTECTION.** Always wear ANSI-approved safety glasses or a face shield when operating or observing machinery to reduce the risk of eye injury or blindness from flying particles. Everyday eyeglasses are not approved safety glasses.

**HAZARDOUS DUST.** Dust created while using machinery may cause cancer, birth defects, or long-term respiratory damage. Be aware of dust hazards associated with each workpiece material, and always wear a NIOSH-approved respirator to reduce your risk.

**WEARING PROPER APPAREL.** Do not wear clothing, apparel, or jewelry that can become entangled in moving parts. Always tie back or cover long hair. Wear non-slip footwear to avoid accidental slips which could cause a loss of workpiece control.

**HEARING PROTECTION.** Always wear hearing protection when operating or observing loud machinery. Extended exposure to this noise without hearing protection can cause permanent hearing loss.

**MENTAL ALERTNESS.** Be mentally alert when running machinery. Never operate under the influence of drugs or alcohol, when tired, or when distracted.





# WARNING

**DISCONNECTING POWER SUPPLY.** Always disconnect machine from power supply before servicing, adjusting, or changing cutting tools (bits, blades, cutters, etc.). Make sure switch is in OFF position before reconnecting to avoid an unexpected or unintentional start.

**APPROVED OPERATION.** Untrained operators can be seriously hurt by machinery. Only allow trained or properly supervised people to use machine. When machine is not being used, disconnect power, remove switch keys, or lock-out machine to prevent unauthorized use—especially around children. Make workshop kid proof!

**DANGEROUS ENVIRONMENTS.** Do not use machinery in wet or rainy locations, cluttered areas, around flammables, or in dark areas. Keep work area clean, dry, and well-lighted.

**ONLY USE AS INTENDED.** Only use machine for its intended purpose. Never modify machine for a purpose not intended by the manufacturer!

**USE RECOMMENDED ACCESSORIES.** Consult this owner's manual or the manufacturer for recommended accessories. Using improper accessories will increase the risk of serious injury.

**CHILDREN & BYSTANDERS.** Keep children and bystanders a safe distance away from work area. Stop using machine if children or bystanders become a distraction.

**REMOVE ADJUSTING TOOLS.** Never leave adjustment tools, chuck keys, wrenches, etc. in or on machine—especially near moving parts. Verify removal before starting!

**SECURING WORKPIECE.** When required, use clamps or vises to secure workpiece. A secured workpiece protects hands and frees both of them to operate the machine.

**FEED DIRECTION.** Unless otherwise noted, feed work against the rotation of blades or cutters. Feeding in the same direction of rotation may pull your hand into the cut.

**FORCING MACHINERY.** Do not force machine. It will do the job safer and better at the rate for which it was designed.

**GUARDS & COVERS.** Guards and covers can protect you from accidental contact with moving parts or flying debris. Make sure they are properly installed, undamaged, and working correctly before using machine.

**NEVER STAND ON MACHINE.** Serious injury or accidental contact with cutting tool may occur if machine is tipped. Machine may be damaged.

**STABLE MACHINE.** Unexpected movement during operations greatly increases risk of injury or loss of control. Before starting, verify machines are stable and mobile base (if used) is locked.

**AWKWARD POSITIONS.** Keep proper footing and balance at all times when operating machine. Do not overreach! Avoid awkward hand positions that make workpiece control difficult or increase the risk of accidental injury.

**UNATTENDED OPERATION.** Never leave machine running while unattended. Turn machine **OFF** and ensure all moving parts completely stop before walking away.

**MAINTAIN WITH CARE.** Follow all maintenance instructions and lubrication schedules to keep machine in good working condition. An improperly maintained machine increases risk of injury.

**CHECK DAMAGED PARTS.** Regularly inspect machine for damaged parts, loose bolts, mis-adjusted or mis-aligned parts, binding, or any other conditions that may affect safe operation. Always repair or replace damaged or mis-adjusted parts before operating machine.

**MAINTAIN POWER CORDS.** When disconnecting cord-connected machines from power, grab and pull the plug—NOT the cord. Pulling the cord may damage the wires inside. Do not handle cord/plug with wet hands. Avoid cord damage by keeping it away from heated surfaces, high traffic areas, harsh chemicals, and wet/damp locations.

**EXPERIENCING DIFFICULTIES.** If at any time you are experiencing difficulties performing the intended operation, stop using the machine! Contact our Technical Support Department at (570) 546-9663.



# Additional Safety for Dust Collectors

## **WARNING**

**INTENDED USE.** This dust collector is only intended for collecting wood dust and chips from woodworking machines. DO NOT use this dust collector to collect metal, dirt, pebbles, drywall, asbestos, lead paint, silica, liquids, aerosols, or any flammable, combustible, or hazardous materials.

**HAZARDOUS DUST.** Dust created while using machinery may cause cancer, birth defects, or long-term respiratory damage. Be aware of dust hazards associated with each workpiece material, and always wear a NIOSH-approved respirator to reduce your risk.

**DUST ALLERGIES.** Dust from certain woods may cause an allergic reaction in people and animals. Make sure you know what type of wood dust you will be exposed to in case there is a possibility of an allergic reaction.

**WEAR RESPIRATOR.** Fine dust that is too small to be caught in the filter will be blown into the ambient air during operation. Always wear a NIOSH approved respirator during operation and for a short time after to reduce your risk of permanent respiratory damage.

**EMPTYING DUST.** When emptying dust from the collection container, wear a respirator and safety glasses. Empty dust away from ignition sources and into an approved container.

**DISCONNECTING POWER SUPPLY.** Turn the switch **OFF**, disconnect the dust collector from the power supply, and allow the impeller to come to a complete stop before leaving the machine unattended or doing any service, cleaning, maintenance, or adjustments.

**REGULAR CLEANING.** Regularly check/empty the collection bags or drum to avoid the buildup of fine dust that can increase the risk of fire. Make sure to regularly clean the surrounding area where the machine is operated—excessive dust buildup on overhead lights, heaters, electrical panels, or other heat sources will increase the risk of fire.

**SUSPENDED DUST PARTICLES AND IGNITION SOURCES.** DO NOT operate the dust collector in areas where explosion risks are high. Areas of high risk include, but are not limited to, areas near pilot lights, open flames, or other ignition sources.

**FIRE SUPPRESSION.** Only operate the dust collector in locations that contain a fire suppression system or have a fire extinguisher nearby.

**IMPELLER HAZARDS.** DO NOT place your hands or tools near the open inlet during operation for any reason. The powerful suction could easily cause accidental contact with the impeller which will cause serious personal injury or damage to the machine. Always keep small animals and children away from open dust collection inlets.

**AVOIDING SPARKS.** DO NOT allow steel or rocks to strike the impeller—this may produce sparks. Sparks can smolder in wood dust for a long time before a fire is detected. If you accidentally cut into wood containing tramp metal (nails, staples, spikes, etc.), immediately turn **OFF** the dust collector, disconnect it from power, and wait for the impeller to stop—then empty the collection container into an approved airtight metal container.

**OPERATING LOCATION.** To reduce respiratory exposure to fine dust, locate permanently installed dust collectors away from the working area, or in another room that is equipped with a smoke detector. DO NOT operate the dust collector in rainy or wet locations—exposure to water may create a shock hazard or decrease the life of the machine.

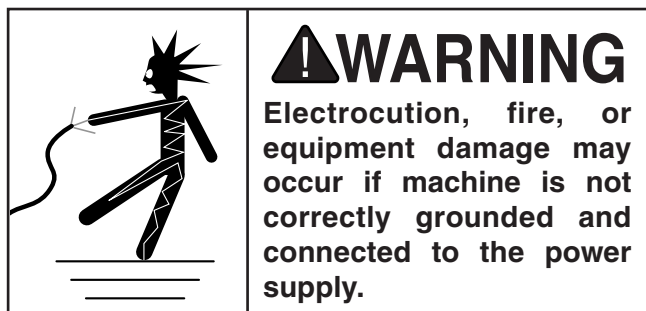
**STATIC ELECTRICITY.** Plastic dust lines generate high amounts of static electricity as dust chips pass through them. Although rare, sparks caused by static electricity can cause explosions or fire. To reduce this risk, make sure all dust lines are thoroughly grounded by using a grounding wire.



# SECTION 2: POWER SUPPLY

## Availability

Before installing the machine, consider the availability and proximity of the required power supply circuit. If an existing circuit does not meet the requirements for this machine, a new circuit must be installed. To minimize the risk of electrocution, fire, or equipment damage, installation work and electrical wiring must be done by a qualified electrician in accordance with all applicable codes and standards.



## Full-Load Current Rating

The full-load current rating is the amperage a machine draws at 100% of the rated output power. On machines with multiple motors, this is the amperage drawn by the largest motor or sum of all motors and electrical devices that might operate at one time during normal operations.

**Full-Load Current Rating at 110V... 18.8 Amps**

**Full-Load Current Rating at 220V .... 9.4 Amps**

The full-load current is not the maximum amount of amps that the machine will draw. If the machine is overloaded, it will draw additional amps beyond the full-load rating.

If the machine is overloaded for a sufficient length of time, damage, overheating, or fire may result—especially if connected to an undersized circuit. To reduce the risk of these hazards, avoid overloading the machine during operation and make sure it is connected to a power supply circuit that meets the requirements in the following section.

## Circuit Information

A power supply circuit includes all electrical equipment between the breaker box or fuse panel in the building and the machine. The power supply circuit used for this machine must be sized to safely handle the full-load current drawn from the machine for an extended period of time. (If this machine is connected to a circuit protected by fuses, use a time delay fuse marked D.)

**! CAUTION**  
For your own safety and protection of property, consult an electrician if you are unsure about wiring practices or electrical codes in your area.

**Note:** *The circuit requirements listed in this manual apply to a dedicated circuit—where only one machine will be running at a time. If this machine will be connected to a shared circuit where multiple machines will be running at the same time, consult a qualified electrician to ensure that the circuit is properly sized for safe operation.*

## Circuit Requirements for 110V

This machine is prewired to operate on a 110V power supply circuit that has a verified ground and meets the following requirements:

**Nominal Voltage** ..... 110V/120V  
**Cycle** ..... 60 Hz  
**Phase** ..... Single-Phase  
**Power Supply Circuit** ..... 30 Amps  
**Plug/Receptacle** ..... NEMA L5-30

## Circuit Requirements for 220V

This machine can be converted to operate on a 220V power supply (refer to **Voltage Conversion** instructions). This power supply must have a verified ground and meet the following requirements:

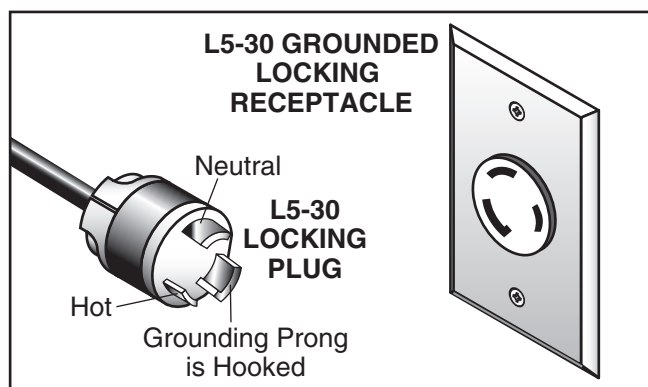
**Nominal Voltage** ..... 220V/240V  
**Cycle** ..... 60 Hz  
**Phase** ..... Single-Phase  
**Power Supply Circuit** ..... 15 Amps  
**Plug/Receptacle** ..... NEMA 6-15



## Grounding & Plug Requirements

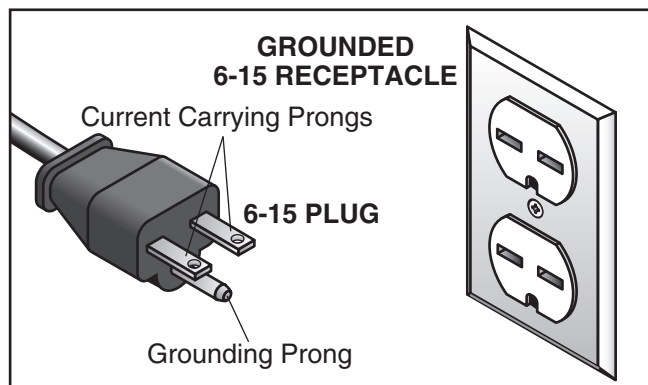
This machine **MUST** be grounded. In the event of certain malfunctions or breakdowns, grounding reduces the risk of electric shock by providing a path of least resistance for electric current.

**For 110V operation:** The plug specified under “Circuit Requirements for 110V” on the previous page has a grounding prong that must be attached to the equipment-grounding wire inside the included power cord. The plug must only be inserted into a matching receptacle (see below) that is properly installed and grounded in accordance with all local codes and ordinances.



**Figure 2.** Typical L5-30 plug and receptacle.

**For 220V operation:** The plug specified under “Circuit Requirements for 220V” on the previous page has a grounding prong that must be attached to the equipment-grounding wire on the included power cord. The plug must only be inserted into a matching receptacle (see following figure) that is properly installed and grounded in accordance with all local codes and ordinances.



**Figure 3.** Typical 6-15 plug and receptacle.

Improper connection of the equipment-grounding wire can result in a risk of electric shock. The wire with green insulation (with or without yellow stripes) is the equipment-grounding wire. If repair or replacement of the power cord or plug is necessary, do not connect the equipment-grounding wire to a live (current carrying) terminal.

Check with a qualified electrician or service personnel if you do not understand these grounding requirements, or if you are in doubt about whether the tool is properly grounded. If you ever notice that a cord or plug is damaged or worn, disconnect it from power, and immediately replace it with a new one.

## Extension Cords

We do not recommend using an extension cord with this machine. If you must use an extension cord, only use it if absolutely necessary and only on a temporary basis.

Extension cords cause voltage drop, which may damage electrical components and shorten motor life. Voltage drop increases as the extension cord size gets longer and the gauge size gets smaller (higher gauge numbers indicate smaller sizes).

Any extension cord used with this machine must contain a ground wire, match the required plug and receptacle, and meet the following requirements:

**Minimum Gauge Size (110V).....12 AWG**  
**Minimum Gauge Size (220V).....14 AWG**  
**Maximum Length (Shorter is Better).....50 ft.**



## G0443 Conversion to 220V Operation

Converting the Model G0443 from 110V to 220V operation consists of: 1) Replacing the 110V remote magnetic switch with the 220V switch, 2) re-wiring the motor, and 3) installing a NEMA 6-15 plug and receptacle.

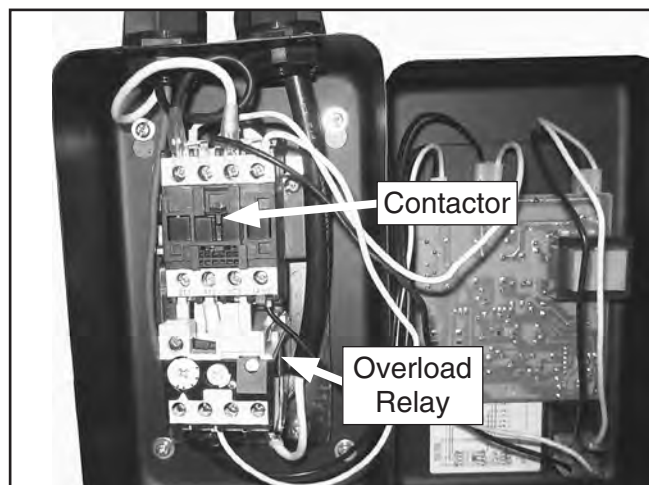
Purchase the Model G0443 220V Remote Magnetic Switch (Part No. P0443004C) by calling Grizzly Customer Service at (800) 523-4777.

All wiring changes must be inspected by an electrician or qualified service personnel before the dust collector is connected to the power source. If, at any time during this procedure you need help, call Grizzly Tech Support at (570) 546-9663.

Items Needed	Qty
Model G0443 220V Remote Mag Switch.....	1
Phillips Screwdriver #2 .....	1
Wrench 8mm .....	1
Wire Nuts.....	2
Electrical Tape.....	As Needed
NEMA 6-15 Plug & Receptacle .....	1 Each

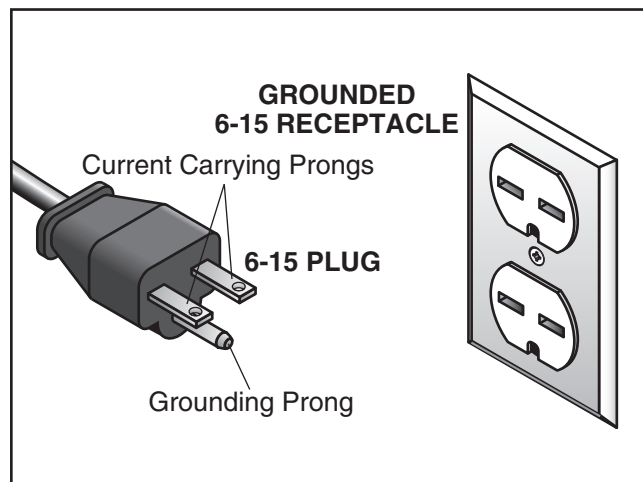
### To convert the Model G0443 for 220V operation:

1. DISCONNECT MACHINE FROM POWER!
2. Open the remote magnetic switch, then record the wire locations on the top of the contactor and the bottom of the overload relay (see **Figure 4**).



**Figure 4.** Model G0443 remote magnetic switch wiring.

3. Disconnect the wires coming from the power and motor cords, loosen the strain reliefs on top of the switch, then remove the cords from the switch.
4. Remove the four Phillips screws, flat washer, and hex nuts that secure the switch to the frame, remove the switch, then install the 220V switch in the same position.
5. Install the strain reliefs from the 110V switch onto the 220V switch, pull the power and motor cords through the reliefs, and re-connect the wires as noted in **Step 2**.
6. With adequate slack in the wires inside the switch, tighten the strain reliefs around the outside jackets of the cords so that there is no movement of the wires inside the switch when you tug on the cords, then secure the switch cover.
7. Open the motor junction box and, using wire nuts and electrical tape, connect the wires as directed by the diagram on the inside of the cover. Secure the junction box cover.
8. Attach a NEMA 6-15 plug (see **Figure 5**) to the end of the power cord. Make sure the plug grounding prong is attached to the equipment-grounding wire inside the power cord.

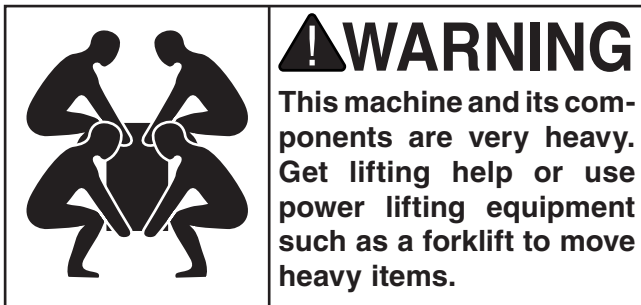
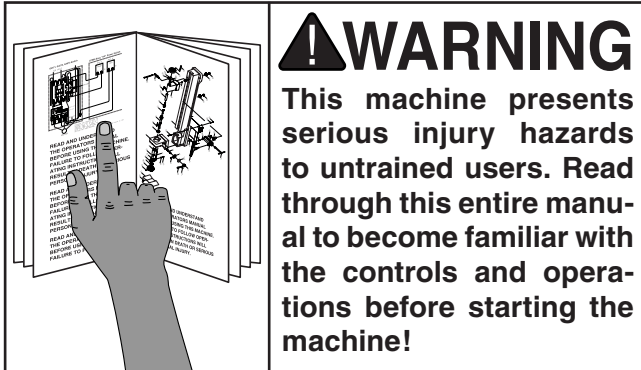


**Figure 5.** NEMA 6-15 plug and receptacle.

9. Install the matching NEMA 6-15 receptacle, making sure that it is properly connected to the 220V circuit and is grounded in accordance with all local codes and ordinances.



# SECTION 3: SETUP



## Needed for Setup

The following are needed to complete the setup process, but are not included with your machine.

Description.....	Qty
• Safety Glasses.....	1
• Additional People.....	As Needed
• Power Lifting.....	As Needed
• Screwdriver Phillips #2.....	1
• Wrench or Socket 1/2".....	2
• Wrench or Socket 9/16".....	2

## Unpacking

Your machine was carefully packaged for safe transportation. Remove the packaging materials from around your machine and inspect it. If you discover any damage, *please call us immediately at (570) 546-9663 for advice.*

Save the containers and all packing materials for possible inspection by the carrier or its agent. *Otherwise, filing a freight claim can be difficult.*

When you are completely satisfied with the condition of your shipment, inventory the contents.



# Inventory

The following is a description of the main components shipped with your machine. Lay the components out to inventory them.

If any non-proprietary parts are missing (e.g. a nut or a washer), we will gladly replace them; or for the sake of expediency, replacements can be obtained at your local hardware store.

Inventory (Figure 6)	Qty
A. Intake Cylinder .....	1
B. Cyclone Funnel .....	1
C. Intake Barrel .....	1
D. Canister/Drum Collection Bags .....	1 Each
E. Gray Flexible Hose 7" X 32" .....	1
F. Motor/Blower Housing Assembly .....	1
G. Collection Drum Lid.....	1
H. Collection Drum.....	1
I. Collection Drum Seal .....	1
J. Clear Flexible Hose 9" x 8" .....	1
K. Hose Clamps 9" .....	2
L. Outlet Port .....	1
M. Filter L-Braces .....	2
N. Foam Tape Roll 3 x 6mm .....	1
O. Hose Clamps 7" .....	2
P. Hose Clamp 6" .....	1
Q. Wall Mount Bracket .....	1
R. Casters .....	4
S. Wall Mount Brace .....	1
T. Barrel Gaskets.....	2
U. Brace Gaskets.....	2
V. Outlet Gasket .....	1
W. Canister Filter Assembly .....	1
X. Hose Clamps 1 1/4" .....	2
Y. Vacuum Hose 1 1/4" x 98" .....	1
Z. Collection Drum Vacuum Ring .....	1
AA. Cyclone Vacuum Tube .....	1

## Hardware (Not Shown)

—Phillips Head Screws #10-24 x 3/8" .....	6
—Hex Nuts #10-24 .....	6
—Drum Latches .....	3
—Roll of Foam Tape 3 x 15mm .....	1
—Hex Bolts 5/16"-18 x 1" .....	24
—Hex Bolts 5/16"-18 x 3/4" .....	24
—Flat Washers 5/16" .....	68
—Fender Washers 5/16" .....	4
—Hex Nuts 5/16"-18 .....	24
—Hex Bolts 3/8"-16 x 1" .....	6
—Hex Nuts 3/8"-16 .....	14

## Hardware (continued)

—Lock Washers 3/8" .....	4
—Flat Washers 3/8" .....	28

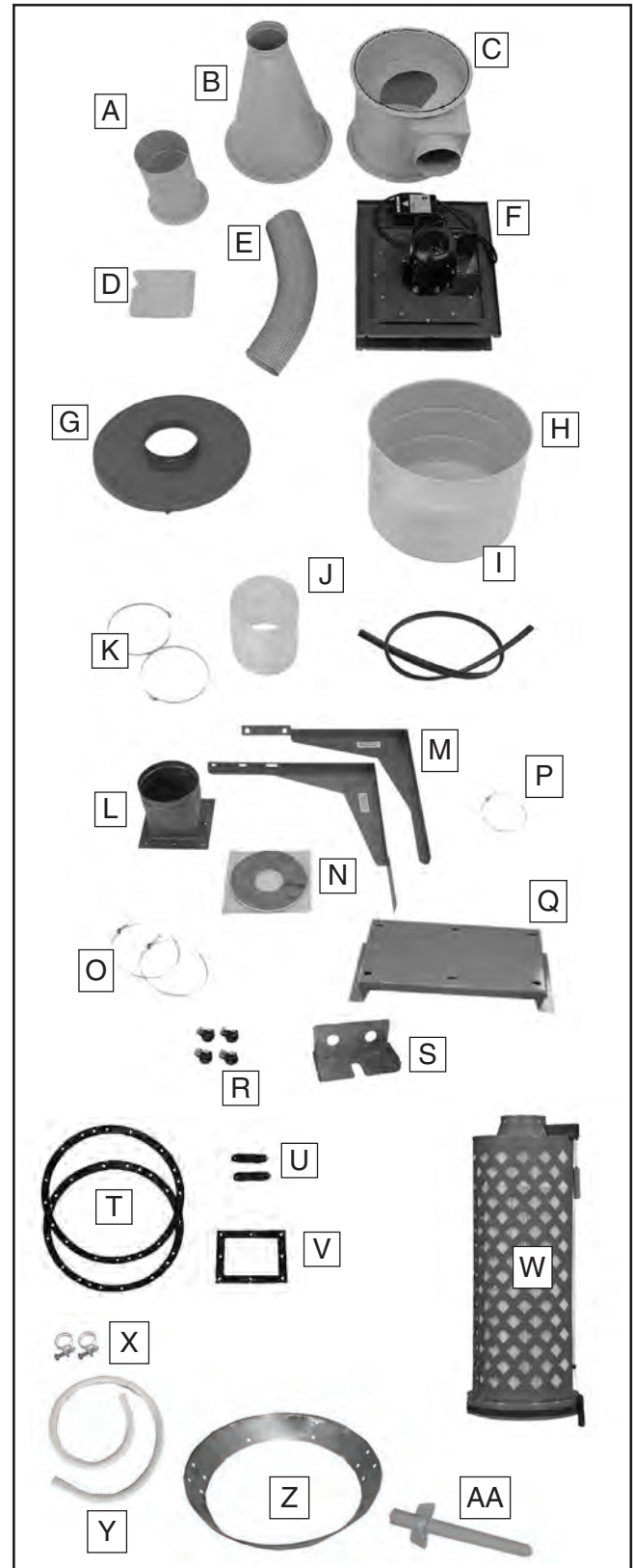


Figure 6. Model G0443 inventory.



# Site Considerations

## Weight Load

Refer to the **Machine Data Sheet** for the weight of your machine. Make sure that the surface upon which the machine is placed will bear the weight of the machine, additional equipment that may be installed on the machine, and the heaviest workpiece that will be used. Additionally, consider the weight of the operator and any dynamic loading that may occur when operating the machine.

## Space Allocation

Consider the largest size of workpiece that will be processed through this machine and provide enough space around the machine for adequate operator material handling or the installation of auxiliary equipment. With permanent installations, leave enough space around the machine to open or remove doors/covers as required by the maintenance and service described in this manual. **See below for required space allocation.**



## Physical Environment

The physical environment where the machine is operated is important for safe operation and longevity of machine components. For best results, operate this machine in a dry environment that is free from excessive moisture, hazardous chemicals, airborne abrasives, or extreme conditions. Extreme conditions for this type of machinery are generally those where the ambient temperature range exceeds 41°–104°F; the relative humidity range exceeds 20–95% (non-condensing); or the environment is subject to vibration, shocks, or bumps.

## Electrical Installation

Place this machine near an existing power source. Make sure all power cords are protected from traffic, material handling, moisture, chemicals, or other hazards. Make sure to leave access to a means of disconnecting the power source or engaging a lockout/tagout device, if required.

## Lighting

Lighting around the machine must be adequate enough that operations can be performed safely. Shadows, glare, or strobe effects that may distract or impede the operator must be eliminated.

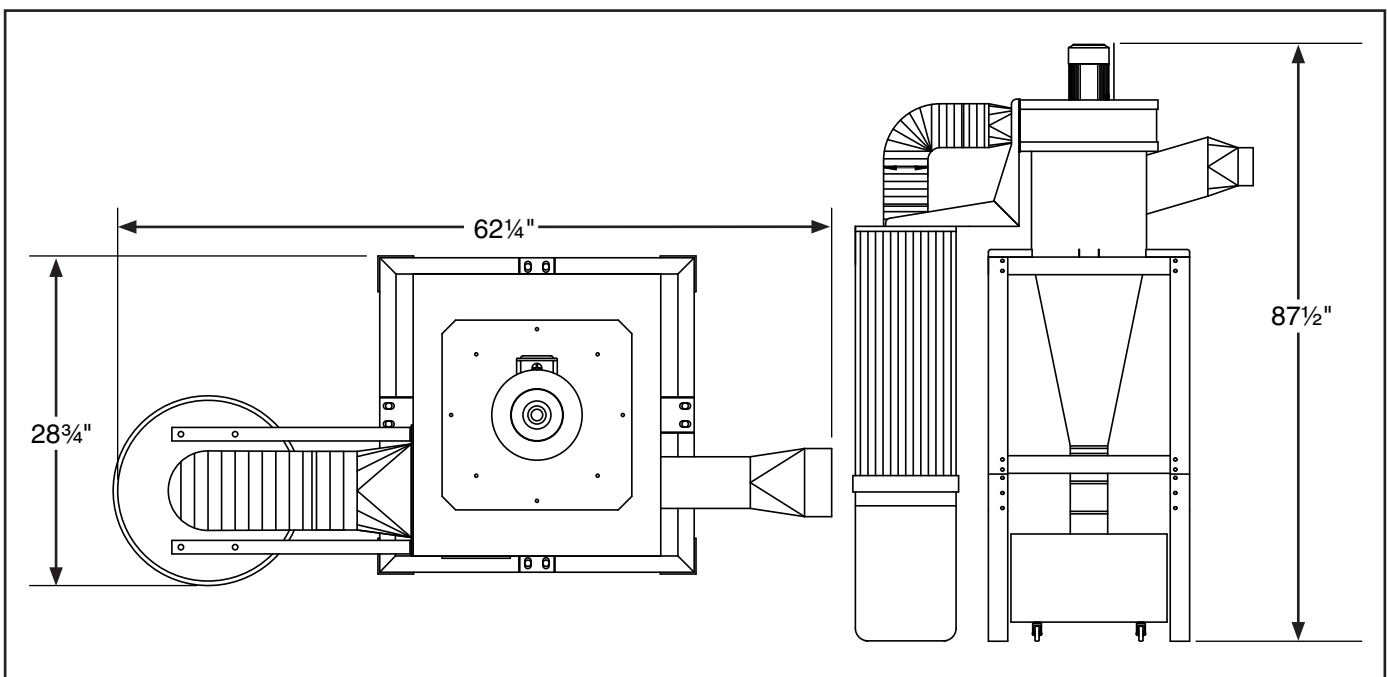


Figure 7. Minimum working clearances.





# Wall Mounting

Before mounting, make sure to situate the dust collector away from any open flames or potential ignition sources, as fine dust can easily ignite.

If mounting the dust collector to a wood framed wall, you must build and install the wall mounting boards described below to support the heavy weight of the dust collector.

If mounting the dust collector to a concrete or masonry wall, skip to **Page 16**.

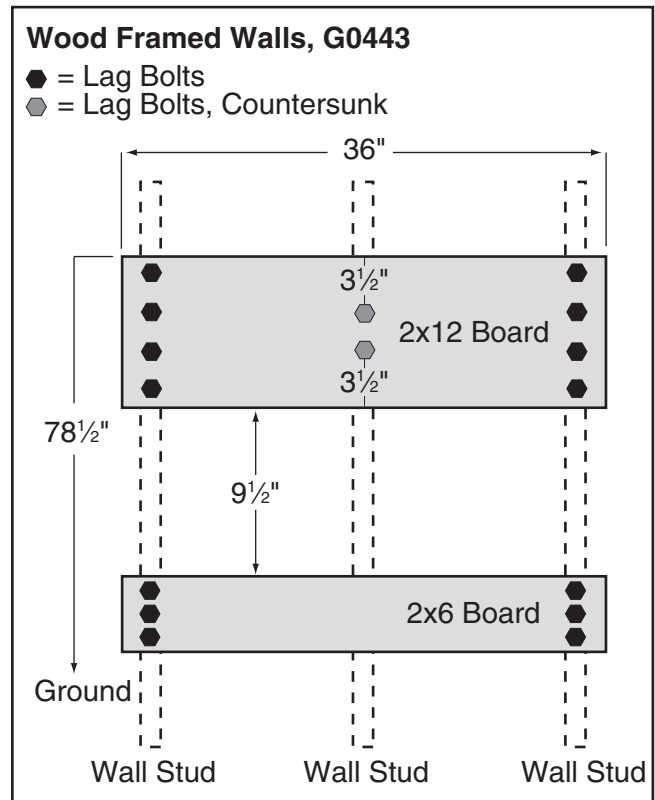
## Materials Needed for Standard Wood Framed Walls

- 2x12 Board 36" Long for Wall Mounting..... 1
- 2x6 Board 36" Long for Wall Mounting ..... 1
- Level 4' ..... 1
- Pencil..... 1
- Measuring Tape..... 1
- Lag Bolts  $\frac{3}{8}$ " x 5" (board/wall)..... 1
- Flat Washers  $\frac{3}{8}$ " (board/wall)..... 16
- Lag Bolts  $\frac{1}{2}$ " x 2" (machine/board) ..... 8\*
- Flat Washers  $\frac{1}{2}$ " (machine/board) ..... 8\*
- Drill ..... 1
- Drill Bit  $\frac{1}{4}$ " (for  $\frac{3}{8}$ " predrill)..... 1
- Drill Bit  $\frac{3}{8}$ " (for  $\frac{1}{2}$ " predrill) ..... 1
- Stud Finder..... 1

*\*Two of these fastener sets will be used in mounting the intake barrel brace during assembly.*

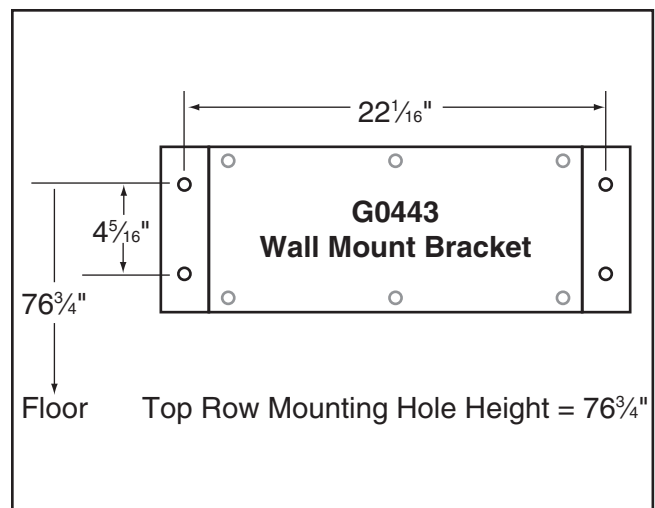
### To mount the motor/impeller housing to a wood framed wall:

1. Secure the wall mounting boards to the wall, using the applicable layout diagrams for your machine and wall type shown in **Figure 8**.



**Figure 8.** G0443 wall mounting board layout.

2. Copy the mounting hole layout pattern from the motor housing (see **Figure 9**) to the wall mounting board, making sure the **Top Row Mounting Hole Height** is at the height indicated in **Figure 9**.

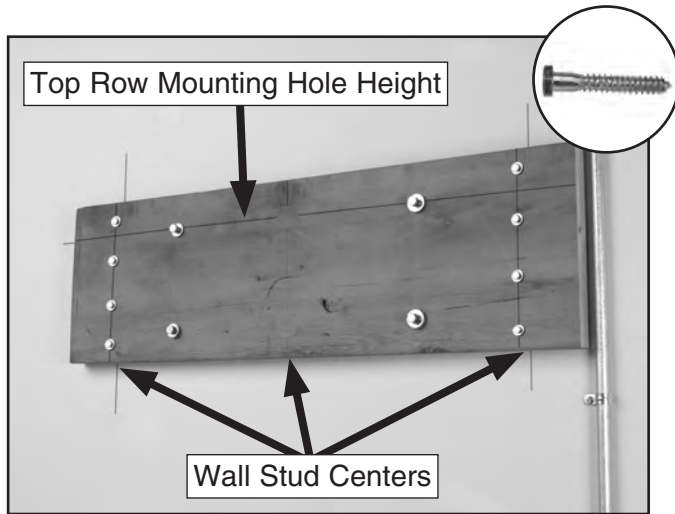


**Figure 9.** G0443 wall mounting layout.



3. Tighten the 1/2" lag bolts into the mounting locations so they do not project more than 1/2" from the mounting board to the top of the head, but leave them out enough to slide the housing over. This will prepare the mounting board for the mounting instructions described in **Assembly** on **Page 17**.

**Note:** *Predrill the mounting holes now, and insert the lag screws when you mount the motor/blower housing in the next section.*



**Figure 10.** Board fastened to wall and ready for motor/blower housing assembly.

## Materials Needed for Concrete/Masonry Wall

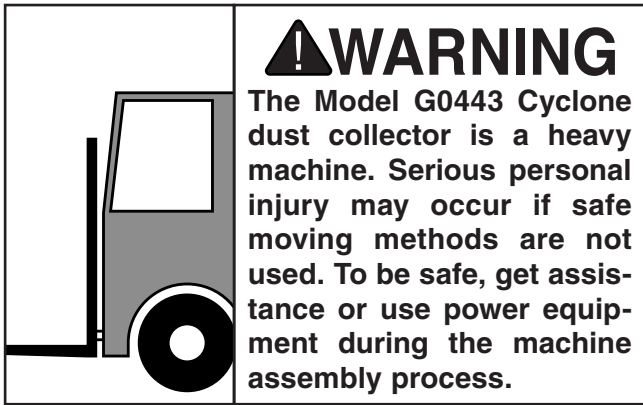
• Concrete Anchor Studs 1/2" x 2 3/4" .....	6
• Hex Nuts 1/2" .....	6
• Flat Washers 1/2" .....	6
• Hammer Drill .....	1
• Masonry Drill Bit 1/2" .....	1
• Level 4' .....	1
• Pencil.....	1
• Measuring Tape.....	1

### To mount the motor/impeller housing to a concrete or masonry wall:

1. Copy the mounting hole layout pattern from the motor housing to your wall, making sure the **Top Row Mounting Hole Height** (see **Figure 9** on **Page 17**) is correct for your dust collector.
2. Mount the anchor studs to the wall in the mounting hole locations for the motor/impeller housing. This will prepare the mounting board for the mounting instructions described in **Assembly** on **Page 17**.

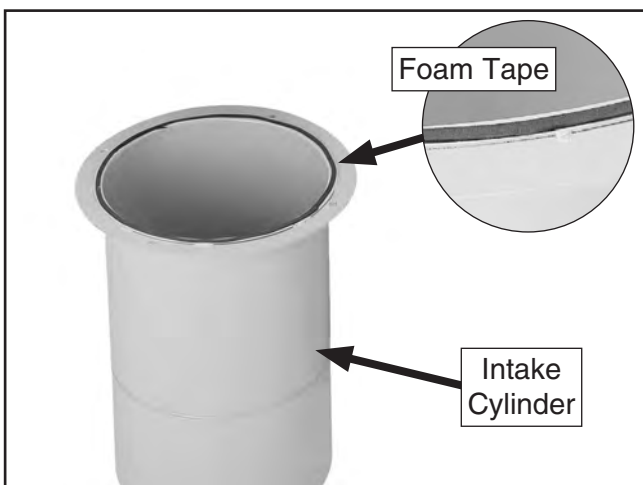


# Assembly



## To assemble the dust collector:

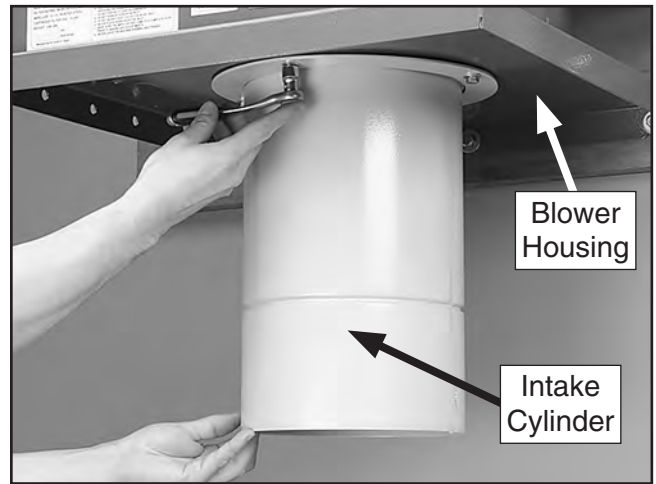
1. Attach the wall mounting bracket to the motor/blower housing with the provided (6)  $\frac{3}{8}$ "-16 x 1" hex bolts, (12)  $\frac{3}{8}$ " flat washers, and (6)  $\frac{3}{8}$ "-16 hex nuts. Refer to the parts breakdown diagram on **Page 44** for a graphical orientation of the parts.
2. With the help of assistants or power lifting equipment, lift the motor/blower housing assembly onto the hardware you mounted in the **Wall Mounting** section.
3. Attach the 3 x 6mm foam tape to the top of the intake cylinder, as shown in **Figure 11**.



**Figure 11.** Foam tape stuck on intake cylinder.

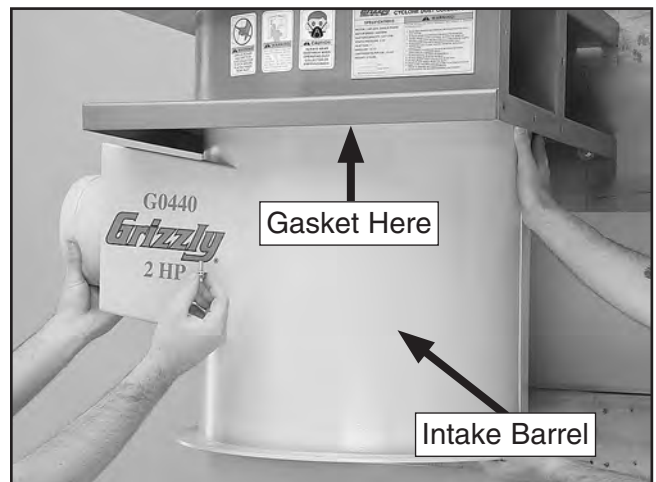
4. Attach the intake cylinder to the bottom of the housing, as shown in **Figure 12**, using (4)  $\frac{5}{16}$ "-18 x  $\frac{3}{4}$ " hex bolts and (4)  $\frac{5}{16}$ " flat washers.

**Note:** Because this part of the dust collector will not be accessible after assembly, consider using medium strength thread locking compound on the bolts that secure the intake cylinder to the motor/blower housing assembly. This added measure will ensure that the fasteners will not come loose from vibration.



**Figure 12.** Attaching intake cylinder to the bottom of motor housing.

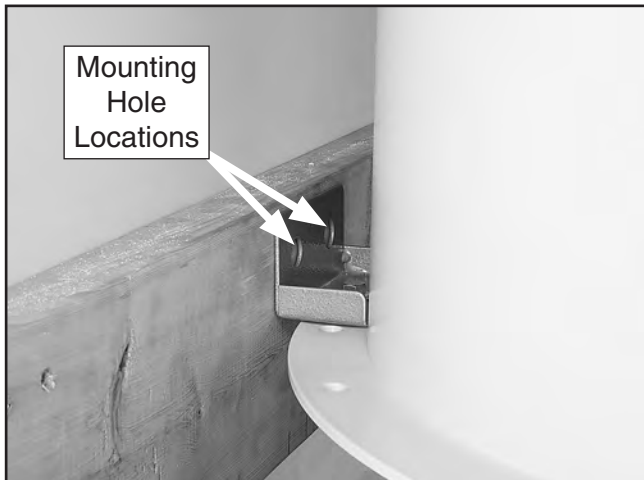
5. Temporarily attach the intake barrel to the housing with a barrel gasket in between, as shown in **Figure 13**, using (4)  $\frac{5}{16}$ "-18 x  $\frac{3}{4}$ " hex bolts and (4)  $\frac{5}{16}$ " flat washers—and only snug the bolts, rather than fully tighten them.



**Figure 13.** Example of securing blower on intake barrel.



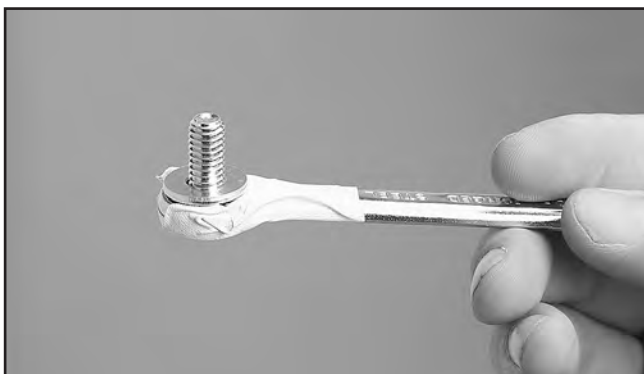
- Place the intake barrel brace in position and mark the location of the mounting holes (shown in **Figure 14**) with a small pencil, nail, or push pin.



**Figure 14.** Intake barrel brace positioned to mark the mounting holes.

- Remove the intake barrel you temporarily attached in **Step 4**, drill holes where you marked in **Step 5**, and loosely install the wall mount brace to the wall with the remaining fasteners from the **Wall Mounting** procedure on **Page 17**.
- Use the (12)  $\frac{5}{16}$ "-18 x  $\frac{3}{4}$ " hex bolts and (12)  $\frac{5}{16}$ " flat washers to re-install the intake barrel to the housing with a barrel gasket in between (see **Figure 13** on **Page 19**).

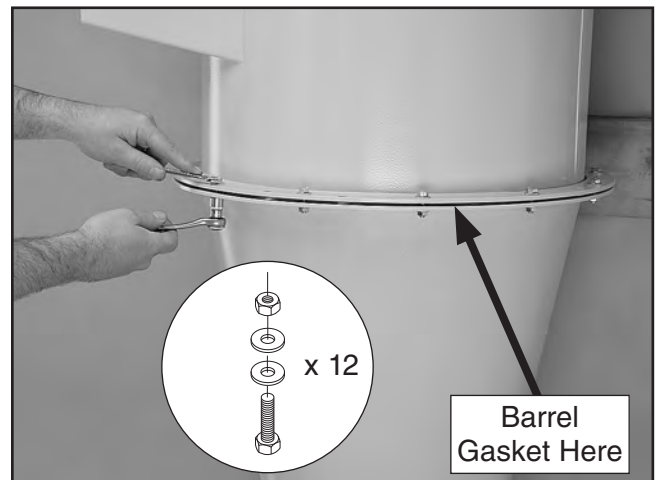
**Note:** When installing the two bolts above the intake port, use duct tape on the bottom of your wrench to hold the bolts in place, as shown in **Figure 15**, to start the bolts easier.



**Figure 15.** Using tape on wrench in tight spot.

- Attach the cyclone funnel to the intake barrel with a barrel gasket between them, as shown in **Figure 16**, using (12)  $\frac{5}{16}$ "-18 x 1" hex bolts, (24)  $\frac{5}{16}$ " flat washers, and (12)  $\frac{5}{16}$ "-18 hex nuts; also secure the wall mounting brace to the lip of the intake barrel/funnel assembly with the same hardware.

**Note:** At the places where you see 3 holes in a row, only use the center hole for this step. The two outside holes are only designed for use with the optional stand.



**Figure 16.** Cyclone funnel attached to intake barrel.

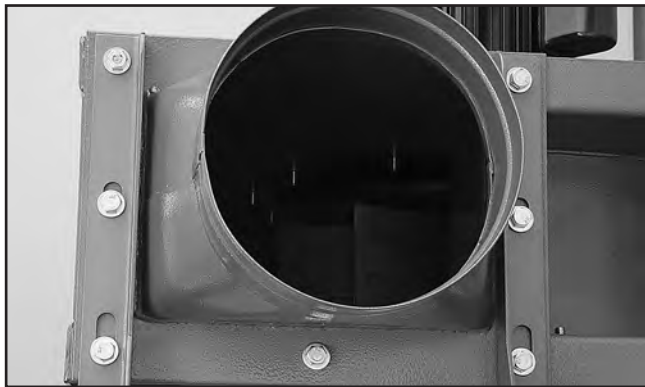
- Tighten the wall mounting brace to the wall.
- Attach the cyclone vacuum tube to the cyclone funnel with (4)  $\frac{5}{16}$ "-18 x  $\frac{3}{4}$ " hex bolts and (4)  $\frac{5}{16}$ " flat washers, as shown in **Figure 17**.



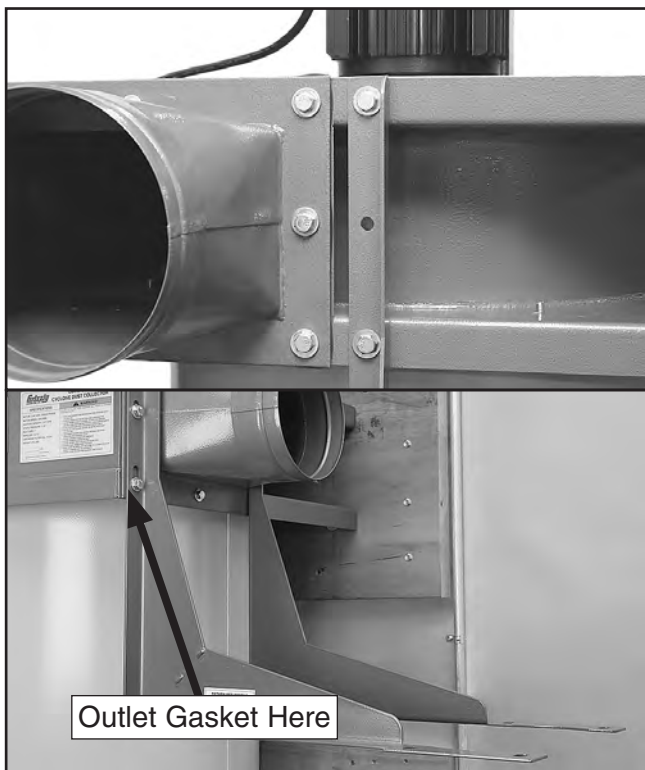
**Figure 17.** Cyclone vacuum tube and hose attachment.

12. Attach the outlet port and filter L-braces to the blower housing with the outlet gasket between the outlet port and the housing, as shown in **Figures 18–19**, using (8)  $\frac{5}{16}$ "-18 x 1" hex bolts, (16)  $\frac{5}{16}$ " flat washers, and (8)  $\frac{5}{16}$ "-18 hex nuts.

**Note:** One of the braces attaches directly to the housing with the following hardware: (2)  $\frac{5}{16}$ "-18 x 1" hex bolts, (4)  $\frac{5}{16}$ " flat washers, and (2)  $\frac{5}{16}$ "-18 hex nuts.

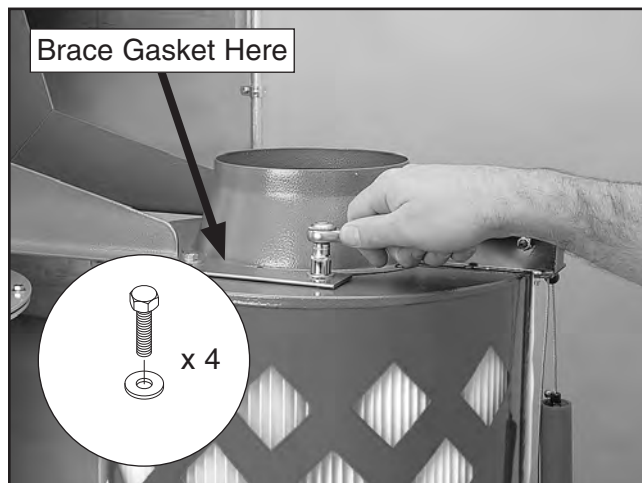


**Figure 18.** Outlet port and filter L-braces installed.



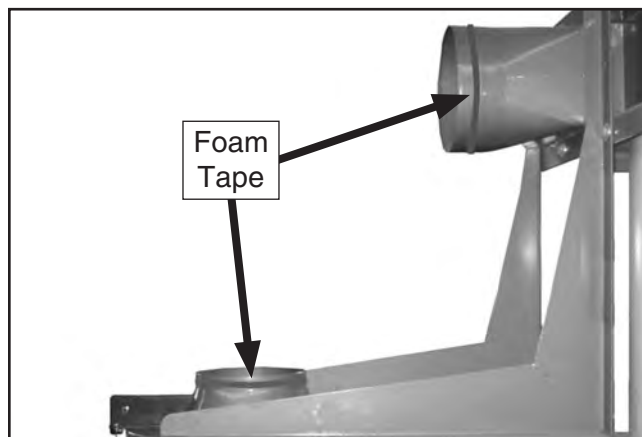
**Figure 19.** Model G0443 outlet port and filter L-braces installed.

13. Mount the filter to the L-braces with the brace gaskets between them, as shown in **Figure 20**, using (4)  $\frac{5}{16}$ "-18 x  $\frac{3}{4}$ " hex bolts and (4)  $\frac{5}{16}$ " fender washers.



**Figure 20.** Mounting filters to the braces.

14. Apply the 3 x 15mm foam tape to the edges of the outlet port and the canister adapter, as shown in **Figure 21**.

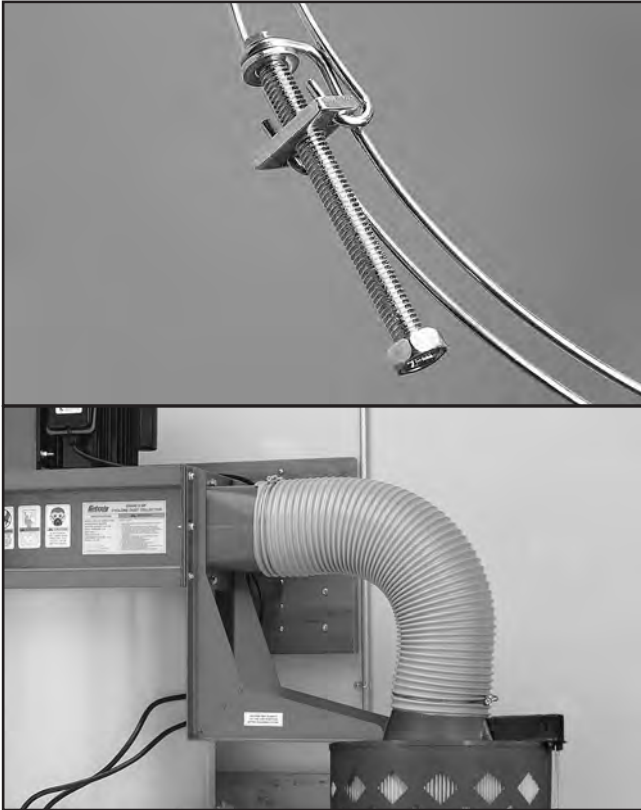


**Figure 21.** Foam tape applied to the outlet port and canister adapter.

**Note:** It may be necessary to reposition the canister L-braces down one bolt hole or shorten the length of the longer piece of flexible hose to accommodate the bend in the hose.

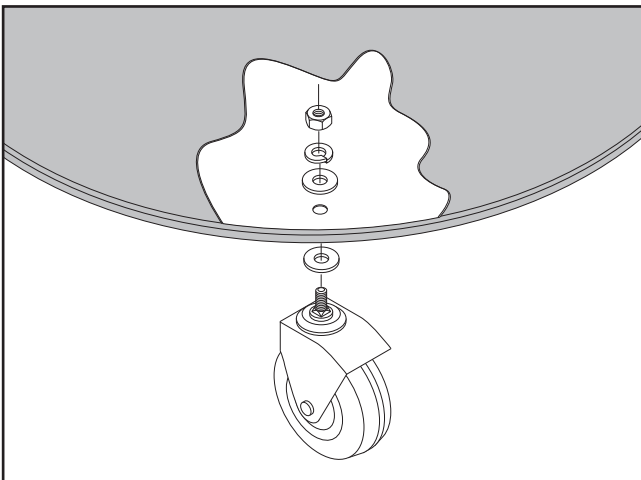


15. Connect the gray flexible hose from the outlet port to the canister adapter and secure it in place with the two 7" hose clamps, as shown in **Figure 22**.



**Figure 22.** Gray hose properly installed.

16. Attach the casters to the bottom of the lower collection drum, as shown in **Figure 23**, using the (4)  $\frac{3}{8}$ "-16 hex nuts, (8)  $\frac{3}{8}$ " flat washers, and (4)  $\frac{3}{8}$ " lock washers included in the box with the casters.



**Figure 23.** Cut-away illustration of casters attached to the lower collection drum.

17. Install the drum latches, as shown in **Figure 24**, with the (6) #10-24 x  $\frac{3}{8}$ " Phillips head screws and (6) #10-24 hex nuts included in the box with the drum latches. Make sure the hex nuts are on the outside of the drum so that they will not snag the plastic collection bag.



**Figure 24.** Installing drum latches on collector drum.

18. Place the collection drum vacuum ring on the bottom of the collection drum (see **Figure 25**).

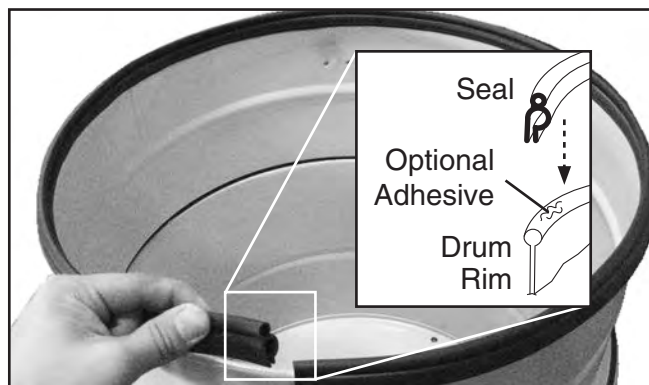
**Note:** During operation, this ring and the vacuum connection to the cyclone funnel will prevent the collection bag from collapsing.



**Figure 25.** Inserting collection drum vacuum ring.

19. Insert the rubber seal over the top lip of the collection drum rim. Pay special attention to the direction of the seal, as shown in the **Figure 26**.

**Tip:** To keep the seal in place, you can use an adhesive applied to the rubber seal at approximately 1" intervals.



**Figure 26.** Installing canister seal.

20. Insert the larger of the plastic collection bags into the collection drum, place the lid on the collection drum and hook the latch over the lid, as shown in **Figure 27**, then clamp it in place.



**Figure 27.** Latch hooked over lid for clamping.

21. Move the collector drum under the dust collector and connect it to the cyclone funnel with the clear flexible hose and the two 9" hose clamps, as shown in **Figure 28**.



**Figure 28.** Drum attached to cyclone funnel with clear 9" hose.

22. Connect the vacuum hose to the cyclone funnel and collection drum vacuum tubes with (2) 1¼" hose clamps, as shown in **Figure 29**.



**Figure 29.** Connecting the vacuum hose.



23. Fit the plastic canister collection bag over the bottom of the canister filter and clamp in place with the metal bag clamp, as shown in **Figure 30**.



**Figure 30.** Plastic collection bag clamped in place under filter.

24. Mount the switch on the funnel with the (2)  $\frac{5}{16}$ "-18 x 1" hex bolts, (4)  $\frac{5}{16}$ " flat washers, and (2)  $\frac{5}{16}$ "-18 hex nuts (see **Figure 31**).



**Figure 31.** Magnetic switch mounted to funnel.

## Power Connection

Before the machine can be connected to the power source, an electrical circuit and connection device must be prepared per the **POWER SUPPLY** section in this manual, and all previous setup instructions in this manual must be complete to ensure that the machine has been assembled and installed properly.

Always make sure the power switch on the machine is turned OFF (or the OFF button is pushed in) before connecting power.

### **NOTICE**

The Model G0443 is prewired for 110V. If you plan to operate the machine at 220V, the motor must be rewired (see Page 12) and a 220V switch must be installed.

### Power Connection

Insert the plug attached to the machine power cord into a matching power supply receptacle. The machine is now connected to the power source.

If you need to disconnect the machine from power later, pull the plug completely out of the receptacle.





# Test Run

---

Once the assembly is complete, test run your machine to make sure it runs properly and is ready for regular operation.

If, during the test run, you cannot easily locate the source of an unusual noise or vibration, stop using the machine immediately, then review the **Troubleshooting** on **Page 39**.

If you still cannot remedy a problem, contact our Tech Support at (570) 546-9663 for assistance.

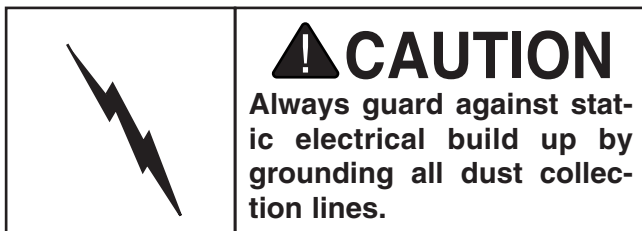
## To test run the machine:

1. Make sure you have read the safety instructions at the beginning of the manual and that the machine is setup properly.
2. Make sure all tools and objects used during setup are cleared away from the machine.
3. Connect the machine to the power source.
4. Using the remote control, press the ON/OFF button to turn the machine **ON**.
5. Listen to and watch for abnormal noises or actions. The machine should run smoothly with little or no vibration or rubbing noises.  
  
—Strange or unusual noises should be investigated and corrected before operating the machine further. Always disconnect the machine from power when investigating or correcting potential problems.
6. Press the TIMER button and cycle through each of the times to make sure the lights illuminate on the switch.
7. Press the TIMER on the remote control and cycle through each of the times in the same manner as **Step 6**.
8. Press the ON/OFF button on the remote control to make sure it is working properly.



# SECTION 4: DESIGNING THE SYSTEM

## General



The Model G0443 works great as a central system for a small shop or a dedicated dust collector for large production machines.

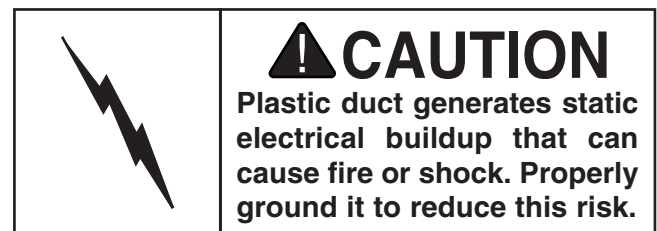
When installing the dust collector be sure to put it in an out of the way location such as a corner or separate room. The dust collector is capable of collecting dust from up to three machines running simultaneously. Grizzly offers a complete line of dust collection accessories for setting up a stationary system. Additionally, Grizzly offers a complete guide book entitled *Dust Collection Basics*.

Whatever system you choose, always make sure there are no open flames or pilot lights in the same room as the dust collector. There is a risk of explosion if dust is dispersed into the air.

## Duct Material

You have many choices regarding main line and branch line duct material. For best results, use metal duct for the main line and branch lines, then use short lengths of flexible hose to connect each machine to the branch lines.

Plastic duct is also a popular material for home shops. However, be aware that there is a fire or explosion hazard if plastic duct material is used for dust collection without being grounded against static electrical charge build-up. This topic will be discussed later in this section. Another problem with using plastic is that it is less efficient per foot than metal.



## Plastic Duct

The popularity of plastic duct is due to the fact that it is an economical and readily available product. It is also simple to assemble and easily sealed against air loss. The primary disadvantage of plastic duct for dust collection is the inherent danger of static electrical build-up.

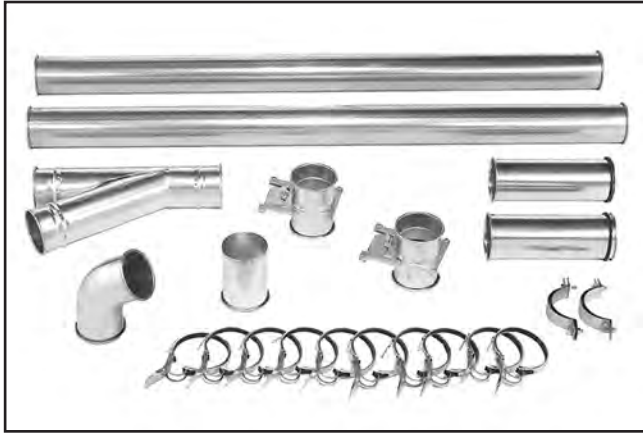


**Figure 32.** Examples of plastic ducting components.



## Metal Duct

Advantages of metal duct is its conductivity and that it does not contribute to static electrical charge build-up. However, static charges are still produced when dust particles strike other dust particles as they move through the duct. Since metal duct is a conductor, it can be grounded quite easily to dissipate any static electrical charges.



**Figure 33.** Examples of metal pipe and components.

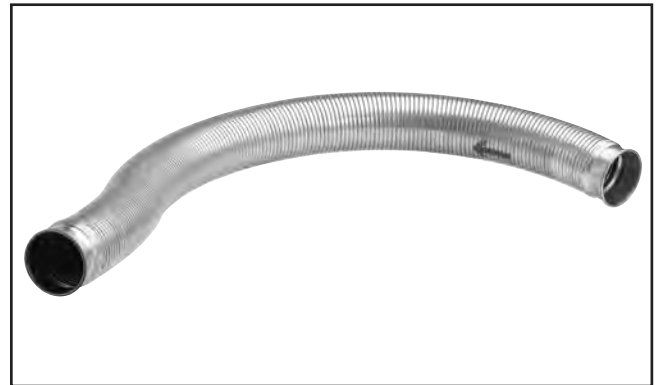
There are a number of options when it comes to metal duct, but metal duct that is specially manufactured for dust collection is the best choice. When selecting your metal duct, choose high quality metal duct with smooth welded internal seams that will minimize airflow resistance. This type of duct usually connects to other ducts or elbows with a simple, self-sealing clamp, is very quick and easy to assemble, and can be readily dismantled and re-installed. This is especially important if you ever need to change things around in your shop or add more tools.

Avoid inferior metal duct that requires you to cut it to length and snap it together. This type of duct is time consuming to install because it requires you to seal all the seams with silicone and screw the components on the ends with sheet metal screws. Another disadvantage is the rough internal seams and crimped ends that unavoidably increase static pressure loss.

## Flexible Duct

Flexible hose is generally used for short runs, small shops and at rigid duct-to-tool connections. There are many different types of flex hose on the market today. These are manufactured from materials such as polyethylene, PVC, cloth hose dipped in rubber and even metal, including steel and aluminum.

The superior choice here is metal flex hose that is designed to be flexible, yet be as smooth as possible to reduce static pressure loss.



**Figure 34.** Example of flexible metal duct.

There are also many kinds of pure plastic flexible hose, such as non-perforated drainage type hose and dryer vent hose. Drainage type hose, while being economical, does not quite have the flexibility required for dust collection. The inside of the duct is also deeply corrugated and can increase the static pressure loss by as much as 50% over smooth wall duct. Dryer vent hose, while being completely flexible, is non-resistant to abrasion and has a tendency to collapse in a negative pressure system. We DO NOT recommend using dryer vent hose in your dust collection system.

If using flex-hose, you should choose one of the many types that are designed specifically for the movement of solid particles, i.e. dust, grains, and plastics. However, the cost of specifically designed flexible duct can vary greatly. Grizzly offers polyethylene hose, which is well suited for the removal of particulate matter, especially sawdust, since it is durable and completely flexible. Polyethylene is also very economical and available in a wide variety of diameters and lengths for most applications.



# System Design

## Step 1. Decide Who Will Design

For most small-to-medium sized shops, you can design and build the dust collection system yourself without hiring engineers or consultants. We have included some basic information here to get you started on a basic design.

If you have a large shop or plan to design a complicated system, we recommend doing additional research beyond this manual or seeking the help of an expert.

## Step 2. Sketch Your Shop Layout

When designing a successful dust collection system, planning is the most important step. In this step, sketch a basic layout of your shop, including space requirements of different machines.

Before you get out your pencil and paper, we recommend you visit our **FREE Workshop Planner** available on our website at [www.grizzly.com](http://www.grizzly.com).

Our *Workshop Planner* will allow you to quickly and easily design and print a basic shop layout. Don't worry, non-Grizzly brand machines can be substituted with Grizzly machines for layout purposes. **Note:** After you're finished, make sure to save your layout for later modification.

Your sketch only needs the basic details of the shop layout, similar to the **Figure** below, including all your current/planned machines and your planned placement of the dust collector.

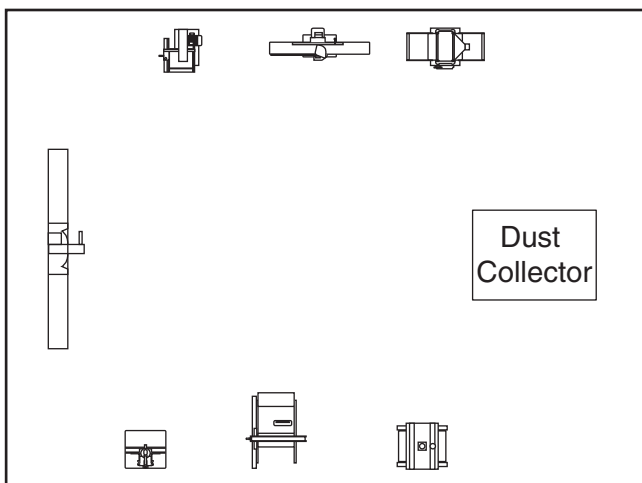


Figure 35. Basic sketch of shop layout.

## Step 3. Sketch a Basic Duct Layout

For the next step, sketch how you will connect your machines to the dust collector. Consider these general guidelines for an efficient system:

1. Machines that produce the most saw dust should be placed nearest to the dust collector (i.e. planers and sanders).
2. Ideally, you should design the duct system to have the shortest possible main line and secondary branch ducts. See the figures below for ideas of efficient versus inefficient duct layouts.

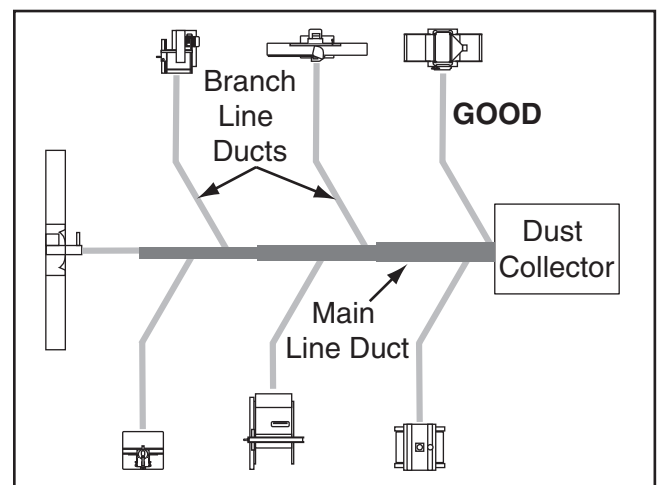


Figure 36. Efficient duct layout.

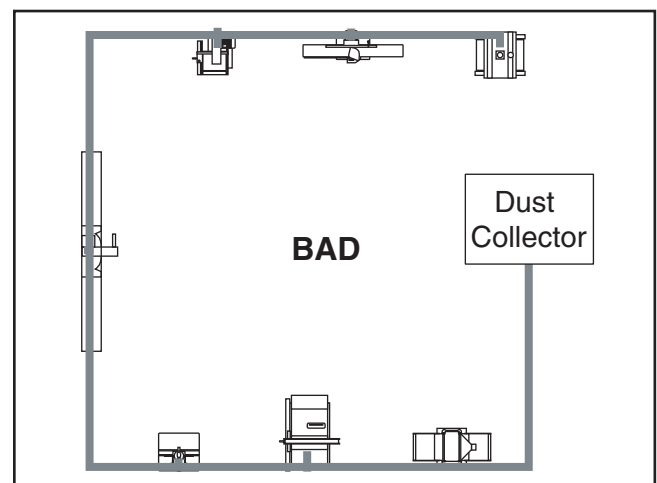


Figure 37. Inefficient duct layout.



- Directional changes should be kept to a minimum. The more directional change fittings you use directly increases the overall resistance to airflow.
- Gradual directional changes are more efficient than sudden directional changes (i.e. use the largest corner radius possible when changing hose or pipe direction).
- Each individual branch line should have a blast gate immediately after the branch to control suction from one machine to another.
- The simpler the system, the more efficient and less costly it will be.

### Step 4. Determine Required CFM of Each Machine

Since each machine produces a different amount of sawdust, the requirements for the minimum amount of CFM to move that sawdust is unique to the machine (for example, a planer produces more sawdust than a table saw). Knowing this required CFM is important to gauging which size of duct to use.

Refer to the **Figure** below for a close estimation of the airflow each machine requires. Keep in mind that machines that generate the most sawdust should be placed closest to the dust collector. If the machine has multiple dust ports, the total CFM required is the sum of all ports.

Machine Dust Port Size	Approximate Required CFM
2"	98
2.5"	150
3"	220
4"	395
5"	614
6"	884
7"	1203
8"	1570
9"	1990
10"	2456

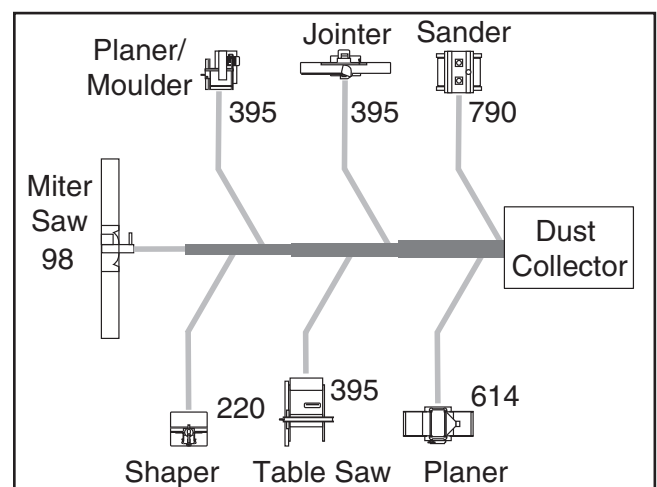
**Figure 38.** Approximate required airflow for machines, based on dust port size.

If the machine does not have a built-in dust port, use the following table to determine which size of dust port to install.

Machine	Average Dust Port Size
Table Saw.....	4"
Miter/Radial-Arm Saw.....	2"
Jointer (6" and smaller) .....	4"
Jointer (8"-12") .....	5"
Thickness Planer (13" and smaller).....	4"
Thickness Planer (14"-20") .....	6"
Shaper.....	4"
Router (mounted to table).....	2"
Bandsaw.....	4"
Lathe.....	4"
Disc Sander (12" and smaller).....	2"
Disc Sander (13-18").....	4"
Belt Sander (6" and smaller) .....	2"
Belt Sander (7"-9") .....	3"
Edge Sander (6" x 80" and smaller).....	4"
Edge Sander (6" x 80" and larger) .....	5"
Drum Sander (24" and smaller).....	2 x 4"
Drum Sander (24" and larger) .....	4 x 4"
Widebelt Sander (18" and smaller).....	5"
Widebelt Sander (24"-37" single head) ...	2 x 6"
Widebelt Sander (24"-51" double head) ..	5 x 4"

**Figure 39.** Dust port size and quantity per average machine.

Write the required CFM for each machine on your sketch, as shown in the figure below.



**Figure 40.** CFM requirements labeled for each machine.



## Determining Main Line Duct Size

The general rule of thumb for a main line duct is that the velocity of the airflow must not fall below 3500 FPM.

For small/medium sized shops, using the inlet size of the dust collector as the main line duct size will usually keep the air velocity above 3500 FPM and, depending on your system, will allow you to keep multiple branches open at one time.

Mark your drawing, as shown in the figure below, but using the inlet size for your dust collector as the main line.

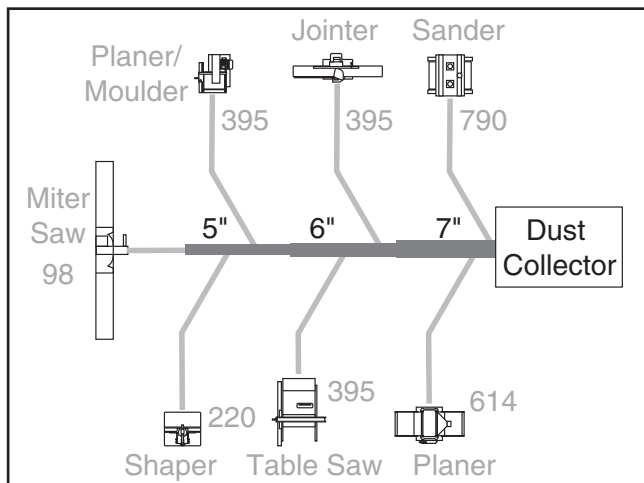


Figure 41. Main line size labeled on sketch.

## Determining Branch Line Duct Size

The general rule of thumb for a branch line duct is that the velocity of the airflow must not fall below 4000 FPM.

For small/medium sized shops, using the dust port size from the machine as the branch line duct size will achieve the correct velocity in most applications. However, if the dust port on the machine is smaller than 4", make the branch line 4" and neck the line down right before the dust port.

**Note:** Systems with powerful dust collectors work better if multiple blast gates are left open. This also allows you to run two machines at once. Experiment with different combinations of blast gates open/closed to find the best results for your system.

Write your determined branch line sizes on your drawing, as shown in the following **Figure**.

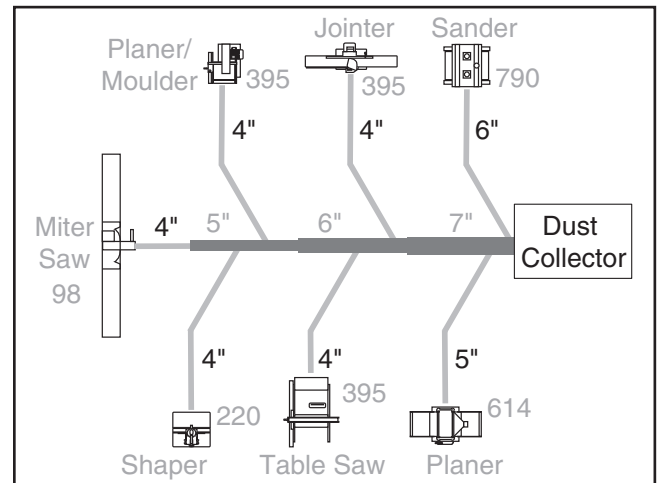


Figure 42. Branch line duct sizes labeled.

## Drop Downs

Plan all the drop downs for each machine with blast gates, as shown in the **Figure** below.

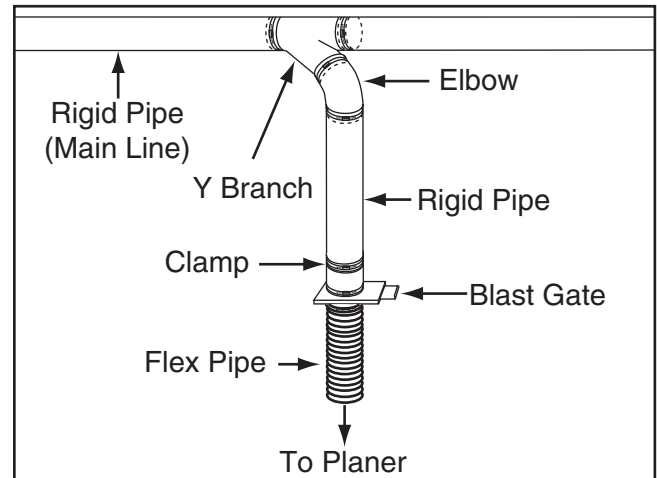


Figure 43. Drop down setup.



## Multiple Dust Ports

If your machine has multiple dust ports, add the total CFM given for each dust port size from the table under **Step 4** (approximate required airflow) on the previous page. Refer to the **Table** below and find the CFM that is closest to your total to determine the correct branch size. Split the branch line just before the dust ports with matching duct sizes.

## Two Machines on Same Branch Line

If both machines will run at the same time, add the total CFM given for each size from the table (approximate required airflow) under **Step 4** and match the branch line given below.

If both machines will never run at the same time, reference the machine with the biggest dust port in the **Table** below and add blast gates after the Y-branch to open/close the line to each machine.

Total CFM	Branch Line Size
400	4"
500	4"
600	5"
700	5"
800	6"
900	6"
1000	6"

## Calculating Duct Resistance

Adding duct work, elbows, branches and any other components to a duct line increases airflow resistance (static pressure loss). This resistance can be minimized by using rigid (smooth) pipe and gradual curves, as opposed to flexible pipe and 90° elbows.

To help you think about this resistance, imagine riding a bicycle in a tunnel that is an exact replica of your duct work. If the inside of the tunnel is very bumpy (flexible pipe) and has a lot of sharp turns (90° elbows), it will take a lot more effort to travel from one end to the other.

The purpose of calculating the resistance is to determine if it is low enough from the machine to the dust collector to meet the given CFM requirement for the machine. Use the following tables to calculate the resistance of duct work.

Duct Dia.	Approximate Static Pressure Loss Per Foot of Rigid Pipe		Approximate Static Pressure Loss Per Foot of Flex Pipe	
	Main Lines at 3500 FPM	Branch Lines at 4000 FPM	Main Lines at 3500 FPM	Branch Lines at 4000 FPM
2"	0.091	0.122	0.35	0.453
2.5"	0.08	0.107	0.306	0.397
3"	0.071	0.094	0.271	0.352
4"	0.057	0.075	0.215	0.28
5"	0.046	0.059	0.172	0.225
6"	0.037	0.047	0.136	0.18
7"	0.029	0.036	0.106	0.141
8"	0.023	0.027	0.08	0.108
9"	0.017	0.019	0.057	0.079

Fitting Dia.	90° Elbow	45° Elbow	45° Wye(Y)	90° Wye(Y)
3"	0.47	0.235	0.282	0.188
4"	0.45	0.225	0.375	0.225
5"	0.531	0.266	0.354	0.236
6"	0.564	0.282	0.329	0.235
7"	0.468	0.234	0.324	0.216
8"	0.405	0.203	0.297	0.189

Figure 44. Static pressure loss tables.

In most small/medium shops it is only necessary to calculate the line with the longest duct length or the most fittings (operating under the assumption that if the line with the highest resistance works, the others will be fine).

**To calculate the static pressure of any given line in the system, follow these steps:**

1. Make a list of each size duct in the line, including the length, and multiply those numbers by the static pressure value given in the previous table.
2. List each type of elbow or branch and multiply the quantity (if more than one) by the static pressure loss given in the previous table.



3. Add the additional factors from the following table to your list.

Additional Factors	Static Pressure
Seasoned (well used) Dust Collection Filter	1"
Entry Loss at Large Machine Hood	2"

**Figure 45.** Additional factors affecting static pressure.

4. Total your list as shown in the example below to come up with your overall static pressure loss number for that line.

**Note:** Always account for a seasoned filter, so you don't end up with a system that only works right when the filter is clean.

<b>Main Line</b>		
6" Rigid Pipe (0.037) at 20'	.....	0.740
<b>Branch Line</b>		
4" Rigid Pipe (0.075) at 10'	.....	0.750
4" Flex Pipe (0.28) at 5'	.....	1.400
<b>Elbows/Branches</b>		
6" 45° Y-Branch	.....	0.329
4" 45° Elbow	.....	0.225
<b>Additional Factors</b>		
Seasoned Filter	.....	<u>1.000</u>
<b>Total Static Pressure Loss</b>	.....	<b>4.444</b>

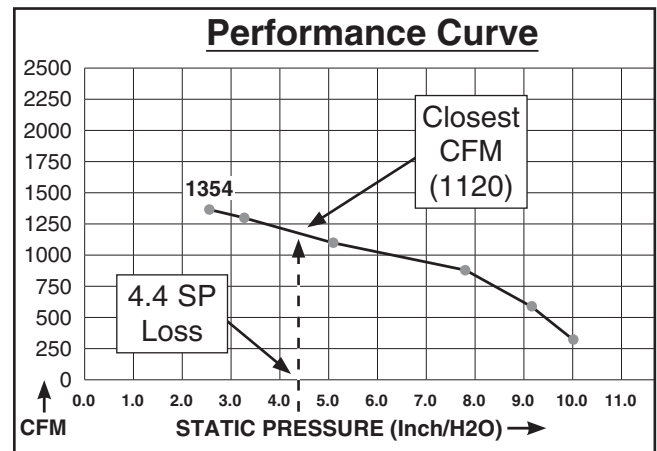
**Figure 46.** Totaling static pressure numbers.

**Note:** When calculating static pressure loss to determine if multiple lines can be left open at the same time, only include the main line numbers once.

5. Compare the total static pressure loss for that line to the closest CFM given in **Figure 48** for your dust collector on **Page 31**.

**Example:** A typical **Data Sheet Performance Curve** is illustrated in **Figure 47**. Find 4.4 on the Static Pressure axis (the amount of total static pressure loss calculated in **Figure 46**), then refer to the closest value on the CFM axis—approximately 1120 CFM.

The 1120 CFM for the static pressure loss of the line connected to the router is well above the 220 CFM requirement of that machine.



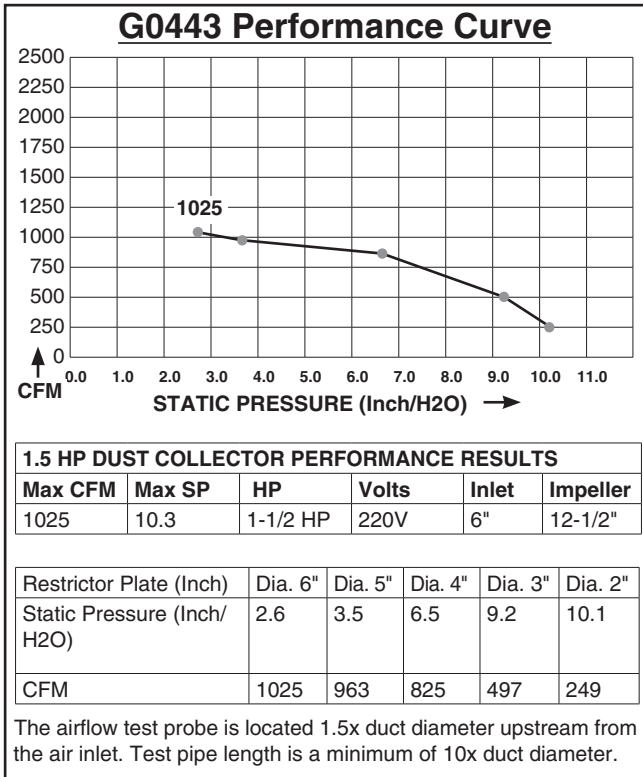
**Figure 47.** CFM for static pressure loss of line connected to a dust collector & router.

—If the CFM for your static pressure loss is above the requirement of the machine connected to the end of that branch line, then dust collection will most likely be successful. Congratulations! You've just designed your own dust system. Refer to the **Accessories** section on **Page 34** to start buying the components necessary to make your system a reality.

—If the CFM for your static pressure loss is below the requirement of the machine, then that line will not effectively collect the dust. You must then modify some of the factors in that line to reduce the static pressure loss. Some of the ways to do this include 1) installing larger duct, 2) reducing amount of flexible duct used, 3) increasing machine dust port size, 4) moving machine closer to dust collector to eliminate duct length, and 5) reducing 90° elbows or replacing them with 45° elbows.







**Figure 48.** G0443 performance curve chart and data.

## Example Materials List

After the system is designed, create a materials list of all the items you will need to build your dust collection system. This will make it easy when it comes time to purchase the materials.

Below is an example of some items that might be needed. Refer to **Accessories** for dust collection components available through Grizzly.com.

Description	Model	Quantity
6" Rigid Pipe at 20'	G7364	4
4" Rigid Pipe at 10'	G6162	2
4" Flex Hose at 5'	H7215	6
6" 45° Y-Branch	G7353	6
4" 45° Elbow	G6167	6

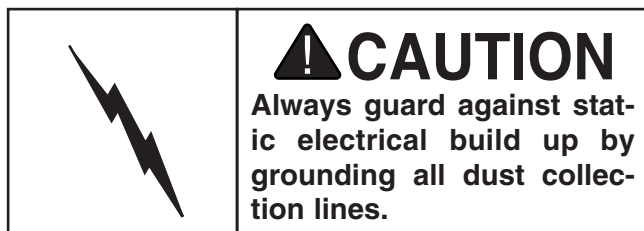


# System Grounding

Since plastic hose is abundant, relatively inexpensive, easily assembled and air tight, it is a very popular material for conveying dust from woodworking machines to the dust collector. We recommend using flexible hose (flex-hose) to connect the woodworking machine to the dust collector. However, plastic flex-hose and plastic duct are an insulator, and dust particles moving against the walls of the plastic duct create a static electrical build up. This charge will build until it discharges to a ground. If a grounding medium is not available to prevent static electrical build up, the electrical charge will arc to the nearest grounded source. This electrical discharge may cause an explosion and subsequent fire inside the system.

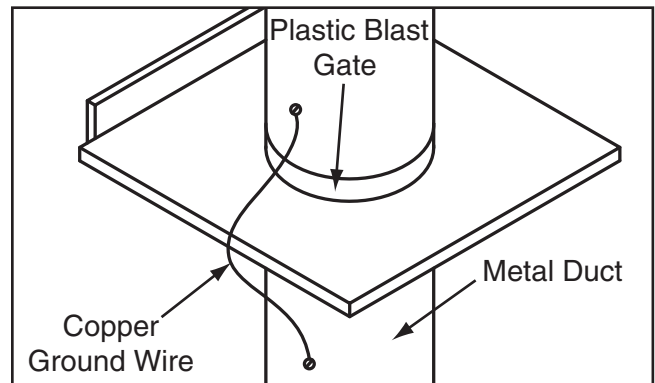
To protect against static electrical build up inside a non-conducting duct, a bare copper wire should be placed inside the duct along its length and grounded to the dust collector. You must also confirm that the dust collector is continuously grounded through the electrical circuit to the electric service panel.

If you connect the dust collector to more than one machine by way of a non-conducting branching duct system and blast gates, the system must still be grounded as mentioned above. We recommend inserting a continuous bare copper ground wire inside the entire duct system and attaching the wire to each grounded woodworking machine and dust collector.



Be sure that you extend the bare copper wire down all branches of the system. Do not forget to connect the wires to each other with wire nuts when two branches meet at a “Y” or “T” connection.

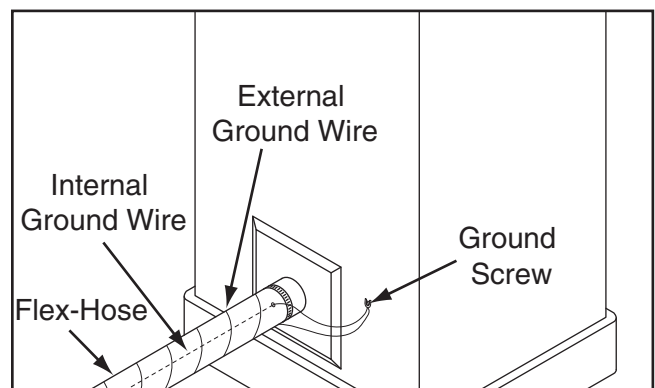
Ensure that the entire system is grounded. If using plastic blast gates to direct air flow, the grounding wire must be jumped (see the **Figure** below) around the blast gate without interruption to the grounding system.



**Figure 49.** Ground jumper wire when using plastic blast gates and metal duct.

We also recommend wrapping the outside of all plastic ducts with bare copper wire to ground the outside of the system against static electrical build up. Wire connections at Y’s and T’s should be made with wire nuts.

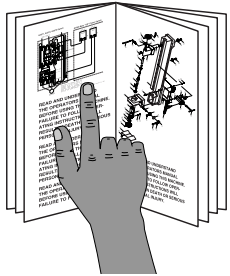
Attach the bare ground wire to each stationary woodworking machine and attach to the dust collector frame with a ground screw as shown in the **Figure** below. Ensure that each machine is continuously grounded to the grounding terminal in your electric service panel.



**Figure 50.** Flex-hose grounded to machine.

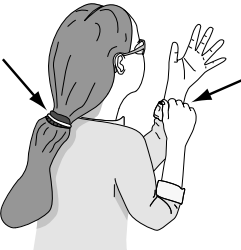


# SECTION 5: OPERATIONS



**!WARNING**  
To reduce the risk of serious injury when using this machine, read and understand this entire manual before beginning any operations.

**!WARNING**  
Damage to your eyes, lungs, and ears could result from using this machine without proper protective gear. Always wear safety glasses, a respirator, and hearing protection when operating this machine.



**!WARNING**  
Loose hair, clothing, or jewelry could get caught in machinery and cause serious personal injury. Keep these items away from moving parts at all times to reduce this risk.

**NOTICE**  
If you have never used this type of machine or equipment before, WE STRONGLY RECOMMEND that you read books, trade magazines, or get formal training before beginning any projects. Regardless of the content in this section, Grizzly Industrial will not be held liable for accidents caused by lack of training.

## Remote Control

The remote control for the Model G0443 is IR (infrared) rather than RF (radio frequency) to prevent accidental startups by other common RF items, such as garage door openers.

Because this remote system is IR, you must point the remote control directly at the switch to make it operate.

If you plan on placing your dust collector in a different room or outside of your shop, you must mount the switch in the shop and wire it through the wall to the dust collector to make use of the remote control.

## General

Operating the Model G0443 is simple and straightforward. Turn the dust collector **ON**, then turn the machine **ON**. When you are finished with the machine operation, turn **OFF** the machine, then turn **OFF** the dust collector.

Blast gates can be used at the start of each branch line to control the air flow from the woodworking machine to the dust collector. If a machine is not being used, keep the blast gate closed to maintain higher levels of efficiency throughout the system.



# SECTION 6: ACCESSORIES

## **⚠️ WARNING**

Some aftermarket accessories can be installed on this machine that could cause it to function improperly, increasing the risk of serious personal injury. To minimize this risk, only install accessories recommended for this machine by Grizzly.

## **NOTICE**

Refer to the newest copy of the Grizzly Catalog for other accessories available for this machine.

**Call 1-800-523-4777 To Order**

### **H7508—Stand for G0443**

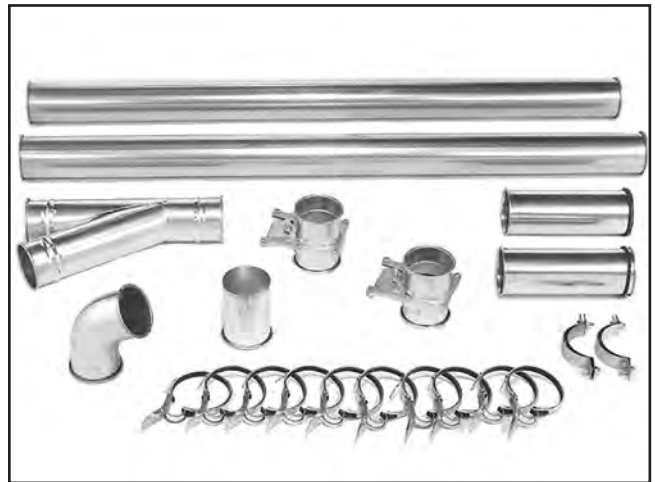
Mounting your dust collector to a stand expands your layout options, and helps protect the dust collector from getting banged up. Also greatly decreases overall noise and vibration that is an inherent part of wall mounting.



**Figure 51.** Cyclone mounted on stand.

### **H5294—4" Metal Duct Machine Addition Kit H5296—5" Metal Duct Machine Addition Kit H5298—6" Metal Duct Machine Addition Kit**

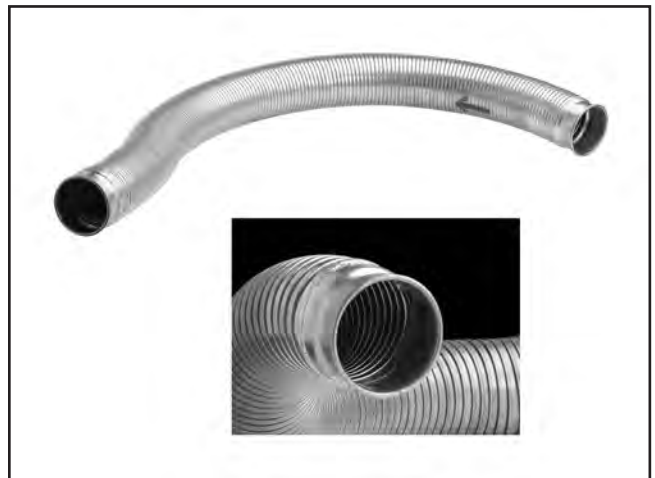
Save over 20% with this great machine addition kit. Includes: (2) blast gates, (1) machine adapter, (10) pipe clamps, (2) pipe hangers, (2) 5' straight pipes, (2) adjustable nipples, (1) branch, and (1) 60° elbow.



**Figure 52.** Metal Duct Machine Addition Kit.

### **H7215—4" x 5' Rigid Metal Flex Hose H7216—5" x 5' Rigid Metal Flex Hose H7217—6" x 5' Rigid Metal Flex Hose**

This flex hose provides just enough flexibility to make difficult connections while still keeping the inside wall as smooth as possible to minimize static pressure loss.



**Figure 53.** Rigid Metal Flex Hose.



- G6163—4" Clamp**
- G7343—5" Clamp**
- G7361—6" Clamp**

These clamps feature lever latches and foam seals, and secure around the rolled ends of fittings and pipe.



**Figure 54.** Dust collection pipe clamps.

- G2752—4" Rolling Floor Sweep**
- G2753—4" Bench Dust Collection Attachment**
- G2754—4" Floor Dust Collection Attachment**

These attachments are indispensable for collecting dust at machines without a port. The rolling floor sweep is also a convenient way to keep the shop floor or workbench top clean! Designed for use with 4" flexible hose (not included).



**Figure 55.** Dust collection attachments.

**H2443—Universal Adapter**

This seven step adapter provides a multitude of dust collection reducing options. Simply cut away unneeded steps with a hacksaw. Outside diameter step sizes include 1", 2", 2.5", 3", 4", 5", and 6". Wall thickness is 1/8".



**Figure 56.** H2443 Universal Adapter.

**G0572—Hanging Air Cleaner w/Remote**

Unfortunately, not even the best dust collection systems get all the dust. This is why it is extremely important to have one or two air cleaners to claim the fine dust suspended in the air. This model features a convenient remote control, three speeds, an automatic shutoff timer, and a 2-stage filter system (5 micron outer and 1 micron inner). Easily the best value in its class!



**Figure 57.** G0572 Hanging Air Cleaner.

**Call 1-800-523-4777 To Order**



# SECTION 7: MAINTENANCE



## Emptying Drum

Empty the collection drum when it is no more than  $\frac{3}{4}$  full. If the drum is overfilled, dust will be sucked into the inlet cylinder and pass through to the filter.

How quickly the drum will fill up is based on the type of work being done at that time.

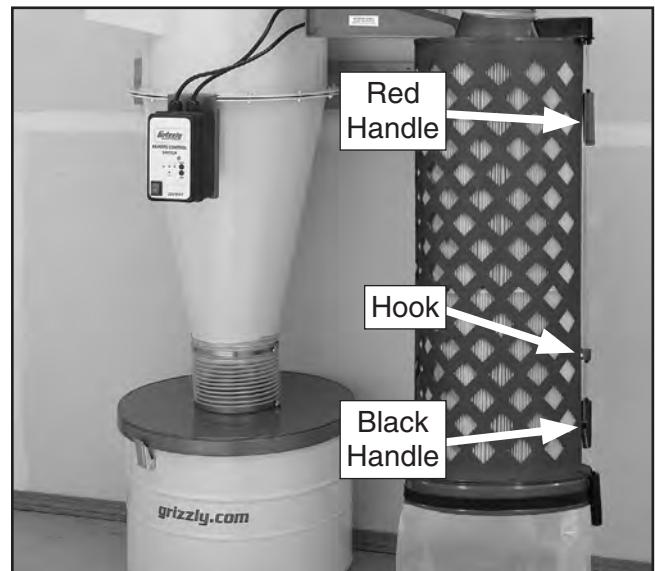
A machine that produces fine dust, such as a sander or table saw, will slowly fill the drum.

A machine that produces curly shavings, such as a planer or jointer, will quickly fill the drum.

In the beginning, check your drum regularly to get an idea of how often it needs to be emptied.

## Cleaning Filter

Your new cyclone dust collector has a gentle brush system inside the filter for cleaning. This brush system is controlled by the red and black handles shown in **Figure 58**.



**Figure 58.** Brush handles for cleaning the filter.

To clean the filter, simply pull the red handle down all the way, then pull the black handle down and hook it in place.

Always make sure to leave the red handle in the up position to ensure that the brushes return to their proper position and do not restrict the filter.

## Rinsing Filter

For a thorough cleaning, the filter can be removed and rinsed off. However, make sure to clean the filter with the brush system first. Allow the filter to air dry, but never leave the filter in the sun to dry or it could become damaged. Refer to **Removing/Replacing Filter** on **Page 37** for detailed instructions on removing the canister filter.



# Removing/Replacing Filter

The filter for canister filter assemblies manufactured since November, 2009, can be removed from the assembly so that it can be replaced or rinsed off (see the instructions in the next subsection).

Removing/installing the filter requires removing the canister filter assembly from the dust collector and disassembling it. Follow the instructions below to perform this procedure.

Refer to the parts breakdown diagrams and listings beginning on **Page 45** to order the correct filter from Grizzly at 800-523-4777.

<b>Tools Needed</b>	<b>Qty</b>
Open-End Wrench 10mm.....	1
Wrench or Socket 12mm.....	2

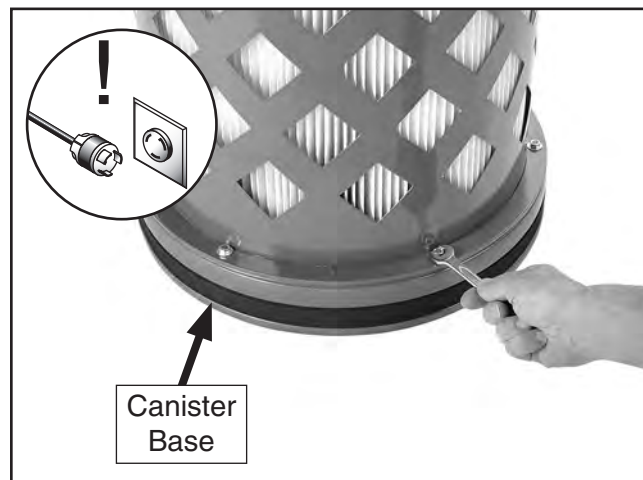
## To replace the canister filter:

1. DISCONNECT MACHINE FROM POWER!
2. Remove the bag clamp and collection bag from the canister assembly.
3. Pull the black handle all the way down and secure the cable into the handle hook at the bottom of the canister assembly, as shown in **Figure 59**, to hold it in place during the following steps.



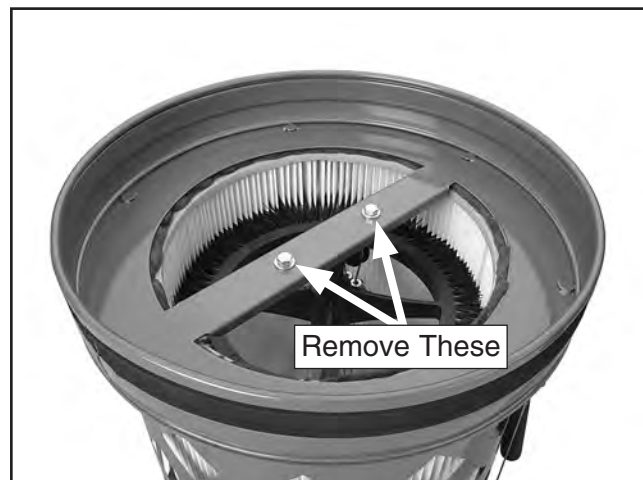
**Figure 59.** Black handle cable secured in the handle hook.

4. Remove the canister assembly from the dust collector and place it right-side up on a stable, flat surface.
5. Remove the six hex bolts, hex nuts, and flat washers from the rim of the canister base, as shown in **Figure 60**.



**Figure 60.** Removing the hex nuts and flat washers from the rim of the canister base.

6. With help from another person to steady the canister assembly, turn it upside down and remove the two hex bolts, hex nuts, and flat washers from the cross support (see **Figure 61**), then remove the canister base from the assembly.



**Figure 61.** Cross support fasteners.



7. Carefully lift the filter from the canister assembly, as shown in **Figure 62**.



**Figure 62.** Removing the filter from the canister assembly.

8. Before re-inserting a filter into the assembly, make sure that the filter brush base is aligned with two of the fastener holes around the base of the assembly (see **Figure 63**). This will allow the canister base to align with the fastener holes around the brush base.



**Figure 63.** Filter brush base aligned with assembly fastener holes.

9. Re-insert a filter into the canister assembly.

**Note:** Make sure the bristles of the brush are straight to ensure efficient cleaning of the filter when needed.

10. Re-attach the canister base in the reverse order that you removed it.
11. Re-attach the canister assembly to the dust collector, then re-install a fresh collection bag with the bag clamp.



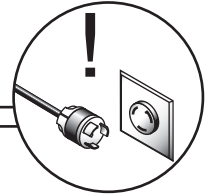


# SECTION 8: SERVICE

Review the troubleshooting and procedures in this section if a problem develops with your machine. If you need replacement parts or additional help with a procedure, call our Technical Support at (570) 546-9663.

**Note:** Please gather the serial number and manufacture date of your machine before calling.

## Troubleshooting



### Motor & Electrical

Symptom	Possible Cause	Possible Solution
Motor will not start, or it growls on start up.	<ol style="list-style-type: none"> <li>1. Power supply fuse or circuit breaker has tripped.</li> <li>2. Motor wired improperly.</li> <li>3. Motor fan cover is dented.</li> <li>4. Toggle switch is broken inside.</li> <li>5. Start capacitor is at fault.</li> <li>6. Motor is at fault.</li> </ol>	<ol style="list-style-type: none"> <li>1. Disconnect power, and inspect circuit for electrical shorts and repair; replace circuit breaker</li> <li>2. Rewire motor.</li> <li>3. Replace motor fan cover (and fan, if damaged).</li> <li>4. Disconnect power, and check/replace switch.</li> <li>5. Replace start capacitor.</li> <li>6. Replace motor.</li> </ol>
Motor runs slower than normal.	<ol style="list-style-type: none"> <li>1. Poor electrical connection.</li> <li>2. Low power source voltage.</li> <li>3. Motor is at fault.</li> </ol>	<ol style="list-style-type: none"> <li>1. Inspect the power supply for loose, corroded, or overheated electrical connections and repair.</li> <li>2. Have the power source voltage checked; reduce the length of extension cord.</li> <li>3. Replace the motor.</li> </ol>

### Operation

Symptom	Possible Cause	Possible Solution
Loud repetitious noise, or excessive vibration coming from dust collector.	<ol style="list-style-type: none"> <li>1. Dust collector is not on a flat surface and wobbles.</li> <li>2. Impeller fan is damaged and unbalanced.</li> <li>3. The motor mounting is loose.</li> <li>4. Impeller is loose on the motor shaft.</li> <li>5. Motor fan cover is dented, causing the motor fan to hit the cover while spinning.</li> </ol>	<ol style="list-style-type: none"> <li>1. Stabilize the dust collector.</li> <li>2. Unplug dust collector, and inspect the impeller for dents, bends, loose fins; replace.</li> <li>3. Re-tighten all fasteners on the dust collector.</li> <li>4. Replace the motor and impeller as a set if the motor shaft and the impeller hub is damaged.</li> <li>5. Replace motor fan cover.</li> </ol>



## Operation (continued)

Symptom	Possible Cause	Possible Solution
Dust collector does not adequately collect dust or chips; poor performance.	<ol style="list-style-type: none"> <li>1. Dust collection drum is full.</li> <li>2. Filter is dirty.</li> <li>3. Restriction in the duct line.</li> <li>4. The dust collector is too far away from the point of suction, or there are too many sharp bends in the ducting.</li> <li>5. The lumber is wet and not flowing through the dust lines smoothly.</li> <li>6. There is a leak in the ducting, or a series of small leaks, or too many open ports.</li> <li>7. There are not enough open branch lines at one time, thereby causing a velocity drop in the main line.</li> <li>8. The ducting and ports are incorrectly sized.</li> <li>9. The machine dust collection design is inadequate.</li> <li>10. The dust collector is too small for the dust collection system.</li> </ol>	<ol style="list-style-type: none"> <li>1. Empty collection drum.</li> <li>2. Clean filter.</li> <li>3. Remove dust line from dust collector inlet and unblock the restriction in the duct line. A plumbing snake may be necessary.</li> <li>4. Relocate the dust collector closer to the point of suction, and rework ducting without sharp bends. Refer to <i>System Design</i>, beginning on <b>Page 26</b>.</li> <li>5. Process lumber with less than 20% moisture content.</li> <li>6. Rework the ducting to eliminate all leaks. Close dust ports for lines not being used. Refer to <i>System Design</i> on <b>Page 26</b> for more solutions.</li> <li>7. Open 1 or 2 more blast gates to different branch lines to allow the velocity in the main line to increase.</li> <li>8. Re-install correctly sized ducts and fittings. Refer to <i>System Design</i> on <b>Page 26</b> for more solutions.</li> <li>9. Use a dust collection nozzle on a stand.</li> <li>10. Install a larger dust collector to power your dust collection system.</li> </ol>



# SECTION 9: WIRING

These pages are current at the time of printing. However, in the spirit of improvement, we may make changes to the electrical systems of future machines. Compare the manufacture date of your machine to the one stated in this manual, and study this section carefully.

If there are differences between your machine and what is shown in this section, call Technical Support at (570) 546-9663 for assistance BEFORE making any changes to the wiring on your machine. An updated wiring diagram may be available. **Note:** *Please gather the serial number and manufacture date of your machine before calling. This information can be found on the main machine label.*

## WARNING

### Wiring Safety Instructions

**SHOCK HAZARD.** Working on wiring that is connected to a power source is extremely dangerous. Touching electrified parts will result in personal injury including but not limited to severe burns, electrocution, or death. Disconnect the power from the machine before servicing electrical components!

**MODIFICATIONS.** Modifying the wiring beyond what is shown in the diagram may lead to unpredictable results, including serious injury or fire. This includes the installation of unapproved after-market parts.

**WIRE CONNECTIONS.** All connections must be tight to prevent wires from loosening during machine operation. Double-check all wires disconnected or connected during any wiring task to ensure tight connections.

**CIRCUIT REQUIREMENTS.** You MUST follow the requirements at the beginning of this manual when connecting your machine to a power source.

**WIRE/COMPONENT DAMAGE.** Damaged wires or components increase the risk of serious personal injury, fire, or machine damage. If you notice that any wires or components are damaged while performing a wiring task, replace those wires or components.

**MOTOR WIRING.** The motor wiring shown in these diagrams is current at the time of printing but may not match your machine. If you find this to be the case, use the wiring diagram inside the motor junction box.









**CAPACITORS/INVERTERS.** Some capacitors and power inverters store an electrical charge for up to 10 minutes after being disconnected from the power source. To reduce the risk of being shocked, wait at least this long before working on capacitors.

**EXPERIENCING DIFFICULTIES.** If you are experiencing difficulties understanding the information included in this section, contact our Technical Support at (570) 546-9663.

#### NOTICE

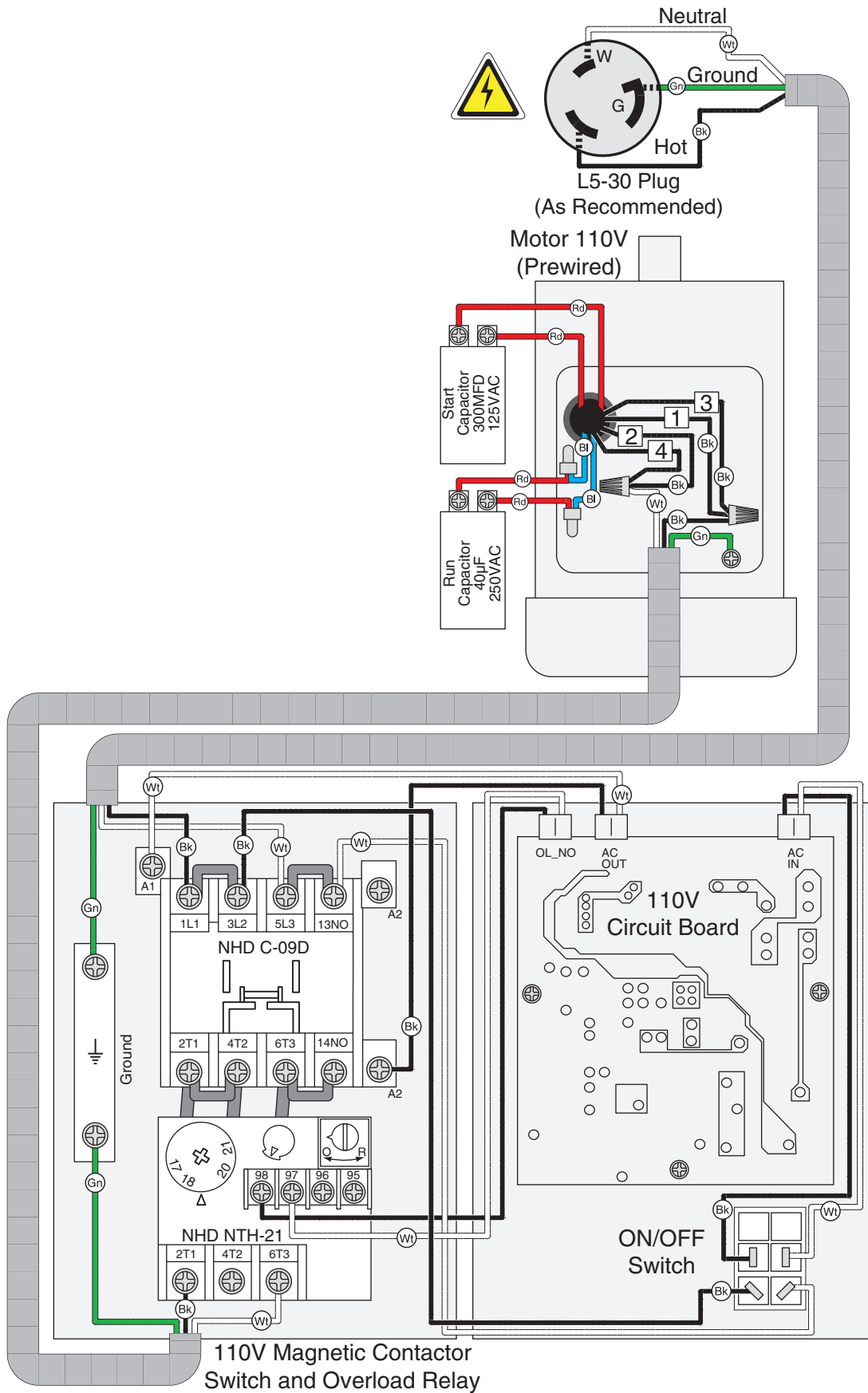
The photos and diagrams included in this section are best viewed in color. You can view these pages in color at [www.grizzly.com](http://www.grizzly.com).

#### COLOR KEY

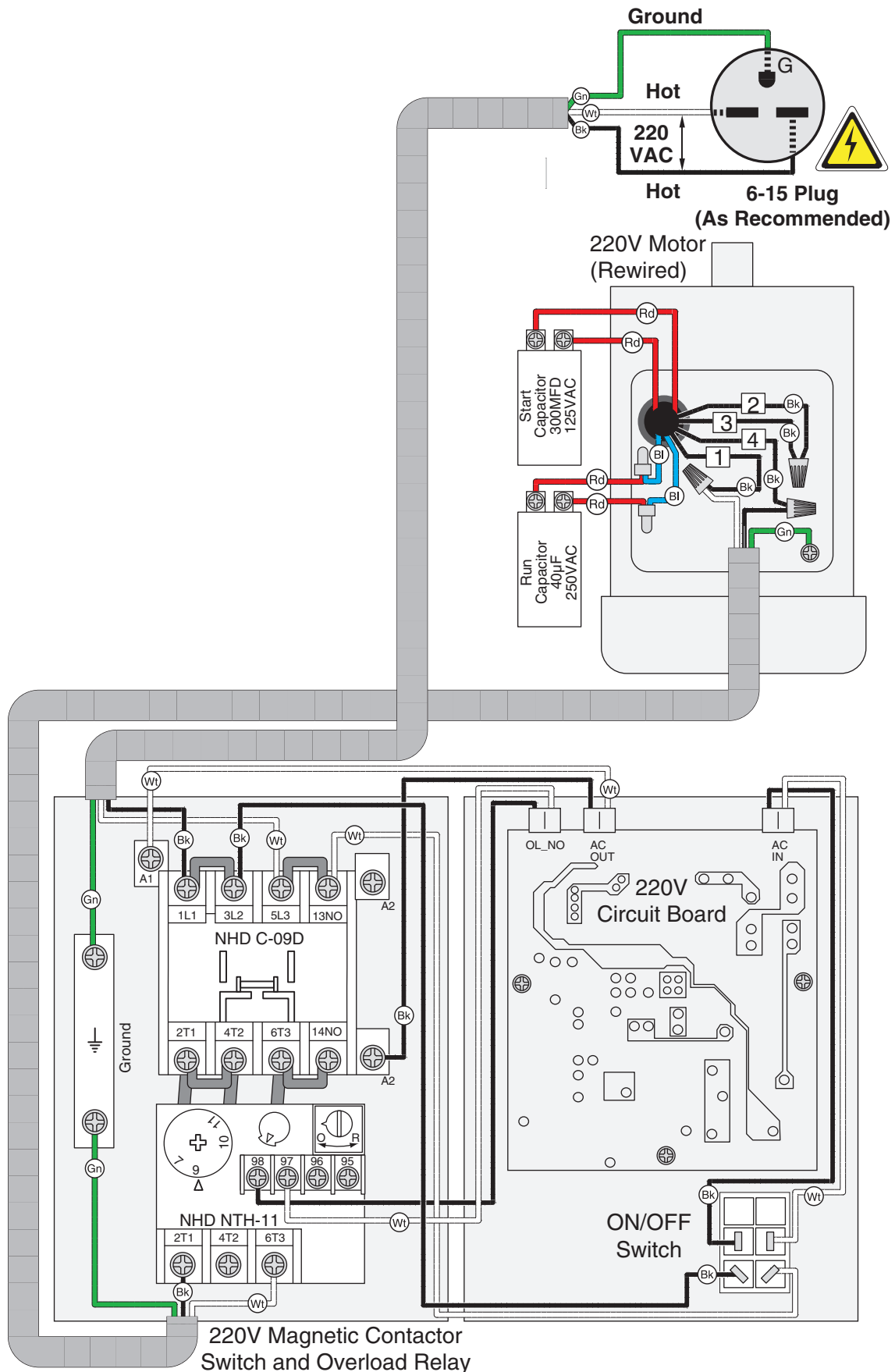
BLACK		BLUE		YELLOW		LIGHT BLUE	
WHITE		BROWN		YELLOW GREEN		BLUE WHITE	
GREEN		GRAY		PURPLE		TURQUOISE	
RED		ORANGE		PINK			



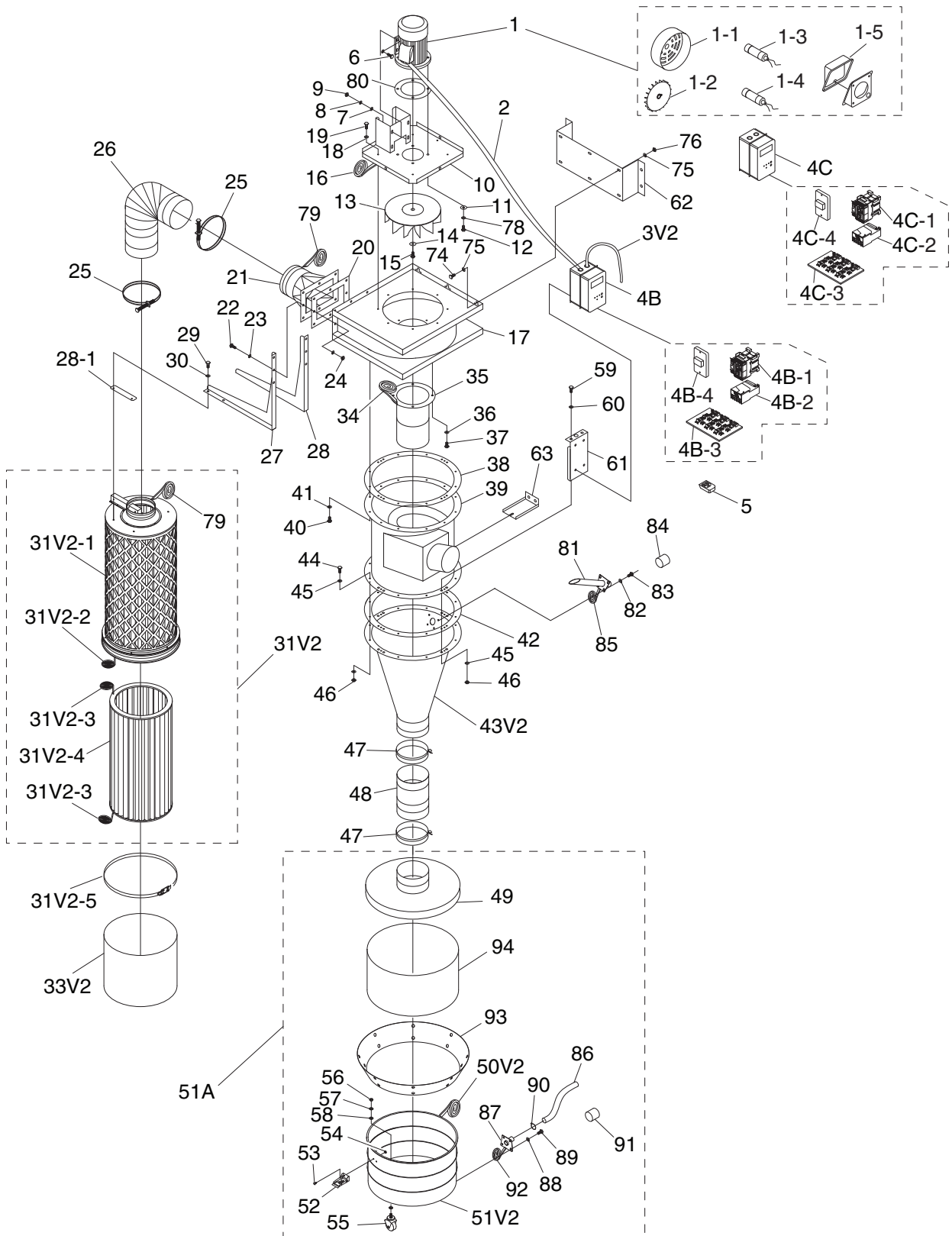
# 110V (Prewired) Wiring Diagram



# 220V (Rewired) Wiring Diagram



# SECTION 10: PARTS



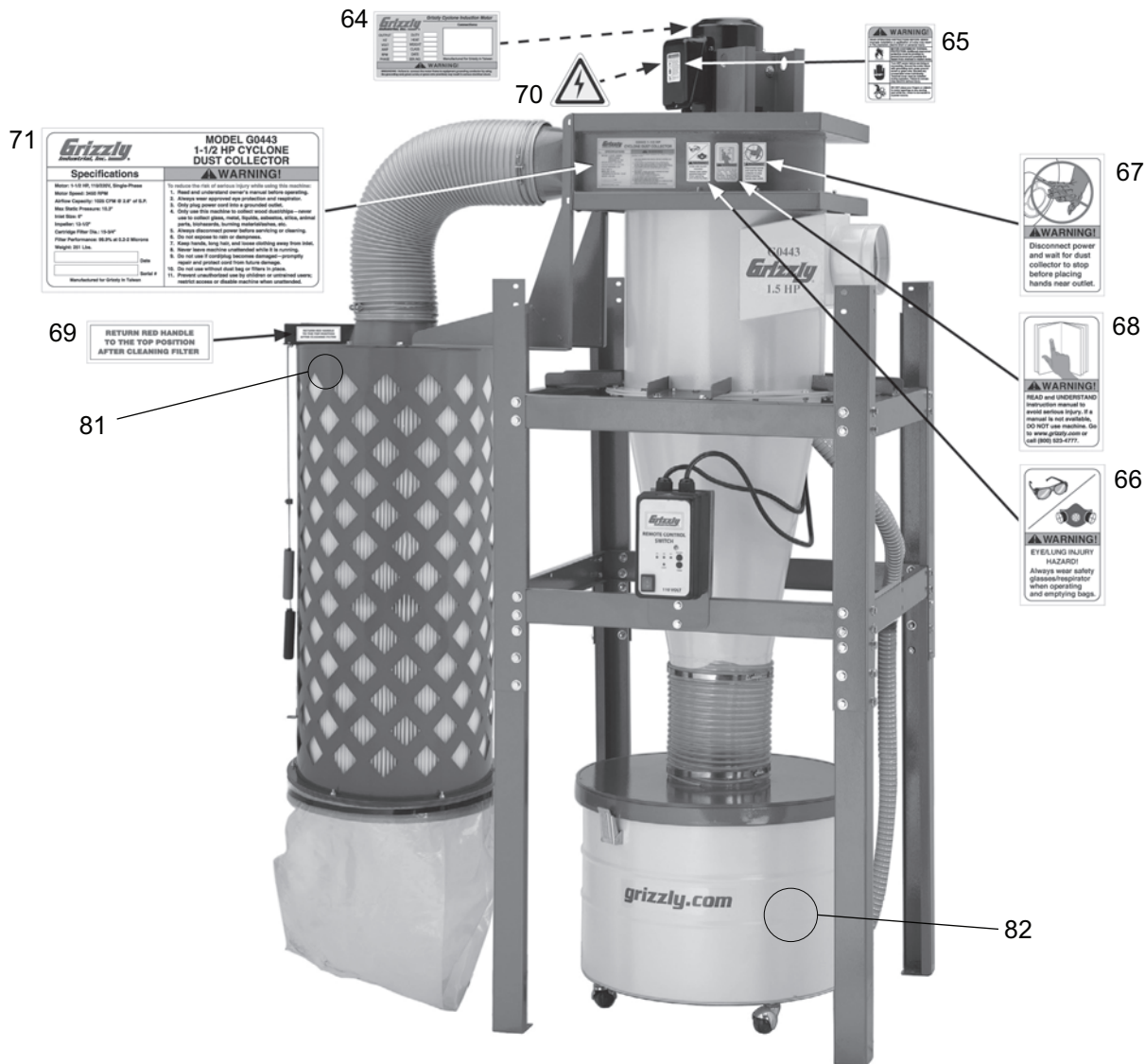
# Main Parts List

Ref	Part #	Description
1	P0443001	MOTOR 1.5HP 110/220V 1PH
1-1	P0443001-1	MOTOR FAN COVER
1-2	P0443001-2	MOTOR FAN
1-3	PC300B	S CAPACITOR 300MFD 125V 1-3/4 X 3-3/8
1-4	PC040A	R CAPACITOR 40MFD 250V 1-3/8 X 2-3/4
1-5	P0443001-5	JUNCTION BOX
2	P0440002	MOTOR CORD 12G 3C
3V2	P0440075	POWER CORD 12AWG 3C V2.08.10
4B	P0443004B	REMOTE MAG SWITCH 110V V2.02.06
4B-1	P0443004B-1	CONTACTOR NHD C-09D 110V
4B-2	P0443004B-2	OL RELAY NHD NTH-21 17-21A
4B-3	P0443004B-3	CIRCUIT BOARD 110V
4B-4	P0443004B-4	ON/OFF SWITCH 110/220V
4C	P0443004C	REMOTE MAG SWITCH 220V V2.02.06
4C-1	P0443004C-1	CONTACTOR NHD C-09D 220V
4C-2	P0443004C-2	OL RELAY NHD NTH-11 8-11A
4C-3	P0443004C-3	CIRCUIT BOARD 220V
4C-4	P0443004B-4	ON/OFF SWITCH 110/220V
5	P0443005	REMOTE CONTROLLER
6	PB24	HEX BOLT 3/8-16 X 1-1/4
7	PW02	FLAT WASHER 3/8
8	PLW04	LOCK WASHER 3/8
9	PN08	HEX NUT 3/8"-16
10	P0443010	BLOWER COVER
11	PWF01	FENDER WASHER 5/16
12	PB03	HEX BOLT 5/16-18 X 1
13	P0443013	IMPELLER 12-1/2"
14	P0443014	IMPELLER FENDER WASHER 5/16
15	PB07	HEX BOLT 5/16-18 X 3/4
16	P0443016	FOAM TAPE 3 X 6 X 1800MM
17	P0443017	BLOWER HOUSING
18	PW07	FLAT WASHER 5/16
19	PB07	HEX BOLT 5/16-18 X 3/4
20	P0443020	OUTLET GASKET 206 X 206MM
21	P0443021	INTAKE
22	PB03	HEX BOLT 5/16-18 X 1
23	PW07	FLAT WASHER 5/16
24	PN02	HEX NUT 5/16"-18
25	P0443025	HOSE CLAMP 7"
26	P0440027	GRAY FLEX PIPE 7" x 800MM
27	P0440029	RIGHT FILTER L-BRACE
28	P0440028	LEFT FILTER L-BRACE
28-1	P0440028-1	BRACE GASKET 155 X 37MM
29	PB07	HEX BOLT 5/16-18 X 3/4
30	PW07	FLAT WASHER 5/16
31V2	P0440032V2	CANISTER FILTER ASSEMBLY V2.11.09
31V2-1	P0440032V2-1	CANISTER FILTER CAGE ASSY V2.11.09
31V2-2	P0440032V2-2	FOAM TAPE 3 X 25 X 1400MM V2.11.09
31V2-3	P0440032V2-3	FOAM TAPE 38 X 35 X 1255MM V2.11.09
31V2-4	P0440032V2-4	CANISTER FILTER 386MM V2.11.09
31V2-5	P0440032V2-5	BAG CLAMP 445MM V2.11.09
33V2	P0440034V2	PLASTIC BAG 470 X 600MM V2.11.09

Ref	Part #	Description
34	P0443016	FOAM TAPE 3 X 6 X 1800MM
35	P0443035	INTAKE CYCLINDER 9"
36	PW07	FLAT WASHER 5/16
37	PB07	HEX BOLT 5/16-18 X 3/4
38	P0443038	BARREL GASKET 534MM DIA.
39	P0443039	INTAKE BARREL 18"
40	PB07	HEX BOLT 5/16-18 X 3/4
41	PW07	FLAT WASHER 5/16
42	P0443038	BARREL GASKET 534MM DIA.
43V2	P0443043V2	CYCLONE FUNNEL 18" V2.08.10
44	PB03	HEX BOLT 5/16-18 X 1
45	PW07	FLAT WASHER 5/16
46	PN02	HEX NUT 5/16"-18
47	P0440048	HOSE CLAMP 9"
48	P0443048	CLEAR FLEX PIPE 9" X 260MM
49	P0440050	COLLECTION DRUM LID V2.08.06
50V2	P0440051V2	DRUM SEAL TYPE-T 2.1M V2.11.09
51A	P0440052A	COLLECTION DRUM ASSEMBLY
51V2	P0440052V2	COLLECTION DRUM 35GAL V2.08.10
52	P0443052	DRUM LID LATCH
53	PS06	PHLP HD SCR 10-24 X 3/8
54	PN07	HEX NUT 10-24
55	P0440056	CASTER 2"
56	PN08	HEX NUT 3/8"-16
57	PLW04	LOCK WASHER 3/8
58	PW02	FLAT WASHER 3/8
59	PB03	HEX BOLT 5/16-18 X 1
60	PW07	FLAT WASHER 5/16
61	P0443061	SWITCH MOUNTING BRACKET
62	P0443062	WALL MOUNTING BRACKET
63	P0443063	WALL MOUNTING BRACE
74	PB18	HEX BOLT 3/8-16 X 1
75	PW02	FLAT WASHER 3/8
76	PN08	HEX NUT 3/8-16
78	PTLW02	EXT TOOTH WASHER 5/16
79	P0440079	FOAM TAPE 3 X 15 X 600MM
80	P0443080	MOTOR MOUNT GASKET
81	P0440080	CYCLONE VACUUM TUBE
82	PW07	FLAT WASHER 5/16
83	PB07	HEX BOLT 5/16-18 X 3/4
84	P0440083	TUBE PLUG 1-1/4"
85	P0440084	FOAM TAPE 3 X 6 X 300MM
86	P0440085	VACUUM HOSE 1-1/4" X 98"
87	P0440086	COLLECTION DRUM VACUUM TUBE
88	PW07	FLAT WASHER 5/16
89	PB07	HEX BOLT 5/16-18 X 3/4
90	P0440089	HOSE CLAMP 1-1/4"
91	P0440083	TUBE PLUG 1-1/4"
92	P0440084	FOAM TAPE 3 X 6 X 300MM
93	P0440092	COLLECTION DRUM VACUUM RING
94	P0440093	DRUM COLLECTION BAG 640 X 1000MM



# Labels



Ref	Part #	Description
64	P0443064	MOTOR SPEC LABEL
65	P0442093	MOTOR WARNING LABEL
66	PLABEL-82	GLASSES/RESPIRATOR DC LABEL
67	PLABEL-59	HANDS/INLET LABEL
68	PLABEL-12	READ MANUAL 2W X 3.3H

Ref	Part #	Description
69	P0442097	RETURN RED HANDLE LABEL
70	PLABEL-14	ELECTRICITY 1.4W X 1.2H
71	P0443071	MACHINE ID LABEL
81	PPAINT-1	GRIZZLY GREEN TOUCH UP PAINT
82	PPAINT-11	GRIZZLY PUTTY TOUCH UP PAINT

## WARNING

Safety labels help reduce the risk of serious injury caused by machine hazards. If any label comes off or becomes unreadable, the owner of this machine **MUST** replace it in the original location before resuming operations. For replacements, contact (800) 523-4777 or [www.grizzly.com](http://www.grizzly.com).







# WARRANTY CARD

Name \_\_\_\_\_  
 Street \_\_\_\_\_  
 City \_\_\_\_\_ State \_\_\_\_\_ Zip \_\_\_\_\_  
 Phone # \_\_\_\_\_ Email \_\_\_\_\_ Invoice # \_\_\_\_\_  
 Model # \_\_\_\_\_ Order # \_\_\_\_\_ Serial # \_\_\_\_\_

The following information is given on a voluntary basis. It will be used for marketing purposes to help us develop better products and services. **Of course, all information is strictly confidential.**

1. How did you learn about us?

Advertisement       Friend       Catalog  
 Card Deck       Website       Other:

2. Which of the following magazines do you subscribe to?

<input type="checkbox"/> Cabinetmaker & FDM	<input type="checkbox"/> Popular Science	<input type="checkbox"/> Wooden Boat
<input type="checkbox"/> Family Handyman	<input type="checkbox"/> Popular Woodworking	<input type="checkbox"/> Woodshop News
<input type="checkbox"/> Hand Loader	<input type="checkbox"/> Precision Shooter	<input type="checkbox"/> Woodsmith
<input type="checkbox"/> Handy	<input type="checkbox"/> Projects in Metal	<input type="checkbox"/> Woodwork
<input type="checkbox"/> Home Shop Machinist	<input type="checkbox"/> RC Modeler	<input type="checkbox"/> Woodworker West
<input type="checkbox"/> Journal of Light Cont.	<input type="checkbox"/> Rifle	<input type="checkbox"/> Woodworker's Journal
<input type="checkbox"/> Live Steam	<input type="checkbox"/> Shop Notes	<input type="checkbox"/> Other:
<input type="checkbox"/> Model Airplane News	<input type="checkbox"/> Shotgun News	
<input type="checkbox"/> Old House Journal	<input type="checkbox"/> Today's Homeowner	
<input type="checkbox"/> Popular Mechanics	<input type="checkbox"/> Wood	

3. What is your annual household income?

\$20,000-\$29,000       \$30,000-\$39,000       \$40,000-\$49,000  
 \$50,000-\$59,000       \$60,000-\$69,000       \$70,000+

4. What is your age group?

20-29       30-39       40-49  
 50-59       60-69       70+

5. How long have you been a woodworker/metalworker?

0-2 Years       2-8 Years       8-20 Years       20+ Years

6. How many of your machines or tools are Grizzly?

0-2       3-5       6-9       10+

7. Do you think your machine represents a good value?       Yes       No

8. Would you recommend Grizzly Industrial to a friend?       Yes       No

9. Would you allow us to use your name as a reference for Grizzly customers in your area?

**Note:** We never use names more than 3 times.       Yes       No

10. Comments: \_\_\_\_\_  
 \_\_\_\_\_  
 \_\_\_\_\_

CUT ALONG DOTTED LINE



FOLD ALONG DOTTED LINE

\_\_\_\_\_  
\_\_\_\_\_  
\_\_\_\_\_



Place  
Stamp  
Here



**GRIZZLY INDUSTRIAL, INC.**  
P.O. BOX 2069  
BELLINGHAM, WA 98227-2069



FOLD ALONG DOTTED LINE

Send a Grizzly Catalog to a friend:

Name \_\_\_\_\_  
Street \_\_\_\_\_  
City \_\_\_\_\_ State \_\_\_\_\_ Zip \_\_\_\_\_

TAPE ALONG EDGES--PLEASE DO NOT STAPLE

# WARRANTY & RETURNS

---

---

Grizzly Industrial, Inc. warrants every product it sells for a period of **1 year** to the original purchaser from the date of purchase. This warranty does not apply to defects due directly or indirectly to misuse, abuse, negligence, accidents, repairs or alterations or lack of maintenance. This is Grizzly's sole written warranty and any and all warranties that may be implied by law, including any merchantability or fitness, for any particular purpose, are hereby limited to the duration of this written warranty. We do not warrant or represent that the merchandise complies with the provisions of any law or acts unless the manufacturer so warrants. In no event shall Grizzly's liability under this warranty exceed the purchase price paid for the product and any legal actions brought against Grizzly shall be tried in the State of Washington, County of Whatcom.

We shall in no event be liable for death, injuries to persons or property or for incidental, contingent, special, or consequential damages arising from the use of our products.

To take advantage of this warranty, contact us by mail or phone and give us all the details. We will then issue you a "Return Number," which must be clearly posted on the outside as well as the inside of the carton. We will not accept any item back without this number. Proof of purchase must accompany the merchandise.

The manufacturers reserve the right to change specifications at any time because they constantly strive to achieve better quality equipment. We make every effort to ensure that our products meet high quality and durability standards and we hope you never need to use this warranty.

Please feel free to write or call us if you have any questions about the machine or the manual.

Thank you again for your business and continued support. We hope to serve you again soon.

# *grizzly.com*<sup>®</sup>

**TOOL WEBSITE**

Buy Direct and Save with Grizzly<sup>®</sup> – Trusted, Proven and a Great Value!  
~Since 1983~

*Visit Our Website Today For  
Current Specials!*

**ORDER  
24 HOURS A DAY!  
1-800-523-4777**



## Free Manuals Download Website

<http://myh66.com>

<http://usermanuals.us>

<http://www.somanuals.com>

<http://www.4manuals.cc>

<http://www.manual-lib.com>

<http://www.404manual.com>

<http://www.luxmanual.com>

<http://aubethermostatmanual.com>

Golf course search by state

<http://golfingnear.com>

Email search by domain

<http://emailbydomain.com>

Auto manuals search

<http://auto.somanuals.com>

TV manuals search

<http://tv.somanuals.com>