

Grizzly **Industrial, Inc.**®

MODEL T10458 **SOPRANO UKULELE KIT** **INSTRUCTION MANUAL** *(For models manufactured since 10/11)*

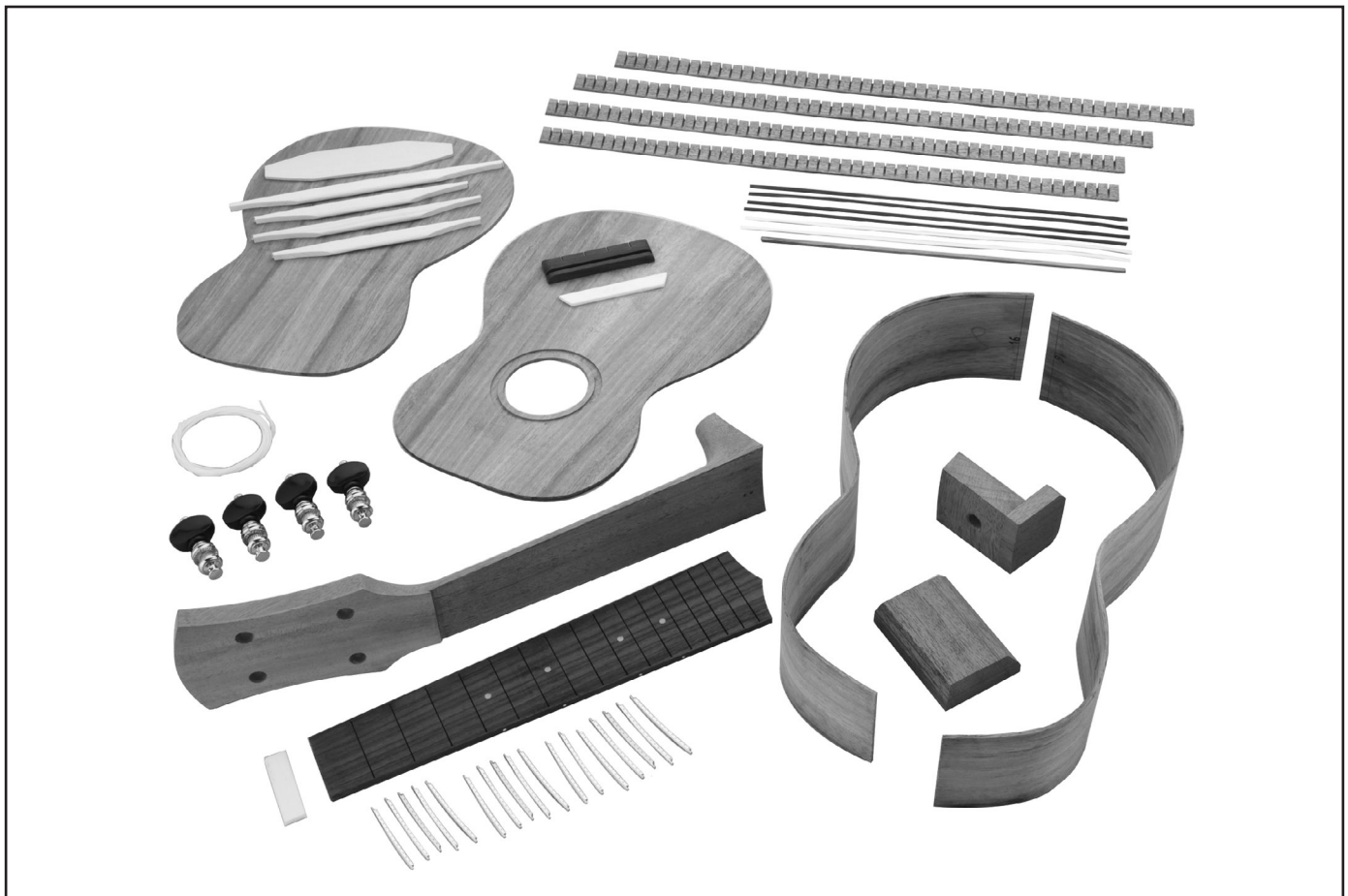

COPYRIGHT © JANUARY, 2012 BY GRIZZLY INDUSTRIAL, INC.
**WARNING: NO PORTION OF THIS MANUAL MAY BE REPRODUCED IN ANY SHAPE
OR FORM WITHOUT THE WRITTEN APPROVAL OF GRIZZLY INDUSTRIAL, INC.**
#KN14356 PRINTED IN JAPAN



WARNING!

Some dust created by power sanding, sawing, grinding, drilling, and other construction activities contains chemicals known to the State of California to cause cancer, birth defects or other reproductive harm. Some examples of these chemicals are:

- **Lead from lead-based paints.**
- **Crystalline silica from bricks, cement and other masonry products.**
- **Arsenic and chromium from chemically-treated lumber.**

Your risk from these exposures varies, depending on how often you do this type of work. To reduce your exposure to these chemicals: Work in a well ventilated area, and work with approved safety equipment, such as those dust masks that are specially designed to filter out microscopic particles.

Table of Contents

SAFETY	2
INTRODUCTION.....	3
Manual Accuracy.....	3
Identification	3
Contact Info.....	3
PARTS INVENTORY	4
ASSEMBLY	5
Supplies/Tools.....	5
Before Starting	5
Assembling Sides & Blocks.....	6
Installing Purfling.....	7
Attaching Braces	8
Attaching Kerfing.....	10
Assembling Body.....	11
Installing Frets.....	12
Attaching Neck to Ukulele Body.....	13
Sanding	14
Ukulele Body	14
Neck	14
Fingerboard	14
Bridge	14
Attaching Fingerboard	15
Determining	15
Bridge/Nut Location.....	15
Preparing to Finish.....	16
Painting/Finishing	16
Attaching Bridge.....	17
Setting String Height	18
Installing Tuning Peg.....	19
Installing Strings.....	19
Tuning	20
AFTERMARKET ACCESSORIES.....	20



SAFETY

WARNING

Always wear safety glasses or goggles when operating equipment. Everyday glasses or reading glasses are not safety glasses. Be certain the safety glasses you wear meet the appropriate standards of the American National Standards Institute (ANSI).

Because there are various ways to cut and join wood, you can make substitutions for the methods stated in this plan. We try to suggest the easiest methods possible. However, only you know your skills with each piece of machinery. Never compromise your safety by using a cutting method with which you are not comfortable. Instead, find an alternative approach that will yield the same result.

WARNING

These instructions assume that you are intimately familiar with the safe operation and use of woodworking machinery and woodworking tools, and understand the techniques used to reproduce this project. If you do not qualify for both of these criteria, **STOP building this project for your own safety.** Read and understand the owner's manual for the machinery you intend to use, take a woodworking class, or visit your local library for more information. Woodworking machinery and tools are inherently dangerous, because they use sharp edges that can and will cause serious personal injury including amputation and death. Do not underestimate the ability of these tools and machinery to cause injury. Never operate any tool without all guards in place and always wear approved safety glasses. For your own safety, please heed this warning.



INTRODUCTION

Manual Accuracy

We are proud to offer the Model T10458 Soprano Ukulele Kit. We've made every effort to be exact with the instructions, specifications, drawings, and photographs of the kit we assembled when writing this manual. However, sometimes we still make an occasional mistake.

We are pleased to provide this manual with this kit. It was written to review safety considerations guide you through assembly, and cover general information. It represents our effort to produce the best documentation possible.

For your convenience, we post all available documentation on our website at www.grizzly.com. Any updates to this product will be reflected in these manuals as soon as they are complete.

Contact Info

We stand behind our products. If you have any questions or parts requests, please call or write us at the location listed below.

Grizzly Industrial, Inc.
1203 Lycoming Mall Circle
Muncy, PA 17756
Phone: (570) 546-9663
Fax: (800) 438-5901
E-Mail: techsupport@grizzly.com
Web Site: <http://www.grizzly.com>

We want your feedback on this manual. What did you like about it. Where could it be improved? Please take a few minutes to give us feedback.

Grizzly Documentation Manager
P.O. Box 2069
Bellingham, WA 98227-2060
Email: manuals@grizzly.com

Identification

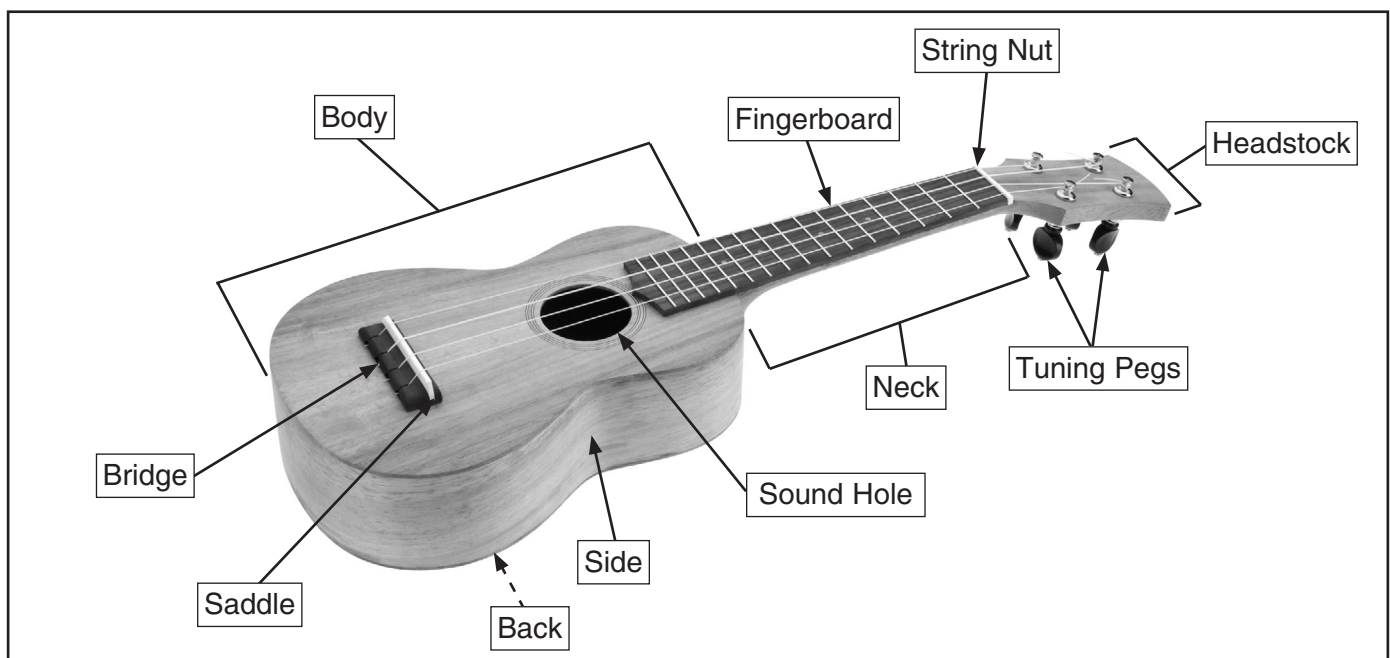

Figure 1. Ukulele identification.



PARTS INVENTORY

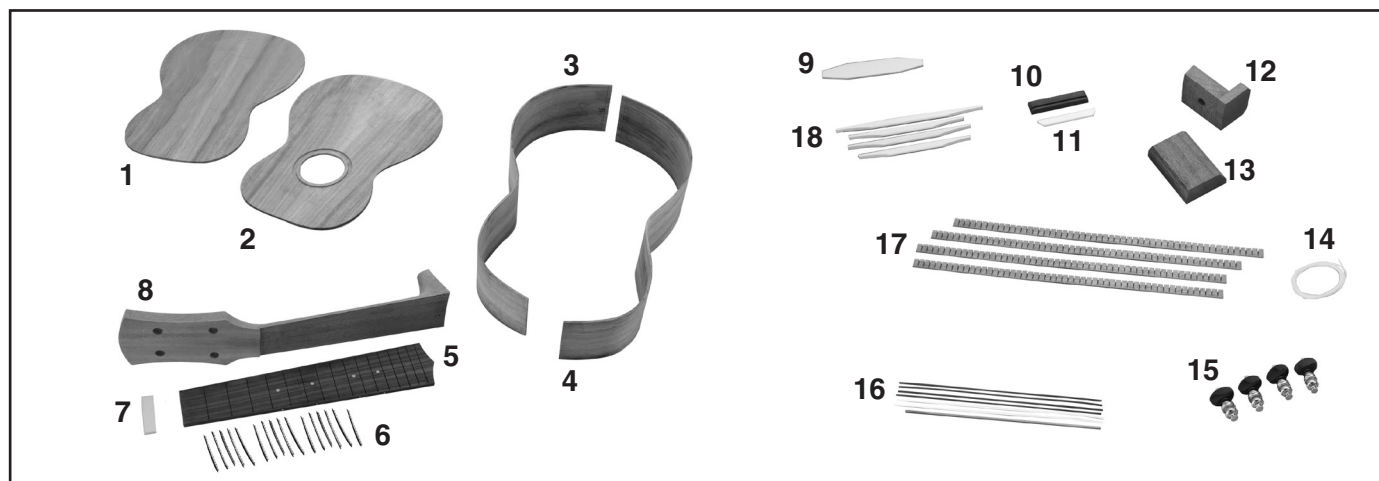

Figure 2. Parts Identification.

REF	PART#	DESCRIPTION	QTY
1	PT10458001	BACK	1
2	PT10458002	SOUND BOARD	1
3	PT10458003	RIGHT SIDE	1
4	PT10458004	LEFT SIDE	1
5	PT10458005	FINGERBOARD	1
6	PT10458006	FRET SET 16PC	1
7	PT10458007	STRING NUT	1
8	PT10458008	NECK	1
9	PT10458009	BRIDGE PLATE	1
10	PT10458010	BRIDGE ROSEWOOD	1
11	PT10458011	SADDLE	1
12	PT10458012	NECK BLOCK	1
13	PT10458013	TAIL BLOCK	1
14	PT10458014	UKULELE STRINGS NYLON 4PC SET	1
15	PT10458015	TUNERS 4PC	1
16	PT10458016	PURFLING SET 7PC	1
17	PT10458017	KERFING TRIANGLE-MAH 15" 4PC	1
18	PT10458018	BRACE SET*	1

*Brace Set includes 1 each of the following:

- Sound Board Brace $5\frac{1}{2}" \times 1\frac{13}{32}" \times \frac{3}{16}"$
- Sound Board Brace $4\frac{29}{32}" \times 1\frac{13}{32}" \times \frac{3}{16}"$
- Back Brace $6\frac{7}{8}" \times 1\frac{13}{32}" \times \frac{3}{16}"$
- Back Brace $5\frac{5}{16}" \times 1\frac{13}{32}" \times \frac{3}{16}"$



ASSEMBLY

Supplies/Tools

The majority of the wooden components in this kit are fully machined at the factory and are ready for assembly. A small amount of drilling, sanding, and light machining will be required to complete the ukulele.

Recommended Tools & Supplies:

- Wood Glue
- Finishing Supplies
- Wood Putty
- Rubber Bands
- Sandpaper #180, #240, #320, and #600
- Sanding Block
- Masking Tape
- Razor Blade
- 1/4" or 1/2" Chisel
- Coat Hanger
- Clamps
- Drill Bit Set
- Tack Cloth
- Coping, Jig, or Scroll Saw (Optional)
- Nippers or Fret Cutters
- Straightedge (16" min.)
- NIOSH-Approved Respirator
- ANSI-Approved Safety Glasses

Before Starting

Read this manual completely before starting the construction process. This will familiarize you with the parts of the ukulele used in construction, the specific procedures you will perform, the tools needed, and the time required.

During construction, we recommend trial-fitting before gluing components together. This provides the opportunity to fit items and correct any issues. It also helps minimize the amount of clean up necessary after gluing parts together. *ALWAYS* let glue set for the manufacturer's recommended time.

While this manual is meant to guide you through the complete construction process, we recommend that you refer to literature, expert advice, and other resources for further information.



Assembling Sides & Blocks

Assembling the sides and blocks requires measuring and cutting the sides to the proper length, transferring marks onto the sides, and gluing the neck and tail blocks into place. The tail and neck blocks provide structure for the sound board, back, sides, and neck of the ukulele.

To attach the tail and neck block to the sides:

1. Draw centerlines all the way around the tail and neck blocks (see **Figure 3**).

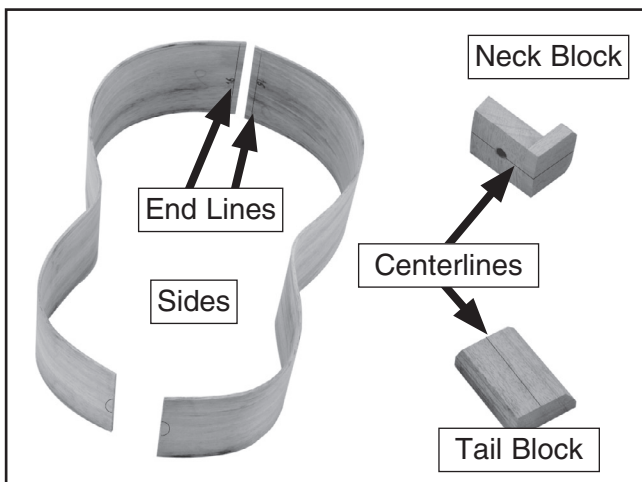

Figure 3. Tail and neck block with centerlines and sides with factory layout lines.

2. The sides have end lines that have been scribed on them at the factory. Use a marking knife to incise the lines.

Note: To reduce the chance of tear out occurring, incise the scribed lines with a marking knife before proceeding. Cut slowly, especially when starting and finishing the cuts.

3. Using a fine tooth saw trim both ends of both sides.
4. Position the neck block and left side so the block center-line aligns with the end of the side.

5. Mark the peg hole on the outside of the sides at the neck block by lining up the blocks with the sound board and back layout lines and making a hole mark (see **Figure 4**).

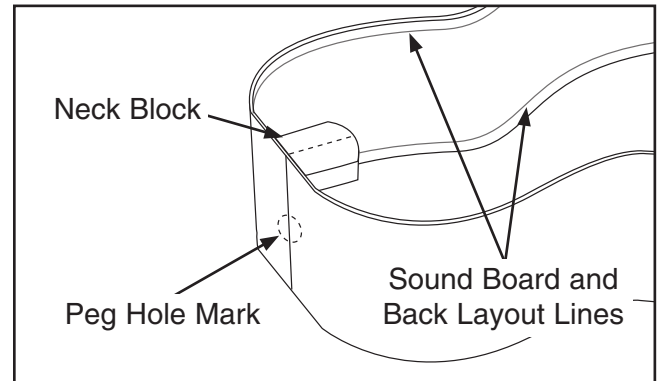

Figure 4. Illustration of hole markings transferred to sides at neck block.

Note: The tail and neck block should be flush with the sound board and back layout lines. This leaves extra material above the lines that will be sanded flush later in construction.

6. Ensure that all marks accurately line up, as shown in **Figure 5**.

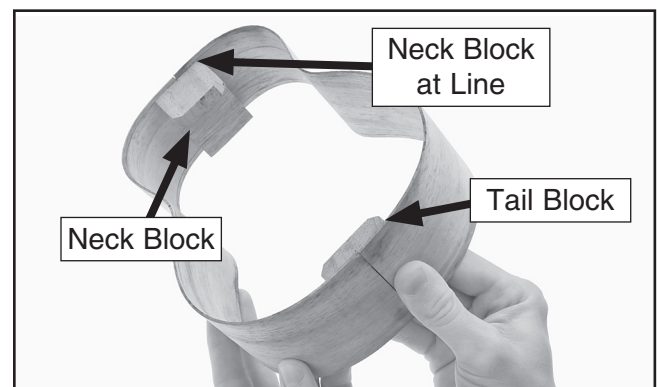

Figure 5. Lining up marks for the tail block before clamping and gluing.

7. Glue and clamp the side to the neck block.
8. Before the glue fully hardens (after about an hour), use a chisel to scrape away any squeezed-out glue from the side.
9. Repeat **Steps 3–6** for the other side.



10. Glue and clamp the tail block to the sides, as shown in **Figure 6**.

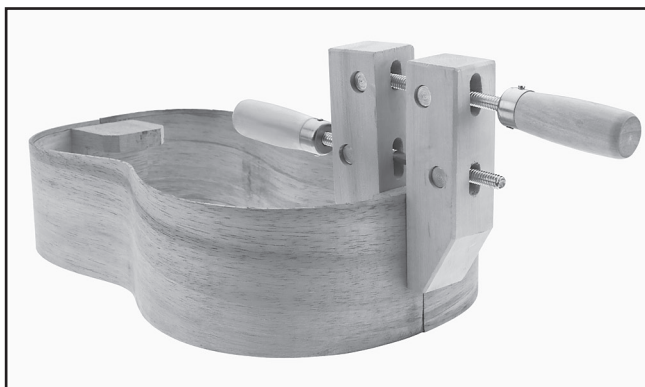

Figure 6. Clamping and gluing the tail block in place.

Installing Purfling

The sound board comes pre-cut with a $\frac{5}{32}$ " dado around the sound hole for decorating. The purfling material includes one mahogany strip and six strips of plastic. It is supplied long and will need to be arranged, measured, and cut. Arrange the purfling as desired to customize the ukulele. Select a purfling pattern that suits you. **Figure 7** shows an example.

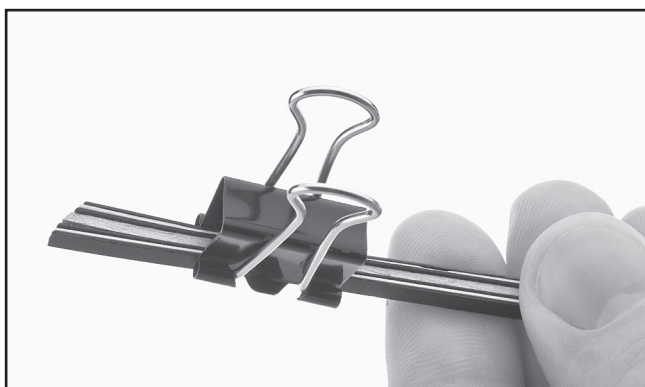

Figure 7. Purfling arranged with end-cut at 45°.

Note: This kit includes a wood strip of purfling. At least 2 bands of the plastic purfling need to be on the outside edge of the purfling pattern to ensure that the wood piece will not splinter as it is bent around the sound hole.

We recommend soaking the wood strip for at least an hour before installation. This will help the wood bend as it is installed.

To install the purfling:

1. Clamp the purfling strips together and cut one end of the group at a 45° angle. Do this as close to one end of the strip as possible (see **Figure 7**).
2. Trial fit the purfling in the dado by tapping it in gently with a non-marring mallet, as shown in **Figure 8**.



Figure 8. Installing the purfling.

3. Match the ends and mark with a pencil. Cut the other end at an opposing 45° angle so the two angles meet smoothly when the purfling is installed.
4. Remove the purfling, add a small amount of glue to the bottom of the dado, and re-install the purfling. Be sure to remove any squeezed-out glue with a damp cloth.
5. Place a weight on the purfling to keep it in place while the glue dries for the manufacturer's recommended time.
6. Once the glue is dry, sand the purfling flush with surface of the sound board.



Attaching Braces

The sound board and back braces must be installed before gluing the body together. The braces, sound board, and back come pre-measured and marked with layout lines as shown in **Figures 9 and 10**.

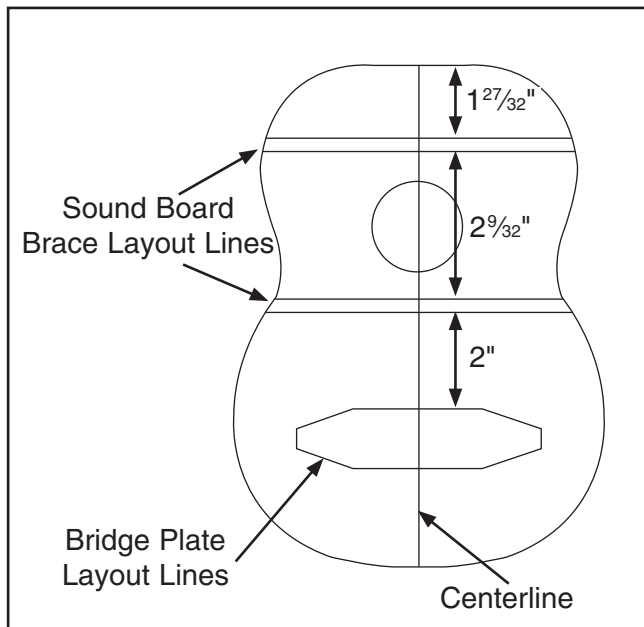

Figure 9. Sound board brace measurements and centerline.

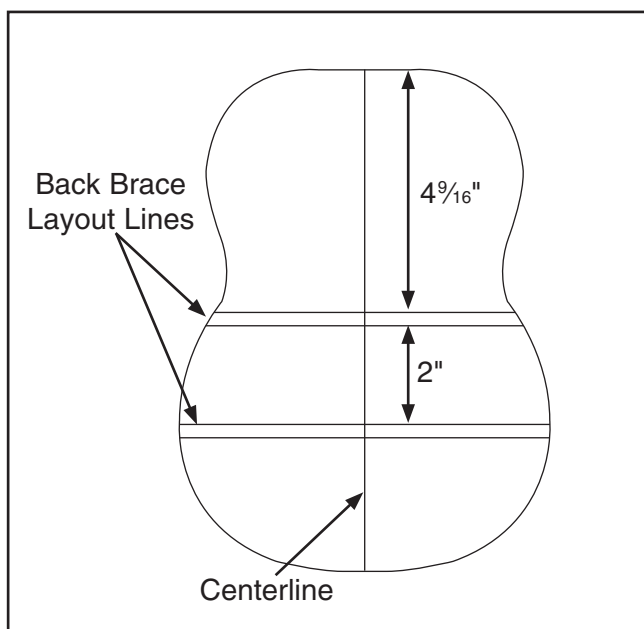

Figure 10. Back brace measurements and centerline.

The braces are roughed to size at the factory, but some fine tuning is necessary for the best fit. The back braces are meant to have a slight curve, which gives the back of the ukulele a belly, improving its sound quality. The sound board braces on the other hand are meant to be flat.

Note: Leave the braces long during assembly. They will be cut to length in a later step.

To prepare the sound board braces:

1. Mark the center on the side of each brace, as shown in **Figure 11**. Transfer any identification markings to the side of the brace as well.

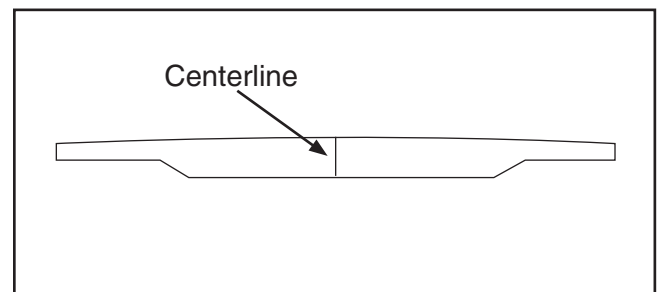

Figure 11. Brace with centerline marked.

2. Using a straightedge, check the back of both the sound board braces for flatness.
 - If the braces are flat, proceed to the next section.
 - If either brace is slightly rounded, proceed to **Step 3**.
3. Using a straightedge and pencil, mark a line as shown in **Figure 12**.

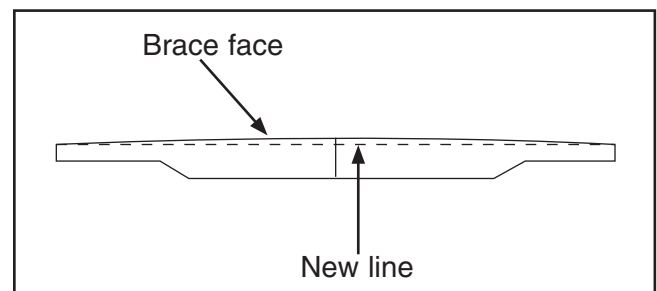

Figure 12. Sound board brace with line marked.

4. Sand the brace flat to the line.



To attach the braces to the back:

1. Apply sufficient glue and center the braces on the back in their specified locations (see **Figure 10 on Page 8**).
2. Place the edges of the back on 1/4" riser blocks. Use a weight to depress the back board enough to conform to the curve of the braces, as shown in **Figure 13**.

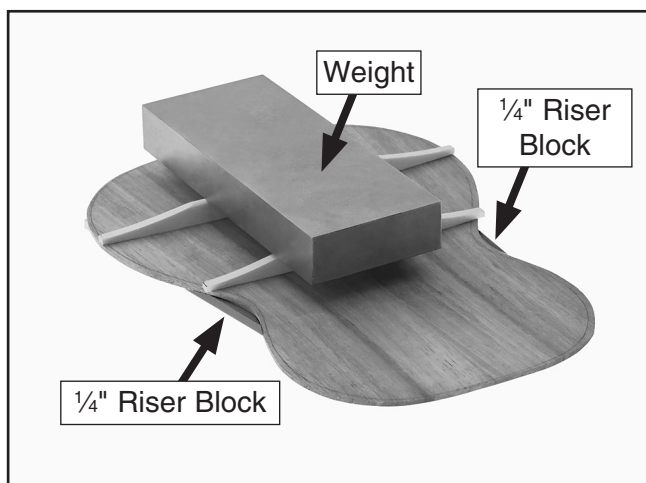

Figure 13. Weight being used to conform the back to the curve of the braces.

3. Ensure the location of the braces is accurate before the glue sets.
4. Before the glue fully hardens (after about an hour), use a chisel to gently scrape away any glue squeezed-out from the braces and the back (see **Figure 14**).



Figure 14. Example of scraping glue squeezed-out while still soft.

5. Allow the glue to fully set per the manufacturer's recommended time.

To attach the braces to the sound board:

1. Apply sufficient glue and center the braces on the sound board in their specified locations (see **Figure 10 on Page 8**).

Note: *The braces and bridge plate attach to the sound board opposite the side with the purfling.*

2. Using clamps or a weight, glue the braces in place.
3. Before the glue fully hardens (after about an hour), use a chisel to gently scrape away any glue squeezed-out from the braces and the back (see **Figure 14**).
4. Allow the glue to fully set per the manufacturer's recommended time.

To attach the bridge plate to the sound board:

1. Apply sufficient glue and center the bridge plate on the soundboard in its specified location (see **Figure 10 on Page 8**).
2. Using clamps or a weight, glue the bridge plate in place.
3. Before the glue fully hardens (after about an hour), use a chisel to gently scrape away any glue squeezed-out from the braces and the back (see **Figure 14**).
4. Allow the glue to fully set per the manufacturer's recommended time.

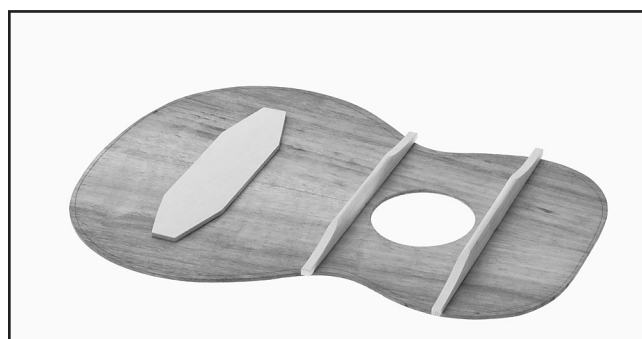

Figure 15. Completed sound board with braces and bridge plate attached.

Attaching Kerfing

Kerfing provides increased surface area for attaching the sound board and back to the ukulele. Attaching the kerfing works best if it is shaped to fit the sides of the ukulele. The kerfing is attached to the sides as shown in **Figure 16**.

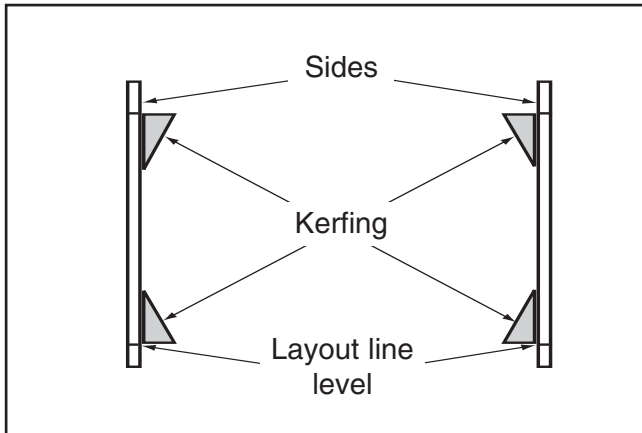

Figure 16. Cross section view of kerfing attached to the ukulele sides.

To fit the kerfing to the ukulele sides:

1. Soak the kerfing in water for at least two hours.
2. Remove kerfing from the water and pat dry with a paper towel or rag to remove standing water from the surface of the kerfing to prevent water from soaking into the sides in the next step.
3. Clamp the end of the kerfing tight against the neck block, and gently bend it to the contour of the side, adding clamps as you proceed, as shown in **Figure 17**.

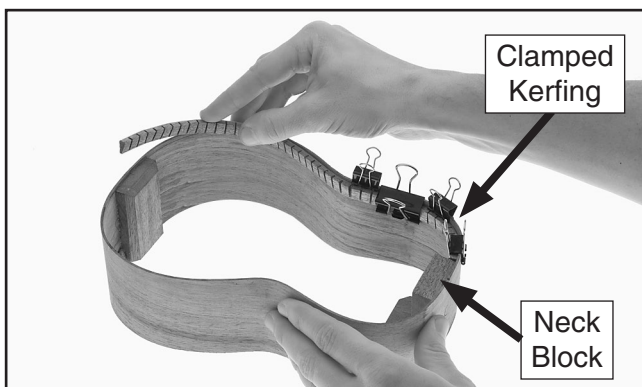

Figure 17. Fitting the kerfing to the sides.

4. Determine the final length of the kerfing at the tail block and cut as necessary.
5. Clamp the kerfing in place and let it dry over night. This forms the kerfing to the sides and makes glue-up go more smoothly.
6. Using a pencil, mark the kerfing and the sides for replacing the kerfing in the same position during the glue-up procedure.
7. Once the kerfing is dry remove it from ukulele body in preparation for gluing the kerfing to the ukulele.

To glue the kerfing to the ukulele sides:

1. Apply a sufficient amount of glue to the block, the ukulele side, and the back of the pre-formed kerfing.
2. Clamp the end of the kerfing tight against the neck block and at the layout line.
3. Clamp the bent kerfing to the contour of the side adding clamps as you proceed, as shown in **Figure 18**.

Note: Ensure that the kerfing and side are in full contact up to the point of each clamp and that the clamps do not move the kerfing above the layout line. Use clamps to maintain the correct height of the kerfing (see **Figure 18**).

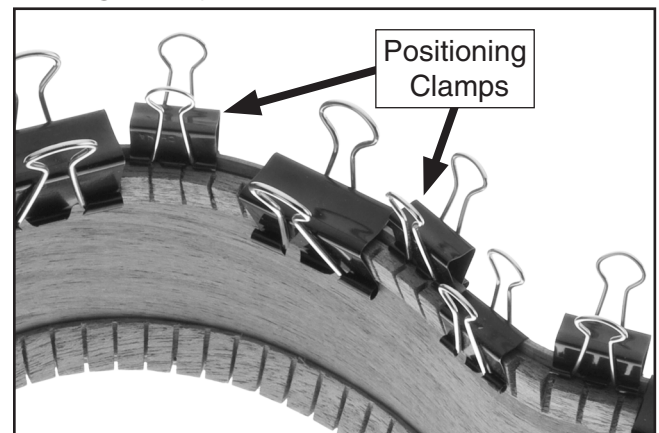

Figure 18. Clamps arranged for positioning and gluing the kerfing to the sides.

4. Let glue set for the manufacturer's recommended length of time.



Assembling Body

Assembling the body consists of removing the excess material above the kerfing, and attaching the sound board and back to the sides/kerfing assembly. It is important to attach the sound board before the back in order to provide added structure when attaching the curved back.

To prepare the sides for assembly:

1. Using coarse grit sandpaper, remove the extra side material that extends beyond the kerfing.

Note: *To make sanding easier and more accurate, you may want to mark waste lines on the outside surface of the sides.*

2. Once the sides are sanded flush with the kerfing, mark and cut the braces to fit inside the kerfing but still touch it.
3. Trial fit the sound board and back, correct any fit issues by sanding as necessary.

To attach the sound board:

Note: *Cutting the braces close allows them to be glued to the kerfing, increasing the strength of the ukulele. However, DO NOT force the braces inside the kerfing, as this will distort the shape of the ukulele.*

2. Apply sufficient glue to the edges of the sound board and top of the kerfing.

Note: *The sound board of the ukulele needs to be flat and the body symmetrical in order for the back to attach properly and provide the best sound quality.*

3. Secure the sound board to the body with rubber bands. Use wedges to ensure a tight fit all around the instrument, as shown in **Figure 19**. Allow the glue to dry for the manufacturer's recommended time.

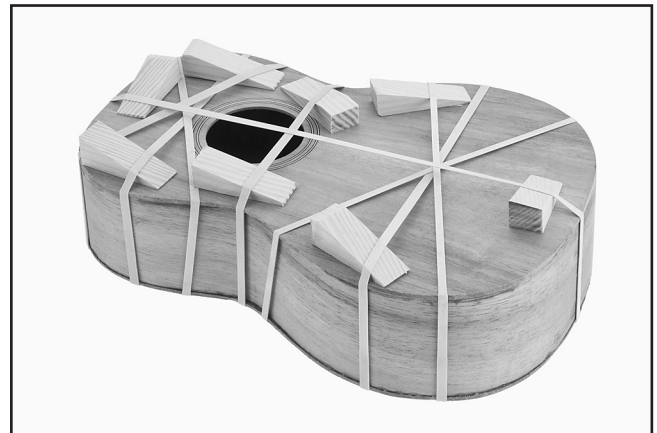

Figure 19. Sound board glued to the body with rubber bands and wedges.

To attach the back:

1. Mark and cut the braces to fit inside the kerfing but still touch it.
2. Secure the back to the body with rubber bands, ensuring a tight fit all around the instrument, as shown in **Figure 20**. Use wedges if necessary to ensure a tight fit. Allow the glue to dry for the manufacturer's recommended time.

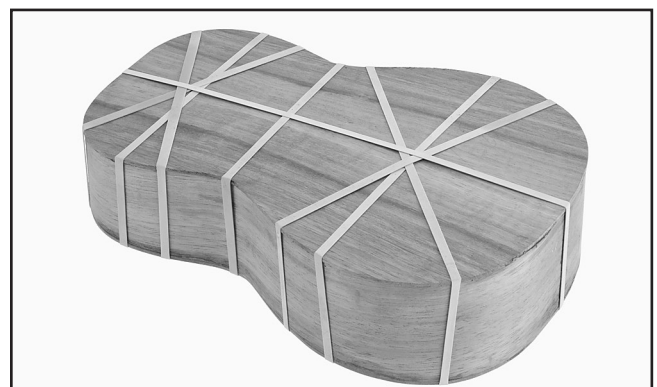

Figure 20. Back glue to the ukulele body with rubber bands.



Installing Frets

The fingerboard comes with precut fret slots. The frets have also been measured and roughly cut to fit their corresponding slots. Installing the frets requires matching the frets to the appropriate slot, installing them on the fingerboard, and removing the excess fret material.

To attach the frets to the fingerboard:

1. Match the frets to the corresponding fret slot on the fingerboard, as shown in **Figure 21**.

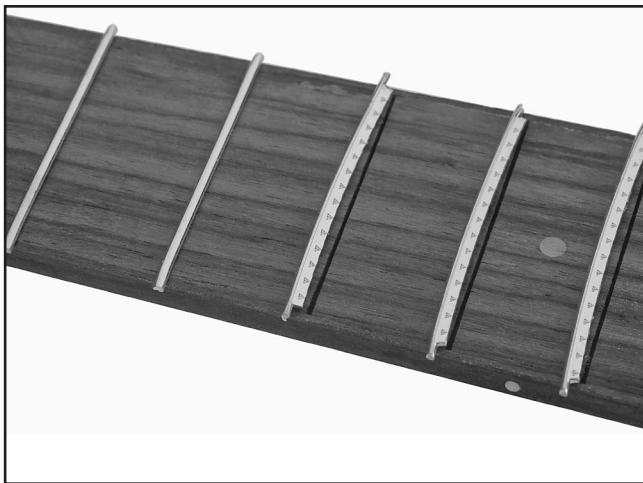

Figure 21. Matching the frets to their respective slots on the fingerboard.

2. While the frets are laid out on the fingerboard, lay a piece of masking tape down the length of the board and number the frets, as shown in **Figure 22**.

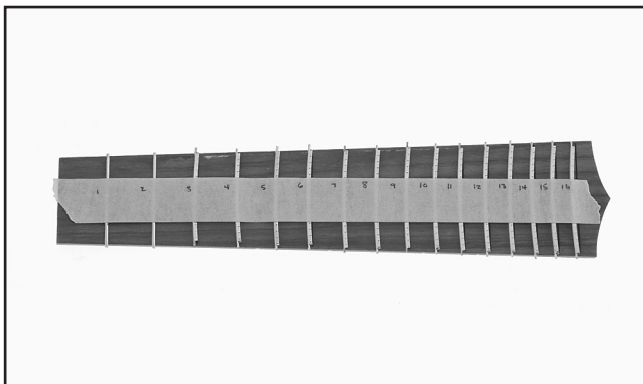

Figure 22. Frets laid out and numbered on the fingerboard.

3. Peel off the tape with the frets attached and set it aside. This will help you keep the frets organized until you are ready to install them.
4. Use a non-marring mallet and lightly tap each fret into the fingerboard slot until the underside of the fret body comes in contact with the fingerboard, as shown in **Figure 23**.



Figure 23. Installing the frets.

Note: Excessive force can cause the frets to bend. Tap them in gradually across the length of each fret.

5. Use a pair of fret cutters or nippers to cut any excess fret lengths flush with the edge of the fingerboard.
6. File the cut ends of the frets smooth with a fine-tooth metal file.
7. Use 600 grit sandpaper on a sanding block to finish the ends of the frets. Be careful not to scratch the fingerboard.



Attaching Neck to Ukulele Body

The neck comes from the factory ready to fit the ukulele body. It must be installed on body before the fingerboard is attached. At the base of the neck, a peg has been installed to properly position it with the ukulele body.

To attach the neck to the body:

1. Drill a hole in the neck block where you marked it earlier in construction (see **Figure 4** on **Page 6**).
2. Using a pencil, draw a centerline down the length of the neck and the body of the ukulele. This mark can be sanded off or erased later.
3. Align the centerlines and ensure that the fit of the neck to the body is flush.
 - If the centerlines **DO** line up straight, proceed to **Step 4**.
 - If the centerlines **DO NOT** line up straight, drill the hole on the body slightly larger or saw the length of the peg to improve the fit.
4. Using a long straightedge, verify the ukulele is flat along the neck and sound board, as shown in **Figure 24**.

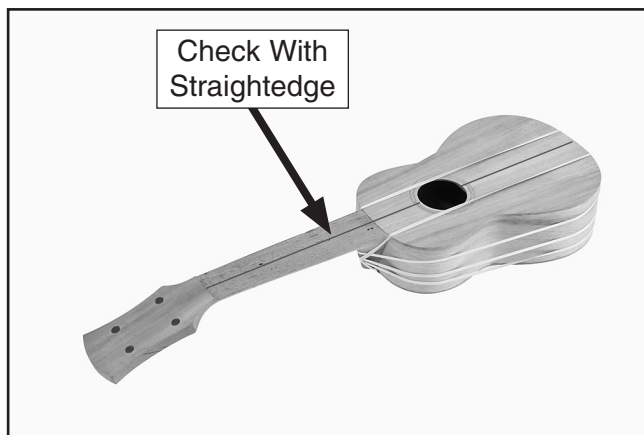

Figure 24. Location to check alignment of body and neck.

- If the ukulele **IS** flat, proceed to **Step 5**.
- If the ukulele **IS NOT** flat, slightly sand the neck as necessary to correct the issue. An index stone or piece of plate glass can be used as a flat sanding surface for your sandpaper.

Note: *A consistent flatness of the neck and the body ensure the fingerboard can be installed properly.*

5. Glue the neck to the body. Use band clamps or rubber bands to ensure a tight fit, as shown in **Figure 25**, and let the glue dry for at least 24 hours before attaching the fingerboard.



Figure 25. Gluing the neck to the body using rubber bands and wedges to secure it in place.



Sanding

Ukulele Body

The components that make the ukulele body have been rough-sanded at the factory; however, no finish has been applied. To complete construction and prepare the ukulele for finish, it must be sanded.

To sand the ukulele body:

1. **Wear an approved respirator and safety glasses when sanding wood!**
2. Using either an electric palm sander or a sanding block, sand the ukulele body (EXCEPT the neck notch, the edges, and the sound hole) with #180 grit aluminum-oxide sanding paper until there is a consistent scratch pattern on the entire surface.

Note: If hand-sanding, always sand in the same direction as the wood grain. Pay particular attention to the joints where excess glue has squeezed out. This must be completely removed for a uniform finish.
3. Repeat **Step 2** with #240 grit sandpaper.
4. Repeat **Step 2** with #320 grit sandpaper.
5. Wipe the ukulele body with a damp cloth. Wiping the workpiece with a damp cloth before the final sanding helps to “raise” the wood grain; thus, allowing the “raised” grain to be sanded smooth.
6. Once the ukulele body is dry, repeat **Step 4**.
7. Wipe the ukulele body with a tack cloth to remove all remaining sanding dust.

Neck

Like the body, most of the neck has been machined at the factory; however, the neck-to-fingerboard joint needs to be completed. Be sure to use caution while sanding this area as not to sand into the fingerboard or change its shape.

To sand the ukulele neck:

1. **Wear an approved respirator and safety glasses when sanding wood!**
2. Using the sanding technique described in **Steps 2–7** of the previous sub-section, sand the entire ukulele neck, EXCEPT for the fingerboard mounting surface.

Note: Sanding the fingerboard mounting surface will affect the playability of the ukulele and could lead to irreparable damage.

Fingerboard

The fingerboard requires no sanding.

Note: Sanding the fingerboard will affect the playability of the ukulele and could lead to irreparable damage.

Bridge

The bridge has been finished at the factory and requires no sanding.



Attaching Fingerboard

With sanding completed, the fingerboard is ready to be attached to the neck and sound board.

To attach the fingerboard:

1. Apply a thin layer of glue to the back of the fingerboard and position it on the neck.
2. Secure the fingerboard in place with rubber bands, as shown in **Figure 26**. Use wedges if necessary to ensure a tight fit. Let the glue dry for at least 24 hours.

Note: Make sure the fingerboard is centered across the width of the neck and that the 12th fret is positioned over the neck-to-body joint.

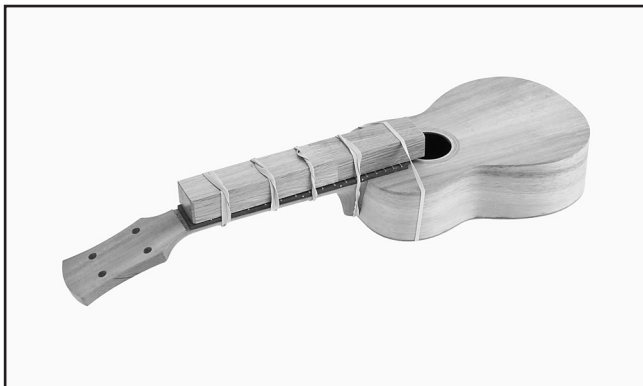

Figure 26. Attaching fingerboard to the neck.

3. Sand or file the edge of the neck flush with the edge of the fingerboard. Do this slowly to avoid sanding the fingerboard.

Determining Bridge Location

The bridge is glued directly to the sound board at the location of the bridge plate. Leaving an area of the sound board slightly smaller than the footprint of the bridge unfinished increases the strength of the glue joint that attaches the bridge to the sound board. The reduced size of this area allows the finish of the ukulele to be consistent around the bridge.

To determine the correct bridge/nut location:

1. Insert the saddle into the bridge and position the front edge of the saddle 6.98" away from the center of the 12th fret (**Figure 27**).

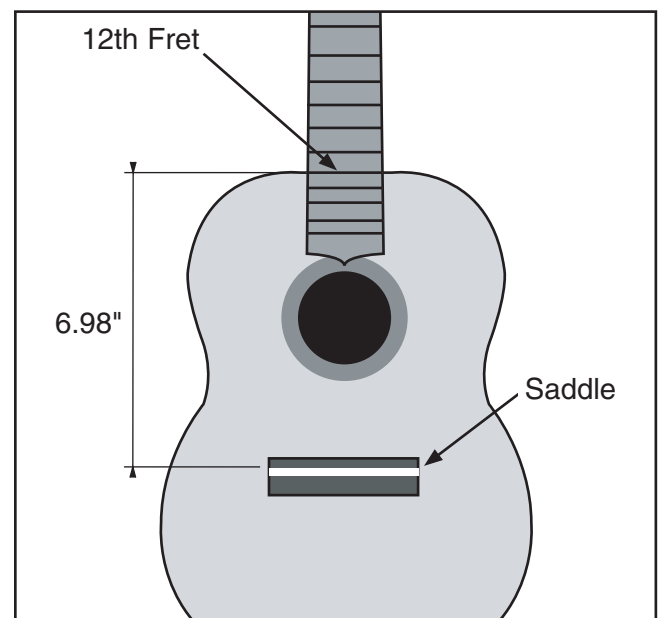

Figure 27. Bridge positioning.

2. Using a pencil, lightly mark out the footprint of the bridge.
3. Cut a piece of tape slightly smaller than the footprint and attach it to the sound board inside the footprint of the bridge.



Preparing to Finish

In preparation for applying the finish, we recommend using masking tape to protect the following parts of the ukulele.

- Mask the bridge mounting location, (see **Figure 28**).
- Mask the fingerboard and nut location, (see **Figure 29**).
- Fill the sound hole with newspaper, (see **Figure 29**).

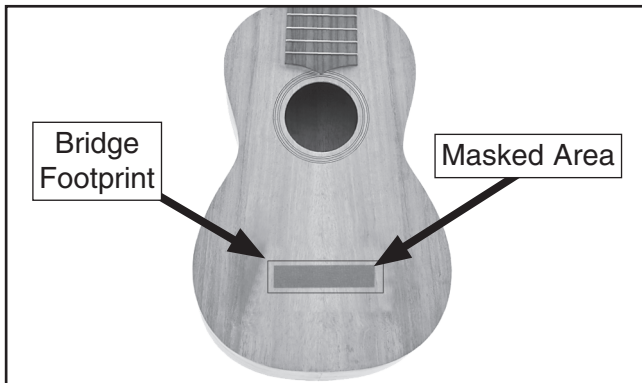

Figure 28. Masked off area for bridge.

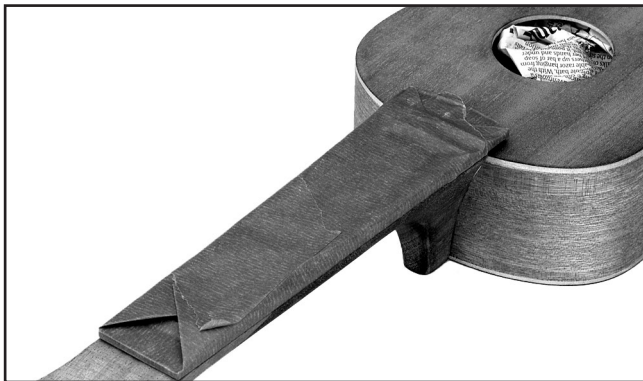

Figure 29. Example of a masked fingerboard and stuffed sound hole.

Carefully press all the masking tape edges securely to the ukulele pieces. The finish coat can seep under these edges, especially near corners, uneven edges, and where the frets meet the fingerboard.

Note: *Failure to correctly mask these areas could result in irreparable damage to the ukulele.*

Painting/Finishing

Finishing supplies are not supplied with the ukulele kit.

Tip: *The ukulele body is made from mahogany. Clear finishes such as lacquer look exceptionally stunning and glossy on this wood.*

Painting/Finishing Tips:

- **Always work in a well ventilated area when using finishing materials.**
 - **Wear an approved respirator mask and safety glasses when using finishing materials!**
 - Fabricate hooks from metal hangers to suspend the ukulele components during the finishing process.
 - Several thinner coats usually produce a nicer finish than one heavy coat.
- Note:** *Always follow the finish manufacturer's instructions.*
- Dust particles suspended in the air will settle on wet finishes, resulting in less than satisfactory results. To avoid this problem:

1. Have the ukulele components positioned for the finish application upon entering the room.
2. Leave the room where the finishing will take place completely undisturbed for 24 hours prior to applying the finish.
3. Avoid making unnecessary movements upon entering the finish room.
4. Apply the finish to the desired ukulele parts and immediately leave the finish room.
5. **DO NOT** return to the room until the specified drying time has elapsed.



Attaching Bridge

Remove the tape from the masked areas in preparation for attaching the bridge. Refer to **Page 15** for the necessary measurements to locate the bridge.

To attach the bridge to the ukulele:

1. Using a pencil, lightly mark the ukulele body where the front edge of the bridge is located.
2. Set the string nut along the end of the fingerboard, near the headstock.
3. Attach pieces of sewing thread to the 1st and the 4th nut slots, and tape the opposite ends over the 1st and the 4th holes on the bridge.
4. Position the bridge on the body at the location marked in the **Determining Bridge/Nut Location** section on **Page 15**.

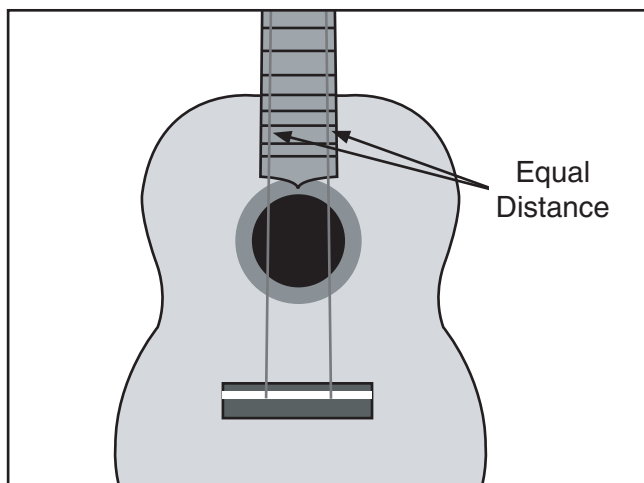

Figure 30. Positioning the bridge across the width of the ukulele.

5. Adjust the bridge side-to-side so there is an equal amount of space between the fingerboard edges and the threads (see **Figure 30**).
6. Using a pencil, lightly mark the ukulele body where the side edges of the bridge are located.

7. Remove the saddle from the bridge.
8. Apply a thin coat of glue to the back of the bridge and the unfinished area of the sound board. Let the glue set until it is still tacky but clear.
Note: Do not use too much glue or the excess may require clean up that can adversely affect the finish of the ukulele.
9. Place and firmly hold the bridge in position for two minutes by hand. This will secure it temporarily before clamping.
10. Clamp the bridge in place overnight, as shown in **Figure 31**.



Figure 31. Gluing the bridge to the body.

11. Remove the clamp setup. Install the saddle on the bridge. The saddle and bridge are now ready for string installation (see **Figure 32**).



Figure 32. Bridge and saddle installed on the sound board.



Setting String Height

The string height is the distance between the top of the fret and the bottom of the string (**Figure 33**). Correct string height is crucial for maximizing the playability of the ukulele. Measurements are taken at the 1st and 12th fret.

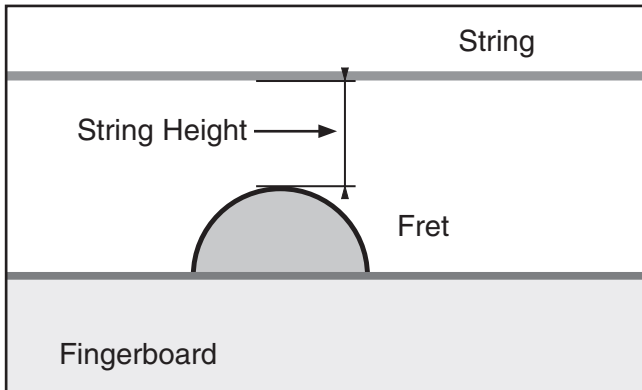

Figure 33. String height measurement (side view).

The string nut and saddle come oversized from the factory. Sizing them requires measuring, sanding, and re-measuring. Fix both the nut and saddle until correct string heights are reached. Hand-sanding prevents removing too much material.

To check the string heights at the 1st and 12th frets:

1. Using a dime as a gauge (approximately $\frac{1}{16}$ "), measure the string heights at the 1st fret (see **Figure 34**).

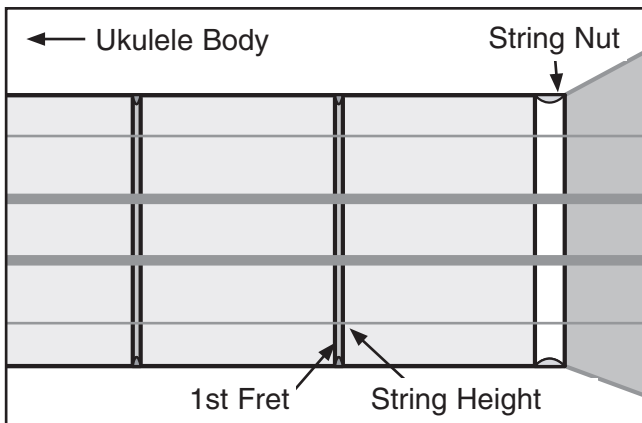

Figure 34. Correct 1st fret string heights.

- If the string heights are at least the thickness of a dime, then proceed to **Step 2**.
- If the string heights are less than the thickness of a dime at the 1st fret, this is an indication that the height of the string nut needs to be adjusted. Proceed to **Step 3**.

2. Using a stack of three pennies (approximately $\frac{3}{16}$ "), measure the string heights at the 12th fret (see **Figure 35**).

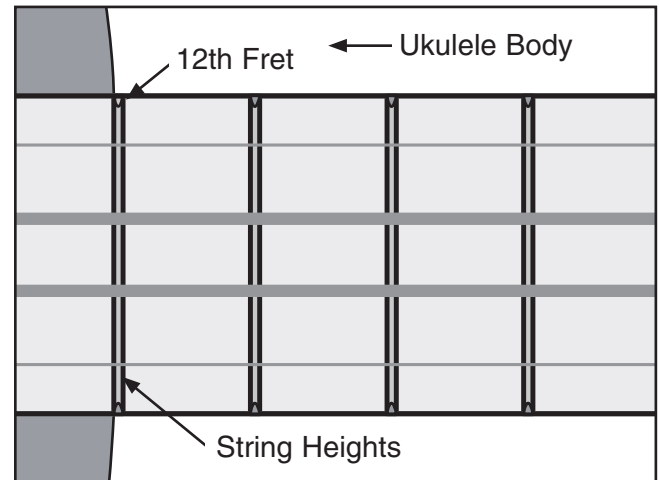

Figure 35. Correct 12th fret string heights.

- If the string heights are approximately the thickness of three pennies, then continue to **Step 5**.
- If the string heights are less than the height of three pennies at the 12th fret, this is an indication that the height of the saddle needs reduced. Proceed to **Step 3**.

3. Hand-sand the base of the string nut/saddle. *DO NOT* remove too much material.
4. Test the string nut/saddle by repeating **Steps 1–2**.
5. Glue the string nut into place.

Note: The nut and saddle may need to be removed and resized if the neck of the ukulele warps due to moisture. Use only enough glue to keep the string nut in place. The saddle should not be glued.



Installing Tuning Peg

Each tuning peg consists of the components shown in **Figure 36**.

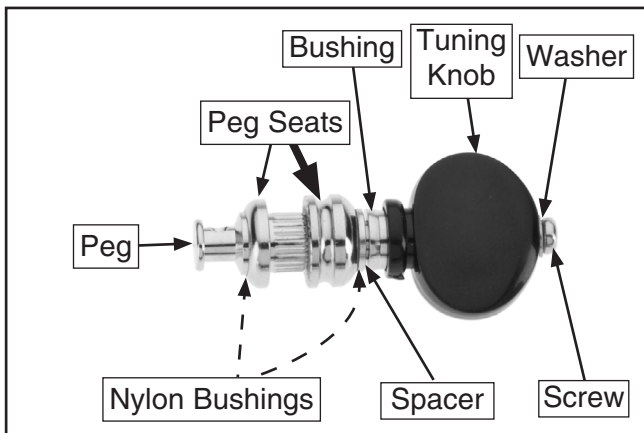

Figure 36. Tuning peg components.

To install the tuning peg:

1. Using a non-marring mallet, tap each of the four peg seats into the pre-drilled holes on the front of the headstock, as shown in **Figure 37**.

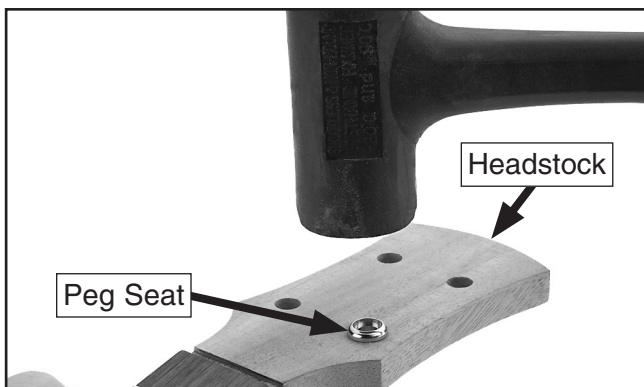

Figure 37. Installing peg seat into front of headstock.

2. Slide each peg through one nylon bushing into the seat on the front of the headstock.
3. Attach the remaining components to the peg in the order shown in **Figure 36**.
4. Secure the tuning peg assembly by tightening the Phillips screw.

Installing Strings

Each string of the ukulele is a different diameter. Number the strings 1, 2, 3, and 4—from the smallest diameter to the largest diameter. Their arrangement on the ukulele is shown in **Figure 38**.

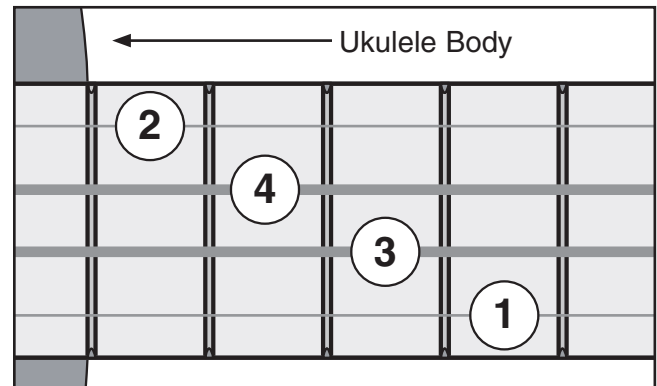

Figure 38. Proper string arrangement.

To install the ukulele strings:

1. Use a piece of tape and pen to designate each string number and tie a knot at one end of each string.
2. In the order shown in **Figure 38**, pull the strings through the bridge slots, over the saddle, and over the string nut slots.
3. Route the strings to the inside of the tuning pegs and through the peg holes.

Note: Provide enough string slack to allow 2–3 complete winds around the tuning peg.

4. Turn the tuning buttons to lightly tighten the strings. The strings are now ready for **Tuning** on **Page 20**.



Figure 39. Completed ukulele.



Tuning

Tuning is the most important concept of playing a ukulele. If the ukulele is not in tune with itself, or the other instruments in an ensemble, the resulting music will not sound pleasing to the ear. Having a good understanding of tuning is essential to maximizing the full potential of any ukulele.

Important issues to consider when tuning a ukulele:

- Get into the habit of tuning the ukulele every time it is picked up to be played.
- Always tune the strings “up.” The final tuned tension of each string should be reached while tightening the string, not loosening it. If the string is tensioned too far, loosen the tension and tune “up” again.
- The goal when tuning is to make the strings in tune with one another. Standard tuning is shown in **Figure 40**.

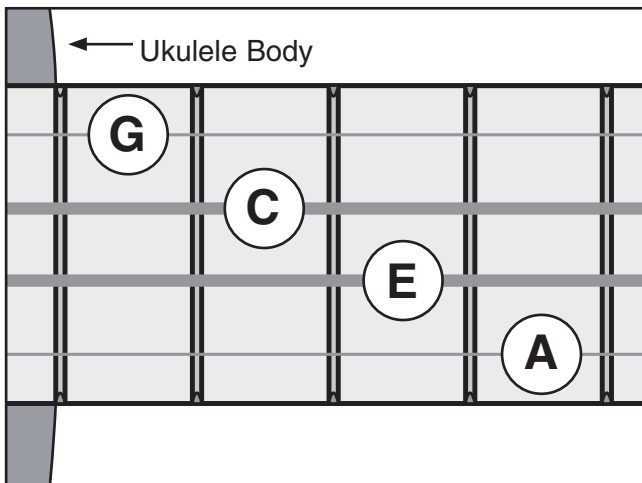

Figure 40. Standard tuning notes.

- The easiest way to tune a ukulele is using an electronic tuner such as the Grizzly T23099 Chromatic Tuner shown on **Page**.

AFTERMARKET ACCESSORIES

NOTICE

Refer to the newest copy of the Grizzly Catalog for other available accessories.

Call 1-800-523-4777 To Order

Model T23099—Chromatic Tuner/Metronome

This metronome/tuner is suitable for all electric and acoustic stringed instruments. It has an easy to read LCD display and is able to tune notes: A, A#, B, C, C#, D, D#, E, F, F#, G, and G#. Seven beat settings and 5 rhythms make this versatile device a must for the novice or experienced musician.

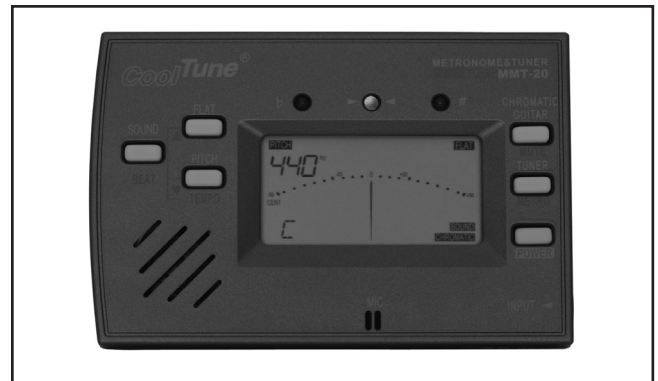

Figure 41. T23099 Chromatic Tuner.

Model H5902—Jumpin' Jim's Camp Ukulele

Model H5903—Jumpin' Jim's '60s Uke-In

Jumpin' Jim's books provide a collection of songs for the ukulele with easy to play along arrangements. Great for any ukulele musician.

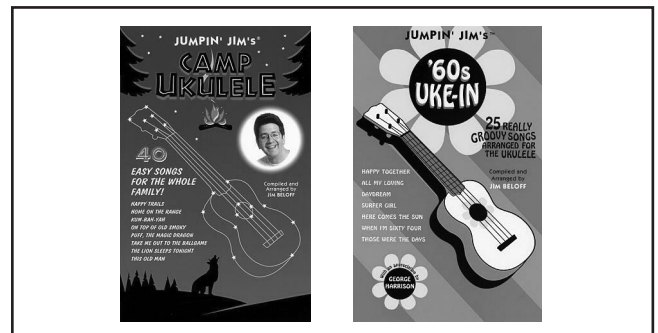

Figure 42. Jumpin' Jim's Camp Ukulele and '60s Uke-In .



Model T24022—The Daily Ukulele

Strum a different song every day with easy arrangements of 365 of your favorite songs! The Daily Ukulele includes arrangements that feature melody, lyrics and ukulele chord grids and are in ukulele-friendly keys that are particularly suited for groups of one to one hundred. Includes folk songs, pop songs, kids' songs, Christmas carols and Broadway tunes, all with a spiral binding.

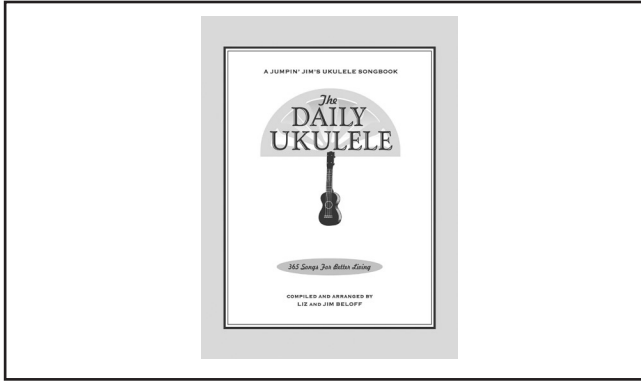

Figure 43. T24022 The Daily Ukulele.

Model T24020—Rogers & Hammerstein for ukulele

Now you can play 20 classic show tunes from this beloved songwriting duo on your uke! Includes: Do-Re-Mi • Edelweiss • I'm Gonna Wash That Man Right Out of My Hair • My Favorite Things • The Surrey with the Fringe on Top • Younger Than Springtime • and more. 48 pages.

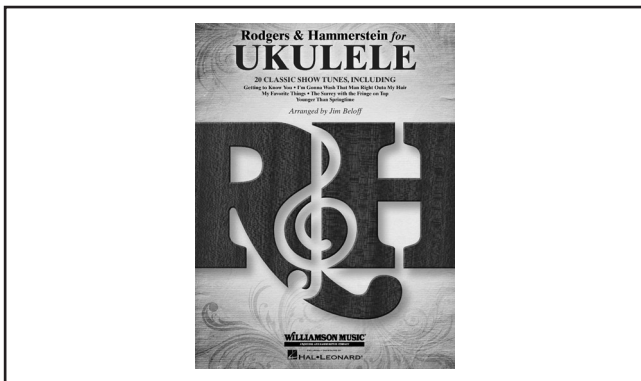

Figure 44. T24020 Rogers & Hammerstein for Ukulele.

Model H2532—12" Stainless Steel Ruler

This 12" Stainless Steel Ruler with increments as fine as 0.5mm and 1/64".

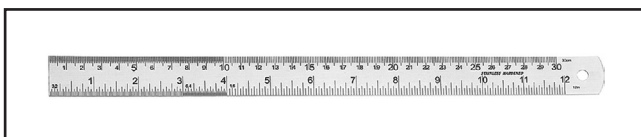

Figure 45. H2532 12" Stainless Steel Ruler.

Model—H6320 Dead Blow Handle—Brass End

This deadblow hammer with brass end provides a non-marring face for those delicate hammering jobs where a bit of punch is needed.

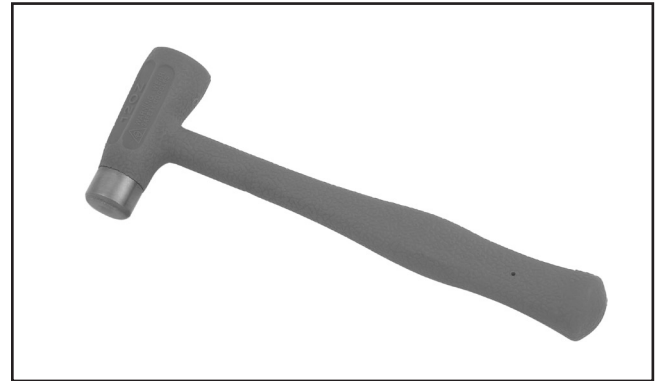

Figure 46. H6320 Dead Blow Handle—Brass End.

Model G9647—6 x 8 x 2" Surface Plate

Model G9648—9 x 12 x 2" Surface Plate

Model G9649—9 x 12 x 3" Surface Plate

These toolroom grade "B" Granite Plates have a bilateral accuracy of +/- 0.0001 total instrument runout for precision measurements from a common surface base. Granite Plates are harder than steel, non magnetic, least responsive to temperature changes, practically maintenance free and won't corrode like steel. Great for precision measuring and flattening in luthierie construction.

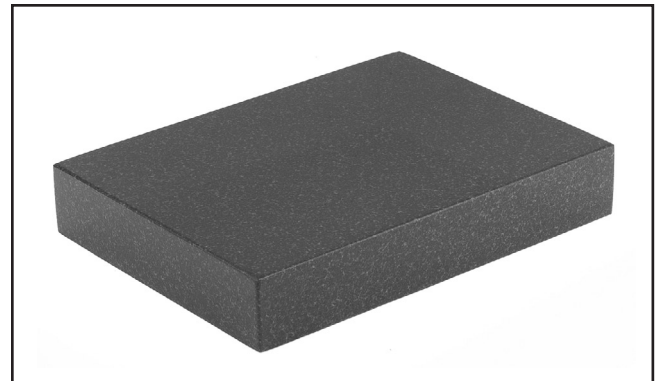

Figure 47. G9649 9 x 12 x 3" Surface Plate.

Call 1-800-523-4777 To Order



grizzly.com[®]

TOOL WEBSITE

Buy Direct and Save with Grizzly[®] – Trusted, Proven and a Great Value!
~Since 1983~

*Visit Our Website Today For
Current Specials!*

**ORDER
24 HOURS A DAY!
1-800-523-4777**



Free Manuals Download Website

<http://myh66.com>

<http://usermanuals.us>

<http://www.somanuals.com>

<http://www.4manuals.cc>

<http://www.manual-lib.com>

<http://www.404manual.com>

<http://www.luxmanual.com>

<http://aubethermostatmanual.com>

Golf course search by state

<http://golfingnear.com>

Email search by domain

<http://emailbydomain.com>

Auto manuals search

<http://auto.somanuals.com>

TV manuals search

<http://tv.somanuals.com>