

Grizzly
Industrial, Inc. ®

3 H.P. OVERARM ROUTER
MODEL G8030
INSTRUCTION MANUAL



COPYRIGHT © 2001 BY GRIZZLY INDUSTRIAL, INC.
**WARNING: NO PORTION OF THIS MANUAL MAY BE REPRODUCED IN ANY SHAPE
OR FORM WITHOUT THE WRITTEN APPROVAL OF GRIZZLY INDUSTRIAL, INC.**
PRINTED IN TAIWAN



WARNING!

Some dust created by power sanding, sawing, grinding, drilling, and other construction activities contains chemicals known to the State of California to cause cancer, birth defects or other reproductive harm. Some examples of these chemical are:

- **Lead from lead-based paints.**
- **Crystalline silica from bricks, cement and other masonry products.**
- **Arsenic and chromium from chemically-treated lumber.**

Your risk from these exposures varies, depending on how often you do this type of work. To reduce your exposure to these chemicals: Work in a well ventilated area, and work with approved safety equipment, such as those dust masks that are specially designed to filter out microscopic particles.

Table Of Contents

	PAGE
1. SAFETY	
SAFETY RULES FOR ALL TOOLS	2-3
ADDITIONAL SAFETY INSTRUCTIONS FOR OVERARM ROUTERS	4
2. CIRCUIT REQUIREMENTS	
220V OPERATION	5
CIRCUIT LOAD	5
GROUNDING	6
EXTENSION CORDS	6
WIRING	6
3. INTRODUCTION	
COMMENTARY	7
UNPACKING	8
PIECE INVENTORY	8
CLEAN UP	9
SITE CONSIDERATIONS	9
4. ASSEMBLY	
BEGINNING ASSEMBLY	10
POWER	10
ROTATION CHECK	11
AIR TUBE/FOOT SWITCH CONNECTION	11-12
CHIP BLOWER	12
BIT INSTALLATION	13
BIT TIGHTENING	14
INSTALLING THE SHIELD	14
INSTALLING THE BRAKE HANDLE	15
INSTALLING THE FENCE	15
5. ADJUSTMENTS	
BELT	16
SPINDLE LOWERING SPEED	17
TABLE TILT	17
SPINDLE BASE ADJUSTMENT	18
CUTTING DEPTH	19
MICRO ADJUSTMENTS	19
6. OPERATIONS	
TEST RUN	20
GUIDE PIN INSTALLATION	20-21
PATTERN ROUTING	21-22
STRAIGHT LINE ROUTING	23
DUST CONTROL	23
7. MAINTENANCE	
GENERAL	24
TABLE	24
LUBRICATION	25
BELT	25
8. CLOSURE	26
MACHINE DATA	27
PARTS BREAKDOWN AND PARTS LISTS	28-30
WARRANTY AND RETURNS	32-34

SECTION 1: SAFETY

WARNING

For Your Own Safety Read Instruction Manual Before Operating This Equipment

The purpose of safety symbols is to attract your attention to possible hazardous conditions. This manual uses a series of symbols and signal words which are intended to convey the level of importance of the safety messages. The progression of symbols is described below. Remember that safety messages by themselves do not eliminate danger and are not a substitute for proper accident prevention measures.



Indicates an imminently hazardous situation which, if not avoided, WILL result in death or serious injury.



Indicates a potentially hazardous situation which, if not avoided, COULD result in death or serious injury.



Indicates a potentially hazardous situation which, if not avoided, MAY result in minor or moderate injury. It may also be used to alert against unsafe practices.



This symbol is used to alert the user to useful information about proper operation of the equipment.

WARNING

Safety Instructions For Power Tools

1. **KEEP GUARDS IN PLACE** and in working order.
2. **REMOVE ADJUSTING KEYS AND WRENCHES.** Form habit of checking to see that keys and adjusting wrenches are removed from tool before turning on.
3. **KEEP WORK AREA CLEAN.** Cluttered areas and benches invite accidents.
4. **DO NOT USE IN DANGEROUS ENVIRONMENT.** Do not use power tools in damp or wet locations, or where any flammable or noxious fumes may exist. Keep work area well lighted.
5. **KEEP CHILDREN AND VISITORS AWAY.** All children and visitors should be kept a safe distance from work area.
6. **MAKE WORKSHOP CHILD PROOF** with padlocks, master switches, or by removing starter keys.
7. **DO NOT FORCE TOOL.** It will do the job better and safer at the rate for which it was designed.
8. **USE RIGHT TOOL.** Do not force tool or attachment to do a job for which it was not designed.

WARNING

Safety Instructions For Power Tools

- 9. USE PROPER EXTENSION CORD.** Make sure your extension cord is in good condition. Conductor size should be in accordance with the chart below. The amperage rating should be listed on the motor or tool nameplate. An undersized cord will cause a drop in line voltage resulting in loss of power and overheating. Your extension cord must also contain a ground wire and plug pin. Always repair or replace extension cords if they become damaged.

Minimum Gauge for Extension Cords

AMP RATING	LENGTH		
	25ft	50ft	100ft
0-6	18	16	16
7-10	18	16	14
11-12	16	16	14
13-16	14	12	12
17-20	12	12	10
21-30	10	10	No

- 10. WEAR PROPER APPAREL.** Do not wear loose clothing, gloves, neckties, rings, bracelets, or other jewelry which may get caught in moving parts. Non-slip footwear is recommended. Wear protective hair covering to contain long hair.
- 11. ALWAYS USE SAFETY GLASSES.** Also use face or dust mask if cutting operation is dusty. Everyday eyeglasses only have impact resistant lenses, they are NOT safety glasses.
- 12. SECURE WORK.** Use clamps or a vise to hold work when practical. It's safer than using your hand and frees both hands to operate tool.
- 13. DO NOT OVERREACH.** Keep proper footing and balance at all times.
- 14. MAINTAIN TOOLS WITH CARE.** Keep tools sharp and clean for best and safest performance. Follow instructions for lubricating and changing accessories.
- 15. USE RECOMMENDED ACCESSORIES.** Consult the owner's manual for recommended accessories. The use of improper accessories may cause risk of injury.
- 16. REDUCE THE RISK OF UNINTENTIONAL STARTING.** On machines with magnetic contact starting switches there is a risk of starting if the machine is bumped or jarred. Always disconnect from power source before adjusting or servicing. Make sure switch is in OFF position before reconnecting.
- 17. MANY WOODWORKING TOOLS CAN "KICKBACK" THE WORKPIECE** toward the operator if not handled properly. Know what conditions can create "kickback" and know how to avoid them. Read the manual accompanying the machine thoroughly.
- 18. CHECK DAMAGED PARTS.** Before further use of the tool, a guard or other part that is damaged should be carefully checked to determine that it will operate properly and perform its intended function. Check for alignment of moving parts, binding of moving parts, breakage of parts, mounting, and any other conditions that may affect its operation. A guard or other part that is damaged should be properly repaired or replaced.
- 19. NEVER LEAVE TOOL RUNNING UNATTENDED. TURN POWER OFF.** Do not leave tool until it comes to a complete stop.
- 20. NEVER OPERATE A MACHINE WHEN TIRED, OR UNDER THE INFLUENCE OF DRUGS OR ALCOHOL.** Full mental alertness is required at all times when running a machine.
- 21. NEVER ALLOW UNSUPERVISED OR UNTRAINED PERSONNEL TO OPERATE THE MACHINE.** Make sure any instructions you give in regards to machine operation are approved, correct, safe, and clearly understood.
- 22. IF AT ANY TIME YOU ARE EXPERIENCING DIFFICULTIES** performing the intended operation, stop using the machine! Then contact our service department or ask a qualified expert how the operation should be performed.

WARNING

Additional Safety Instructions For The Overarm Router

- 1. ALWAYS USE A GUIDE PIN WHEN ROUTING WITHOUT THE FENCE.**
- 2. DO NOT ROUT STOCK TOO SMALL TO HOLD SECURELY WITHOUT SPECIAL JIGS.** Use longer stock and cut to size.
- 3. ALWAYS TEST ANY NEW TEMPLATE OR SETUP** with the machine unplugged, to ensure proper template contact and swing before starting the machine.
- 4. NEVER ATTEMPT TO REMOVE TOO MUCH MATERIAL IN ONE PASS.** Several light passes are safer and give a cleaner finish.
- 5. THE USE OF PUSH STICKS AS SAFETY DEVICES** in some applications is smart; in others it can be quite dangerous. If the push stick comes in contact with the cutter on the end grain, it can fly out of your hand like a bullet – potentially causing serious injury. We recommend using some type of fixture, jig, or hold-down device as a safer alternative. Use a guard, or other type of protective device at all times.
- 6. ALWAYS USE BITS THAT ARE RATED FOR 20,000 R.P.M. OPERATION OR HIGHER.** Do not use bits that are designed for slow R.P.M. operation. If you do not know the maximum rated R.P.M. for a particular bit, do not use it in the overarm router. The bit could break apart under the high centrifical forces, causing flying metal to be launched into the air like a bullet.
- 7. ALWAYS USE SPINDLE BRAKE OR WAIT FOR SPINDLE TO STOP ROTATING BEFORE MAKING ANY ADJUSTMENTS.** Never grab spindle, or use an object to slow the spindle down.
- 8. NEVER PLACE HAND NEAR A ROTATING CUTTER.** Placing hands near the rotating cutter or bit is extremely dangerous and can cause the operator to become injured.

CAUTION

No list of safety guidelines can be complete. Every shop environment is different. Always consider safety first, as it applies to your individual working conditions. Use this and other machinery with caution and respect. Failure to follow guidelines could result in serious personal injury, damage to equipment or poor work results.

SECTION 2: CIRCUIT REQUIREMENTS

220V Operation

The Model G8030 has a 3 H.P., 3450 R.P.M. motor which requires a 220V single-phase circuit. The cord set enclosed does not have a plug as the style of plug you require will depend upon the type of service you currently have or plan to install. The motor will safely draw about 15 amps at 220V under load. If you operate the Model G8030 on any circuit that is already close to its capacity, it might blow a fuse or trip a circuit breaker. However, if an unusual load does not exist, and power failure still occurs, have the circuit inspected by a qualified electrician.



Circuit Load

When operating at 220V, we recommend using a NEMA-style 6L-20 plug and outlet. **See Figure 1.** You may also “hard-wire” the machine directly to your panel, provided you place a disconnect switch near the machine. Check the electrical codes in your area for specifics on wiring requirements.

Under normal use, the motor draws approximately 15 amps at 220V. We recommend a 20 amp circuit breaker for 220V operation. This should be satisfactory for normal use while providing enough protection against circuit damage caused by power surges.

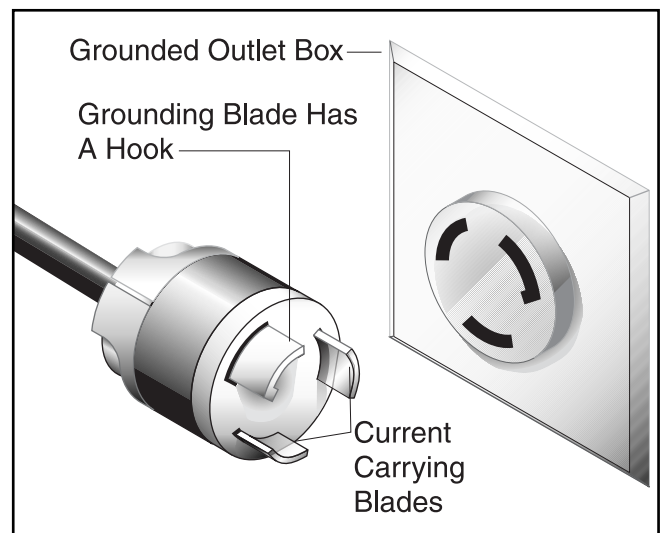

Figure 1. Typical 220V 3-prong plug and outlet



Grounding

In the event of a malfunction or breakdown, grounding provides electric current a path of least resistance. This tool is equipped with an electric cord having an equipment-grounding conductor which must be properly connected to a grounding plug. The plug must be plugged into a matching outlet that is properly installed and grounded in accordance with all local codes and ordinances.

Improper connections of the electrical-grounding conductor can result in risk of electric shock. The conductor with green or green and yellow striped insulation is the electrical-grounding conductor. If repair or replacement of the electric cord or plug is necessary, do not connect the equipment grounding conductor to a live terminal.

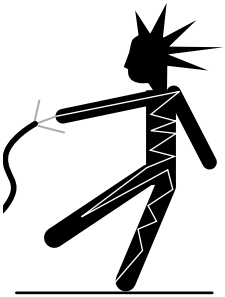
	<p>⚠ WARNING</p> <p>This equipment must be grounded. Verify that any existing electrical outlet and circuit you intend to plug into is actually grounded. Under no circumstances should the grounding pin from any three-pronged plug be removed. Serious injury may occur.</p>
--	--



Extension Cords

We do not recommend the use of extension cords with 220V equipment. It is much better to arrange the placement of your equipment and the installed wiring to eliminate the need for extension cords. Should it be necessary to use an extension make sure the cord is rated Hard Service (grade S) or better. Refer to the chart in **Section 1: Safety Instructions** to determine the minimum gauge for the extension cord. The extension cord must also contain a ground wire and plug pin. Always repair or replace extension cords when they become worn or damaged.



Wiring Diagram

Your Model G8030 comes pre-wired for 220 volt operation. A wiring diagram is provided at the back of this manual should it be necessary to repair or revise the wiring. Always utilize a qualified electrician when doing any electrical work on this equipment.

⚠ CAUTION

We have covered some basic electrical requirements for the safe operation of your machine. These requirements are not necessarily comprehensive. You must be sure that your particular electrical configuration complies with local and state codes. Ensure compliance by checking with your local municipality or a licensed electrician.



SECTION 3: INTRODUCTION

Commentary

We are proud to offer the Grizzly Model G8030 Overarm Router. The Model G8030 is part of a growing Grizzly family of fine woodworking machinery. When used according to the guidelines set forth in this manual, you can expect years of trouble-free, enjoyable operation and proof of Grizzly's commitment to customer satisfaction.

The Model G8030 is intended for heavy-duty professional use. It features a 3 H.P., 220V single-phase motor and magnetic power switching, as well as a precision-ground cast iron table, a brake lever, a foot control for the vertical spindle movement and a front mounted switch. The Model G8030 operates at 20,000 R.P.M., giving you clean and smooth cuts.

A wide variety of router bits for the Model G8030 are available. Please refer to the current Grizzly catalog for more information.

We are also pleased to provide this manual with the Model G8030. It was written to guide you through assembly, review safety considerations, and cover general operating procedures. It represents our latest effort to produce the best documentation possible. If you have any criticisms that you feel we should address in our next printing, please write to us at the address below:

Grizzly Industrial, Inc.
% Technical Documentation
P.O. Box 2069
Bellingham, WA 98227

Most importantly, we stand behind our machines. If you have any service questions or parts requests, please call or write us at the location listed below.

Grizzly Industrial, Inc.
2406 Reach Road
Williamsport, PA 17701
Phone: (570) 546-9663
Fax: (800) 438-5901
E-Mail: techsupport@grizzly.com
Web Site: <http://www.grizzly.com>

After Fall 2001:
Grizzly Industrial, Inc.
1203 Lycoming Circle
Pennsdale, PA 17756

The specifications, drawings, and photographs illustrated in this manual represent the Model G8030 as supplied when the manual was prepared. However, owing to Grizzly's policy of continuous improvement, changes may be made at any time with no obligation on the part of Grizzly. Whenever possible, though, we send manual updates to all owners of a particular tool or machine. Should you receive one, we urge you to insert the new information with the old and keep it for reference.

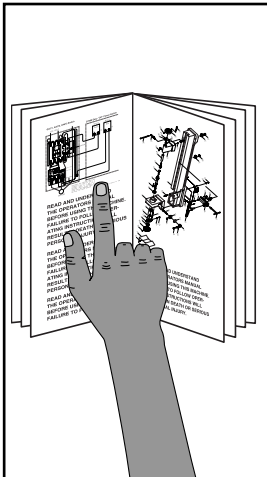
	<p>⚠ WARNING</p> <p>Read the manual before assembly and operation. Become familiar with the machine and its operation before beginning any work. Serious personal injury may result if safety or operational information is not understood or followed.</p>
--	---



Unpacking

The Model G8030 is shipped from the manufacturer in a carefully packed carton. If you discover the machine is damaged after you've signed for delivery, immediately call Customer Service for advice.

When you are completely satisfied with the condition of your shipment, you should inventory its parts.

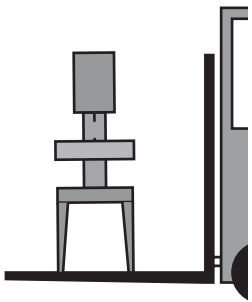

⚠ WARNING

The G8030 is a heavy machine, 683 lbs. shipping weight. **DO NOT over-exert yourself while unpacking or moving your machine – you will need assistance and power equipment. Serious personal injury may occur if safe moving methods are not followed.**

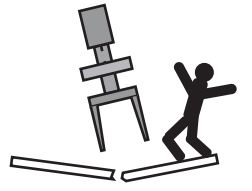

⚠ WARNING

Make sure floor structure is capable of supporting the combined weight of the machine parts and people.

NOTICE

Save all containers and packing materials until you are satisfied that your Model G8030 has arrived in good condition. Freight company adjusters will want to inspect those materials in the event that a freight claim must be made.



Piece Inventory

After all the parts have been removed from the carton, you should have:

- Overarm Router Unit
- Fence
- Hardware Box

The G8030 Hardware Box contains:

Hardware	Qty
Brake Handle	1
Spacer Set	18
Draw Bar	1
Draw Nut	1
Spindle Wrench Set	1
Safety Guard	1
Safety Guard Shaft	1
Starting Pins	3
Hold Downs	4
Hold Down Bars	2
Hold Down Brackets	4
3/8"-16 x 1" Hex Bolts	3
3/8" Lock Washers	3
5/16"-18 x 1" Flat Head Screws	4
5/16"-18 x 3/4" Flat Head Screws	2
5/16" Flat Washers	4
5/16" Hex Nuts	6
Handle For Hand Wheel	1

In the event that any nonproprietary parts are missing (e.g. a nut or a washer), we would be glad to replace them, or, for the sake of expediency, replacements can be obtained at your local hardware store.

NOTICE

A full parts list and breakdown can be found toward the end of this manual. For easier assembly, or to identify specific parts, please refer to the detailed illustrations at the end of the manual.



Clean Up

The unpainted surfaces are coated with a waxy oil to protect them from corrosion during shipment. Remove this protective coating with a solvent cleaner or citrus-based degreaser such as Grizzly's G7895 Degreaser. Avoid chlorine-based solvents as they may damage painted surfaces should they come in contact. Always follow the usage instructions on the product you choose for clean up.

	<p>⚠️ WARNING Do not use gasoline or other petroleum-based solvents. They have low flash points which make them extremely flammable. A risk of explosion and burning exists if these products are used. Serious personal injury may occur if this warning is ignored.</p>
--	--

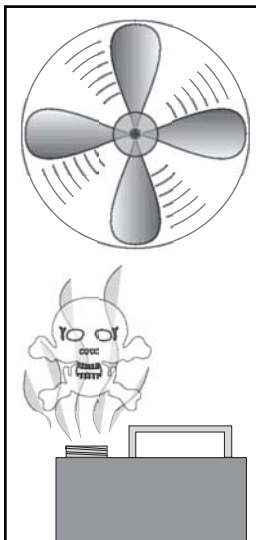
	<p>⚠️ CAUTION Many of the solvents commonly used to clean machinery can be toxic when inhaled or ingested. Always work in well-ventilated areas far from potential ignition sources when dealing with solvents. Use care when disposing of waste rags and towels to be sure they do not create fire or environmental hazards.</p>
---	--

	<p>⚠️ WARNING Do not smoke while using solvents. A risk of explosion or fire exists and may result in serious personal injury.</p>
---	---



Site Considerations

FLOOR LOAD

Your Model G8030 represents a large weight load in a small footprint. Most commercial or home shop floors should be sufficient to carry the weight of the Model G8030. If you question the strength of your floor, you can opt to reinforce it.

WORKING CLEARANCES

Working clearances can be thought of as the distances between machines and obstacles that allow safe operation of every machine without limitation. Consider existing and anticipated machine needs, size of material to be processed through each machine, and space for auxiliary stands and/or work tables. Also, consider the relative position of each machine to one another for efficient material handling. Be sure to allow yourself sufficient room to safely run your machines in any foreseeable operation.

LIGHTING AND OUTLETS

Lighting should be bright enough to eliminate shadows and prevent eye strain. Electrical circuits should be dedicated or large enough to handle combined motor amp loads. Outlets should be located near each machine so power or extension cords are not obstructing high-traffic areas. Be sure to observe local electrical codes for proper installation of new lighting, outlets, or circuits.

	<p>⚠️ CAUTION Make your shop "child safe." Ensure that your workplace is inaccessible to youngsters by closing and locking all entrances when you are away. Never allow visitors in your shop when assembling, adjusting or operating equipment.</p>
--	---



SECTION 4: ASSEMBLY

Beginning Assembly

⚠️ WARNING

All die-cut metal parts have a sharp edge (called “flashing”) on them after they are formed. This is removed at the factory. Sometimes, though, a bit of flashing might escape inspection. Please examine the edges of all die-cut metal parts before handling them or serious injury may occur.

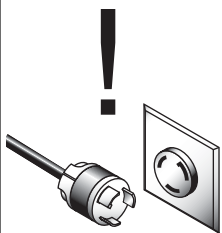

⚠️ WARNING

Disconnect power to the machine when performing any maintenance, assembly or adjustments. Failure to do this may result in serious personal injury.

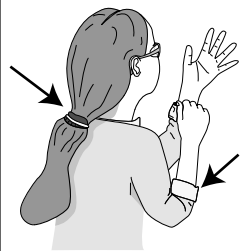

⚠️ WARNING

Keep loose clothing rolled up and out of the way of machinery and keep hair pulled back.



⚠️ WARNING

Wear safety glasses during the entire assembly process. Failure to comply may result in serious personal injury.

Most of your Model G8030 Overarm Router has been assembled at the factory, but some parts must be assembled or installed after delivery. We have organized the assembly process into steps. Please follow along in the order presented here.

TOOLS REQUIRED: You will need a straight-edge, 12mm, 14mm, 15mm open end wrenches, and a 3 mm Allen® wrench.



Power Panel

The power panel at the rear of the Model G8030 must be properly wired with a safe ground. The green wire is the ground wire and is usually the wire on the right when facing the panel as shown in **Figure 2**. Please read **Section 2: Circuit Requirements** for further information on wiring.

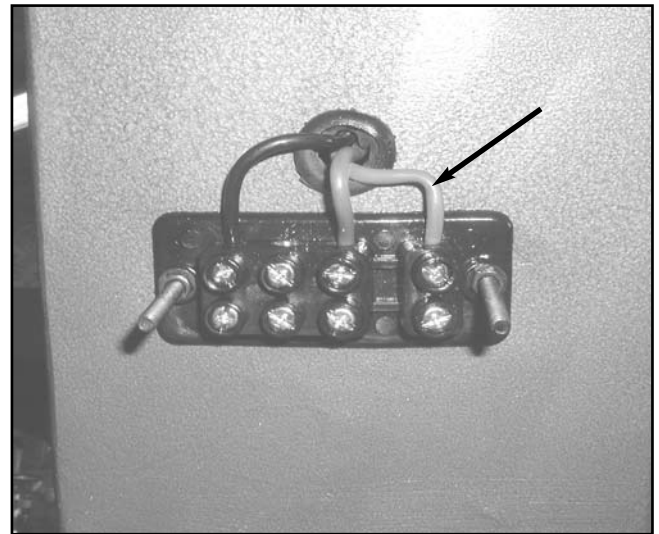

Figure 2. G8030 power panel, with ground wire on right.



Spindle Rotation Check

The Model G8030 spindle must rotate in the direction of the arrow on the face of the machine.

To check rotation:

1. Disconnect the machine from the power source.
2. Turn the spindle by hand as shown in **Figure 3**.
3. Make sure the nut is secure.
4. Start the machine and observe the direction of the spindle travel.
5. If the spindle rotates in the opposite direction, call our customer service department for help.

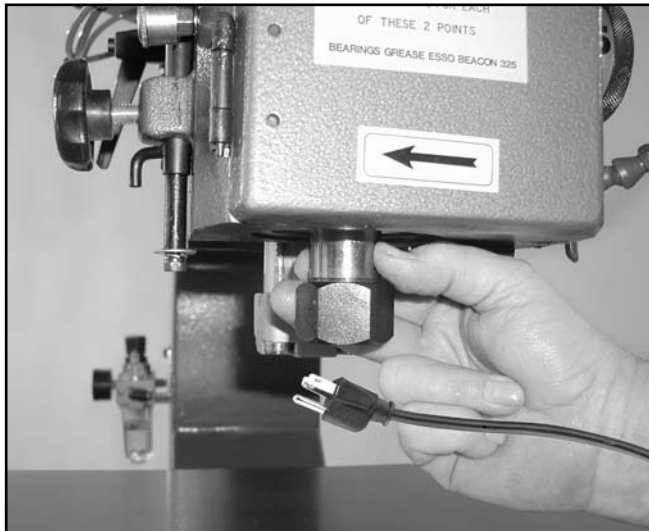

Figure 3. Spindle and nut. Note arrow direction.

CAUTION

Make certain the spindle nut is secure and your hand is well away before starting the motor. If either condition is not met, it is highly possible there will be an injury to the operator.



Air Tubes/Foot Switch Connection

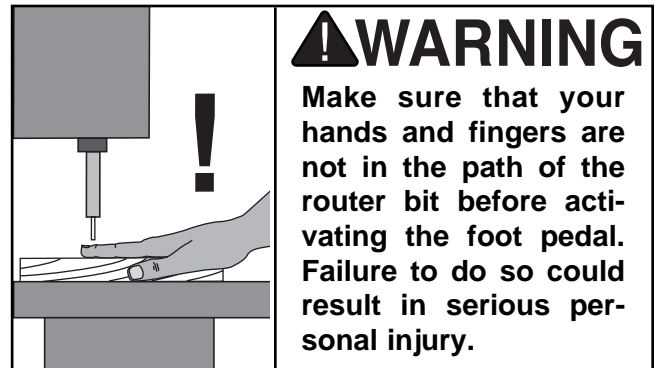

The foot switch controls the direction of vertical spindle travel. Step on the switch and the spindle comes down. Step off the switch and the spindle rises from the work area.

1. Turn the yellow switch housing upside down.
2. Insert the three hoses—blue, yellow and orange—through the grommet in the back of the housing.
3. Make sure each hose is aligned with the correct fitting before inserting, as removal is difficult as shown in **Figure 4**.

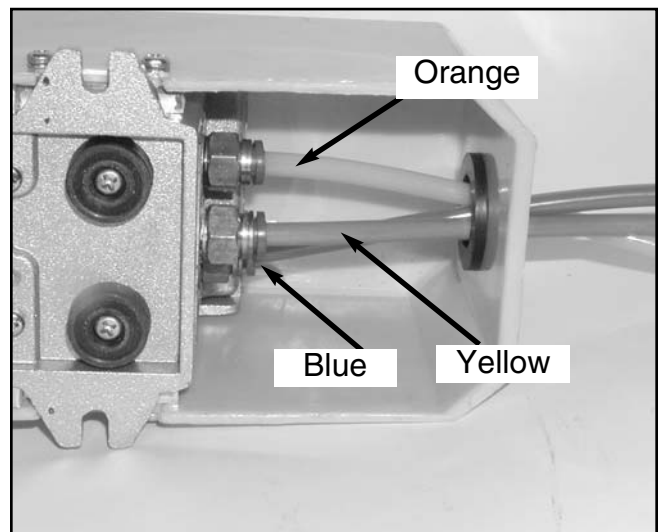

Figure 4. Installing air hoses.

NOTICE

The foot switch is never used when the spindle is not running. Make sure the spindle is turning before stepping on the foot switch.

4. Connect an air compressor to the regulator. Air pressure must be 90 pounds per square inch.
5. To raise the air pressure, lift the air unit cap and turn it counterclockwise as shown in **Figure 5**.

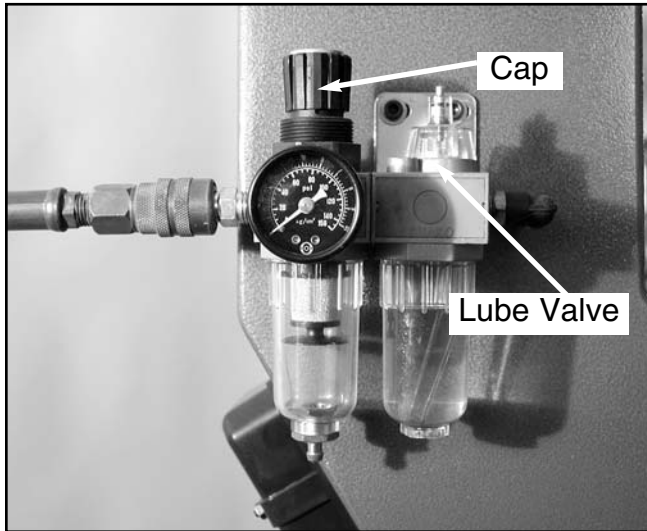

Figure 5. Lift and turn cap to adjust air pressure. Turn lube valve to lubricate foot switch control.



Chip Blower

The air line control is used to check and control air flow to the chip blower.

1. Turn control on and off to see if pressure exists as shown in **Figure 6**.
2. Adjust flow to most effectively remove chips from the line of sight.

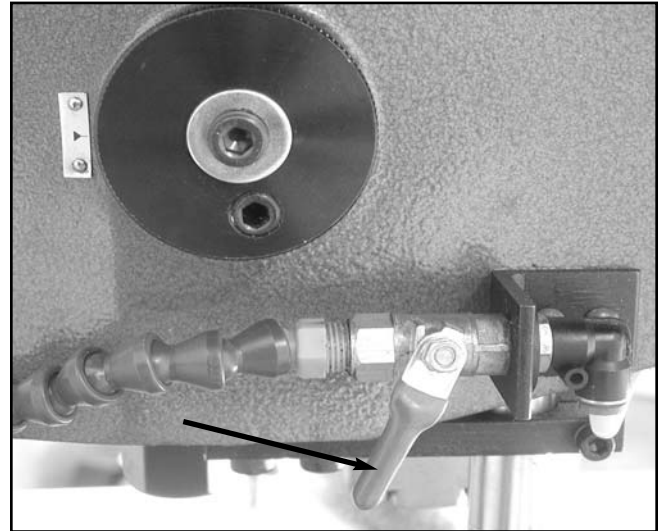

Figure 6. Air line control for chip blower.

⚠ CAUTION

Compressed air can be very dangerous if not handled carefully. Never point an air hose nozzle or blower towards any person, including yourself. Failure to comply with this caution could result in serious injury.



Bit Installation

CAUTION

Router bits are very sharp. Use care in handling to prevent injury.

WARNING

Always use bits that are rated for 20,000 R.P.M. or higher. Do not use bits that are designed for slow R.P.M. operation. If you do not know the maximum rated R.P.M. for a particular bit, do not use it in the overarm router. The bit could break apart under the high centrifugal forces, causing flying metal to be launched into the air like a bullet. Serious personal injury or death could result.

The Model G8030 Overarm Router uses standard router bits.

1. Place the proper collet on the spindle. You can use $\frac{1}{4}$ " or $\frac{1}{2}$ " size.
2. Install the nut loosely as shown in **Figure 7**.



Figure 7. Installing collet nut.

3. Slide the base of the router bit into the collet as shown in **Figure 8**.
4. Finger tighten the nut, keeping a grip on the bit.



Figure 8. Installing the router bit.



Bit Tightening

The installed router bit must be carefully tightened. Two open end wrenches are supplied with the machine.

1. Place one wrench on the flats of the spindle as shown in **Figure 9**.
2. Place the second wrench on the collet nut.
3. Turn until tight.

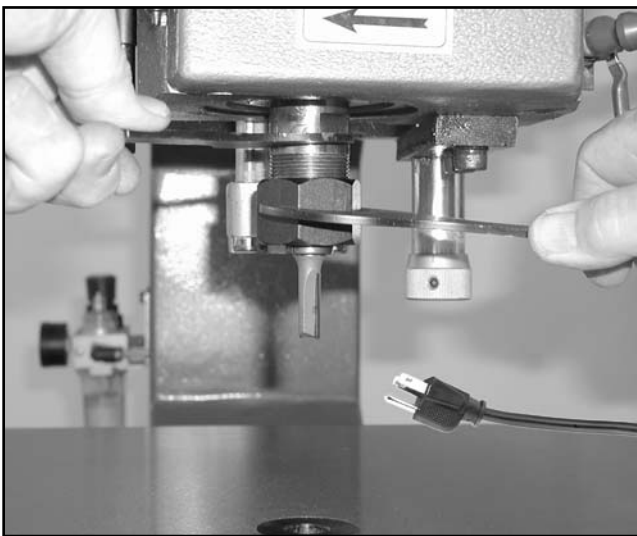

Figure 9. Tightening the collet nut.

CAUTION

Do not use the spindle brake to tighten the collet nut. The collet nut must be secured using the two supplied wrenches. If the collet nut is not secured properly, the bit could fly out of the collet like a bullet. Serious personal injury could result.



Installing the Shield

The dust shield also serves to help keep chips away from the operator's face. Installation is quick.

1. Slide the shield onto its post and place the post in its guide hole on the side of the head.
2. Install the hex head bolt in the bottom of the post. Use a flat washer between the bolt head and the shield as shown in **Figure 10**.
3. Swing the dust shield into place and tighten it with the hand screw.

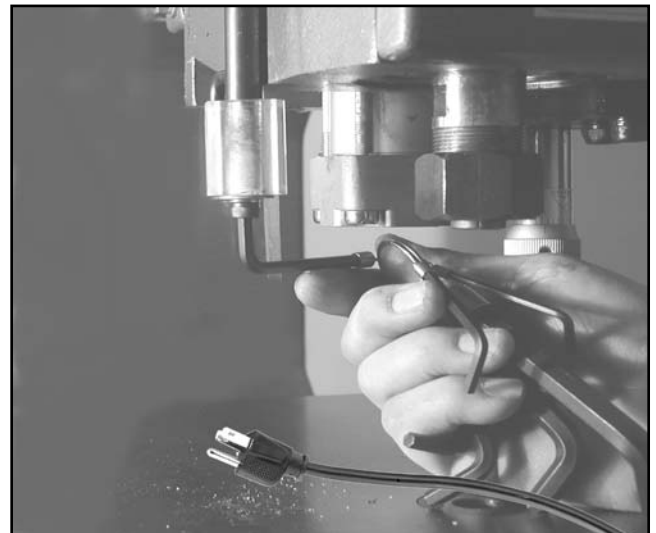

Figure 10. Securing the dust shield.



Installing the Brake Handle

The hand brake serves to stop the spindle when repositioning the workpiece. The machine must be turned off before you begin applying the brake to the spindle

1. Slide the brake lever into its hole as shown in **Figure 11**.
2. Tighten the hex head nut to hold the brake lever in place.

NOTICE

Always turn off the power switch before applying the hand brake. Applying the brake does not disengage the power switch. Failure to do so will result in damage to the braking mechanism.

CAUTION

Always stop the spindle with the brake, or allow it to come to a complete stop before moving hands near the spindle.

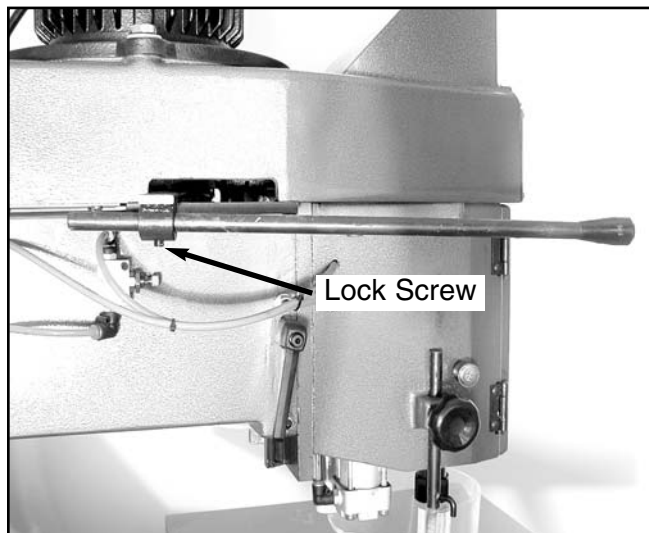

Figure 11. Installed brake lever.



Installing the Fence

The fence is used for straight routing and is easily installed and removed.

1. Place the fence at the location in which it is to be used as shown in **Figure 11**.
2. Assemble and tighten the fence lock as shown in **Figure 12**.
3. Assemble and tighten the fence lock on the other side of the table.

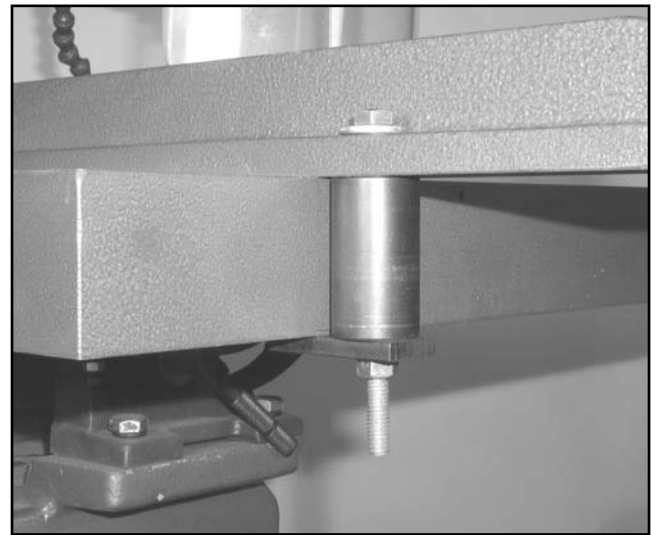

Figure 12. Fence lock in place.



SECTION 5: ADJUSTMENTS

Adjusting the Belt

⚠ WARNING

All die-cut metal parts have a sharp edge (called "flashing") on them after they are formed. This is removed at the factory. Sometimes, though, a bit of flashing might escape inspection. Please examine the edges of all die-cut metal parts before handling them. Serious injury may occur.

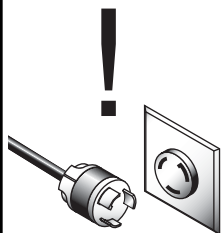

⚠ WARNING

Disconnect power to the machine when performing any maintenance, assembly or adjustments. Failure to do this may result in serious personal injury.

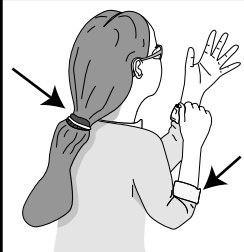

⚠ WARNING

Keep loose clothing rolled up and out of the way of machinery and keep hair pulled back.



⚠ WARNING

Wear safety glasses during the entire adjustment process. Failure to comply may result in serious personal injury.

A slipping belt wastes power, causes control problems and wears the belt out prematurely. You should be able to deflect the belt $\frac{1}{2}$ " to $\frac{3}{4}$ " with moderate finger pressure. The belt will slip if too loose and squeal or cause vibration if too tight.

If the belt is too loose, or too tight:

1. Loosen the bolts around the motor base as shown in **Figure 13**.

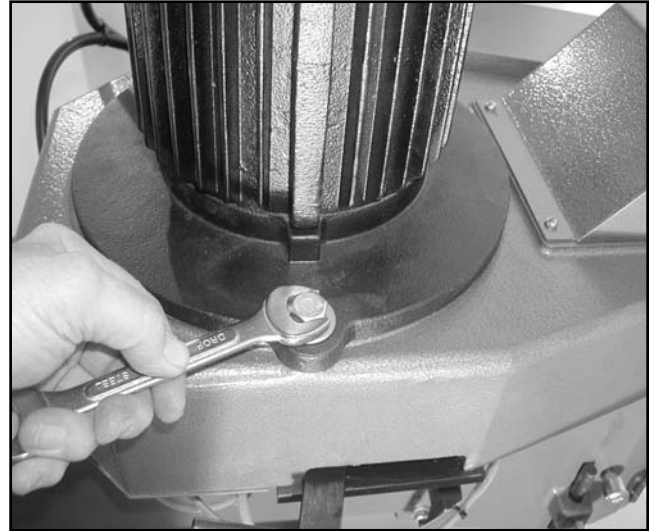

Figure 13. Loosening motor mount bolts.

2. Locate the handle on the motor base, and use it to pull the belt tight. A backwards pull tightens the belt as shown in **Figure 14**.

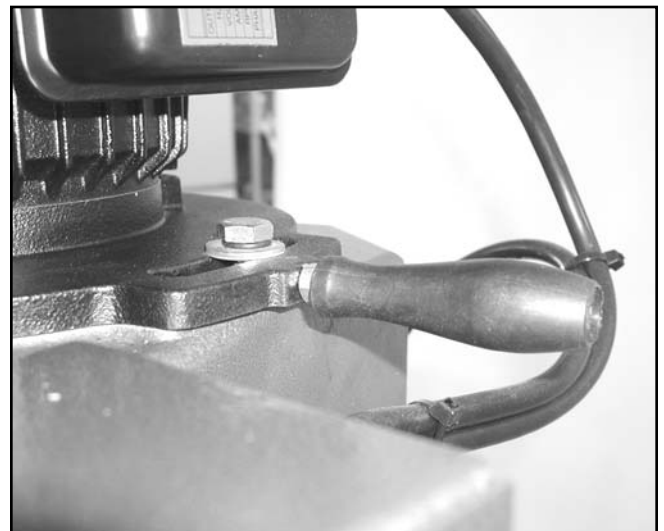

Figure 14. Belt adjustment handle.

3. Tighten the motor mount plate bolts.
4. Check tension. If it is not correct, repeat **Steps 1 to 4**.



Spindle Lowering Speed

The Model G8030 Overarm Router uses an air valve to control the speed with which the spindle is lowered.

1. Increase or decrease lowering speed, as desired, by turning the knurled knob as shown in **Figure 13**.
2. We suggest you try different settings until you find the most useful speed to use. Hardwoods will require a slower setting than softwoods.

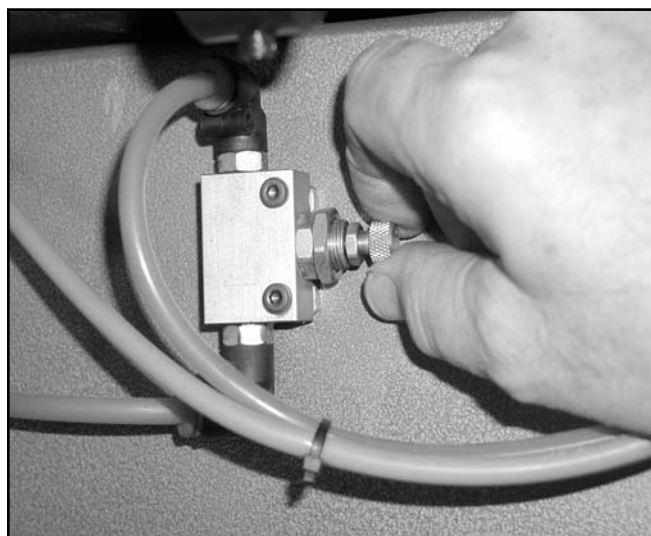

Figure 15. Spindle adjustment.



Table Tilt Adjustment

The table on the Model G8030 adjusts from a 0° to 45° angle of tilt. The right side trunnion is marked in degrees, and both trunnions have locking handles to secure the table in the exact position needed.

1. Loosen the table lock handles as shown in **Figure 16**.

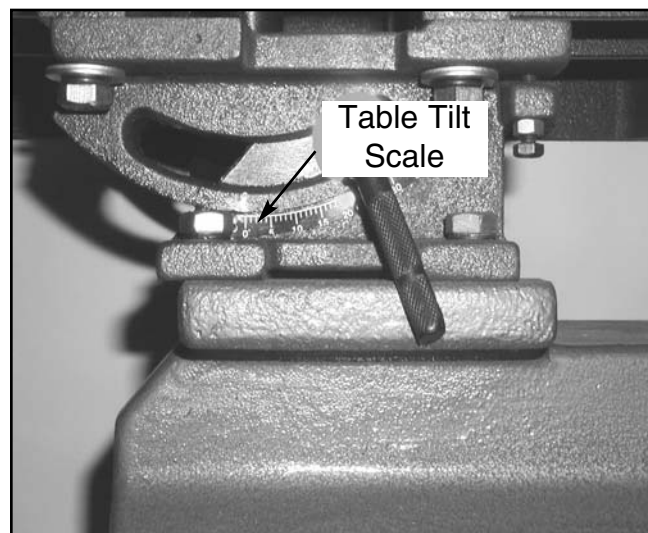

Figure 16. Table tilt adjustment scale and handle.

2. Tilt the table until it reaches the required angle.
3. Tighten the right and left locking handles securely.



Spindle Base Adjustment

The handwheel adjusts the main spindle base up or down, as needed.

1. Unlock the spindle locking handle shown in **Figure 18**.
2. Turn the handwheel to decrease or increase the spindle base height from the table as shown in **Figure 17**.

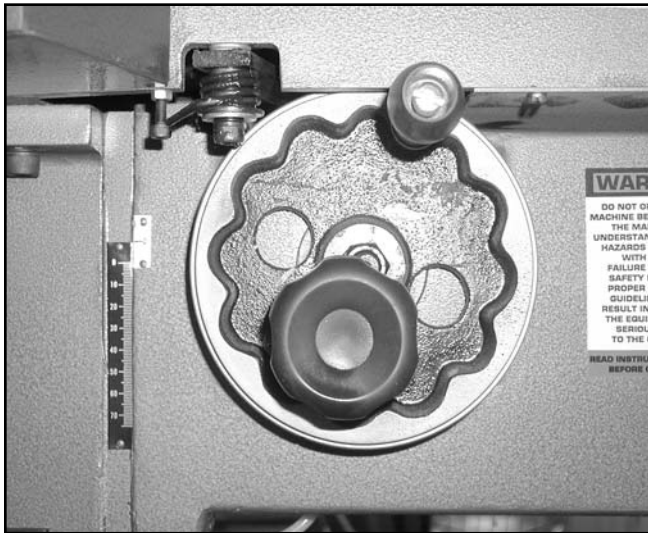

Figure 17. Handwheel, with height scale to left.

3. The height scale on the left makes keeping track of the spindle height simple.

4. Use the locking handle on the other side of the head to lock in the spindle height adjustments as shown in **Figure 18**.



Figure 18. Locking handle.

5. Position the spindle base on the highest setting allowable. It is safer to adjust the spindle base down to the correct depth of cut. If the spindle base is too low, you run the risk of the router bit hitting the table when activating the foot pedal.

CAUTION

Adjust the spindle base to the highest setting before operating the router. If the spindle base is set too low, you run the risk of the router bit hitting the table during operation. Serious personal injury could occur.



Cutting Depth Control Knob

The Model G8030 uses a rapid adjusting ring to control the cutting depth of the spindle. There are six settings on the ring.

1. Simply twist the ring to the adjustment that corresponds with the depth required as shown in **Figure 19**.



Figure 19. Depth control ring.

2. Each number has a corresponding bolt that can be adjusted to a predetermined depth. This will be explained further in the next section.



Micro Adjustments

The Model G8030 spindle depth stop can be finely adjusted from the bolts on the inside of the head cover, which are fixed to the depth control wheel.

1. Open the door on the front of the head and locate the bolts. Note that there are locking nuts on each adjustment bolt.
2. The indicated number on the depth control ring corresponds to the bolt in the vertical position.

3. Back off the locking nut a quarter turn. Then adjust the bolt as shown in **Figure 20**.



Figure 20. Locking bolts and lock nuts.

4. Retighten locking nuts and check settings.
5. Bolt heads can be reached in sequence by turning the depth control ring.
6. You will need to make sure the cutting bit doesn't slam into the table when the foot pedal is pressed. Measure the distance between the end of the installed bit and the table. This distance should always be greater than the distance between the depth setting bolt head and the stationary hex bolt head immediately above the depth setting bolt head. This will ensure the bit will not hit the table. The next step will be to fine tune the depth for the specific application.
7. Place the desired workpiece onto the router table. If a template tray/pattern is used under the workpiece, make sure that it is in place. Now measure the distance between the bottom of the cutting bit and the top surface of the workpiece. Add this measurement to the depth of cut you want to make. This is the overall distance that the bit should plunge. Make sure that the distance between the hex bolt head on the depth setting ring, and the one directly above it, is the same as the overall distance you want the bit to plunge. Test the setup on a piece of scrap wood of the same thickness.



SECTION 6: OPERATIONS

Test Run

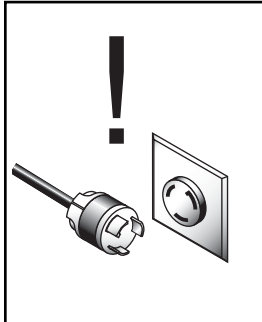

!WARNING
Disconnect power to the machine when performing any maintenance, assembly or adjustments. Failure to do this may result in serious personal injury.

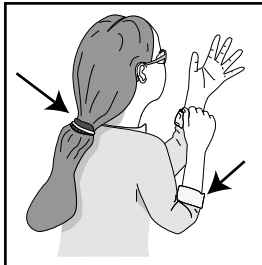

!WARNING
Keep loose clothing rolled up and out of the way of machinery and keep hair pulled back.



!WARNING
Wear safety glasses during the entire operation process. Failure to comply may result in serious personal injury.

Once assembly is complete and adjustments are done to your satisfaction, you are ready to test run the machine.

Turn on the power supply at the main panel. Press the START button. Make sure that your finger is poised on the switch, just in case there is a problem. The machine should run smoothly, with little or no vibration or rubbing noises. Strange or unnatural noises should be investigated and corrected before operating the machine further.

If you cannot easily locate the source of an unusual noise or vibration, contact our service department for help.



!WARNING

Always use bits that are rated for 20,000 R.P.M. or higher. Do not use bits that are designed for slow R.P.M. operation. If you do not know the maximum rated R.P.M. for a particular bit, do not use it in the overarm router. The bit could break apart under the high forces, causing flying metal to be launched into the air like a bullet. Serious personal injury or death could result.

Guide Pin Installation

Pattern and template cuts are made by sliding the work or template against a guide pin, which may be one of six included with the Model G8030 (three pins, two sizes each).

1. Place the guide pin in its hole in the table as shown in **Figure 21**.

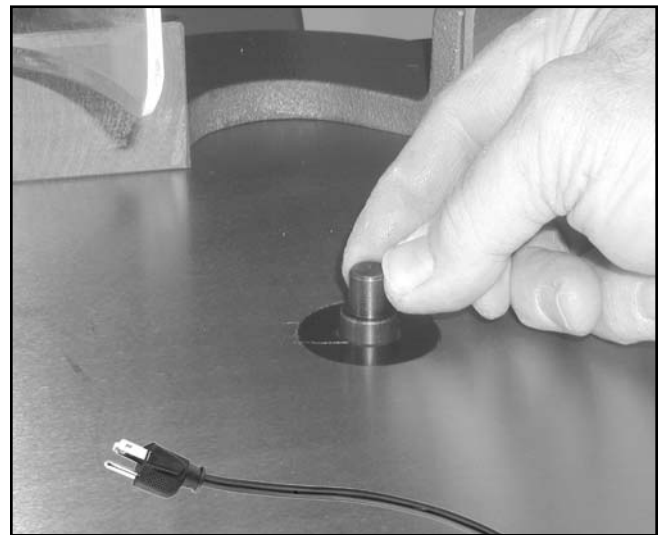

Figure 21. Installing a guide pin.

2. Check guide pin height.
3. Locate adjuster bolt and lock nut directly under the guide pin in the table as shown in **Figure 22**. Turn the bolt until the desired depth is obtained and then lock in place with the nut. The guide pin shoulder should be flush or below the table surface.

G8030 3 H.P. Overarm Router

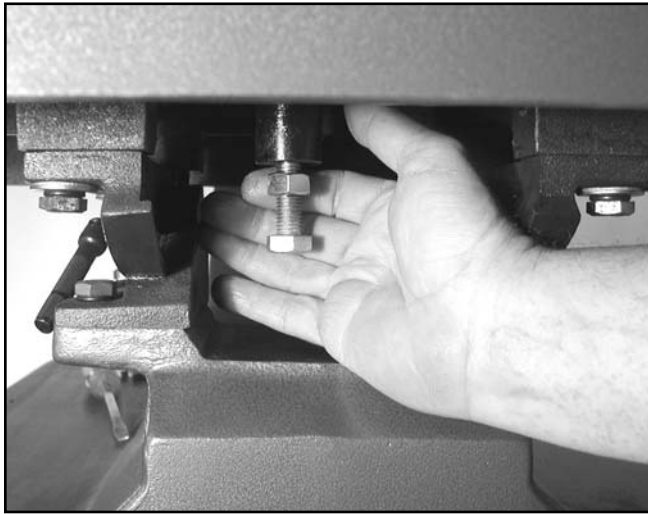
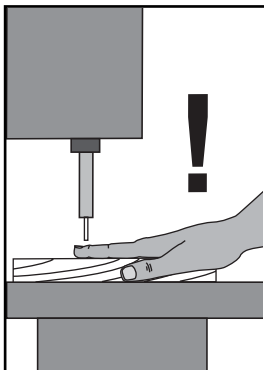

Figure 22. Location of guide pin height lock.



Pattern Routing



! WARNING

Make sure that your hands and fingers are not in the path of the router bit before activating the foot pedal. Failure to do so could result in serious personal injury.

The overarm pin router truly excels in the area of pattern routing. The basic set-up consists of a guide pin and router bit that have the same diameter. The guide pin is mounted in the table directly below the position of the installed router bit. When used in conjunction with a pattern mounted to the underside of the workpiece, the operator is able to guide the pattern along the pin while transferring the exact routing path to the top of the workpiece.

This operation can be used to rout consistent grooves in the tops of workpieces; however, it can also be used to cut consistent shapes completely out of workpieces. It is also helpful when many pieces of the exact same profile are required, or when making even one cutting operation where absolute precision is required on the initial attempt. It only takes one mistake to ruin expensive lumber or a time consuming assembly.

G8030 3 H.P. Overarm Router

The key to successful pattern routing is having good patterns to follow. The time you spend making accurate patterns will save a lot of time during production runs, as well as reducing the amount of wasted lumber from mis-cuts. Take the time to follow our pattern making directions and you will be on your way to very efficient routing operations. For this example, we will be making a “smiley” face.

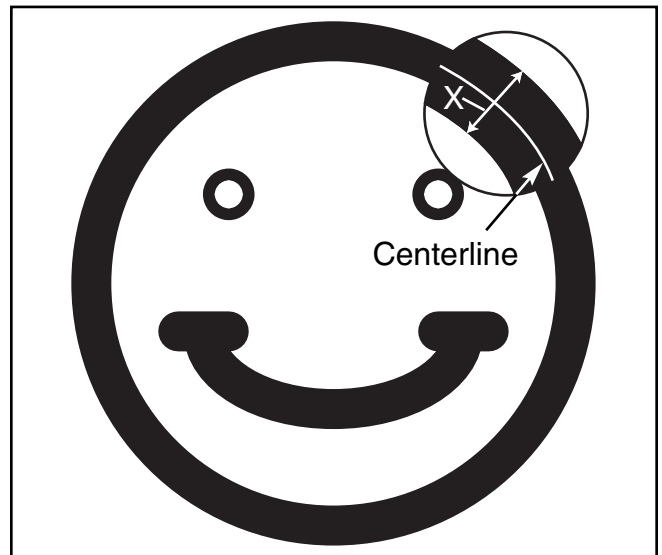

Figure 23. “X” equals the diameter of the router bit.

1. Draw out the full scale pattern on a piece of paper. A computer aided drawing program can be helpful here, but it is not necessary. Be sure that the pattern drawing takes into account the area that will be cut away during the routing operation. It is best to draw a line that represents the centerline, then draw two more lines on each side of the centerline, representing the actual width of the routed line. For example, we are using a $\frac{1}{4}$ " bit, so we need to measure $\frac{1}{8}$ " off of either side of the centerline to account for the full width of the routed line as shown in **Figure 23**.
2. Using spray adhesive, glue the paper pattern to a piece of $\frac{1}{8}$ " to $\frac{1}{4}$ " birch plywood.
3. Using a jig saw or scroll saw, cut out the area that represents the full width of the routed area. Use a drill to make saw starts that are located on the inner part of the pattern. A $\frac{1}{4}$ " diameter drill bit can also be used to make the rounded holes and ends of lines.

4. Once all the waste areas have been removed from the pattern, mount them to a piece of medium density fiberboard (MDF). Center and glue the pattern pieces to the MDF.
5. Cut (4) 1/2" wide strips of the same birch plywood used for the pattern. Glue them on the four sides of the MDF, on the same side as the pattern. These will serve as runners to keep the whole assembly level when performing the routing operation as shown in **Figure 24**.

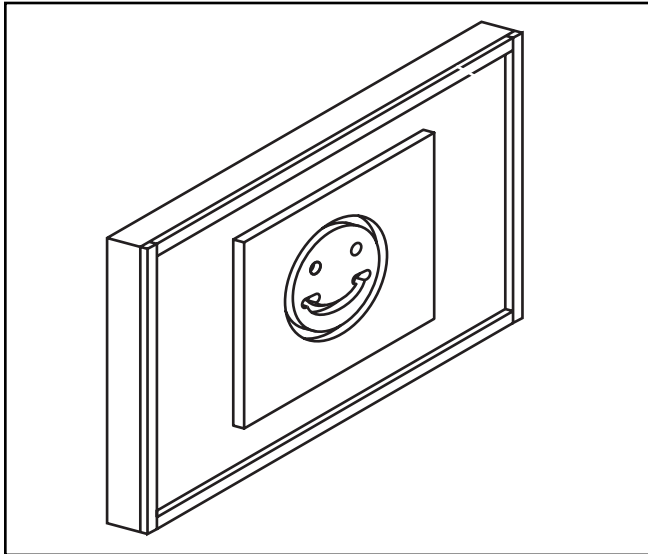

Figure 24. Bottom side of the pattern template.

6. Flip the MDF over to the blank side. Two dowels and clamps need to be mounted as shown in **Figure 25**.
7. Determine the size of the workpiece that will be used with the pattern. Center the workpiece over the area that contains the pattern cut-outs on the other side. Install the dowels at the opposite sides of the clamps so that the workpiece will be held secure.
8. Your template is now ready for use. Simply clamp the workpiece into the pattern template and place it on the guide pin on the router table. Push the pattern template clockwise around the entire pattern, making sure the template guides through the entire pattern with no hang ups.

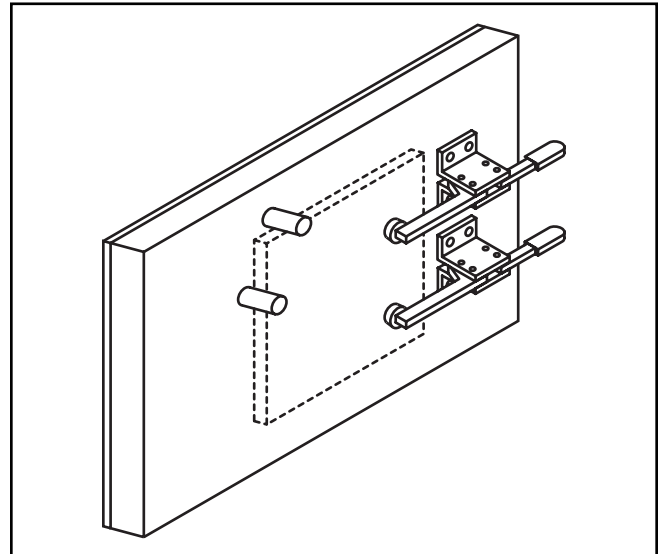

Figure 25. Top side of the pattern template.

NOTICE

Always use a scrap piece of wood when testing your pattern for the first time. Make sure that the desired results are produced before using expensive project wood.



Straight Routing

The overarm router can also be used to do straight routing procedures as well. The overarm router comes with a clamp-on fence that can be adjusted on the table. The guide pin is removed when using the fence. This type of routing is the same as routing on a traditional routing table except that the router is mounted above the workpiece. The advantage of this is having increased visibility of the cut while it is being performed.

1. Set the fence to the position required for the routing application. Tighten down the bolts securely so the fence will not move accidentally.
2. The feed direction will be from the left to the right. Note that this is the opposite way that is normally used for a router table or shaper, where the motor is mounted below the table as shown in **Figure 26**.
3. Establish the correct depth of cut using the depth control knob and the spindle base height handwheel.
4. Activate the foot pedal and slowly feed the workpiece into the router bit.

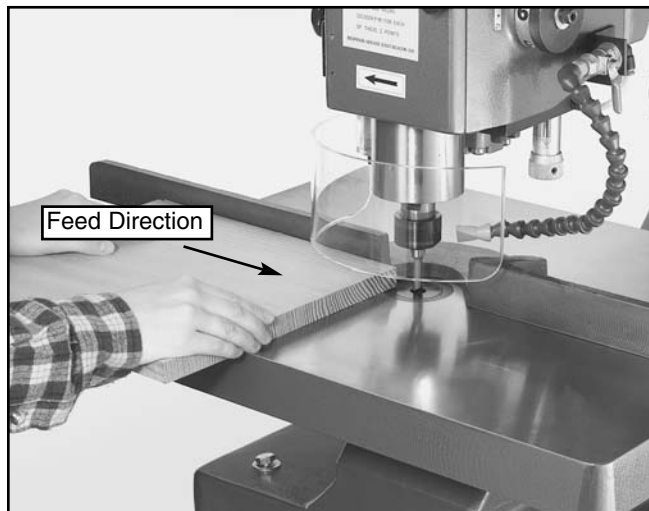

Figure 26. Straight routing direction.



Dust Control

The overarm router produces a significant amount of wood dust. Although it does not have a dedicated dust collection port, we recommend using a universal dust collector attachment such as the Grizzly G2754. Designed to hold a suction inlet as close to the cutting operation as possible without interfering with the machine movement, the dust collector will be able to eliminate most of the wood dust produced. The overarm router is also equipped with a chip blower (**Figure 27**) that can help keep the cutting area clear by blowing and redirecting the wood dust towards the dust collector.

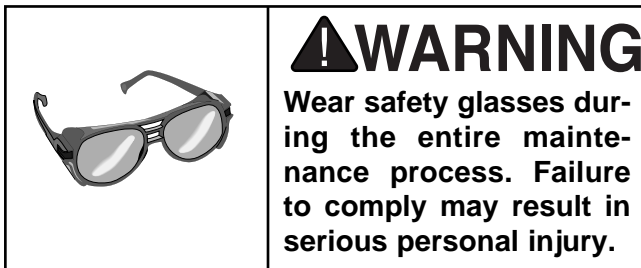
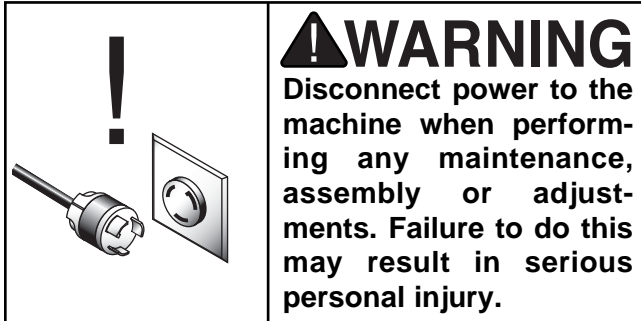

Figure 27. Chip Blower.



SECTION 7: MAINTENANCE

General



Regular periodic maintenance on your Model G8030 Overarm Router will ensure its optimum performance. Make a habit of inspecting your overarm router each time you use it. Check for the following conditions and repair or replace when necessary.

1. Loose mounting bolts.
2. Worn switch.
3. Worn or damaged cords and plugs.
4. Damaged belt.
5. Inspect air fittings and hoses.
6. Any other condition that could hamper the safe operation of this machine.
7. Bleed the water out of the condenser bottle below the air regulator—everyday.



Table

The table and other non-painted surfaces on the Model G8030 should be protected against rust and pitting. Wiping the table clean after every use ensures that wood dust isn't allowed to trap moisture against bare metal surfaces.

Some woodworkers recommend using automotive paste wax on exposed steel and cast iron surfaces. The wax provides a layer of protection, as well as reducing friction between lumber and the table, making cuts faster and smoother. Avoid waxes that contain silicone or other synthetic ingredients. These materials can find their way into lumber that's being worked, and can make staining and finishing difficult. If you use paste wax, make sure that it's 100% Carnuba wax.



Lubrication

The only parts on this machine that require periodic lubrication are the spindle bearings. The frequency of lubrication depends on the amount you use the overarm router. As a habit, inspect the machine at least once a month. To lubricate the spindle cartridge:

1. Turn the grease cup one turn after every four to six weeks of working use. **See Figure 28.**
2. Keep the grease cup filled with NO. 2 grease.



Figure 28. Grease cup.



Drive Belt

Inspect regularly for tension and wear. Check pulleys to ensure that they are properly aligned. See Pulley/Drive belt sections for proper tension and pulley alignment procedures.



SECTION 8: CLOSURE

The following pages contain general machine data, parts diagrams/lists, a troubleshooting guide and Warranty/Return information for your Model G8030.

If you need parts or help in assembling your machine, or if you need operational information, we encourage you to call our Service Department. Our trained service technicians will be glad to help you.

If you have comments dealing specifically with this manual, please write to our Bellingham, Washington location using the address in **Section 3 Introduction**.

We have included some important safety measures that are essential to this machine's operation. While most safety measures are generally universal, Grizzly reminds you that each workshop is different and safety rules should be considered as they apply to your specific situation.

We recommend you keep a copy of our current catalog for complete information regarding Grizzly's warranty and return policy. If you need additional technical information relating to this machine, or if you need general assistance or replacement parts, please contact the Service Department listed in **Section 3 Introduction**.

Additional information sources are necessary to realize the full potential of this machine. Trade journals, woodworking magazines, and your local library are good places to start.

<p>⚠ WARNING</p> <p>Operating this equipment creates the potential for flying debris to cause eye injury. Always wear safety glasses or goggles when operating equipment. Everyday glasses or reading glasses only have impact resistant lenses, they are not safety glasses. Be certain the safety glasses you wear meet the appropriate standards of the American National Standards Institute (ANSI).</p>		
		

<p>⚠ WARNING</p> <p>The Model G8030 was specifically designed for routing operations. DO NOT MODIFY AND/OR USE THIS MACHINE FOR ANY OTHER PURPOSE. Modifications or improper use of this tool will void the warranty. If you are confused about any aspect of this machine, DO NOT use it until all your questions have been answered or serious personal injury may occur.</p>
--

<p>⚠ WARNING</p> <p>Like all power tools, there is danger associated with the Model G8030. Accidents are frequently caused by lack of familiarity or failure to pay attention. Use this tool with respect and caution to lessen the possibility of operator injury. If normal safety precautions are overlooked or ignored, serious personal injury may occur.</p>





MACHINE DATA SHEET

Customer Service #: (570) 546-9663 • To Order Call: (800) 523-4777 • Fax #: (800) 438-5901

MODEL G8030 OVERARM HIGH SPEED ROUTER

Design Type..... Floor Model

Overall Dimensions:

Table24" x 18"
 Overall Height74"
 Height From Table To Floor34"
 Depth35"
 Width (w/o fence).....24"
 Width (w/ fence installed)33½"
 Weight (Shipping).....680 lbs.
 Weight (in place)600 lbs.
 Box Size.....28" L x 40" W x 45" H
 Footprint21½" x 26"

Capacities:

Spindle Stroke3⅝"
 Head Travel5¾"
 Maximum Distance Spindle to Table9½"
 Table Tilt45°
 Swing19½"
 Spindle Speed20,000 RPM
 Spindle BearingsShielded, Lubricated Ball Bearings

Construction:

TableGround Cast Iron
 Fence Assembly.....Cast Iron
 Body AssemblyCast Iron
 StandPre-formed Steel

Motor:

TypeTEFC Capacitor-Start Induction
 Horsepower.....3 HP
 Phase / VoltageSingle Phase / 220 V
 Amps.....15
 Cycle / RPM.....60 Hertz / 3580 RPM
 BearingsShielded & Lubricated Ball Bearings
 SwitchPush On/Off Switch
 Power TransferFlat Belt

Features:

.....Independently Adjustable Split Fence
Insertable Pins for Pin Routing
Table Tilt Locks with Two Positive Stops
Spindle Travels on Dovetailed Ways
Foot Control Allows Hands Free Operation
Pneumatic and Hydraulically Driven Head
Clear Plastic Guard
Six Adjustable Depth Stops
Complete Tool Kit
½" & ¼" Collet
¾" Plunge Router Bit w/ ½" Shank

Specifications, while deemed accurate, are not guaranteed.

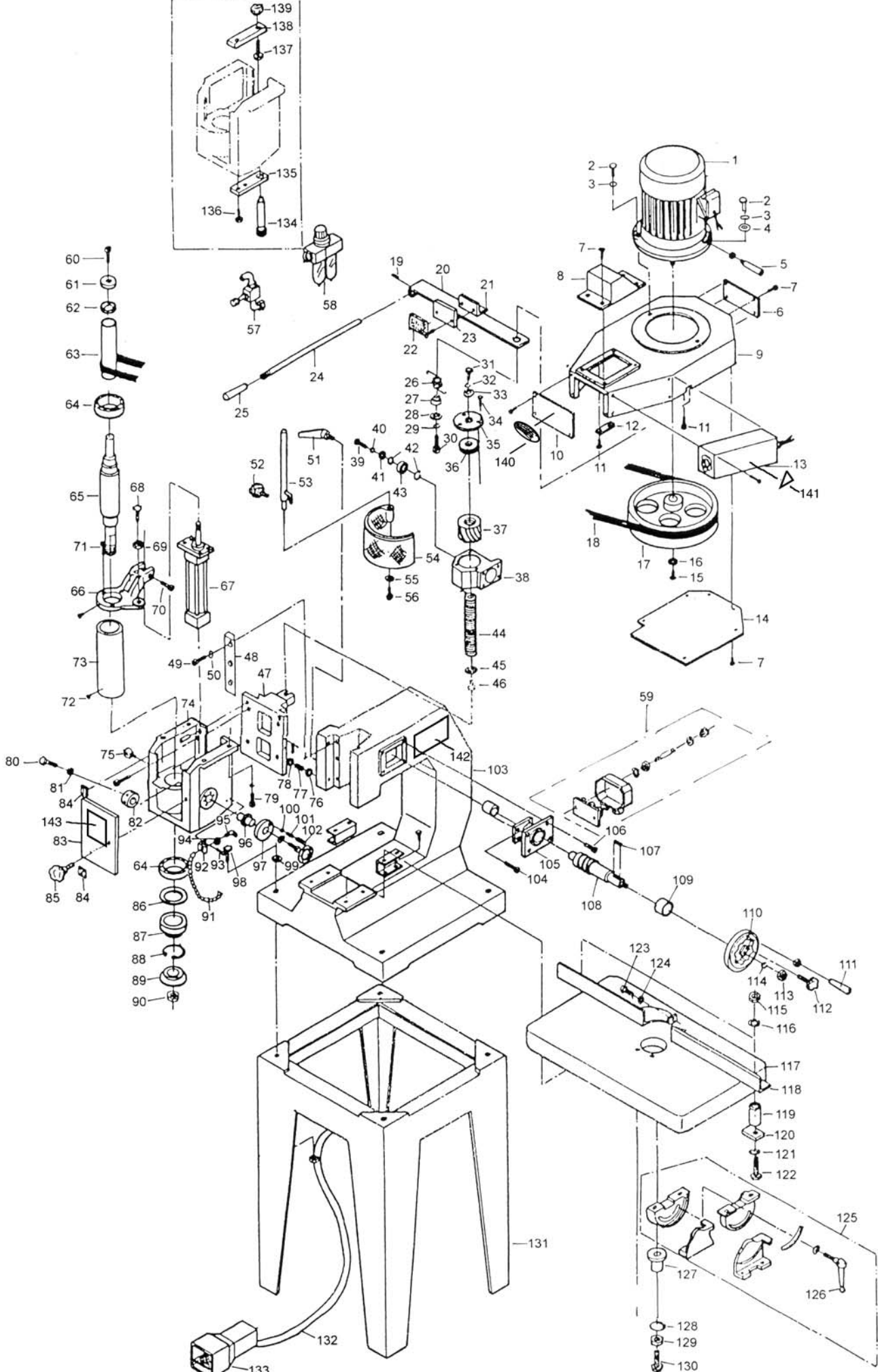

Ref#	Part#	Description
001	P8030001	MOTOR
002	PB01M	HEX HD BOLT M10-1.5 X 30
003	PLW06M	LOCK WASHER M10
004	PW04M	FLAT WASHER M10
005	P8030005	KNOB
006	P8030006	COVER
007	PS05M	PHLP HD SCR M5-0.8 X 8
008	P8030008	COVER
009	P8030009	MOTOR
010	P8030010	COVER
011	PB42M	HEX HD BOLT M5-0.8 X 20
012	P8030012	SUPPORTER
013	P8030013	SWITCH
014	P8030014	COVER
015	PB09M	HEX HD BOLT M8-1.25 X 20
016	P8030016	WASHER M8 X 30 X 6
017	P8030017	MOTOR PULLEY
018	P8030018	BELT
019	PSS16M	SETSCREW M8-1.25 X 10
020	P8030020	BRAKE BASE
021	P8030021	SUPPORTER
022	P8030022	BRAKE PLATE
023	P8030023	PLATE
024	P8030024	POLE
025	P8030025	KNOB
026	P8030026	SPRING
027	P8030027	RING M8 X 20
028	PW01M	FLAT WASHER M8
029	PLW04M	LOCK WASHER M8
030	PB20M	HEX HD BOLT M8-1.25 X 35
031	PB14M	HEX HD BOLT M10-1.5 X 35
032	PLW06M	LOCK WASHER M10
033	PW06M	FLAT WASHER M12
034	PS24M	PHLP HD SCR M6-1.0 X 10
035	P8030035	PLATE
036	P8030036	NEEDLE UNIT
037	P8030037	BRASS WORM GEAR
038	P8030038	WORM GEAR BOX
039	PS11M	PHLP HD SCR M6-1.0 X 16
040	PLW03M	LOCK WASHER M6
041	PW03M	FLAT WASHER M6
042	P8030042	C-RING
043	P8030043	BEARING 6002
044	PS27M	PHLP HD SCR M30-5.0 X 75
045	PW04M	FLAT WASHER M10
046	PB09M	HEX HD BOLT M8-1.25 X 20
047	P8030047	BRACKET
048	P8030048	SLIDE
049	PB08M	HEX HD BOLT M6-1.0 X 20
050	PLW03M	LOCK WASHER M6

Ref#	Part#	Description
051	P8030051	KNOB
052	P8030052	KNOB
053	P8030053	POLT
054	P8030054	ACRYLIC COVER
055	PW03M	FLAT WASHER M6
056	PS11M	PHLP HD SCR M6-1.0 X 16
057	P8030057	VALVE
058	P8030058	LUBRICANT UNIT
059	P8030059	PWER UNIT
060	PB07M	HEX HD BOLT M8-1.25 X 25
061	P8030061	FLAT WASHER M8 X 30
062	P8030062	RING
063	P8030063	SPINDLE PULLEY
064	P8030064	BALL BEARING
065	P8030065	MAIN SPINDLE
066	P8030066	BRACKET
067	P8030067	CYLINDER
068	PB46M	HEX HD BOLT M12-1.75 X 75
069	PN09M	HEX NUT M12-1.75
070	PB22M	HEX HD BOLT M8-1.25 X 50
071	PS22M	PHLP HD SCR M5-0.8 X 25
072	P8030072	GREASE BALL
073	P8030073	HOUSING
074	P8030074	SPINDLE BOX
075	P8030075	GREASE CUP
076	PW01M	WASHER M8
077	PSS21M	SETSCREW M8-1.25 X 25
078	PN03M	HEX NUT M8-1.25
079	PB01M	HEX HD BOLT M10-1.5 X 30
080	P8030080	SCREW M8-1.25 X 15, 20, 25
081	PN03M	HEX NUT M8-1.25
082	P8030082	RING
083	P8030083	DOOR PLATE
084	P8030084	KNOB
085	P8030085	KNOB
086	P8030086	PLATE
087	P8030087	GREASE
088	P8030088	C-RING
089	P8030089	DUST COVER
090	P8030090	HEX NUT
091	P8030091	BLOWER
092	P8030092	SUPPORTER
093	PS09M	PHLP HD SCR M5-0.8 X 10
094	P8030094	VALVE
095	P8030095	AIR TUBE CONNECT
096	P8030096	POLE
097	P8030097	ROTATION RING
098	PB44M	HEX HD BOLT M10-1.5 X 75
099	PW04M	FLAT WASHER M10
100	P8030100	BALL

Ref#	Part#	Description
101	P8030101	SPRING
102	PS29M	PHLP HD SCR M12-1.75 X 25
103	P8030103	FRAME BODY
104	P8030104	SCREW
105	P8030105	SUPPORTER
106	PS26M	PHLP HD SCR M6-1.0 X 20
107	PK34M	KEY M5 X 5 X 20
108	P8030108	GEAR POLE
108	P8030109	RING
110	P8030110	KNOB
111	P8030111	KNOB
113	PN09M	HEX NUT M12-1.75
114	PLW05M	LOCK WASHER M12
115	PN03M	HEX NUT M8-1.25
116	PW01M	FLAT WASHER M8
117	P8030117	WORKING TABLE
118	P8030118	FENCE
119	P8030119	RING
120	P8030120	PLATE
121	PW01M	FLAT WASHER M8
122	PB45M	HEX HD BOLT M8-1.25 X 100
123	P8030123	PHLP HD SCR M8-1.25
124	PW01M	FLAT WASHER M8
125	P8030125	TILTING UNIT
126	P8030126	KNOB
127	P8030127	RING
128	P8030128	SPRING
129	PN09M	HEX NUT M12-1.75
130	PB38M	HEX HD BOLT M12-1.75 X 60
131	P8030131	FRAME FOOT
132	P8030132	TUBE
133	P8030133	FOOT SWITCH
134	P8030134	REGULATOR
135	P8030135	PLATE
136	PS28M	PHLP HD SCR M8-1.25 X 30
137	PB43M	HEX HD BOLT M12-1.75 X 75
138	P8030138	PLATE
139	PM09M	HEX NUT M12-1.75
140	G9987	MINI CAST LOGO
141	P8030141	ELEC. WARNING LABEL
142	P8030142	WARNING / ID LABEL
143	P8030143	SAFETY GLASSES LABEL

NOTES

WARRANTY AND RETURNS

Grizzly Industrial, Inc. warrants every product it sells for a period of **1 year** to the original purchaser from the date of purchase. This warranty does not apply to defects due directly or indirectly to misuse, abuse, negligence, accidents, repairs or alterations or lack of maintenance. This is Grizzly's sole written warranty and any and all warranties that may be implied by law, including any merchantability or fitness, for any particular purpose, are hereby limited to the duration of this written warranty. We do not warrant or represent that the merchandise complies with the provisions of any law or acts unless the manufacturer so warrants. In no event shall Grizzly's liability under this warranty exceed the purchase price paid for the product and any legal actions brought against Grizzly shall be tried in the State of Washington, County of Whatcom.

We shall in no event be liable for death, injuries to persons or property or for incidental, contingent, special, or consequential damages arising from the use of our products.

To take advantage of this warranty, contact us by mail or phone and give us all the details. We will then issue you a "Return Number," which must be clearly posted on the outside as well as the inside of the carton. We will not accept any item without this number. Proof of purchase must accompany the merchandise.

The manufacturers reserve the right to change specifications at any time because they constantly strive to achieve better quality equipment. We make every effort to ensure that our products meet high quality and durability standards and we hope you never need to use this warranty.

Please feel free to write or call us if you have any questions about the machine or the manual.

Thank you again for your business and continued support. We hope to serve you again soon.

WARRANTY CARD

Name _____
Street _____
City _____ State _____ Zip _____
Phone Number _____ E-Mail _____ FAX _____
MODEL # G8030 3H.P. Overarm Router Order# _____

The following information is given on a voluntary basis. It will be used for marketing purposes to help us develop better products and services. Of course, all information is strictly confidential.

1. How did you learn about us?
 Advertisement Friend
 Catalog Card Deck
 World Wide Web
 Other _____
2. Which of the following magazines do you subscribe to.
 American Woodworker Practical Homeowner
 Cabinetmaker Shop Notes
 Family Handyman Today's Homeowner
 Fine Homebuilding WOOD
 Fine Woodworking Wooden Boat
 Home Handyman Woodshop News
 Journal of Light Construction Woodsmith
 Old House Journal Woodwork
 Popular Mechanics Woodworker
 Popular Science Woodworker's Journal
 Popular Woodworking Workbench
 Other _____
3. Which of the following woodworking/remodeling shows do you watch?
 Backyard America The New Yankee Workshop
 Home Time This Old House
 The American Woodworker Woodwright's Shop
 Other _____
4. What is your annual household income?
 \$20,000-\$29,999 \$60,000-\$69,999
 \$30,000-\$39,999 \$70,000-\$79,999
 \$40,000-\$49,999 \$80,000-\$89,999
 \$50,000-\$59,999 \$90,000 +
5. What is your age group?
 20-29 50-59
 30-39 60-69
 40-49 70 +
6. How long have you been a woodworker?
 0 - 2 Years 8 - 20 Years
 2 - 8 Years 20+ Years
7. How would you rank your woodworking skills?
 Simple Advanced
 Intermediate Master Craftsman
8. What stationary woodworking tools do you own? Check all that apply.
 Air Compressor Panel Saw
 Band Saw Planer
 Drill Press Power Feeder
 Drum Sander Radial Arm Saw
 Dust Collector Shaper
 Horizontal Boring Machine Spindle Sander
 Jointer Table Saw
 Lathe Vacuum Veneer Press
 Mortiser Wide Belt Sander
 Other _____
9. How many of your woodworking machines are Grizzly? _____
10. Which benchtop tools do you own? Check all that apply.
 1" x 42" Belt Sander 6" - 8" Grinder
 5" - 8" Drill Press Mini Lathe
 8" Table Saw 10" - 12" Thickness Planer
 8" - 10" Bandsaw Scroll Saw
 Disc/Belt Sander Spindle/Belt Sander
 Mini Jointer
 Other _____
11. How many of the machines checked above are Grizzly? _____
12. Which portable/hand held power tools do you own? Check all that apply.
 Belt Sander Orbital Sander
 Biscuit Joiner Palm Sander
 Circular Saw Portable Planer
 Detail Sander Saber Saw
 Drill/Driver Reciprocating Saw
 Miter Saw Router
 Other _____
13. What machines/supplies would you like Grizzly Industrial to carry?

14. What new accessories would you like Grizzly Industrial to carry?

15. What other companies do you purchase your tools and supplies from?

16. Do you think your purchase represents good value?
 Yes No
17. Would you recommend Grizzly Industrial to a friend?
 Yes No
18. Would you allow us to use your name as a reference for Grizzly customers in your area? **Note: We never use names more than three times.**
 Yes No
19. Comments: _____

CUT ALONG DOTTED LINE

FOLD ALONG DOTTED LINE



Place
Stamp
Here



GRIZZLY INDUSTRIAL, INC.
P.O. BOX 2069
BELLINGHAM, WA 98227-2069



FOLD ALONG DOTTED LINE

Send a Grizzly Catalog to a friend:

Name _____

Street _____

City _____ State _____ Zip _____

TAPE ALONG EDGES--PLEASE DO NOT STAPLE

Free Manuals Download Website

<http://myh66.com>

<http://usermanuals.us>

<http://www.somanuals.com>

<http://www.4manuals.cc>

<http://www.manual-lib.com>

<http://www.404manual.com>

<http://www.luxmanual.com>

<http://aubethermostatmanual.com>

Golf course search by state

<http://golfingnear.com>

Email search by domain

<http://emailbydomain.com>

Auto manuals search

<http://auto.somanuals.com>

TV manuals search

<http://tv.somanuals.com>