

TEFAL

Actua Pressure Cooker



User's manual

Descriptive diagram

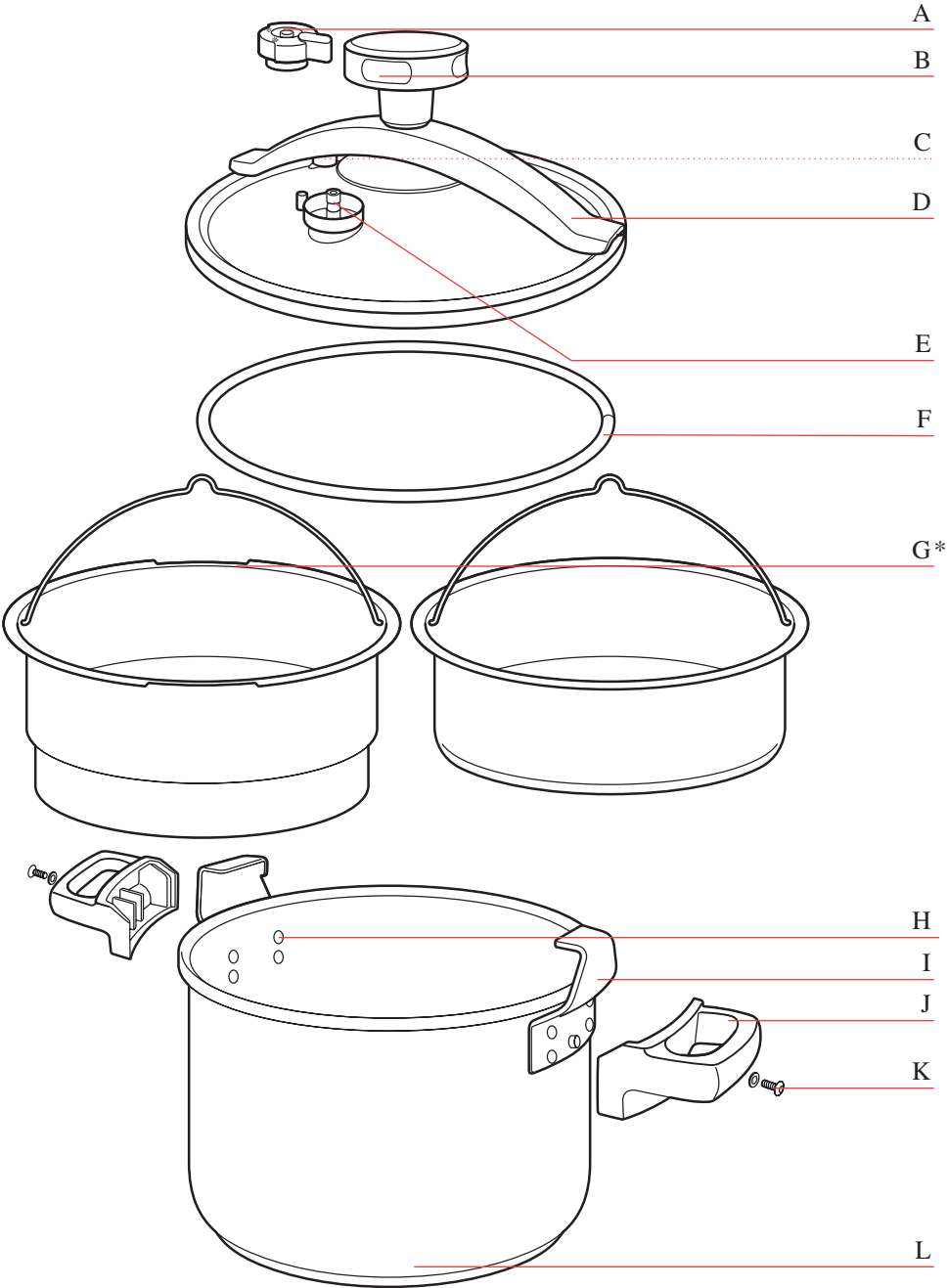

* depending on model

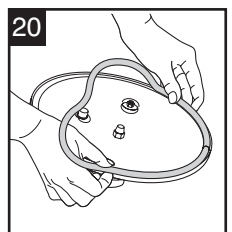
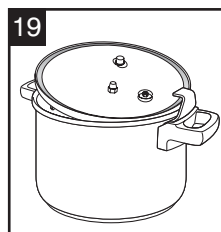
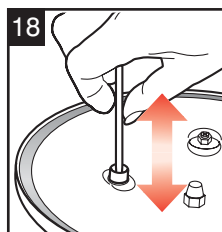
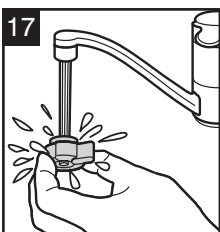
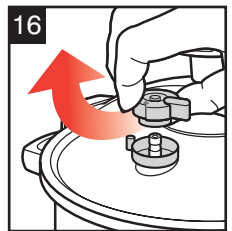
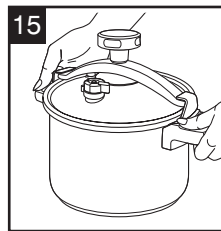
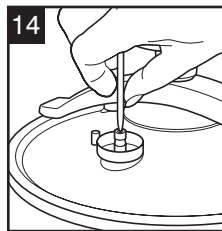
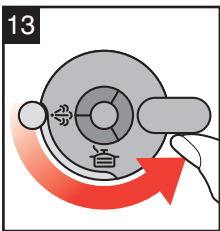
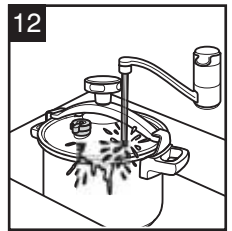
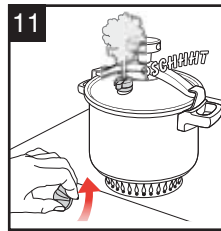
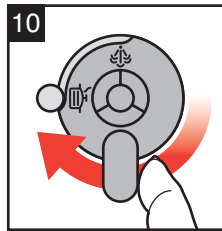
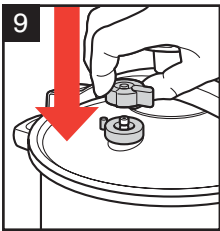
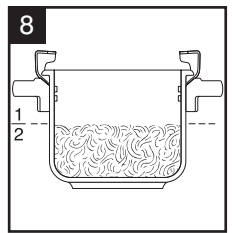
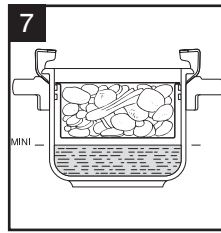
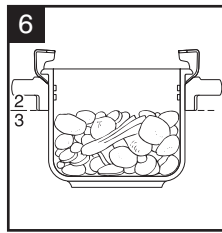
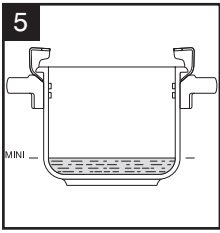
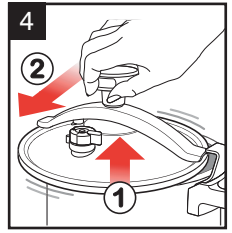
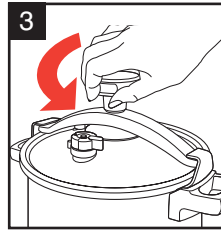
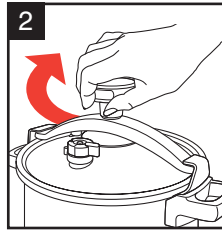
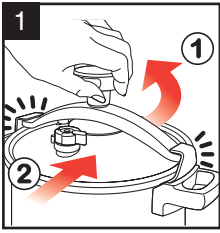

IMPORTANT SAFEGUARDS

Take the time to read all the instructions and refer to the "Instructions for use".

- As with any cooking appliance, supervise cooking closely if using the Pressure Cooker with children nearby.
- Do not put your Pressure Cooker into a hot oven.
- When the Pressure Cooker is under pressure, take great care when moving it. Do not touch the hot surfaces. Use the handles and knobs, and wear gloves if necessary.
- Do not use your Pressure Cooker for any use other than that for which it is designed.
- Your Pressure Cooker cooks under pressure. Burns could result from boiling over if not used properly. Make sure that the Pressure Cooker is properly closed before bringing it up to pressure.
- Never force the Pressure Cooker open. Make sure that the inside pressure has returned to normal.
- Never use your Pressure Cooker without liquid: this could cause serious damage.
- Use compatible heat sources.
- Do not fill your Pressure Cooker more than 2/3 full. For food that expands considerably during cooking, such as rice, dehydrated vegetables or compotes, do not fill the Pressure Cooker more than half full.
- After cooking meat which has an outer layer of skin (such as ox tongue), which could swell due to the effects of pressure, do not pierce the skin after cooking if it appears swollen: you could get burnt. Pierce it before cooking.
- When cooking food with a thick texture (chick peas, rhubarb etc.) the Pressure Cooker should be shaken slightly before opening to ensure that the food does not spurt out.
- Always check that valves are clear before use.
- Do not use the Pressure Cooker to fry under pressure using oil.
- Leave the safety systems alone, except for cleaning and maintenance in accordance with instructions.
- Use only the appropriate TEFAL spare parts for your model. Particularly, use only pan and lid TEFAL.
- Alcohol vapours are flammable. Watch your appliance when preparing alcohol-based recipes.
- Do not use your pressure cooker to store acidic or salty food before and after cooking.
- Make sure the pressure regulator valve is in the steam release position before opening the lid.

Keep these instructions

Cooking vegetables

fresh vegetables

Artichokes	- steamed	18 min.
	- immersed in water	15 min.
Asparagus	- immersed in water	5 min.
Broccoli florets	- steamed	3 min.
Brussels sprouts	- steamed	7 min.
Carrots (sliced)	- steamed	6 min.
Cauliflower florets	- immersed in water	3 min.
Celery (pieces)	- steamed	6 min.
	- immersed in water	10 min.
Courgettes (sliced)	- steamed	6 min. 30
	- immersed in water	2 min.
Endives (in pieces if large)	- steamed	12 min.
Green beans (whole)	- immersed in water	7 min.
Green cabbage sliced	- steamed	6 min.
stripped	- steamed	7min.
Green flageolet beans	- immersed in water	45 min.
Green lentils (pulses*)	- immersed in water	10 min.
Leeks (sliced)	- steamed	2 min. 30
Mushrooms sliced	- steamed	1 min.
whole	- immersed in water	1 min. 30
Peas	- steamed	1 min. 30
Pumpkin (purée)	- steamed	8 min.
Red beetroot	- steamed	20 - 30 min.
Rice **	- immersed in water	7 min.
Semi-dried beans	- immersed in water	20 min.
Sliced old potatoes (1 cm slices or quartered)	- steamed	10 min.
	- immersed in water	6 min.
Spinach	- steamed	5 min.
	- immersed in water	3 min.
Split peas (pulses*)	- immersed in water	14 min.
Turnips (cubed)	- steamed	7 min.
	- immersed in water	6 min.
Wheat (pulses)	- immersed in water	15 min.

* = When cooking pulses they swell up and tend to froth up so do not fill more than one-third full. Use 2 pints (1.2 litres) water for every 450 g (1 lb) pre-soaked weight of pulses. Remember all dried peas and dried beans, must be soaked in boiling water for 1 hour before cooking. Drain, rinse thoroughly and cook in fresh water. Never eat uncooked beans or peas. Soaking is not necessary for red lentils. The high temperatures achieved in the pressure cooker ensure that any natural toxins in the pulses are destroyed. Canned beans and pulses can simply be drained and rinsed before use in recipes.

** = When cooking rice, cereal or pasta, do not fill more than half full as it expands during cooking.

Frozen vegetables

Artichoke hearts	- steamed	7 min.
Broccoli	- steamed	3 min. 30
Brussels sprouts	- steamed	7 min.
Butter beans	- steamed	9 min. 30
Cauliflower	- steamed	6 min.
Courgettes	- steamed	13 min.
Extra thin green beans	- steamed	7 min.
Flageolet beans	- steamed	14 min.
Flat beans	- steamed	7 min.
Mushrooms	- steamed	7 min.
Peas	- steamed	5 min.
Sliced carrots	- steamed	7 min.
Sliced leeks	- steamed	29 min.
Whole baby carrots	- steamed	12 min.
Whole leaf spinach (block)	- steamed	11 min.

Descriptive diagram

- A - Pressure regulator valve
- B - Tightening knob
- C - Safety valve
- D - Clamp
- E - Steam outlet
+ pressure valve position
- F - Gasket

- G - Steaming basket (depending on model)
- H - Rivets
- I - Clamp Hook
- J - Handle
- K - Fixing screw
- L - Pan

1 - Characteristics

Diameter of Pressure Cooker base:

	Stainless steel	
Capacity	Base Ø	Models
4,5 L	18 cm	P05206
6 L	18 cm	P05207
8 L	18 cm	P05211
10 L	20 cm	P05216

Technical informations:

Maximum operating pressure: 55 kPa (8 psi).

Maximum safety pressure: 110 kPa (16 psi).

Compatible heat sources

-  Stainless steel models can be used on all hob types, including induction.

- On an electric hob, use a hotplate of a diameter equal to or less than the diameter of the base of the Pressure Cooker.
- On a ceramic hob, take care that the bottom of the pan is perfectly clean.
- On gas, the flame should not go beyond the base of the pan.

TEFAL accessories

- For other spare parts or repairs contact TEFAL After Sales Service (See enclosed list).
- Use only the appropriate TEFAL spare parts for your model.

2 - Closing

- Turn the tightening knob to the left to lower the clamp.
- Slide the lid horizontally onto the rim of the Pressure Cooker, making sure it sits properly on the pan - **Fig 1**
- Turn the tightening knob to the right until the clamp is in contact with the clamp hook on the Pressure Cooker - **Fig 2**
- To ensure that the lid is locked into position, turn the tightening knob again through **(two complete turns minimum)**.

3 - Opening

- Turn the tightening knob to the left to lower the clamp - **Fig 3**
- Lift the lid to release it.
- Slide it horizontally away from the pan - **Fig 4**

4 - Filling

Minimum 25 cl (2 small cupfuls) - **Fig 5**

Maximum - Do not fill the unit over 2/3 full - **Fig 6**



For steam cooking

- Use at least 75 cl of liquid.
- Suspend the basket from the rivets on the pan - **Fig 7**

For certain foods

- For foods which expand during cooking, such as rice, dehydrated vegetables, or compotes, do not fill your Pressure Cooker more than half full - **Fig 8**

5 - When using for the first time

- Turn the pan upside down to fit the handles. Place them in position, engage the screws and screw them up tightly.
- After using for a few days, tighten the screws again.
- Place the pressure regulator valve on the steam outlet and align one of the two symbols on the valve with the valve position index. Press down fully - **Fig 9**
- Turn to the "cook" position  - **Fig 10**
- Put the steaming basket in the base of the pan.
- Fill 2/3 full with water.
- Close the Pressure Cooker.
- Place the Pressure Cooker on a source of heat at high setting.
- When steam begins to escape through the pressure regulator valve, reduce the heat and wait 20 minutes - **Fig 11**
- When the 20 minutes are up, turn off the heat.
- Reduce pressure by putting your Pressure Cooker under the cold tap - **Fig 12**
- When steam no longer comes from the pressure regulator valve, turn the pressure regulator valve to the steam release position  and open the lid - **Fig 13**

- Rinse the Pressure Cooker with water and dry it.
- Use a metal scourer and a little diluted vinegar to remove any traces of scale.

6 - Before cooking



- Every time you use the Pressure Cooker, check first that the steam outlet is clear - **Fig 14**
- Put the pressure regulator valve in position. Turn to the “cook” position  - **Fig 9**
- Place the Pressure Cooker on a source of heat at high setting.
- When the pressure regulator valve is turning regularly and emitting a hissing sound, cooking has begun. Turn down the heat - **Fig 11**

7 - During cooking

- Time cooking as indicated in the recipe book. A little steam may escape from the safety valve: this is normal.
- During cooking, check that the valve is revolving regularly and hissing. If there is not enough steam, turn the heat up slightly: if there is too much, turn it down.
- As soon as cooking time is up, turn off the heat.

8 - End of cooking

To release the steam

- Once the heat has been turned off, you have two options:
 - **Slow release of pressure:** turn the valve to the “depressurise” position  - **Fig 13**
 - **Fast pressure release:** place the Pressure Cooker under the cold tap. - **Fig 12**
- When steam stops coming out of the pressure regulator valve:
 - Turn the valve to the “depressurise” position .
 - Open the Pressure Cooker.

 **To move the Pressure Cooker, only use the handles - Fig 15**

9 - Cleaning and maintenance

To clean the pan and the steaming basket

- Wash after each use with warm water and washing-up liquid.

To clean the inside of the pan

- Use a scourer.

To clean the outside of the pan

- Use a sponge.
- You can put the pan and the basket in the dishwasher.

To clean the lid

- Wash the lid under running water.

To clean the pressure regulator valve

- Lift it off - **Fig 16**
- Clean the pressure regulator valve in water - **Fig 17**
- Clean the steam outlet with a strong jet of water or a needle - **Fig 14**

To clean the safety valve

- Clean the base of the safety valve inside the lid.
- Check that it is working correctly by pressing lightly on the valve, which should give way easily - **Fig 18**

To clean your Pressure Cooker if it has darkened

- Clean the pan with a special stainless steel cleaner sold in your TEFAL Approved After Sales Service Centre.

To change the gasket

- Make sure that you buy the correct gasket for your model - **Fig 20**
- Soak it in soapy water for a few seconds, then put it in position, beginning with the two ends
- Never shorten the gasket.

Storage of your Pressure Cooker

- Turn the lid upside down on the pan - **Fig 19**

To ensure that your Pressure Cooker lasts as long as possible

- Avoid over-heating the pan when empty.
- Darkening and lines which may appear after long use do not matter.
- If the inside of your pan shows iridescent or white marks (scale), clean it with vinegar or with a special cleaning product for stainless steel.

Safety

Your pressure cooker is equipped with several safety devices, 2 of which are for overpressure:

- First device: the safety valve releases the pressure and steam escapes from under the module.
- Second device: steam flows from between the lid and the pot.

If one safety system is activated:

- Turn the heat source off.
- Let the pressure cooker cool down.
- Open it.
- Check and clean the operation valve, steam release outlet, safety valve and seal.

Recommendations d'utilisation

1 - Supervise carefully if using the Pressure Cooker with children around.

2 - A little steam may escape from the safety valve: this is normal.

3 - To release the steam: caution: jet of steam.

4 - To move the Pressure Cooker, only use the handles.

5 - Do not leave food in the Pressure Cooker.

6 - Never use bleach or chlorine products.

7 - Never immerse the lid in water. Do not put the lid in the dishwasher.

8 - Do not use a sharp or pointed object for this purpose.

9 - After 10 years use, it is advisable to have your Pressure Cooker checked in a TEFAL Approved After Sales Service Centre.

Frequently Asked Questions

1 - If you can't open the lid:

- Check that there is no longer any pressure.
- Release pressure.
- If necessary, put back on the heat for a few seconds with the valve on position "Release".

2 - If the Pressure Cooker has been heated without any liquid inside:

- Get the Pressure Cooker checked in a TEFAL Approved After Sales Service Centre.

3 - If there is no steam coming out of the pressure regulator valve:

- Pressure has not risen inside the Pressure Cooker. This is usual during the first few minutes of heating.

4 - If the problem persists, check that:

- The heat setting is high enough.
- The quantity of liquid in the pan is sufficient.
- The pressure regulator valve is in position.
- The Pressure Cooker is properly closed.
- The pressure regulator valve is not dirty.
- The gasket and rim of the pan are not damaged.

5 - If the safety valve is activated:

- Turn off the heat.
- Let the Pressure Cooker cool down.
- Check the steam outlet and pressure regulator valve.

6 - If steam leaks out around the lid, check:

- That the lid is properly closed. If necessary, tighten it.
- That the gasket is in good condition.
- That the gasket is correctly positioned inside the lid.
- That the lid, safety valve and pressure regulator valve are clean.
- That the rim of the pan is not damaged.

7 - If food is under-cooked or burnt, check:

- Cooking times.
- That heat setting is high enough.
- Correct positioning of pressure regulator valve.
- Quantity of liquid.

8 - If food has been burnt in the Pressure Cooker:

- Soak the pan for a little while before cleaning it.
- Never use bleach or chlorine products.

Guarantee

- Your new TEFAL pressure cooker has a 10 year warranty against:
 - Any defect related to the metal pot.
 - Any premature damage of the metal base, provided the product is used according to the recommended instructions.
- This guarantee does not include:
 - Damage due to inappropriate uses and resulting from shocks, falls or placing in the oven;
 - Replacement of parts, such as seal, handles, valves, basket.Only TEFAL Approved Service Centres are entitled to offer this guarantee.
- This product has been designed for domestic use only. Any professional use, inappropriate use or failure to comply with the instructions, the manufacturer accepts no responsibility and the guarantee will not apply.

Free Manuals Download Website

<http://myh66.com>

<http://usermanuals.us>

<http://www.somanuals.com>

<http://www.4manuals.cc>

<http://www.manual-lib.com>

<http://www.404manual.com>

<http://www.luxmanual.com>

<http://aubethermostatmanual.com>

Golf course search by state

<http://golfingnear.com>

Email search by domain

<http://emailbydomain.com>

Auto manuals search

<http://auto.somanuals.com>

TV manuals search

<http://tv.somanuals.com>