

Assembly Instructions

English



Grundig SAT Systems

STC 160 Head-End Station Quad modulators

HMM 470

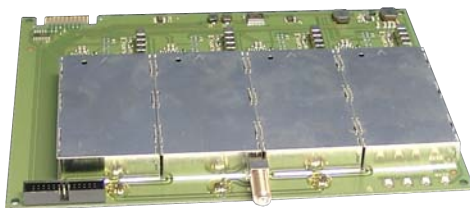

HMS 470

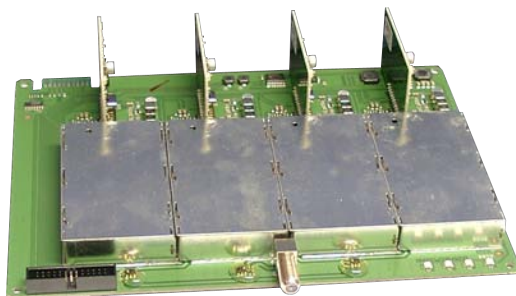

Notes on the Assembly Instructions

As well as this supplementary Assembly Instructions, the Assembly Instructions for the STC 160 apply.



GSS
Grundig SAT Systems GmbH
Beuthener Strasse 43
D-90471 Nuremberg

Phone: +49 (0) 911 / 703 8877
Fax: +49 (0) 911 / 703 9210
Email: info@gss.tv
Internet: www.gss.tv

Contents

| | |
|--|-----------|
| 1 Safety regulations | 3 |
| 2 General information | 3 |
| 2.1 Scope of delivery | 3 |
| 2.2 Meaning of the symbols used | 3 |
| 2.3 Technical data | 4 |
| 2.4 Description | 4 |
| 3 Installation | 5 |
| 3.1 Installing the modulator module | 5 |
| 3.2 Connecting the modulator module | 7 |
| 4 The control panel at a glance | 8 |
| 4.1 Menu items | 8 |
| 4.2 Functions of the control panel buttons | 8 |
| 5 Programming | 9 |
| 5.1 Preparation | 9 |
| 5.2 Programming procedure | 10 |
| 5.2.1 HMM 470 modulator module | 10 |
| 5.2.2 HMS 470 modulator module | 11 |
| 5.3 Programming the HMM 470 modulator module | 12 |
| Selecting the module / channel strip | 12 |
| Switching on the modulator | 13 |
| Setting the output channel | 13 |
| Setting the fine tuning | 14 |
| Setting the output level | 14 |
| Selecting the audio signal | 15 |
| Storing data | 15 |
| 5.4 Programming the HMS 470 modulator module | 16 |
| Selecting the module / channel strip | 16 |
| Selecting the audio signal | 17 |
| 6 Final procedures | 17 |
| 7 Channel and frequency tables | 18 |

1 Safety regulations



Please read the safety regulations listed in the assembly instructions for the STC 160 head-end station which pertain to this module.



Take precautions to prevent static discharge when working on the device!

2 General information

2.1 Scope of delivery

- 1 HMM 470 or HMS 470 module
- 1 HF cable with F plugs
- 1 CD (assembly instructions)
- 1 Brief Assembly Instructions

2.2 Meaning of the symbols used



Important note



General note

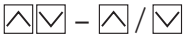
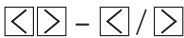

Optional use of the buttons

- Performing works

2.3 Technical data

The requirements of the following are met:

2006/95/EC, 2004/108/EC

The product fulfils the guidelines and standards for CE labelling.

HF outputs:

Modulators A / B / C / D

| | |
|-------------------------------------|--|
| Channels: | C 02 ... C 69 (incl. S 03 ... S 14 and S 16 ... S 41) |
| Frequency range: | 48.25 MHz ... 855.25 MHz |
| Modulation method: | CCIR, PAL B/G |
| Output level: | typ. 86 dB μ V |
| Output impedance: | 75 Ω , nominal |
| Video signal-to-noise ratio: | typ. 55 dB |
| Video frequency response: | 20 Hz ... 5 MHz |
| Audio frequency response: | 40 Hz ... 15 kHz |
| - | - |

Connections:

| | |
|----------------------------|--------------------------------------|
| HF output: | 1 F socket |
| Connection strip (20-pin): | Supply voltages and control circuits |
| AV input: | 26-pin pin socket |

2.4 Description

The modulator modules contain four modulators, which convert existing video and audio signals into PAL B/G signals in the C 02 ... C 69 channel range via the AV interface.

The modulators are labelled (analogue to the channel strips) as "A", "B", "C" and "D", and can be individually programmed. Four LEDs indicate if the respective modulator is switched on (LED illuminates) or off.

The audio and video signals being fed in through the 26-pin socket of the modulator module are modulated onto the carrier frequencies (channels) which have been selected. The HF output signals are sent through the HF output on the modulator module to the output collector. The levels of the HF output signals are adjustable by software.

When the head-end station is switched on, the two-line LC display shows the "SETUP" menu and the software version of the control unit. The head-end station total output level can be adjusted in this menu.

If the modulator modules are not detected by the head-end station you can update the head-end station's operating software via the head-end station's 9-pin

D-Sub socket, using a PC or notebook and the “**BE-Flash**” software. You can find the current operating software for the head-end station, the software “**BE-Flash**” and the current assembly instructions on the website “www.gss.tv”.

The modules are designed exclusively for use in the STC 160 head-end station.

3 Installation



Caution

- Ensure the head end station is mounted so it will not be able to vibrate. Avoid, for example, mounting the head end station onto a lift shaft or any other wall or floor construction that vibrates in a similar way.
- Before installing or changing a module, switch off the head-end station or unplug the power cable from the mains power socket.



Take precautions to prevent static discharge when working on the device!

- Open the housing of the head-end station according to the instructions in the STC 160 installation manual.

3.1 Installing the modulator module



- Always position modules which belong together next to each other. The modulator module must be installed to the right of the digital module or an add-on module.
- When installing a module, make sure that it is inserted in the long numbered grooves in front of the contact strip on the board at the rear wall of the housing.
The shorter, not numbered grooves without contact strip on the board at the rear wall of the housing are for add-on modules only.

- Open the housing of the head-end station in accordance with the assembly instructions for the STC 160.
- Open the locking device ① in the direction of the arrow (fig. 1).

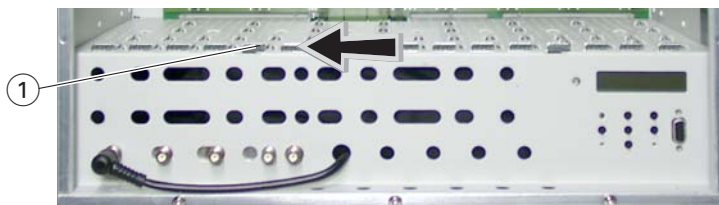

Fig. 1

—> Slots 1 (digital module) and 2 (modulator module) are shown in figure 2. The open slot in between (without a contact strip on the board at the rear wall of the housing) is intended for an add-on module.

- Insert the modulator module in grooves (A) and (B) (fig. 2) of an open slot on the right hand side of the associated digital module or an add-on module.
- Gently slide the modulator module into the head-end station and ensure that it makes contact with the contact strip on the board at the rear wall of the housing.

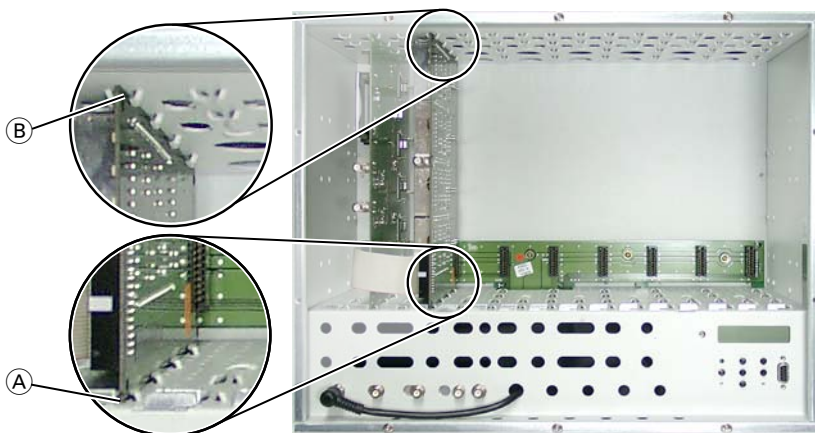

Fig. 2

3.2 Connecting the modulator module

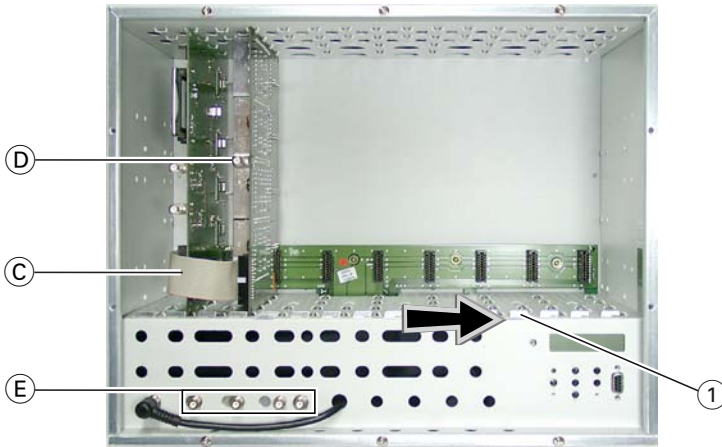

Fig. 3

- Using the AV cable (C), connect the modulator module to the digital module or to an add-on module if applicable.
- After programming, connect the modulator output (D) to one of the input sockets (E) on the output collector.
- Close the locking device (1) in the direction of the arrow.

4 The control panel at a glance

4.1 Menu items





Program the module using the buttons on the head-end station control unit. The menus appear on the two-line display of the control unit.

You can use the **M** button to select the following menu items:

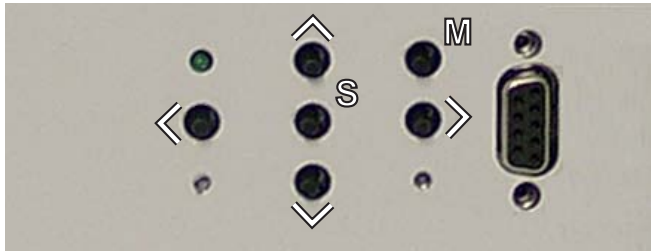
- Modulator settings
- Modulator output channel
- Output level
- Audio setting
- Storing

4.2 Functions of the control panel buttons



-   – To move the cursor
-   – To adjust values and functions
- S** – To store the programmed data
- M** – To switch to extended menus

5 Programming

5.1 Preparation

- Connect the test receiver to the HF output on the modulator module.
- Adjust the test receiver to the output channel of the channel strip to be set.
- Switch on the modulator if necessary. For each modulator, there is a green LED which indicates if the modulator is switched on.

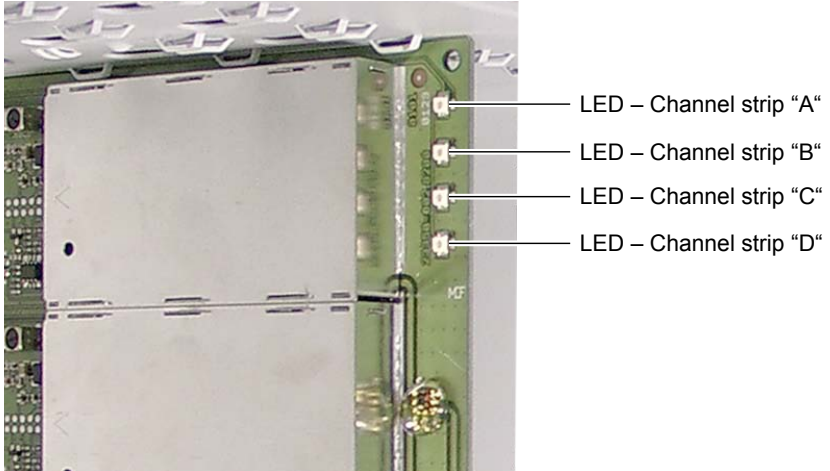

The process of programming the HMM 470 and HMS 470 modules is the same, with one exception. The programming process for the HMM 470 module is described in section 5.3. Please see sections 5.4 and 5.3 to programme the HMS 470 module.

5.2 Programming procedure

The parameters and functions to be set are underlined>.

5.2.1 HMM 470 modulator module

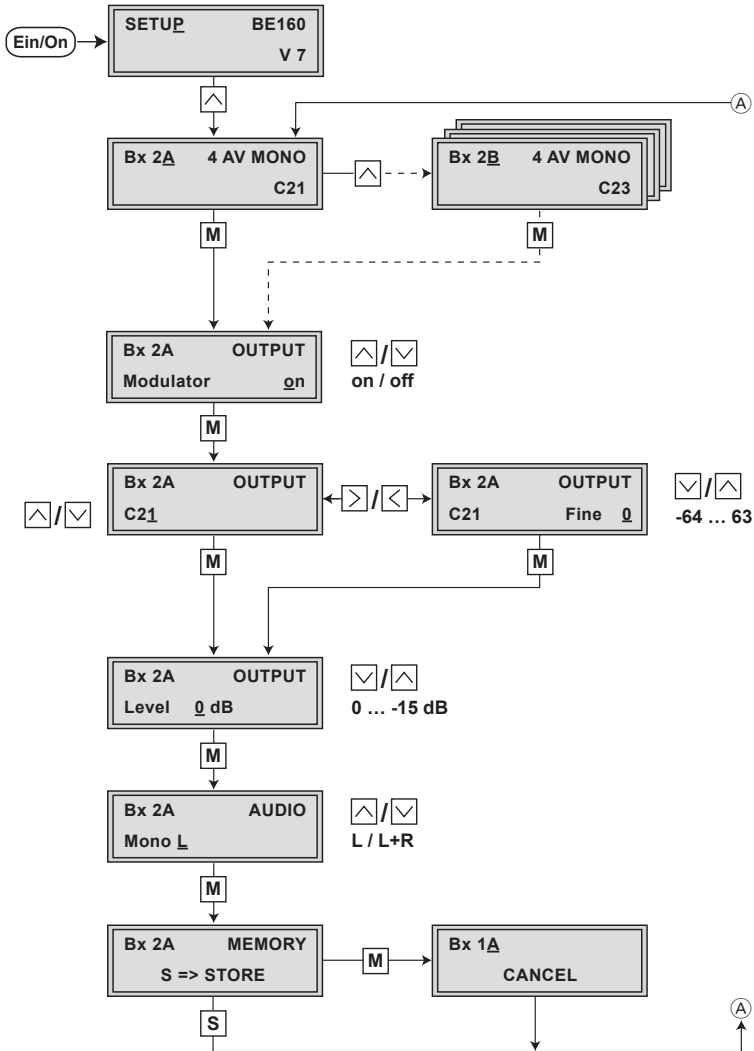

5.2.2 HMS 470 modulator module

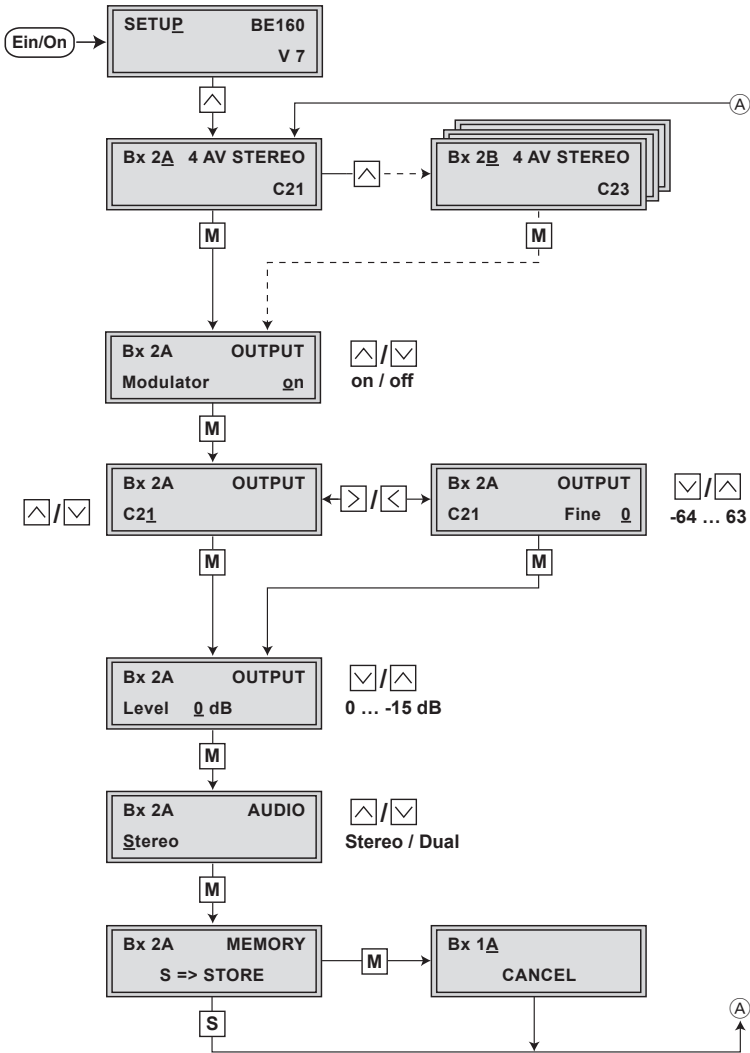

5.3 Programming the HMM 470 modulator module

Notes:

- Entries are saved by pressing the **[S]** button.
 - You will be returned to the item "**Selecting the module/channel strip**".
- The programming process can be cancelled by pressing and holding the **[M]** button.
 - You will be returned to the item "**Selecting the module/channel strip**".

Switch on the head-end station.

- The display shows "**SETUP BE160**" and the software version of the head-end station (e.g. V 7).
- In the "**SETUP**" menu, the output level of the output collector can be adjusted (see STC 160 assembly instructions).

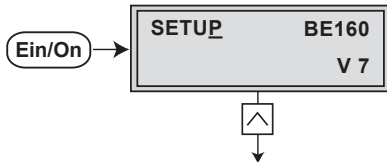

Selecting the module / channel strip

- Press **[↑]**/**[↓]** repeatedly if necessary to select the particular module (**Bx ...**) or channel strip "**A**", "**B**", "**C**" or "**D**" to be programmed.

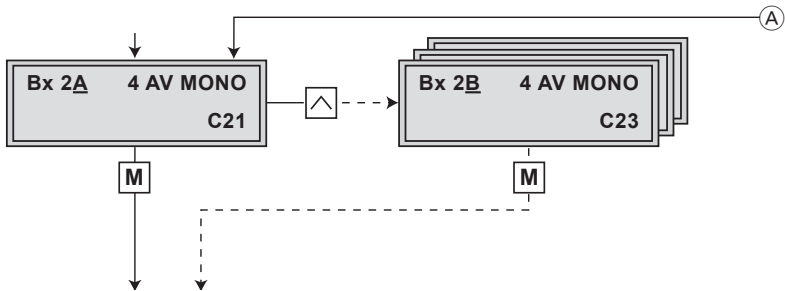

- Press the **[M]** button to activate the channel strip.
 - The display shows this menu (for example) "**Bx 2A 4 AV MONO C21**":
 - "**Bx**" indicates the slot
 - "**2**" indicates slot no. 2
 - "**A**" indicates channel strip "**A**"
 - "**C21**" indicates the HF channel set

- Press the **M** button:
 → The “Switching on the modulator” –
 “**OUTPUT – Modulator**” menu is activated.

Switching on the modulator

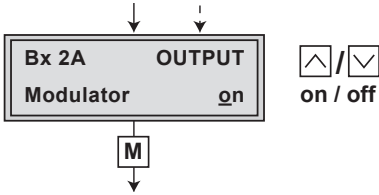

- Use the **▲/▼** buttons to switch “**on**” the modulator (LED illuminates – page 9), or to switch “**off**” the modulator if necessary (LED is switched off).
- Press the **M** button.
 → The “Setting the output channel” – “**OUTPUT**” menu is activated.

Setting the output channel

In this menu you set the output channel of the channel strip. Additionally the output frequency of the output channel can be fine tuned.

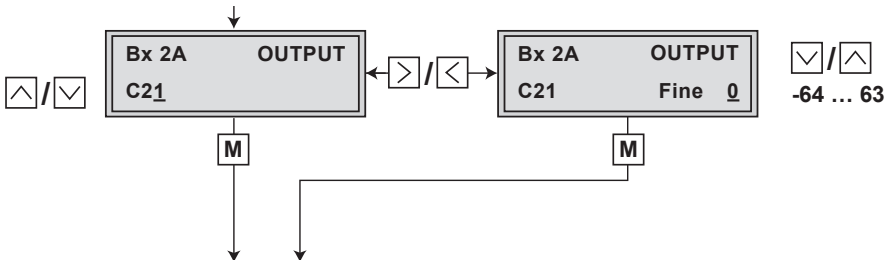

- Use the **▲/▼** buttons to set the output channel.



Setting the fine tuning

Only change the fine tuning (frequency offset) in circumstances where it is absolutely necessary to do so. Once you have changed it, all televisions connected to the cable system will need to be calibrated by means of fine tuning to match it.

- Press the button.
→ Pressing the button you can return to the “Setting the output channel” menu.
- Use the buttons to adjust the fine tuning (**Fine**).
- Press the button.
→ The “Setting the output level” – “**OUTPUT Level**” menu is activated.

Setting the output level

This menu item is used to set the output levels of the modulators of the modul’s channel strips to the same value and to level them to the output levels of the modulators of other modules used.

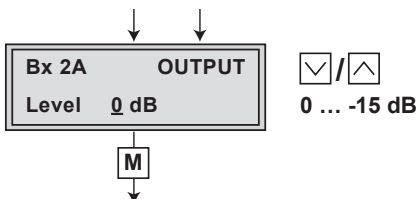

- Use the test receiver to measure the output level of the channel strip and make note of the value.
- When adjusting the other channel strip, compare its value with the value noted for the first channel strip.
- Measure the output levels of the other modulators used and make notes of their values.
- Use the buttons to balance the higher output level of the one channel strip to the lower output levels of the other modulators used (“**0 dB**” ... “**-15 dB**”).
- Press the button.
→ The “Selecting the audio signal” – “**AUDIO**” menu is activated.

Selecting the audio signal

In this menu, you can select between mono audio (**Mono L**) and the composite signal of the audio signals (**Mono L + R**).

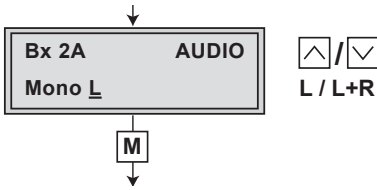

- The buttons are used to select the audio signal ("**Mono L**" or "**Mono L + R**").
- Press the button.
→ The "Storing data" – "**MEMORY**" menu is activated.

Storing data

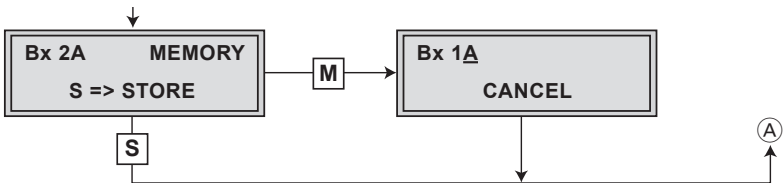



- All programmed data is saved by pressing the button. You will be returned to the menu item "**Selecting the module / channel strip**" via (page 12).
→ By pressing the button, you will be returned to the menu item "**Selecting the module / channel strip**" via **without** saving the programmed data.
- Select additional channel strips for programming if necessary.

5.4 Programming the HMS 470 modulator module

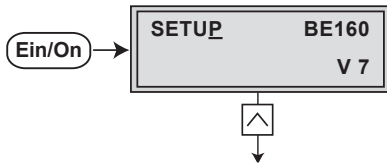

- Switch on the head-end station.
→ The display shows **“SETUP BE160”** and the software version of the head-end station (e.g. V 7).

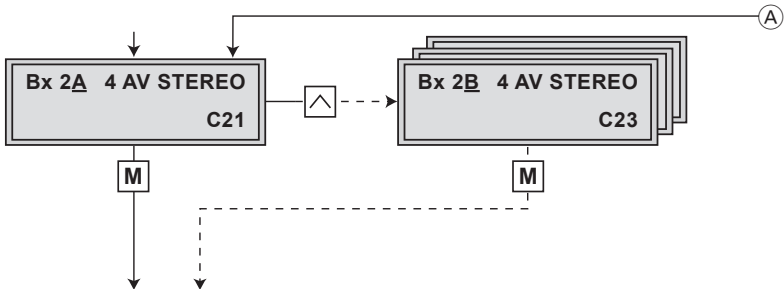

Selecting the module / channel strip

- Press   repeatedly if necessary to select the particular module (**Bx ...**) or channel strip **“A”**, **“B”**, **“C”** or **“D”** to be programmed.



- Press the  button to activate the channel strip.
→ The display shows this menu (for example) **“Bx 2A 4 AV STEREO C21”**:
 “Bx” indicates the slot
 “2” indicates slot no. 2
 “A” indicates channel strip **“A”**
 “C21” indicates the HF channel set
- Press the  button:
→ The **“Switching on the modulator”** – **“OUTPUT – Modulator”** menu is activated.

Switching on the modulator (page 13)

Setting the output channel (page 13)

Setting the output level (page 14)

Selecting the audio signal

In this menu, you can select between stereo and dual tone. If the audio signal will be supplied by the digital module, it will be switched automatically.

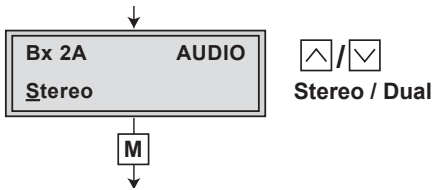

- Using the button, select the desired audio signal "Stereo" or "Dual".
- Press the button.
→ The "Storing data" – "MEMORY" menu is activated (page 15).

6 Final procedures



After installing the head-end station, upgrading accessories or installing modules it is necessary to tighten all cable connections, F terminals and cover screws in order to maintain compliance with current EMC regulations.

- Securely tighten the cable connections (F connectors) using an open-ended spanner (spanner gap 11 mm).
- After programming, connect the modulator output to one of the input sockets of the output collector (page 7, fig. 3).
- Test the output level of the output collector according to the STC 160 assembly instructions and set the output level required for the cable system.
- Mount the base plate and the front cover (see STC 160 assembly instructions).

7 Channel and frequency tables

CCIR – Band I/III (Frequency raster 7 MHz)

| Kanal Channel | Bildträgerfrequenz Picture carrier frequency [MHz] | Kanal Channel | Bildträgerfrequenz Picture carrier frequency [MHz] | Kanal Channel | Bildträgerfrequenz Picture carrier frequency [MHz] | Kanal Channel | Bildträgerfrequenz Picture carrier frequency [MHz] | Kanal Channel | Bildträgerfrequenz Picture carrier frequency [MHz] |
|------------------|--|------------------|--|------------------|--|------------------|--|------------------|--|
| C 2 | 48.25 | S 5 | 133.25 | C 5 | 175.25 | C 11 | 217.25 | S 15 | 259.25 |
| C 3 | 55.25 | S 6 | 140.25 | C 6 | 182.25 | C 12 | 224.25 | S 16 | 266.25 |
| C 4 | 62.25 | S 7 | 147.25 | C 7 | 189.25 | S 11 | 231.25 | S 17 | 273.25 |
| S 2 | 112.25 | S 8 | 154.25 | C 8 | 196.25 | S 12 | 238.25 | S 18 | 280.25 |
| S 3 | 119.25 | S 9 | 161.25 | C 9 | 203.25 | S 13 | 245.25 | S 19 | 287.25 |
| S 4 | 126.25 | S 10 | 168.25 | C 10 | 210.25 | S 14 | 252.25 | S 20 | 294.25 |

CCIR – Hyperband (Frequency raster 8 MHz)

| Kanal Channel | Bildträgerfrequenz Picture carrier frequency [MHz] | Kanalmittefrequenz Channel centre frequency [MHz] | Kanal Channel | Bildträgerfrequenz Picture carrier frequency [MHz] | Kanalmittefrequenz Channel centre frequency [MHz] | Kanal Channel | Bildträgerfrequenz Picture carrier frequency [MHz] | Kanalmittefrequenz Channel centre frequency [MHz] | Kanal Channel | Bildträgerfrequenz Picture carrier frequency [MHz] | Kanalmittefrequenz Channel centre frequency [MHz] |
|------------------|--|---|------------------|--|---|------------------|--|---|------------------|--|---|
| S 21 | 303.25 | 306.00 | S 27 | 351.25 | 354.00 | S 33 | 399.25 | 402.00 | S 39 | 447.25 | 450.00 |
| S 22 | 311.25 | 314.00 | S 28 | 359.25 | 362.00 | S 34 | 407.25 | 410.00 | S 40 | 455.25 | 458.00 |
| S 23 | 319.25 | 322.00 | S 29 | 367.25 | 370.00 | S 35 | 415.25 | 418.00 | S 41 | 463.25 | 466.00 |
| S 24 | 327.25 | 330.00 | S 30 | 375.25 | 378.00 | S 36 | 423.25 | 426.00 | | | |
| S 25 | 335.25 | 338.00 | S 31 | 383.25 | 386.00 | S 37 | 431.25 | 434.00 | | | |
| S 26 | 343.25 | 346.00 | S 32 | 391.25 | 394.00 | S 38 | 439.25 | 442.00 | | | |

CCIR – Band IV/V (Frequency raster 8 MHz)

| | | | | | | | | | | | |
|------|--------|--------|------|--------|--------|------|--------|--------|------|--------|--------|
| C 21 | 471.25 | 474.00 | C 35 | 583.25 | 586.00 | C 49 | 695.25 | 698.00 | C 63 | 807.25 | 810.00 |
| C 22 | 479.25 | 482.00 | C 36 | 591.25 | 594.00 | C 50 | 703.25 | 706.00 | C 64 | 815.25 | 818.00 |
| C 23 | 487.25 | 490.00 | C 37 | 599.25 | 602.00 | C 51 | 711.25 | 714.00 | C 65 | 823.25 | 826.00 |
| C 24 | 495.25 | 498.00 | C 38 | 607.25 | 610.00 | C 52 | 719.25 | 722.00 | C 66 | 831.25 | 834.00 |
| C 25 | 503.25 | 506.00 | C 39 | 615.25 | 618.00 | C 53 | 727.25 | 730.00 | C 67 | 839.25 | 842.00 |
| C 26 | 511.25 | 514.00 | C 40 | 623.25 | 626.00 | C 54 | 735.25 | 738.00 | C 68 | 847.25 | 850.00 |
| C 27 | 519.25 | 522.00 | C 41 | 631.25 | 634.00 | C 55 | 743.25 | 746.00 | C 69 | 855.25 | 858.00 |
| C 28 | 527.25 | 530.00 | C 42 | 639.25 | 642.00 | C 56 | 751.25 | 754.00 | | | |
| C 29 | 535.25 | 538.00 | C 43 | 647.25 | 650.00 | C 57 | 759.25 | 762.00 | | | |
| C 30 | 543.25 | 546.00 | C 44 | 655.25 | 658.00 | C 58 | 767.25 | 770.00 | | | |
| C 31 | 551.25 | 554.00 | C 45 | 663.25 | 666.00 | C 59 | 775.25 | 778.00 | | | |
| C 32 | 559.25 | 562.00 | C 46 | 671.25 | 674.00 | C 60 | 783.25 | 786.00 | | | |
| C 33 | 567.25 | 570.00 | C 47 | 679.25 | 682.00 | C 61 | 791.25 | 794.00 | | | |
| C 34 | 575.25 | 578.00 | C 48 | 687.25 | 690.00 | C 62 | 799.25 | 802.00 | | | |

Service:

Phone: +49 (0) 911 / 703 2221
 Fax: +49 (0) 911 / 703 2326
 Email: service@gss.tv

Free Manuals Download Website

<http://myh66.com>

<http://usermanuals.us>

<http://www.somanuals.com>

<http://www.4manuals.cc>

<http://www.manual-lib.com>

<http://www.404manual.com>

<http://www.luxmanual.com>

<http://aubethermostatmanual.com>

Golf course search by state

<http://golfingnear.com>

Email search by domain

<http://emailbydomain.com>

Auto manuals search

<http://auto.somanuals.com>

TV manuals search

<http://tv.somanuals.com>