

FOR A GOOD REASON

**GRUNDIG**

## **FACIAL SAUNA**

FS 4820

de

en

fr

it

pt

es

pl

cs

tr

el

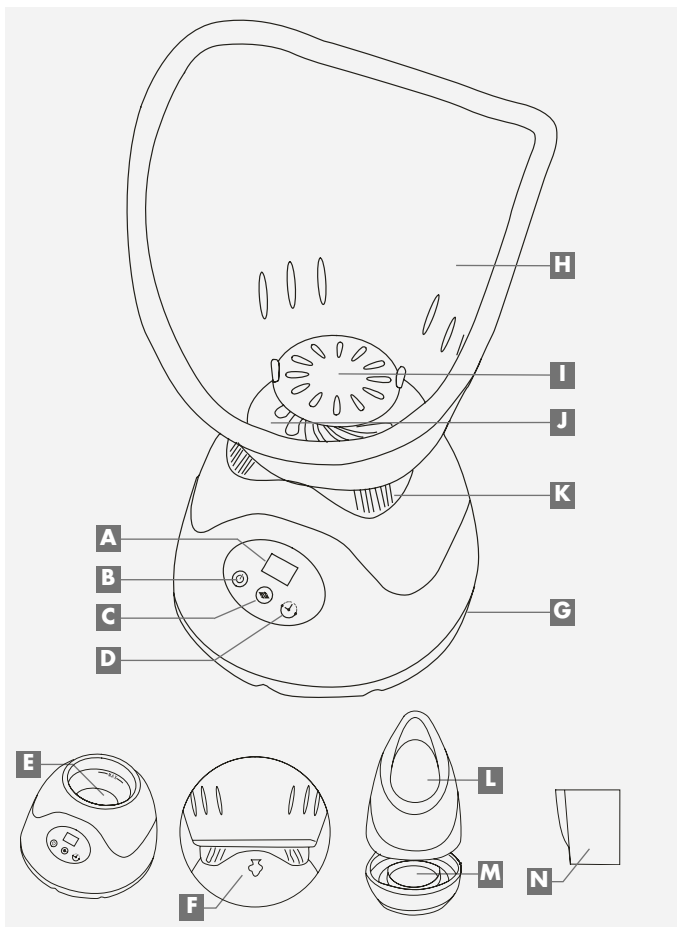

---

<b>DEUTSCH</b>	<b>4-16</b>
----------------	-------------

<b>ENGLISH</b>	<b>17-28</b>
----------------	--------------

<b>FRANÇAIS</b>	<b>29-40</b>
-----------------	--------------

<b>ITALIANO</b>	<b>41-52</b>
-----------------	--------------

<b>PORTUGUÊS</b>	<b>53-64</b>
------------------	--------------

<b>ESPAÑOL</b>	<b>65-76</b>
----------------	--------------

<b>POLSKI</b>	<b>77-88</b>
---------------	--------------

<b>ČESKY</b>	<b>89-100</b>
--------------	---------------

<b>TÜRKÇE</b>	<b>101-112</b>
---------------	----------------

<b>ΕΛΛΗΝΙΚΑ</b>	<b>113-124</b>
-----------------	----------------

# SAFETY

---

Please note the following instructions when using the appliance:

- Do not use the appliance if you suffer from a heart condition, eczema or any other skin complaints.
- Only use the appliance if one of the two steam masks is attached.
- The appliance is designed for domestic use only.
- Follow these instructions to prevent damaging the appliance or danger arising from improper use. Keep them in a safe place.
- Never use the appliance in the bath, shower or over a wash basin filled with water; nor should it be operated with wet hands.
- Do not immerse the appliance in water.
- Do not drop the appliance.
- Always pull out the plug before filling the appliance with water and after using it.
- Never use the appliance for longer than 30 minutes.
- When using the appliance, make sure the steam is not directed at the eyes or any other places sensitive to heat. Always keep your eyes closed.
- When using the appliance, always make sure you keep a sufficient distance from the steam pouring out.
- Relax your face and keep it directed towards the steam pouring out.
- Do not remove any accessories while using the appliance. This could result in burns.
- Keep the appliance out of the reach of children.
- If not already present, for additional protection we recommend installing a residual-current-operated protective device (RCD) with a rated residual operating current not exceeding 30 mA in the electrical circuit of your bathroom. Ask your electrician for advice.

# SAFETY

---

- Never use the appliance if it or the power cord is visibly damaged.
- If the power cord is damaged, it must be replaced by the manufacturer, its service centre or a similarly qualified person to prevent danger arising.
- The device may not be used by the following people, including children: those with limited physical, sensory or mental capabilities and also those with a lack of experience and knowledge. This does not apply to the latter if they were instructed in the use of the device or if they use it under the supervision of a person responsible for safety. Children should always be supervised to ensure that they do not play with the device.
- Do not open the appliance under any circumstances. No warranty claims are accepted for damage caused by improper handling.

## Caution

- The device switches off automatically for your safety, if extremely high fluctuations occur in the mains voltages.  
Press the »« button to switch on the device again.

## Caution

- The FS 4820 is a product for your well-being. It is not a medical product. No medical recommendations can be made on the basis of its use or of the results displayed.

# OVERVIEW

---

Dear customer,

Congratulations on the purchase of your FS 4820 face steamer. Read the following user notes carefully to ensure you can enjoy your quality product from Grundig for many years to come.

## A responsible approach!



GRUNDIG focuses on contractually agreed social working conditions with fair wages for both internal employees and suppliers, as well as on the efficient use of raw materials with continual waste reduction of several tonnes of plastic each year – and availability of at least 5 years for all accessories.

For a future worth living.  
For a good reason. Grundig.

## Special features

- Using the face steamer will prepare your skin perfectly for other treatments, such as deep pore cleansing, moisturising, face masks, etc. The invigorating steam increases the blood circulation, opens pores and allows impurities to be easily removed.
- The face steamer provides the perfect basis for any type of facial. Beauty products are able to penetrate deep into the skin through the open pores so that the overall effect is optimised.
- Two different masks, one for the whole face and one especially for the nose.
- Easy switching between the two temperature levels and a pulse button.
- Five different timer settings for timed treatments. A signal tone indicates the progress of the set time.



# OVERVIEW

---

## Contents and operating controls

See the illustrations on page 2.

### Basic appliance

- A** Display.
- B** »  « Switches the appliance on and off.
- C** »  « Selects the temperature level:  
LO = low, HI = high and  
PU = pulse higher and  
lower temperatures.
- D** »  « Selects five different timer settings:  
from 10 to a maximum of  
30 minutes.
- E** Water container.
- F** Outlet for steam.
- G** Power cord.

### Face mask

- H** Face mask.
- I** Steam diffuser cover (aroma attachment).
- J** Steam diffuser.
- K** Steam outlet.

### Nose mask

- L** Nose mask.
- M** Base for attaching the nose mask and the ensemble on the basic appliance.

### Accessories

- N** Measuring cup for measuring the amount of water required for operation.

### Power supply

Check if the mains voltage on the power cord plug corresponds to your local mains supply.

The only way to disconnect the appliance from the mains is to pull out the plug.

Only connect the power plug to the socket once you have filled the appliance with water and the face mask or nose mask is attached on the basic appliance.

# USING WITH THE FACE MASK

## Preparation

- 1 Disconnect the power cord from the wall socket.
- 2 Fill the water container **E** of the basic appliance with tap water. Only use the measuring cup provided.

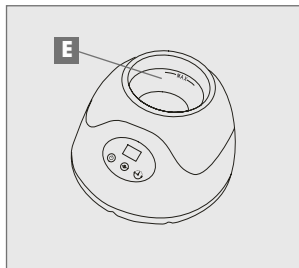

## Note

- Fill the water container in the basic appliance up to the »**MAX**« mark.

## Caution

- Never fill up the water container directly under the tap. Only use the measuring cup provided.

- 3 Put the face mask on the basic appliance and turn to tighten clockwise.

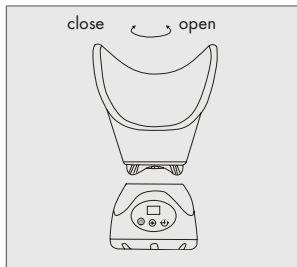

- 4 Plug the power cord into the wall socket.

## Note

- For the maximum amount of water, the steam takes about 20 minutes to develop.



# USING WITH THE FACE MASK

---

## Use

- 1 Press the »⏻« button to switch on the appliance.
  - The appliance starts at the lowest temperature level which takes 10 minutes to reach as long as the timer setting has not been changed.
- 2 Select the required temperature level with »◀▶« (LO = low, HI = high and PU = pulse higher and lower temperatures).

## Note

- The LO, HI and PU (»pulse«) settings are based on the original duration of 10 minutes, as long as the timer setting has not been changed.
- 3 Select the timer setting with »⌚« (10 up to maximum of 30 minutes).

## Note

- Once the set time has elapsed, a signal tone is emitted three times.
- 4 Press »⏻« to switch off the appliance after use.
  - 5 Disconnect the power cord from the wall socket.

## Important note

- It is advisable to use the LO = low temperature level. Too hot steam could cause injury to your face.
- Do not hold your face too near to the mask.
- We recommend using the appliance for not longer than 20 minutes per day and not more than two or three times a week.
- You can stop the treatment at any time, by pressing »⏻« to switch off.
- Rinse your face with cold water at the end of each session. Then you can begin the cosmetic treatment.
- Always disconnect the power plug after use. Leave the appliance to cool down for 10 to 15 minutes.
- Once it has cooled down, remove the face mask from the basic appliance (anti-clockwise). Pour the remaining water in the container down the drain.

# USING WITH THE FACE MASK

## Using medicinal herbs, oils and aromas

The aroma attachment **I** on the diffuser gives you the option of using medicinal herbs, oils and other aromas for aroma treatments.

These substances are most effective when mixed with steam. Saline solutions may not be used.

Only use medicinal herbs, oils and aromas that are intended for using in a face steamer. These substances must be approved by the manufacturer.

## Diffuser function

The diffuser **J** ensures an equal distribution of the steam. You can also use it for spreading aromas or other substances that are gentle on the skin.

Remove the aroma attachment **I** from the diffuser. Put a cotton wool pad that has been soaked with an aroma into the diffuser and put the aroma attachment back on carefully.

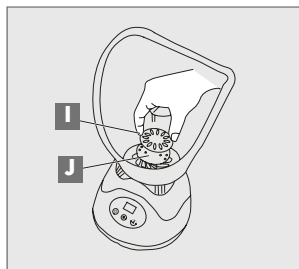

# USING WITH THE FACE MASK

---

## The steam outlet

The steam outlet **K** is located under the face mask.

You can open and close it.

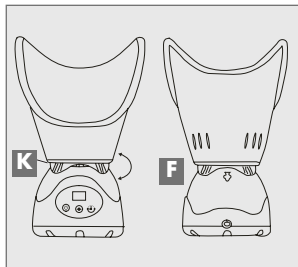

When the steam outlet is closed, it reduces the warming up time and the amount of steam going into the face mask. The steam **F** then escapes from the outlet on the back of the basic appliance.

## Caution

- Be careful of the outlet on the back of the basic appliance when the steam **F** outlet is closed. Avoid touching it with your hands or fingers. There is a risk of injury.

# USING WITH THE NOSE MASK \_\_\_\_\_

## Preparation

- 1 Disconnect the power cord from the wall socket.
- 2 Fill the water container **E** of the basic appliance with tap water. Only use the measuring cup provided.

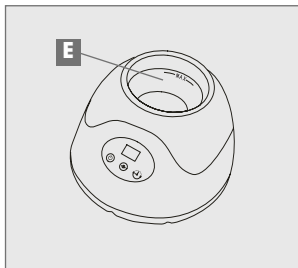

## Note

- Fill the water container in the basic appliance up to the »MAX« mark.

## Caution

- Never fill up the water container directly under the tap. Only use the measuring cup provided.

- 3 Put the nose mask **L** on the base **M**.  
Put both parts on the basic appliance and turn to tighten clockwise.

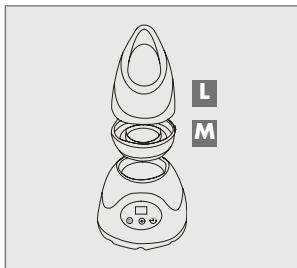

- 4 Plug the power cord into the wall socket.

## Note

- For the maximum amount of water, the steam takes about 20 minutes to develop.

# USING WITH THE NOSE MASK

## Use

- 1 Press the »⏻« button to switch on the appliance.
    - The appliance starts at the lowest temperature level with a time limit of 10 minutes to reach, as long as the timer setting has not been changed.
  - 2 Select the recommended temperature level LO with »◀▶«.
  - 3 Press »⏻« to switch off the appliance after use.
  - 4 Disconnect the power cord from the wall socket.
- We recommend using the appliance for not longer than 20 minutes per day and not more than two or three times a week.
  - You can stop the treatment at any time, by pressing »⏻« to switch off.
  - Always disconnect the power plug after use. Leave the appliance to cool down for 10 to 15 minutes.
  - Once it has cooled down, remove the nose mask from the basic appliance (anti-clockwise). Pour the remaining water in the container down the drain.

## Important note

- It is advisable to use the LO = low temperature level. Too hot steam could cause injury to your nose.
- Do not hold your nose too near to the mask.

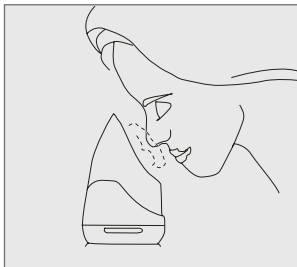

# CLEANING AND MAINTENANCE \_\_\_\_\_

## Cleaning the basic appliance

### Caution

- Always pull out the power cord plug before cleaning the appliance.
- Wait until the appliance has cooled down completely. Remove the rest of the water from the water container.

Clean the appliance after every use.

Use a soft, slightly moist cloth to clean the appliance. Do not use any chemical cleaning agents.

Dry the appliance thoroughly.

## Cleaning the mask attachments

Use a soft, slightly moist cloth to clean the mask attachments. Do not use any chemical cleaning agents.

Dry the mask attachments thoroughly.

## Storage

If you do not want to use the appliance for a long period of time, please store it carefully.

- The appliance must be completely dry.
- Ensure that the mask attachments are completely clean.
- Store the appliance and the mask attachments in the original packaging in a cool, dry place.
- Make sure the appliance is kept out of reach of children.

## Environmental Note

This product is manufactured from high-quality parts and materials which can be reused and recycled.

Therefore, do not dispose of the product along with normal household waste at the end of its service life. Take it to a collection point for the recycling of electrical and electronic devices. This is indicated by this symbol on the product, in the operating manual and on the packaging.



Please find out about collection points operated by your local authority.

Help protect the environment by recycling used products.

## Technical data



This product conforms to the European directives 2004/108/EC, 2006/95/EC and 2009/125/EC.

### Power supply

230 V~, 50 Hz

### Power

120 W

Technical and design modifications are reserved.

## Free Manuals Download Website

<http://myh66.com>

<http://usermanuals.us>

<http://www.somanuals.com>

<http://www.4manuals.cc>

<http://www.manual-lib.com>

<http://www.404manual.com>

<http://www.luxmanual.com>

<http://aubethermostatmanual.com>

Golf course search by state

<http://golfingnear.com>

Email search by domain

<http://emailbydomain.com>

Auto manuals search

<http://auto.somanuals.com>

TV manuals search

<http://tv.somanuals.com>