



DOC022.53.00720

DR 2800

USER MANUAL

January 2008, Edition 2



Section 1 Specifications	7
Section 2 General Information	9
2.1 Safety information	9
2.1.1 Use of hazard information	9
2.1.2 Precautionary labels	9
2.1.3 Class 1 LASER	9
2.1.4 Chemical and Biological Safety	10
2.2 Overview of product	10
Section 3 Installation	11
3.1 Unpack the instrument	11
3.2 Operating environment	11
3.3 Power connections	12
3.4 Connection	13
3.5 Cell compartments, Cell adapters, Light Shield and Protective Cover	14
3.5.1 Cell compartments and adapters	14
3.5.2 Installation of the cuvette/sample cell adapters	15
3.5.3 Use of the light shield for measurements	16
3.5.4 Protective Cover	18
3.6 Mobile use of the DR 2800 for field analysis	19
3.6.1 Position the Protective Cover	20
3.7 Beam path	21
Section 4 Start Up	23
4.1 Power the instrument on and off	23
4.2 Language selection	23
4.3 Self-Check	23
Section 5 Standard Operations	25
5.1 Overview	25
5.1.1 Tips for the use of the touch screen	25
5.1.2 Use of the alphanumeric keypad	25
5.1.3 Main Menu	26
5.2 Instrument Setup mode	27
5.2.1 Operator ID	27
5.2.2 Sample ID	28
5.2.3 Date and time	29
5.2.4 Display and sound preferences	29
5.2.5 Power Management	29
5.2.6 PC and printer	31
5.2.6.1 Printer setup	31
5.2.6.2 Print data	33
5.2.6.3 HACH Data Trans	33
5.2.7 Password	34
5.2.7.1 Password deactivation	35

Table of Contents

5.3 Store, recall, send and delete data	37
5.3.1 The data log	37
5.3.1.1 Auto/manual data storage	37
5.3.1.2 Recall stored data from the data log	37
5.3.1.3 Send data from the data log	38
5.3.1.4 Delete stored data from the data log	39
5.3.2 Time Course	40
5.3.2.1 Data Storage from Time Course	40
5.3.2.2 Recall Stored Data from Time Course	40
5.3.2.3 Send Data from Time Course	41
5.3.2.4 Delete Stored Data from Time Course	42
5.4 Stored Programs	43
5.4.1 Select a saved test/method; enter user-specific basic data	43
5.4.2 Stored program options	43
5.4.3 Use of program timers	45
5.4.4 Set the dilution factor	46
5.4.5 Run a standard adjust	46
5.4.6 Set the chemical form	47
5.4.6.1 Change of the default setting of the chemical form	48
5.4.7 Run a reagent blank	48
5.4.8 Analysis of samples	49
5.4.9 Add stored programs to the favorite programs list	50
5.5 Barcode Programs	51
5.5.1 Complete a barcode 13 mm test/vial	51
5.5.2 Select the measuring range	52
5.5.3 Select the chemical evaluation form	52
5.5.3.1 Change of the default setting of the chemical form	53
5.5.4 Basic test-specific and sample-specific data settings	53
5.5.5 Sample blank	54
5.5.6 Update/edit barcode tests	55
5.5.6.1 Manual update of a barcode test	55
5.5.6.2 Update an existing barcode test	58
5.5.6.3 Program a new test	59
5.5.7 Upgrade of the instrument software	59
Section 6 Advanced Operations	61
6.1 User Programs	61
6.1.1 Program a user method	61
6.1.1.1 Single wavelength settings	63
6.1.1.2 Multi wavelength settings	64
6.1.1.3 Calibration settings for single and multi wavelength mode	66
6.1.1.4 Store a user program	70
6.1.1.5 Additional user-defined parameters and functions	70
6.1.2 Free programming program type	72
6.1.2.1 Measurement process	72
6.1.2.2 Enter a new element of a measuring sequence	73
6.1.2.3 Enter the calibration formula (evaluation formula)	75
6.1.2.4 Enter variables	78
6.1.2.5 Save a free programming user program	78
6.1.3 Select a user program	79
6.1.4 Add, edit and delete user programs from the favorites list	79
6.1.4.1 Add to Favorites	80
6.1.4.2 Edit	80
6.1.4.3 Delete	80

6.2 Favorite Programs	81
6.2.1 Recall a favorite program	81
6.2.2 Delete a favorite program	81
6.3 Standard Addition – monitoring/checking results	82
6.3.1 Complete a standard addition	83
6.4 Single Wavelength (absorbance, concentration and transmittance measurements)	87
6.4.1 Set up single wavelength mode	87
6.4.2 Take single wavelength measurements	89
6.5 Multi-Wavelength mode – measurements at more than one wavelength	90
6.5.1 Set the reading mode at different wavelengths	90
6.5.2 Complete a measurement in the multi wavelength mode	93
6.6 Time course of absorbance/transmittance	94
6.6.1 Time course setup parameters	94
6.6.2 Time course scan reading	95
6.6.3 Analysis of time course data	96
6.6.3.1 Navigation of a time scan or a time scan analysis	97
6.7 System checks	97
6.7.1 Instrument information	98
6.7.2 Upgrade of the instrument software	98
6.7.3 Optical checks	99
6.7.3.1 Wavelength check	99
6.7.3.2 Stray light check	100
6.7.3.3 Absorbance check	101
6.7.3.4 Verification kit	102
6.7.4 Output checks	104
6.7.5 Lamp history	104
6.7.6 Factory service	104
6.7.7 Service time	105
6.7.8 Instrument Backup	106
Section 7 Maintenance	109
7.1 Cleaning requirements	109
7.1.1 Spectrophotometer	109
7.1.2 Display	109
7.1.3 Cuvettes/sample cells	109
7.2 Insert or change of the battery	110
7.2.1 Information about using the battery	111
7.2.1.1 Dispose of the lithium battery	111
7.2.1.2 Optimal operation of the battery	112
7.2.1.3 Lifespan of the battery	112
7.2.1.4 Load the battery/Operating time	112
7.3 Lamp replacement	113
Section 8 Troubleshooting	117
Section 9 Replacement Parts	119
Section 10 Contact Information	121
Section 11 Limited Warranty	123
Index	125

Section 1 Specifications

Specifications are subject to change without notice.

Performance Specifications	
Operating Mode	Transmittance (%), Absorbance and Concentration
Source Lamp	Gas-filled Tungsten (visible)
Wavelength Range	340–900 nm
Wavelength Accuracy	± 1.5 nm
Wavelength Reproducibility	< 0.1 nm
Wavelength Resolution	1 nm
Wavelength Calibration	Automatic
Wavelength Selection	Automatic, based on method selection
Spectral Bandwidth	< 8 nm
Photometric measuring range	± 3.0 Ext in Wavelength Range 340–900 nm
Photometric Accuracy	5 mAbs at 0.0–0.5 Abs 1% at 0.50–2.0 Abs
Photometric Linearity	< 0.5%–2 Abs < = 1% at > 2 Abs with neutral glass at 546 nm
Stray Light	< 0.2% T @ 340 nm with KV450/3 < 0.1% T @ 340 nm with NaNO ₂
Data storage	500 measured values (result, date, time, sample ID, user ID)
User programs	50
Physical and Environmental Specifications	
Width	220 mm (8.6 in)
Height	135 mm (5.3 in)
Depth	330 mm (12.9 in)
Weight	4.06 kg (8.95 lbs) without battery 4.38 kg (9.66 lbs) with battery
Operating Requirements	10–40 °C (50–104 °F), max. 80% relative humidity (non-condensing)
Storage Requirements	-40–60 °C (-40–140 °F) max. 80% relative humidity (non-condensing)
Additional technical data	
Mains connection	15 V- / 30VA Plug-in power supply unit: (100–240 V/50–60 Hz)
Interfaces	Use only shielded cable with max. length of 3 m. 1 x USB type A 1 x USB type B
Enclosure Rating	IP 41 with closed lid IP 42 with Protective Cover in place
Safety class	Safety class II

Section 2 General Information

2.1 Safety information

Please read this entire manual before unpacking, setting up or operating this equipment. Pay attention to all danger, warning and caution statements. Failure to do so could result in serious injury to the operator or damage to the equipment.

Make sure that the protection provided by this equipment is not impaired, do not use or install this equipment in any manner other than that specified in this manual.

2.1.1 Use of hazard information

DANGER

Indicates a potentially or imminently hazardous situation which, if not avoided, will result in death or serious injury.

WARNING

Indicates a potentially or imminently hazardous situation which, if not avoided, could result in death or serious injury.

CAUTION



Indicates a potentially hazardous situation that may result in minor or moderate injury.

Important Note: *Indicates a situation which, if not avoided, may cause damage to the instrument. Information that requires special emphasis.*

Note: *Information that supplements points in the main text.*

2.1.2 Precautionary labels

Read all labels and tags attached to the instrument. Personal injury or damage to the instrument could occur if not observed. A symbol, if noted on the instrument, will be included with a danger or caution statement in the manual.

	This symbol, if noted on the instrument, references the instruction manual for operation and/or safety information.
	Electrical equipment marked with this symbol may not be disposed of in European public disposal systems after 12 August of 2005. In conformity with European local and national regulations (EU Directive 2002/96/EC), European electrical equipment users must now return old or end-of life equipment to the Producer for disposal at no charge to the user. Note: <i>For return for recycling, please contact the equipment producer or supplier for instructions on how to return end-of-life equipment, producer-supplied electrical accessories and all auxiliary items for proper disposal.</i>
LASER CLASS 1	This symbol indicates that the instrument contains a Class 1 LASER device. Data: 0.3 mW; $\lambda = 650 \text{ nm}$

2.1.3 Class 1 LASER

A Class 1 LASER is installed in this instrument. Class 1 LASERS are products where the radiant power of the LASER beam accessible (the accessible emission) is always below the Maximum

Permissible Exposure value. Therefore, for Class 1 LASERS the output power is below the level at which it is believed eye damage will occur. Exposure to the beam of a Class 1 LASER will not result in eye injury. Class 1 LASERS may therefore be considered safe. However, Class 1 LASER products may contain LASER systems of a higher Class but there are adequate engineering control measures to ensure that access to the beam is not reasonably likely. Examples of such products include LASER printers and compact disc players. CDRH assessment number 0510555-02.

Data: 0.3 mW; wavelength = 650 nm

2.1.4 Chemical and Biological Safety

DANGER

Potential Chemical/ Biological Exposure Hazards. Handling chemical samples, standards and reagents can be dangerous. Users of this product are advised to familiarize themselves with safety procedures and the correct use of chemicals, and to carefully read all relevant Material Safety Data Sheets.

Normal operation of this instrument may involve the use of hazardous chemicals or biologically harmful samples.

- The user must observe all cautionary information printed on the original solution containers and safety data sheet prior to their use.
- All waste solutions must be disposed in accordance with local and national law.
- The type of protective equipment must be selected according to the concentration and amount of the dangerous substance at the specific workplace.

2.2 Overview of product

The DR 2800 spectrophotometer is a VIS spectrophotometer with a wavelength range of 340 to 900 nm. The instrument comes with a complete set of application programs and multi-language support.

The DR 2800 spectrophotometer contains the following application modes: Stored Programs (pre-installed tests), Barcode Programs, User Programs, Favorite Programs, Single Wavelength Mode, Multi-Wavelength Mode and Time Course Mode.

The DR 2800 spectrophotometer provides digital readouts in direct concentration units, absorbance, or percent transmittance.

When a user-generated or programmed method is selected, the on-screen menus and prompts direct the user through the test.

This menu system also can be used to generate reports, statistical evaluations of generated calibration curves, and to report instrument diagnostic checks.

WARNING

Electrical and Fire Hazards. Use only the provided power supply. Only qualified personnel should conduct the tasks described in this section of the manual.

3.1 Unpack the instrument

The DR 2800 Spectrophotometer comes packaged with the following items:

- DR 2800 spectrophotometer
- Plug-in power supply, including 4 adapter for EU, GB, USA, AUS/China
- Dust cover
- 3 different cuvette/cell adapters (A, B and C)
- Light Shield belongs to standard configuration of DR 2800
- Protective Cover
- DR 2800 User Manual
- CD-ROM containing the HACH and HACH LANGE procedures
- Quick start guide

Note: *If any of these items are missing or damaged, contact the manufacturer or a sales representative immediately.*

3.2 Operating environment

The following conditions are necessary to ensure correct instrument operation and accurate results:

- Place the instrument firmly on an even surface. Do not push any objects under the instrument.
- Maintain an ambient temperature of 10 to 40 °C (50 to 104 °F) for proper instrument operation.
- The relative humidity should be less than 80%; moisture should not condense on the instrument.
- Leave at least a 15 cm (6 in.) clearance at the top and on all sides for air circulation to avoid overheating of electrical parts.
- Do not operate or store the instrument in extremely dusty, damp or wet locations.
- Keep the surface of the instrument, the cell compartment and all accessories clean and dry at all times. Splashes or spills on and in the instrument should be cleaned up immediately (see section 7.1 on page 109).

Important Note: *Protect the instrument from temperature extremes, including heaters, direct sunlight and other heat sources.*

3.3 Power connections

Install the correct adapter plug on the supplied external power supply (Figure 1) by sliding the adapter on until it "clicks" into position. Correctly mounted, both housing of power supply and plug are in line. Plug the external power supply cord into the connector on the back panel of the instrument, then plug the supply into a power outlet (100–240 V~ / 50–60 Hz). Press the power switch on the back of the instrument to initialize power (Figure 2 on page 13).

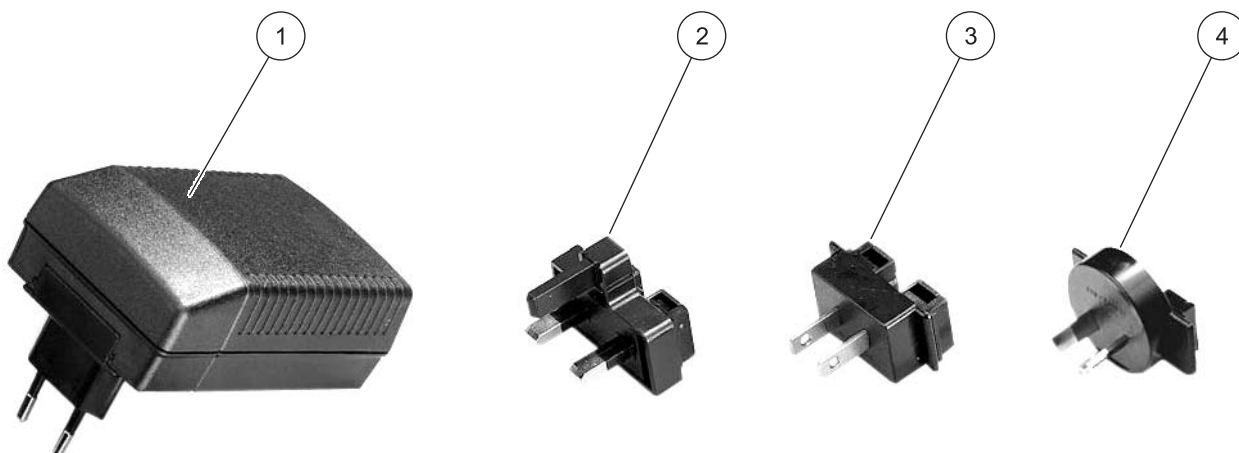

Figure 1 Power adapter

1	Power supply with EU adapter plug installed	3	USA adapter plug
2	UK adapter plug	4	AUS/China adapter plug

3.4 Connection

The DR 2800 has two USB interfaces as a standard feature, located on the back of the instrument (Figure 2).

The USB Type A interface is used for communications with a printer, USB memory stick, barcode scanner, or keyboard. A USB memory stick is used to update instrument software.

The USB Type B interface is used for communications with a PC. The optional Hach Data Trans software (see section 5.2.6.3 on page 33) must be installed on the PC for this use.

A USB hub may be used to connect several accessories at a time.

Note: USB cables **must not** be longer than 3 meters (10 feet).

These USB interfaces enable data and graphics to be output to a Printer and a PC and upgrade instrument software (see section 6.7.2 on page 98).



Figure 2 Interfaces

1	On/Off switch	4	Cover
2	USB type B	5	USB type A
3	Plug in power supply		

3.5 Cell compartments, Cell adapters, Light Shield and Protective Cover

3.5.1 Cell compartments and adapters

The DR 2800 has two cell compartments (Figure 3). Only one cuvette/sample cell type at a time can be used for a measurement.

Cell compartment #1

- 13-mm and 16-mm round cuvettes/vials

Note: Cell compartment #1 contains a barcode reader for cuvettes/vials.

Cell compartment #2

Cell compartment #2 uses adapters to accommodate different cuvette/sample cell types.

- 1-inch square or 50-mm rectangular cuvettes/cells (can be inserted directly into the cell compartment without using an adapter).
- Adapter A: 10-mm square cuvettes/cells
- Adapter B: Pour-Thru cells (refer to the instruction sheet supplied with the Pour-Thru cell) and multi-path cuvettes/cells

*Note: Pour-Thru Cell **must be** used with Adapter B, **not** Adapter C.*

- Adapter C: One-inch round cuvettes/cells and AccuVac® Ampules

*Note: One-inch round cuvettes/cells and AccuVac Ampules **must be** used with Adapter C, **not** Adapter B.*



Figure 3 Cell compartments

1 Cell compartment #1	2 Cell compartment #2
-----------------------	-----------------------

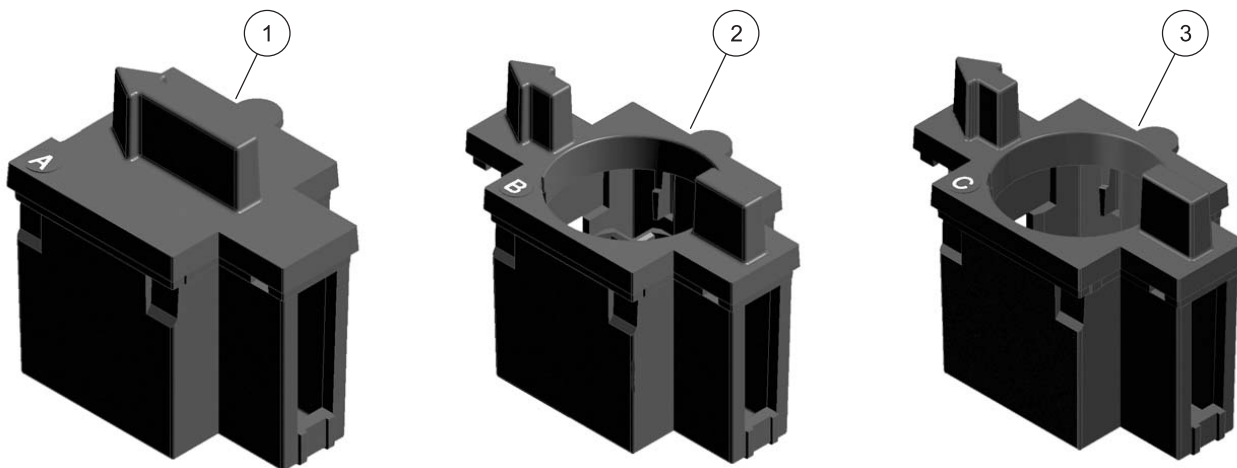

Figure 4 Cuvette/Sample cell adapters

1	10 mm square cuvette/sample cell adapter (A)	3	1 inch round cuvette/sample cell adapter (C)
2	1 inch Pour-Thru adapter (B)		

3.5.2 Installation of the cuvette/sample cell adapters

1. Open the cell compartment.
2. Select the correct adapter for the cuvette/sample cell type.
3. Insert the adapter so the arrow on top of the adapter points to the left (Figure 5 on page 16) and the orientation tab fits the groove in the compartment opening. The cuvette/sample cell type imprint should be legible on the adapter (Figure 4).

Note: The arrow on top of the adapter indicates the direction of the light beam path.



Figure 5 Installation of a cuvette/sample cell adapter

3.5.3 Use of the light shield for measurements

The light shield (Figure 6 on page 17) prevents light interference when using 13 mm and 16 mm vial tests and must be in place before measurements can be taken in cell compartment #1. The light shield is required only when using 13 mm or 16 mm vial tests.

The DR 2800 is shipped with the light shield installed. Remove the light shield before using cell compartment #2. The light shield can be stored in the Protective Cover (Figure 8 on page 18)

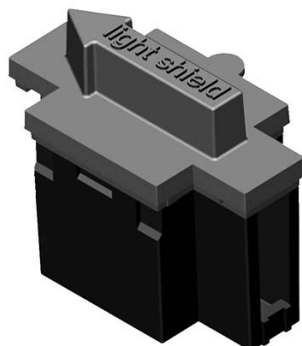

Figure 6 Light Shield

Installation of the light shield

1. Open the cell compartment.
2. Insert the light shield so the arrow on the light shield points to the left and the orientation tab fits the groove in the compartment opening (Figure 7).



Figure 7 Light Shield in place

1 Light Shield

3.5.4 Protective Cover

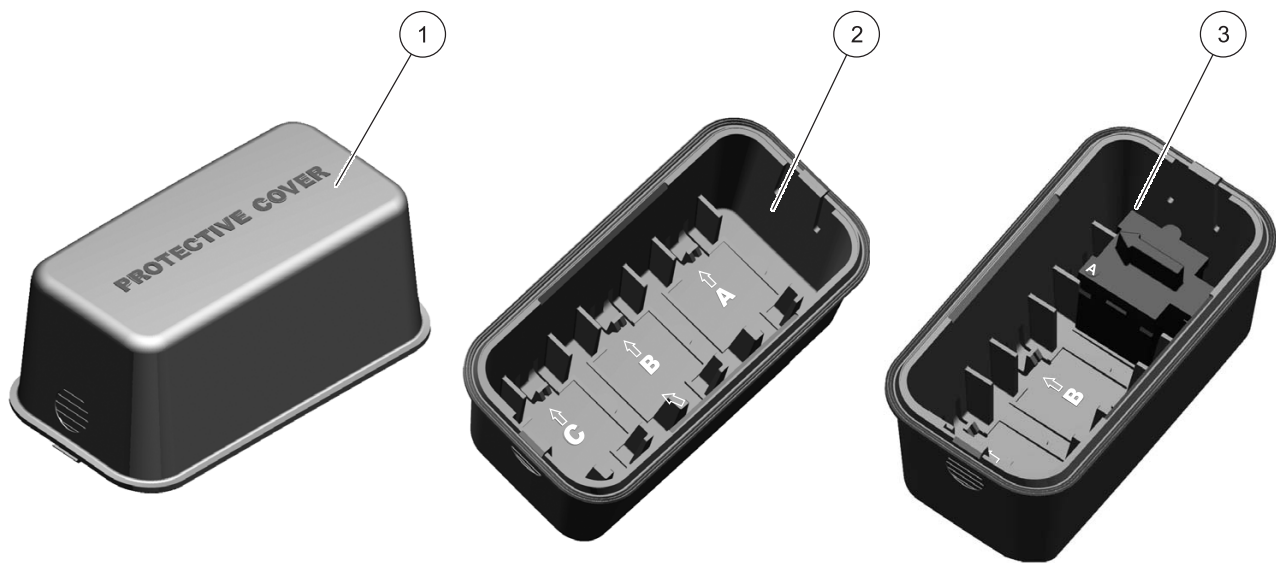

Figure 8 Protective Cover

1 Protective Cover	3 Protective Cover with inserted cuvette/sample cell adapter A in position A.
2 Protective Cover (inside view) The inside of the Protective Cover is intended to house the cuvette/sample cell adapters. The recesses for holding the cuvette/sample cell adapters are marked with the corresponding letters.	

3.6 Mobile use of the DR 2800 for field analysis



If the DR 2800 spectrophotometer is used to carry out field analyzes, it may be necessary to take a number of measures to compensate for the fluctuating ambient light conditions.

You should take the measures described below if the following warning is displayed after you take a measurement:

Error: Too much ambient light! Move device into shade or close the lid!

General measure:

Shield the instrument from the sun by standing so that your shadow falls on it, and carry out the measurement again. If the warning appears again, take the following measures.

Measures:

Measurements in a 10 mL round cuvette/cell, a rectangular cuvette/cell or AccuVac Ampules

Close the lid of the cuvette compartment and carry out the measurement.

Measurements in a 13 or 16 mm round cuvette/vial or a 25 mL square cuvette/cell

To obtain consistent measurement conditions in all weather conditions, place the Protective Cover on the open cuvette/cell compartment (see Figure 9 Position the Protective Cover on page 20) and carry out the measurement.

Important Note: *When you carry out measurement in 25 mL square cuvettes/cells, take care that there is no adapter in the Protective Cover.*

The enclosure rating of the photometer increases from IP41 to IP42 when the Protective Cover is in place.

3.6.1 Position the Protective Cover



Figure 9 Position the Protective Cover

1. After you have inserted the zero solution cell or the sample cell, position the Protective Cover over the open cell compartment. The lettering "Protective Cover" must be readable from the display side of the instrument.
2. Press the Protective Cover lightly into the correct position until the cell compartment is completely sealed and the Protective Cover cannot slip off.
3. Carry out the measurement.

Note: The Protective Cover can simultaneously be used to house the different cuvette adapters. The cuvette adapter recesses in the Protective Cover are marked with the corresponding letters and arrows of the adapter. The arrows in the Protective Cover and on the adapters indicate the direction of insertion.

3.7 Beam path

Figure 10 shows the beam path of the DR 2800:

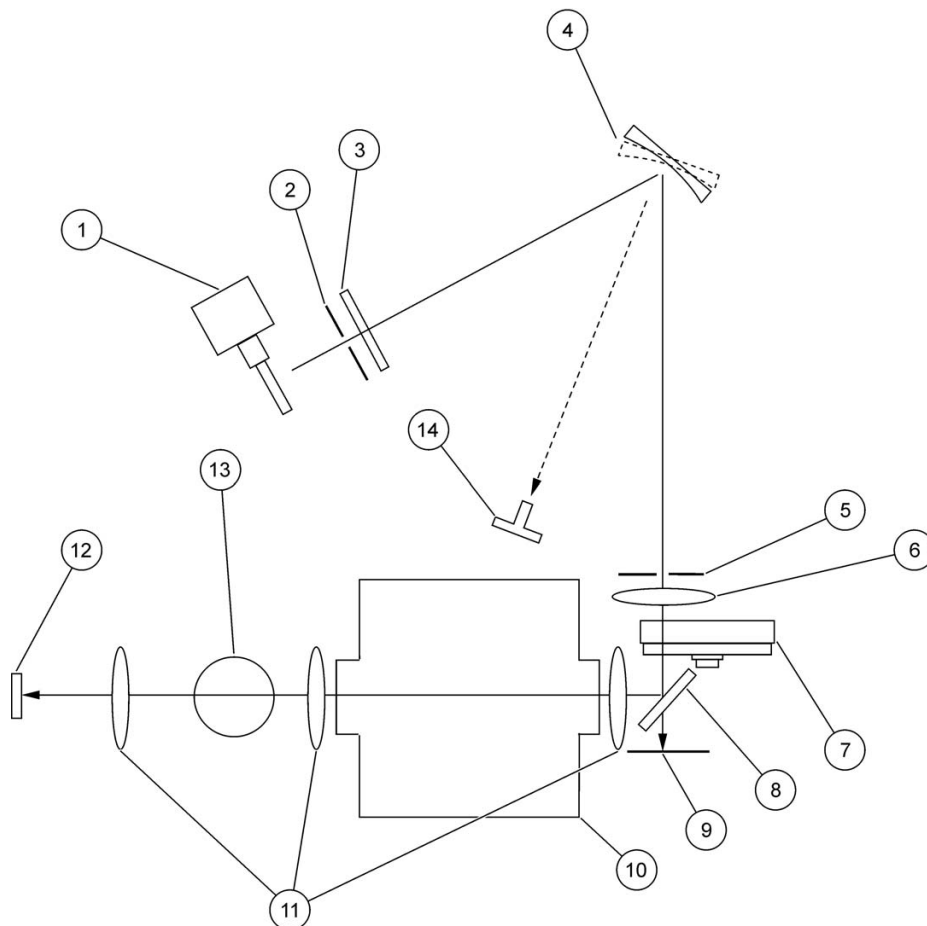

Figure 10 Beam path

1 Tungsten lamp	8 Splitter mirror
2 Entrance slit	9 Reference-element
3 Heat-protection glass	10 Cell compartment #2
4 Grating	11 Lens
5 Exit slit	12 Measurement element
6 Lens	13 Cell compartment #1
7 Filter wheel	14 LED

Section 4 Start Up

4.1 Power the instrument on and off

1. Plug in to the power supply (laboratory analysis) or insert the battery (field analysis).
2. The push-button switch on the back of the instrument switches the instrument on (press for about 1 second) and off (press for about 3 to 5 seconds). An acoustic signal confirms that the instrument has been switched off.

Note: Do not turn the instrument off and on in rapid succession. Always wait about **20 seconds** before turning the instrument on again, otherwise the electronic and mechanical systems will be damaged.

4.2 Language selection



The spectrophotometer software includes several language options. The first time the instrument is turned on, the language selection screen will appear.

1. Select the desired language.
2. Press **OK** to confirm the language selection. The self check will start automatically.

Change the language setting

The instrument functions in the selected language until the option is changed.

1. While turning the instrument on, touch the screen at any point until the list for selecting a language appears (about 30 seconds).
2. Select the required language.
3. Press **OK** to confirm. The test program subsequently starts automatically.

4.3 Self-Check

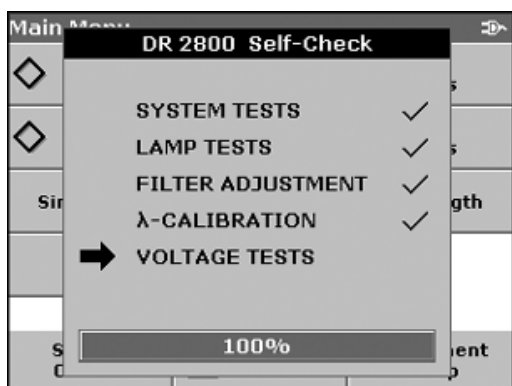

Each time the instrument is powered up, a series of diagnostic tests are performed automatically to ensure operation of major system components.

This procedure, which takes approximately two minutes, checks the system, lamp, filter adjustment, wavelength calibration and voltage. Each test which functions correctly is confirmed with a check mark.

The Main Menu is displayed when power up diagnostics are completed.



If the instrument detects any deviation relative to the last calibration, a system check has to be carried out.

4. Remove the cuvette from the cell compartment and close the lid.
5. Then press **Start**.

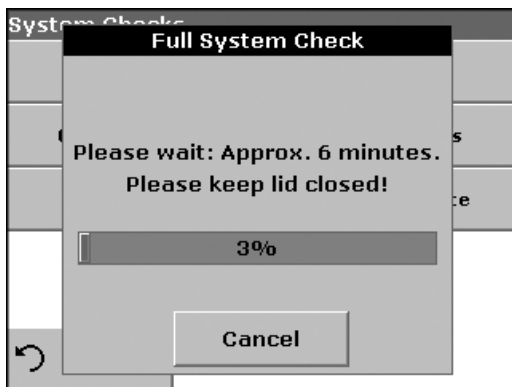

The system check is carried out (duration approx. 6 minutes).

Note: Further error messages during self check, see Section 8 on page 117.

Section 5 Standard Operations

5.1 Overview

5.1.1 Tips for the use of the touch screen

The entire screen is touch-activated. To make a selection, press the screen with a fingernail, fingertip, pencil eraser or a stylus. Do not press the screen with a sharp object, such as the tip of a ball point pen.

- Do not place anything on top of the screen, to prevent damage or scratching on the screen.
- Press keys, words or icons to select them.
- Use scroll bars to move up and down long lists very quickly. Press and hold the scroll bar, then move up or down to move through the list.
- Highlight an item from a list by pressing it once. When the item has been successfully selected, it will be displayed as reversed text (light text on a dark background).

5.1.2 Use of the alphanumeric keypad

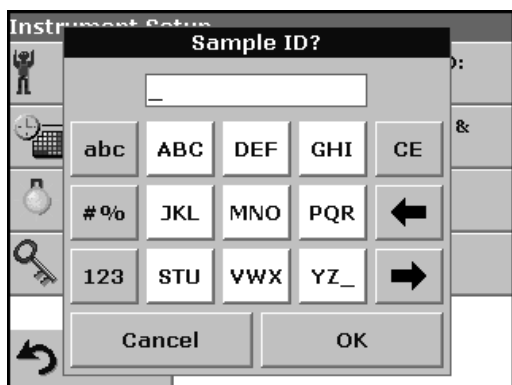

This display is used to enter letters, numbers and symbols as needed when programming the instrument. Unavailable options are disabled (grayed out). The icons on the right and left of the screen are described in Table 1.

The central keypad changes to reflect the chosen entry mode. Press a key repeatedly until the desired character appears on the screen. A space can be entered by using the underscore on the YZ_ key.

Note: A USB keyboard (with US keyboard layout) or a USB Barcode handset scanner can be used for input (see Section 9 on page 119).

Table 1 Alphanumeric keypad

Icon / key	Description	Function
ABC/abc	Alphabetic	When entering alphabetic characters (ex. user-entered units), this key allows to toggle between upper and lower case letters.
# %	Symbols	Punctuation, symbols and numerical sub- and superscripts may be entered.
123	Numeric	For entering regular numbers.
CE	Clear Entry	Clear the entry.
Left Arrow	Backspace	Moves back one position. This deletes the character previously entered in the new position.
Right Arrow	Advance	Moves to the next space in an entry when two adjacent characters occur on the same key.

5.1.3 Main Menu

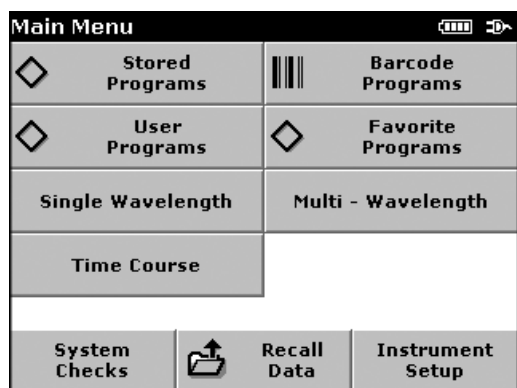

A variety of modes may be selected from the "Main Menu". The following table briefly describes each menu option.

Table 2 "Main Menu" Options DR 2800

Option	Function
Stored Programs / Barcode Programs (HACH LANGE Programs)	Stored programs are pre-programmed methods that make use of HACH reagents and LANGE cuvette tests and pipette tests. The DR 2800 Procedures Manual contains illustrated, step-by-step procedures for analyzes using HACH programs. The working procedures for LANGE tests are included in the test packs.
User Programs	User programs make "made to measure analysis" possible: - Users can program methods they have developed themselves - Existing HACH and LANGE methods can be stored as user programs. The LANGE tests can then be modified to suit the user's requirements.
Favorite Programs	List of methods/tests created by the user to suit his own requirements.
Single Wavelength	Single wavelength measurements are: Absorbance measurements: The light absorbed by the sample is measured in absorbance units. Transmittance measurements (%): The percentage of the light that passes through the sample and reaches the detector is measured. Concentration measurements: A concentration factor can be entered to enable the measured absorbance values to be converted into concentration values.
Multi Wavelength	In the multi-wavelength mode, absorbance (Abs) or percentage transmittance (%T) is measured at up to four wavelengths, and absorbance differences and absorbance relationships are calculated. Simple conversions into concentrations can also be carried out.
Time Course	The time scan records the absorbance or % transmittance at a wavelength over a defined time.
System Checks	The system checks menu offers a number of options, including optical checks, output checks, lamp history, instrument update, service time and instrument backup.
Recall Data	Stored data can be called up, filtered, transmitted and deleted.
Instrument Setup	In this mode, user-specific or method-specific settings can be entered: Operator-ID, Sample-ID, Date & Time, Display & Sound, Power Management, PC & Printer and Password.

5.2 Instrument Setup mode

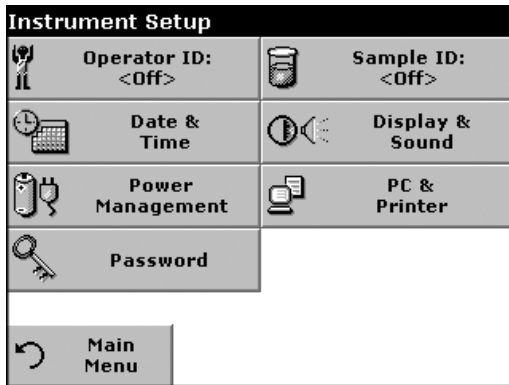

1. Select **Instrument Setup** in the "Main Menu".

A selection of functions appears in order to configure the functions of the instrument.

5.2.1 Operator ID

Use this option to enter up to 30 sets of operator initials (up to 5 characters each) into the instrument. This feature helps record which operator measured each sample.

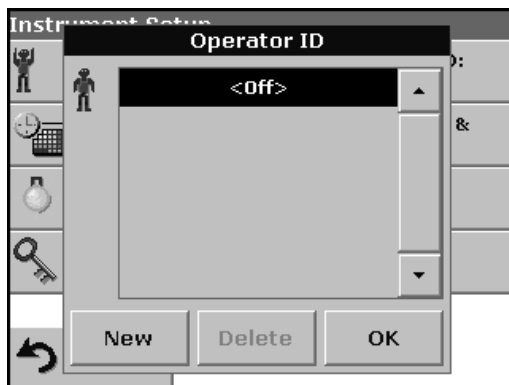

1. Press **Operator ID** in the Instrument Setup.
2. Press **New** to enter a new Operator ID.
3. Use the alphanumeric keypad to enter a new Operator ID.
4. Press **OK** to confirm.

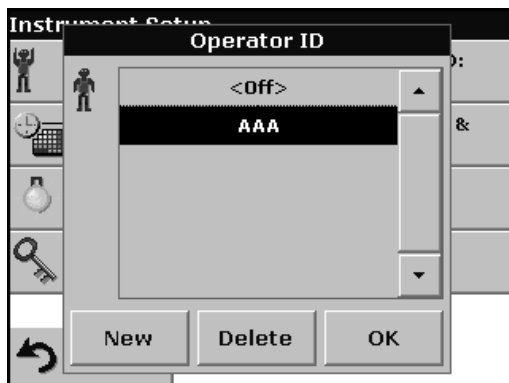

5. The display shows the chosen Operator ID.
6. Press **OK**. The instrument will return to the Instrument Setup screen and show the selected operator identifier.
7. The chosen Operator ID is activated.

Note: Press **Delete** to remove an Operator ID from the list.

Note: Alternatively, enter or change an Operator ID in measurement mode. In the results screen, press **Options>More>Instrument Setup** or if an Operator ID is already assigned, select the "Operator ID symbol immediately in the results screen.

5.2.2 Sample ID

Use this option to enter up to 100 Sample Identification tags (up to 13 characters each) into the instrument. Sample IDs can be used to specify the sample location or other sample specific information.

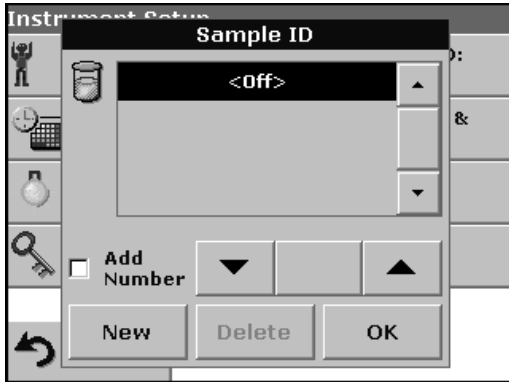

1. Press **Sample ID** in the Instrument Setup.
2. Press **New** to enter a new Sample ID.

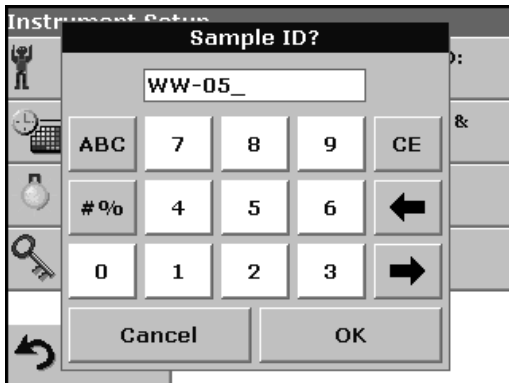

3. Use the alphanumeric keypad to enter a new Sample ID.

Note: If a USB Barcode handset scanner (see Section 9 on page 119) is connected, Sample IDs can also be scanned. Sample IDs can also be entered with a USB keyboard.

4. Press **OK** to confirm.

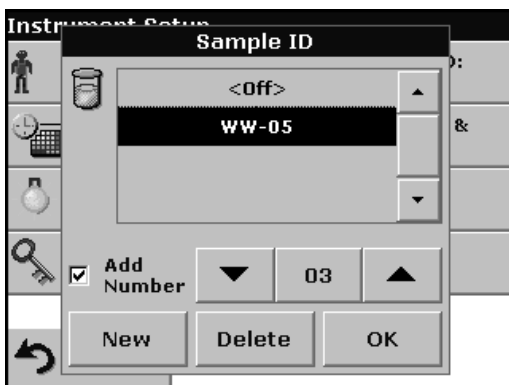

5. To number the Sample IDs sequentially (e.g. Inflow (01 etc.)), select **Add Number**.

- Use the arrow keys to specify the first number of the sequence.
- Use the key between the arrow keys to enter the first number of the sequence using the alphanumeric keypad.

6. Press **OK** to return to "Instrument Setup".

7. The Sample ID is activated. Each Sample ID is automatically numbered in ascending order after a measurement. The number is shown in parentheses behind the Sample ID.

Note: To remove a Sample ID, highlight the ID and press Delete.

*Note: A Sample ID can be entered or changed in measurement mode. In the results screen, press **Options>More>Instrument Setup**. If a Sample ID is already assigned, select the Sample ID symbol in the results screen.*

5.2.3 Date and time

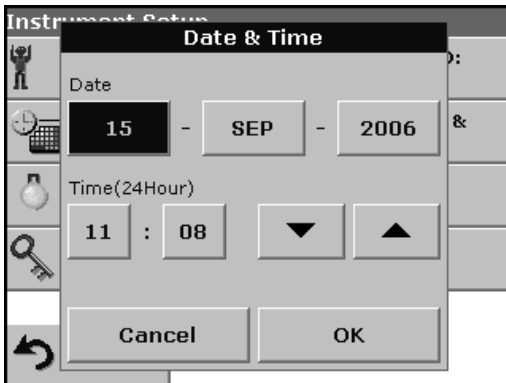

1. Press **Date & Time** in the Instrument Setup.
2. The date and time are subdivided over a number of fields. Press the appropriate field and use the arrow keys to change the value.
3. Press **OK** to confirm. The instrument will return to Instrument Setup.

5.2.4 Display and sound preferences

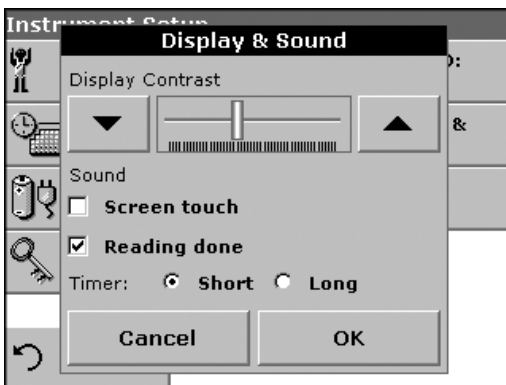

1. Press **Display & Sound** in the Instrument Setup.

The following options will be displayed:

- **Display Contrast**—Adjusts the display brightness to suit lighting conditions.
 - **Screen touch**—Activates//Deactivates a short beep each time the screen is pressed (Default:off).
 - **Reading done**—Activates/Deactivates a sound when a reading is complete (Default: short beep every time a reading is complete).
 - **Timer**—Adjusts the length of the timer sound. Select Short or Long. Long beeps are recommended for noisy environments.
2. Press **OK** to confirm. The instrument will return to Instrument Setup.

5.2.5 Power Management

The DR 2800 can run on mains or battery power.

Note: The battery is **not** part of the standard scope of delivery.

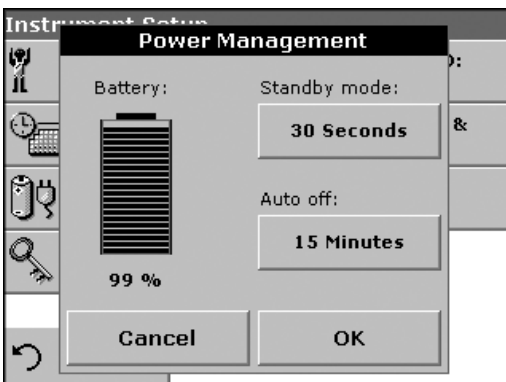

1. Select **Power Management** in the "Instrument Setup" menu.

The battery symbol indicates the charge status of the battery in %.

Note: The timer settings in the **Power Management** menu are only active when the instrument is running on battery power.

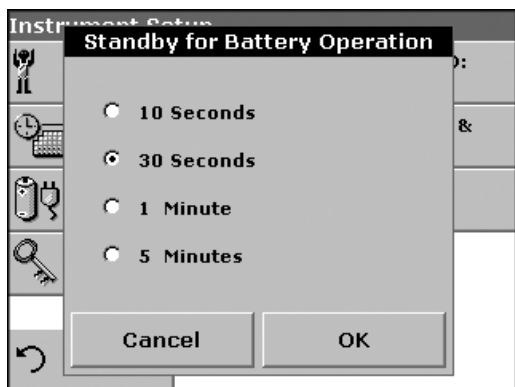

2. Select one of the options under **Standby mode** to set the length of the idle period that can elapse before the instrument switches to the Standby mode when running on battery power.

Note: In standby mode, the backlighting of the screen is switched off. Touching the display causes the lighting to switch on again.

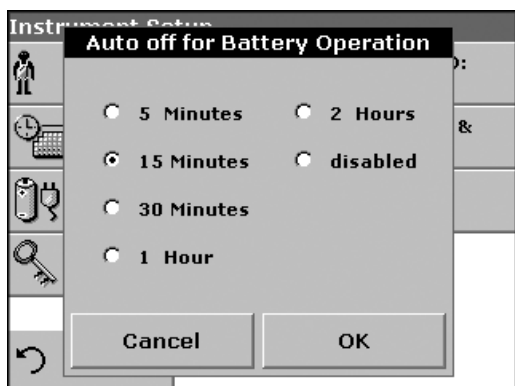

3. Select one of the options under **Auto off** to set the length of the idle period that can elapse before the instrument automatically switches off when running on battery power.

Note: After the instrument switches itself off automatically, you have to press the push-button switch on the back of the instrument to start it again.

5.2.6 PC and printer

The instrument is provided with 2 USB interfaces, which are located on the back of the instrument (see Figure 2 on page 13). These interfaces can be used for exporting data and graphics to a printer, updating data and for data communication to a personal computer. These interfaces can be used for the connection of a USB stick, an external USB keyboard or a USB Barcode handset scanner.

Note: A USB hub may be used to connect several accessories at a time.

A USB memory stick is used to upgrade data and software, see section 6.7.2 on page 98.

Important Note: A screened **USB cable** must not be longer than **3 m!**

Table 3 USB connector

USB Interfaces	Description
USB (Type B)	This USB interface is only intended to connect the instrument to a PC (with installation of the HACH Data Trans Software).
USB (Type A)	This USB port can be used to connect a printer, a USB memory stick , a barcode scanner or a keyboard.



1. Press **PC & Printer** in the Instrument Setup.

A list with information about the connections opens.

5.2.6.1 Printer setup



For reasons of compatibility, the printer language must be **HP PCL 3**.

2. Press **Printer**.
3. Press **Setup** to display the Printer Setup screen.



Printer Setup:

- Resolution: Print quality
- Paper: Paper size

Note: If an optional Thermal Printer is connected, the function "Auto Send" on/off is available.



4. Select **Auto-Send: On** to send all measured data automatically to the Thermal printer.

Note: The option Auto-Send is **not** available for any other printer (e.g. ink jet printer).

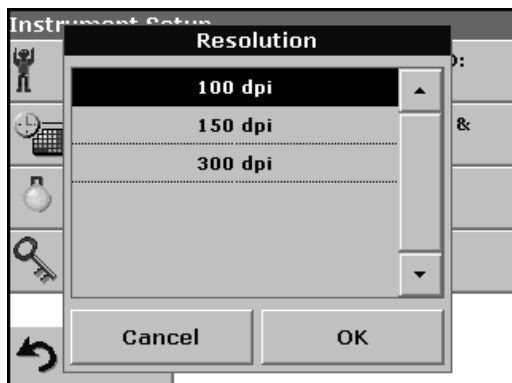

5. Press **Resolution** to select the print quality.

Select between

- 100 dpi
- 150 dpi and
- 300 dpi

6. Press **OK** to confirm.

Note: Press **OK** again to return to the **PC & Printer** menu.

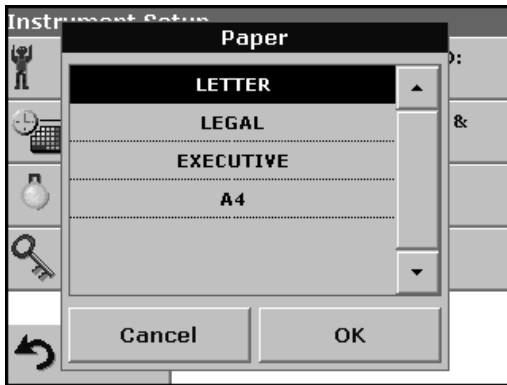

7. Press **Paper** to select the paper size.

Select between

- Letter
- Legal
- Executive
- A4

8. Press **OK** to confirm.

Note: Press OK again to return to the PC & Printer menu.

5.2.6.2 Print data

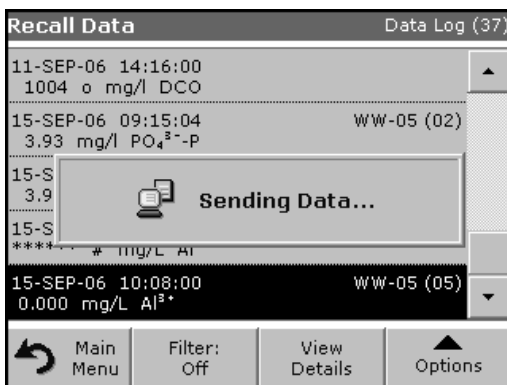

1. Press **Recall Data** in the Main Menu.

2. Select the data source, where the data to be printed are stored.

3. A list is displayed. Data can be filtered. For more information see section 5.3.1.2 on page 37.

4. Press the **PC & Printer** icon to send the data (table, curve) immediately to the printer.

5. Highlight **Single point** or **Filtered data** or **All data** and press **OK** to confirm.

Sending Data... is displayed until the data have been printed.

5.2.6.3 HACH Data Trans

The optional HACH Data Trans software must be installed on the PC for the subsequent to process for measurement data.



1. Press **PC & Printer** in the Instrument Setup.

2. Select **PC**.

3. Press **Setup** to display the PC Setup screen.

For further installation instructions, refer to the HACH Data Trans user manual.

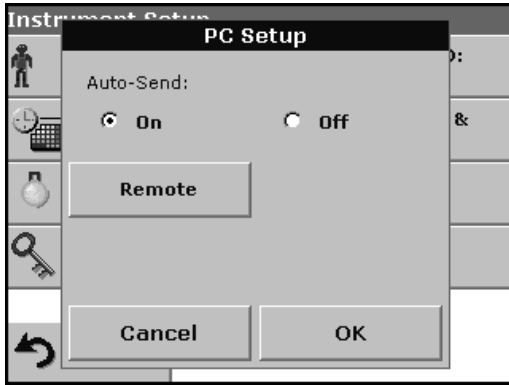

4. Select **Auto-Send: On** to send all measured data automatically to the PC.

*Note: If **Auto-Send: Off** is selected, the **PC & Printer** icon must be pressed, in order to send data to the PC.*

Note: The remote function is only for monitoring the data transfer.

5.2.7 Password

The Password menu contains a variety of security settings to control access to various functions. For example, prevent unauthorized changes to stored programs or instrument configurations.



1. Press **Password** in the Instrument Setup menu.
2. In order to highlight the **Security List** assign a password. Press **Set Password**.

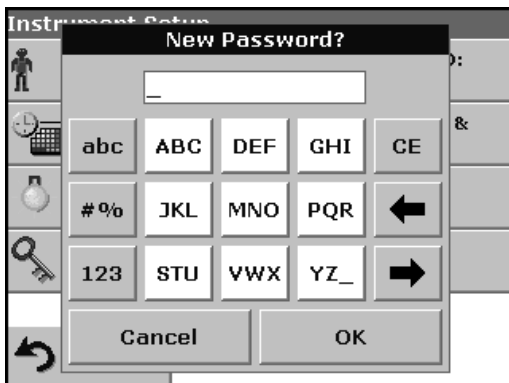

3. Use the alphanumeric keypad to enter a new Password (up to 10 characters each) and press **OK** to confirm.

The access to the Security List is activated.



4. Press **Security List** to lock various functions for unauthorized users.



5. Highlight the desired functions to control.
6. Confirm the **Security List** with **OK** to return to the Password menu.
7. Press **On** to highlight the new settings of the Security List.
8. Enter the new Password again to confirm.
9. Press **OK** to return to Instrument Setup.

Note: The alphanumeric keypad to the Password inquiry appears when a user tries to reach a locked setting.

5.2.7.1 Password deactivation

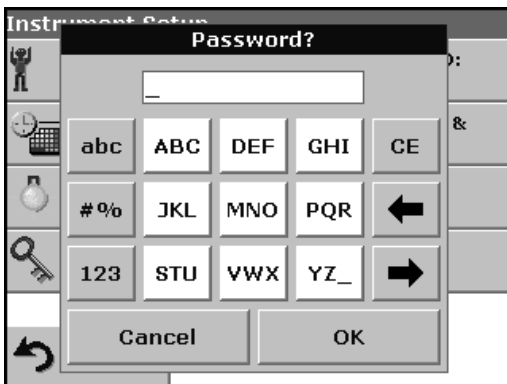

1. Press **Password** in the Instrument Setup.
2. Use the alphanumeric keypad to enter the former Password and press **OK** to confirm.



3. Press **Off** to deactivate the settings of the Security List.

4. Press **OK** to return to Instrument Setup.

Note: Use this function to delete the former Password or to enter a new one.

5.3 Store, recall, send and delete data

5.3.1 The data log

The Data Log will store up to 500 readings taken in the modes: Stored Programs, Barcode Programs, User Programs, Favorite Programs, Single Wavelength and Multi Wavelength. A complete record of the analysis is stored, including the Date, Time, Results, Sample ID, and Operator ID.

5.3.1.1 Auto/manual data storage

The data storage parameter indicates whether data are to be stored automatically or manually (in which case the user has to decide which data to store).

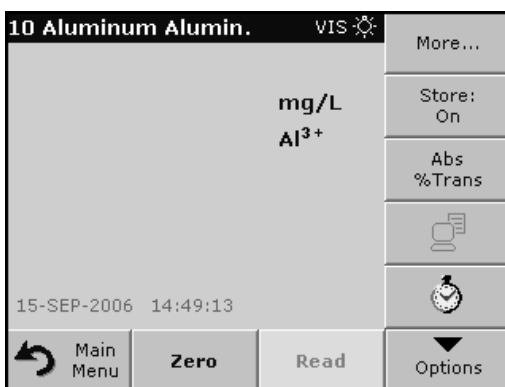

1. Press **Store: On/Off** in the Options menu.

- With the **Store On** setting, all measurement data are stored automatically.
- With the **Store Off** setting, no measurement data are stored. However, this setting can be changed to **Store On** in the result display through configuration. The reading currently shown in the display is then stored.

Note: When the instrument's memory (data log) is full, the oldest data are automatically deleted allowing the new data to be stored.

5.3.1.2 Recall stored data from the data log

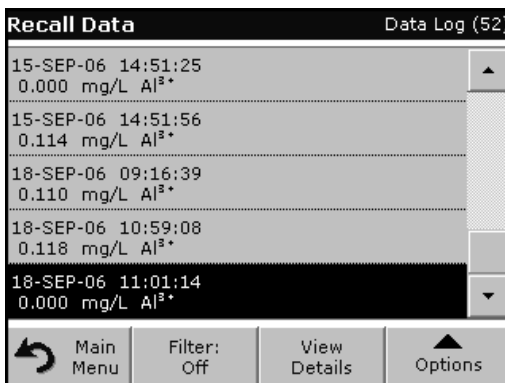

1. Press **Recall Data** in the Main Menu.

2. Press **Data Log**.

A listing of the stored data is displayed.

3. Press **Filter: On/Off**.

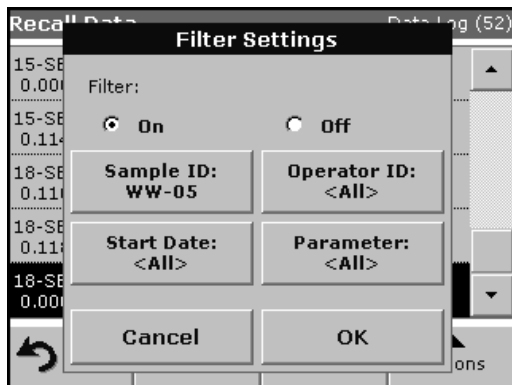

4. The function **Filter Settings** is used to search for specific items.

5. Highlight **On** to turn on the filters to select data by

- Sample ID
- Operator ID
- Start Date
- Parameter

or any combination of the four.

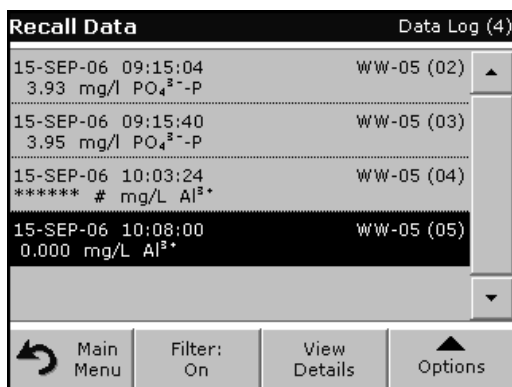

6. Press **OK** to confirm the selection. The chosen items are listed.

7. Press **View Details** to get more information.

5.3.1.3 Send data from the data log

Data is sent from the data log as CSV (Comma Separated Value) files through a USB memory stick to a file named DATALOG. The file can then be processed using a spreadsheet program. The file name will be formatted as:

DLYear_Month_Day_Hour_Minute_Second. CSV.

To send data to a Printer, see section 5.2.6.2 on page 33.

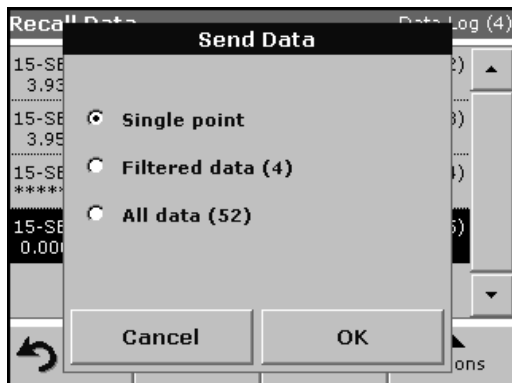

1. Plug in the USB device (Figure 2 on page 13).

2. Press **Recall Data** from the Main Menu. Press **Options** and then the **PC & Printer** icon.

3. Select the data to send to the memory stick and press **OK**.

Note: The number in parenthesis is the total number of data sets assigned to this selection.

To send measurement data to a PC:

The optional HACH Data Trans software must be installed on the PC, see section 5.2.6.3 on page 33.

5.3.1.4 Delete stored data from the data log

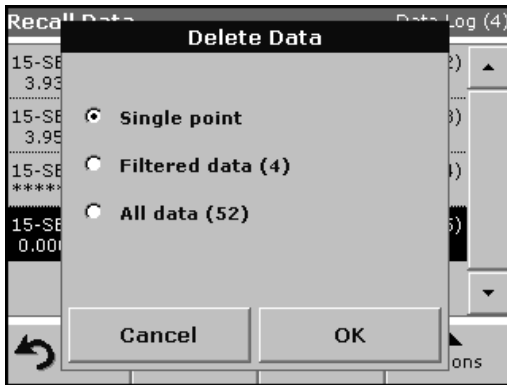

1. Press **Recall Data** in the Main Menu.
2. Press **Data Log>Options>Delete**.
3. Highlight **Single Point** or **Filtered data** or **All data** and press **OK** to confirm.

Note: The number in parentheses is the total number of data sets assigned to this selection.

Standard Operations

5.3.2 Time Course

The instrument can store 20 Time Course Data sets. The data can be stored manually at the user's discretion after viewing the data.

5.3.2.1 Data Storage from Time Course

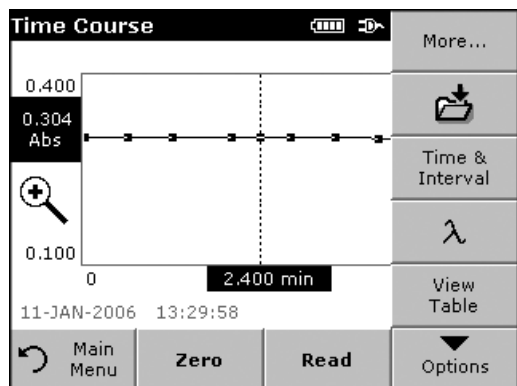

1. Press the **Store icon** in the "Options" menu from Time Course mode after a reading is taken.

Store Data Time Course

09-DEC-05 14:22:01	Run 1	560 nm	5 min	
04-JAN-06 09:52:47	Run 2	560 nm	5 min	WW-05 AAA
10-JAN-06 13:36:58	Run 3	560 nm	5 min	WW-13 AAA
10-JAN-06 11:01:07	Run 4	560 nm	5 min	WW-13 AAA
	Run 5			

Cancel Store

The Store Data list opens.

2. Press **Store** to save the current scan to the highlighted numbered line. A run can also be overwritten.

5.3.2.2 Recall Stored Data from Time Course

Recall Data Time Course

09-DEC-05 14:22:01	Run 1	560 nm	5 min	
04-JAN-06 09:52:47	Run 2	560 nm	5 min	WW-05 AAA
10-JAN-06 13:36:58	Run 3	560 nm	5 min	WW-13 AAA
10-JAN-06 11:01:07	Run 4	560 nm	5 min	WW-13 AAA
11-JAN-06 13:26:41	Run 5	560 nm	5 min	

Main Menu Table Graph Options

1. Press **Recall Data** in the "Main Menu".
 - a. Select **Time Course** to call up the required data.
 - b. If you are already working in this program, press **Options, More...** and then **Recall Data**.

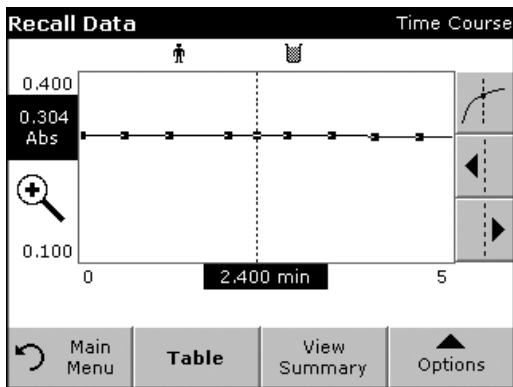

2. Press **Graph** to look at details.

*Note: Press **View Summary** to return to the Recall Data list.*

min	Abs	Mark	min	Abs	Mark
0.000	0.306	Mark	0.200	0.305	
0.400	0.305		0.600	0.304	Mark
0.800	0.304		1.000	0.304	
1.200	0.304	Mark	1.400	0.304	
1.600	0.304		1.800	0.304	
2.000	0.304	Mark	2.200	0.304	

3. Press **Table** to look at details.

*Note: Press **View Summary** to return to the Recall Data list.*

5.3.2.3 Send Data from Time Course

Date	Time	Wavelength	Duration	Options
09-DEC-05	14:22:01	560 nm	5 min	Print
04-JAN-06	09:52:47	560 nm	5 min	Print
10-JAN-06	13:36:58	560 nm	5 min	Print
10-JAN-06	11:01:07	560 nm	5 min	Delete
11-JAN-06	13:26:41	560 nm	5 min	Print

Option 1:

4. Press **Recall Data** in the "Main Menu" and then **Time Course** to send the data to a USB memory stick or to a printer.

The files will be automatically send as CSV files (Comma Separated Value) to a file "TCData" (Time Course Data).

The file name will be formatted as: "TCData_X.csv"
X = number of scans (1–20)

For further processing use a spreadsheet program.

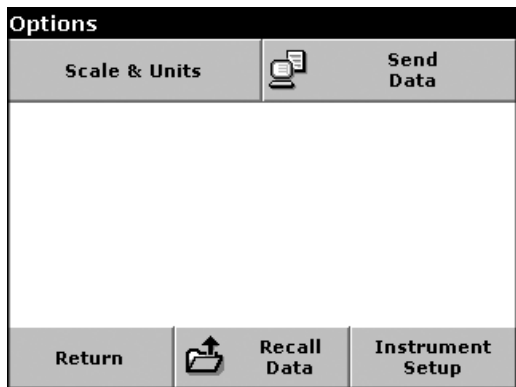

Option 2:

5. Press **Time Course** and then **Options, More...** and **Send Data** to send the data to a USB memory stick or to a printer.

The files will be automatically send as CSV files (Comma Separated Value) to a file "TCData" (Time Course Data).

The file name will be formatted as:
 "TCYear_Month_Day_Hour_Minute_Second.CSV" (Time Course Data)

For further processing use a spreadsheet program.

5.3.2.4 Delete Stored Data from Time Course

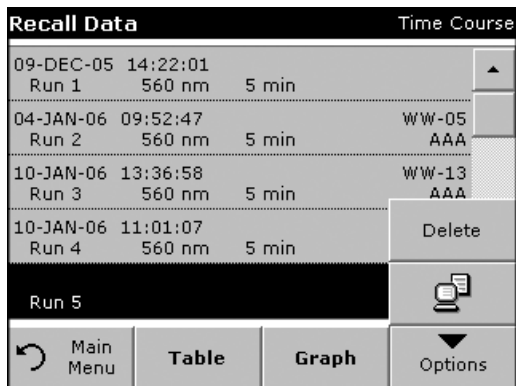

1. Press **Recall Data** from the "Main Menu" and then **Time Course** or "Options" menu, **More...**, **Recall Data**:

A listing of the stored data is displayed.

2. Highlight any data you want to delete.
3. Press **Delete** in the "Options" menu and confirm with **OK**.

5.4 Stored Programs

The instrument contains more than 200 programmed procedures. They can be accessed through the **Stored Programs** menu.

5.4.1 Select a saved test/method; enter user-specific basic data

Stored Programs		
10	Aluminum Alumin.	0.800 mg/L
9	Aluminum ECR	0.250 mg/L
20	Barium	100 mg/L
771	Beer color	60.0 units
30	Benzotriazole	16.0 mg/L
40	Boron	14.0 mg/L
45	Boron LR	1.50 mg/L
50	Bromine	4.50 mg/L
55	Bromine AV	4.50 mg/L
395	CD 2	6.00 g/l

Main Menu
 Select by Number
 Program Options
 Start

1. Press **Stored Programs** in the Main Menu to view an alphabetical list of stored programs with program numbers.

The Stored Programs list will appear.

2. Highlight the required test.

*Note: Select the program number by name or use the arrow keys to scroll through the list quickly and highlight the program or press **Select by number** to search for a specific program number. Use the alphanumeric keypad to enter the test number and press **OK**.*

3. Press **Start** to run the program. After a program is selected, the screen for that parameter will appear.

Note: All corresponding data (wavelength, factors and constants) are already preset.

4. Follow the chemical procedures described in the corresponding Procedures Manual.

5.4.2 Stored program options

1. From the Main Menu, select **Stored Programs**. Select the necessary method and press **Start**.
2. Press **Options** for Parameter Setup. Refer to Table 4 for stored program descriptions.

10 Aluminum Alumin.			
mg/L Al ³⁺			More...
			Store: On
			Abs %Trans
11-JAN-2006 13:19:59			
Main Menu	Zero	Read	Options

Options			
Send Data	Dilution Factor: Off		
Standard Additions	Standard Adjust: Off		
Chemical Form: Al³⁺	Reagent Blank: Off		
Save as User Program			
Return	Recall Data	Instrument Setup	

Table 4 Stored programs options

Options	Description
More	For further Options

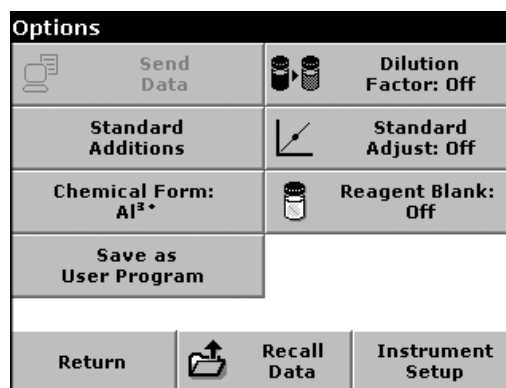
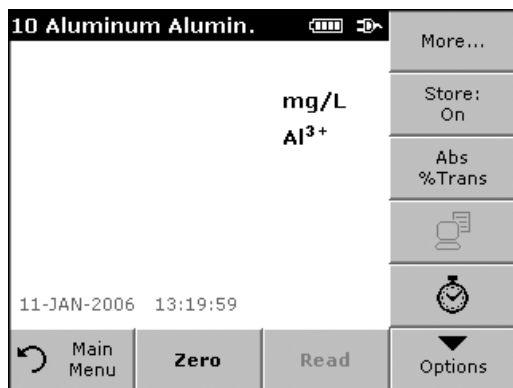

Table 4 Stored programs options (continued)

Options	Description
Store Off/On	With the Store On setting, all measurement data are stored automatically. With the Store Off setting, no measurement data are stored.
% Trans/Conc/Abs	To switch to % transmittance, concentration or absorbance readings
Send Data icon / Send Data	To send Data to a printer, computer or USB memory stick (Type A)
Timer icon	This functions as a stopwatch. It helps to ensure that the steps of an analysis are correctly timed (e.g. reaction times, wait times, etc., can be exactly specified). When the specified time has elapsed, an acoustic signal is emitted. The use of the timer has no influence on the measurement program.
Dilution Factor Off/On	A corrective dilution factor can be entered in order to take account of certain properties. The number entered at the dilution factor prompt will be multiplied by the result to compensate for the adjustment. For example, if the sample has been diluted by a factor of 2, enter 2. The default setting of the dilution factor is turned off. Note: <i>When a dilution is in effect, the dilution icon will appear on the display.</i>
Standard Addition	This enables the accuracy of the measurements to be checked. The (working) procedure for a test parameter contains a detailed explanation of how to use this function.
Standard Adjust	The (working) procedure for a test parameter indicates whether a standard adjustment is necessary and, if so, how to proceed.
Chemical Form	Some of the stored tests/methods allow to select the chemical form and the measuring range.
Reagent Blank	Some of the stored tests/methods include the "Reagent Blank" function. This enables the reagent blank value to be added to or subtracted from, the subsequent readings. The reagent blank value shifts the calibration curve along the y-axis, without changing the shape or gradient of the curve. The effect corresponds to a y-axis intercept of the calibration straight line. This is made clear by the following equation: $\text{Concentration} = [(\text{Conc. factor}) * \text{Abs}] - (\text{reagent blank value})$.
Save as User Program	To store the selected parameters as a User Program, see section 6.1 on page 61.
Recall Data	Call up saved measurement data or time courses, see section 5.3 on page 37.
Instrument Setup	Basic data of the instrument, see section 5.2 on page 27.

5.4.3 Use of program timers

Some procedures do not require the use of timers. Other procedures require several timers. These timers are pre-programmed into each **Stored Program**, along with a description of the activity to be performed during the timed period.



1. Press the **Timer** icon on the display.
2. Press **OK** to start the first timer.

The timer will count down on the screen.

3. To start the next timed activity for the Stored Program, press the Timer icon and **OK**.

Note: Press **Close** to view the measurement screen while the timer is running. The time will be shown left side bottom instead of the date.

Note: Press **Cancel** to stop the timer midway through the countdown.

Note: The Timer will beep when the end of the running time is reached.



A general purpose timer is also available in many programs. When the timer icon is visible, press the icon and select General Timer. A new screen will appear. Enter the length of the timed interval and press OK to start the timer. The timer will beep when the timed interval ends.

5.4.4 Set the dilution factor

The Dilution Factor function is used to calculate the original concentration of a sample that has been diluted by a known ratio. For example, dilution factor can bring the analyzed concentration within the test range.



1. Press **Options>More...>Dilution Factor**.

The number entered at the dilution factor prompt will be multiplied by the result to compensate for the adjustment.

For example, if the sample has been diluted by a factor of 2, enter 2. The default setting of the dilution factor is turned off.

2. Press **OK** to confirm. Press again **OK**.



3. Press **Return** to return to the result display.

4. Confirm 'Store present reading again?' to save the current measured value if necessary.

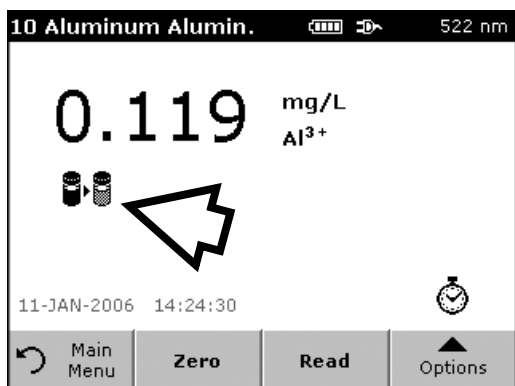

Note: When a dilution is in effect, the dilution icon will appear on the display.

Note: If using undiluted samples, set the dilution factor off again.

5.4.5 Run a standard adjust

The Standard Adjust function allows the calibration curve for a stored program to be adjusted based on analysis of a known standard solution. The Accuracy Check section of written procedures often suggests a standard solution concentration for this purpose.

Read a standard before setting Standard Adjust to On.

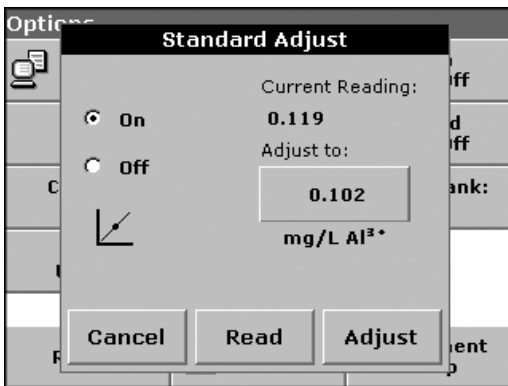

1. Follow the entire procedure, using a known standard for the sample.
2. After reading the concentration, press **Options>More>Standard Adjust**.
3. If Standard Adjust is set to **Off**, turn it **On**.

The Current Reading will show the concentration. The box on the right will show the default standard value for the test, as mentioned in the procedure.

4. If the measurement used a standard concentration that is different from the one displayed in the box, press the box on the right to enter a different standard value and enter the new value. Press **OK** to confirm.

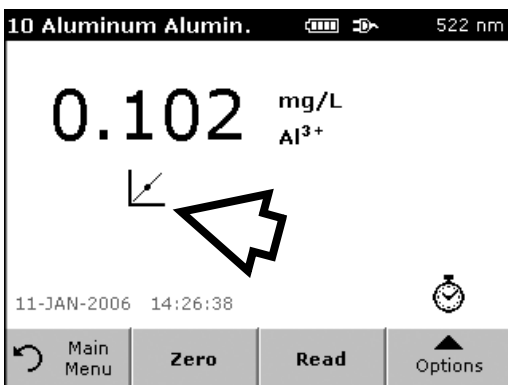

5. Press **Adjust** to enable the Standard Adjust. The Standard Adjust icon will appear.

Note: The adjustment must be within certain limits, which vary with each program. The allowable percentage is shown after "Adjustment".

Note: When a Standard Adjust is in effect, the Standard Adjust icon will appear on the display.

5.4.6 Set the chemical form

Some Stored Programs allow a variety of chemical forms to be selected.

Press the unit (e.g. mg/L) or the chemical representation of the evaluation form (e.g. Al³⁺). A list of available evaluation forms is displayed. Select the required form by pressing the corresponding entry in the list.

Note: When the program is exited, the evaluation form reverts to the standard setting.

An alternative way of changing the standard setting:

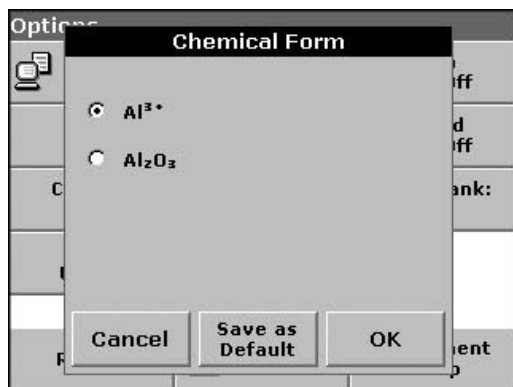

1. Press **Options>More>Chemical Form**.
2. Select the Chemical Form.

Note: The stoichiometric conversion of the measurement result is carried out automatically.

Note: The selected Chemical Form will appear on the display. Test results will be calculated and displayed in this chemical form.

5.4.6.1 Change of the default setting of the chemical form

1. Insert the sample cuvette or blank (depending on the working procedure) into the cell compartment.
2. In the result display, press **Options>More>Chemical Form**.
3. A list of available evaluation forms appears. Select the new default setting.
4. Press **Save as Default**.

The current result and all further measurements will be displayed in the new chemical form.

5.4.7 Run a reagent blank

Some of the stored tests/methods include the "Reagent Blank" function. This enables the reagent blank value to be measured and then taken into account in calculating the measurement result.

Measurement/analysis of a reagent blank:

1. Prepare the test/method in accordance with the (working) procedure. Instead of a sample, deionized water is used to determine the reagent blank value.
2. Select the test. If required by the (working) procedure, insert the cell with deionized water into the cell compartment. Press **Zero**.
3. Insert the prepared sample cell into the cell compartment. Press **Read**. The result is displayed.

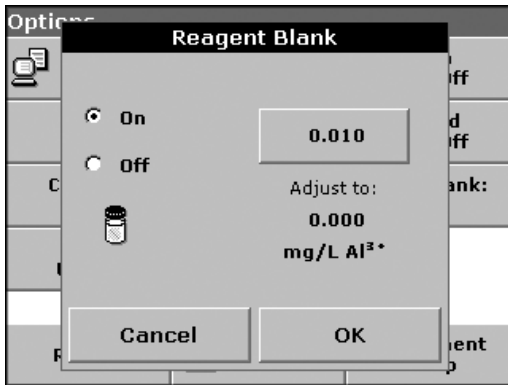

4. Press **Options>More>Reagent Blank**.
5. Press **On** to highlight the Reagent Blank function.
6. The concentration shown on the key is the measured value of the reagent blank. To use this value for more analyses of this parameter, press **OK**.
7. To enter a previously recorded reagent blank value, press the key and use the alphanumeric keypad.
8. Press **OK**.

Note: The Reagent Blank function is deactivated when the measurement program is left. To use the same blank value later for other tests using the same reagent lot, enter the value per step 7.

Note: The results calculated using the reagent blank value must lie within the limits of the measuring range of the test/method.

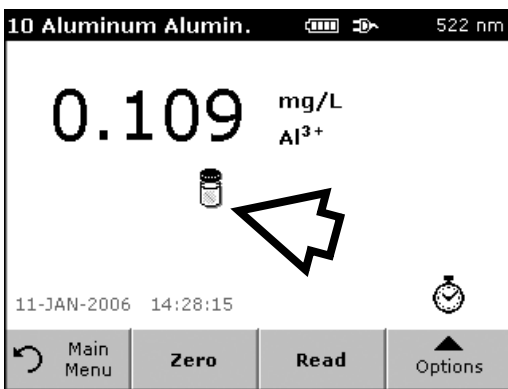

Note: The reagent blank icon is shown in the result display (see arrow) when the function is active.

5.4.8 Analysis of samples

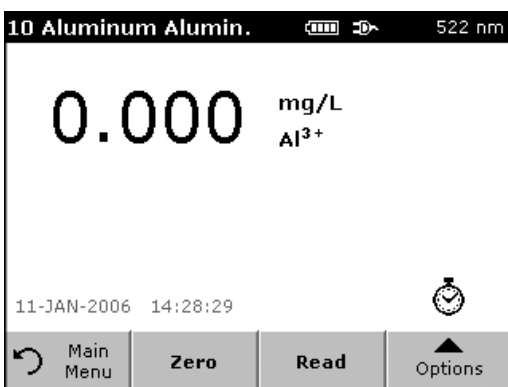

1. Press **Stored Programs** and select a program.
2. Insert the blank cuvette/cell into the cuvette/sample cell holder.
3. Press **Zero**.

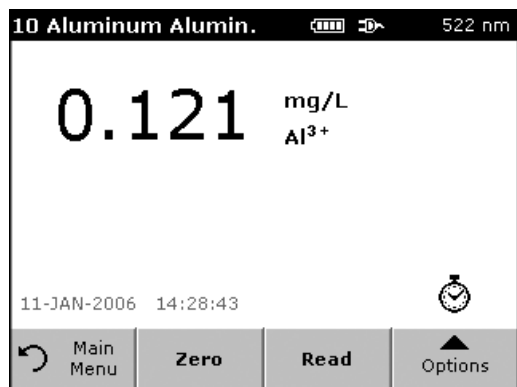

4. Remove zero solution and insert sample cuvette/cell into the cell compartment.
5. Press **Read**. The result will be displayed.
6. For data storage, see section 5.3.1 on page 37.

5.4.9 Add stored programs to the favorite programs list

The Favorites menu simplifies test selection by creating a list of the most frequently used tests from the Stored Programs and User Programs.



1. Press **Stored Programs** in the Main Menu. The Stored Programs list will appear.
2. Highlight the selection by pressing it or **Select by Number** to search for the program by number.
3. Press **Add to Favorites** and press **OK** to confirm.

The program can now be selected from **Favorite Programs** menu in the Main Menu.

5.5 Barcode Programs

A special barcode reader in cell compartment #1 automatically reads the barcode on the 13 mm cuvette/vial as the cuvette/vial completes a single rotation. The instrument uses the barcode identification to automatically set the correct wavelength for the analysis and calculates the result immediately with the help of the stored factors.

In addition, measured values are recorded at 10 different positions during a rotation. A special outlier-elimination program is run and then the average of the measured values is calculated. Cuvette/vial errors and soiling are recognized and highly precise results are obtained.



Figure 11 Cell compartment #1 for barcode 13 mm cuvettes/vials

5.5.1 Complete a barcode 13 mm test/vial

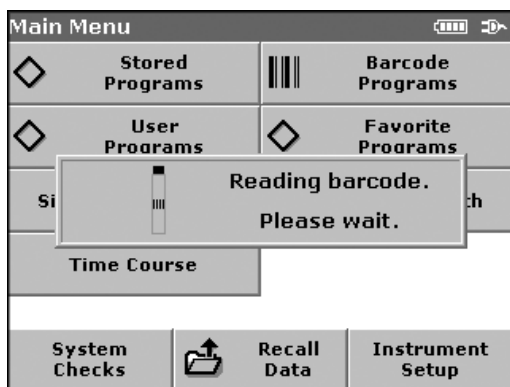

1. Insert the light shield in cell compartment #2.
2. Prepare the barcode 13 mm cuvette/vial in accordance with the working procedure and insert the cuvette/vial in cell compartment #1.
 - When a coded cuvette/vial is placed in cell compartment #1 (Figure 11), the corresponding measurement program is automatically activated in the Main Menu.



- Otherwise, press **Barcode Programs** in the Main Menu. and insert the blank or sample cuvette/vial (depending on the working procedure) in cell compartment #1.

The measurement is started automatically and the results are displayed.

To evaluate other cuvette/vial tests and other parameters, insert the prepared cuvette/vial into the cell compartment and read the result.

5.5.2 Select the measuring range

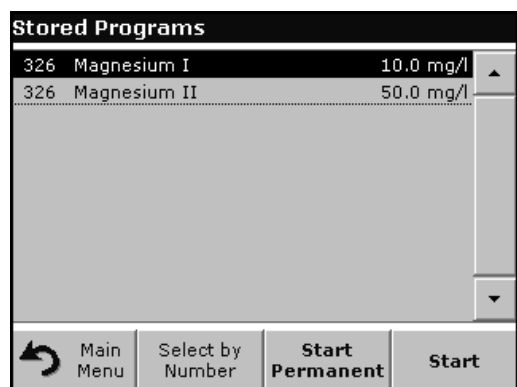

Some tests can be used for different measuring ranges. After the sample cuvette/vial has been inserted, a list of the different measuring ranges is displayed.

Select the required measuring range by highlighting the appropriate line.

Press **Start Permanent** if this measuring range is to apply to all subsequent measurements.

Changing the standard setting

In the result display, press **Options>More>Permanent: On**. The key will change to **Permanent: Off**.

5.5.3 Select the chemical evaluation form

The chemical form of the test result of a number of parameters can be selected individually.

In the result display, press the unit (e.g. mg/L) or the chemical representation of the evaluation form (e.g. $\text{PO}_4^{3-}\text{-P}$). A list of possible evaluation forms is displayed, from which the required form can be selected. Press **OK** to confirm.

Another way of changing the standard setting is:

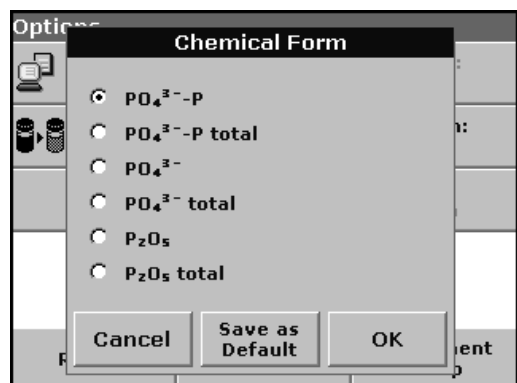

1. In the result display, press **Options>More>Chemical Form**.

A list of available evaluation forms appears.

2. Select the required chemical form and press **OK** to confirm.

Note: The selected chemical form is displayed, but does not become the default. To change the default, see section 5.5.3.1.

5.5.3.1 Change of the default setting of the chemical form

1. Insert the blank or sample cuvette/cell (depending on the working procedure) into the cell compartment.
2. In the result display, press **Options>More>Chemical Form**.
3. A list of available evaluation forms appear. Select the new default setting.
4. Press **Save as Default**.

The current result and all further measurements will be displayed in the new chemical form.

5.5.4 Basic test-specific and sample-specific data settings

Press **Options** to change test or sample specific settings.

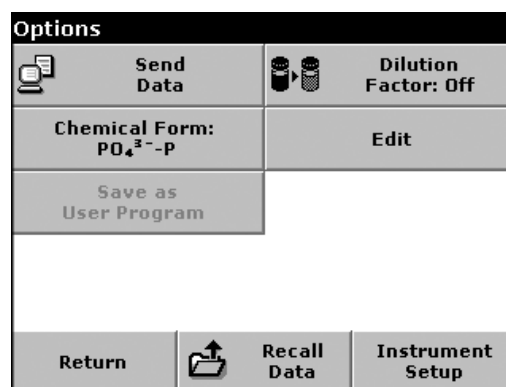
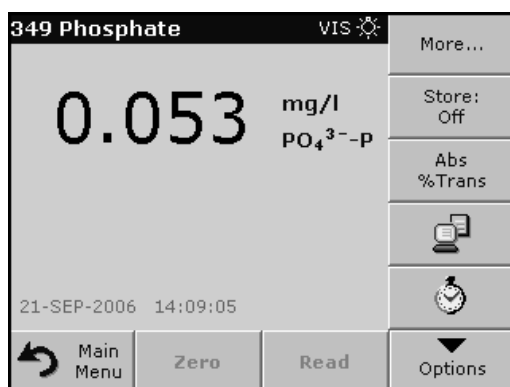

Table 5 Barcode program options

Options	Description
More	For further Options
Store Off/On	With the Store On setting, all measurement data are stored automatically. With the Store Off setting, no measurement data are stored.
Abs % Trans	To switch to % transmittance or absorbance readings
Send Data icon / Send Data	To send data to a printer, computer or USB memory stick (Type A)
Timer icon	This functions as a stopwatch. It helps to ensure that the steps of an analysis are correctly timed (e.g. reaction times, wait times, etc., can be exactly specified). When the specified time has elapsed, an acoustic signal is emitted. The use of the timer has no influence on the measurement program.
Dilution Factor Off/On	A corrective dilution factor can be entered in order to take account of certain properties. The number entered at the dilution factor prompt will be multiplied by the result to compensate for the adjustment. For example, if the sample has been diluted by a factor of 2, enter 2. The default setting of the dilution factor is turned off. Note: When a dilution is in effect, the dilution icon will appear on the display. Note: If undiluted samples are used, set the dilution factor off.
Chemical Form	Some of the stored tests/methods allow to select the chemical form and the measuring range.
Edit	To modify an existing program

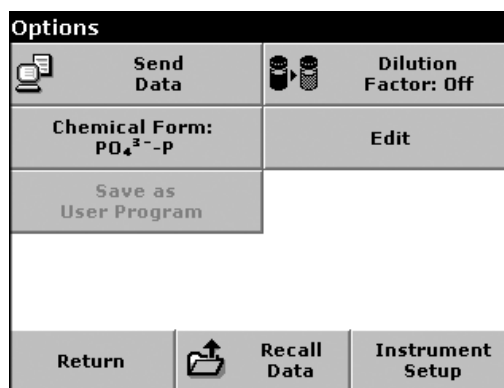
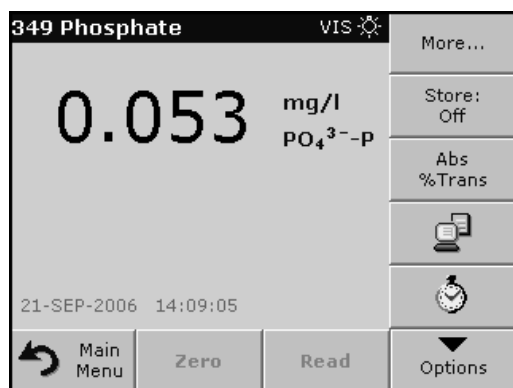
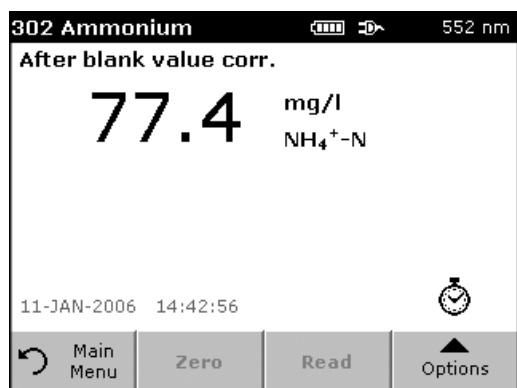

Table 5 Barcode program options (continued)

Options	Description
Save as User Program	To store the selected parameters as a User Program, see section 6.1 on page 61.
Recall Data	Call up saved measurement data or time courses, see section 5.3 on page 37.
Instrument Setup	Basic data of the instrument, see section 5.2 on page 27.

5.5.5 Sample blank



Turbidity and color in the sample matrix can falsify the results of a photometric analysis. The interference factors come from the sample or are created by reactions with the reagents.

The influence of turbidity and/or color can be eliminated or reduced by taking a sample blank reading.

In the barcode mode, a special cuvette/vial (TNT919) containing the sample blank is placed in cell compartment #1 after the sample reading has been taken and is automatically measured. The sample reading is then corrected by adding or subtracting the blank value. The final result is displayed, with the message "After blank value corr."

Some barcode tests do not require a sample blank value to be determined, as turbidity and color are dealt with during the test procedure. Other barcode tests use the reagent test vials to determine the sample blank. Please refer to the Hach procedure for method-specific instructions.

5.5.6 Update/edit barcode tests

5.5.6.1 Manual update of a barcode test

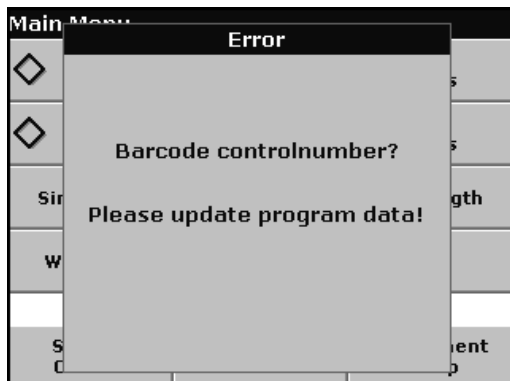

Using the data provided in the barcode, the instrument automatically sets the measurement wavelength and factors. If a discrepancy is detected between the barcode data and the stored data or a new test is identified, the instrument requests an update.

Data types are described in Table 6.

Table 6 Program update options

Program point	Description
Name	Name of the analysis parameter
Version	An abbreviation assigned by the user or the version number, etc. is entered here
Measurement process	Exact definition of the test: the number of wavelengths at which measurements are carried out, the number of absorbance measurements needed, the keys to be used, any waiting periods between measurements, etc.
Formula	Definition of the evaluation formulas with which the test result is calculated
Variables	The number of variables shown in the display depends on the definition of the measurement process and the formulas. Input of the numerical values of the wavelengths, factors, constants, etc.
Timer 1, Timer 2, Timer 3, Timer 4	This function can be used to enter abbreviations and defined times for up to four timers. Highlight the appropriate line and press Edit . The timers are activated or deactivated with the control boxes on the left of the display. In the next column, a selection can be made from a list of names that describe the corresponding work step. In the third column, the times for each active timer are entered.

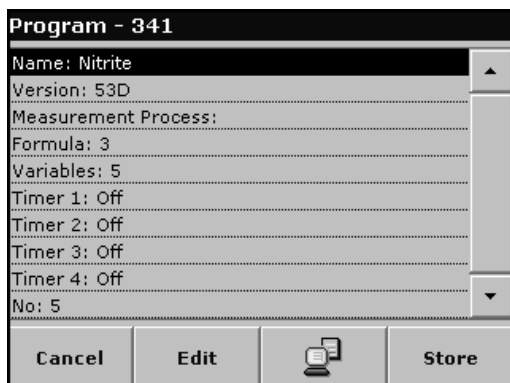

Enter the Name

Check the working procedure in advance to determine whether this point needs to be changed.

1. Highlight the line containing **Name** and press **Edit**. Use the alphanumeric keypad to enter the name indicated in the working procedure.
2. Press **OK** to confirm.

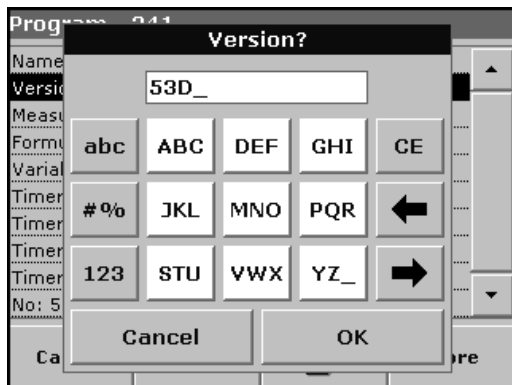

Enter the Version

1. Highlight the line containing **Version** and press **Edit**. Use the alphanumeric keypad to enter the name indicated in the working procedure.
2. Press **OK** to confirm.

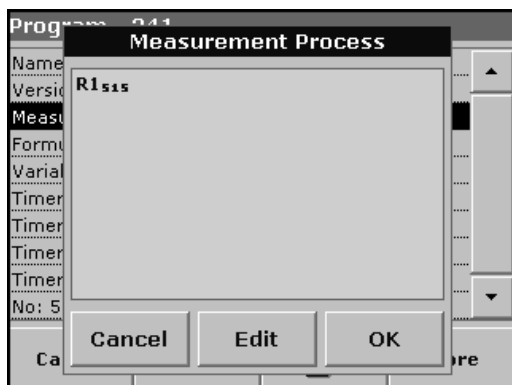

Enter the Measurement Process

For detailed information on entering the measurement process, see section 6.1.2 on page 72.

Check the working procedure in advance to determine whether this point needs to be changed.

1. Highlight the **Measurement Process** line in the data overview and press **Edit**.
2. Press **Edit**, select the sequence to be edited and press **Delete**.
3. Press **New** and use the alphanumeric keypad to enter the process indicated in the working procedure.

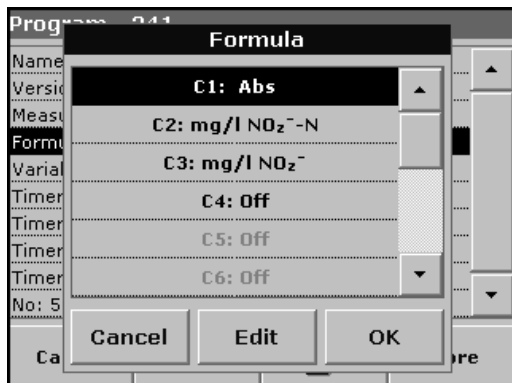

Enter the Formula, Concentration Units, Designation, Measuring Ranges

For detailed information on entering the Formula, see section 6.1.2 on page 72.

Check the working procedure in advance to determine whether this information needs to be changed.

1. Highlight the **Formula** line in the data overview and press **Edit**.
2. Select the formula, press **Edit** and use the alphanumeric keypad to enter the data specified in the working procedure (for C1=, C2=, units, name, measuring range limits, etc.).

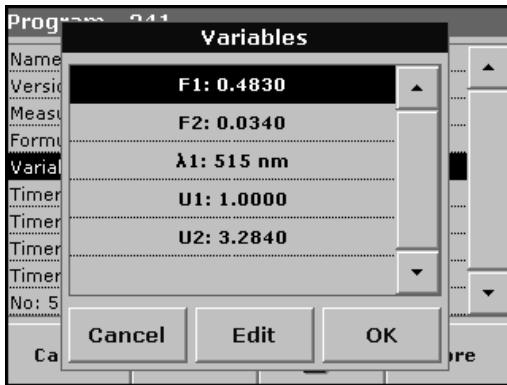

Enter the Variables (Factors, Wavelength and Conversion Factors)

For detailed information on entering the Variables, see section 6.1.2 on page 72.

Check the working procedure in advance to determine whether this point needs to be changed.

1. Highlight the **Variables** line in the data overview and press **Edit**.
2. Select the variable, press **Edit** and use the alphanumeric keypad to enter the data specified in the working procedure (for F1, F2, λ 1, U1 etc.). Confirm each entry with **OK**.

Abbreviation of Variables:

F1: Factor 1

F2: Factor 2

λ 1: Wavelength 1

U1: Conversion Factor 1 for the first chemical form

U2: Conversion Factor 2 for additional chemical forms etc.



Timer 1, Timer 2, Timer 3 and Timer 4:

The timers are activated or deactivated with the control boxes on the left of the display. In the next column, a selection can be made from a list of names that describe the corresponding work step. In the third column, the times for each active timer are entered.

5.5.6.2 Update an existing barcode test

Note: Only in very few cases does the revision of a test require all test specifications to be updated.



Program - 341			
Name: Nitrite			
Version: 53D			
Measurement Process:			
Formula: 3			
Variables: 5			
Timer 1: Off			
Timer 2: Off			
Timer 3: Off			
Timer 4: Off			
No: 5			
Cancel	Edit		Store

Option 1: Manual update of test data

1. Insert the light shield in cell compartment #2.
2. The instrument needs to be at the Main Menu or press **Barcode Programs** in the Main Menu.
3. Insert the blank or sample cuvette/vial (depending on the working procedure) in cell compartment #1.
4. After "Barcode controlnumber?", a data overview is displayed, including the specifications of the test that is to be revised.

Note: The working procedures of the corresponding test contains the new data (Wavelength, Factors, Measurement Ranges, Conversion Factor for chemical Form, etc.).

5. Highlight the corresponding line and press **Edit**.
6. When finished programming, press **Store** and then **Cancel** to return to the User Programs menu.
7. Press **Start** to begin the test with the new data.

Options			
	Send Data		Dilution Factor: Off
Chemical Form: PO ₄ ³⁻ -P		Edit	
Save as User Program			
Return		Recall Data	Instrument Setup

Option 2: Manual check/revision of test data

If an incorrect entry was made during the data update and is not recognized via the barcode of the cuvette/vial (e.g. an incorrect measuring range), another option is available for checking and if necessary revising, the test data.

1. Insert the light shield in cell compartment #2.
2. The instrument need to be at the Main Menu or press **Barcode Programs** in the Main Menu.
3. Insert the blank or sample cuvette/vial (depending on the working procedure) in cell compartment #1.
4. Press **Options>More>Edit**.
5. A data overview is displayed, including the specifications of the test that is to be revised. Compare the displayed data with the data in the working procedure and edit the displayed data in accordance with the working procedure.

5.5.6.3 Program a new test



1. The instrument needs to be at the Main Menu or press **Barcode Programs** in the Main Menu.
2. Insert the sample cuvette/vial or blank (depending on the working procedure) into the cell compartment.

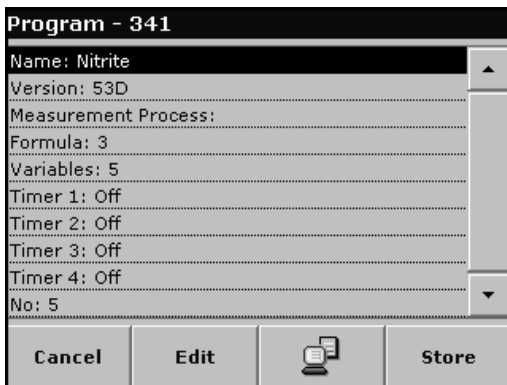

3. After "Program not available", a data overview is displayed, including the specifications of the test that is to be revised.
The working procedures of the corresponding test contains the new data (Wavelength, Factors, Measurement Ranges, Conversion Factor for chemical Form etc.).
4. Highlight the corresponding line including the specifications of the test that is to be programmed and press **Edit**.
5. To finish programming, press **Store** and then **Cancel** to return to the Main Menu.
6. Press **Start** to begin the test with the new data.

5.5.7 Upgrade of the instrument software

To obtain the software for the update from the Internet at **www.hach.com**:



1. Go to <http://www.hach.com>.
2. On the DR 2800 product page, click **Lab System Software/Software Update Downloads** under **Downloads**.
3. Locate the appropriate download and follow the prompts for saving the file(s) to the USB memory stick.
4. On the DR 2800, press **Instrument Update** in the System Checks menu.
5. Connect the USB stick to the USB interface on the DR 2800 (section 3.4 on page 13). Press **OK**. The link is established automatically and the software is updated.

6. Press **OK** to return to the System Checks menu.

***Note:** When the instrument software has been updated, a prompt to restart the instrument is displayed.*

Section 6 Advanced Operations

6.1 User Programs

User programs provide the opportunity to complete "made to measure" analysis.

The User Programs database is empty when the instrument leaves the factory and is used to accommodate programs created by users specific needs. Here are a few examples of entries:

- Programming of user-created procedures. The analysis procedure must be developed first, before it can be programmed. The user must define or determine the program sequences, calculation formulas, measurement wavelengths, factors, measuring range limits, etc.
- Modified tests
- Assignment of user programs to the favorites menu for frequently used tests.
- Creation of a specific selection of methods and tests.

Press **User Programs** in the Main Menu and then **Program Options**. The **Program Options** menu contains several input and editing options (Table 7):

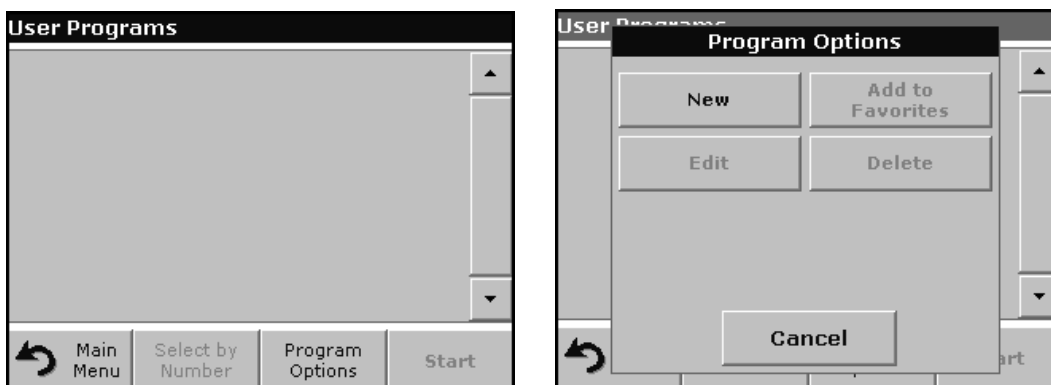

Table 7 Program options user programs

Options	Description
New	Select New to program a new user program. <i>Note: The first time Program Options is selected, only the New option is available. The other options remain inactive (grey) until the first program has been created.</i>
Add to favorites	Select Add to favorites to add an existing user program to the list of frequently used programs.
Edit	Select Edit to modify an existing program
Delete	Select Delete to remove a program from the list of user programs. The program will be simultaneously deleted from the Favorites list.

6.1.1 Program a user method

All input steps and their significance and options are explained in the following sections.

1. Select **New** in the Program Options menu.



Program Number:

Specific test number, with which the program can subsequently be called up from the selection list in the **User Programs** menu or the **Favorites** menu.

2. Use the alphanumeric keypad to enter a program number between 950 and 999. The lowest available number appears automatically.
3. Press **OK**.

*Note: If the program number is already assigned to another user program, a message appears, asking whether the existing program should be replaced. Press **OK** to overwrite the existing program.*

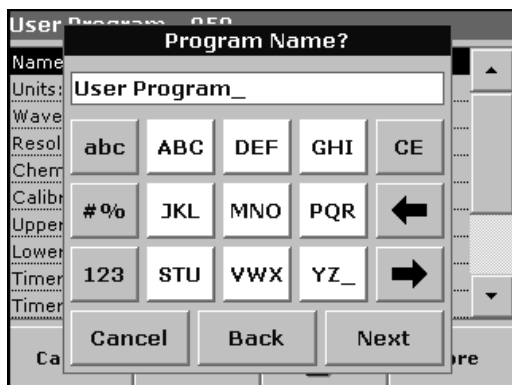

Program Name:

4. Use the alphanumeric keypad to enter a program name. The name can be a maximum of 28 characters long.
5. Press **Back** to go back to the previous program point or press **Next** to continue with the input of the program data.

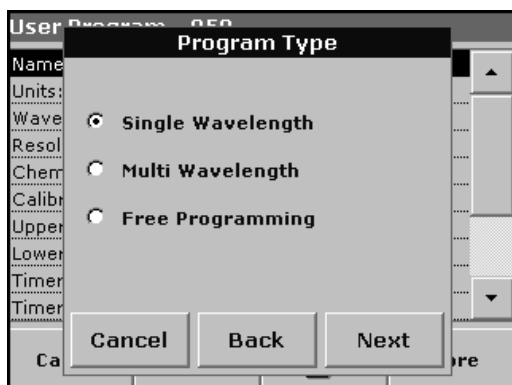

Program Type:

6. Select the required option (Table 8) and press **Next**.
7. If the Single Wavelength (section 6.1.1.1 on page 63) or Multi Wavelength (section 6.1.1.2 on page 64) is selected, define the unit, wavelength, absorbance formula, wavelength λ , concentration factor Kx, concentration resolution, chemical form and calibration equation. More information on Free Programming parameters see section 6.1.2 on page 72.

Table 8 Program descriptions

Program Type	Description
Single Wavelength	Measurements at a defined wavelength
Multi Wavelength	In the Multi Wavelength mode, absorbance values can be measured at up to four wavelengths and the results can be mathematically processed to obtain sums, differences and relationships.
Free Programming	This is an advanced form of programming for original user-developed methods. In Free Programming, the user defines the measurement process, variables and calculations involved in obtaining a reading.

6.1.1.1 Single wavelength settings

If the Single Wavelength mode is selected, the following parameters can be defined:

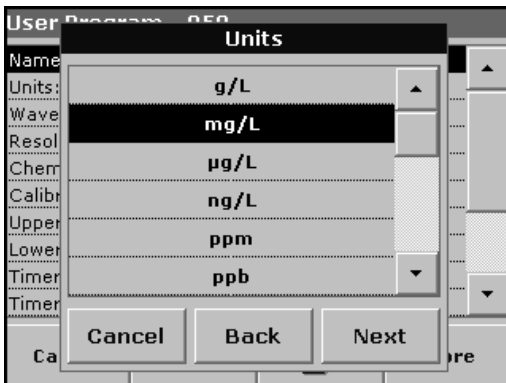

Units:

Select the required unit from the list and press **Next**.

Note: Units of measure not included in this list can be added in the edit program under **Program Options, Edit**. Select **Units, Edit** and then **New**.

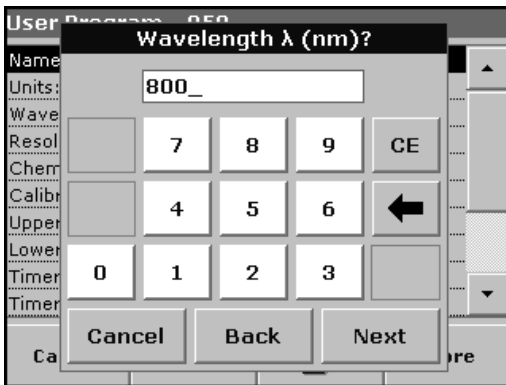

Wavelength (single wavelength program type):

Use the alphanumeric keypad to enter the measurement wavelength. The entered wavelength must be in the range from 340–900 nm.

Press **Next** to proceed.

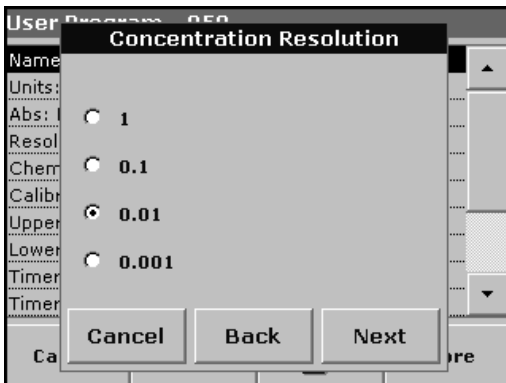

Concentration resolution (number of decimal places)

Select the required number of decimal places from the displayed list and press **Next**.

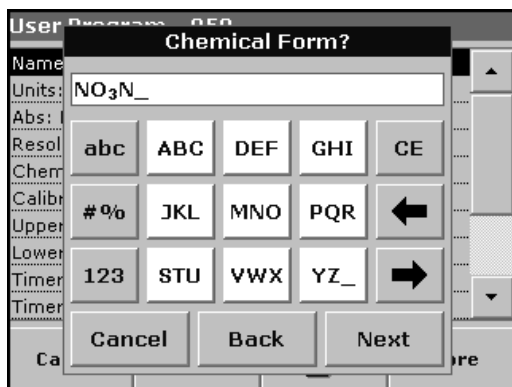

Chemical form:

Enter the chemical formula used in the display to represent the analysis parameter.

Use the alphanumeric keypad to enter the chemical form and press **Next** to enter Calibration settings.

6.1.1.2 Multi wavelength settings

If the Multi Wavelength mode is selected, the following parameters can be defined:

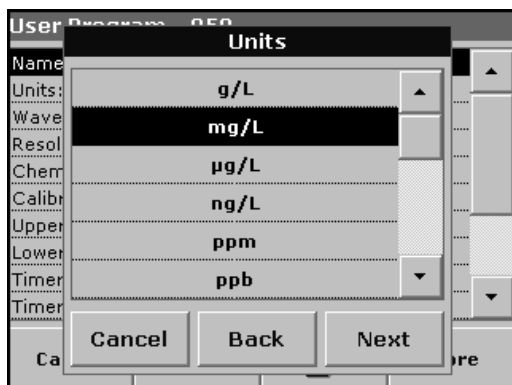

Units:

Select the required unit from the list and press **Next**.

*Note: Units of measure not included in this list can be added in the edit program under **Program Options, Edit**. Select **Units, Edit** and then **New**.*

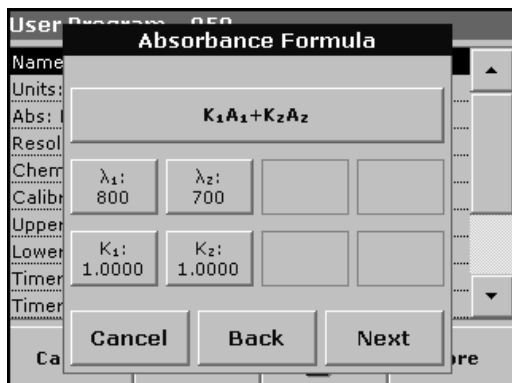

Absorbance formula (multi-wavelength program type):

The Absorbance Formula menu is used to define the wavelengths and the coefficients used in the formula. The absorbance formula defines the calculation for the multi-wavelength measurement.

Press the appropriate key to edit the input.

Press the **Formula** key.

In the displayed list, select the formula for the program and press **OK** to confirm.

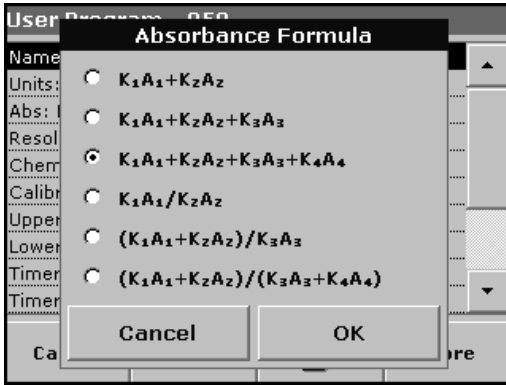

List of available absorbance formulas

A_1 is the absorbance at wavelength 1,

A_2 is the absorbance at wavelength 2 and so on

K_1 is the factor at wavelength 1,

K_2 is the factor at wavelength 2 and so on

If a subtraction has to be completed, the factors can be entered with a minus sign.

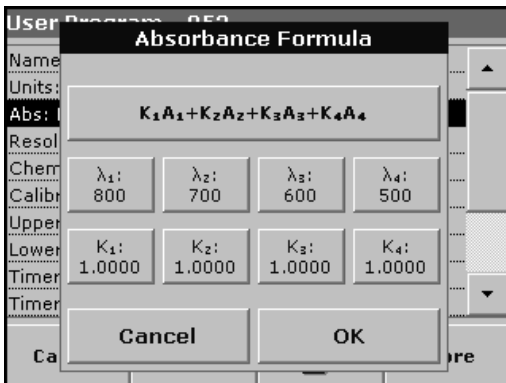

Wavelength λ_x :

Press a λ_x key and use the alphanumeric keypad to enter a wavelength. Press another λ_x key and enter the next wavelength. If necessary, repeat until all the wavelengths for the formula have been entered. The wavelengths must be in the range from 340–900 nm. Press **OK**.

Concentration Factor K_x

Multiplication factor for converting absorbance values into concentration values.

Press a factor key and use the alphanumeric keypad to enter a factor. If the formula includes more than one factor, press another factor key and enter another factor and repeat until all the factors have been entered. Press **OK**. When all the relevant data have been entered, press **Next**.

Note: Up to 5 digits can be entered, including a maximum of 4 decimal places to the right of the decimal.

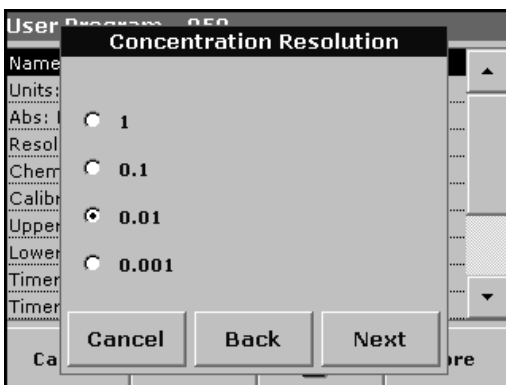

Concentration resolution (number of decimal places)

Select the required number of decimal places from the displayed list and press **Next**.

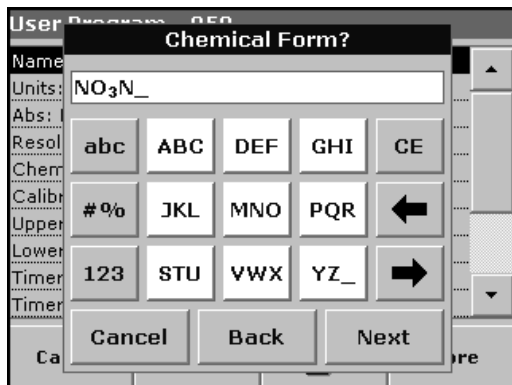

Chemical form:

Enter the chemical formula used in the display to represent the analysis parameter.

Use the alphanumeric keypad to enter the chemical form and press **Next** to enter Calibration settings.

6.1.1.3 Calibration settings for single and multi wavelength mode

A method is calibrated by determining the absorbance values of several standard solutions of known concentration.

There are three ways to create and store a calibration curve. Instructions for each method follows (Table 9).

Table 9 Calibration settings

Mode	Descriptions
Enter values	A calibration table is created by entering the concentration values and the absorbance values of the analyte solution. The absorbance values are plotted versus standard concentrations and the calibration curve is displayed as a graph (page 66).
Read Standards	A calibration table is created by entering the concentration values of the standard solutions and then measuring the absorbance of the analyte solutions. The absorbance values are plotted versus standard concentrations and the calibration curve is displayed as a graph (page 68).
Enter Formula	If the calibration curve can be determined from the mathematical relationship between concentration and absorbance by linear regression, etc., the corresponding formula can be selected (linear, 2nd or 3rd order polynomial) from a list and the appropriate factors can be entered (page 69).

Calibration by entering calibration values

Enter concentration/absorbance

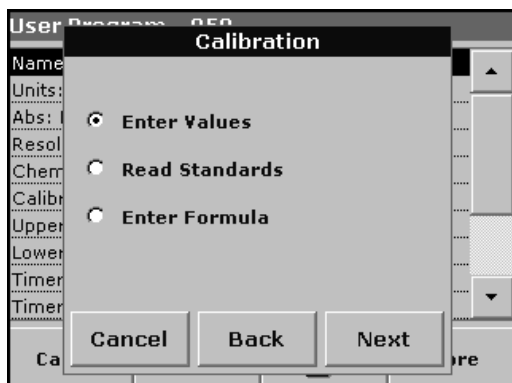

1. Select the **Enter Values** and press **Next**.

Calibration Values			
mg/L	Abs		
0.0000	0.000		
1.0000	0.200		
2.0000	0.400		
3.0000	0.600		
4.0000	0.800		
✕			
▲			
▼			
+			
Exit	mg/L	Abs	Graph

- To enter the standard concentrations and corresponding absorbance values in the displayed table, press the "+" symbol. Use the alphanumeric keypad to enter the values.

Press **OK** and enter the corresponding absorbance value. Press **OK**.

The entered data are displayed in the table. Repeat the sequence for each data point to enter it.

- To change a value in the table, highlight the appropriate line, press the unit key (e.g. **mg/L**) or **Abs** and enter the changed value via the alphanumeric keypad.

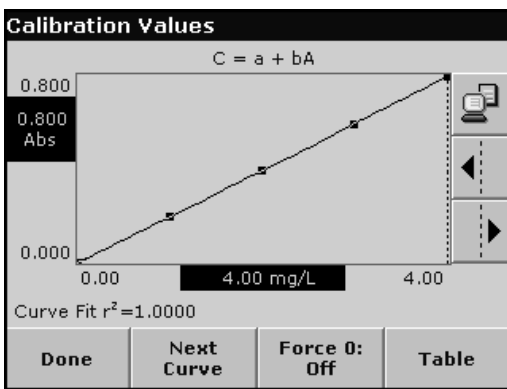

- When the data have all been entered, press **Graph**.

Note: The correlation coefficient (r^2) is shown on the left below the axes.

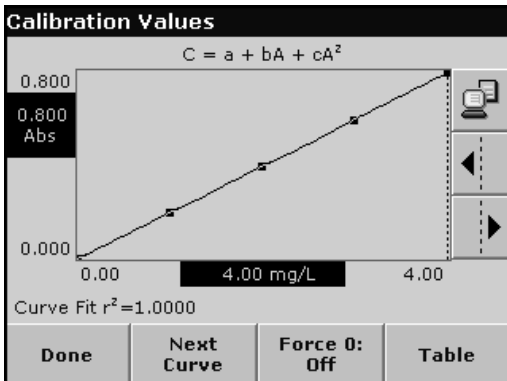

- The linear equation corresponds to the standard setting. Press **Next Curve** to display the polynomial 2nd order curve. Press **Next Curve** again, to display the polynomial 3rd order curve.

- Press **Force 0** to change the setting from **Off** to **On**. The curve now passes through the origin of the coordinate system.

Note: This may have an adverse effect on the correlation coefficient (r^2).

- Press **Table** to display the table again.

- When the table has been completed and the curve type has been chosen, press **Done** when the graph is displayed or **Exit** when the table is displayed. Go to section 6.1.1.4 on page 70.

Calibration by reading standards

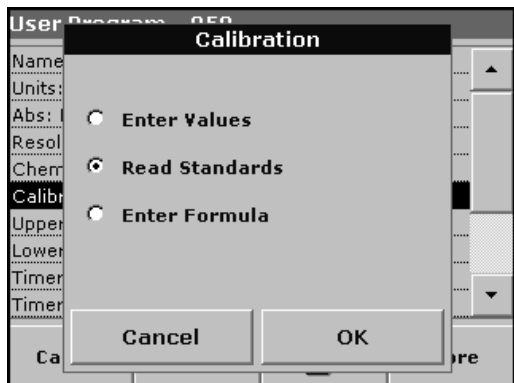

1. Press **Read Standards** and press **Next**.
2. To enter the standard concentrations in the displayed table, press the "+" symbol. Use the alphanumeric keypad to enter the standard concentration. Press **OK**.

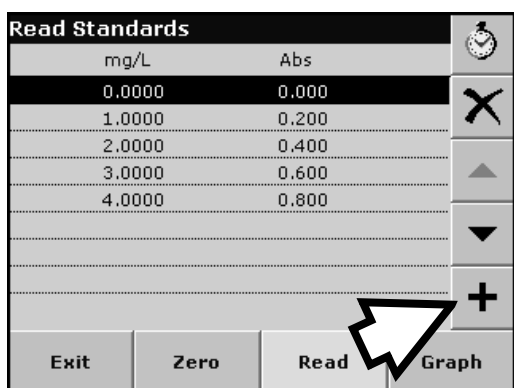

3. Press the "+" symbol again (see arrow) and enter the next standard concentration. Repeat this sequence until all standard concentrations (maximum of 24 solutions) have been entered.
4. Highlight the line with the appropriate concentration and insert the cuvette with the corresponding standard solution.
5. Insert the zero solution into the cell compartment. Press **Zero**.
6. Insert the **first** standard solution into the cell compartment. Press **Read**.

Insert the **second** standard solution into the cell compartment. Press **Read**.

Repeat this sequence until all the standard solutions have been measured (maximum of 24 solutions).

The entered and measured data are displayed in the table.

Note: To delete a standard concentration, highlight the appropriate line and press the **Delete** icon.

The timer icon shown in the display helps to ensure, when necessary, that the steps of an analysis are correctly timed (e.g. reaction times, wait times, etc., can be exactly specified). When the specified time has elapsed, an acoustic signal is emitted. The use of the timer has no influence on the measurement program.

7. When the data have all been entered and the measurements have all been completed, press **Graph**.
8. The linear curve corresponds to the standard setting. Press **Next Curve** to display the polynomial 2nd order curve. Press **Next Curve** again to display the polynomial 3rd order curve.

9. Press **Force 0** to change the setting from **Off** to **On**. The curve then passes through the origin of the coordinate system.

Note: This may have an adverse effect on the correlation coefficient (r^2).

10. Press **Table** to display the table again.
11. When the table has been completed and the curve type has been chosen, press **Done** when the graph is displayed or **Exit** when the table is displayed. Go to section 6.1.1.4 on page 70.

Calibration by entering the formula

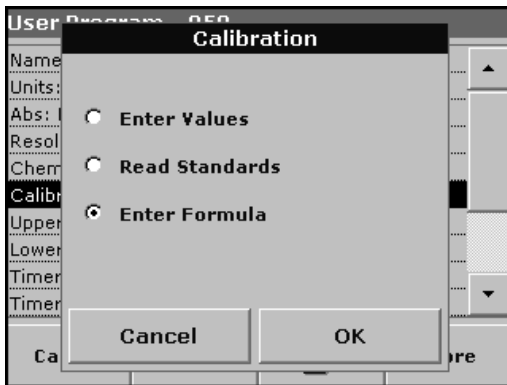

1. Press **Enter Formula** and press **Next**.

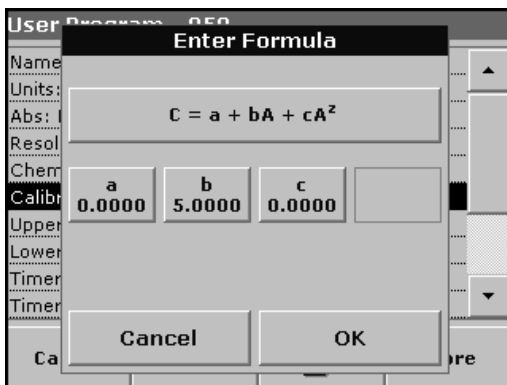

2. Press the formula key.

A list of available formulas (linear and 2nd and 3rd order polynomial) is displayed. Up to 4 coefficients can be entered, depending on the selected formula. Press the required formula.

3. Depending on the selected formula, the required coefficients (a, b, c...) are displayed. Press the coefficient keys and enter the corresponding values via the alphanumeric keypad. After each entry, press **OK** to confirm.

Note: The coefficients can have 5 digits and can have a positive or a negative sign.

Advanced Operations

6.1.1.4 Store a user program

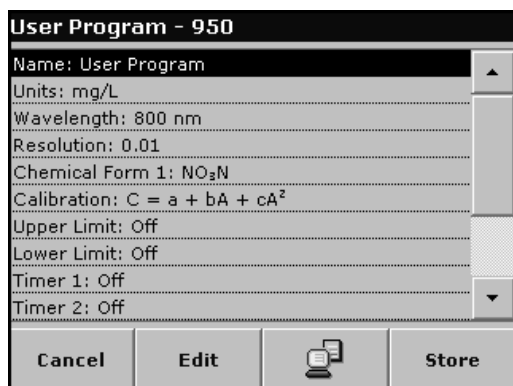

The input of the basic data is complete. An overview of the variable program data is displayed.

1. To enter more specifications or change existing ones, highlight the appropriate line and press **Edit**.
2. Select **Store** to save the user program.
3. Press the **PC & Printer** icon to send the program data to a printer or to a USB memory stick (connect the USB memory stick to the USB interface first).

Note: The test data will be formatted in the preinstalled PrgData folder as a .csv and as a .lst file.

4. To transfer the program data from one instrument to another create a new folder on the USB memory stick named **dbhlc** and copy the **.lst** files into this folder. (see section 6.7.2 on page 98).

6.1.1.5 Additional user-defined parameters and functions

In addition to the previously defined basic data, additional parameters and functions can be defined for user programs:

- measuring range upper and lower limits
- timer functions
- chemical forms



Upper and lower limits of the measuring range

It is possible to enter a maximum (upper) and minimum (lower) measurement value. An error message is displayed if a reading is above the upper limit or below the lower limit.

1. Highlight the appropriate line in the overview of the program data and press **Edit**.
2. Set **On** and press the **0.000** key to enter the measuring range limit. Confirm the entry by pressing **OK**.

**Timer 1 / Timer 2 / Timer 3 / Timer 4:**

This function can define time intervals for up to four timers. Timer designations such as Shake, Wait and Swirl can be assigned.

1. Highlight the appropriate line in the overview of the program data and press **Edit**.
2. The timers are activated or deactivated with the check boxes in the left part of the display. In the next column, a selection can be made from a list of names that designate the corresponding work step. In the third column, the times for each timer are entered (in mm:ss).

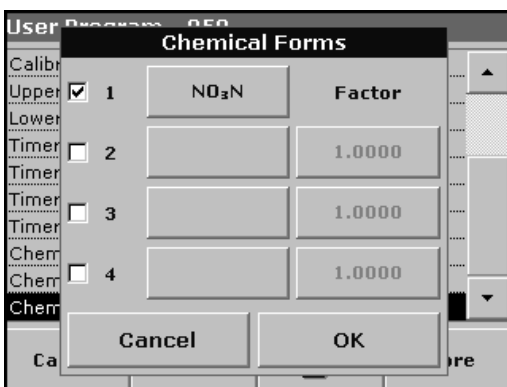
**Chemical form 2 / chemical form 3 / chemical form 4:**

If a **Chemical Form 1** has been defined, up to three additional alternative forms can be entered here.

1. Highlight the appropriate line in the overview of the program data and press **Edit**.
2. The chemical forms are activated or deactivated with the check boxes in the left part of the display.
3. Press the left key to enter another chemical form with the alphanumeric keypad and press **OK** to confirm. Press the right key to enter the conversion factor to calculate the concentration of the additional chemical form from the concentration of Chemical Form 1 and press **OK** to confirm.
4. Press Store to save the program data. Press **Cancel** to return to the Main Menu.

6.1.2 Free programming program type

Free Programming is an advanced option for entering original user-developed methods. When the Free Programming option is selected, an overview of the specifications of the programmed test is displayed. Each input option can be modified to develop the user method. Refer to Table 10 for more information. To modify an input option, select the appropriate line and press **Edit**.

Important Note: Perform steps 1–6 of Programming a New User Method (section 6.1.1 on page 61) before proceeding with Free Programming.

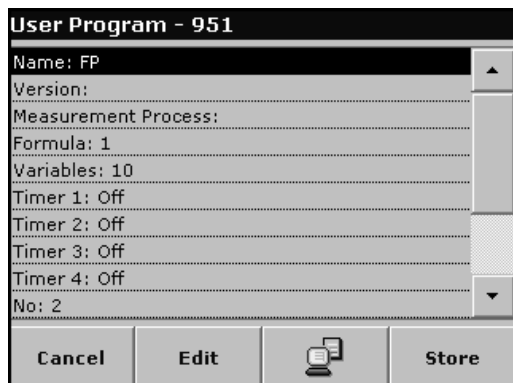

Highlight the line containing the program point that is to be edited or defined and press **Edit**.

Table 10 Definitions of the program points

Program point	Description
Name	Name of the analysis parameter
Version	An abbreviation or version number assigned by the user is entered here.
Measurement Process	Exact definition of the test: the number of wavelengths at which measurements are made, the number of absorbance measurements needed, the keys to be used, any waiting periods between measurements, etc.
Formula	Definition of the formulas with which the test result is calculated.
Variables	The number of variables shown in the display depends on the definition of the measurement process and the formulas. Input of the numerical values of the wavelengths, factors, constants, etc.
Timer 1, Timer 2, Timer 3, Timer 4	Used to enter abbreviations and defined times for up to four timers. Highlight the appropriate line and press Edit . The timers are activated or deactivated with the control boxes on the left of the display. In the next column, a selection can be made from a list of names that describe the corresponding work step. In the third column, the times for each active timer are entered.

6.1.2.1 Measurement process

The measurement process defines the handling and the measurements of the test:

- At which and how many wavelengths should measurements be completed
- How many absorbance measurements must be completed?
- When should the zero measurement and the sample measurement be completed?
- Are waiting times necessary between measurements?

- Should individual program sequences be repeated?

The elements of a measuring sequence, such as zero and sample measurements and the timer(s) (reaction times, waiting times, etc.) are individually defined.

6.1.2.2 Enter a new element of a measuring sequence

Important Note: Each component of the measurement process **must** be entered in the order in which it will be completed.



1. Highlight the **Measurement Process** line in the data overview and press **Edit**.
2. Press **Edit** again and then **New**.

Content and definition of the keys

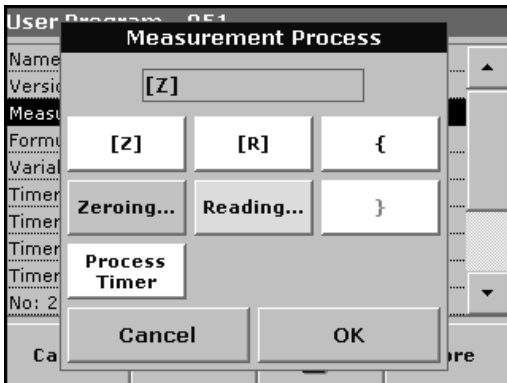

[Z] key / Zeroing

1. Press the **[Z]** key to program a zero measurement. Confirm with **OK**.
2. Press **New** and then **Zeroing...** and use the alphanumeric keypad to enter the wavelength at which the zero measurement is to be completed. Press **OK** and confirm the input by pressing **OK** again.
3. If zero measurements are to be carried out at a number of wavelengths, repeat the above two steps for each wavelength.

Note: The entered measurement sequence is displayed.



Process Timer key

1. Press the **Process Timer** key to enter any waiting, reaction or handling times that have to be taken into account. Use the alphanumeric keypad to enter the time. Press **OK** and confirm the input by pressing **OK** again.

Note: This time is integrated into the measurement process.

Note: The entered measurement sequence is displayed.

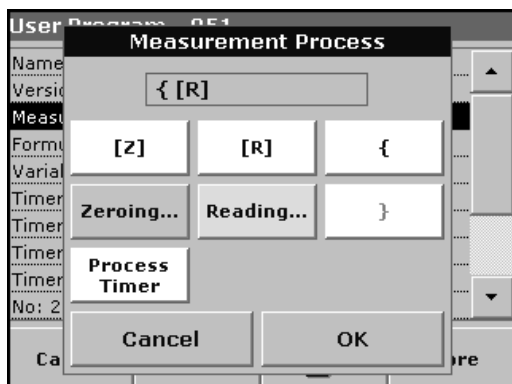

[R] key / Reading...

1. Press the **[R]** key to program a measurement of the substance that is to be analyzed. Confirm with **OK**.
2. Press **New** and then **Reading...** and use the alphanumeric keypad to enter the wavelength at which the measurement is to be completed. Press **OK** and confirm the input by pressing **OK** again.
3. If measurements are to be completed at a number of wavelengths, repeat the above two steps for each wavelength.

Note: The entered measurement sequence is displayed.

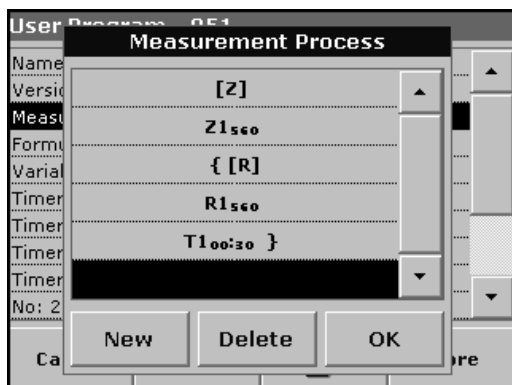

{ } key

Elements of the measurement sequence that are to be repeated are placed in brackets.

The left bracket "{" marks the start of the sequence that is to be repeated and the right bracket "}" marks the end.

Note: The key showing the right bracket remains inactive until a left bracket is entered.

1. Press {.
2. Press the key that defines the sequence that is to be repeated: **[Z]** or **[R]**. Confirm with **OK**.
3. Press **New** and then press **Zeroing...** or **Reading...** and use the alphanumeric keypad to enter the wavelength at which the measurement should be completed. Press **OK** and confirm the input by pressing **OK** again.
4. Press } to end the sequence.

Note: If an action such as a zero measurement recurs at different stages of a measurement sequence, the series of actions is numbered sequentially (e.g. Z1, Z2, etc.).

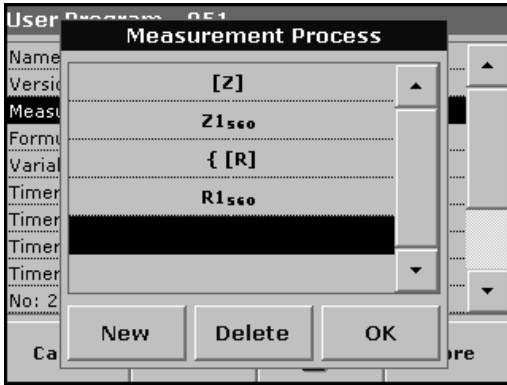

Deleting an element of a measuring sequence

Select the appropriate line and press **Delete**. The element is deleted.

Inserting an element of a measuring sequence

Select the line in the measuring sequence where the insertion is to be made and press **New**.

A new element can be entered at the selected position.

When the input is complete, press **OK** in the "Measurement Process" display. The data overview is then displayed.

6.1.2.3 Enter the calibration formula (evaluation formula)

The calibration formula (evaluation formula) defines the calculation and display of intermediate and final results. The previously defined elements of the measuring sequence are the basis for calculating the concentrations.

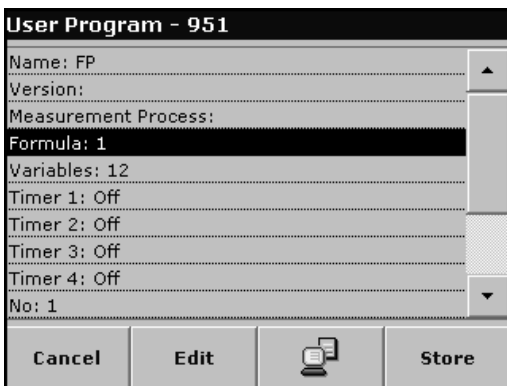

Enter calibration formula C1

1. Highlight the **Formula** line in the data overview and press **Edit**.

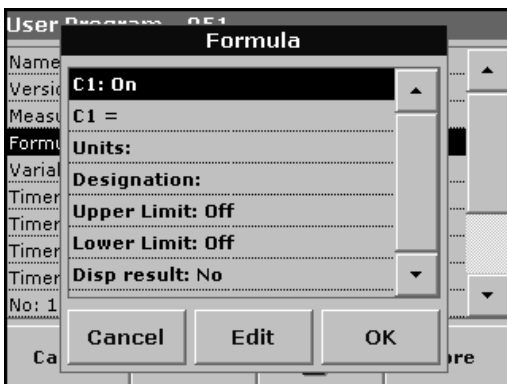

2. Highlight the line **C1: Off** and press **Edit**.

3. Select **C1: Off** again and press **Edit**. The display changes to **C1: On**.

4. Highlight the next line **C1 =** to define the formula and press **Edit**.

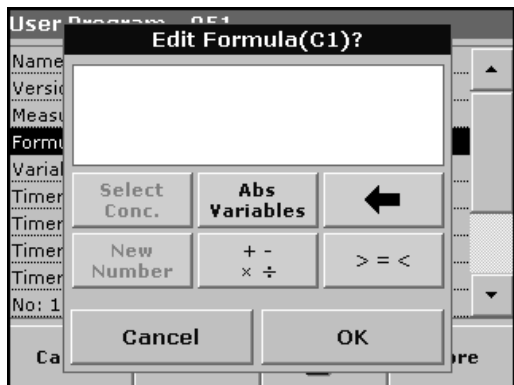

Refer to Table 11 for detailed information on the Edit formula keys.

Note: The evaluation formula is built up successively in the display in accordance with the input.

Note: The **arrow** key deletes the most recently entered element of the formula.

Table 11 Edit formula key descriptions

Screen	Key	Description
	<p>Abs/Variables</p>	<p>Press the Abs/Variables key to select, from the displayed list, the required element of the defined measuring sequence and therefore the corresponding measurement wavelength, so that this can be taken into account in the formula.</p>
	<p>New Number</p>	<p>Press New Number to enter a new factor or constant.</p>

Table 11 Edit formula key descriptions (continued)

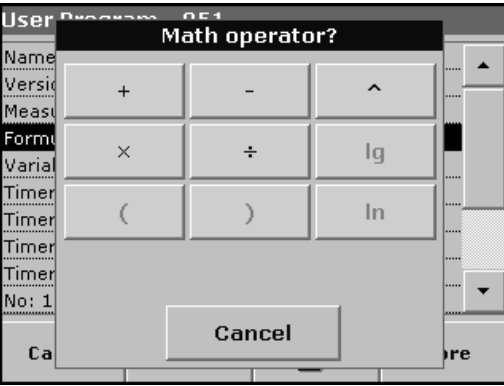
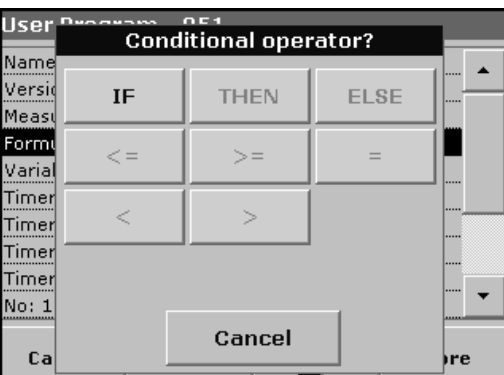
Screen	Key	Description
	<p>+ - ÷ x</p>	<p>Press + - ÷ x, to enter a mathematical operation. Select the operation and press OK to confirm. The available choice of mathematical operations depends on the defined formula. This means that functions such as "()" or "ln"/"log" etc. are only active if a term in parentheses or the calculation of a logarithm is mathematically permissible in the defined formula (this also applies to the basic mathematical operations). The following mathematical operations are available:</p> <ul style="list-style-type: none"> • + (Addition) • - (Subtraction) • ÷ (Division) • x (Multiplication) • ^ (Exponent) • Ln (Natural logarithm) • Log (Common logarithm)
	<p>>=<</p>	<p>Press >=< to include logic statements/links/conditions in the formula. The following functions are available: = (Equal to), < (Less than), > (Greater than), <= (Less than or equal to), >= (Greater than or equal to), IF, THEN, ELSE</p> <p>When the evaluation formula C1 has been entered completely, press OK to confirm. Press OK again to return to the Formula display.</p> <p>When the formula C1 has been entered and confirmed, the parameter name, upper and lower limits of the measuring range and display result (yes, no) can be entered.</p>

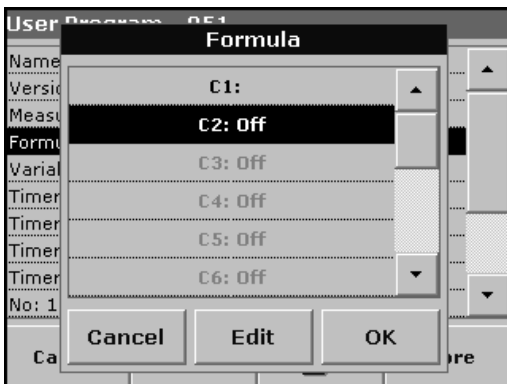

Enter the next calibration formula (C2 or Cn)

1. Highlight **C2: Off** and press **Edit**.
2. Select **C2: Off** again and press **Edit**. The display switches to **C2: On**.
3. Highlight the next line **C2 =** to define the formula and press **Edit**.

In addition to the keys described in Table 11, only one other function is available:

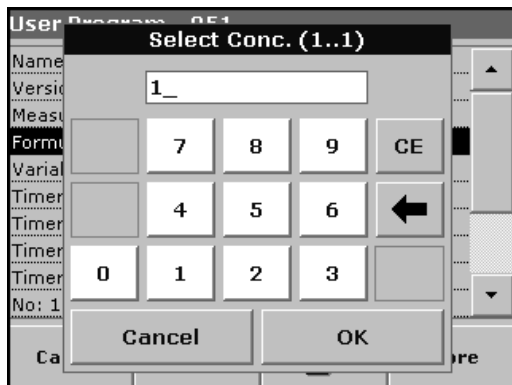

Select Conc. key

If an already defined formula, in this case C1, is to be taken into account in the formula for C2, press **Select conc.**

Enter the number of the formula (e.g. 1 for C1) and press OK to confirm.

Cn can now be linked with a mathematical operation.

Note: The Cn concentrations that are to be calculated are numbered in sequence: C1, C2, C3, etc.

Note: When the first Cn formula has been defined, the Formula list is automatically extended by Cn+1.

6.1.2.4 Enter variables

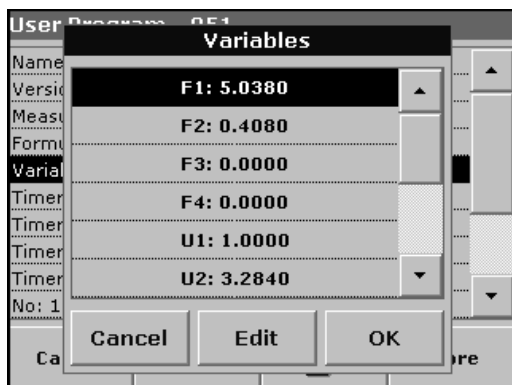

1. Highlight the **Variables** line in the data overview and press **Edit**.
2. Select the variable to be edited, press **Edit** and use the alphanumeric keypad to enter the data specified in the working procedure (for F1, F2, λ 1, U1 etc.). Press **OK** to confirm each entry.

Abbreviation of Variables:

F1: Factor 1

F2: Factor 2

λ 1: Wavelength 1

U1: Conversion Factor 1 for the first chemical form

U2: Conversion Factor 2 for the further chemical form etc.

6.1.2.5 Save a free programming user program

1. Press **Store** to save the entered data. The data can be stored under any data point (Measurement sequence, Formula, Timer, etc.).
2. Press the **PC & Printer** icon to send the program data to a printer or to a USB memory stick (connect the USB memory stick to the USB interface first).

Note: The test data will be formatted in the preinstalled PrgData folder as a **.csv** and as a **.lst** file.

3. To transfer the program data from one instrument to another create a new folder on the USB memory stick named **dbhic** and copy the **.lst** files into this folder (see section 6.7.2 on page 98).

6.1.3 Select a user program

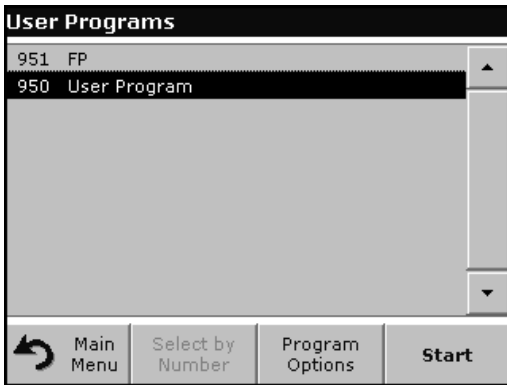

1. Press **User Programs** in the Main Menu to view an alphabetical list of user programs with program numbers.

The User Programs list will appear.

Note: Use the scroll bar to scroll through the list quickly.

*Note: Highlight the selection by pressing it or press **Select by Number** to search for the program by number.*

2. Press **Start** to run the program.

6.1.4 Add, edit and delete user programs from the favorites list

The most frequently used tests/methods in the User Program menu can also be added to the list of favorites to simplify their selection.

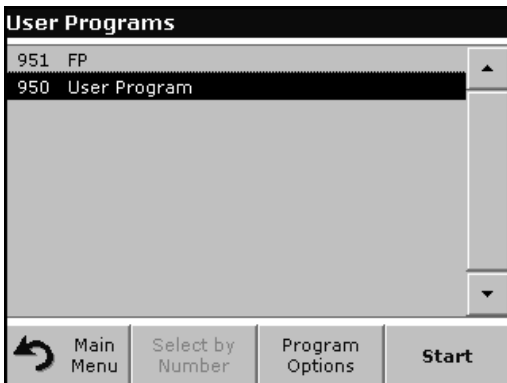

1. Press **User Programs** in the Main Menu.

The User Programs list will appear.

2. Highlight the selection by pressing it or press **Select by Number** to search for the program by number.

Note: Use the scroll bar to scroll through the list quickly. Use the alphanumeric keypad to enter the test number (program number) and press OK to confirm.



3. Press **Program Options**.

4. Press **Add to Favorites**, **Edit** or **Delete** and press **OK** to confirm.

Note: If the stored program is deleted in User Programs, it will also be deleted in Favorites Programs.

Advanced Operations

6.1.4.1 Add to Favorites



1. Press **Add to Favorites** and press **OK** to confirm.

The program is added to the Favorites.

6.1.4.2 Edit

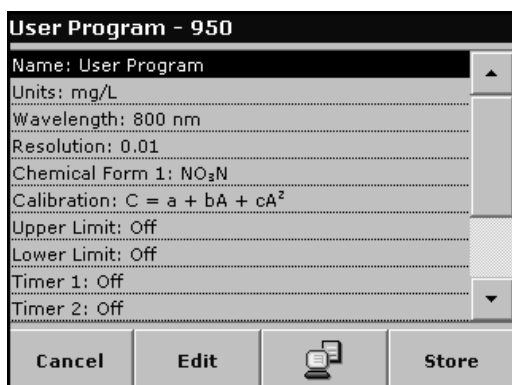

1. Press **Edit** and press **OK** to confirm.

An overview of the specifications of the programmed test is displayed. More information about the input options is provided in the section 6.1.2 on page 72.

6.1.4.3 Delete



1. Press **Delete** and press **OK** to confirm.

The program is deleted from the list of User Programs.

Note: If the stored program is deleted in User Programs, it will also be deleted in Favorites Programs.

6.2 Favorite Programs

The most frequently used tests/methods in the **Stored Programs** menu and the **User Programs** menu can also be added to the list of favorites to simplify their selection.

To add **Stored Programs** and/or **User Programs** to the favorites list or the favorite programs, see section 6.1.4 on page 79.

6.2.1 Recall a favorite program

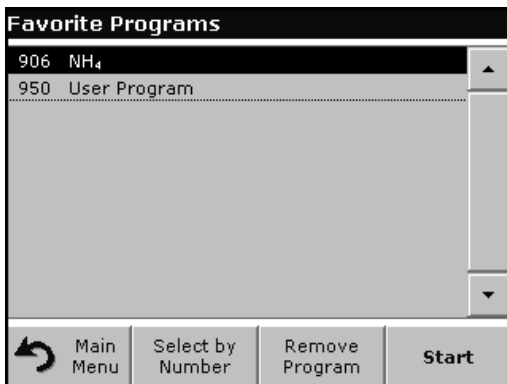

1. Press **Favorite Programs** in the Main Menu.

The Favorite Programs list will appear.

2. Highlight the selection by pressing it.

Note: Use the scroll bar to scroll through the list quickly.

Note: Press **Select by Number** to search for the program by number. Use the alphanumeric keypad to enter the test number (program number) and confirm the input by pressing **OK**.

3. Press **Start**.

6.2.2 Delete a favorite program



1. Press **Favorite Programs** in the Main Menu.

The Favorite Programs list will appear.

2. Highlight the selection by pressing it.

Note: Use the scroll bar to scroll through the list quickly.

Note: Press **Select by Number** to search for the program by number. Use the alphanumeric keypad to enter the test number (program number) and confirm the input by pressing **OK**.

3. Press **Remove Program** and press **OK** to confirm.

Note: If a **Favorite Programs** is deleted, it will stay in the **User Programs** or **Stored Programs**.

Note: If the stored program is deleted in **User Programs**, it will also be deleted in **Favorites Programs**.

6.3 Standard Addition – monitoring/checking results

The accuracy of measured values (their correspondence with the actual concentration of the analyte in the sample) and their precision (correspondence of the measurement results obtained from several samples containing the same concentration of the test analyte) can be determined or improved using the standard addition method.

This method (also referred to as spiking) serves to identify sample-specific interference factors, e.g. substances in the sample that falsify the analysis (sample matrix effect), a defective measuring instrument or contaminated reagents.

Method:

A defined amount (concentration) of a standard solution of the test substance is added to the sample. The detection rate should be close to 100%.

$$\text{Detection rate} = \frac{\text{Measured value after a standard addition}}{\text{Expected value after a standard addition}}$$

Detection rate	Conclusion	
100%	Probability that the measurement results are correct is high.	
< 100%	Assumption: The analysis was falsified by substances in the sample (sample matrix effect) Test to determine whether a sample matrix effect is present: Use distilled water instead of the sample. Add standard solution as described in the procedure.	
	Detection rate	Conclusion
	100%	Ions in the sample are interfering with the analysis, causing false results to be obtained.
≠ 100%	No interfering ions - consider other interference factors.	

Measures to identify other interference factors:

Checklist:

1. Check if the procedure is completed correctly:
 - a. Are the reagents added in the correct order?
 - b. Is enough time allowed for color development?
 - c. Is the correct glassware in use?
 - d. Is the glassware clean?

- e. Does the test require the sample to be at a certain temperature?
 - f. Was the pH of the sample in the correct range?
 - g. Is the pipette volume correct?
2. Check the used reagents by repeating the standard addition procedure with freshly prepared reagents.

Detection rate	Conclusion	
100%	The originally used reagents were defective. Check the standard solution: Repeat the standard addition procedure with a freshly prepared standard solution.	
	Detection rate	Conclusion
	100%	The originally used standard solution was defective.

If none of these measures resolves the problem, please contact the manufacturer or a sales representative.

6.3.1 Complete a standard addition

Carry out the standard addition in accordance with the corresponding procedure.

There are two different methods:

Peak volume (Standard addition):

Defined volumes of a standard solution are added step by step to an already analyzed sample. The sample is measured again after each addition.

Sample volume:

A defined volume of a standard solution of known concentration is added to the volume of sample specified in the procedure and the sample is measured after each addition. In most cases three different standard solutions are prepared and the procedure is repeated for each of them.

***Note:** The units and chemical forms used for the sample are used for the standard solutions. Be careful to ensure that to use the correct units for subsequent entries.*

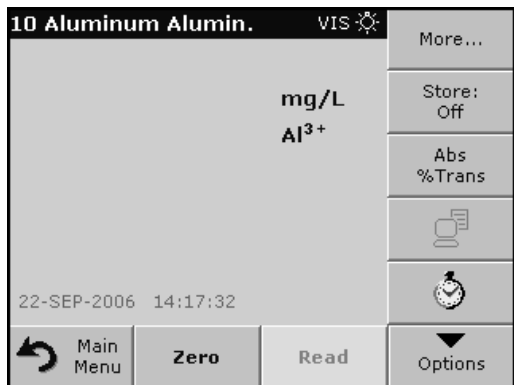

Peak volume/sample volume methods

1. Select **Stored Programs** in the main menu. Select the required program.
2. Press **Start**.
3. Analyze a sample without added standard solution in accordance with the instructions in the Procedures Manual. When the measurement is complete, leave the sample cuvette/cell in the cuvette/sample cell holder.

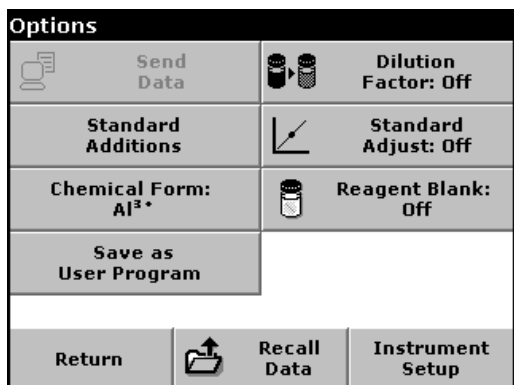

4. Press **Options>More>Standard Addition**.

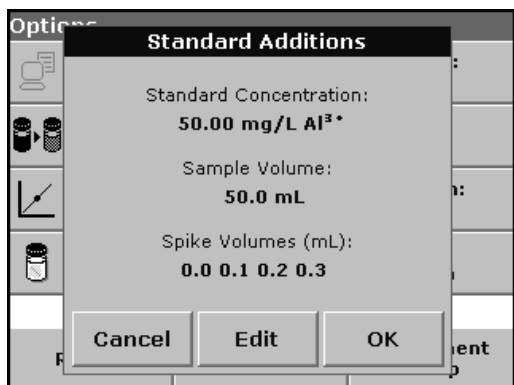

An overview of the data of the standard addition procedure is displayed.

5. Press **OK** to accept the standard values for standard concentration, sample volume (total) and standard addition volume. Press **Edit** to change any of these values.

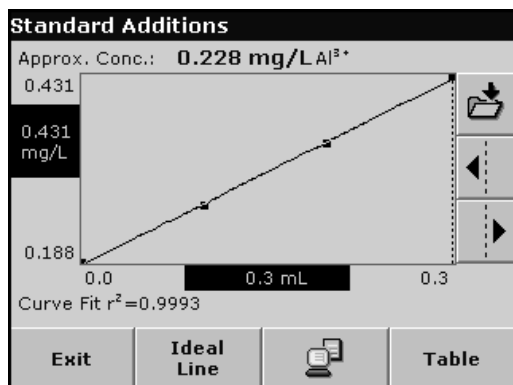

11. After all the standard addition solutions have been measured, press **Graph**.

The regression line through the standard addition data points is displayed.

The correlation coefficient r^2 indicates how close the data points are to the line.

If the correlation coefficient = 1, the curve is linear.

The concentration shown above the curve is the estimated concentration of the sample without the added standard.

Note: In the curve menu, the name on the **Curve** key switches to **Table**. Press **Table** to display all the data in the table again.

12. Press **Ideal line** to display the relationship between the added standard solutions and the ideal line (detection rate 100%).

6.4 Single Wavelength (absorbance, concentration and transmittance measurements)

The Single Wavelength mode can be used in three ways. For sample measurements at a single wavelength, the instrument can be programmed to measure the absorbance, % transmittance or concentration of the analyte.

Absorbance measures the amount of light absorbed by the sample, in units of absorbance.

% transmittance measures the percent of the original light that passes through the sample and reaches the detector.

Turn the concentration factor on to select a specific multiplier for converting absorbance readings to concentration. In a graph of concentration versus the absorbance, the concentration factor is the slope of the line.

6.4.1 Set up single wavelength mode

Press **Single Wavelength** in the Main Menu. Press **Options** for Parameter Setup.

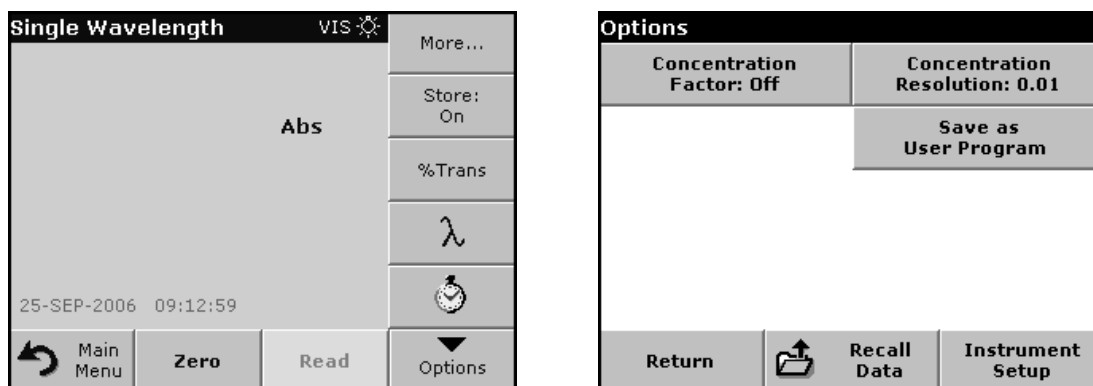

Table 12 Single wavelength setup options

Options	Description
More	For further Options
Store Off/On	With the Store On setting, all measurement data are stored automatically. With the Store Off setting, no measurement data are stored.
% Trans/Abs	To switch to % transmittance, concentration or absorbance readings
λ Wavelength	To enter the measurement wavelength. Use the alphanumeric keypad to enter the measurement wavelength. The entered wavelength must be in the range from 340–900 nm.
Timer icon	This functions as a stopwatch. It helps to ensure that the steps of an analysis are correctly timed (e.g. reaction times, wait times, etc., can be exactly specified). When the specified time has elapsed, an acoustic signal is emitted. The use of the timer has no influence on the measurement program.
Concentration Factor	Multiplication factor for converting absorbance values into concentration values.
Concentration Resolution	To select the position of the decimal point in the calculated concentration readings.
Save as User Program	To store the selected parameters as a User Program, see section 6.1 on page 61
Recall Data	Call up saved measurement data or time courses, see section 5.3 on page 37.

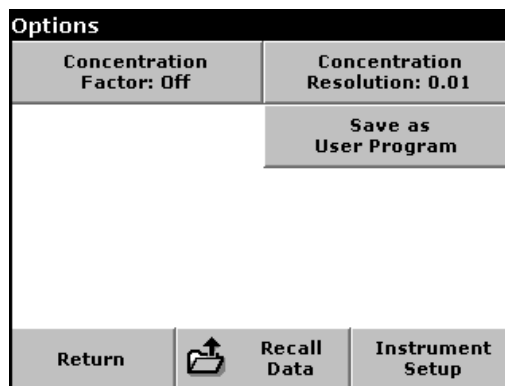
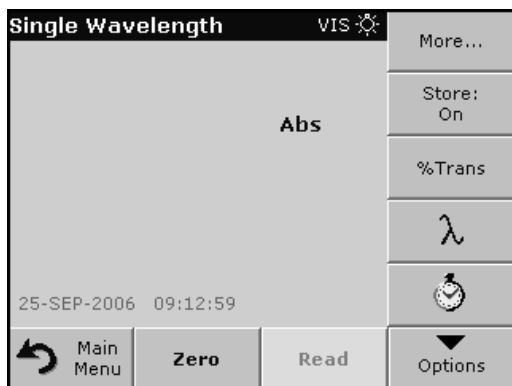
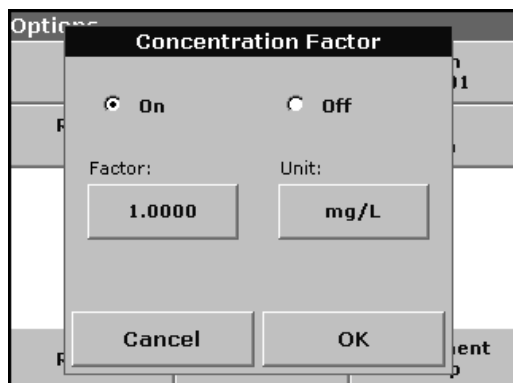

Table 12 Single wavelength setup options (continued)

Options	Description
Instrument Setup	Basic data of the instrument, see section 5.2 on page 27.



Concentration factor:

1. Press **Concentration Factor: Off** in the Options menu. Press **On** to highlight this feature.
2. Press the "Factor" key and use the alphanumeric keypad to enter the factor by which absorbance readings are to be multiplied. Press the "Unit" key to select the units for concentration measurements or to create a new unit.
3. Press **OK** to confirm.

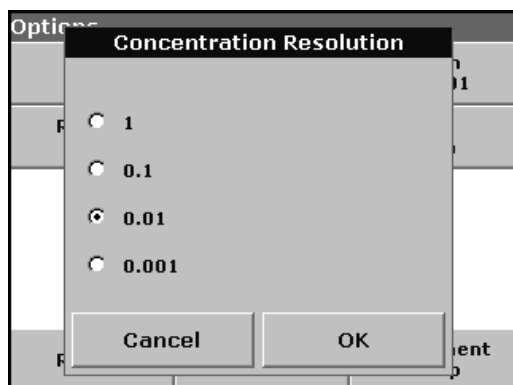

Concentration resolution:

1. Press **Concentration Resolution** in the Options menu.
2. Select the resolution and press **OK** to confirm.

6.4.2 Take single wavelength measurements



1. Insert the blank cuvette/cell into the cuvette/sample cell holder. Press **Zero**.

*Note: The **Read** key is only active after the zero measurement has been completed.*

2. Insert the sample cuvette/cell into the cuvette/sample cell holder. Press **Read**.
3. For data storage, see section 5.3.1 on page 37.

6.5 Multi-Wavelength mode – measurements at more than one wavelength

In the multi-wavelength mode, absorbance values can be measured at up to four wavelengths and the results can be mathematically processed to obtain sums, differences and relationships.

Absorbance measures the amount of light absorbed by the sample, in units of absorbance.

% Transmittance measures the percent of the original light that passes through the sample and reaches the detector.

Turning on the concentration factor allows selection of a specific multiplier for converting absorbance readings to concentration. In a graph of concentration versus the absorbance, the concentration factor is the slope of the line. Concentration is calculated using a single factor for each wavelength, which is input by the user.

6.5.1 Set the reading mode at different wavelengths

Press **Multi Wavelength** in the Main Menu. Press **Options** for Parameter Setup.

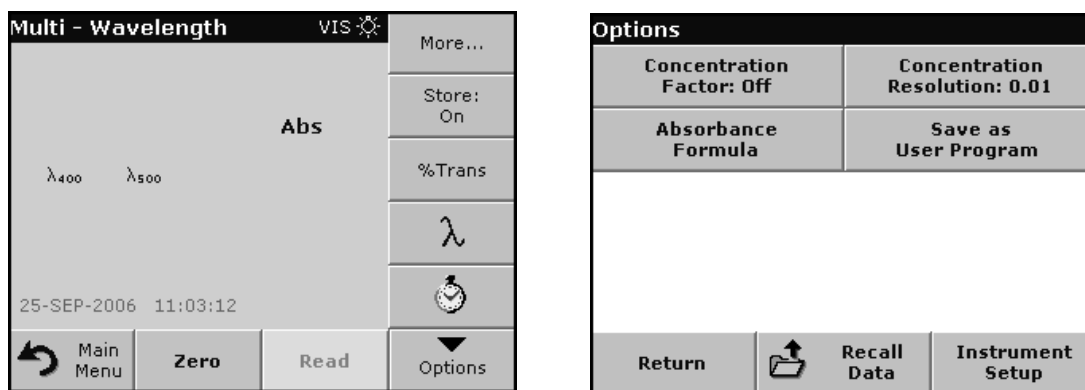

Table 13 Multi-wavelength setup options

Options	Description
More	For further Options
Store Off/On	With the Store On setting, all measurement data are stored automatically. With the Store Off setting, no measurement data are stored.
% Trans/Abs	To switch to % transmittance, concentration or absorbance readings
λ Wavelength	To enter the measurement wavelength. Use the alphanumeric keypad to enter the measurement wavelength. The entered wavelength must be in the range from 340–900 nm.
Timer icon	This functions as a stopwatch. It helps to ensure that the steps of an analysis are correctly timed (e.g. reaction times, wait times, etc., can be exactly specified). When the specified time has elapsed, an acoustic signal is emitted. The use of the timer has no influence on the measurement program.
Concentration Factor	Multiplication factor for converting absorbance values into concentration values.
Concentration Resolution	To select the position of the decimal point in the calculated concentration readings.
Absorbance Formula	Calculation basis for evaluating samples
Save as User Program	To store the selected parameters as a User Program, see section 6.1 on page 61

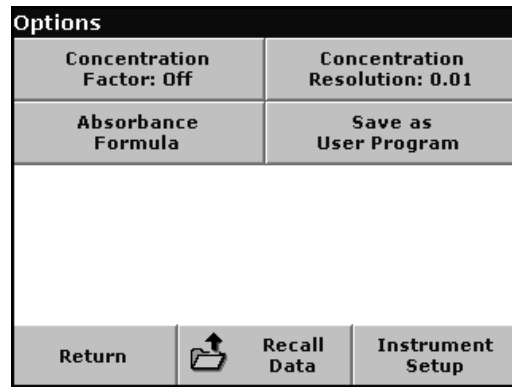
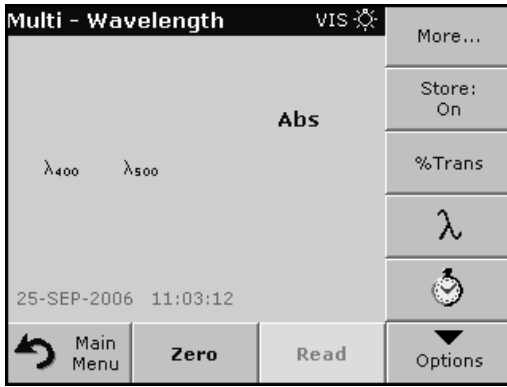
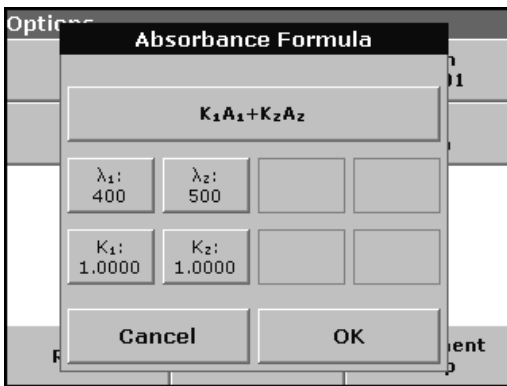

Table 13 Multi-wavelength setup options (continued)

Options	Description
Recall Data	Call up saved measurement data or time courses, see section 5.3 on page 37.
Instrument Setup	Basic data of the instrument, see section 5.2 on page 27.



λ / Absorbance formula:

1. Press **Absorbance Formula**.
2. The formula selected in the top key determines the number of wavelength and coefficient keys that will appear below. To change the absorbance formula, press the top key, select a formula from the displayed list and press **OK**. When a new formula is selected, the number of variables below changes to match.

The following formulas are available:

$$K_1 A_1 + K_2 A_2$$

$$K_1 A_1 + K_2 A_2 + K_3 A_3$$

$$K_1 A_1 + K_2 A_2 + K_3 A_3 + K_4 A_4$$

$$K_1 A_1 / K_2 A_2$$

$$(K_1 A_1 + K_2 A_2) / K_3 A_3$$

$$(K_1 A_1 + K_2 A_2) / (K_3 A_3 + K_4 A_4)$$

A₁ refers to the absorbance at wavelength 1

A₂ refers to the absorbance at wavelength 2, etc.

K₁ refers to the coefficient at wavelength 1

K₂ refers to the coefficient at wavelength 2, etc.

Coefficients can be set negative where subtraction is required.

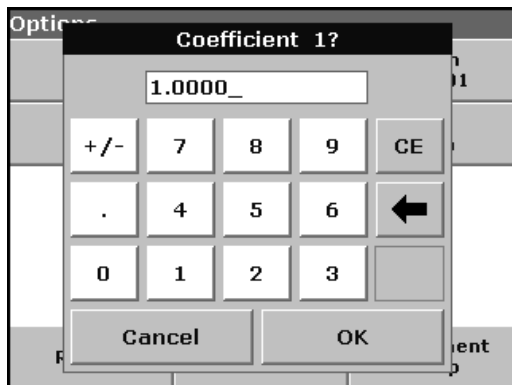

3. To change a wavelength, press one of the "λx:" keys. Enter the desired wavelength coefficient into the numeric keypad. Press **OK** to confirm.
4. To change a coefficient, press one of the "Kx:" keys. Enter the desired coefficient into the numeric keypad. Press **OK** to confirm.

Note: The instrument allows entry of up to 5 significant digits, with a maximum of 4 significant digits after the decimal point.

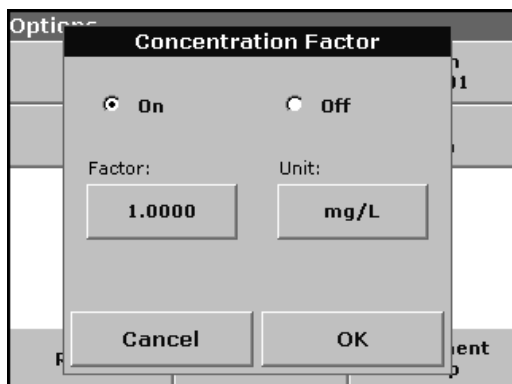

Concentration factor:

1. Press **Concentration Factor: Off** in the Options menu. Press **On** to highlight this feature.
2. Press the "Factor" key to enter the factor by which absorbance readings are to be multiplied. Press the "Unit" key to select the units for concentration measurements or to create a new unit.
3. Press **OK** to confirm.

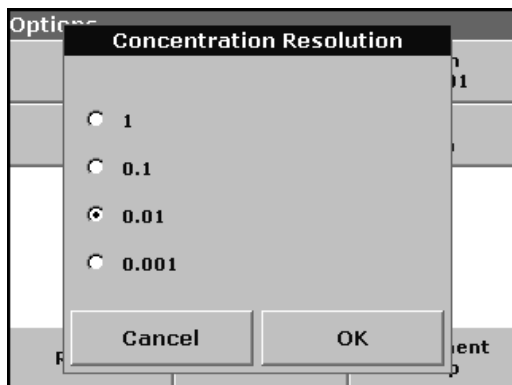

Concentration resolution:

1. Press **Concentration Resolution** in the Options menu.
2. Select the resolution and press **OK** to confirm.

6.5.2 Complete a measurement in the multi wavelength mode



1. Insert the blank cuvette/cell into the cuvette/sample cell holder. Press **Zero**.

*Note: The **Read** key does not become active until the zero measurement has been completed.*

2. Insert the sample cuvette/cell into the cuvette/sample cell holder. Press **Read**.
3. For data storage, see section 5.3.1 on page 37.

6.6 Time course of absorbance/transmittance

The Time Course Mode is used to collect data in either absorbance or transmittance for a user-specified length of time. After the data are collected, they can be displayed in either graphic or tabular format.

6.6.1 Time course setup parameters

Press **Time Course** mode in the Main Menu. Press **Options** to configure parameters.

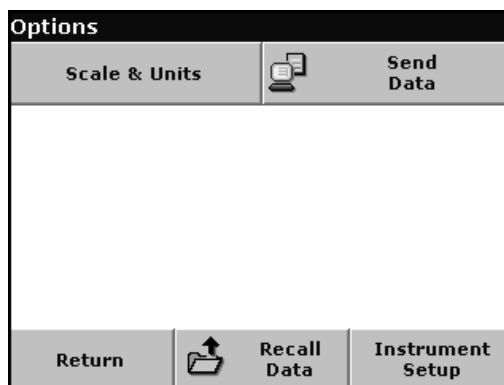
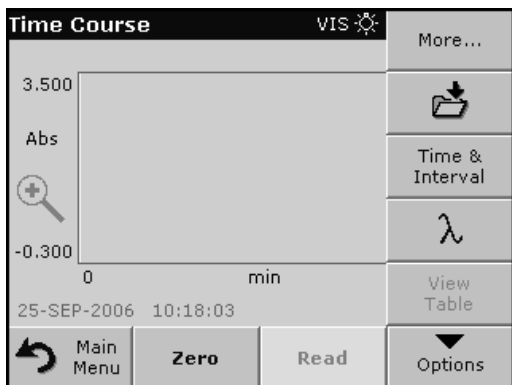

Table 14 Time course setup options

Option	Description
More	For further Options
Store icon	To store the scan data
Time & Interval	To input the total time for data collection and the time interval between the collection of data points
λ	To input the wavelength setting
View Table	To display readings in absorbance, transmittance or concentration. This can be changed after sample data are collected.
Scale & Units	Scale: In the automatic scaling mode, the y-axis is automatically adjusted so that the total scan is displayed. The manual scaling mode allows sections of the scan to be displayed. Units: Choice of absorbance or transmittance.
Send Data	To send Data to a printer, computer or USB memory stick (Type A)
Recall Data	Call up saved measurement data or time courses, see section 5.3 on page 37.
Instrument Setup	Basic data of the instrument, see section 5.2 on page 27.

**Time & interval:**

1. Press **Time & Interval** in the Options menu.
2. Input the total time and the reading time and press OK to confirm.

Note: In total 500 measuring steps are possible. To select a total time and a time interval that would cause this number of measurements to be exceeded, the time interval is defined automatically and the **OK** key is inactivated.

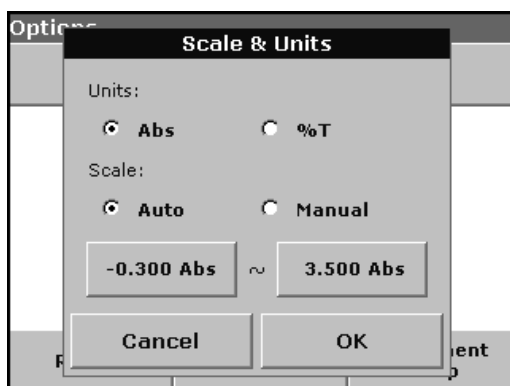
**Scale & units:**

1. Press **Scale & Units** in the Options menu.
2. Highlight **Abs** or **%T** as the required units.
3. Highlight **Auto** or **Manual** scaling on the graph's y-axis.

Note: If manual scaling is selected, use the alphanumeric keypad to set the limits y_{min} . and y_{max} . The graph is adjusted to display only the values in the selected range. If automatic scaling is selected, the instrument sets the limits automatically so that the total range can be displayed.

4. Press **OK** to confirm.
5. Press **Return** to return to the scan mode.

6.6.2 Time course scan reading

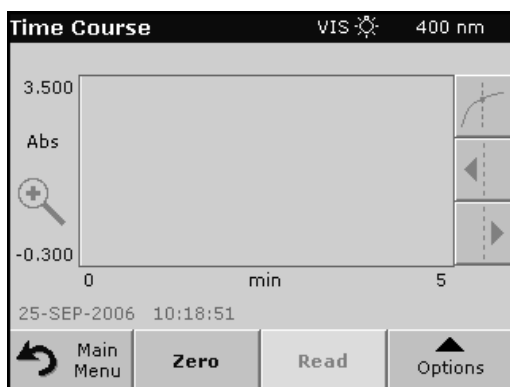

After the parameters have been selected, the instrument must be blanked, then the sample can be analyzed.

1. Insert the blank cuvette/cell into the cuvette/sample cell holder. Press **Zero**. The blank reading is shown on the display.
2. Insert the sample cuvette/cell into the cuvette/sample cell holder. Press **Read**. Start collecting time course (kinetic) data.

Note: During the measurement the **Zero** and **Read** keys change to **Mark** and **Stop**.

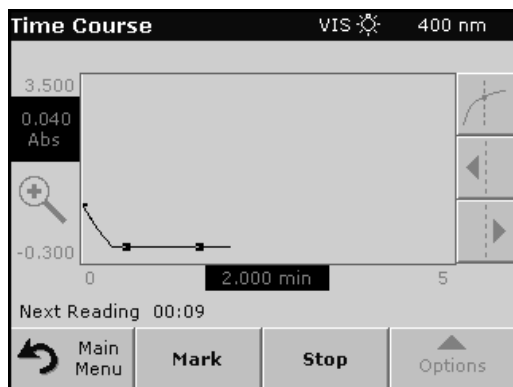

- Select **Mark** to mark the next data point collected. This mark is not used by the instrument, but is available for the user and may indicate a significant event, such as the addition of a sample or other reagent. The mark is also shown in the table.
- Select **Stop** to stop taking sample readings.

6.6.3 Analysis of time course data

After the data are collected, the following manipulations can be done on the graphic data:

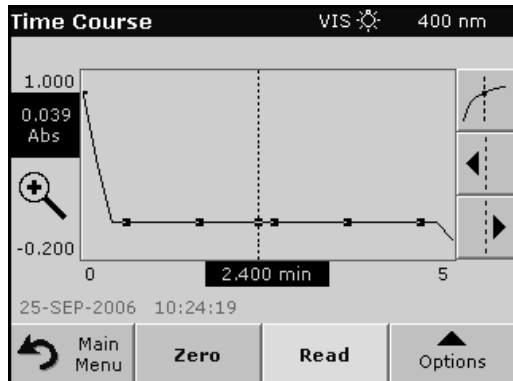

The **Time Course** Program is complete, if

- the sound is turned on, the instrument beeps when the readings are done
- the graph is shown fullsize,
- the scaling of the x-axis occurs automatically,
- the Cursor functions in the vertical navigation bar are highlighted.

6.6.3.1 Navigation of a time scan or a time scan analysis

After a time scan has been completed, the time and the absorbance/transmittance data are displayed as a curve.

Where the cursor is positioned on the curve, the elapsed time up to this point and the corresponding absorbance are highlighted.

Table 15 Navigating the time scan

Cursor Function/ Zoom Function	Description
Curve Icon (Choice of Cursor Mode)	Delta mode: A second cursor is highlighted. The position of the fixed cursor was previously defined in Cursor Mode Single. Use the active cursor to select any point on the measurement curve. The difference to the fixed cursor is shown on the curve. The delta values are correspondingly highlighted and displayed on the x and y axes. The gradient of the curve and the correlation coefficient (r^2) between the cursor points in the Delta mode are shown under the curve.
	Cursor Mode Single: The cursor moves to each selected measurement point of the scan.
Arrow keys	The arrow keys (right/left) are used to move the cursor (depending on the selected mode) to the next data point. The data of the data point (wavelength/absorbance or transmittance value) are highlighted on the x and y axes. <i>Note: Press any point on the curve to display the associated data.</i>
Zoom Icon	This function is used to magnify the section of the curve in the vicinity of the cursor. The original curve size can be restored by pressing the zoom icon again.

6.7 System checks

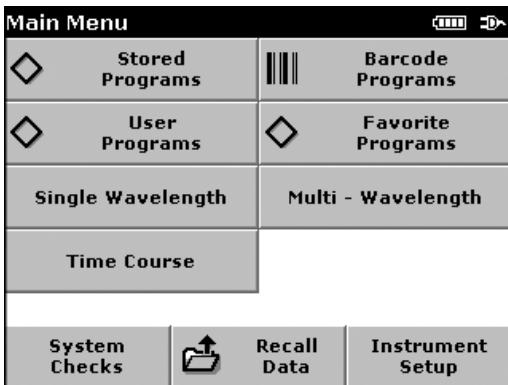

1. Press **System Checks** in the Main Menu.

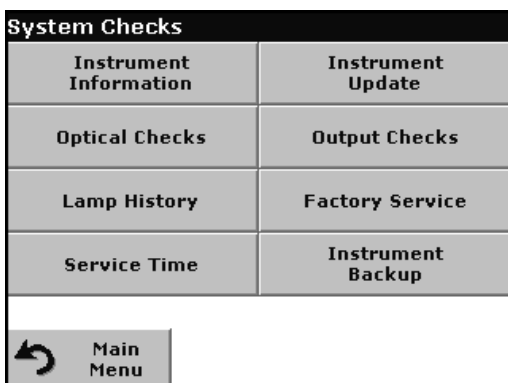

The System Checks menu contains instrument information and various performance tests.

6.7.1 Instrument information

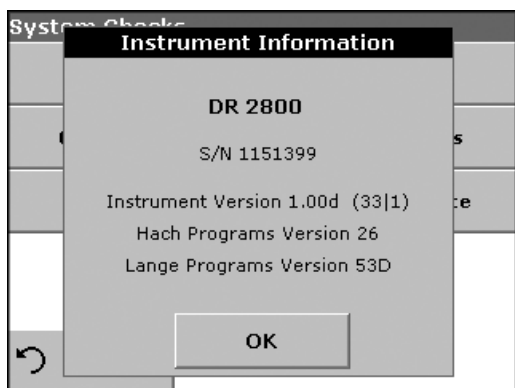

1. Press **Instrument Information** in the System Checks menu.
2. The model, serial number and software version are displayed.

6.7.2 Upgrade of the instrument software

To obtain the software for the update from the Internet at www.hach.com:



1. Go to <http://www.hach.com>.
2. On the DR 2800 product page, click **Lab System Software/Software Update Downloads** under **Downloads**.
3. Locate the appropriate download and follow the prompts for saving the file(s) to the USB memory stick.
4. On the DR 2800, press **Instrument Update** in the System Checks menu.
5. Connect the USB stick to the USB interface on the DR 2800 (section 3.4 on page 13). Press **OK**. The link is established automatically and the software is updated.
6. Press **OK** to return to the System Checks menu.

Note: When the instrument software has been updated, a prompt to restart the instrument is displayed.

6.7.3 Optical checks

For each optical check, the measured results must be evaluated against user-specific requirements. The check options do not define tolerances.

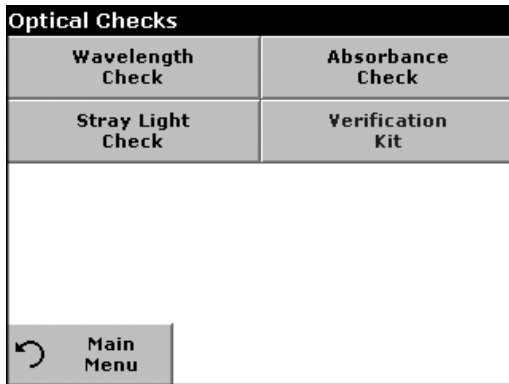

1. Press **Optical Checks** in the System Checks menu.

The Optical Checks menu contains programs for checking the wavelength accuracy, stray light and photometric accuracy.

An optional test filter set (Verification Kit) (Section 9 on page 119) containing 6 precision glass filters, target values, tolerances and instructions is available and is recommended as an aid for carrying out comprehensive in-house instrument checks.

6.7.3.1 Wavelength check

The Wavelength Check test is used to check wavelength accuracy at 807 nm.

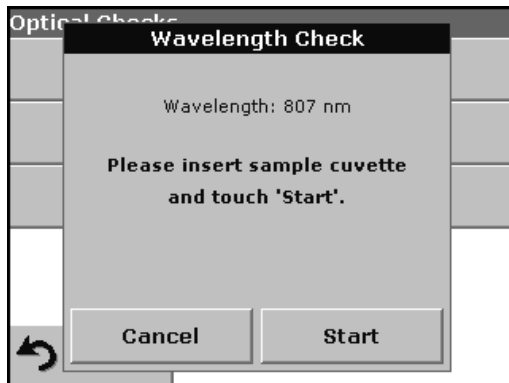

1. Press **Wavelength Check** in the Optical Checks menu.
2. Insert the adapter (A) for 10-mm rectangular cells in the cell compartment #2 and insert the sample cuvette/cell (Neodym or BG20/2) in the adapter. Close the cell compartment. Press **Start**.

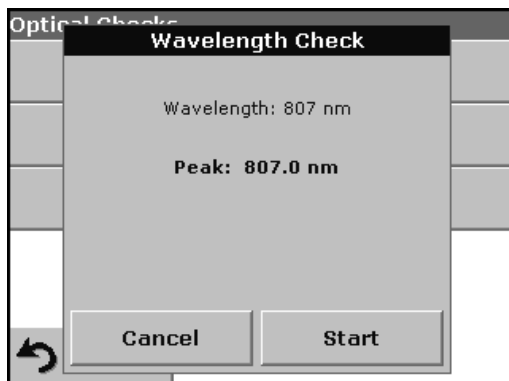

3. The result is displayed and is to be compared with the nominal/standard data (given in the quality control certificate) of the sample cuvette/cell.
4. Press **Cancel** to return to Optical Checks.

6.7.3.2 Stray light check

The Stray Light test is used to measure the stray light in the instrument at 340 nm.



1. Press **Stray Light Check** in the Optical Checks menu.
2. Remove any cuvette/sample cell from the cell compartment.
3. Insert the adapter (A) for 10-mm rectangular cells in the cell compartment #2. Press **Zero**.



4. Insert the sample cuvette/cell or reference filter into the cell compartment #2. Close the cell compartment. Press **Start**.

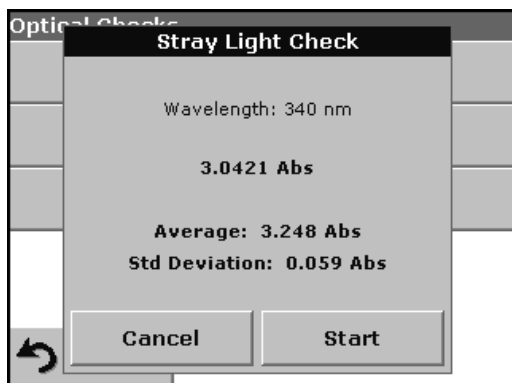

5. The "Average" and "Std Deviation" are calculated from 100 successive absorbance measurements. The result is displayed and is to be compared with the nominal/standard data (given in the quality control certificate) of the sample cuvette/cell.

Note: Failings and passings will be defined by the user.

6. Press **Cancel** to return to Optical Checks.

6.7.3.3 Absorbance check

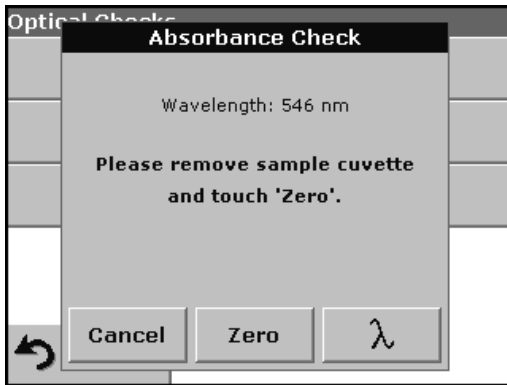

The Absorbance Check test is used to test the photometric accuracy and repeatability of the instrument.

This test can be used to test absorbance at any wavelength by a specific sample or test filter set (Refer to section 6.7.3.4 on page 102).

1. Press **Absorbance Check** in the Optical Checks menu.
2. Press λ to input the wavelength.
3. Input the wavelength and press **OK** to confirm.
4. Remove any cuvette/sample cell from the cell compartment and press **Zero**.

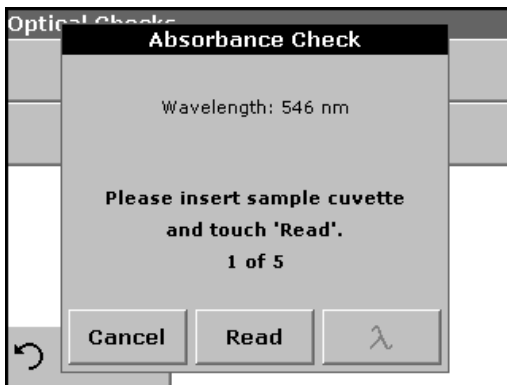

5. Insert sample cuvette/cell into the cell compartment and press **Read**.
6. 5 Replicates of blanking and reading lead to results.

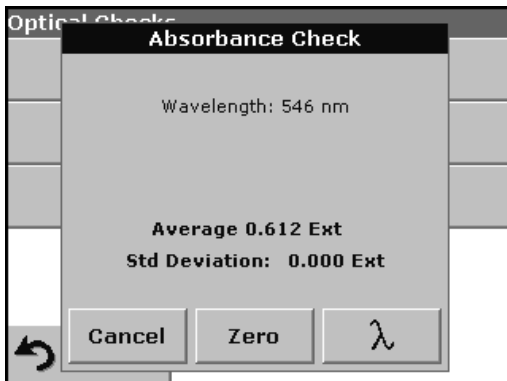

7. The result is displayed and is to be compared with the nominal/standard data of the sample cuvette/cell.
8. Press **Cancel** to return to Optical Checks.

6.7.3.4 Verification kit

The Verification Kit, LZV537, (see Section 9 on page 119) is designed for periodic monitoring of scattered light, photometric accuracy and the wavelength accuracy of the spectrophotometers.

When results exceed allowable tolerances (given in the quality control certificate), contact the manufacturer.

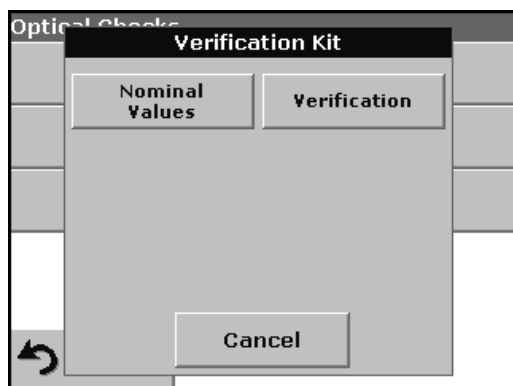

1. Press **Verification Kit** in the Optical Checks menu.
2. Press **Nominal Values**.

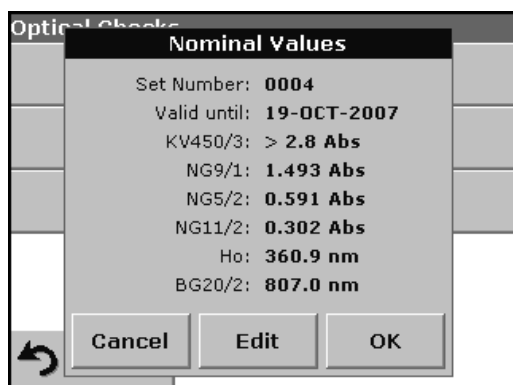

3. Press **Edit**.
- An automatic menu guidance queries values (filters, wavelength, nominal values and tolerances) given in the quality control certificate, to the following specifications:
- Stray Light
 - Photometrical accuracy
 - Wavelength accuracy
4. Press **OK** when all values are entered and the overview is displayed.

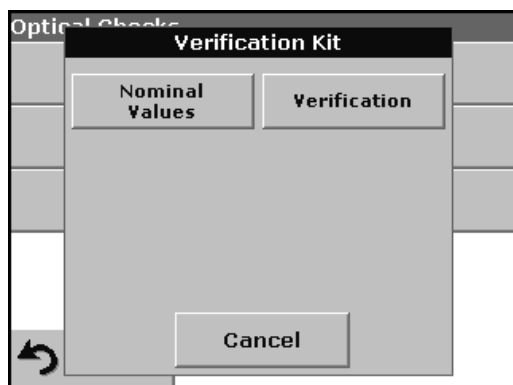

5. Press **Verification**.
6. Insert the adapter A (Figure 4 on page 15) in cell compartment #2.



7. Remove any cuvettes/cells from the cell compartment and press **Start**.



8. Insert the different filter in the given order one after the other. Press **Next** after inserting a filter.

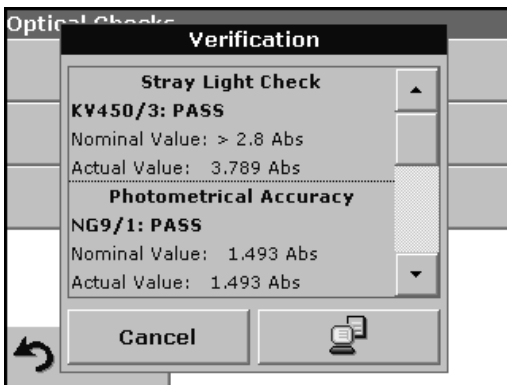

After the last measurement the results are displayed.

9. Press **PC & Printer** icon to send the data to a USB memory stick, PC or to a printer.

The files will be stored automatically as CSV file (Comma Separated Value). The file name will be formatted as "Verification.csv".

6.7.4 Output checks

If a printer is connected a test printing of the current screen will be printed.

6.7.5 Lamp history

The Lamp History menu provides the amount of time that the lamp has been on (Hours).

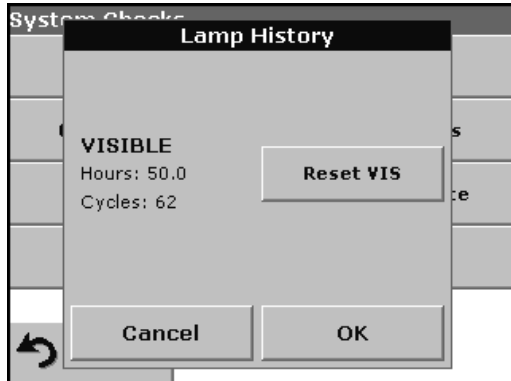

After a lamp is replaced and the Lamp History is reset, the display of the total operating time is reset to 0.

1. Press **Lamp History** in the System Checks menu.
2. Press **Reset VIS** and the Visible Lamp will be reset.
3. Press **OK** to return to System Checks.

6.7.6 Factory service

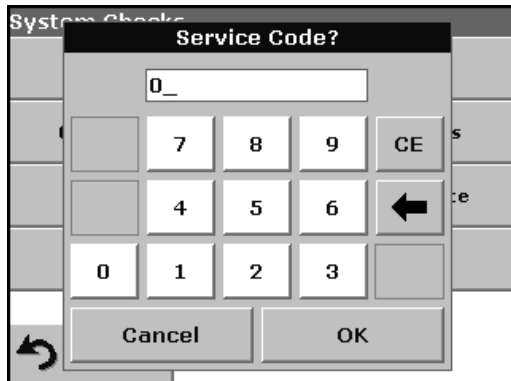

The Factory Service menu is password protected. This menu is not intended for customer use.

6.7.7 Service time

In order to ensure a regular inspection, an automatic memory reference for the service times can be entered. After switching the instrument on this memory reference will be activated and indicated at the appropriate time.



1. Press **Service Time** in the System Checks menu.
2. Select **On** and then **Last Service** to enter the date of the last inspection.
3. Press **OK** to confirm.



4. Select **Next Service** to determine a specific period of time up to the next inspection.
5. Press **OK** to confirm.



If the next service is due, the message "**Next service is due!**" is displayed after switching on the instrument.

6. Press **OK** to return to the Main Menu.

Contact the manufacturer or distributor to arrange an appointment for the next service.

6.7.8 Instrument Backup

Before the next service date the Instrument Backup menu offers the possibility to store all programs, measuring data, Operator ID, Sample ID, passwords and all adjustable data on a USB stick.

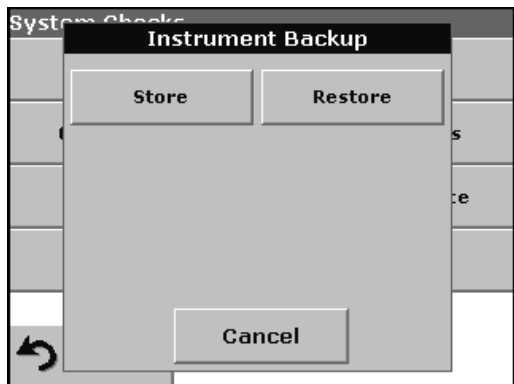

1. Press **Instrument Backup** in the System Checks menu.
2. Connect the USB memory stick (section 3.4 on page 13).
3. Press **Store** to start a Backup.



Note: If the USB stick is not connected, the message "Please insert USB Memory" is displayed. Connect a USB stick, in order to store the data. Press **OK** to confirm and press **Store** again.



Note: If the Backup was already stored before, the message "Data already exist. Overwrite?" is displayed. Press **OK** to overwrite the data.



If the file was stored the message Instrument Backup is stored to USB stick will be displayed.

4. Press **OK** to return to the System Checks menu.

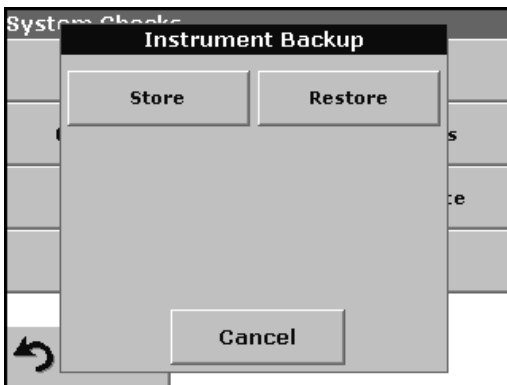

Restore backup data:

***Important Note:** All current data will be overwritten when restoring the Backup file!*

1. Press **Instrument Backup** in the System Checks menu.
2. Connect the USB memory stick containing the Backup (section 3.4 on page 13).
3. Press **Restore** to pass back the data.



***Note:** If the USB stick is not connected, the message "Please insert USB Memory" is displayed. Connect a USB stick, in order to store the data. Press **OK** to confirm and press **Restore** again.*



4. Press **OK** to confirm after the message "Instrument Backup from S/N XXXXXXXX. Restore?" is displayed.

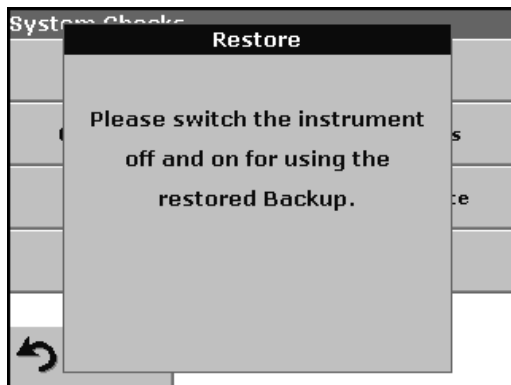

5. After the backup start the instrument again.

CAUTION

Potential Chemical, Biological Eye and Skin Hazards.
Only qualified personnel should conduct the tasks described in this section of the manual.

Important Note: Remove any cuvettes/cells that are still in the instrument and dispose of them or their contents using an approved disposal method.

7.1 Cleaning requirements

CAUTION

Potential Pinch, Eye, Burn and Chemical Hazards.
Always disconnect power from the instrument before attempting any cleaning operations.

Important Note: Under no circumstances should the instrument, display or the accessories be cleaned with solvents such as white spirit, acetone, etc.

7.1.1 Spectrophotometer

- Clean the enclosure, cuvette/sample cell compartments and all accessories with a soft damp cloth. A mild soap solution can also be used. Do not get excess water in the cuvette/sample cell compartments. Do not insert a brush or sharp object into Cell Compartment #1 to avoid damaging the mechanical components.
- Dry the cleaned parts carefully with a soft cotton cloth.

7.1.2 Display

- Take care not to scratch the display. Do not touch the screen with ball pens, pencils or similar pointed objects.
- Clean the display with a soft, lint-free and oil-free cotton cloth. Diluted window cleaner liquid can also be used.

7.1.3 Cuvettes/sample cells

CAUTION

Potential Chemical/ Biological Exposure Hazards.
Use proper laboratory practices whenever there is a risk of chemical exposure.

1. After performing a procedure, clean glass cuvettes/sample cells with cleaning agents.
2. Afterwards, rinse the cuvettes/sample cells several times with tap water and then thoroughly with deionized water.

Important Note: Glass cuvettes/sample cells that have been used for organic solvents (such as chloroform, benzene, toluene, etc.) must be rinsed with acetone before being treated with cleaning agents. In addition, another rinse with acetone is necessary as a final treatment step before the cuvettes/sample cells are dried.

7.2 Insert or change of the battery

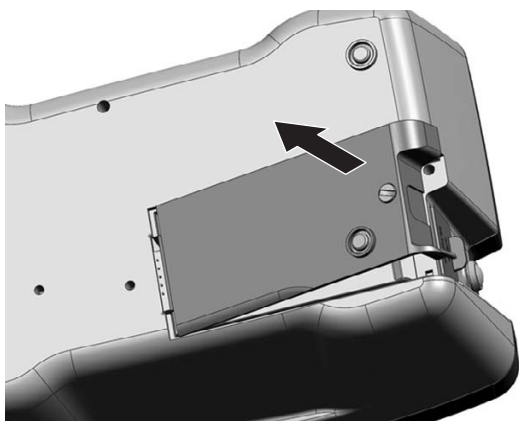

1. Remove the cuvette from the cell compartment.
2. Switch the instrument off.
3. Unplug the power cord.
4. Turn the instrument over carefully and place it on a soft surface.

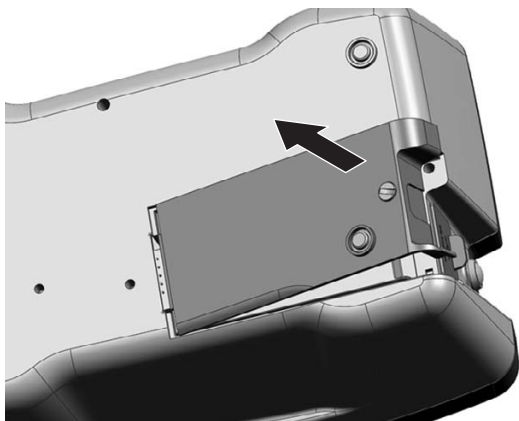

5. Use a screwdriver or a coin to remove the screw from the cover.
6. Remove the cover and place it to one side.

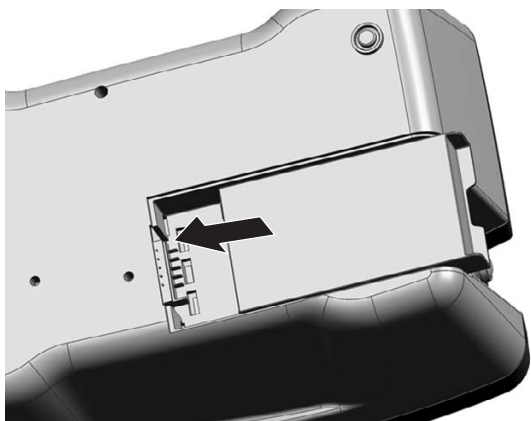

CAUTION

For quality and safety reasons, only the manufacturer's lithium batteries (LZV551) should be used for this instrument. Use of non-instrument-specific battery types may impair the functioning of and/or damage the instrument electronics by overloading them, or depending on battery types can even result in fire or explosion hazards.

7. Carefully push the battery from right to left into the compartment, with the labeled face upward.

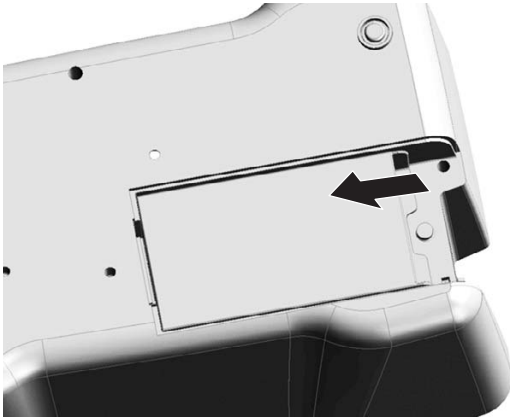

8. Push in the battery so that the contacts of the instrument can be plugged into the socket of the battery.

Important Note: Take care that the battery contacts are always clean. Soiled contacts can result in contact heating and voltage drop, interfering with the proper operation of the spectrophotometer.

9. Use a screwdriver or a coin to replace the screw securing the cover.
10. Carefully stand the instrument upright.
11. Plug in power supply again – the Instrument is now ready for use. The battery charges up.

7.2.1 Information about using the battery

7.2.1.1 Dispose of the lithium battery

A lithium battery allows the DR 2800 to be used as a portable instrument.

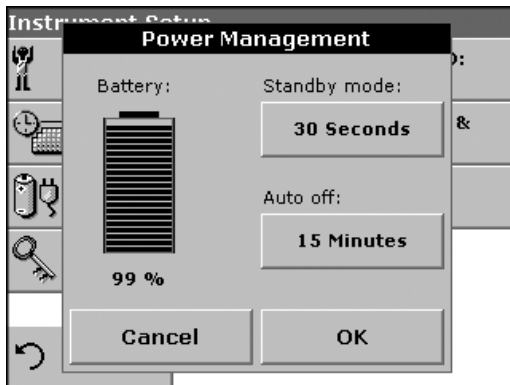

Please dispose the batteries of in compliance with the country-specific regulations (information about the charge status of the battery can be found in the "Instrument Setup" menu under 5.2.5 Power Management on page 29).

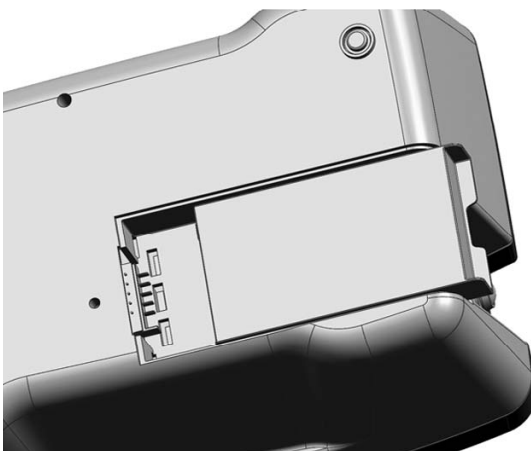

CAUTION

Pay special attention to the following information for the Lithium battery pack:

- Do not short-circuit the contacts.
- Keep the battery away from fire.
- Do not expose the battery to temperatures above 60°C (such temperatures may occur, for example, in a car left in the sun, or in direct sunlight).
- Take care that the battery does not become wet.
- Take care that the battery is not exposed to impacts, blows, etc. Do not drop it. Do not step on it by accident.
- Do not take the battery apart or modify it in any way.

- The performance of the battery decreases with the temperature.

7.2.1.2 Optimal operation of the battery

The battery is charged automatically when the plug-in power supply on the back of the instrument is connected and is plugged into a mains socket (100–240 Volt/50–60 Hz).

CAUTION

Use only the manufacturer's specified external power supply to operate the instrument and charge the internal lithium battery pack. The specified power supply and its plug shape, its voltage rating (12V, 2A) and its electromagnetic characteristics are critical to assuring the DR 2800's performance and the safety of the user.

Important Note: We advise charging the battery at an ambient temperature between 10°C and 30°C, as this is the range in which it can be most effectively charged to 100%.

7.2.1.3 Lifespan of the battery

The battery has a limited lifespan. The more it is used, the more its capacity is reduced. If a fully charged battery only allows the instrument to be used for a relatively short time, replace the battery with a new one.

Note: You need not run down the battery completely before recharging it. If you recharge the battery when it still has some residual charge, this does not reduce its capacity!

7.2.1.4 Load the battery/Operating time

The time required to charge a newly installed battery is about 3.5 hours.

Operating time of a fully charged battery:

Charge: If a battery is charged to 100% capacity, and the user carries out 10 measurements per day, and the instrument is left on after each measurement for the full 15 minutes before it automatically switches off, the battery can be used for 6 to 7 days before it needs recharging.

7.3 Lamp replacement

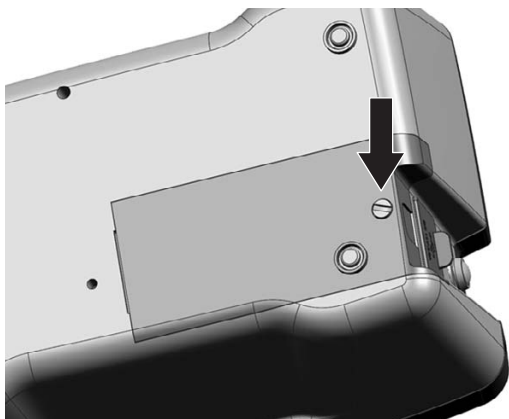
**CAUTION**

To avoid a possible electric shock, disconnect the instrument from the power source before servicing the lamp.

1. Remove the cuvette from the cell compartment.
2. Switch the instrument off.
3. Unplug the power cord.

WARNING

Burn Hazard. Wait until the lamp cools down. Contact with the hot lamp can cause burns.

4. Turn the instrument over carefully and place it on a soft surface.
5. Use a screwdriver or a coin to remove the screw from the cover.
6. Remove the cover and place it to one side.
7. If there is a battery in the instrument, push it out and put it to one side too, see section 7.2.1 on page 111.

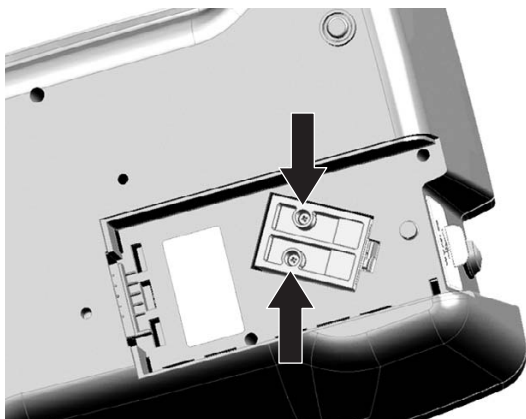
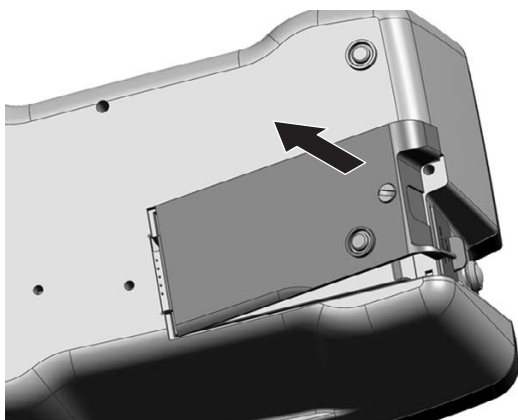

8. Use a screwdriver (slotted or cross-headed) to remove the screws from the lamp fitting.

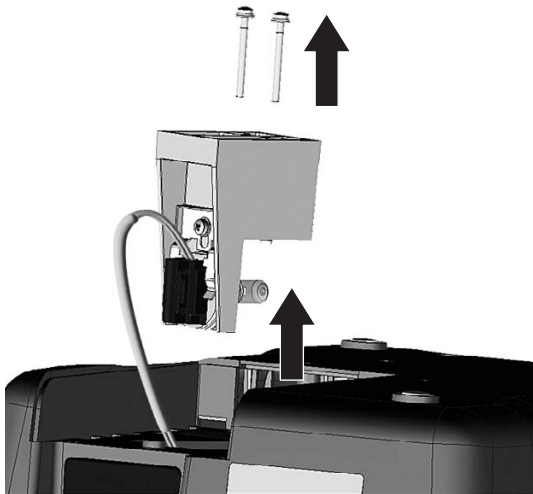

WARNING
Burn Hazard. Wait until the lamp cools down. Contact with the hot lamp can cause burns.

9. Lift the lamp fitting carefully.
10. Put both screws to one side.

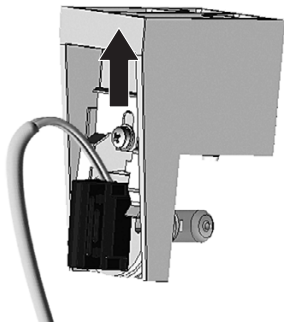

11. Push up on the pressure spring.

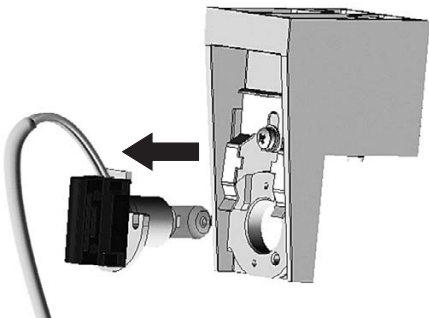

12. Remove the halogen lamp complete with the plug panel.

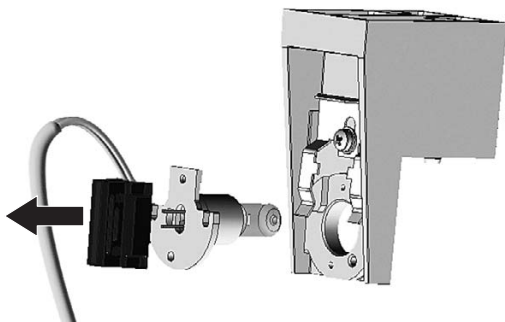

13. Carefully unplug the halogen lamp from the plug panel.

Important Note: Hold the lamp by the fitting only. Avoid touching the glass, as substances on the skin can bake onto the lamp bulb and thus accelerate the aging process of the lamp.

14. Plug a new halogen lamp to the panel.

15. Insert the halogen lamp with the half rounded part pointing down.

16. Press the plug with slight pressure into the direction of the halogen lamp and push the pressure spring down, so that it will engage.

17. Carefully insert the lamp fitting again.

18. Use a screwdriver (slotted or cross-headed) to replace the screws to secure the lamp fitting.

19. Put the battery back in place, see section 7.2.1 on page 111.

20. Use a screwdriver or a coin to screw the back cover to the instrument.

21. Carefully stand the instrument upright.

22. Plug in the power supply.

23. Reset the Lamp History, see section 6.7.5 on page 104.

Section 8 Troubleshooting

Problem/Display screen	Likely Cause	Action
Attention! Please insert the light shield.	Measurements with barcode cuvettes generally require the light shield.	Insert the light shield. Press OK .
Absorbance > 3.5!	The measured absorbance exceeds 3.5	Dilute the sample and repeat the measurement
Concentration too high!	Calculated concentration is higher than 999999	Dilute the sample and repeat the measurement
Error Barcode controlnumber? Please update program data!	Deviation to the stored data	Data updating
Error Program not available. Please update program data!	Barcode cuvette test missing	Data updating
Error Clean Cuvette	The cuvette is soiled or there are undissolved particles in the cuvette	Clean the cuvette; allow the particles to settle
Error Selfcheck stopped. Please check the lamp. Please close the lid. Error [xx]	Self Check Test stops while starting the instrument	Check the lamp and replace it if necessary. Close the lid. Press Start Again .
Error Selfcheck stopped. Please remove the cuvette	Self Check Test stops while starting the instrument	Remove the cuvette. Press OK .
Error Selfcheck stopped. Hardware error. Error [x]	Electronic defect	Contact the manufacturer or a sales representative and indicate the error number
It's recommended to execute a Full System Check Please remove cuvette. Please close the lid.	The instrument needs a new Full System Check.	Remove cuvette. Close the lid. Press Start . If the Full System Check fails, please contact the manufacturer or distributor.
Negative result!	The calculated result is negative	Check the concentration of the sample
No evaluation!	Error in the test database / user database	Check the programming Contact the manufacturer or a sales representative
Over measuring range	The measured absorbance is above the calibration range of the test	Dilute the sample and repeat the measurement
Please check the lamp.	The lamp output is too low	Check the lamp and replace it if necessary
Too much ambient light! Move device into shade or close the lid!	The instrument sensors detects too much ambient light.	Reduce ambient light. (Avoid direct sun light.) Close the lid.
Under measuring range	The measured absorbance is below the calibration range of the test	If possible, select a test with a lower measurement range or use a cuvette with a longer path length
Unstable lighting conditions!	Fluctuating light conditions during the measurement	Close the lid or place the Protective Cover on the cuvette compartment (2)

Section 9 Replacement Parts

Description	Cat. No.
Rechargeable lithium battery	LZV551
Tungsten Lamp	LZV565
Cuvette/ Sample cell adapter 10 mm (A)	LZV583
Cuvette/ Sample cell adapter 1 inch (C)	LZV584
Light Shield	LZV646
Cell adapter for Pour-Thru Cell (B)	LZV585
Cell adapter set (cuvette adapters A, B, and C)	LZV647
Wall power supply	LZV610
Protective Cover and adapter holder	LZV642
Dust cover	HYH019
USB-Memory Stick	2946900
USB-Interface Cable (1 m)	LZV567
USB-Keyboard (keyboard layout: US)	LZV582
USB-Barcode Scanner (handset scanner)	LZV566
Pour-Thru Kit	5940400
Cuvette/ Sample cell set (1-inch square cuvettes/cells, matched pair, glass (10 mL)	2495402
Hach Data Trans (PC software for data transfer)	LZY274
Certified test filter set for self-checks (6 precision glass filters with target values)	LZV537

Section 10 Contact Information

HACH Company World Headquarters

P.O. Box 389
Loveland, Colorado
80539-0389 U.S.A.
Tel (800) 227-HACH
(800) -227-4224
(U.S.A. only)
Fax (970) 669-2932
orders@hach.com
www.hach.com

HACH LANGE GMBH

Willstätterstraße 11
D-40549 Düsseldorf
Tel. +49 (0)2 11 52 88-320
Fax +49 (0)2 11 52 88-210
info@hach-lange.de
www.hach-lange.de

DR. BRUNO LANGE AG

Juchstrasse 1
CH-8604 Hegnau
Tel. +41(0)44 9 45 66 10
Fax +41(0)44 9 45 66 76
info@hach-lange.ch
www.hach-lange.ch

HACH LANGE APS

Åkandevej 21
DK-2700 Brønshøj
Tel. +45 36 77 29 11
Fax +45 36 77 49 11
info@hach-lange.dk
www.hach-lange.dk

HACH LANGE LDA

Av. do Forte nº8
Fracção M
P-2790-072 Carnaxide
Tel. +351 214 253 420
Fax +351 214 253 429
info@hach-lange.pt
www.hach-lange.pt

HACH LANGE KFT.

Hegyalja út 7-13.
H-1016 Budapest
Tel. +36 (06)1 225 7783
Fax +36 (06)1 225 7784
info@hach-lange.hu
www.hach-lange.hu

HACH LANGE D.O.O.

Fajfarjeva 15
SI-1230 Domžale
Tel. +386 (0)59 051 000
Fax +386 (0)59 051 010
info@hach-lange.si
www.hach-lange.si

Repair Service in the United States:

HACH Company
Ames Service
100 Dayton Avenue
Ames, Iowa 50010
Tel (800) 227-4224
(U.S.A. only)
Fax (515) 232-3835

HACH LANGE LTD

Pacific Way
Salford
GB-Manchester, M50 1DL
Tel. +44 (0)161 872 14 87
Fax +44 (0)161 848 73 24
info@hach-lange.co.uk
www.hach-lange.co.uk

HACH LANGE FRANCE S.A.S.

33, Rue du Ballon
F-93165 Noisy Le Grand
Tél. +33 (0)1 48 15 68 70
Fax +33 (0)1 48 15 80 00
info@hach-lange.fr
www.hach-lange.fr

HACH LANGE AB

Vinthusdsvägen 159A
SE-128 62 Sköndal
Tel. +46 (0)8 7 98 05 00
Fax +46 (0)8 7 98 05 30
info@hach-lange.se
www.hach-lange.se

HACH LANGE SP.ZO.O.

ul. Opolska 143 a
PL-52-013 Wrocław
Tel. +48 (0)71 342 10-83
Fax +48 (0)71 342 10-79
info@hach-lange.pl
www.hach-lange.pl

HACH LANGE S.R.L.

Str. Leonida, nr. 13
Sector 2
RO-020555 Bucuresti
Tel. +40 (0) 21 201 92 43
Fax +40 (0) 21 201 92 43
info@hach-lange.ro
www.hach-lange.ro

HACH LANGE E.Π.E.

Αυλιδος 27
GR-115 27 Αθήνα
Τηλ. +30 210 7777038
Fax +30 210 7777976
info@hach-lange.gr
www.hach-lange.gr

Repair Service in Canada:

Hach Sales & Service
Canada Ltd.
1313 Border Street, Unit 34
Winnipeg, Manitoba
R3H 0X4
Tel (800) 665-7635
(Canada only)
Tel (204) 632-5598
Fax (204) 694-5134
canada@hach.com

HACH LANGE LTD

Unit 1, Chestnut Road
Western Industrial Estate
IRL-Dublin 12
Tel. +353(0)1 46 02 5 22
Fax +353(0)1 4 50 93 37
info@hach-lange.ie
www.hach-lange.ie

HACH LANGE SA

Motstraat 54
B-2800 Mechelen
Tél. +32 (0)15 42 35 00
Fax +32 (0)15 41 61 20
info@hach-lange.be
www.hach-lange.be

HACH LANGE S.R.L.

Via Riccione, 14
I-20156 Milano
Tel. +39 02 39 23 14-1
Fax +39 02 39 23 14-39
info@hach-lange.it
www.hach-lange.it

HACH LANGE S.R.O.

Lešanská 2a/1176
CZ-141 00 Praha 4
Tel. +420 272 12 45 45
Fax +420 272 12 45 46
info@hach-lange.cz
www.hach-lange.cz

HACH LANGE

8, Kr. Sarafov str.
BG-1164 Sofia
Tel. +359 (0)2 963 44 54
Fax +359 (0)2 866 04 47
info@hach-lange.bg
www.hach-lange.bg

HACH LANGE E.P.E.

27, Avlidos str
GR-115 27 Athens
Tel. +30 210 7777038
Fax +30 210 7777976
info@hach-lange.gr
www.hach-lange.gr

Repair Service in Latin America, the Caribbean, the Far East, Indian Subcontinent, Africa, Europe, or the Middle East:

Hach Company World
Headquarters,
P.O. Box 389
Loveland, Colorado,
80539-0389 U.S.A.
Tel +001 (970) 669-3050
Fax +001 (970) 669-2932
intl@hach.com

HACH LANGE GMBH

Hütteldorferstr. 299/Top 6
A-1140 Wien
Tel. +43 (0)1 9 12 16 92
Fax +43 (0)1 9 12 16 92-99
info@hach-lange.at
www.hach-lange.at

DR. LANGE NEDERLAND B.V.

Laan van Westroijen 2a
NL-4003 AZ Tiel
Tel. +31(0)344 63 11 30
Fax +31(0)344 63 11 50
info@hach-lange.nl
www.hach-lange.nl

HACH LANGE S.L.U.

Edif. Arteaga Centrum
C/Larrauri, 1C- 2ª Pl.
E-48160 Derio/Vizcaya
Tel. +34 94 657 33 88
Fax +34 94 657 33 97
info@hach-lange.es
www.hach-lange.es

HACH LANGE S.R.O.

Roľnícka 21
SK-831 07 Bratislava –
Vajnory
Tel. +421 (0)2 4820 9091
Fax +421 (0)2 4820 9093
info@hach-lange.sk
www.hach-lange.sk

HACH LANGE SU ANALİZ SİSTEMLERİ LTD.ŞTİ.

Hilal Mah. 75. Sokak
Arman Plaza No: 9/A
TR-06550 Çankaya/ANKARA
Tel. +90 (0)312 440 98 98
Fax +90 (0)312 442 11 01
bilgi@hach-lange.com.tr
www.hach-lange.com.tr

Section 11 Limited Warranty

Hach Company warrants its products to the original purchaser against any defects that are due to faulty material or workmanship for a period of one year from date of shipment unless otherwise noted in the product manual.

In the event that a defect is discovered during the warranty period, Hach Company agrees that, at its option, it will repair or replace the defective product or refund the purchase price excluding original shipping and handling charges. Any product repaired or replaced under this warranty will be warranted only for the remainder of the original product warranty period.

This warranty does not apply to consumable products such as chemical reagents; or consumable components of a product, such as, but not limited to, lamps and tubing.

Contact Hach Company or your distributor to initiate warranty support. Products may not be returned without authorization from Hach Company.

Limitations

This warranty does not cover:

- Damage caused by acts of God, natural disaster, labor unrest, acts of war (declared or undeclared), terrorism, civil strife or acts of any governmental jurisdiction
- Damage caused by misuse, neglect, accident or improper application or installation
- Damage caused by any repair or attempted repair not authorized by Hach Company
- Any product not used in accordance with the instructions furnished by Hach Company
- Freight charges to return merchandise to Hach Company
- Freight charges on expedited or express shipment of warranted parts or product
- Travel fees associated with on-site warranty repair

This warranty contains the sole express warranty made by Hach Company in connection with its products. All implied warranties, including without limitation, the warranties of merchantability and fitness for a particular purpose, are expressly disclaimed.

Some states within the United States do not allow the disclaimer of implied warranties and if this is true in your state the above limitation may not apply to you. This warranty gives you specific rights, and you may also have other rights that vary from state to state.

This warranty constitutes the final, complete, and exclusive statement of warranty terms and no person is authorized to make any other warranties or representations on behalf of Hach Company.

Limitation of Remedies

The remedies of repair, replacement or refund of purchase price as stated above are the exclusive remedies for the breach of this warranty. On the basis of strict liability or under any other legal theory, in no event shall Hach Company be liable for any incidental or consequential damages of any kind for breach of warranty or negligence.

Index

A

Absorbance Check	101
Absorbance Formula	90, 91
Alphanumeric keypad	25
Audio signals	29

B

Barcode Programs	51, 52, 53, 54
edit	53
Basic data	43, 53

C

Calibration formula	75
Calibration Settings	66
Chemical Form	44, 47, 53
Chemical form	52, 53
Cleaning	
Display	109
Spectrophotometer	109
Concentration Factor	87, 88, 90, 92
Concentration Resolution	87, 88, 90, 92
Cuvettes/cells	109

D

Data	37
delete	37, 39
recall	37
send	37
store	37
Data Log	37
Date and Time	28
Dilution Factor	44, 46, 53
Display	25, 109
Display and Sound	29

F

Factory Service	104
Favorites	50, 80, 81
delete	80, 81
edit	80
recall	81
Filter Settings	38
Formula	55, 56
Free programming	72, 73, 75, 78, 80

H

HACH Data Trans	33, 38
Hazard Information	9

I

Instrument Backup	106, 107
Instrument Information	98
Instrument Setup	44, 54, 88, 91, 94
Interfaces	31
Internet	59, 98, 99

L

Lamp, <i>see VIS-Lamp</i>	
Language	23

M

Main Menu	26
Maintenance	109

Marking	96
Measurement Process	55, 56, 72
Measuring sequence	73
Multi Wavelength	64, 66, 90, 91, 92, 93

N

Name	55
------------	----

O

Operator ID	26
create	26
delete	27
Optical Checks	99, 100, 101, 102
Output Checks	104

P

Password	34
activate	34
PC and Printer	31, 33
Print data	33
Printer Setup	31
Program	59, 61

R

Reagent Blank	44, 48
Recall Data	44, 54, 87, 91, 94

S

Safety Information	9
Sample blank	54
Sample ID	28
create	28
delete	28
Save as User Program	44, 54, 87, 90
Scale & Units	94, 95
Security List	34
Self Check	23
Send Data	38, 44, 53, 94
Service Time	105
Single Wavelength	63, 66, 87, 88
Software	59, 98, 99
Specifications	7
Standard Addition	44, 82
Standard Adjust	44, 46
Stored Data	37
Stored Programs	43, 44, 46, 47, 48, 50
send Data	44
Stray Light Check	100
System Checks .. 23, 26, 97, 99, 100, 101, 102, 104, 105,	106

T

Time & Interval	94, 95
Time Course	94, 96, 97
Time Course Scan Reading	95
Timer	29, 44, 53, 55, 57, 87, 90
Touch Screen	25

U

Unpack the instrument	11
Update	55, 59, 98, 99
User Programs	61

V

Variables	55, 57, 78
Verification Kit	102
Version	55, 56
View Table	94
VIS-Lamp	
Lamp Control	
Lamp History	104

W

Warranty	123
Wavelength	87, 90
Wavelength Check	99
Wavelength setting	94

Free Manuals Download Website

<http://myh66.com>

<http://usermanuals.us>

<http://www.somanuals.com>

<http://www.4manuals.cc>

<http://www.manual-lib.com>

<http://www.404manual.com>

<http://www.luxmanual.com>

<http://aubethermostatmanual.com>

Golf course search by state

<http://golfingnear.com>

Email search by domain

<http://emailbydomain.com>

Auto manuals search

<http://auto.somanuals.com>

TV manuals search

<http://tv.somanuals.com>