

R410A MULTI SPLIT SERIES ROOM AIR CONDITIONER

CASSETTE TYPE INDOOR UNITS OPERATION & INSTALLATION MANUAL

AB092XCERA

AB122XCERA

AB142XCERA

AB182XCERA

No.0010577258

A

- Please read this manual carefully before using this air conditioner.
- Please keep this manual safely for future use.

■ Contents

Cautions	1-2
Main Points of Operation.....	3-4
Parts and Functions	5
Safety Cautions.....	6-7
Maintenance	8-9
When Trouble Happens	10
Customer Need-to-know	11
Installation Procedures	12-17
Instructions to installation	18-19
Trouble Shooting.....	20-22

■ Cautions

Disposal of the old air conditioner

Before disposing an old air conditioner that goes out of use, please make sure it's inoperative and safe. Unplug the air conditioner in order to avoid the risk of child entrapment.

It must be noticed that air conditioner system contains refrigerants, which require specialized waste disposal. The valuable materials contained in a air conditioner can be recycled. Contact your local waste disposal center for proper disposal of an old air conditioner and contact your local authority or your dealer if you have any question. Please ensure that the pipework of your air conditioner does not get damaged prior to being picked up by the relevant waste disposal center, and contribute to environmental awareness by insisting on an appropriate, anti-pollution method of disposal.

Disposal of the packaging of your new air conditioner

All the packaging materials employed in the package of your new air conditioner may be disposed without any danger to the environment.

The cardboard box may be broken or cut into smaller pieces and given to a waste paper disposal service. The wrapping bag made of polyethylene and the polyethylene foam pads contain no fluorochloric hydrocarbon.

All these valuable materials may be taken to a waste collecting center and used again after adequate recycling.

Consult your local authorities for the name and address of the waste materials collecting centers and waste paper disposal services nearest to your house.

Safety Instructions and Warnings

Before starting the air conditioner, read the information given in the User's Guide carefully. The User's Guide contains very important observations relating to the assembly, operation and maintenance of the air conditioner.

The manufacturer does not accept responsibility for any damages that may arise due to non-observation of the following instruction.

- Damaged air conditioners are not to be put into operation. In case of doubt, consult your supplier.
- Use of the air conditioner is to be carried out in strict compliance with the relative instructions set forth in the User's Guide.
- Installation shall be done by professional people, don't install unit by yourself.
- For the purpose of safety, the air conditioner must be properly grounded in accordance with specifications.
- Always remember to unplug the air conditioner before opening inlet grill. Never unplug your air conditioner by pulling on the power cord. Always grip plug firmly and pull straight out from the outlet.
- The air breaker should be all-pole switch, and the distance between it's two connectors should be no less than 3mm.

Cautions

- All electrical repairs must be carried out by qualified electricians. Inadequate repairs may result in a major source of danger for the user of the air conditioner.
 - Do not damage any parts of the air conditioner that carry refrigerant by piercing or perforating the air conditioner's tubes with sharp or pointed items, crushing or twisting any tubes, or scraping the coatings off the surfaces. If the refrigerant spurts out and gets into eyes, it may result in serious eye injuries.
 - Do not obstruct or cover the ventilation grille of the air conditioner. Do not put fingers or any other things into the inlet/outlet and swing louver.
 - Do not allow children to play with the air conditioner. In no case should children be allowed to sit on the outdoor unit.
2. If the supply cord is damaged, it must be replaced by the service agent or a similar qualified person.
 3. If the fuse on PC board is broken please change it with the type of T3.15A/250VAC.
 4. The wiring method should be in line with the local standard.
 5. The power cable and connecting cable are self-provided.

The requirement of the communication cable:

Model	power cable	Communication cable (sheilded wire)
AB092XCERA	H05RN-F 3G (1-2.5)mm ²	H05RN-F 2X(0.75-1.5)mm ²
AB122XCERA	H05RN-F 3G (1-2.5)mm ²	H05RN-F 2X(0.75-1.5)mm ²
AB142XCERA	H05RN-F 3G (1-2.5)mm ²	H05RN-F 2X(0.75-1.5)mm ²
AB182XCERA	H05RN-F 3G (1-2.5)mm ²	H05RN-F 2X(0.75-1.5)mm ²

Specifications

The refrigerating circuit is leak-proof.

The machine is adaptive in following situation

1. Applicable ambient temperature range:

			Rated	Maximum	Minimum
Cooling	Indoor	DB °C	27	32	18
		WB °C	19	23	14
	outdoor	DB °C	35	43	10
		WB °C	24	26	6
Heating	Indoor	DB °C	20	27	15
		WB °C	14.5	--	--
	outdoor	DB °C	7	24	-15
		WB °C	6	18	--

6. The waste battery shall be disposed properly.
7. The indoor unit installation height is at least 2.5m.

Main Points of Operation

Operation of Air Conditioner

When the environmental humidity is great, water may be dripped from the air outlet in cooling or drying mode.

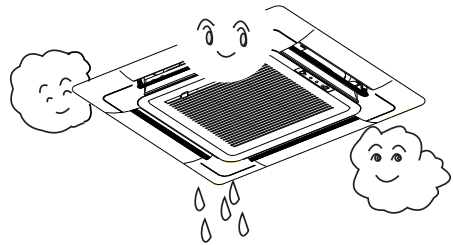

3-minute Protection Function

If restart the unit immediately after stopping, the compressor will start only 3 minutes later to protect the machine.

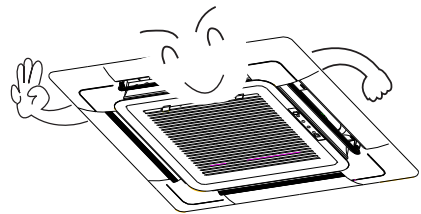

Variation of Fan Speed

If fan speed in auto mode, it will automatically lower when the room temperature close to the setting temperature in cooling mode.

In heating mode, the compressor stops when the room temperature at setting temperature and fan turns into low speed or stops.

In Dry mode, fan speed will be automatically varied.

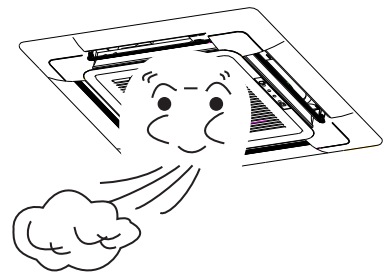

Remote Control:

There is a telecommunication interface for remote control on the control panel of the indoor unit. After the peripheral equipment have been installed in accordance with the instruction manual of the selected remote control detector, the air conditioner will be computerized and controlled from a far-away place.

Main Points of Operation

Prevent Cool Air Blowing Off

In heating mode, the indoor fan will not run immediately after the unit starts to prevent the cool air blowing off.



Defrosting Function

In heating mode, when frost formed on the outdoor heat exchanger, the air conditioner will automatically defrost a few minutes. During defrosting, both indoor and outdoor fan will stop running. When defrosting finished, air conditioner will automatically back to running.

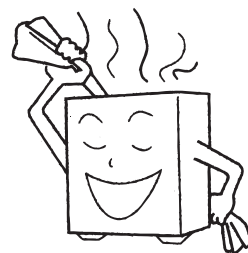

Defrosting Running

Hints

The air conditioner absorbs heat from outside and releases inside when in heating mode, therefore the outside environmental temperature will affect heating effects.

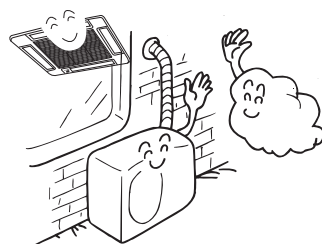

Power Failure Compensation(to be applied for a necessary situation):

After the power failure compensation is set, if power failure suddenly occurs while the air conditioner is working, it will resume the previous working state when the power is supplied again.

Setting Method: When the remote controller is on (excluding timer mode and fan mode), press the "sleeping" button on the remote controller 10 times within 5 seconds, and after the buzzer rings 4 times, the air conditioner will enter the state of power failure compensation.

Cancel Method: Press the "sleeping" button on the remote controller 10 times within 5 seconds, and after the buzzer rings 2 times, the power failure compensation mode will be cancelled.

Note: When a power failure suddenly occurs during the air conditioner is working after the power failure compensation is set, if the air conditioner will not be used for a long time, please cut off the power supply to prevent its operation from being resumed after the power is supplied again, or press the "Switch On/Off" button after the power comes again.

Parts and Functions

Swing louver

(Air flow direction can be adjusted by using the SWING button on the remote controller)

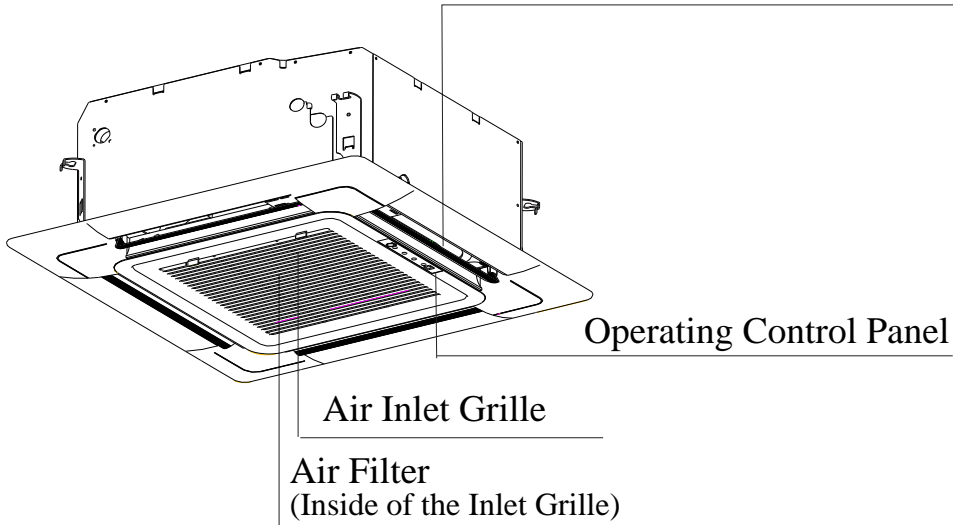

Operating Control Panel

Air Inlet Grille

Air Filter
(Inside of the Inlet Grille)

Safety Cautions

Carefully read the following information in order to operate the air conditioner correctly.

Below are listed four kinds of Safety Cautions and Suggestions:

WARNING: Incorrect operations may result in severe consequences of death or serious injuries.

CAUTION : Incorrect operations may result in injuries or machine damages; in some cases may cause serious consequences.

 : It must be strictly prohibited where marked with 'Prohibited', otherwise may result in machine damages or endanger the user's personal safety.

INSTRUCTION: This information can ensure the correct operation of the machine.

Be sure to conform with the following important Safety Cautions.

The Safety Cautions should be at hand so that they can be checked at any time when needed.

If the air conditioner is transferred to the new user, this manual should be as well transferred to the new user.

WARNING

- **If any abnormal phenomena are found (e.g. smell of firing), please cut off the power supply immediately, and contact the dealer to find out the handling method.**

In such case, to continue using the air conditioner will damage the conditioner, and may cause electrical shock or fire hazard.



- **When need maintenance and repair, call dealer to handle it.**

Incorrect maintenance and repair may cause water leak, electrical shock and fire hazard.

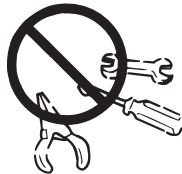

- **Don't put figures or any other things into the inlet/outlet and swing louver while the conditioner is in operation**

Because the high-speed fan is very dangerous and may cause injuries.



- **Call the dealer to take measures to prevent the refrigerant from leaking.**

The leaked refrigerant over certain density may cause oxygen deficient. If the air conditioner is installed in a small room be sure to take measure in order to prevent suffocation accident even in case of refrigerant leakage

- **When air conditioner is removed and reinstalled dealer should be responsible for them.**

Incorrect installation may cause water leaking, electrical shock and fire hazard.

- **Don't dismantle the outlet of the outdoor unit.**

The exposure of fan is very dangerous which may harm human beings.



- **After a long time use of air conditioner the base should be checked for any damages.**

If the damaged base is not repaired, the unit may fall down and cause accidents.



Safety Cautions

⚠ WARNING

- **No goods or nobody is permitted to be placed on or stand on outdoor unit.**

The falling of goods and people may cause accidents.



- **Don't operate the air conditioner with damp hands.**

Otherwise will be shocked.



- **Only use correct type fuse.**

May not use wire or any other materials replacing fuse, otherwise may cause faults or fire accidents.



- **Don't place any burning unit in the airflow of air conditioner, which may cause incomplete combustion.**



- **No inflammable spray fluid should be permitted to be placed or used near air conditioner, otherwise may cause fire accident.**



- **Air conditioner should be cleaned only after power supply is cut off to keep from shock or hurt.**

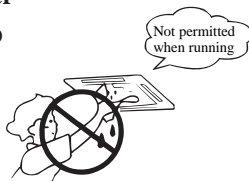

- **Don't clean air conditioner with water.**

Otherwise may cause shock.



- **Connect earthing wire.**

Earthing wire should not be connected to the gas pipe, water pipe, lightning rod or phone line, incorrect earthing may cause shock.



- **Use discharge pipe correctly to ensure efficient discharge.**

In correct pipe usage may cause water leaking.

- **Air conditioner can't be installed in the environment with inflammable gases.**

The inflammable gases near to air conditioner may cause fire hazard.

- **Installed electrical-leaking circuit breaker.**

It easily causes electrical shock without circuit breaker.

- **When use the fumigating insecticide don't operate air conditioner.**

Otherwise the poisonous chemicals may settle in air conditioner, which harm the health of chemical-allergic people.



Maintenance

Clean the unit

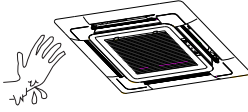
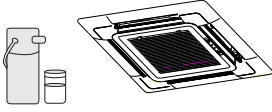
Turn off the power supply switch	Do not touch with wet hand.	Do not use hot water or volatile liquid
		

The 4 fixed bolts must be loosed as shown in the figure by arrow if they are bolts, the method is that: push the bolts inward till to another edge.

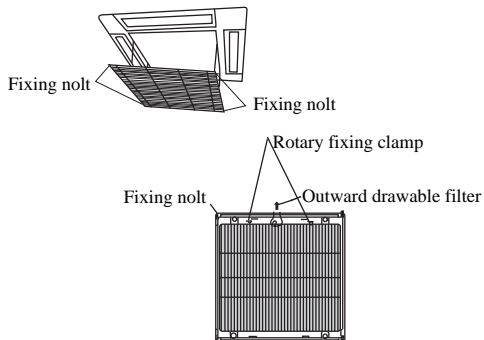

Clean the air filter

Clean the air filter with water or vacuum cleaner. Use the detergent or neutral soapy water if the air filter is too dirty. Then rinse the air filter with water, and reinstall after drying.

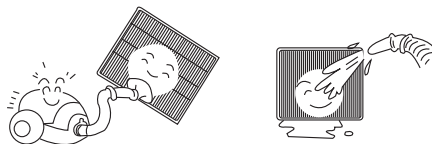

Caution:

Do not clean the air filter with hot water over 40°C, otherwise may damage the filter.
Sweep the filter carefully.

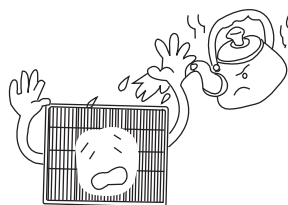

Clean indoor (outdoor) unit

Clean with hot wet cloth and neutral detergent, then wipe with dry cloth. Do not use too hot water (over 40°C) which may result in fading and deforming. Do not use insecticide and chemical washing agent.

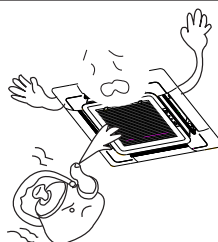

Maintenance

Seasonal Reserve

Post-season Care

Operate the unit with FAN mode on a fair day for about half a day to dry the inside of the unit well.

Stop operation and turn off the power supply switch .Electric power is consumed even the air conditioner is in stop.

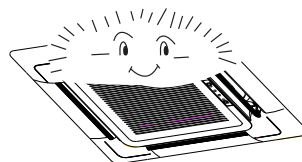

Clean the air filter, indoor unit and outdoor unit,and cover the unit with dustcoat.



Pre-season Care

See that there is no obstacle blocking the air inlet and air outlet of both indoor and outdoor unit to avoid reduce the working efficiency.

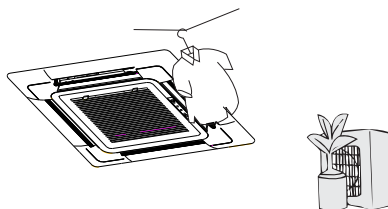

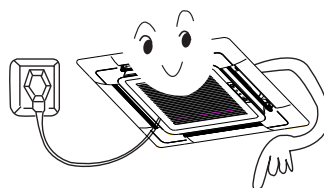

Be sure to install the air filter, ensure that the air filter is not dirty. Otherwise may result in machine damages or cause malfunction due to dust inside the unit

To protect compressor when start in HEAT mode, please cut in the power supply switch 12 hours before starting run,furthermore, always keep the power supply switch on during the using season.



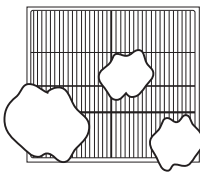

When Trouble Happens

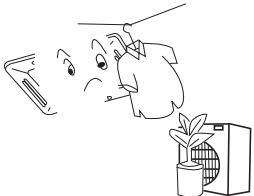
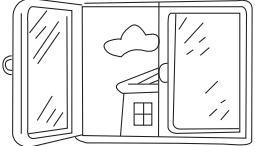
Insufficient cooling or heating

<p>The operation controller adjusted as required</p> 	<p>Air filter too dirty ?</p> 	<p>Horizontal swing louver upward ? (in HEAT mode)</p> 
<p>Any obstacle exists at the air inlet or outlet?</p> 	<p>Door or window left opened ?</p> 	

Insufficient cooling

<p>Any other heat sources in the room?</p> 	<p>Sunlight direct into the room ?</p> 	<p>Too crowded in the room ?</p> 
--	--	---

Cooled air blown out (when heating)

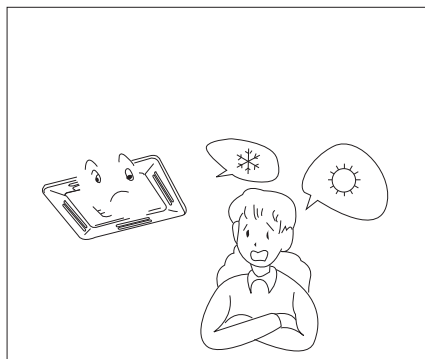

When the air conditioner does not operate properly after you have checked the above-mentioned items or when following phenomenon is observed, stop the operation of the air conditioner and contact your sales dealer.

- The fuse or breaker often shuts down.
- Water drops off during cooling or drying operation.
- There is an irregularity in operation or abnormal sound that is audible.

Customer Need-to-know

Customer Need-to-know

- Please install the air conditioner according to the requirements specified in this manual to ensure the air conditioner work well.
- Be careful not to scratch the surface of the case during moving the air conditioner.
- Please keep the installation manual for future reference when maintenance and changing installation place.
- After installation ,please use the air conditioner according to the specification in the operation manual.

Using Directions

Adjust suitable airflow direction

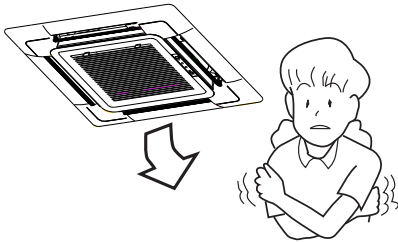

Avoid direct sunlight and airflow



Keep the proper indoor temperature.
Too cool or hot is not good for your health.
Furthermore, it will result in excessive
consumption of electric power.

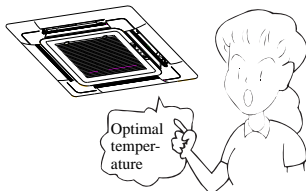

Effectively use timer.

Using TIMER mode, you can make the room
temperature reach a suitable temperature when
you wake up or back home.

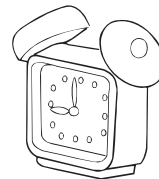

ATTENTION: after finishing installation, please confirm no refrigerant leakage.

Installation Procedures

1. Selection of Installation Place

- (1) Place above the ceiling where have enough space to arrange the unit.
- (2) Place where the drainage pipe can be arranged well.
- (3) Place where inlet and outlet air of indoor and outdoor unit will not be blocked.
- (4) Do not expose the unit to the place with heavy oil or moisture (e.g.kitchen and workshop).
- (5) Do not set the unit in the place where destructive gas (such as sulfuric acid gas) or pungent gas (thinner and gasoline) concentrates and retains.
- (6) Place strong enough to support the unit weight.
- (7) No expensive articles such as television and piano below indoor unit.
- (8) Enough space for maintenance.
- (9) Place more than 1m away from television and radio to avoid disturbing television and radio.
- (10) Easy for maintenance.

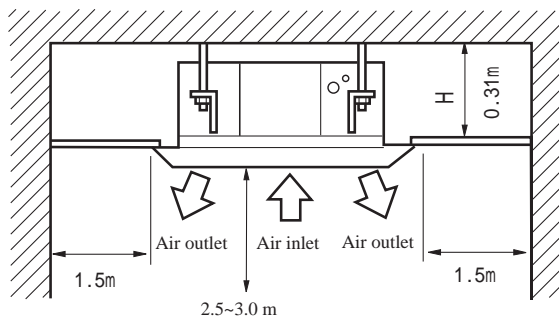

2. Installation Preparation

- (1) Position of ceiling opening between unit and suspending bolt (front view of unit).

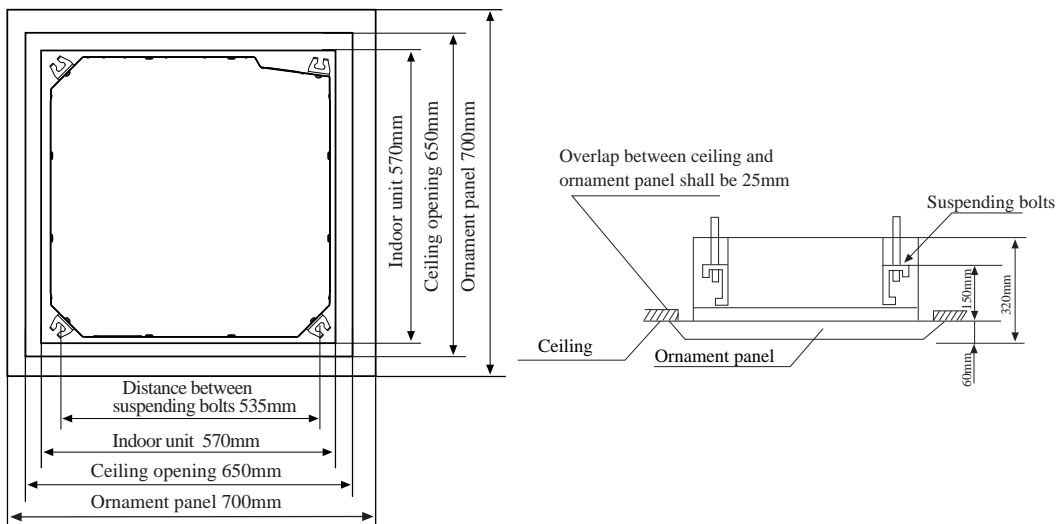

- (2) Prepare all piping (refrigerant, water drainage) and wires (connection wire of remote controller, indoor unit connection wires) to the indoor unit before installation in order to connect indoor unit immediately after installation.

Installation Procedures

(3) Install a suspending bolt

To support the unit weight, anchor bolt should be used in the case of already exists ceiling. For new ceiling, use flush-in type bolt, built-in type bolt or parts prepared in the field.

Before going on installing, adjust space to ceiling.

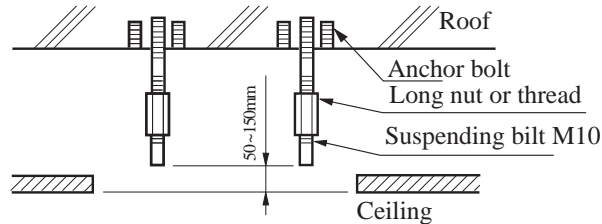

Note: All the above mentioned parts shall be prepared in field, the diameter of suspending bolt is M10

3. Installation of indoor unit

<Installation Example>

In case of no ceiling

Install unit temporarily

Put suspending bracket on the suspending bolt to hang the unit up. Be sure to use nut and washer at both end of the bracket to secure firmly.

After installation on the ceiling

(1) Adjust unit to its right position (Refer to preparation for installation-(1))

(2) Check that unit is horizontal.

Water pump and floating switch is installed inside indoor unit, check four corners of the unit for its level using horizontal comparator or PVC tube with water. (If unit is tilting against the direction of water drainage, problem may occur on floating water leakage.)

In the case of ceiling already exists

(1) Install unit temporarily

Put suspending bracket on the suspending bolt to hang the unit up. Be sure to use nut and washer at both end of the bracket to secure it firmly.

(2) Adjust the height and position of the unit.

(3) Proceed with procedure (4) of " In the case of no ceiling "

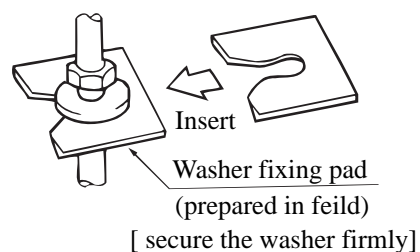
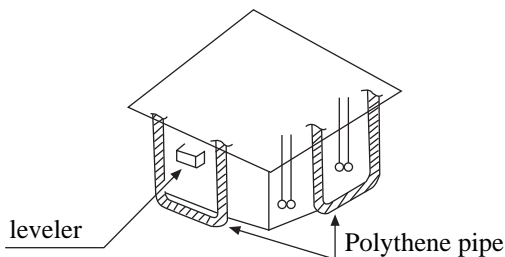
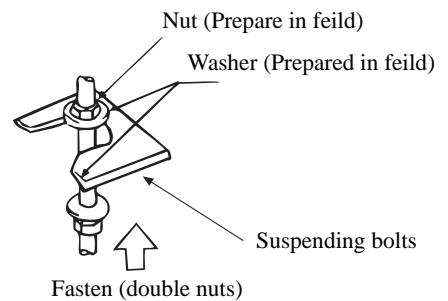

Installation Procedures

4. Installation of water drainage pipe

(1) Install water drainage pipe

- Pipe diameter shall be equal or larger than that of connecting pipe (Pipe of polythene; size: 25mm; O.D.: 32mm)
- Drainpipe should be short, with a downward slope at least 1/100 to prevent air bag from forming.
- If downward slope of drainpipe cannot be made, lifting pipe shall be installed.
- Keep a distance of 1-1.5m between suspending bolts, to make water hose straight.

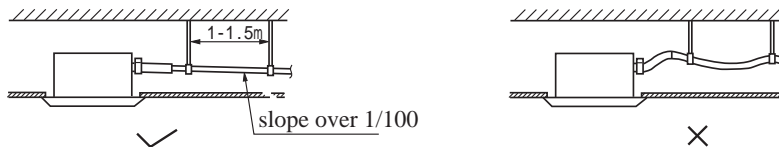

- Use the drainage hose and clip provided with unit.
Insert water pipe into water plug until it reaches the white tape.
Tighten the clip until head of the screw is less than 4mm from hose.
- Wind the drainage hose to the clip using seal pad for heat insulation.
- Insulate drainage hose in the room.

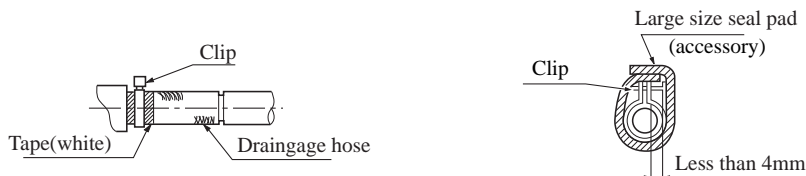

5. Cautions for the water drainage lifting pipe

- Installation height of water drainage lifting pipe shall be less than 280mm
- There should be a right angle with unit, 300mm from unit.

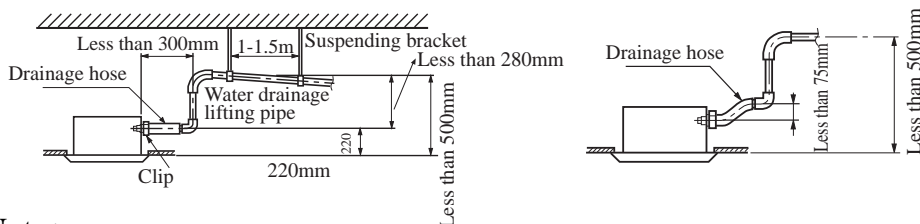

< Note >

- The slope of water drainage hose shall be within 75mm, make the drainage plug not to bear excessive force.
- If several water hoses join together, as per following procedures.



Specifications of the selected drainage hoses shall meet the requirements for the unit running

Installation Procedures

6. Installation of Ornament Panel

Install ornament panel on indoor unit

- (1) Check whether indoor unit is horizontal with leveler or polythene pipe filled with water , and check that the dimension of the ceiling opening is correct. Take off the lever gauge before install the ornament panel.
- (2) Fasten the screws to make the height difference between the two sides of indoor unit less than 5mm.
- (3) First fix it with screws temporarily.
- (4) Fasten the two temporally fixing screws and other two, and tighten the four screws.
- (5) Connect the wires of swing-motor.
- (6) Connect the wire of signal.
- (7) If no response of remote controller,check whether the wiring is correct,restart remote controller 10 seconds after shut off power supply.

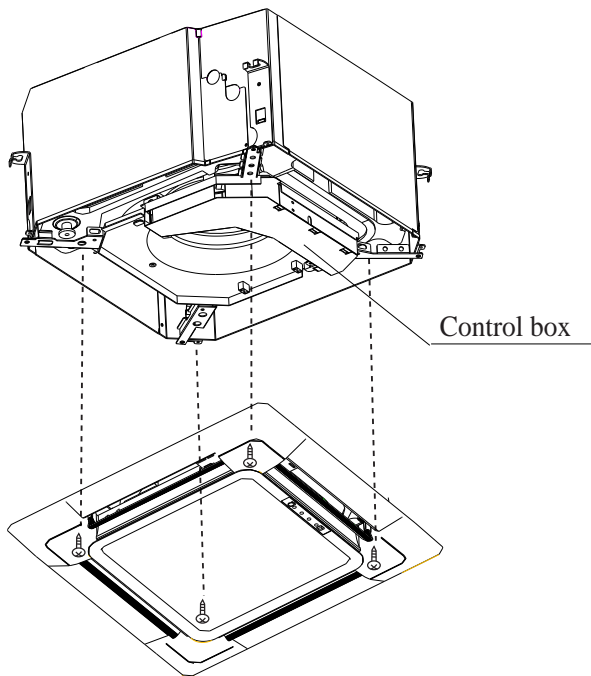

Limits of panel board installation

- (1) Install the panel board in the direction shown in the figure.
- (2) The incorrect direction will result in water leakage, meanwhile swing and signal receiving are displayed that cannot be connected.

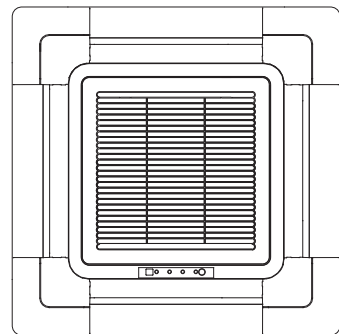

Installation Procedures

7. Piping Connection

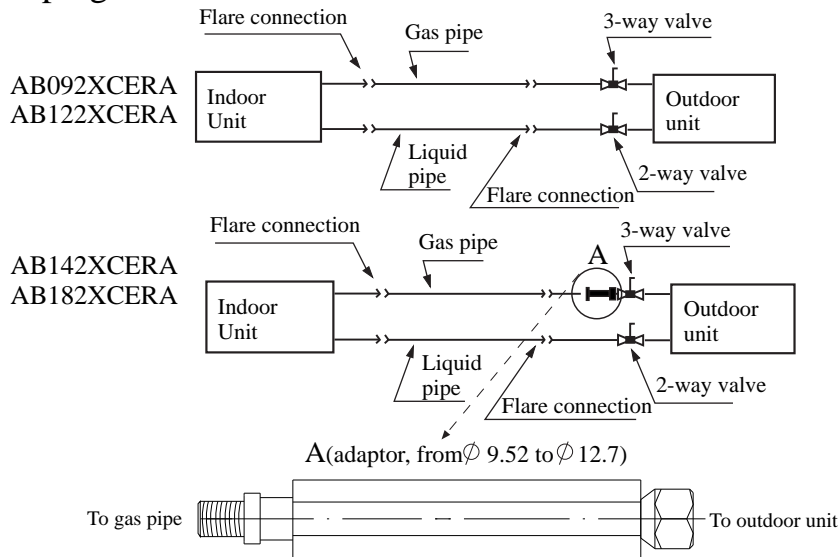

(1) Dimension of connecting pipe

AB092XCERA AB122XCERA	Gas pipe	ϕ 9.52mm
	Liquid pipe	ϕ 6.35mm
AB142XCERA AB182XCERA	Gas pipe	ϕ 12.7mm
	Liquid pipe	ϕ 6.35mm

- Fit the nut on and fasten

(2) The maximum length and drop height of connecting pipe

- The maximum length is 20m
- The maximum drop height is 10m.
- To ensure the efficiency, Pipes shall be as short as possible.

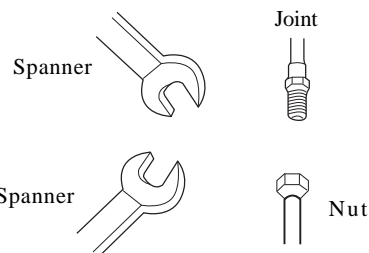
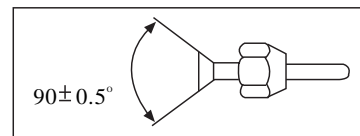

Cautions for piping connection

- Do not twist or deform the connecting pipe.
- Do not mix dusts.
- The bending radius shall be as large as possible.
- Both gas pipe and liquid pipe shall be heat insulation.
- No leakage in the flare.

(3) Piping connection

- Connecting method

Smear refrigerant oil on the joints of piping and flare. The bending radius shall be as large as possible. Align the pipe center when fastening, and tighten the nut, as shown in the figure. Pay attention to not mix foreign matters such as sands in.

Diameter of Pipe	Tighten Torque (N.m)
Liquid Pipe 6.35mm	11.8
Gas Pipe 9.52mm	40
Gas Pipe 12.7mm	49.0

If not aligned, tighten the nut by force will damage the nut that result in gas leakage

Installation Procedures

8. Electrical Wiring

Wiring methods:

① Wiring method of ring terminal

For connecting line which end is a ring, its wiring method as shown in the right figure: remove wiring screw and pass it through the end ring of connecting line, then connect it to the terminal block and tighten screw.

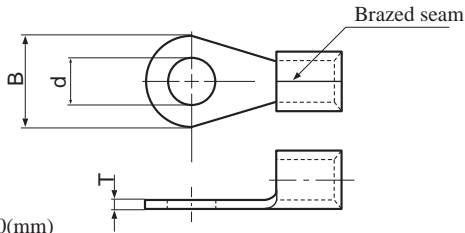

B=8.0-9.0(mm)
d=4.3-5.3(mm)
T=1.0-2.0(mm)
(For your reference)

Ring Terminal

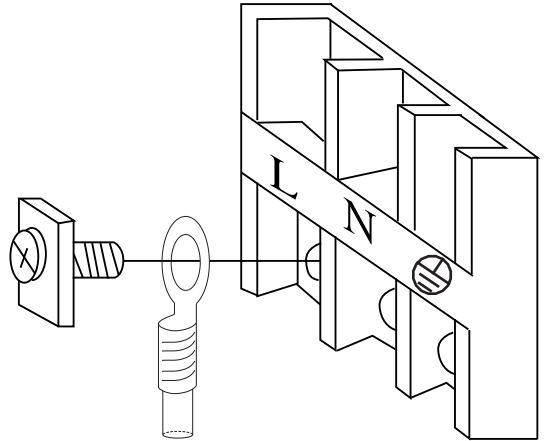

Wiring method of ring terminal

② Wiring of indoor unit

The distance between the signal wires and the power cables should be at least 50mm.

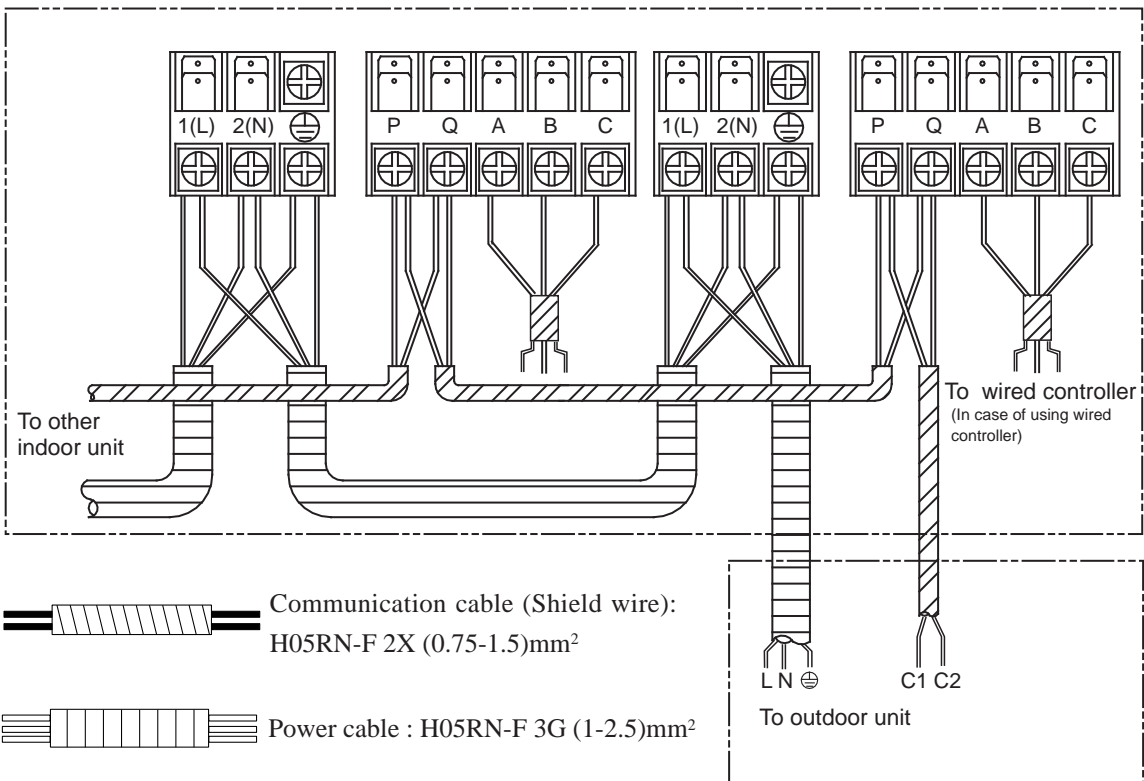

⚠ WARNING

1. Incorrect address setting will cause abnormal to the system.
2. Communication cable must be use shielded type.
3. Communication cable and power cable must be use ring terminal type.

Instructions to installation

9. Indoor unit communication addresses setting

CAUTION! FAIL TO DO THIS, THE UNIT WILL NOT WORK.

1. There are two methods to set the communication address

A. Use the remote controller (default status in first installation).

B. Use dip switches on the indoor unit PCB.

2. Address setting procedure when using the remote controller.

A. Set the addresses only after the successful installation of the refrigerant pipes and connecting cables, and open all the stop valves;

B. Please confirm that the indoor units and the outdoor unit in the same system use the same power source;

C. Power on the units, but put all the indoor units in the status of STANDBY;

D. Please note that the address must be set as following:

Indoor unit that connect to valve A, the address must be 1;

Indoor unit that connect to valve B, the address must be 2;

Indoor unit that connect to valve C, the address must be 3;

Indoor unit that connect to valve D, the address must be 4;

the LED board is blank.

E. Example: set unit A to address 1.

Continuously press the emergency switch for about 15 seconds, the buzzer will sound 4 times (PI PI PI PI) and then leave go of the switch. At this time, the indoor unit has entered the address setting procedure. But F. Use the controller to turn on the indoor unit. At this time, the controller should be changed from OFF to ON, and then the TIMER LED flashes once. That is to say, the address setting is enabled.

G. Press the button "SLEEP" on the controller, the times you press it stands for the address you want to set, detailed as following:

Press button "SLEEP" once, the address is "1", and the TIMER LED flashes once;

Press button "SLEEP" twice, the address is "2", and the TIMER LED flashes twice;

Press button "SLEEP" three times, the address is "3", and the TIMER LED flashes three times;

Press button "SLEEP" four times, the address is "4", and the TIMER LED flashes four times;

H. Use the remote controller to turn off the unit, At this time, the controller should be changed from ON to OFF, and the unit will exit the address setting procedure, the address will be memorized. The LED board will always display the address of this indoor unit until the system be powered off.

I. If you want to change the address, please repeat the above steps from E to G.

J. After setting all the addresses, please power off the system and then power on again. Otherwise the system will not start to work.

K. Once the addresses are successfully set, please do not change it any more to avoid confusion.

3. Address setting procedure when using the DIP switches SW01 and SW03.

A. The DIP switches SW01 and SW03 are on the indoor unit PCB.

B. Before carrying out the address setting work, the system must be powered off.

C. Take off the front panel and the filters, then take off the flaps and also the front cover, disconnect the swing motor connectors from the PCB and then take out the lower part of the PCB.

D. Change the position of DIP 7 of SW01 from OFF to ON, if fail to do this, the addresses set by SW03 will not work.

E. Use SW03 to set the addresses as following (DO NOT CHANGE OTHER DIP SWITCHES):

Instructions to installation

SW01	SW03	INDOOR UNIT ADDRESS																																																
<table border="1"> <tr><td>1</td><td>2</td><td>3</td><td>4</td><td>5</td><td>6</td><td>7</td><td>8</td></tr> <tr><td></td><td></td><td></td><td></td><td></td><td></td><td>■</td><td></td></tr> <tr><td></td><td></td><td></td><td></td><td></td><td></td><td></td><td></td></tr> </table> ON OFF	1	2	3	4	5	6	7	8							■										<table border="1"> <tr><td>1</td><td>2</td><td>3</td><td>4</td><td>5</td><td>6</td><td>7</td><td>8</td></tr> <tr><td></td><td></td><td></td><td></td><td></td><td></td><td></td><td></td></tr> <tr><td></td><td></td><td></td><td></td><td></td><td></td><td></td><td></td></tr> </table> ON OFF	1	2	3	4	5	6	7	8																	1
1	2	3	4	5	6	7	8																																											
						■																																												
1	2	3	4	5	6	7	8																																											
	<table border="1"> <tr><td>1</td><td>2</td><td>3</td><td>4</td><td>5</td><td>6</td><td>7</td><td>8</td></tr> <tr><td></td><td></td><td></td><td></td><td></td><td></td><td></td><td></td></tr> <tr><td></td><td></td><td></td><td></td><td></td><td></td><td></td><td></td></tr> </table> ON OFF	1	2	3	4	5	6	7	8																	2																								
1	2	3	4	5	6	7	8																																											
	<table border="1"> <tr><td>1</td><td>2</td><td>3</td><td>4</td><td>5</td><td>6</td><td>7</td><td>8</td></tr> <tr><td></td><td></td><td></td><td></td><td></td><td></td><td></td><td></td></tr> <tr><td></td><td></td><td></td><td></td><td></td><td></td><td></td><td></td></tr> </table> ON OFF	1	2	3	4	5	6	7	8																	3																								
1	2	3	4	5	6	7	8																																											
	<table border="1"> <tr><td>1</td><td>2</td><td>3</td><td>4</td><td>5</td><td>6</td><td>7</td><td>8</td></tr> <tr><td></td><td></td><td></td><td></td><td></td><td></td><td></td><td></td></tr> <tr><td></td><td></td><td></td><td></td><td></td><td></td><td></td><td></td></tr> </table> ON OFF	1	2	3	4	5	6	7	8																	4																								
1	2	3	4	5	6	7	8																																											

4. How to check the addresses?

When finish all the above works, please power off and power on again to the whole system but set all the indoor units in STANDBY. Then continuously press the emergency switch until you hear the buzzer sound 5 times (Pi Pi Pi Pi Pi), and then the TIMER LED board will show the address of this indoor unit. Press any key on the remote controller, it will exit the address checking procedure.



10. Setting method of temperature compensation (For heating function only)

Set method of temperature compensation (-8°C~6°C) in heating mode with the remote controller.

In 24°C heating mode, press sleep 7 times continuously. Indoor buzzer sounds 2 times, that show temp. compensation works. Switch on the unit in heating mode by the remote controller, press the time button to set the set temp. compensation. so the set temp. compensation = the current set temp. - 24°C. For example, if the set temp. is 24°C, the temp. compensation is 0°C; if the set temp. is 25°C, the temp. compensation is 1°C; if the set temp. is 30°C, the temp. compensation is 6°C; if the set temp. is 23°C, the temp. compensation is -1°C; if the set temp. is 16°C, the temp. compensation is -8°C; If setting is finished, press ON/OFF button, then the unit quits the temp. compensation.

Trouble Shooting

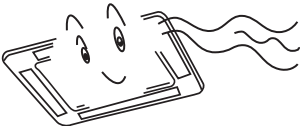
The followings are not malfunction

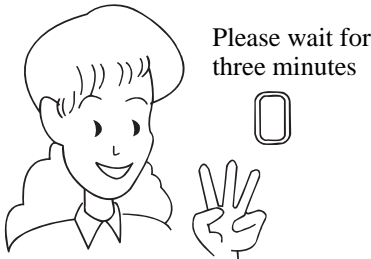
<p>Water flowing sound is heard</p> 	<p>When the air conditioner is started, when the compressor starts or stops during operation or when the air conditioner is stopped, it sometimes sounds like 'Bi-Bi' or 'Godo-Godo'. It is the flowing sound of the refrigerant, not a malfunction.</p>
<p>Cracking sound is heard</p>	<p>This is caused by heat expansion or contraction of plastics</p>
<p>It smells.</p>	<p>Air blown out from the indoor unit sometimes smells. The smell results from smells of furniture, paint, tobacco absorbed by indoor unit.</p>
<p>During operation, white fog comes out of indoor unit.</p> 	<p>When in COOL or DRY mode, a thin water fog can be seen blown out of unit, this is the condensed fog because the suddenly cooled indoor air is blown out.</p>
<p>Automatically switch into FAN mode during cooling.</p>	<p>To prevent frost from being accumulated on the indoor unit heat exchanger, it sometimes automatically switched into the FAN mode, but it will soon back to the cooling mode.</p>
<p>The air conditioner cannot be restarted soon after it stops. Air conditioner does not start?</p> 	<p>This is because of the self-protection function of the system, therefore, it cannot be restarted for about three minutes after it stops.</p> 

Trouble Shooting

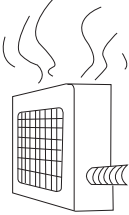
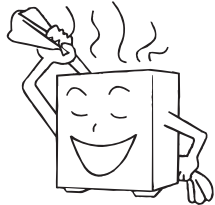
<p>Air does not blow or the fan speed cannot be changed during drying.</p>	<p>In DRY mode, when room temperature becomes 2°C higher than temperature setting, unit will run intermittently at LO speed regardless of FAN setting</p>
<p>Water or vapor generated from the outdoor unit during heating.</p> 	<p>This happens when the frost accumulated on the outdoor unit is removed (during defrosting operation).</p> <p>Defrosting operation</p> 
<p>During heating, indoor fan is still running even unit is stopped.</p>	<p>To get rid of the excess heat, indoor fan will continue running for a while after unit automatically stops.</p>

Please check the following things about your air conditioner before making a service call.

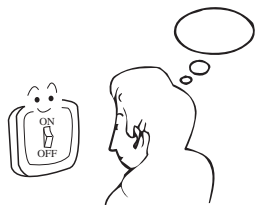
Unit fails to start.		
<p>Is the power supply switch on ?</p>  <p>Power supply switch is not in ON position.</p>	<p>Is city supply power normal ?</p> 	<p>Is the earth leakage breaker in action ?</p> <p>Be sure to turn off the power supply switch immediately and contact the sales dealer.</p>

Trouble Shooting

TROUBLE SHOOTING	FAILURE CODE (TIMER LED OF INDOOR RECEIVER BOARD FLASHES TIMES)	POSSIBLE REASONS
Faulty temperature sensor Tai	ONCE *	Sensor disconnected, or broken, or at wrong position, or short circuit
Faulty temperature sensor Tc1	TWICE *	Sensor disconnected, or broken, or at wrong position, or short circuit
Faulty temperature sensor Tc2	3 TIMES *	Sensor disconnected, or broken, or at wrong position, or short circuit
Faulty temperature sensor Tm	4 TIMES *	Sensor disconnected, or broken, or at wrong position, or short circuit
Faulty EEPROM on indoor unit PCB	5 TIMES	Faulty indoor unit PCB
Abnormal communication between indoor and outdoor unit	6 TIMES *	Wrong connection, or the wires be disconnected, or wrong address setting of indoor units, or faulty power supply or faulty PCB
Abnormal communication between wired controller and indoor unit PCB	7 TIMES *	Wrong connection, or use the wired controller be disconnected, faulty PCB
Drainage system abnormal	8 TIMES *	Pump motor disconnected, or at wrong position, or the float switch broken down or the float switch disconnected, or at wrong position
Indoor unit address repeated	9 TIMES	Wrong setting of indoor unit address
Central control address repeated	10 TIMES	Wrong setting of centralized control indoor unit address
Faulty indoor unit fan motor	11 TIMES	Fan is blocked, or the terminal is disconnected from the PCB, or faulty indoor unit PCB
Faulty driver of indoor unit fan motor	12 TIMES	Faulty indoor unit PCB
Abnormal communication between chip TMP/807 and chip TMP/846	14 TIMES *	Faulty indoor unit PCB
Malfunction on outdoor unit	20 TIMES	Check the outdoor unit failure code

Note:

1. Please contact the installers or distributors when trouble happens to repair it.
2. Turn the power off and power on again, if the failure code recurs, please inform the franchiser.
3. Failure codes marked with * are resumable.

HAIER GROUP

Qingdao Haier Air Conditioner Electric Co., Ltd.

Address: Haier Garden, Qianwangang Road, Economic Development Zone,
Qingdao, Shandong 266555, P.R.China

Web Site: <http://www.haier.com>

Free Manuals Download Website

<http://myh66.com>

<http://usermanuals.us>

<http://www.somanuals.com>

<http://www.4manuals.cc>

<http://www.manual-lib.com>

<http://www.404manual.com>

<http://www.luxmanual.com>

<http://aubethermostatmanual.com>

Golf course search by state

<http://golfingnear.com>

Email search by domain

<http://emailbydomain.com>

Auto manuals search

<http://auto.somanuals.com>

TV manuals search

<http://tv.somanuals.com>