

Haier

Condenser Tumble Dryer
HDY-D70-E

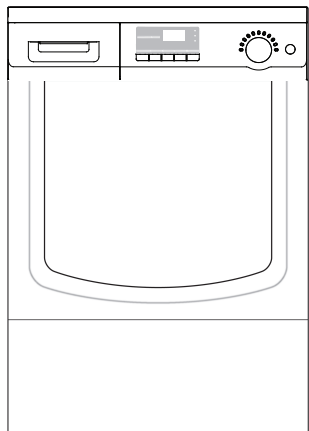

Table of Contents

Before using the dryer

Name of Parts.....1
 Important Safety Instructions2-3
 Installation.....4-6
 Preparation7

How to operate the dryer

Control panel.....8-9
 Programming guide.....10
 Drying methods11

Maintenance

Cleaning and maintenance12-13
 Trouble shooting14-15
 Wiring circuit16
 Specifications17

Name of Parts

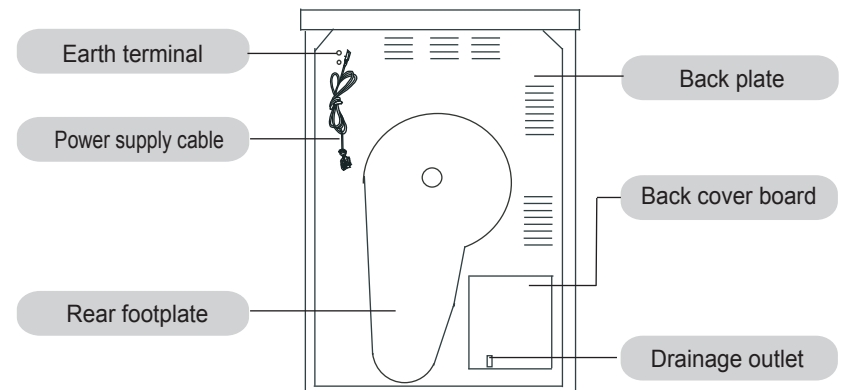
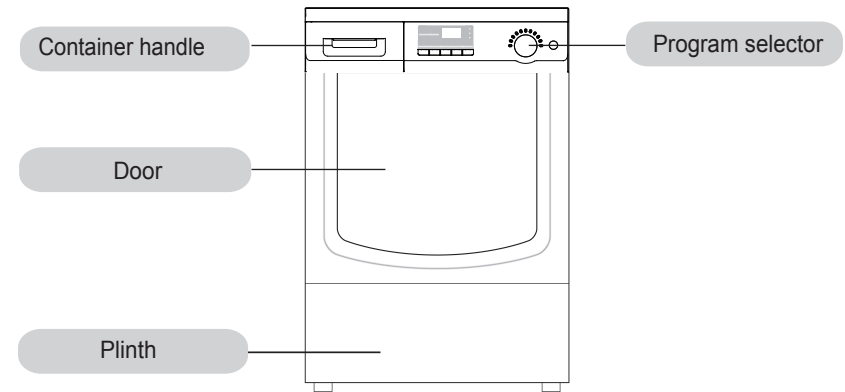

⚠ Warning Read all instructions before using dryer.
 Dryers are provided with operating, care and installations instructions

SAVE THESE INSTRUCTIONS

This diagram may be slightly different from the layout of the machine you have just purchased due to technical improvements

Important Safety Instructions

⚠ WARNING To reduce the risk of fire, electrical shock, or injury to persons when using this dryer, follow basic precautions, including the following:

1. Read all instructions before using this dryer.
2. Do not dry items that have been previously cleaned in, washed in, soaked in, or spotted with gasoline, cleaning solvents, kerosene, waxes, etc. Do not store these spotted with gasoline, cleaning solvents, kerosene, waxes, etc. Do not store these items on or near the dryer. These substances give off vapors that could ignite or explode.
3. This appliance is not intended for use by persons (including children) with reduced physical, sensory or mental capabilities, or lack of experience and knowledge, unless they have been given supervision or instruction concerning use of the appliance by a person responsible for their safety. Children should be supervised to ensure that they do not play with the appliance. Do not allow children to play on or in the dryer. Close supervision of children is necessary when the dryer is used near children.
4. Before the dryer is removed from service or discarded, remove the dryer door to prevent accidental entrapment.
5. To prevent injury, do not reach into the dryer if the drum is moving. Wait until the dryer has stopped completely before reaching into the drum.
6. Do not install or store this appliance where it will be exposed to water and /or the weather.
7. Do not tamper with controls.
8. Do not repair or replace any part of the appliance or attempt any servicing unless specifically recommended in the user-maintenance instructions or in published user-repair instructions that you understand and have skills to carry out.
9. To prevent fire, do not use heat to dry items containing plastic, foam, rubber or similarly textured rubber-like materials, or items containing feathers or down.
10. Do not place items exposed to cooking oils in your dryer. Items contaminated with cooking oils may contribute to a chemical reaction that could cause a load to catch fire.
11. Clean lint screen before or after each load.
12. This dryer must be properly installed in accordance with the installation instructions before it is used.
13. To prevent shock hazard and assure stability during operation, the dryer must be installed and electrically grounded by a qualified service person in accordance with local codes.
14. Always disconnect dryer from electrical supply before attempting any service. Disconnect power cord by grasping the plug, not the cord.
15. The dryer must only be used for its intended purpose.
16. Do not sit on top of the dryer.

Important Safety Instructions

17. If the supply cord is damaged, it must be replaced by the manufacturer, its service agent or similarly qualified persons in order to avoid a hazard.
18. Do not operate the dryer if any parts are missing or broken.
19. Do not store or use gasoline or other flammable vapors and liquids in the vicinity of the appliance.
20. Keep surrounding areas free from the accumulation of lint, dust and dirt.
21. Avoid fire hazard or electrical shock. Do not use an adaptor plug or extension cord or remove grounding prong from electrical power cord. Failure to follow this warning can cause serious injury, fire or death.
22. Do not dry unwashed items in the tumble dryer.
23. Items that have been soiled with substances such as cooking oil, acetone, alcohol, petrol kerosene, spot removers, turpentine, waxes and wax removers should be washed in hot water with an extra amount of detergent before being dried in the tumble dryer.
24. Items such as foam rubber (latex foam), shower caps, waterproof textiles, rubber backed articles and clothes or pillows fitted with foam rubber pads should not be dried in the tumble dryer.
25. Fabric softeners, or similar products, should be used as specified by the fabric softener instructions.
26. The final part of a tumble dryer cycle occurs without heat (cool down cycle) to ensure that the items are left at a temperature that ensures that the items will not be damaged.

WARNING: Never stop a tumble dryer before the end of the drying cycle unless all items are quickly removed and spread out so that the heat is dissipated.

Installation

- Dimensions
 a = 855 mm
 b = 620 mm
 c = 595 mm
 Weight = 43 kg

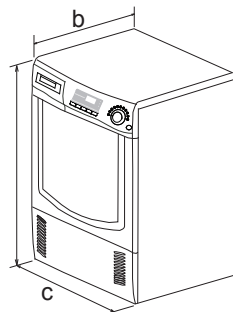

● Packing accessories

Checklist of the accessories and materials provided with the machine:

Name	Owner's manual	Certificate of Conformity	Drainpipe
Quantity	1	1	1

- To ensure the dryer operates normally, attention must be paid to the following instructions;
 - The dryer must be level when installed. Its bottom is equipped with adjustable feet. Adjust these 4 feet to level the unit before operation;
 - Check whether there is any damage to the dryer during transportation. Any damaged dryer must not be used. If the unit is damaged, contact your dryer supplier;
 - The dryer must be kept away from flammable substances;
 - The surrounding environment must be dry and ventilated;
 - To allow the dryer to perform better, the ambient temperature shall not be lower than 10°C nor higher than 35°C.

Installation

● Change the door-opening direction

If the direction of the dryer's door is not suitable to the location, its opening direction may be changed. The procedure is as follows:

1. Unscrew the 4 hinge screws holding the door onto the machine and remove the door.
2. Unscrew the door catch 6 and prise out the catch cover on the opposite side of the door and transpose them.
3. Unscrew the door hinges and prise out the hinge covers on the opposite side of the door and transpose them.
4. Remove the 4 blanking plugs from the screw holes on the machine and insert them in the holes on the other side.
5. Refit the door on the opposite side of the machine.

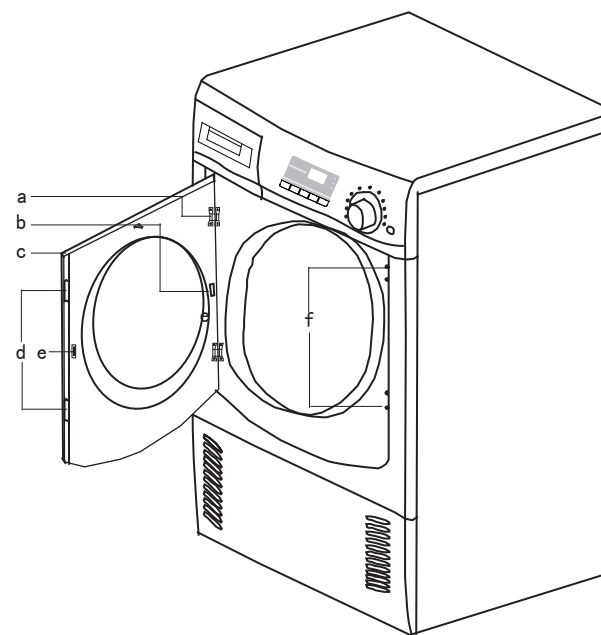

a-door hinge b-catch cover c-door
 d-hinge cover e-door catch f-blanking plug

Installation

● Drain switchover

During the drying of the laundry, the condensate water is automatically collected in the box inside the machine, so that the water needs to be removed from the box after every drying cycle. If your dryer is in the vicinity of a drain, you may allow the condensed water to discharge directly into the drain through the drainpipe provided to avoid emptying the box every time.

The method to connect the drainpipe is as follows:

1. Loosen the hose clip with the drain switchover joint;
2. Pull the hose off the joint;
3. Install the accessory drainpipe on the joint;
4. Fix the hose in place with the clip;

Note: The outlet of the drainpipe must not be higher than 1.0 m above the floor

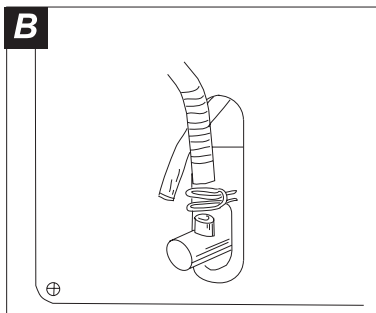
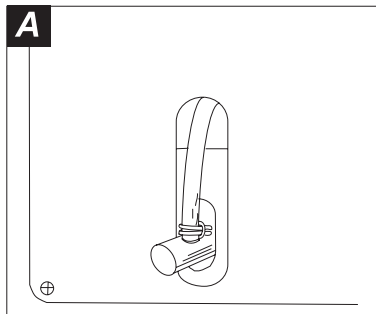

Preparation

● Attention

- Before use, clean any deposits from inside the drum of the dryer with a wet towel;
- Clean debris on the filter screen to increase the drying efficiency.

● Turning on power

Before turning on the power for the dryer, check:



- Whether the supply voltage is in accordance with the value indicated on the nameplate;
- Whether the supply receptacle can withstand the maximum power load to the dryer;
- Whether the supply receptacle is in accordance with the plug of the dryer. If not, replace the power supply cable or receptacle to make them accord with each other; The replacement of the power supply cable must be made by a qualified professional or our authorized service agent;
- The dryer must be grounded securely.

● Treatment of laundry to dry

- Check whether the laundry to be dried is suitable to be dried in the dryer;
- The dryer can only dry the laundry that has been spun dry. Do not put too wet laundry into the machine;
- Empty all pockets of the laundry with such items as keys and coins and remove the adornment that is not suitable to be dried;
- Pull up zippers, sew and mend up loosened fasteners and tie up dispersed ribbons to prevent the laundry from being entangled. If necessary, put small items into a net.
- To achieve a better drying result, shake the heavy laundry and make it loose before load it into the dryer.

● Load to dry

Make sure that the laundry you are going to dry is suitable for drying in a dryer. You will find information on this on the laundry labels. The following symbols mean:

		
Dry at normal temperature	Dry at reduced temperature	Drying in the tumble dryer not possible

Warning: Do not dry wool, silk, down and other delicate fabrics to avoid damage to fabrics.

Control Panel

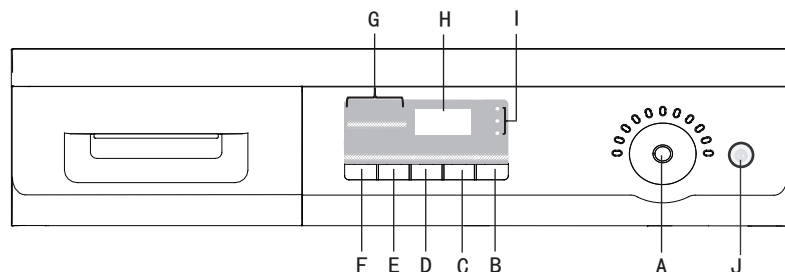

A - Program knob

Turn this knob to choose the drying program you desire. This type of dryer has 11 program options. For description of specific programs, refer to the list of programs on Page 10. When the drying program is selected, the relevant indicator light is on.

B - Start/Pause button

Gently touch this button to start the dryer. Gently touch this button again during the operation of the dryer and the indicator light and display screen will flash and the machine will be paused. Press the button again and the program will continue.

C - Signal button

When the drying cycle has finished, an intermittent acoustic signal will sound. Touch this button, the buzzer will be canceled.

D- Anti-crease button

If this additional function is selected, the anti-crease phase at the end of the drying cycle is lengthened by 60 minutes. The laundry can be removed at any time during the anti-crease phase.

E - Delicate button

During a program, the drying temperature and power will decrease and the drying time will increase to take better care of the delicate laundry.





F- Delay button

Gently touch this button before a program starts. You may choose to start the dryer after a preset time. The delay range is between 1 and 19 hours. Every touch of the delay button will increment by one hour. When you pass 19 hours, the delay time will turn off. After a delay time is set, gently touch the Start/Pause button to start the delay operation and the indicator light will flash.

Control Panel

G - Programme progress display

Depending on the programme selected, the drying stage reached is shown by the indicator lamps on the control panel:

-  - Drying
-  - Ready to iron
-  - Airing
-  - End/Anti-crease



At the end of a programme, the End/Anti-crease indicator lamp comes on. The drum will continue to rotate at intervals to prevent laundry creasing, if you do not wish to remove it immediately.

H - LED screen

The screen displays the remaining time for a program, the delay time and other related information.

Note: The remaining time to start a program is the default time for the program. During operation, with variation of factors such as the moisture content. The actual remaining time will be automatically adjusted until the preset drying result has been achieved and the program is complete.

I - Maintenance displays

-  - Empty tank
-  - Clean filter
-  - Clean condenser

Important: After each drying cycle,

- Clean the filter;
 - Drain the condensed water container;
- (See section "Cleaning and maintenance")





J - Power Button

When the machine is plugged, press this button to switch on the dryer. Press it again to switch it off.

D+E composite button and child lock function

During a program, press and hold down both buttons for 3 seconds to set up the child lock function if necessary. At this time, The display screen shows the remaining time and the lock alternatively, and the control panel will lock. Press and hold down both buttons for 3 seconds once again and the child lock will release. When the program is end or the power off during the program, the child lock will release.

Programming Guide

Program	Degree of drying	Max. load	Type of Laundry
			
 *	Extra dry	7 kg	Heavy cotton fabrics, sheets, gowns.
	Ready to wear	7 kg	Cotton fabrics, sheets, coats
	Ready to iron	7 kg	Ordinary cotton fabrics
	Damp	7 kg	Ordinary cotton fabrics
			
	Ready to wear	3 kg	Ordinary synthetic fabrics
	Ready to iron	3 kg	Ordinary synthetic fabrics
			
20	Timer 20 min	7 kg	Heavy fabrics, needing further drying.
40	Timer 40 min	7 kg	
60	Timer 60 min	7 kg	
	Refresh/Airing	7 kg	/
	One piece	0.5 kg	/
* Programme setting for testing in accordance with EN 61121.			

Drying Methods

1. Turning on power

Insert the power plug into an appropriate wall socket and turn on the power.
Operating power supply: (220-240)V/50Hz.

2. Laundry loading

Open the door and place the laundry into the drum of the dryer. To save energy and achieve a better drying result, please spin the laundry as dry as possible. Place the laundry evenly into the drum after shaking them loose.
Note: Do not put excess laundry into the dryer to avoid damage to the dryer and laundry.

Reference weight of fabrics for drying

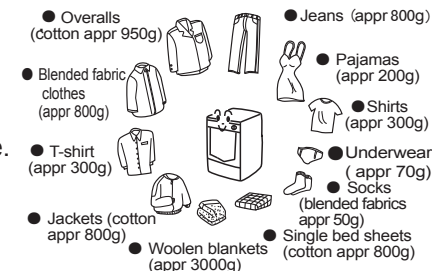

3. Setting drying program

Turn the program knob to set an optimal drying program according to the laundry type and the drying result required.

4. Selecting additional functions

According to you desire, select the additional function:
- Start Delay,- Delicate,- Anti-crease,- Signal Off.

5. Program operation

After a program is set, gently touch the Start/Pause button to start the program

6. Program completion

Before the drying program ends, the dryer will enter the cold air cycle. After the program is complete, the display screen will display "End." Open the door to remove the laundry. If the laundry is not removed after the drying program is complete, the dryer will start the anti-crease protection cycle automatically. In the anti-crease protection cycle, the dryer's drum will run at a set interval to keep your laundry loose.

7. Turning off the dryer

Press the power keystroke to cut off the power supply and turn off the dryer at the wall socket.

Cleaning and Maintenance

1. Cleaning the surface

Wipe the body of the dryer and the control panel with a damp cloth. Remember not use any organic solvent or corrosive agent to avoid damage to the machine.

2. Cleaning the filter screen

To ensure a good ventilation during drying, the filter screen must be cleaned after every drying program is complete.

Open the door and remove the filter screen from the machine. Open the screen and clean off the dust on the screen with a wet towel. After cleaning, put the screen back in place.

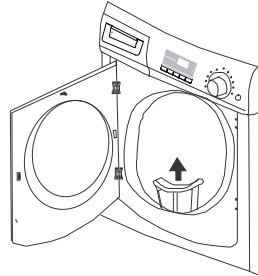

3. Emptying the water collection box

During operation, steam condenses into water and is collected in the box. The box must be emptied after the program is complete.

-Hold the handle and pull the box outwards to remove it. Keep it level to prevent the water from overflowing;

-Pour away water. Note: the water can not be used for drink or for food processing;

-Put the box back in place. If the box has not been emptied, the dryer will sound an alarm when the box is full. The indicator light comes on while the box is emptied and the dryer will stop. It will not restart until the box is emptied.

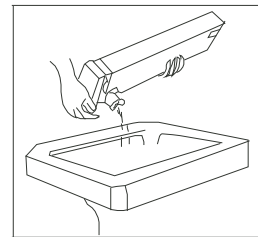
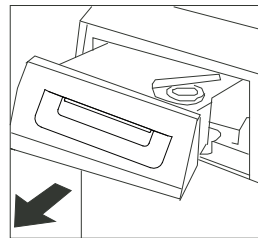

4. Cleaning the condenser

The condenser must be cleaned monthly. Switch off the power supply before cleaning.

-Hold the protrusions on both sides of the lower deco panel and open it.

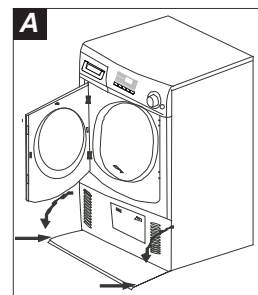

Cleaning and Maintenance

-Using a coin or other tool, push the slides on the cover to the position as shown in the figure and then remove the cover;

-Turn the condenser's handle 90 degrees in the direction as shown in the figure;

-Remove the condenser from the dryer;

-Clean the condenser with a brush or flush with by a water jet;

Note: Do not use a sharp tool in cleaning the heat exchanger, otherwise it may damage its sealing performance;

-Put the condenser back in place and lock up the cover;

-Put the lower deco panel back in place.

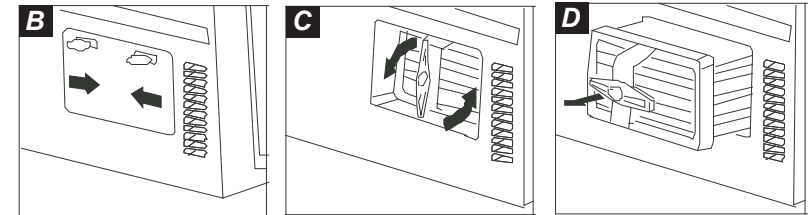

5. Cleaning the drum

After the dryer has operated for a time, fabric caring agents or calcium contained in the water will form an almost invisible layer on the inside of the drum.

This makes the dryer not able to reliably and accurately identify the dryness of the laundry. So the inside of the drum, especially the stainless steel pieces on the blades must be cleaned regularly by a wet cloth.

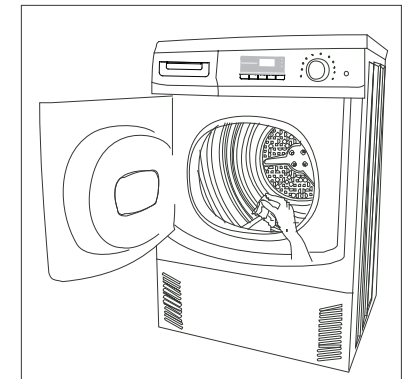

Trouble Shooting

The following must be confirmed before calling for service:

Problem	Possible Cause
The dryer does not start	<ul style="list-style-type: none"> • Is the power supply plugged in and switched on. • Plug another appliance into the wall socket to test if there is power. • Is the door closed tightly; • Check if a drying program has been set; • the Start/Pause button has been pressed; • The water collection box is full;
The drying result is not good and the drying time is too long.	<ul style="list-style-type: none"> • Is the drying program setting correct; • Has the filter screen been cleaned ; • Is the condenser blocked; • Does the amount of the loaded laundry exceed the rated load; • Has the loaded laundry been spun dry; • Is the vent duct blocked; • Has the surface of the inside of the drum got a deposit layer forming, if so clean the drum interior;
The remaining time display is halted, or the remaining time displayed is skipping	<p>The remaining time will be adjusted and corrected continuously and automatically based on the following factors:</p> <ul style="list-style-type: none"> • Type of laundry; • Loaded amount; • The degree of spinning dry of laundry; • Ambient temperature; <p>The automatic adjustment is a normal operation.</p>

Trouble Shooting

Prompt and Alarm Information

In case of an improper operation or trouble with the machine when it operates, the code corresponding to the trouble will be displayed on the screen:

Code	Category	Cause	Solutions
E2	Trouble code	There is no change in the temperatures of the laundry in the tub	Contact a professional serviceman
E3	Trouble code	The laundry not dried	Contact a professional serviceman
E5	Trouble code	The thermal sensor open-circuited or short circuited	Contact a professional serviceman
E6	Trouble code	Drain pump fails	Contact a professional serviceman

Wiring Circuit

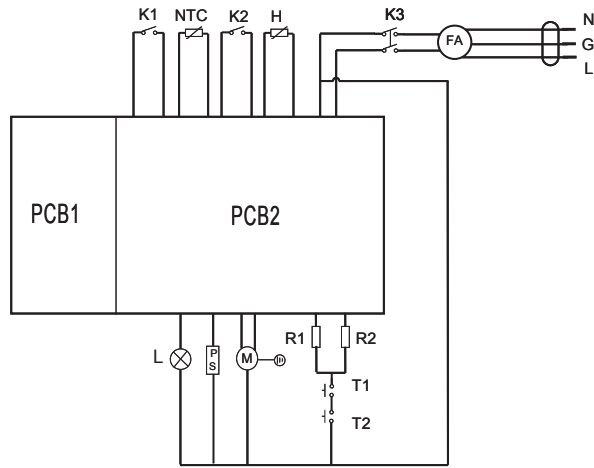

FA-Electromagnetic interference inhibitor

R1-Heating1 R2-Heating2

T1- Thermal cut-out T2- Thermostat NTC- Temperature sensor

PS- Drainage pump M- Motor H- Humidity sensor

K1- Door switch K2- Level switch K3- Power switch

PCB1、 PCB2- Printed circuit board

Specifications

Item	Type	LHDY-D70-E
Power supply		(220-240)V/50Hz
Maximum operating current(A)		12
Rated load(kg)		7
Drying program		11
Maximum power(W)		2800
Dimensions(H×D×W)mm		855×620×595



The symbol  on the product or on its packaging indicates that this product may not be treated as household waste. Instead it shall be handed over to the applicable collection point for the recycling of electrical and electronic equipment. By ensuring this product is disposed of correctly, you will help prevent potential negative consequences for the environment and human health, which could otherwise be caused by inappropriate waste handling of this product. For more detailed information about recycling of this product, please contact your local city office, your household waste disposal service or the shop where you purchased the product.

Free Manuals Download Website

<http://myh66.com>

<http://usermanuals.us>

<http://www.somanuals.com>

<http://www.4manuals.cc>

<http://www.manual-lib.com>

<http://www.404manual.com>

<http://www.luxmanual.com>

<http://aubethermostatmanual.com>

Golf course search by state

<http://golfingnear.com>

Email search by domain

<http://emailbydomain.com>

Auto manuals search

<http://auto.somanuals.com>

TV manuals search

<http://tv.somanuals.com>