

Haier

Dishwasher
DW12-TFE4SS
DW12-TFE4WH
Instructions for Use

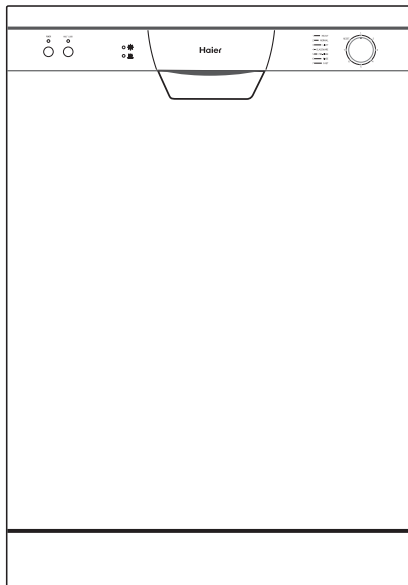

0120505780

Index

Safety information	2
Installation	4
Getting to know your dishwasher	6
How to fill the rinse aid and the detergent dispenser	7
Not suitable for the dishwasher	8
Arranging crockery, glasses, etc. in the dishwasher	9
Programme overview	11
Washing dishes	12
How to keep your dishwasher in shape	14
Care and maintenance	15
Fault finding	16
Technical data	19
Important information	20

Safety information

At time of delivery

- Check packaging and dishwasher immediately for signs of transport damage. If the appliance is damaged, do not put it into use but contact your supplier or customer service without delay.
- Please dispose of packaging materials properly.

During installation

- Site the dishwasher and connect it up in accordance with the installation instructions.
- The dishwasher must not be connected to the electricity supply while installation is being carried out.
- Ensure that the domestic wiring is properly earthed.
- The mains electricity supply must conform to the details shown on the dishwasher nameplate.
- Do not connect the dishwasher to the electricity supply via an extension cable.
- After the appliance has been installed, the mains plug should still be easily accessible.
- During installation, the power supply cord must not be excessively or dangerously bent or flattened.

During normal use

- The dishwasher must only be used by adults for the washing of household dishes and cooking utensils.
- This appliance cannot be installed outdoor, not even if the area in which it is installed is covered by a roof; it is also very dangerous to leave it exposed to the rain and elements.
- Do not place any heavy objects or stand on the door when it is open. The appliance could tip forward.
- The water inside the dishwasher is not suitable for drinking.
- Do not use solvents of any kind inside your dishwasher. They could cause an explosion danger.
- Open the door very carefully if the dishwasher is operating. There is a risk of water squirting out.
- Do not touch the heating element during or after a wash cycle.
- Fundamental rules to follow when using the appliance:
 - Never touch the dishwasher when barefoot or with wet hands or feet;
 - We discourage the use of extension cords and multiple sockets;
 - If the appliance is not operating properly or maintenance must be performed, disconnect the appliance from the power supply.

If your family includes children

- Keep detergents out of the reach of children, who must also be kept away from the dishwasher when it is open.



The appliance is not for use by young children of infirm persons without supervision. Young children should be supervised to ensure that they do not play with the appliance.

If a fault occurs

- If the appliance malfunctions, turn off water supply to the appliance and disconnect the plug from the wall socket. Then, consult the section entitled, "Finding fault" .If you cannot solve the problem, contact a service center.
- To maintain the EFFICIENCY and SAFETY of this appliance,we recommend:
 - call only the Service Centers authorized by the manufacturer.
 - always use original Spare Parts.



If the supply cord is damaged, it must be replaced by the manufacturer or its service agent or a similarly qualified person in order to avoid a hazard.

When disposing of old appliances

- Appliances which are no longer being used must be made inoperable by cutting the power supply cord and removing the door lock.
- Take the appliance to a designated waste disposal center.



Dangerous voltage



Children could get locked in the appliance (risk of suffocation) or get stuck in other positions. Therefore: Remove the mains plug, cut the mains wire and set aside. Damage the door lock so that the door can no longer be closed.

Installation

Positioning the appliance

Positioning the appliance in the desired location. The back should rest against the wall behind it, and the sides, along the adjacent cabinets or wall. The dishwasher is equipped with water supply and drain hoses that can be positioned to the right or the left to facilitate proper installation.

Levelling the appliance

Once the appliance is positioned, adjust the feet (screwing them in or out) to adjust the dishwasher, making it level. In any case, the appliance should not be inclined more than 2°. If the appliance is level, it will help ensure proper performance.

Cold water connection

Connect the water supply hose to a threaded 3/4" bsp connector, making sure that it is fastened tightly in place (see fig.A).

If the water pipes are new or have not been used for an extended period of time, let the water run to make sure that the water is clear and free of impurities. If this precaution is not taken, there is a risk that the water inlet can get blocked and damage the appliance.

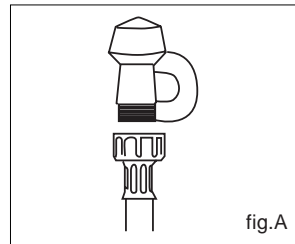

The appliance is to be connected to the water mains using new hose-sets and that old hose-sets should not be reused. Water pressure 0.03-1.0MPa. A Pressure limiting valve is required where water pressure exceeds 1.0MPa.

Drain hose connection

Insert the drain hose into a drain pipe with a minimum diameter of 4cm, or let it run into the sink, making sure to avoid bending or crimping it. If necessary, fit a syphon trap (U-bend) with a connecting piece for the drain hose (fig.B). The free end of the hose must be at a height between 40 and 100cm and must not be immersed in water.

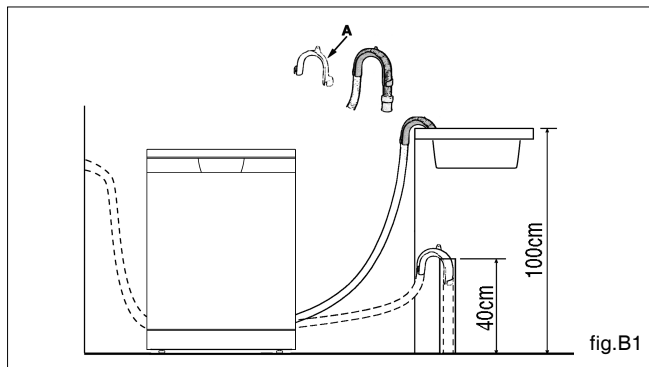

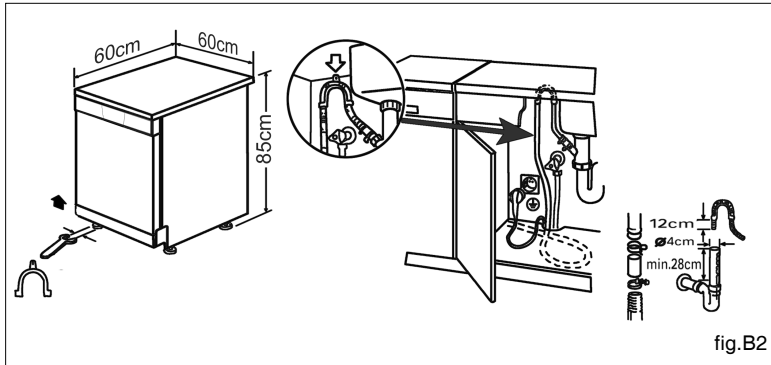

The connecting piece for syphon trap (U-bend) must be solidly fastened to the wall to prevent the drain hose from moving and allowing water to spill outside the drain.

Electrical Connection

After making sure that the voltage and frequency values for the current in the home correspond to those on the rating plate (located on the stainless steel inner door of the appliance) and that the electrical system is correct for the maximum voltage on the rating plate, insert the plug into an electrical socket which is earthed properly (the earthing of the appliance is a safety requirement mandated by law).

If the electrical socket to which the appliance must be connected is not appropriate for the plug, replace the whole cable, rather than using adaptors or the like as they could cause overheating and burns.



The dishwasher plug must be accessible even when the appliance is installed as a built-in unit so that maintenance can be done safely.

Getting to know your dishwasher

Close-up view (control panel)



- | | |
|-----------------------------|--|
| A "POWER" Light | E Low Rinse Aid Indicator Light |
| B "POWER" Button | F Heat Indicator Light |
| C "HALF LOAD" Light | G Knob For Selecting Cycle |
| D "HALF LOAD" Button | |

Dishwasher interior

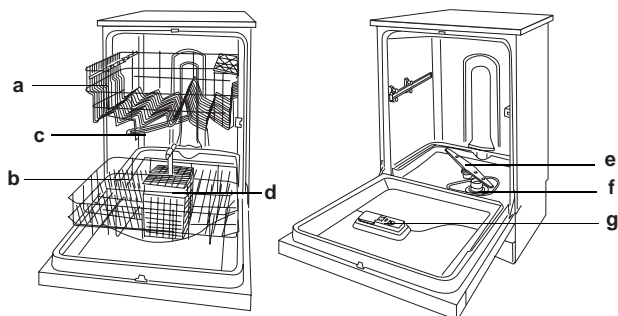

- | | |
|----------------------------|--|
| a Upper Rack | e Bottom Spray Arm |
| b Lower Rack | f Washing Filter |
| c Top Spray Arm | g Detergent and Rinse Aid Dispenser |
| d Silverware Basket | |

How to fill the rinse aid and the detergent dispenser

Rinse aid

This product makes dishes sparkle and helps them to dry without spotting. The dispenser is located on the inside panel of the door.

- When the low rinse aid indicator lights, you must load rinse aid.

Loading the rinse aid

Regardless of the type of detergent dispenser installed on your appliance, you must proceed as indicated below when loading the rinse aid.

To open the dispenser, turn the "1" cap in an anti-clockwise direction and then pour in the rinse aid, making sure not to overfill. The amount of rinse aid used for each cycle can be regulated by turning the "2" dose adjuster, located beneath the "1" cap, with a screwdriver. There are 6 different settings; the normal dosage setting is 2.

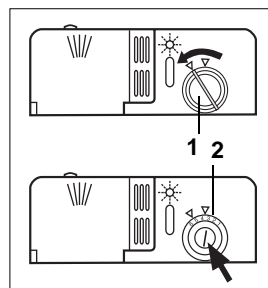

Proper dosage of the rinse aid improves drying. If drops of water remain on the dishes or spotting occurs, the dosage adjuster should be turned to a higher setting. If the dishes have white streaks, turn the dosage adjuster to a lower setting.

Detergent

Detergent specifically intended for use with dishwashers must be used. The dispenser must be refilled before the start of each wash cycle following the instructions provided in the "Programme overview". The detergent dispenser is located on the inside panel of the door.

Loading the detergent

- To open the "3" cover on the dispenser, press the "4" button.
- The detergent for the wash cycle should be poured into the "5" compartment.
- The detergent for the pre-wash cycle should be poured into the "6" compartment.
- After the detergent has been placed in the dispenser, close the cover and press down until it clicks in place.

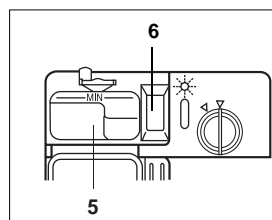
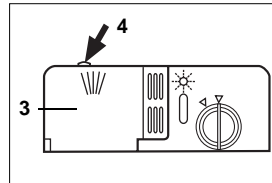

To facilitate closing the cover, remove any excess detergent on the edges of the dispenser. Dishwasher detergents are strongly alkaline. They can be extremely dangerous if swallowed. Avoid contact with the skin and eyes and keep children away from the dishwasher when the door is open. Check that the detergent receptacle is empty after completion of the wash cycle.

Not suitable for the dishwasher

What you should not put into the dishwasher

Cutlery and tableware manufactured in whole or part from wood. They become faded and unsightly in appearance. Furthermore, the adhesives that are used are not suitable for the temperature that occur inside the dishwasher. Delicate decorative glassware and vases, special antique or irreplaceable china. The decorative patterns on such items will not be dishwasher-proof.

Plastic objects that are not resistant to hot water, copper and pewter utensils are also not suitable. Decorative patterns printed or painted onto the surface of crockery, glasses, etc., aluminium and silver items tend to become discoloured or faded if washed in the dishwasher. Some types of glass can become opaque in appearance after they have been washed many times in a dishwasher. Highly absorbent materials, such as sponges and towels, should never be placed in the dishwasher.

Our recommendation

In future, only purchase table or kitchenware that has been confirmed as being dishwasher-proof.



Dishes or cutlery that have been soiled by tobacco ash, wax, lubricating grease or paint, should not be put in the dishwasher.

Damage to glassware and other dishes

Possible causes

- type of glass or manufacturing process
- chemical composition of detergent
- water temperature and duration of dishwasher programme.

Suggested remedy

- Use glassware or porcelain dishes that have been marked 'dishwasher-proof' by the manufacture.
- Use a mild detergent that is described as 'kind to dishes'. If necessary, seek further information from detergent manufacturers.
- Select a programme with a low temperature and a short duration as possible.
- To prevent damage, take glass and cutlery out of the dishwasher as soon as possible after the programme has ended.

Arranging crockery, glasses, etc. in the dishwasher

Before placing the dishes in the dishwasher, remove larger food particles to prevent the filter from becoming clogged, which results in reduced performance.

If the pots and pans have baked-on food that is extremely hard to remove, we recommend that they are soaked before washed. This will eliminate the need for extra wash cycles.

Pull out the rack to load the dishwasher.

How to use the lower rack

We recommend that you place the most difficult to clean items on the bottom rack: pots, pans, lids, serving dishes and bowls, as shown in the figure to the right.

It is preferable to place serving dishes and lids on the sides of the racks in order to avoid blocking the rotation of the top spray arm.

- Pots, serving bowls, etc. must always be placed face down. (see fig.C)
- Deep pots should be slanted to allow the water to flow out.
- The silverware basket can be doubled (see fig.D) so that only one section may be used when the silverware load is light. This also makes space for additional pots and pans and it can also be placed in the upper rack.
- Silverware should be placed in the silverware basket with the handles at the bottom; if the rack has side baskets, the spoons should be located individually into the appropriate slots. Especially long utensils should be placed in the horizontal position at the front of the upper rack. (see fig.D)

Load for 12 Standard Settings
(for AS/NZS 2007 tests)

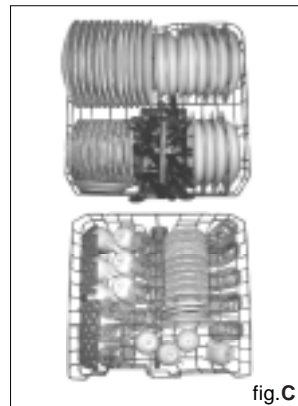

fig.C

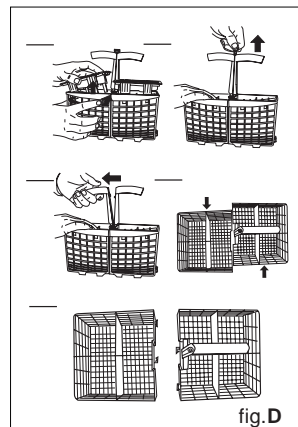

fig.D



Knives and other utensils with sharp points must be loaded in the basket with their points down or placed in a horizontal position.

How to use the upper rack

The upper rack is designed to hold more delicate and lighter dishware, such as glasses, cups and saucers, plates, small bowls and shallow pans (as long as they are not too dirty).

- Position the dishes and cookware so that they do not get moved by the spray of water.
- The upper rack can be adjusted for height by using the knobs located on both sides of the rack itself (see fig.E).

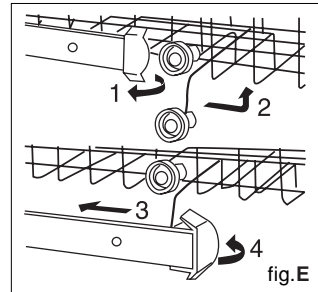

Adjust the upper basket to the higher level and you have more space to accommodate those taller pans and trays in the bottom basket.

Shelf

Lean tall glasses and those with long stems against the shelf-not against other items to be washed.

Place glasses, cups and small bowls on the additional cup rack. The additional cup rack can be swivelled in or out as required (see fig.F).

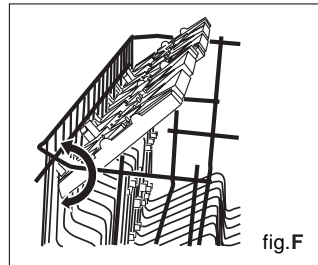

Programme overview

Wash programme	Types of load	Description of cycle	1/2 Load	Detergent		Rinse Aid
				Prewash	Extended Wash	
HEAVY	Very dirty dishes, pots and pans. (Not to be used with delicate items.)	Pre-wash with hot water. Extended wash at 70°C. Rinses with cold water. Rinse with hot water. Drying.	—	5g	25g	●
			●	5g	15g	●
NORMAL (AS/NZS 2007)	Normal load of dirty dishes, pots and pans, Standard daily cycle.	Prewash use cold water. Extended wash at 50°C. Rinse with cold water. Rinse with hot water. Drying.	—	5g	25g	● (*)
			●	5g	15g	●
LIGHT	Lightly soiled delicate items.	Prewash use cold water. Extended wash at 50°C. Rinse with cold water. Rinse with hot water. Drying.	—	5g	25g	●
			●	5g	15g	●
GLASSWARE	Economic cycle for delicate items. Run immediately after dishes are used.	Wash at 45°C. Rinse with cold water. Hot rinse. Drying.	—	—	25g	●
			●	—	15g	●
QUICK 30	Very lightly soiled mixed dishes.	Short wash at 40°C. Cold rinse.	—	—	15g	—
			●	—	12g	●
RINSE	For dishes that only require a rinse and dry.	Hot rinse at 65°C. Drying.	—	—	—	●
			●	—	—	●
PRE-RINSE	Pre-rinse of dishes while waiting for a full load.	Short cold wash to prevent food residue from drying on the dishes .	—	—	—	—
			●	—	—	—

(*) AS/NZS 2007 test with rinse aid setting 5

“●” be able to applied “—”not to be applied

Washing dishes

Programme selection

The most appropriate programme can be identified by comparing the type of crockery, cutlery, etc., as well as the amount and condition of food remains, with the details contained in the wash cycle table.

Earn savings

If only a small number of dishes have been loaded into the dishwasher, selecting a programme that operates at the next lowest temperature will usually be sufficient.

Programme data

The stated programme data are based on standard operating conditions. The values can vary considerably according to:

- different amounts of dishes
- temperature of mains water supply
- pressure of mains water supply
- ambient temperature
- fluctuations in mains voltage
- machine-related factors (e.g. temperature, water volume,...)

Turning on the Appliance

Starting a wash cycle...

- Make sure that the plug for the appliance is inserted into the wall socket.
- Make sure that the water supply is turned on to full pressure.
- Load the dishes.
- Pour in the detergent.
- Press the Power button, and the "POWER" light will turn on.
- Turn the knob located on the right of the control panel until the number or symbol for the cycle setting is aligned with the reference mark (see the section entitled, program overview). If the knob is correctly aligned with the reference mark you want to choose, you must turn the knob to with the mark of "Reset". Then back to the number or symbol of the program you want to choose.
- After five seconds the "POWER" light will flash, the wash cycle will begin.

Note: When washing, the knob will not rotate itself.

At the end of the wash cycle...

When the buzzer constantly beeps six times, the "POWER" light will turn on and the cycle has finished. Turn off the appliance using the Power button, turn off the water supply and open the door of the dishwasher. Wait a few minutes before unloading the dishwasher to avoid handling the dishes and utensils while they are still hot and more susceptible to breakage. They will also dry better.

Cancelling or modifying a wash cycle setting...

A cycle that is underway can only be modified if it has been running for a short time. Otherwise, the detergent may have already been used, and the appliance may have already drained the wash water. If this is the case, the detergent dispenser must be refilled (see the paragraph entitled, "Loading the Detergent").

Rotate the knob to the mark of "Reset" then select right programme.

- 1 — HEAVY
- 2 — NORMAL
- 3 — LIGHT
- 4 — GLASSWARE
- 5 — QUICK 30
- 6 — RINSE
- 7 — PRE-RINSE

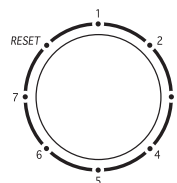

"HALF LOAD" Button

This button "D" (see "Close-up View (Control Panel)) makes it possible to wash dishes using only the upper rack if there are not enough dishes for a full load. This will allow you to save on water and energy consumption.

To select "HALF LOAD":

- Select the programme (see the paragraph entitled "Turning on the Appliance")
- Press the HALF LOAD button " D " , HALF LOAD indicator lights.
 - Please keep in mind that the amount of detergent should also be adapted to the "HALF LOAD".

How to keep your dishwasher in shape

After Every Wash

After every wash, turn off the water supply (not necessary for models with "Aquastop") to the appliance and leave the door slightly ajar so that moisture and odors are not trapped inside.

Remove the plug

Before cleaning or performing maintenance, always remove the plug from the socket. Do not run risks.

No solvents or Abrasive Cleaning Products

To clean the exterior and rubber parts of the dishwasher, do not use solvents or abrasive cleaning products. Rather, use only a cloth and warm soapy water.

To remove spots or stains from the surface of the interior, use a cloth dampened with water and a little white vinegar, or cleaning product made specifically for dishwashers.

Moving the Appliance

If the appliance must be moved, try to keep it in a vertical position. If absolutely necessary, it can be positioned on its back.

Seals

One of the factors that cause odors to form in the dishwasher is food that remains trapped in the seals. Periodic cleaning with a damp sponge will prevent this from occurring.

The door should not be left in the open position since this could present a tripping hazard.

When You Go on Holiday

When you go on holiday, it is recommended that you run a wash cycle with the dishwasher empty and then remove the plug from the socket, turn off the water supply and leave the door of the appliance slightly ajar. This will help the seals last longer and prevent odors from forming within the appliance.

Care and maintenance

Regular inspection and maintenance of your appliance helps to prevent problems from occurring. This saves time and aggravation. You should therefore carefully inspect the inside of your dishwasher from time to time.

Overall condition of appliance

- Check that no grease or scale has accumulated on the inside of the dishwasher.
- If you discover any deposits:
 - Clean the interior of the dishwasher thoroughly with a detergent solution.

Rinse-aid

Check the LOW RINSE-AID indicator " 7 ", on the control panel. Top up with rinse-aid, if required.

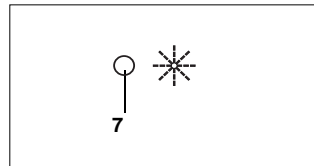

Filters

The filters " 8 ", " 9 " prevent larger particles of food in the water from reaching the pump. These particles may occasionally block the filters.

- When the appliance has finished washing, check the filters for particles of food and, if required, clean.
- After undoing the coarse micro-filter " 8 ", the filter unit " 9 " can be removed. Remove any particles of food and rinse the filters under running water.
- Insert the filter unit " 9 " and tighten the coarse micro-filter.

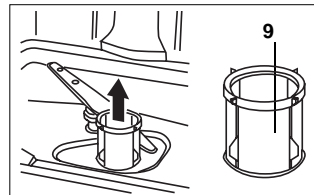
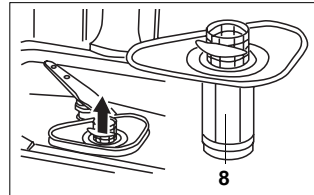

Spray arms

Lime and remnants of food in the washing water can block the nozzles in the spray arms " 10 " and " 11 " and the arm mountings.

- Inspect the nozzles in the spray arms for blocked holes due to remnants of food.
- If necessary, pull the lower arm " 11 " upwards and lift it off.
- Unscrew the upper spray arm " 10 ".
- Clean both spray arms under running water.
- Refit the spray arms. Ensure that the lower arm has locked into place and the upper one is screwed tight.

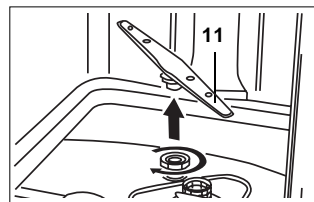
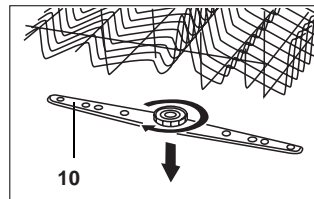

Fault finding

Resolving minor problems yourself

Experience has shown that you can resolve most problems that arise during normal daily usage yourself, without having to call out a service engineer. Not only does this save costs, but it also means that the appliance is available for use again that much sooner. The following list of common occurrences and their remedies should help you identify the causes of most problems.

Problems...

...when the appliance is switched on

Appliance does not start up

- Fault with fuse in mains electricity supply.
- Plug not inserted in wall socket.
- Appliance door not closed properly.
- Programme has not been chosen.
- Water tap not turned on.
- Blocked strainer in water intake hose.
 - The strainer is situated in the Aquastop or supply-hose connection.



Do not forget that repairs should only be carried out by a qualified specialist. Improper repairs can lead to considerable equipment damage as well as danger to the user.

...with the appliance itself

When the alarm sounds in a series of 2 beeps, pause, 2 beeps, pause ...

- the water is turned on and the hose is connected properly;
- the water supply to the house is on and has sufficient pressure;
- the water supply hose is crimped or bent;
- the filter for the water supply hose is clogged.
- the drain hose is too low.

When the alarm sounds in a series of 3 beeps, pause, 3 beeps, pause ...

- the drain hose is crimped or bent.
- the drain hose is too high.

When the alarm sounds in a series of 6 beeps, pause, 6 beeps, pause ...

- the drain hose is too low.

When the "POWER" indicator is on, at the moment, the alarm sounds in a series of 10 beeps, pause, 10 beeps, pause ...

- the door is not properly closed.

If you take all these checks and the dishwasher still does not function or your dishwasher have any other error display, you can power the dishwasher OFF, and wait a few minutes. You can power the dishwasher on, try it again , if the dishwasher still does not function and/or the problem persists, contact the nearest authorised service center and provide them with the following information:

- the nature of the problem.
- the model type number (Mod...) And the serial number (S/N...), which are indicated on the nameplate located on the side of the inner part of the door.

Spray arm rotates with difficulty

- Spray arm is blocked by small items or food remains.

Lid in detergent compartment cannot be closed

- Detergent compartment has been overfilled.
- Mechanism is clogged with remnants of detergent.

Indicator lamps do not extinguish after washing has finished

- Power Button is still set to ON.

Remnants of detergent stuck inside dispenser

- Compartment was damp when it was filled up with detergent. Compartment must be dry before detergent is added.

Water remains inside appliance after programme has ended

- Blockage or kind in drainage hose.
- Pump is jammed.
- Filters are blocked.
- The programme is still running. Wait for the programme to end .

...during washing

Unusual amount of foam is increased

- Normal washing up liquid has been poured into the rinse-aid container.
- Remove any spilled rinse aid with a cloth as it could otherwise lead to excessive foaming during the next washing cycle.

Appliance stops suddenly while washing is taking place

- Cut off electricity supply to appliance.
- Water supply has been interrupted.

Knocking sound can be heard while washing is taking place

- A spray arm is knocking against the dishes inside the appliance.

Rattling sound can be heard while washing is taking place

- Crockery has not been stacked properly inside the appliance.

Knocking sound coming from inlet valves

- This is caused by the way the water pipes have been laid and it has no effect upon the way the appliance functions. There is no remedy for this.

...with the dishes, cutlery, etc.

Remnants of food are stuck to the dishes, cutlery, etc.

- Dishwasher was not loaded properly. Jets of water could not reach all parts of the dishes, etc.
- Too many items in the rack.
- Items in the rack were touching each other.
- Not enough detergent was added to dispenser.
- Selected wash programme was not intensive enough.
- Rotation of spray arm was obstructed by dishes, etc.
- Nozzles in spray arm are blocked by remnants of food.
- Filters are blocked.
- Filters have been incorrectly fitted.
- Waste-water pump is jammed.

White stains are left on crockery, glasses have a milky appearance

- Not enough detergent was added to dispenser compartment.
- Amount of rinse-aid was set too low.

Dishes, cutlery, etc. have not been dried

- Selected programme did not include drying function.
- Amount of rinse-aid was set too low.
- Items were removed from dishwasher too soon.

Glasses have a dull appearance

- Amount of rinse-aid was set too low.

Tea stains or traces of lipstick have not been completely removed

- Detergent does not have a sufficient bleaching effect.
- Washing temperature was set too low.

Traces of rust on cutlery

- Cutlery is not sufficiently rustproof.

Glasses become clouded and discoloured; coating cannot be wiped off

- Unsuitable detergent was used.
- Glasses are not dishwasher-proof.

Smears left behind on glasses and cutlery; glasses have acquired a metallic appearance

- Amount of rinse-aid set too high.

Technical data

Width	60 cm
Depth	60 cm
Height	85 cm
Capacity	12 standard place settings
Mains water pressure	0.03-1.0MPa
Power supply	220-240V~ 50Hz
Maximum current intensity	13A
Total absorbed power	1950W

Important information

Notes on waste disposal

Old appliances still have some residual value. An environment-friendly method of disposal will ensure that valuable raw materials can be recovered and used again.

When an appliance has reached the end of its working life, unplug it from the mains. Cut through the mains cable and dispose of it together with the plug.

Destroy the door locking mechanism. This will ensure that children at play cannot become locked inside and are not exposed to the risk of suffocation.

Your new appliance was protected by suitable packaging while it was on its way to you. All materials used for this purpose are environment-friendly and can be recycled. Please make a contribution to protecting the environment by disposing of the packaging appropriately.

Do not allow children to play with any parts of the packaging. There is a risk of suffocation by the cardboard boxes and the plastic wrapping.

Up-to-date information concerning options for disposal can be obtained from your retailer or local municipal administration.

General information

- Measures must be taken to ensure that built-under and built-in units that are subsequently re-sited as free-standing appliances cannot topple over. This can be achieved by bolting the dishwasher to the wall or fitting it under a continuous work surface which is screwed to the adjacent cupboards.

Information on comparability tests implemented in compliance with AS/NZS 2007

Appliance loaded in accordance with standard specifications.

Example of loaded dishwasher: See fig. 1 and 2.

Capacity: 12 place settings

Comparability programme: NORMAL wash

Rinse-aid setting: 5

Detergent: 25+5g

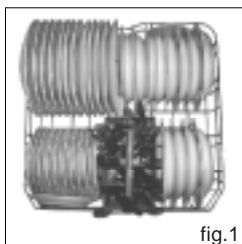

fig.1

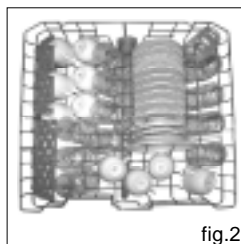
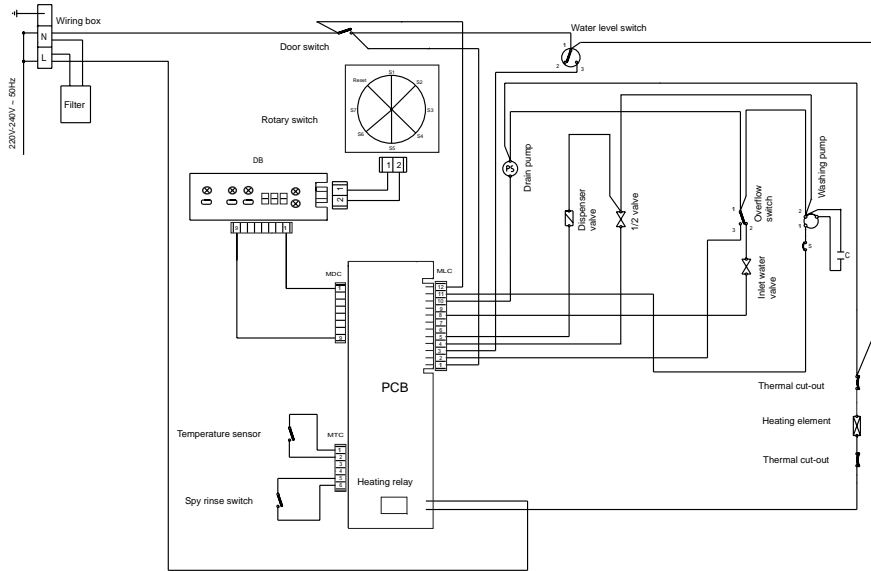

fig.2

If the comparability tests do not comply fully with AS/NZS 2007, e.g., degree of soiling, type of dishes and cutlery, etc., contact the appliance manufacturer before starting the test.

Diagram



Free Manuals Download Website

<http://myh66.com>

<http://usermanuals.us>

<http://www.somanuals.com>

<http://www.4manuals.cc>

<http://www.manual-lib.com>

<http://www.404manual.com>

<http://www.luxmanual.com>

<http://aubethermostatmanual.com>

Golf course search by state

<http://golfingnear.com>

Email search by domain

<http://emailbydomain.com>

Auto manuals search

<http://auto.somanuals.com>

TV manuals search

<http://tv.somanuals.com>