

# Dishwasher Installation Manual

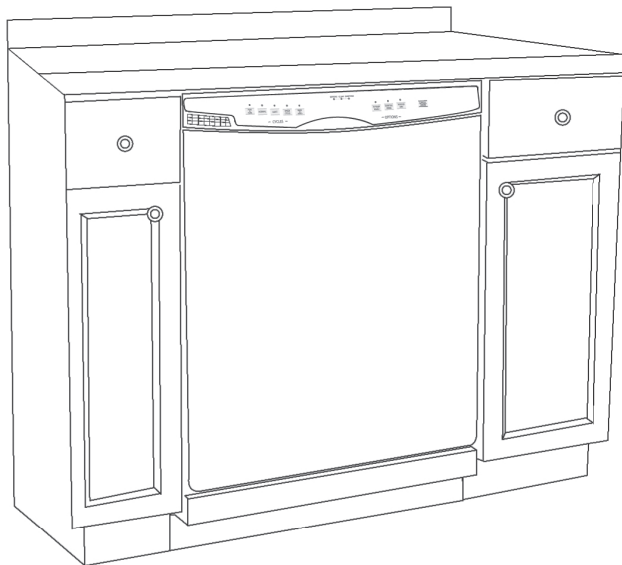

Model DWL3025

**Haier**

Quality • Innovation • Style

Download from [www.Somanuals.com](http://www.Somanuals.com). All Manuals Search And Download.

# TABLE OF CONTENTS

	PAGE
Before Using Your Dishwasher .....	2-3
BUILT-IN DISHWASHER INSTALLATION INSTRUCTIONS .....	4-10
WHAT DO I NEED TO HAVE TO INSTALL THE DISHWASHER? .....	4-10
Tools, parts & materials .....	4-5
Requirements .....	6-10
Cabinet Dimensions .....	9
WHAT DO I NEED TO DO BEFORE I INSTALL THE DISHWASHER? .....	10-20
Prepare cabinet .....	10-14
Prepare dishwasher .....	14-20
HOW DO I INSTALL THE DISHWASHER? .....	20-25
Connect dishwasher .....	20-23
Secure dishwasher .....	24
Check operation .....	25

# BEFORE USING THE DISHWASHER

IMPORTANT: READ AND SAVE THESE INSTRUCTIONS

Doing so will:

- make installation easier.
- help you in the future if you have questions.
- help if you have an electrical inspection.



This is the safety alert symbol.

This symbol alerts you to potential hazards that may seriously injure you and others.

All safety messages follow the safety alert symbol and either the word "DANGER" or "WARNING".

## DANGER

YOU CAN BE SERIOUSLY INJURED IF YOU DO NOT FOLLOW INSTRUCTIONS IMMEDIATELY.

## WARNING

YOU CAN BE SERIOUSLY INJURED IF YOU DO NOT FOLLOW INSTRUCTIONS.

All safety messages will tell you what the potential hazard is, how to reduce the chance of injury and what can happen if the instructions are not followed.

## YOU NEED TO

- Carefully open dishwasher door while someone grasps the rear of the dishwasher. Remove shipping materials and lower rack. Close dishwasher door. Latch the dishwasher door shut.
- Install this dishwasher as specified in these instructions.
- Have everything you need (tools, materials, parts) to properly install the dishwasher.

## IMPORTANT

- Observe all governing codes and ordinances.
- **Note to installer** – Be sure to leave these instructions for the consumer's and inspector's use.
- **Note to consumer** – Keep these instructions with your owner's manual for future reference.
- **Skill level** – Installation of this dishwasher requires basic mechanical, electrical, and plumbing skills.

**Proper installation is the responsibility of the installer. Product failure due to improper installation is not covered under warranty.**

**See warranty information.**

- Completion time – 1 to 3 hours. New installations require more time than replacement installations.

# TOOLS AND MATERIALS NEEDED

## ALL INSTALLATIONS



- A. Pliers
- B. Phillips screwdriver
- C.  $\frac{5}{8}$ " open end wrench
- D. Measuring tape or ruler
- E. 10" adjustable wrench that opens to  $1\frac{1}{8}$ " (2.9 cm)
- F. Flat-blade screwdriver
- G. Gloves
- H. Utility knife
- I. 2 twist-on wire connectors which are the proper size to connect your house hold wiring to 16-gauge wiring in dishwasher
- J. Small level
- K. Safety glasses
- L. 90° elbow with  $\frac{3}{8}$ " (0.9 cm) N.P.T external threads on one end. (The other end must fit your water supply line.)
- M. Flashlight
- N. Teflon® tape or pipe joint compound
- O. Shallow pan
- P. Shim stock (if instilled with built-up floor)

**In addition for new installations**

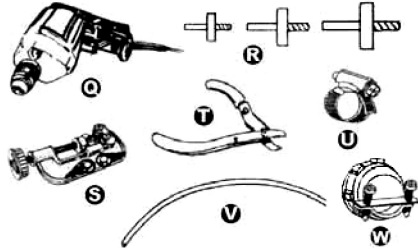

- Q. Electric drill
  - R. ½", ¾" and 1½" hole saw bits
  - S. Small tubing cutter
  - T. Wire stripper
  - U. 1½"-2" screw-type clamp if connecting to waste-tee
  - V. Copper tubing (3/8" recommended) or flexible stainless steel braided fill line
  - W. Clamp connector or conduit connector to fit a 7/8" (2.2 cm) diameter hole
- © Teflon is a registered trademark of E.I. Du Pont de Nemours and Company.

**Parts supplied**

- A. 2 drain hose clamps
  - 1-large
  - 1-small
- B. 2 No. ST4.2 X 18 Phillips head screws
- C. Drain hose

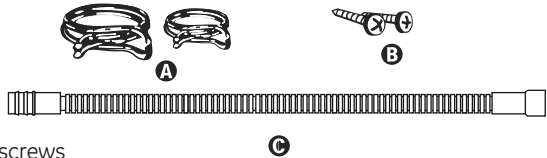

Make sure all these parts are included.

# REQUIREMENTS

## Cabinet Requirements

Do not run water drain lines or electrical wiring where they can interfere with or contact dishwasher motor or legs.

The location where the dishwasher will be installed must provide clearance between motor and flooring.

Do not install dishwasher over carpeted flooring.

Protect dishwasher and water lines leading to dishwasher against freezing.

Damage from freezing is not covered by the warranty.

### Check location where dishwasher will be installed. The location must provide:

- Easy access to water, electricity and drain.
- Convenient loading. Corner locations require a 2" (5.1 cm) minimum clearance between the side of the dishwasher door and wall or cabinet.
- Square opening for proper operation and appearance.
- Cabinet front perpendicular to floor.
- Level floor. If floor at front of opening is not level with floor at rear of opening, shims may be needed to level dishwasher.

**NOTE:** Shims must be securely attached to floor to prevent their movement when dishwasher is being operated.

If dishwasher will be left unused for a period of time or in a location where it may be subject to freezing, have it winterized by authorized service personnel. Make sure pipes, wires and drain hose are within the shaded area. See page 9 for dimensions.

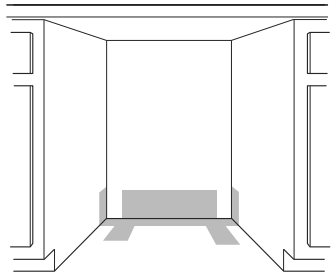

## HELPFUL TIP:

If the floor in the dishwasher opening is uneven (example: tile flooring only part way into opening) you will need to take special care in measuring dimensions and in leveling dishwasher.

# ELECTRICAL

It is the customer's responsibility:

To assure that the electrical installation is adequate and in conformance with all national and local codes and ordinances.

You must have:

- 120-volt, 60Hz, AC-only, 15- or 20-amp., fused electrical supply, and connected to an individual, properly grounded branch circuit.
- Wiring must be 2-wire with ground and rated for 176°F (75°C).

We recommend:

- a time-delay fuse or circuit breaker.
- a separate circuit.

## If direct wiring dishwasher:

- Use flexible, armored or non-metallic sheathed, copper wire with grounding wire that meets the wiring requirements for your home and local codes and ordinances.
- Use strain relief method provided with house wiring junction box or install a cUL-listed/CSA-certified clamp connector to the house wiring junction box. If using conduit, use a cUL-listed/CSA-certified conduit connector.

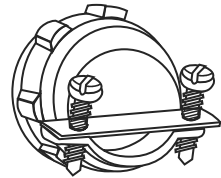

## If connecting dishwasher with a power supply cord:

- Use a cUL-listed, 16-gauge, three-conductor power supply cord that meets all local codes and ordinances. Maximum length of the power supply cord is 6 feet (1.8 m).
- A clamp connector to fit a  $7/8$ " (2.2 cm) diameter hole is required to secure power supply cord to dishwasher terminal box.
- Power supply cord must plug into a mating three-prong, grounded outlet, located in the cabinet next to the dishwasher opening. Outlet must meet all local codes and ordinances.

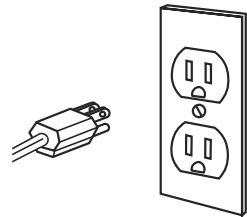

## WARNING

### Electrical Shock Hazard

The improper connection of the equipment grounding conductor can result in a risk of electric shock. Check with a qualified electrician if you are in doubt that the appliance is properly grounded.





## WATER

### You must have:

- A hot water line with 20-120 psi (138-862 kPa) water pressure.
- 120°F (49°C) water at dishwasher.
- $\frac{3}{8}$ " (0.9 cm) O.D. tubing with compression fitting or flexible stainless steel braided fill line ( $\frac{1}{2}$ "/1.3 cm) minimum plastic tubing is optional but not recommended).
- A 90° elbow with  $\frac{3}{8}$ " (0.9 cm) N.P.T. external pipe threads on one end.

Do not solder within 6" (15.2 cm) from water inlet valve.

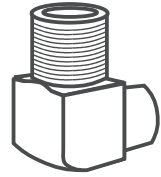

## DRAIN

### You must:

- Use the new drain hose supplied with your dishwasher. If this is not suitable, use a new drain hose with a maximum length of 12 feet (3.7 m) that meets all current AHAM/IAPMO test standards, is resistant to heat and detergent, and fits the drain connector on your dishwasher.
- Have a high drain loop 30 inches (76.2 cm) above the subfloor or floor.
- Connect drain hose to waste tee or disposer inlet above drain trap in house plumbing and 20 inches (50.8 cm) minimum above the floor.
- Use an air gap if the drain hose is connected to house plumbing lower than 20 inches (50.8 cm) above subfloor or floor.
- Use  $\frac{1}{2}$ " (1.3 cm) minimum I.D. drain line fittings.

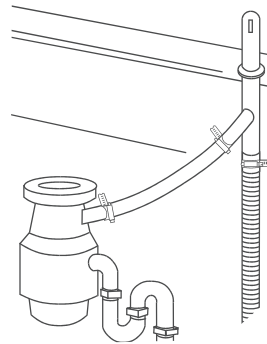

# CABINET DIMENSIONS

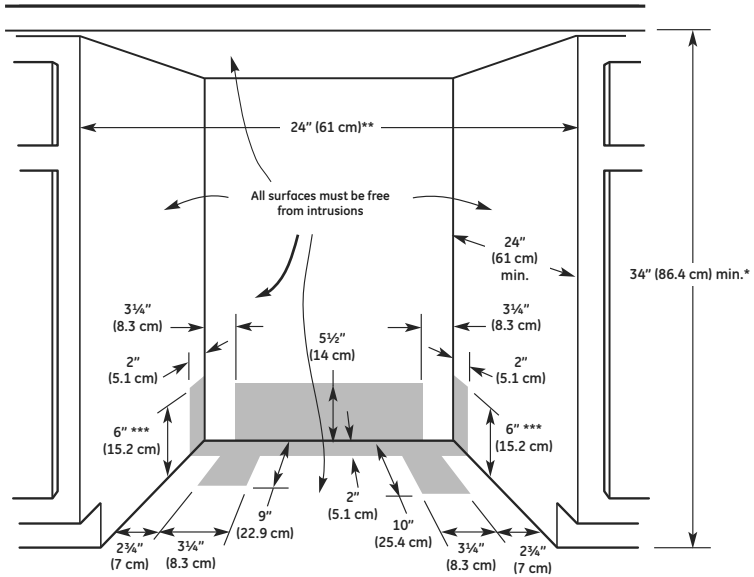

Cut openings in shaded area of cabinet walls or floor as specified in chart:

OPENING FOR:	DIAMETER
Water Line	1/2" (1.3 cm)
Drain Line	1 1/2" (3.8 cm)
Direct Wire	3/4" (1.9 cm)
Power Supply Cord	1 1/2" (3.8 cm)

- \* Measured from the lowest point on the underside of countertop.  
May be reduced to 33 7/8" (86 cm) by removing wheels from dishwasher.
- \*\* Minimum, measured from narrowest point of opening.
- \*\*\* Maybe increased to 6 7/8" (17.5 cm) if height of opening is 34 1/2" (87.6 cm) at lowest point.

## WARNING

### Electrical Shock Hazard

Disconnect electrical power at the fuse box or circuit breaker box before installing dishwasher.

Failure to do so can result in death or electrical shock.

Do not use an extension cord or adapter plug with this appliance.



## A. PREPARE CABINET

1. Disconnect the power supply. Turn water off. Put on gloves and safety glasses.

### 2. If you are replacing a dishwasher:

- Check that the water line "A" reaches to the back left of opening where the water connection will be made.

- Check that the direct line "B" reaches to the back left of opening where the electrical connection will be made.

If the water line and the direct wire reach into the opening far enough, go to step 10, page 12.

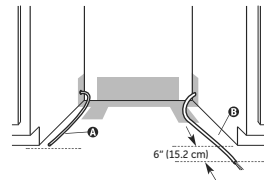

If you are installing a new dishwasher, complete all of the following steps:

### Electrical

Follow all national and local codes and ordinances for completing electrical supply to cabinet.

If you are:	Use Steps:
Direct Wiring	3, 4 and 5
Using a Power Supply cord	3a and 4a

## HELPFUL TIP:

Wiring the dishwasher will be easier if you route wire into the cabinet opening from the left side.

### 3. Direct wire method:

Cut a  $\frac{3}{4}$ " (1.9 cm) hole "C" in righthand cabinet side, rear or floor. Optional locations are shown.

**Wood Cabinet:** Sand hole until smooth.

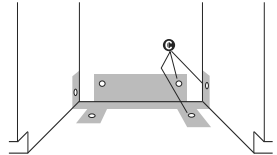

4. Run wire into house wiring junction box. Use strain relief method provided with junction box. If no strain relief is provided, install a cUL-listed/CSA-certified clamp connector for flexible-type wire. If installing conduit, attach a cUL-listed/CSA-certified conduit connector to junction box.

5. Run other end of wire through cabinet hole. Cable must extend to the left front of cabinet opening. Go to step 6.

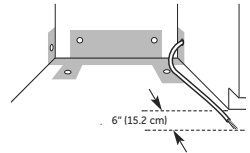

### 3a. Power supply cord method:

Cut a  $1\frac{1}{2}$ " (3.8 cm) hole "D" in right-hand cabinet rear or side. Optional locations are shown.

**Wood cabinet:** Sand hole until smooth.

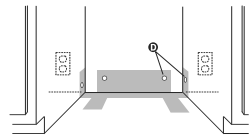

- 4a. Install a mating, three-prong, grounding-type wall receptacle "E" in the cabinet next to the dishwasher opening. Go to step 6.

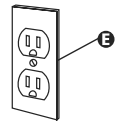

## Water Line

## HELPFUL TIP:

Routing the water line through the left side of cabinet opening will make water connection easier.

6. Cut a  $\frac{1}{2}$ " (1.3 cm) minimum hole "F" in left-hand cabinet side, rear or floor. Optional locations are shown. (The hole "F" is about  $\frac{1}{8}$ " higher than hole "C" or hole "D")

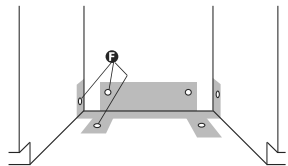

7. Measure overall length of copper tubing "G" required. Attach copper tubing to water line with manual shutoff valve. Carefully feed copper tubing through hole in cabinet (copper tubing will bend and kink easily) until it is far enough into the cabinet opening to connect it to dishwasher inlet on the front left of dishwasher.

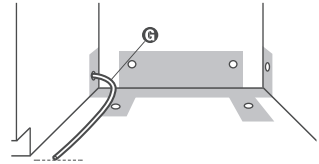

8. Turn shutoff valve "H" to "ON" position. Flush water into a bucket to get rid of particles that may clog the inlet valve.

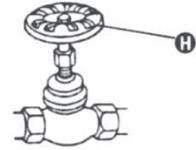

9. Turn shutoff valve to "OFF" position.

## Drain Hose

10. Cut a 1½" (3.8 cm) diameter hole in cabinet wall or floor on the side of the opening closest to the sink.

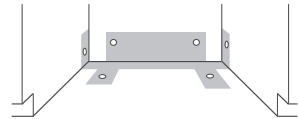

11. Connect drain hose to waste tee or waste disposer following one method.

If you have:	And:	Go to Step:
A Waste Disposer	An Air Gap	11a.
	No Air Gap*	11c.
No Waste Disposer	An Air Gap	11b.
	No Air Gap*	11d.

\* An air gap is recommended

### 11a. Waste disposer + air gap

- Remove the disposer knockout plug. Cut end of drain hose "I" if needed (do not cut ribbed section).
- Attach drain hose to air gap "J" with large spring-type clamp "K". If the drain hose was cut, use a 1½" to 2" (3.8 to 5 cm) screw-type clamp\*.
- Use a rubber hose connector\* "L" with spring or screwtype clamps\* "M" to connect air gap to disposer inlet "N". This connection "N" MUST be before drain trap "O" and at least 20" (50.8 cm) above the floor where dishwasher will be installed. Go to step 12.

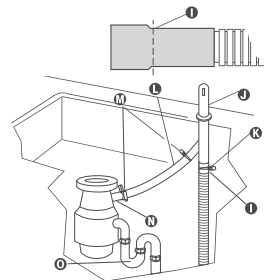

### 11b. No waste disposer + air gap

1. Cut end of drain hose "I" if needed (do not cut ribbed section).
2. Attach drain hose to air gap "J" with large springtype clamp. If the drain hose was cut, use a 1½" to 2" (3.8 to 5 cm) screw-type clamp\*.
3. Use a rubber hose connector\* "L" with spring or screwtype clamps\* "M" to connect air gap to waste tee "P".

This connection "P" MUST be before drain trap "O" and above the floor at 15<sup>4</sup>/<sub>8</sub>" (40 cm) to 39<sup>2</sup>/<sub>8</sub>" (100 cm), at least 20" (50.8 cm) above the floor where dishwasher will be installed. Go to step 12.

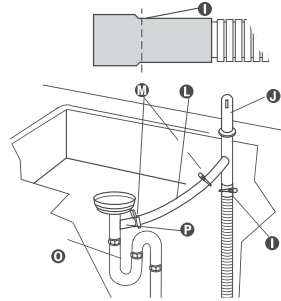

### 11c. Waste disposer, no air gap

1. **Remove the disposer knockout plug.**  
Do not cut end of drain hose.
2. Attach drain hose "I" to disposer inlet "N" with large spring type clamp "K".  
This connecting "N" MUST be before drain trap "O" and at least 20" (50.8 cm) above the floor where dishwasher will be installed.
3. The drain hose must be looped up and securely fastened to the underside of the counter before going to the drain. Hose loop must be a minimum of 30" (76.8cm) above floor.  
Go to step 12.

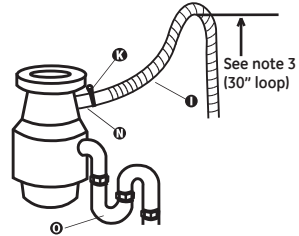

### 11d. No waste disposer + no air gap

1. Cut end of drain hose "I" (do not cut ribbed section).
2. Attach drain hose to waste tee "P" with 1½" to 2" (3.8 to 5 cm) screw-type clamp\* "M".  
This connecting "P" MUST be before drain trap "O" and at least 20" (50.8 cm) above the floor where dishwasher will be installed.
3. The drain hose must be looped up and securely fastened to the underside of the counter before going to the drain. Hose loop must be a minimum of 30" (76.8cm) above floor.  
Go to step 12.

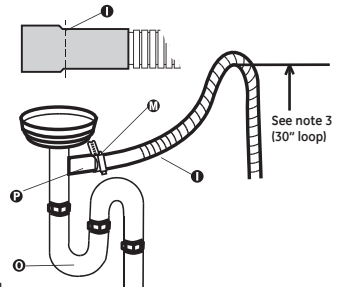

\* Parts available from local plumbing supply stores.

## HELPFUL TIP:

To reduce the vibration of the hose, keep the hose away from the floor and the edge of the hole where it passes through the cabinet.

12. Insert drain hose "1" into hole cut in cabinet to the back center of opening where drain connection will be made.

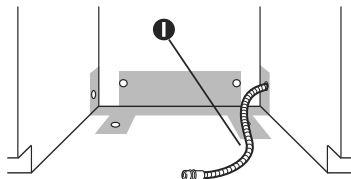

## B. PREPARE DISHWASHER

### WARNING

#### Tip Over Hazard

Do not use dishwasher until completely installed.  
Do not push down on open door.  
Doing so can result in serious injury or cuts.



### WARNING

#### Excessive Weight Hazard

Use two people to move and install dishwasher.  
Failure to do so can result in back or other injury.

1. Grasp sides of dishwasher door and put dishwasher on its back.
2. Remove two screws "A" attaching access panel "B" and lower panel "C" to dishwasher using a ¼" hex socket, nut driver or Phillips screwdriver. Remove panels and set panels aside on a protective surface. Check that grounding clip "D" is attached to the lower panel.

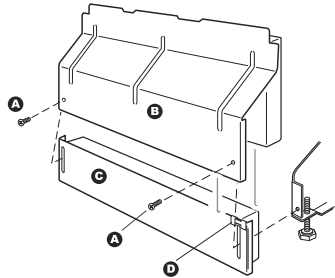

3. Apply pipe joint compound "E" to 90° elbow fitting "F" and connect fitting to water inlet valve "G". Tighten elbow until snug, and be sure that it faces to the rear.

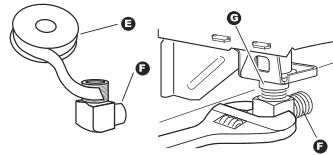

4. Remove terminal box cover "H". Pull appliance wires "I" through hole in terminal box. Do not untie the knot in the wires.  
If you are direct wiring: install a cUL-listed/CSA certified clamp connector "J" to the terminal box. If using conduit use a cUL-listed/CSA certified conduit connector.  
If you are installing a power supply cord kit, do so now and follow kit instructions.

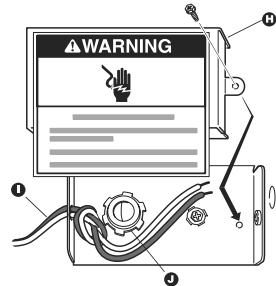

## HELPFUL TIP:

Put cardboard under dishwasher until it is installed. The cardboard will help protect floor covering during installation.



5. Measure height of cabinet opening from underside of countertop to floor where dishwasher will be installed "K" (you need the lowest point). Check chart for that height opening. Put wheels "L" in the required position. Turn both front leveler legs to the same height.

Min. Cutout Height	Wheel Position (See Illustration)	Number of Turns on Front Leg
34" (86.4 cm)	1	10
34¼" (87 cm)	2	5
34½" (87.6 cm)	3	

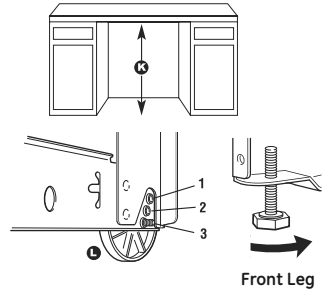

If the minimum cutout height is less than 34" (86.4 cm), the adjustable legs can be removed for additional clearance. This will allow the dishwasher to fit into a 33¼" (85.9 cm) high cutout, but the dishwasher will be more difficult to move into position. **If the wheels are removed, protect the floor when moving the dishwasher.**

## HELPFUL TIP:

### Built-up floors.

Measure height of opening from underside of countertop to built-up floor. If the height is at least 33¾" (84.5 cm), the dishwasher will fit into the opening without modification to the countertop or flooring.

Put wheels "L" in position 1 and turn the front leveler legs up all the way.

Add shims as needed in the area shown to bring dishwasher up to proper height.

**Note:** Shims must be securely attached to floor to prevent their movement when the dishwasher is operated.

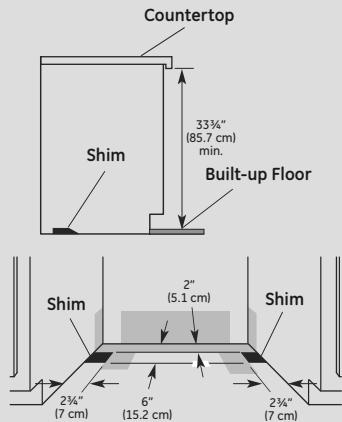

6. Stand dishwasher upright.
7. The dishwasher must be secured to the cabinet. There are two brackets on top of the dishwasher that usually can be attached to the countertop. If this is not possible, the brackets "M" may be moved to the sides of the dishwasher. If you are going to attach the dishwasher to the countertop, skip to step 13. If you are going to attach the dishwasher to the sides of the cabinet, follow steps 8 through 12.

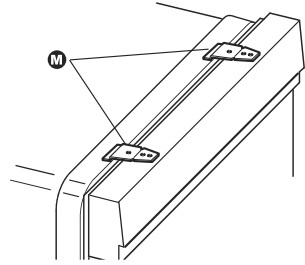

8. To remove the brackets from the top, flatten tab "N" at back of brackets with pliers, and pull the brackets out of the slots "O".
9. Break off the end of the bracket along the scored line "P".

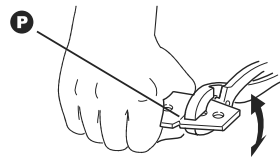
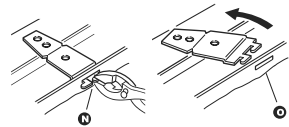

10. Open dishwasher door and place towel "Q" over pump assembly and spray arm of dishwasher. This will prevent screws from falling into pump area when securing dishwasher to countertop.

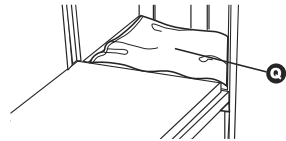

11. Open dishwasher door and push the plastic buttons "R" out of the side of the tub.

**NOTE:** Save the buttons to cover the holes after dishwasher is installed.

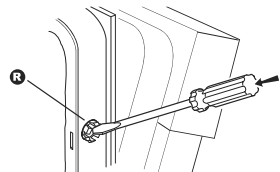

12. Push bracket into slot "S" on the side of dishwasher, and bend tab in towards the side of the dishwasher so that it keeps the bracket in place.

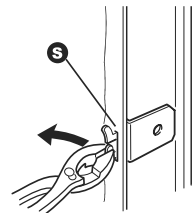

13. Check the door spring tension. With another person holding the dishwasher to prevent it from tipping, open and close the door a few times. If the door opens by itself, adjust the door spring tension.

To adjust the door spring tension, unhook the spring "T" from the rear leg of dishwasher. With a  $\frac{5}{16}$ " nut driver or hex socket, remove the screw "U" from the tensioner "V". The screw can be put into one of three holes "1", "2", "3", in front leg of dishwasher. The dishwasher is shipped with the screw in the back hole.

If the door opened by itself, move the tensioner to hole "2" or "3" and replace screw. Re-attach door spring to rear leg. Tensioners on both sides of dishwasher should be secured at same holes.

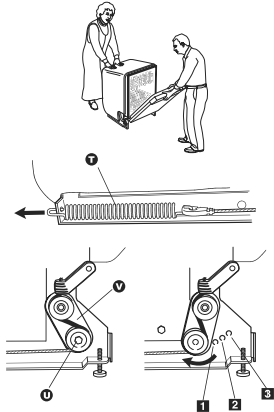

14. Grasp the dishwasher door at the edges of the door panel "W". Tilt dishwasher backwards on wheels "X". Move dishwasher close to cabinet opening. **DO NOT PUSH ON FRONT OF PANEL OR ON CONSOLE - THEY MAY DENT.**

15. If dishwasher has a power supply cord, insert power supply cord into hole cut into cabinet.

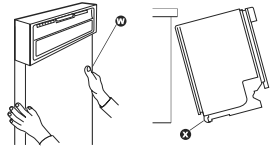

16. Check that water line is on the left side of opening and drain hose is near the center of the hole in the cabinet. If using direct wire, check that it is on the right side of opening.

17. Carefully move dishwasher completely into cabinet opening. Do not kink or pinch copper tubing, drain hose, power supply cord or direct wire between dishwasher and cabinet.

Center dishwasher in opening.

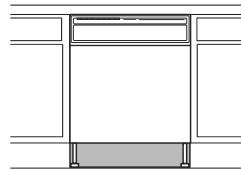

## HELPFUL TIP:

### Built-up floors.

Tilt dishwasher backward to move into opening.  
Once in position, support front of dishwasher by lowering  
or shimming front feet.

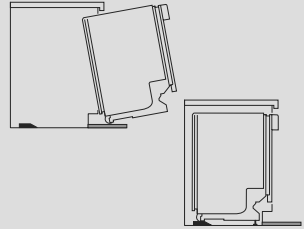

18. Remove cardboard from under dishwasher.

## HELPFUL TIP:

It is okay if dishwasher fits tightly into cabinet opening. Do not remove insulation  
blanket - it reduces the sound level.

19. Align front of dishwasher door panel "Y" with cabinet doors  
"Z". You may need to adjust alignment to look good with  
your cabinets.

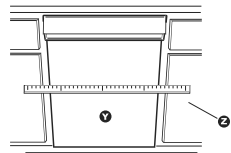

## HELPFUL TIP:

Prop up one side of frame to hold dishwasher up off floor  
when adjusting front legs.

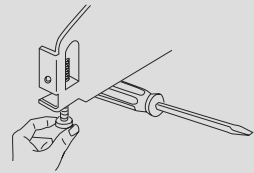

20. Check that leveling legs "AA" are firmly against the floor. Close and latch the door, and place level against the front panel "BB". Check that dishwasher is plumb. Adjust leveling leg or add shims under rear wheel until dishwasher is level.

**NOTE:** Shims must be securely attached to floor to prevent their movement when the dishwasher is operated. Repeat for other side of dishwasher.

Place level against top front opening of tub "CC". Check that dishwasher is level from side to side. If dishwasher is not level, adjust front legs up or down until dishwasher is level.

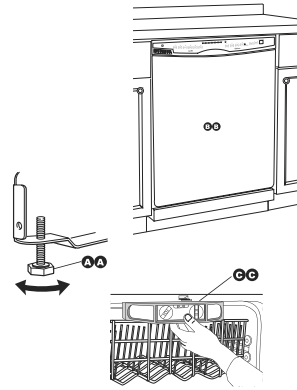

## C. CONNECT DISHWASHER

### Electrical Connection

Check electrical requirements (see page 7).

You need to:

- Have the correct electrical supply and recommended grounding method.
- Check that power supply is disconnected.

If you are:	Use Steps:
Direct Wiring	1-4
Using a Power Supply cord	1a

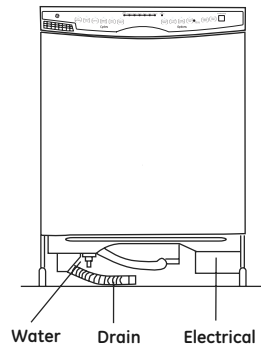

1. Direct wire method:

**⚠ WARNING**

**Electrical Shock Hazard**

Electrically ground dishwasher.  
Connect ground wire to green ground connector in terminal box. Do not use an extension cord. Failure to do so can result in death, fire, or electrical shock.



Install strain relief and route direct wire so that it does not touch dishwasher motor or lower part of dishwasher tub. Pull direct wire "A" through hole in terminal box.

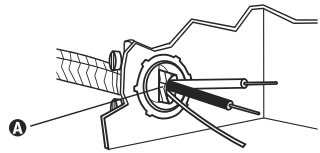

**HELPFUL TIP:**

- Select the proper size twist-on connectors to connect your household wiring to 16-gauge dishwasher wiring.
- Insert wire ends into twist-n connector. Do not pretwist bare wire.
- Twist connector.
- Gently tug on wires to be sure both are secured.

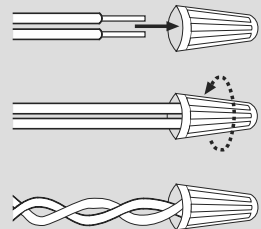

2. Connect the wire "B" as follows using twist-on connectors "C" sized to connect direct wire to 16-gauge dishwasher wire:  
From bare ground wire "D" into a U-shaped hook. Wrap ground wire hook clockwise around ground connector "E" and under the washer "F". Securely tighten ground connector "E" and under the washer "F".

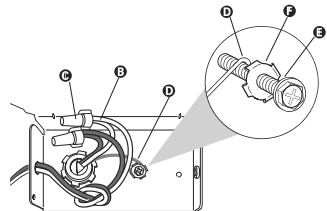

Securely tighten ground connector "E". Do not untie knot in the wires.

Power Supply Wire:		Terminal Box Wire:
White	↔	White
Black	↔	Black
Ground Wire	↔	Ground Wire

- Tighten clamp connector or conduit connector screws "G".

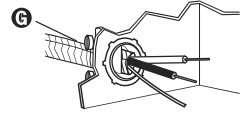

- Reinstall terminal box cover "H" with wires inside terminal box. Go to step 5. The cover must be outside the box on the right side. Make sure no wires are pinched by cover. Do not leave the box without the cover.

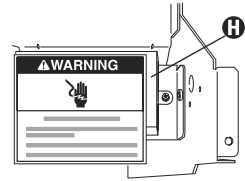

### 1a. Power Supply Cord Method:

WARNING

#### Electrical Shock Hazard

Plug into a grounded 3 prong outlet.

Do not remove ground prong.

Do not use an adapter.

Do not use an extension cord.

Failure to follow these instructions can result in death, fire, or electrical shock.

Check that power supply cord does not touch dishwasher motor or lower part of dishwasher tub. Go to step 5.

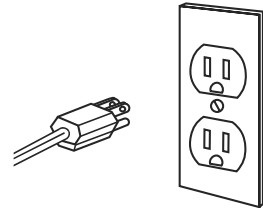

## Water Connection

### HELPFUL TIP:

Compression Fittings:

- 1 Slide nut "I" onto copper tubing "J" about 1" (2.5 cm).
2. Slide ferrule "K" onto the tubing. Do not position ferrule on the end of the tubing.
3. Put the tubing into the elbow "L" as far as it will go.
4. Slide the nut and ferrule forward and start the nut onto the elbow threads "M". Be careful when handling and positioning the copper tubing. It bends and kinks easily.

- To prevent vibration during operation, route the water supply line so that it does not touch the dishwasher base, frame or motor. Make sure the water line stays within the shaded area shown on page 7 when the dishwasher is installed in the cabinet. With copper tubing "J" pushed into compression fitting as far as it will go, use an adjustable wrench and tighten compression fitting nut "I" to elbow "L" on water inlet valve.
- Place Paper towel under elbow. Turn on water supply and check for leaks.

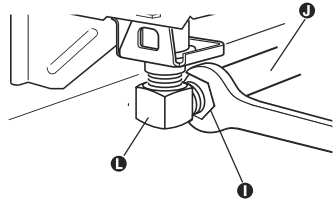

## Drain Connection

- To help minimize vibration noise, route drain hose to avoid contact with motor, door springs, water line, cabinet, flooring or the edge of the hole where it passes through the cabinet. Do not remove drain loop "N" from side of dishwasher.

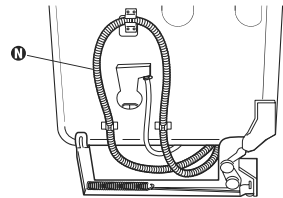

- Place the smaller drain hose clamp "N" onto the small end of the drain hose "O". Remove the plug from the connector "P".

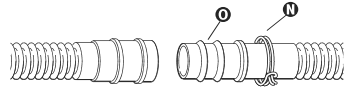

- Push the drain hose into the connector "P" up to the rib "O" on the drain hose.

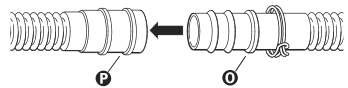

- Use pliers to open clamp "N" and slide clamp onto connector "P" between ribs "O" on connector.

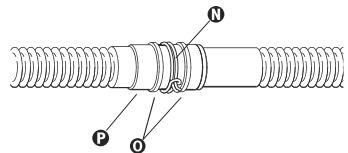



## D. SECURE DISHWASHER

### WARNING

#### Tip Over Hazard

Do not use dishwasher until completely installed.  
Do not push down on open door.  
Doing so can result in serious injury or cuts.



1. Open dishwasher door and place towel "A" over pump assembly and spray arm of dishwasher. This will prevent dishwasher from falling into pump area when securing dishwasher to countertop.

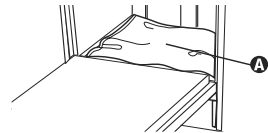

2. Check that dishwasher is still level and centered in the opening.

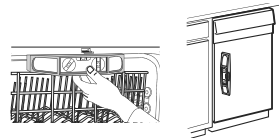

3. Secure dishwasher to countertop with two, No. ST4.2 x 18 Phillips-head screws "B". The dishwasher MUST be secured to keep it from tipping when door is opened. Do Not drop screws into bottom of dishwasher.

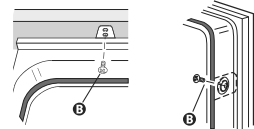

4. Open door about 3 inches (7.6 cm) and check that space between inner door and tub is equal on both sides. If spacing is not equal, loosen bracket screws and shift tub. Tighten bracket screws. If securing to sides of cabinet, replace the plastic buttons "C".

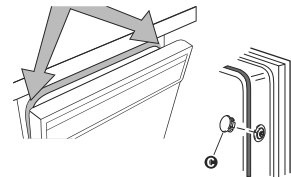

Check that top of door does not contact screws, brackets, or countertop. If it does, dishwasher must be lowered and re-leveled. Remove paper or towel from dishwasher.

## E. CHECK OPERATION

1. Read the Owner's Manual that came with your dishwasher.
2. Check that all parts have been installed and no steps were skipped. Check that you have all the tools you used.
3. At fuse box or circuit breaker, turn on electrical power supply to dishwasher. Start dishwasher and allow it to complete the shortest wash cycle. After the first two minutes, unlatch door, wait five seconds, then open door. Check to see that there is water in the bottom of the dishwasher and that there are no water leaks.

4. Check that grounding clip "A" is attached to the lower panel. Place the lower panel "B" behind the access panel "C". Some models have insulation "D" on the access panel which must fall behind the insulation "E" on the lower panel. Hold the two panels together and place them against dishwasher leg. Reinstall the screws through the holes in the access panel and the slots in the lower panel. Install right side screw first. Check that the lower edge of the lower panel contacts the floor. Tighten the screws.

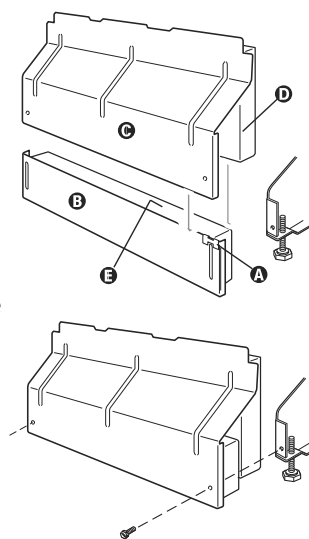

### If Dishwasher Does Not Operate:

- Has the circuit breaker tripped or the house fuse blown?
- Is the door closed tightly and latched?
- Has the cycle been set correctly to start the dishwasher?
- Is the water turned on?

## Side view

### Model DWL3025

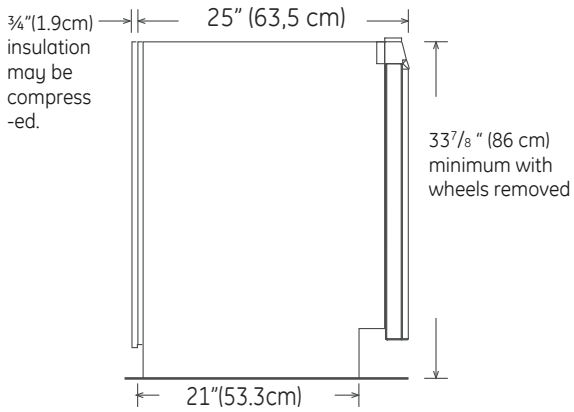

# **IMPORTANT**

**Do Not Return This Product To the Store**  
**If you have a problem with this product, please contact the**  
**“Haier Customer Satisfaction Center” at 1-877-337-3639.**  
**DATED PROOF OF PURCHASE MODEL # AND SERIAL #**  
**REQUIRED FOR WARRANTY SERVICE**

# Haier

Haier America  
New York, NY 10018

Made in China

## Free Manuals Download Website

<http://myh66.com>

<http://usermanuals.us>

<http://www.somanuals.com>

<http://www.4manuals.cc>

<http://www.manual-lib.com>

<http://www.404manual.com>

<http://www.luxmanual.com>

<http://aubethermostatmanual.com>

Golf course search by state

<http://golfingnear.com>

Email search by domain

<http://emailbydomain.com>

Auto manuals search

<http://auto.somanuals.com>

TV manuals search

<http://tv.somanuals.com>