

The logo consists of a lime green square with a white, stylized 'H' shape cut out of its top-left corner. The word 'HANNspree' is written in white, sans-serif font across the center of the square.

**HANNspree**

# All-In-One PC

SN22A1 series

## User's Manual

---

# Table of Contents

<b>Overview of your documentation.....</b>	<b>4</b>
Document type.....	4
Printed documentation .....	4
Non-printed documentation.....	4
Servicing .....	4
Typographics .....	4
<b>Package contents .....</b>	<b>5</b>
Standard items.....	5
<b>Getting to know the PC .....</b>	<b>6</b>
Touring the PC .....	6
Front view .....	6
Rear view .....	8
Right-side view.....	10
Left-side view .....	11
Wired keyboard and mouse.....	11
Special keyboard buttons (front view) .....	11
Overview of the wired mouse (front view).....	13
Indicator lights.....	13
<b>Setting up the PC.....</b>	<b>14</b>
Preparing to setup your PC .....	14
Connecting the power.....	16
Connecting the wired keyboard and mouse .....	16
Customizing the mouse settings.....	17
Turning on the PC.....	17
Turning off the PC.....	18
Turning off the display.....	18
Configuring the display .....	19
Brightness control .....	19
Volume control .....	20
Picture mode control .....	20

<b>Using the PC .....</b>	<b>21</b>
Connecting to the Internet .....	21
Connecting to a wired network.....	21
Connecting to a wireless network (for select models).....	22
Using the webcam .....	23
Using the optical disc drive .....	24
Inserting a disc.....	24
Reading a disc .....	26
Writing to a disc .....	26
Removing a disc .....	26
Using memory cards.....	27
Using the touch screen (for select models) .....	29
Selecting items with your touch screen.....	29
<b>Using the Peripheral Devices .....</b>	<b>30</b>
Connecting USB devices .....	30
Removing USB devices .....	31
<b>Cleaning and care.....</b>	<b>32</b>
Screen and computer .....	32
Cleaning the screen and computer .....	32
Storing your computer.....	33
CDs and DVDs (Recovery DVD and Driver CD) .....	33
Cleaning the discs.....	33
Keyboard and mouse.....	34
Cleaning your keyboard and mouse .....	34
<b>BIOS Setup Utility.....</b>	<b>35</b>
When to Use the BIOS Setup Utility .....	35
Navigating the BIOS setup screen.....	37
Main menu .....	38
Advanced menu .....	39
Security menu .....	42
Boot menu.....	44

---

Exit menu .....	46
<b>Troubleshooting .....</b>	<b>47</b>
Frequently asked questions (FAQ) .....	47
Power problems .....	47
Internet access problems .....	48
Optical discs problems .....	49
Display problems .....	50
Keyboard and mouse problems .....	51
Sound and microphone problems .....	52
Miscellaneous problems .....	53
<b>Specifications: SN22A1 .....</b>	<b>54</b>
Specifications .....	54
Regulatory Information .....	55
Trademark Notice .....	56

---

# Overview of your documentation

---

## Document type

Your documentation contains printed information and PDF user manuals to help you perform various tasks.

### Printed documentation

- **Quick Start Guide** provides information about setting up your computer.

### Non-printed documentation



- **User Manual** provides information about using your computer, cleaning and maintaining the monitor and the accessories, and the common solutions to the problems you may encounter while using your computer.
- **Recovery DVD and Driver Disc** (containing this manual) provides information about restoring your computer system to factory settings.

## Servicing

Do not attempt to service this product yourself, as opening or removing covers may expose you to the risk of electric shock and other hazards. If any of the above mentioned misuse or other accident such as dropping or mishandling occurs, contact qualified service personnel for servicing.

## Typographics

Special tips, notes, and cautions that appear throughout this manual are designed to ensure that you perform specific tasks properly, preventing unnecessary errors.

	<b>CAUTION:</b> Indicates important information to prevent potential damage to the unit and data, or personal injury caused by improper use.
	<b>NOTE:</b> Indicates additional information for particular situation.
	<b>TIP:</b> Indicates useful information for completing a task.





# Package contents

When unpacking please check you have the following items. If any are missing or damaged, please contact the place of purchase for a replacement. Retain the box and packaging in case you need to transport your personal computer in the future. The fitted foam packing is ideal for protecting the device during transport.

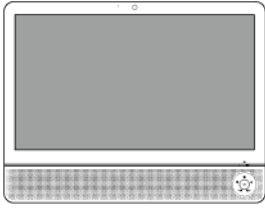
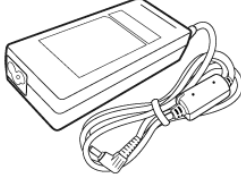

**The appearance and contents of your package may be different from those illustrated below due to regional variations.**

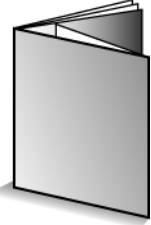
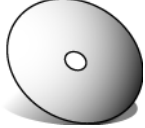
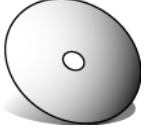
## Standard items

		
All-in-One PC	power adapter	power cord
		
Quick Start Guide	Driver CD	Recovery DVD
		
mouse	keyboard	

# Getting to know the PC

## Touring the PC





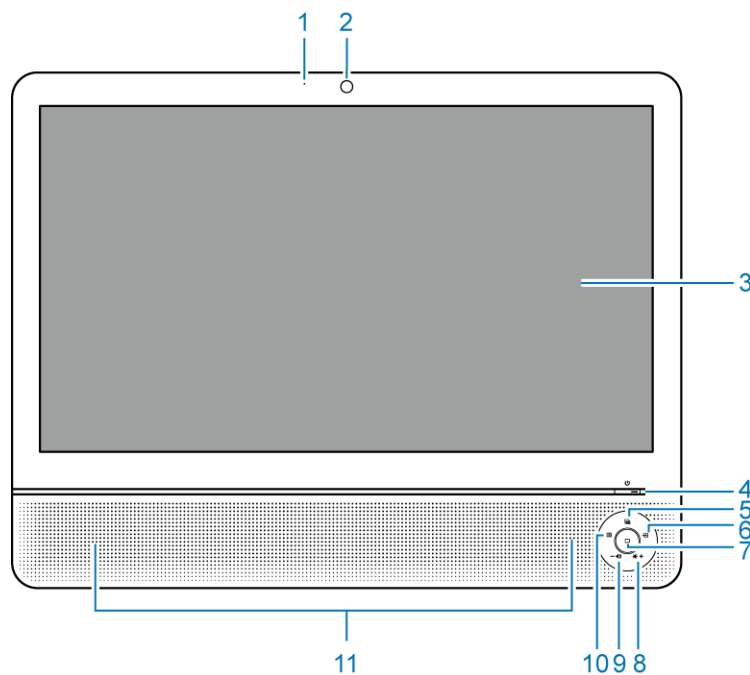

This section describes the views and the features of the controls, ports, buttons, components, and connectors of your computer.

### Front view

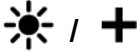
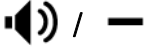

No.	Item	Description
1	<b>Built-in microphone</b>	The built-in microphone receives sounds and voices when used with the built-in webcam.
2	<b>Webcam</b>	The built-in camera allows you to capture still images, record videos, and have video chats.
3	<b>Touch-enabled widescreen (for select models)</b>	The monitor is equipped with touch screen. You may make adjustments to your work field at your fingertips. The touch screen will responsively react with your fingertip commands.
4		Power. Press to turn on your computer.

## Getting to know the PC





5		Picture mode switch. Press the key continually to select the mode which best suits the type of images shown on the screen. These modes include <b>Standard</b> , <b>Sport</b> , <b>Photo</b> , and <b>Movie</b> .
6		Input signal switch. Press to select the input signal that may have connected to your computer.
7		LCD display switch. Press to turn on or turn off the display. When the system is on, pressing the LCD display control will turn off the display and the built-in speakers.   <b>When the system is on, pressing the LCD display control will turn off the display and the built-in speakers.</b>
8		Brightness/Increase. Hotkey for LCD <b>Brightness</b> control / Press to make increase adjustment.
9		Volume/Decrease. Hotkey for LCD <b>Volume</b> control / Press to make increase adjustment.   <b>Volume function is only available for the HDMI input signal.</b>
10		Auto-adjust. Press to automatically optimize and adjust the screen while displaying video source from the D-sub input jack.
11	<b>Speakers</b>	The internal speakers deliver high-quality audio while listening to music or watching your home videos and DVD discs.



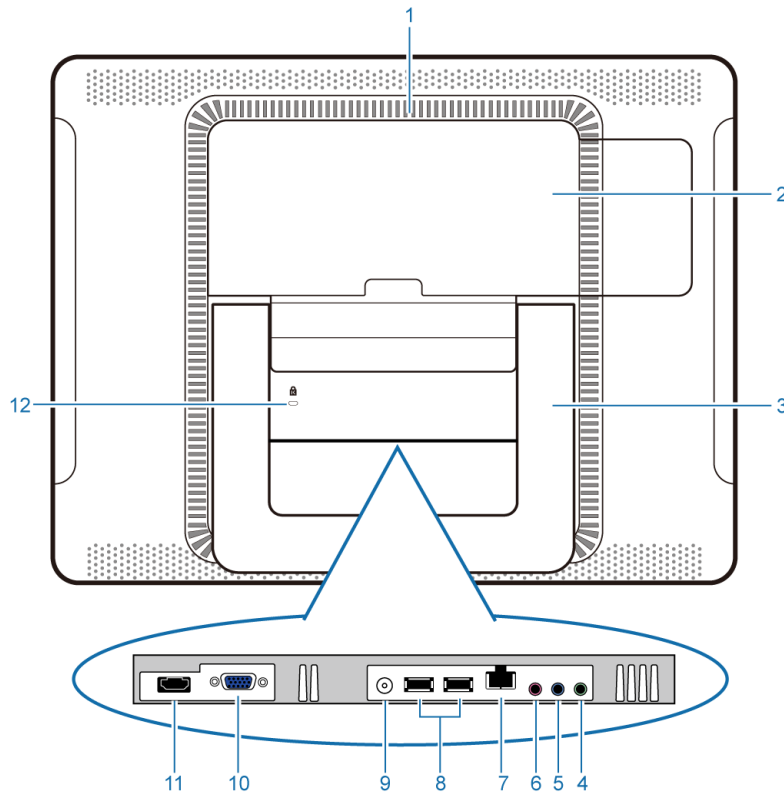



# Getting to know the PC

## Rear view



No.	Item	Description
1	<b>Vents</b>	The design of the vents is to prevent the computer from overheating. The internal fans blow hot air away from heat-sensitive components in the computer.
	 <b>Keep the vents clean and free of dirt and dust, as blocking it may cause serious thermal problems.</b>	
2	<b>Rear panel cover</b>	The hard drive and the memory module slots are located under the rear panel cover. You may access your hard drive and the memory module after removing the cover.
3	<b>Computer stand</b>	You can adjust the computer stand for the best viewing angle.
4		Audio/Headphone output jack. Connect your headphones or speakers to this jack to listen to the sound from your PC when watching videos and DVDs, listening to music, and playing games.
5		Audio input jack. Connect to an audio in jack on external audio equipment for audio sound.
6		Microphone input jack. Connect your microphone to this jack to record sound or voice.
7		LAN (Local Area Network) port. Use an Ethernet (RJ45) cable to connect your computer with a network or broadband device.

## Getting to know the PC

8		USB ports. Insert the USB plugs into the USB ports to connect your USB devices, such as MP3 players, digital cameras, keyboard and mouse, or external hard disk drives, etc.
9		DC IN port. Connect the power cord to this port to power the computer.
10		15-pin D-Sub input jack. Use a 15-pin D-Sub cable to connect other devices with D-Sub output port, such as notebooks, or game consoles, etc.
11	<b>HDMI</b>	HDMI input port. Use a HDMI cable to connect your devices with HDMI output ports, such as DVD players, or game consoles, etc.
12		Security lock slot. We recommend you to attach a security lock (sold separately) and cable (sold separately) to the slot to help prevent possible theft.

## Right-side view

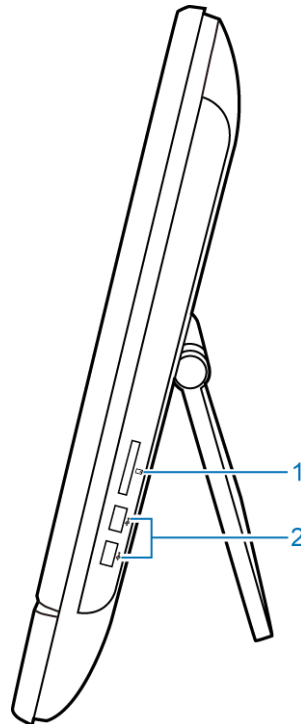

No.	Item	Description
1	<b>Media card reader</b>	Insert your memory card into this media card reader to access photos, audio and video files, or other data stored in the memory cards. This reader supports the following card types: <ul style="list-style-type: none"><li>• Secure Digital (SD)</li><li>• MultiMedia Card (MMC)</li><li>• Memory Stick (MS)</li><li>• Memory Stick Pro (MS Pro)</li></ul>
2	<b>USB ports</b>	Connect the USB plugs into the USB ports to connect your USB devices, such as MP3 players, digital cameras, keyboard and mouse, or external hard disk drives, etc.

## Left-side view

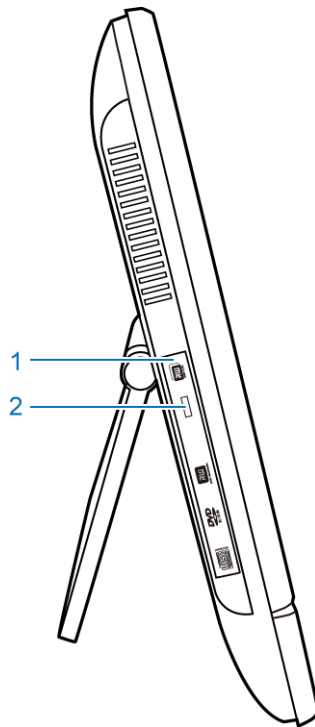

No.	Item	Description
1	<b>CD/DVD drive</b>	Press the <b>Eject</b> button and insert a CD/DVD into this drive to play your CD's collections, DVD movies, or access the data burned onto the discs.  To record a CD or DVD, press the <b>Eject</b> button to insert a recordable CD or DVD into this drive and burn the data with CD/DVD recording applications installed on your system.
2	<b>Eject button</b>	Press to open the disc tray.

## Wired keyboard and mouse

This section describes some information about the wired keyboard and mouse.

### Special keyboard buttons (front view)



**The appearance of the keyboard may vary by region.**

1. **<Caps Lock>**: Press to toggle between uppercase and lowercase text as you type.
2. **<My Computer>** key: Press to activate the **My Computer** window.

# Getting to know the PC

3. **Mute** key: Press to mute the volume.
4. **Volume down** key: Press to decrease the volume level.
5. **Volume up** key: Press to increase the volume level.
6. **Numeric keypad**: Use the numeric keypad to enter numbers and do calculations. Pressing <Num Lock> will activate or inactivate the numeric keypad.
7. **Cursor control keys** (left, right, up, down): Use these directional keys to move the mouse pointer to the desired location.
8. **<Application>** key: Press to open up the context menu which appears when you right-click the mouse.

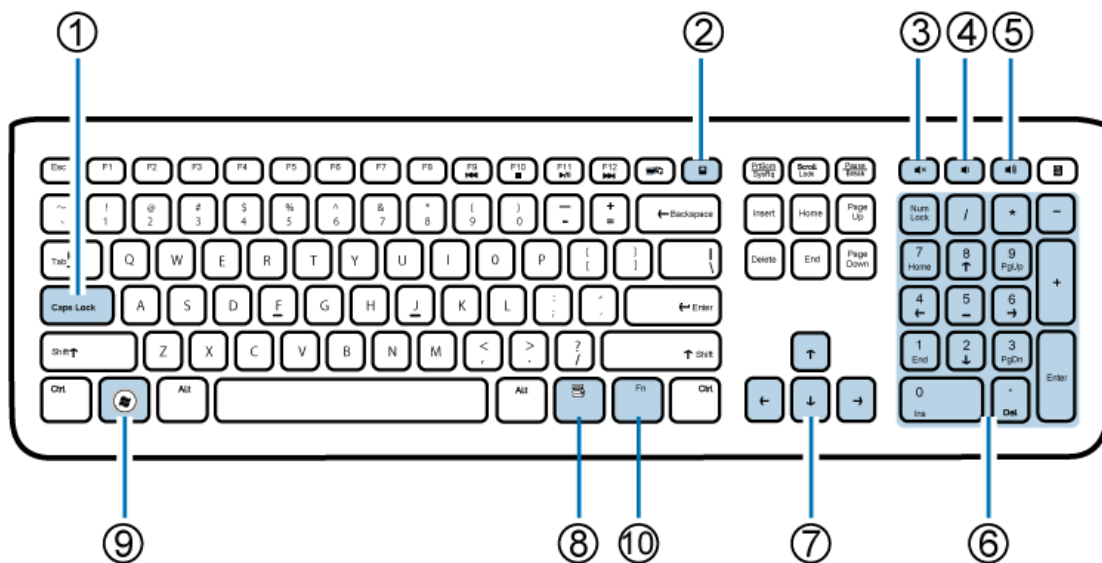

9. **<Windows>** key: Press to activate the **Start** menu.
  10. **<Fn>** (Function) key: Press to perform specific tasks.
- You can use the function hotkeys to quickly launch your favorite programs, files, and websites. To use the hotkeys, press and hold the <Fn> key, and then press the desired hotkey.

Function key	Performed task
<Fn> + <F9> (⏮)	Press to skip to the previous audio track or movie chapter.
<Fn> + <F10> (■)	Press to stop the playback.
<Fn> + <F11> (▶/  )	Press to start or pause the playback.
<Fn> + <F12> (⏭)	Press to play the next audio track or movie chapter.



**To adjust keyboard functionality, click "Start" at the bottom left corner of your screen, select "Control Panel" to open the "Adjusting your computer's settings" window, then select "Keyboard", and make adjustments in the opened "Keyboard Properties" dialog box according to your preference.**

## Overview of the wired mouse (front view)

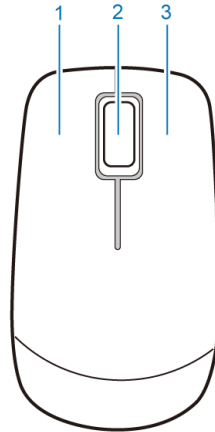

1. Left button: single-click or double-click to select items. To drag and drop items, click on the items and hold the left button, then drag them to the desired destination before releasing the button.
2. Central wheel: Rotate the wheel to scroll up and down a page.
3. Right button: Single-click to open a menu of the selected item.

## Indicator lights

The table below describes the status that LED indicators present.

	LED	Activities
1	<b>Power</b>	<ul style="list-style-type: none"><li>• When the computer is on, the LED indicator lights up in blue.</li><li>• When the computer is off, the LED indicator goes off.</li></ul>
2	<b>LCD display power</b>	<ul style="list-style-type: none"><li>• When the monitor is on, the LED indicator lights up in blue.</li></ul>
3	<b>CD/DVD drive activity</b>	<ul style="list-style-type: none"><li>• When the CD/DVD drive is in use, the LED indicator flashes green.</li><li>• When the CD/DVD drive is not in use, the LED indicator goes off.</li></ul>

---

# Setting up the PC

---

This section describes how to set up your computer and make adjustments to the monitor.

## Preparing to setup your PC

Before attempting to set up your computer, to protect the computer and monitor, you should:

- find a flat open area on your desk to position your computer
- place a soft item like the computer packaging bag on the desk for padding



**It is suggested to install your computer in a space that allows for airflow as restricting the airflow may cause overheating which could impact the performance of your computer.**

---

1. Gently lay the screen face down on a flat clean padded surface. Pull the computer stand apart from the computer.

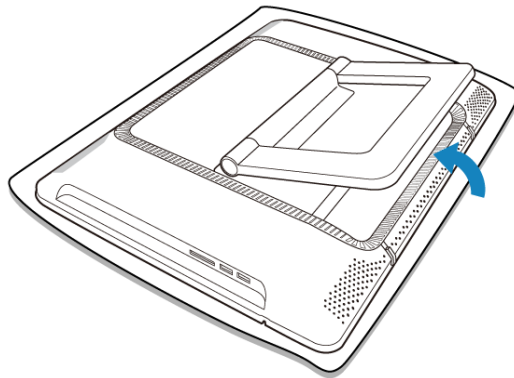

**Please ensure the computer stand has been pulled up to its fully extended position, so that your computer may stand firm and upright.**

---

2. Carefully lift the computer to set the best viewing angle by pulling the top of the display forward.

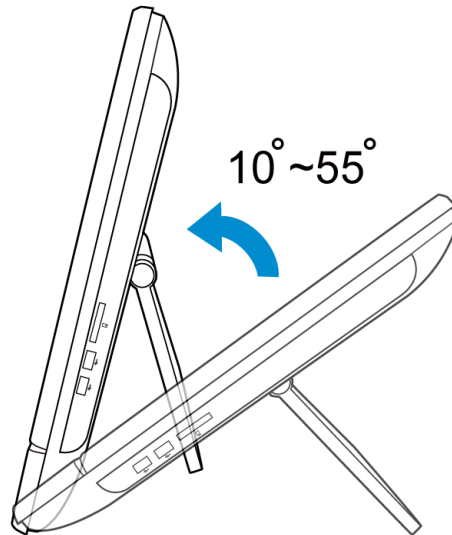

---

**Your computer is stable through a 45-degree range of motion, from upright 10° to 55° (leaning back).**

**As you pull the display forward, the stand will maintain the adjusted angle.**

---

Now you are ready to access some ports on the rear panel of the computer to make cable connections.



## Connecting the power



The illustrations may differ from product supplied for your region.

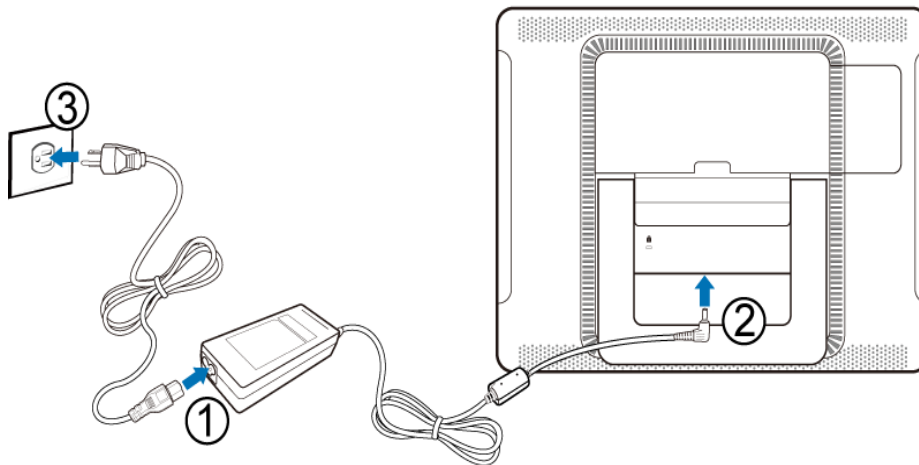

1. Connect the power cable to the supplied power adapter.
2. Connect the power plug to the power jack on the rear panel of the monitor.
3. Connect the power adapter to a nearby power outlet.



**Do not plug in or turn on the power to the computer until instructed to do so.**

## Connecting the wired keyboard and mouse

The complete computer installation includes the setup of the keyboard and mouse. Follow the procedures below to set up your keyboard and mouse.

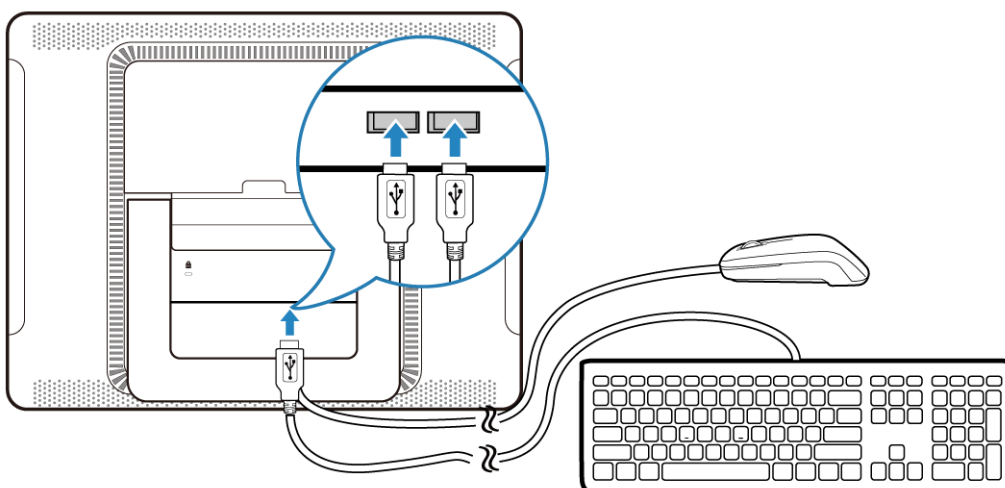

1. Connect the USB cable on the keyboard to a USB port on the rear panel of the computer.

2. Connect the USB cable on the mouse to the other USB port on the rear panel of the computer.



- **It is recommended that you use the USB ports on the rear panel for devices that usually remain connected, such as keyboards and mouse.**
- **For information about using the keyboard shortcut keys and mouse, see Special keyboard buttons (front view) and Overview of the wired mouse (front view).**

## Customizing the mouse settings

You may configure the mouse settings to meet your personal preferences. To modify the mouse settings, follow the procedures below.

1. Click the **Start** menu at the bottom left corner of your screen.
2. Select **Control Panel** to open the **Adjusting your computer's settings** window.
3. Select **Mouse** to open the **Mouse Properties** dialog box.
4. Make adjustments according to your preference.

## Turning on the PC

After you finish the installation of your computer, press the **Power** button on the front panel of the computer to turn it on. Then follow the on-screen instructions to complete the initial setup.

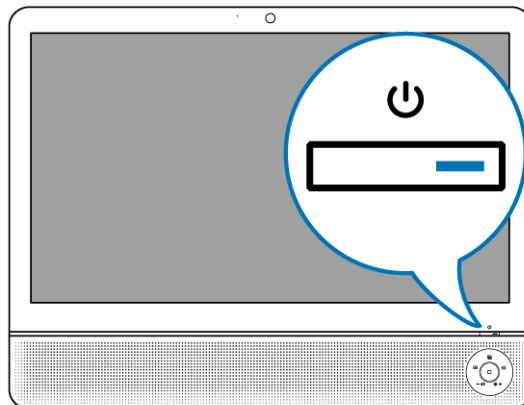

## Turning off the PC

To turn off the system, close all the active windows, and then click the **Start** menu at the bottom left corner of your screen, and then click **Shut Down** on the right side of the open tab.

Alternatively, after closing all the active windows, you may press the **Power** button on the front panel of the computer to turn off the system.

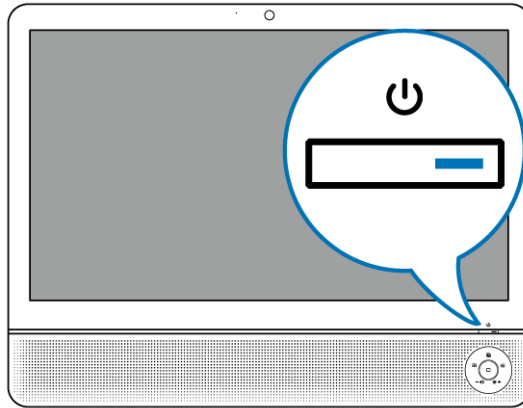

## Turning off the display

To save power, you may press the **LCD display switch** button to turn off the LCD monitor power when not in use. Pressing the same button again will turn on the screen.

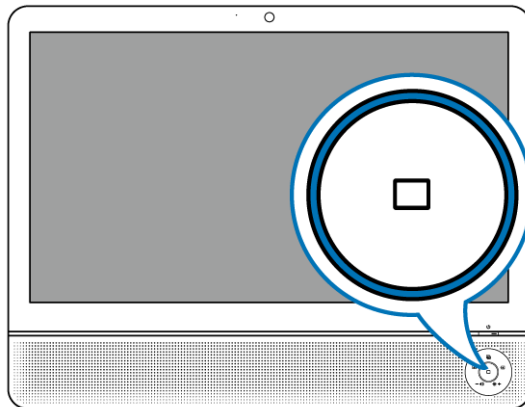

**Pressing the LCD display switch button will only turn off the monitor, and the system is still operating.**

## Configuring the display

You may press the **Auto-adjust** button to automatically optimize and adjust the screen settings while displaying video source from the D-sub input jack.

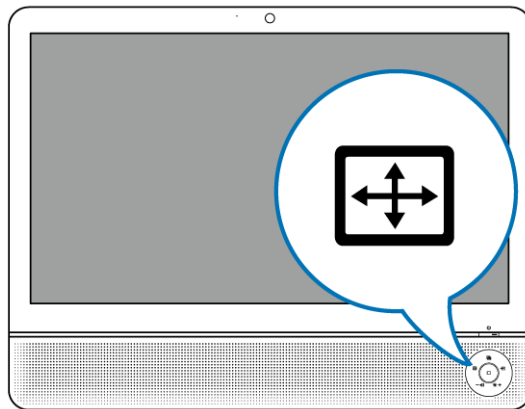

## Brightness control

To adjust the brightness level of the monitor, press the **Brightness/Increase** button to display the **Brightness** indicator, and then press the same button to increase the level or press the **Volume/Decrease** button to decrease the level.

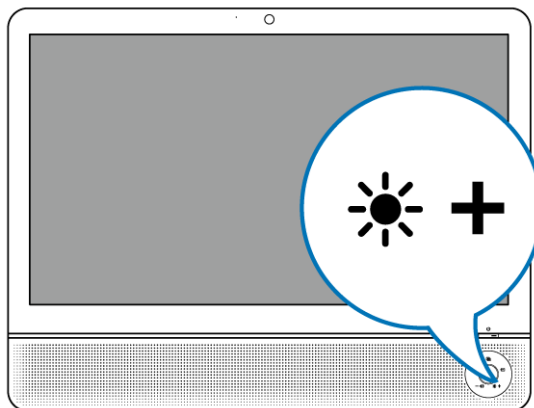

## Volume control

To adjust the sound level, press the **Volume/Decrease** button to display the **Volume** indicator, and then press the **Brightness/Increase** button to increase the level or press the **Volume/Decrease** button to decrease the level.

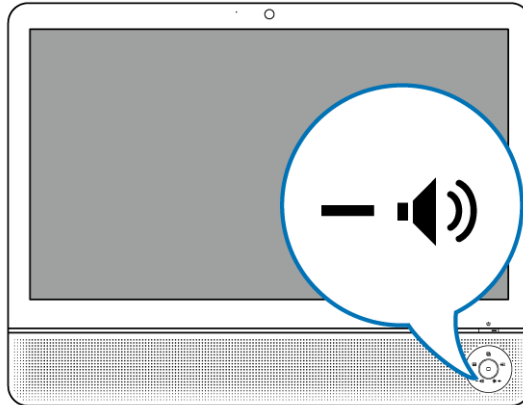

**The Volume function is only available for the HDMI input signal.**

## Picture mode control

To display the contents of images in an optimal mode, continuously press the **Picture mode** button to switch among **Standard**, **Sport**, **Photo**, and **Movie**. Each mode has its own preset picture settings.

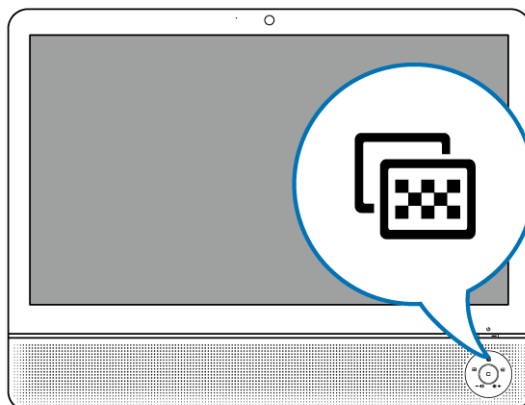

Picture Mode	Descriptions
Standard	for basic PC application
Sport	for viewing motion pictures such as sports
Photo	for viewing still images
Movie	for viewing videos

---

# Using the PC

---

This section describes more tasks your computer can perform, including connecting to the Internet, using the Webcam to communicate with your family and friends, enjoying your digital entertainment from CD and DVD, reading and writing to your memory cards, and taking control of your computer via the touchscreen technology.

## Connecting to the Internet

With the access to the Internet you can browse the Web, send e-mail or exchange instant messages with friends and family.

Before attempting to build the Internet connectivity with either a wired or wireless local area network, you need to purchase high-speed Internet service from an Internet service provider (ISP). Your ISP will offer various Internet connection options, and assist you in setting up the Internet access through them.

To set up your computer to access the Internet connection, the following items are needed:

- Broadband modem (DSL or cable) purchased from your Internet service provider (ISP).
- An Ethernet cable (sold separately)
  - to connect your computer and the broadband modem, or
  - to connect the broadband modem and a wireless router or access point which serves as an access point station to make transmission possible. (for a wireless network)
- For a wireless network connection, a wireless LAN (Local Area Network) card for your computer to connect with the router or access point. (sold separately; a built-in wireless LAN card is supplied with select models only.)



**For details about installing the wireless LAN card, router, or access point, please refer to the manuals that shipped with the product you purchased or contact that manufacturer.**

---

## Connecting to a wired network

1. Ensure the local area network is properly set up.
  - You have purchased the Internet service from an ISP.
  - You have set up the broadband modem (DSL or cable).
2. Connect the computer LAN port to the modem with an Ethernet cable.

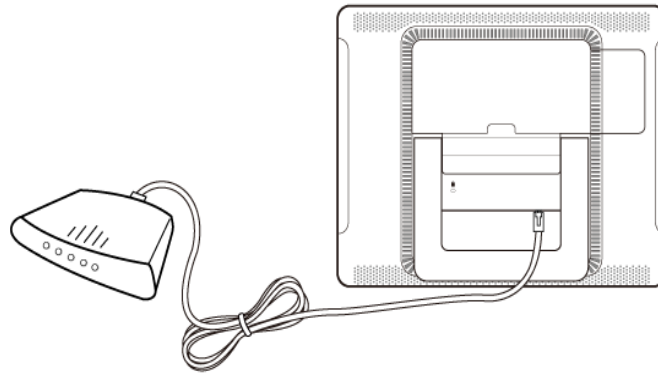



3. Open the Web browser and access any Web site to test the network connection.

## Connecting to a wireless network (for select models)

Wireless LAN (WLAN) connectivity has limited range, depending upon the equipment being used, the chosen frequency band, radiowave interference, and the physical landscape, including building structure. Circumstances will vary depending upon your particular situation.

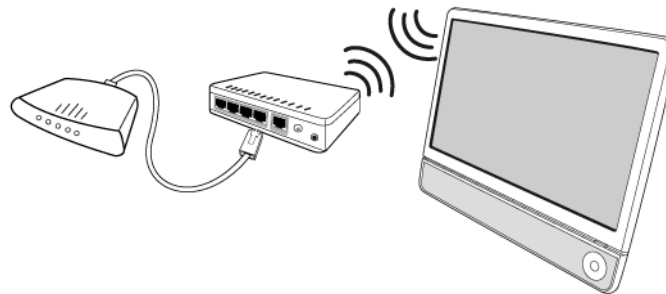
1. Make sure you
  - are located within the wireless network service area.
  - have purchased the Internet service from an ISP.
  - have inserted the wireless LAN card to the computer and installed its drivers.
  - have set up the broadband modem (DSL or cable).
  - have connected the modem to the wireless router or access point with an Ethernet cable.



2. Click the **Wireless Network** icon in the system tray, , to open a list of available wireless networks.
3. Choose a network you intend to join from the list.

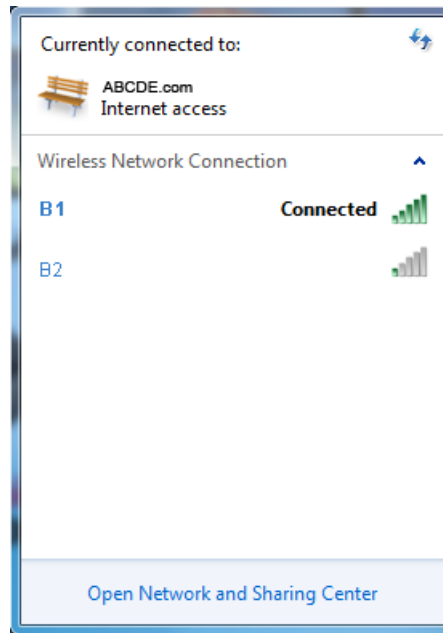

**If the selected network requires security authentication, please enter user name and password.**

4. If you are able to successfully connect to a wireless network, you will receive a message indicating that the connection has been established.
5. Open the Web browser and access any Web site to test the network connection.



**To disable WLAN manually, click "Disconnect" from the Wireless Network Connection list.**

## Using the webcam

Your computer comes with a built-in 1.3 megapixel webcam at the top center of the bezel. With this webcam, you can capture still images or record videos via the preinstalled image capture software, or you can chat online in real time via instant message programs.



**Check the ambient light conditions around the webcam to avoid getting images that appear too dark or too light.**



## Using the optical disc drive

Your computer comes with an optical disc drive, which supports music CDs, video CDs and DVD. You can also use it to burn CD-R/CD-RW or DVD+R/DVD-R/DVD+RW/DVD-RW/DVD-RAM discs.

The following tables show which formats are supported by the optical disc drive.

### CD-writable drives

Media Type	Read	Write	Rewritable
CD-R	Yes	Yes	Yes
CD-RW	Yes	Yes	Yes

### DVD-Writable drives

Media Type	Read	Write	Rewritable
CD-R	Yes	Yes	Yes
CD-RW	Yes	Yes	Yes
DVD+R	Yes	Yes	Yes
DVD-R	Yes	Yes	Yes
DVD+RW	Yes	Yes	Yes
DVD-RW	Yes	Yes	Yes
DVD-RAM	Yes	Yes	Yes

## Inserting a disc



**When the optical disc drive is in use, the indicator lights up and flashes. When the indicator light is flashing, do not move the computer.**

1. Press the **Eject** button on the drive, as shown below.

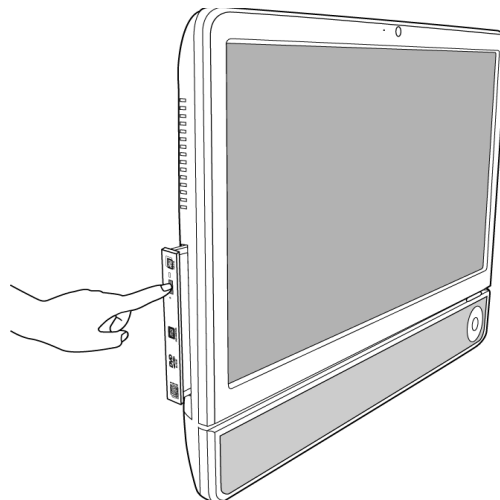

2. Gently pull out the disc tray.

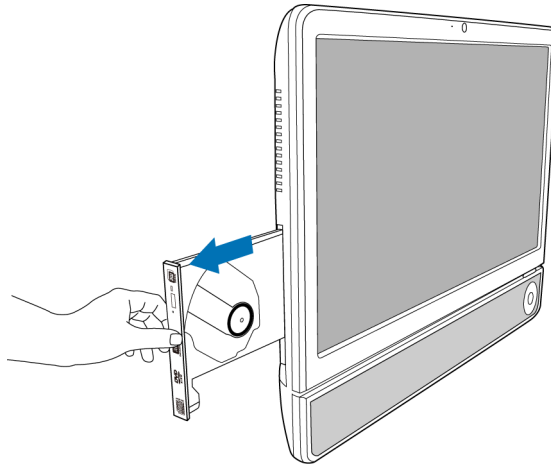

3. With the label side facing forward, place the disc in the center of the disc tray.

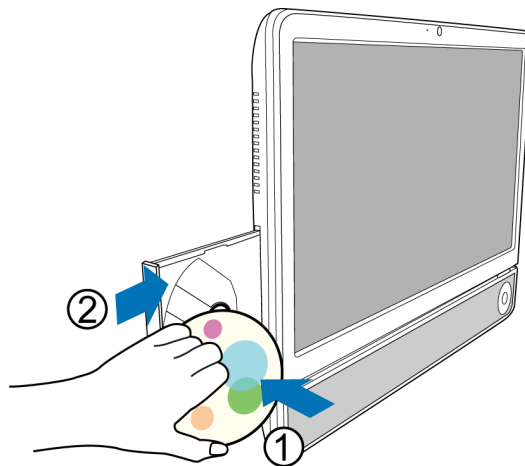

4. Gently push the disc tray back into the disc slot.
5. The optical disc drive indicator is on and your computer will start to read the disc you just inserted.

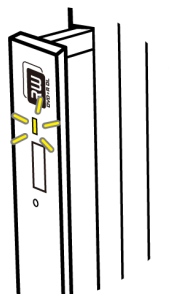

## Reading a disc

1. Follow the steps in the “**Inserting a disc**” section.
2. When prompted, choose the desired program to play the inserted disc.



**If no window appears on the desktop, click “Start”, select “All Programs”, and then select the desired software to play the inserted disc. For more instructions about the selected software, please see its manual or online help.**

## Writing to a disc



**Ensure that the discs you create do not violate copyright laws.**

1. Follow the steps in the “**Inserting a disc**” section.
2. When prompted, choose the desired program to record files to the inserted rewritable disc.



**If no window appears on the desktop, click “Start”, select “All Programs”, and then select the desired disc copying software to create your disc. For more instructions about the selected software, please see its manual or online help.**

3. Follow the on-screen instructions to complete burning process.

## Removing a disc

1. Ensure the optical disc driver indicator is off.
2. Press the **Eject** button on the drive.

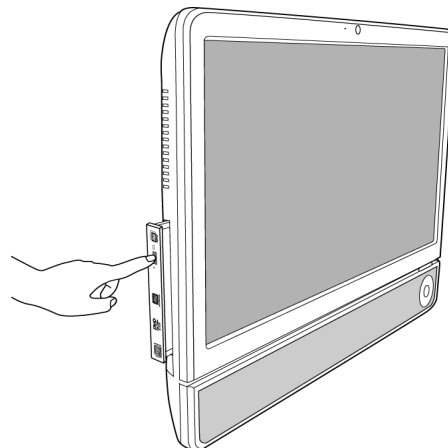

3. Pull out the disc tray and remove the disc.

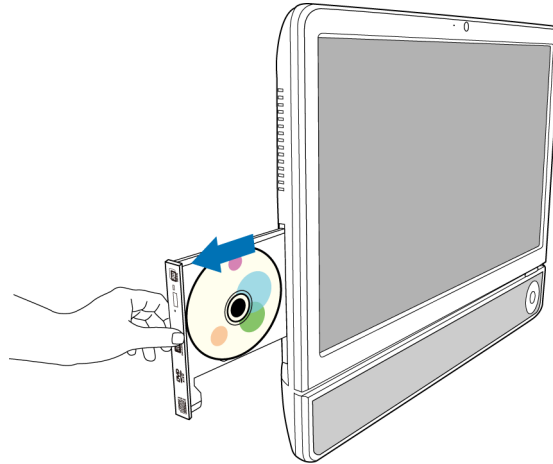

**Alternatively, you may click "Start", select "Computer" to open the Computer window, then right-click the disc drive icon, and select "Eject" from the menu.**



**If the disc tray doesn't open, please restart your system and repeat the above procedures.**

4. Gently push the disc tray back into the disc slot.

## Using memory cards

Your computer comes with a 4-in-1 media card reader which allows you to exchange and share your data stored on your memory cards with other devices, such as your mobile phones and digital cameras.

The media card reader supports the following memory card types:

- Secure Digital (SD)
- MultiMedia Card (MMC)
- Memory Stick (MS)
- Memory Stick Pro (MS Pro)

To use the media card reader, follow the direction arrow on your memory card to insert it into the slot until it clicks into place. Insert the card with the metallic connectors facing towards you.

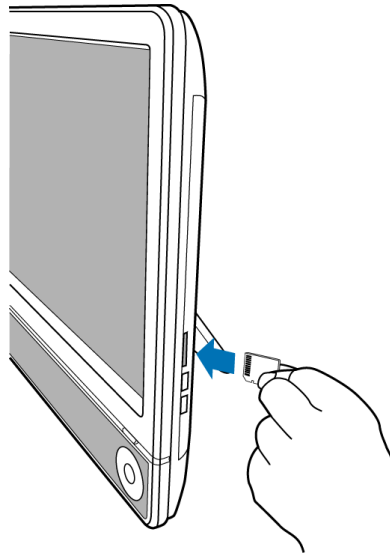

Your system will automatically detect the inserted memory card and then display the content of the memory card.



---

**If no window appears on the desktop, click "Start", select "Computer" to open the Computer window, then double-click the memory card icon to access the data stored on the memory card. If the Computer window does not show any memory card icon, check if the memory card is inserted in the correct direction.**

---

To remove a memory card, click **Start**, select **Computer** to open the **Computer** window, and right-click the memory card icon, then select **Eject** from the menu, and do not remove the memory card until you have saved any changes.

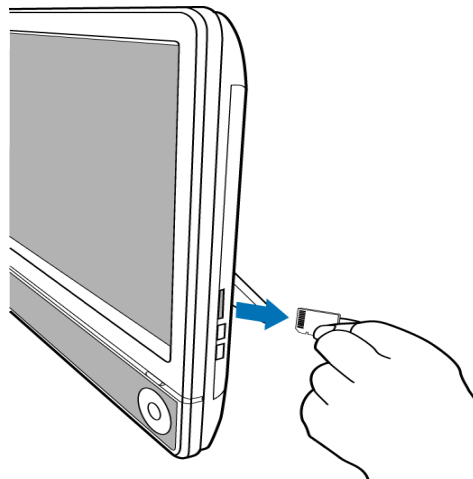

---

**Never remove the memory card or turn off the computer while the media card reader is still reading or writing files from the card, or you may lose data.**

---



---

**Always remove the inserted memory card from the media card reader before you turn off the computer.**

---

## Using the touch screen (for select models)

Your computer is equipped with a touch screen which has a high sensitivity level. You can control your PC with the touch of your finger or by using a stylus pen. Your fingertips and stylus pen work as the hand-held mouse pointer. When you control the computer with your fingertips on the screen, the hand-held mouse can work concurrently.

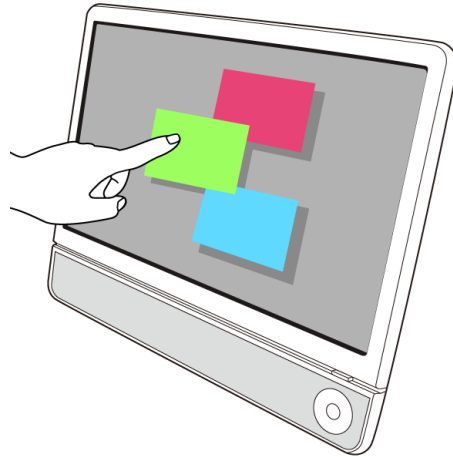

---

**When you press LCD display switch button to turn off the LCD monitor, the touch screen is still active. To avoid accidental or unintentional activation and inactivation of the functions or programs while the monitor is turned off, do not touch on the screen surface while the system is still running.**

---



---

**Do not apply pressure on the front of the display or around the screen borders to avoid damaging the touch screen. For more details about maintaining and cleaning the LCD screen, please see Cleaning the screen and computer.**

---

## Selecting items with your touch screen

Use the touch screen as follows:

- Tap once for a single mouse click.
- Tap twice for a double mouse click
- Press and hold an item to open the item's menu, then move your finger to the appropriate menu item. When you remove your finger, the item is selected.

---

# Using the Peripheral Devices

---

## Connecting USB devices

Your computer comes with 4 USB ports; two on the side panel and the other on the rear panel. To expand the functionality of your computer, you may connect your USB peripherals, such as digital still camera, digital video camera, printer, floppy disk drive. etc., to the USB ports of your computer.

To connect USB peripherals to the USB port, please follow the procedures below.

1. Choose a USB port you wish to use.

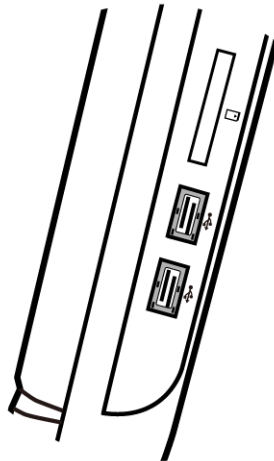

**It is recommended that you use the USB ports on the rear panel for devices that usually remain connected, such as your keyboard and mouse.**

---

2. If your USB device hasn't been connected with the USB cable, connect one end of the USB cable into the USB port on your device.
3. Connect the other end of the USB cable into the computer's USB port.



**The following USB device illustration is for reference only.**

---

# Using the Peripheral Devices

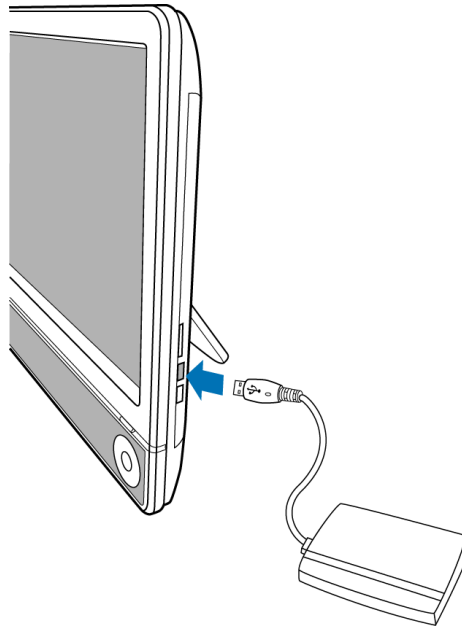

**There is only one direction to make the connection. Incorrect direction will cause damage to the USB device.**

4. Your system will automatically detect the connected USB device. You may review the contents of the device in the Windows Explorer.

## Removing USB devices

To avoid data or equipment damage while removing the USB devices from the computer, please always follow the procedures below.

1. Ensure all files or programs accessing the connected USB devices are closed.
2. Click the **Safely Remove Hardware and Eject Media** icon in the system tray.
3. Choose **Eject USB Flash Drive** from the opened menu.
4. A message appears in the system tray to notify that it is now safe to remove the hardware device.
5. Gently remove the USB device from the USB port on the computer.



---

# Cleaning and care

---

Your computer, keyboard, and mouse need occasional cleaning to prolong their life. Please read this section carefully to ensure proper care of your monitor, keyboard and mouse.

## Screen and computer

As your LCD screen is a product made of glass which is equipped with high touchscreen technology, it is recommended that you should handle the screen and computer with special care while performing maintenance on them, since vibrations or inappropriate operation may reduce the life of the devices.

- Slots and openings on the back or top of the cabinet are for ventilation. They must not be blocked or covered. Your computer should never be placed near or over a radiator or heat source, or in a built-in installation unless proper ventilation is provided.
- Never push objects or spill liquid of any kind into this product.
- To help maintain the best image quality on your monitor, use a screen saver and turn off your monitor when you are not using your computer.

## Cleaning the screen and computer

To get rid of the dust or fingerprints, be sure to clean the computer case and display regularly. The following procedures should be followed when cleaning your monitor:

- Turn off your computer.
- Disconnect the computer power cord from the rear panel of the computer. (Pull the plug, not the cord.)
- To clean the computer case, use a soft cloth dampened with water to wipe the case clean, and do not use solvents or abrasives.
- To clean the dust or fingerprints on the screen, gently wipe the screen with a dry, soft, and lint-free cloth to avoid any unwanted scratches. If using quality screen cleaner to remove the dirt on the screen surface as necessary, apply a small amount of the cleaner onto the cloth, and then carefully wipe the screen surface with it. Never spray cleaner directly onto the screen.

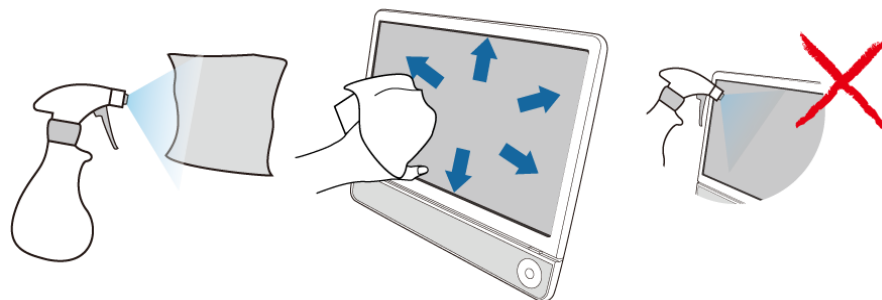

## Storing your computer

If you need to store your computer for an extended period of time, unplug your computer from the electric outlet and remove all connected cables before any action is taken. When transporting your computer, we recommend you pack the computer in its original packaging.

## CDs and DVDs (Recovery DVD and Driver CD)

Your computer is shipped with a System Recovery DVD and a Driver CD. In case you need them for future usage, always store them in the original sleeves to avoid scratches and dirt, and keep them in a safe place.

## Cleaning the discs

If you notice problems while playing the CDs or DVDs, such as skipping, try to clean the discs by following the procedures below.

1. Hold the outer edge of the disc.
2. Use a soft lint-free cloth to wipe your CD or DVD (the unlabeled side) in a straight line from the center to the outer edge of the disc.

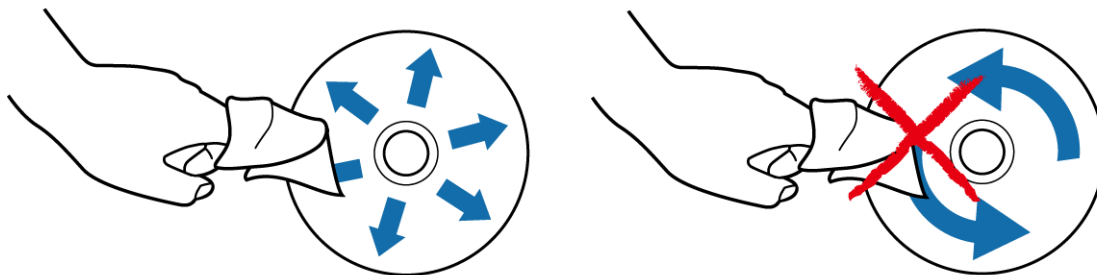

**To avoid damaging the surface of your disc, never wipe in a circular motion around the disc.**



**For stubborn spots or dirt, you can use a soft lint-free cloth moistened with some water or mild detergent to wipe across the disc, starting from the inside out in straight line, rinse the disc well, and then allow it to air dry completely.**

## Keyboard and mouse

### Cleaning your keyboard and mouse

Before starting to clean the keyboard or mouse, unplug the USB cable to disconnect the keyboard from the computer. To properly disconnect the USB cable, see **Removing USB devices**.

1. For wireless keyboard or mouse only, if your keyboard or mouse has a power button, turn it off.
2. For wireless keyboard or mouse only, remove installed batteries from the battery compartment.
3. For the keyboard, use a can of compressed air (purchased separately) to blow away any dust between the keys on the keyboard. You may even turn the keyboard upside to remove the dust trapped between the keys.
4. Use a soft lint-free cloth moistened with some water to wipe the keys and chassis of your keyboard or mouse. Do not allow water to seep into the internal components of keyboard or mouse.
5. Before reassembling and reconnecting the keyboard or mouse, ensure they are completely dry.

---

# BIOS Setup Utility

---

**BIOS Setup Utility** is a program for configuring the BIOS (Basic Input/Output System) settings of the computer.

BIOS is a layer of software called firmware that translates instructions from other layers of software into instructions that the computer hardware can understand. The BIOS settings are needed by your computer to identify the types of installed devices and establish special features.

This chapter tells you how to use the **BIOS Setup Utility**.

## When to Use the BIOS Setup Utility

You need to run the **BIOS Setup Utility** when:

- You see an error message on the screen requesting you to run Setup.
- You want to restore the factory default settings.
- You want to modify some specific settings of the hardware.
- You want to modify some specific settings to optimize system performance.



**The BIOS setup screen shown in this chapter is for your reference only. The actual items or settings on your system may differ.**

---

To run BIOS setup, press the <Delete> key immediately when the system boots. The startup page screen shows up for only a few seconds, so you must press the <Delete> key at the time. The BIOS setup main screen will appear as follows.

# BIOS Setup Utility

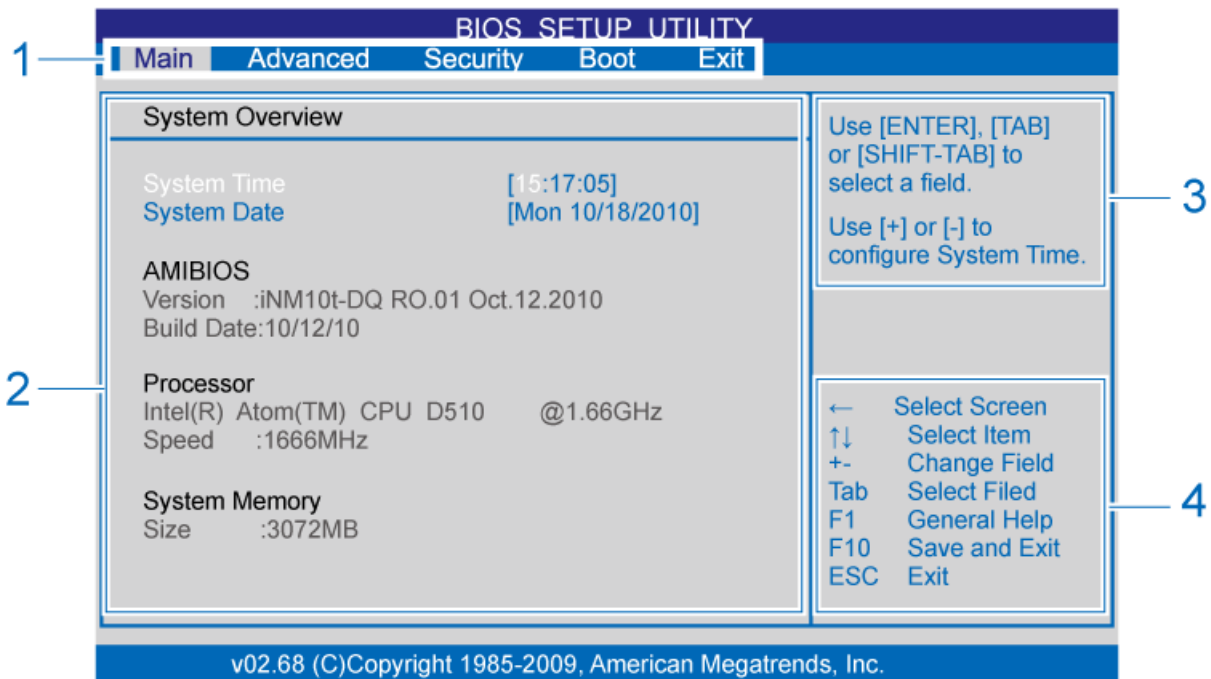

The BIOS Setup Utility screen can be divided into four areas:

Area	Descriptions
1	Displays the available menus for your computer. These menus are: <ul style="list-style-type: none"> <li>• <b>MAIN</b> - sets up the basic system configurations</li> <li>• <b>ADVANCED</b> - sets up the advanced settings</li> <li>• <b>SECURITY</b> - sets up the security settings</li> <li>• <b>BOOT</b> - configures the default system device that is used to locate and load the operating system</li> <li>• <b>EXIT</b> - exits the current menu or the BIOS Setup</li> </ul>
2	Displays information or options regarding the current settings of the system.
3	Displays brief information about the current option selected.
4	Displays keyboard instructions for moving around and making selections.

## Navigating the BIOS setup screen

Keyboard information can be found at the bottom of the screen. The following table lists the keys and their corresponding functions:

Key(s)	Function
<F1>	Launches the <b>General Help</b> screen.
<<-><->>	Moves between the menus on the title bar.
<↑><↓>	Moves to the previous or next item.
<Enter>	Enters the submenu or bring up the Options screen.
<+><->	Increases or decrease the values.
<Esc>	Leaves the current screen or exit the BIOS setup screen.
<F2><F3>	Changes the BIOS setup screen color.
<F7>	Discards the changes.
<F9>	Restores the settings to default values.
<F10>	Saves the changes and leaves the BIOS setup screen.

## Main menu

The **Main** menu contains the basic configuration settings of the system and shows some system information, such as the BIOS version, CPU type and speed, and the system memory, etc.

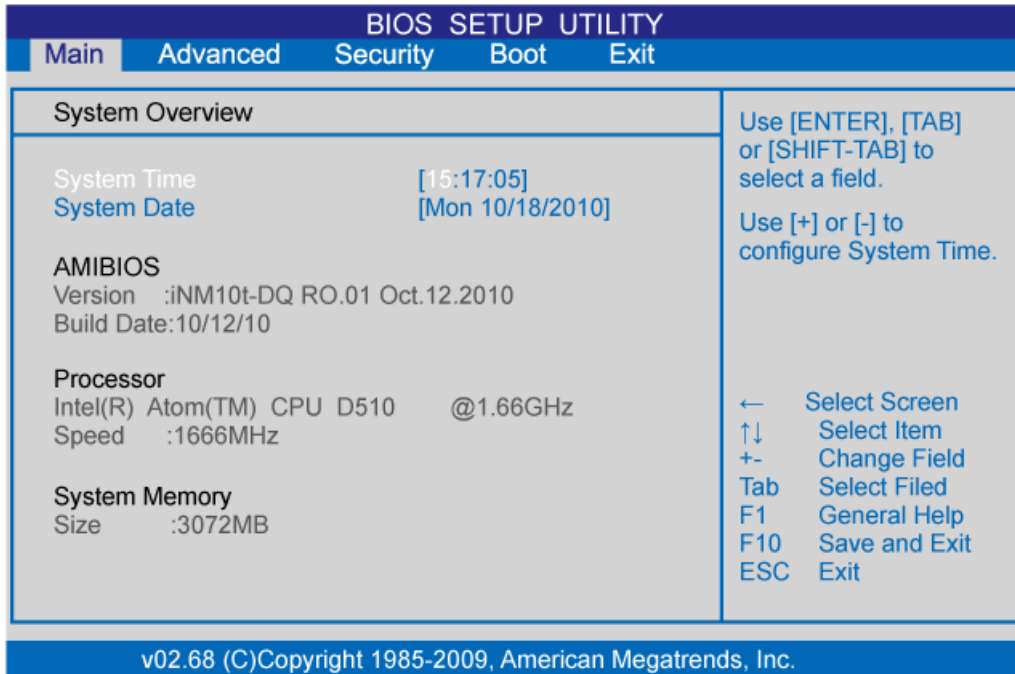

A brief description of the adjustable menus displays in the **Descriptions** box below.

Menu	Descriptions
<b>System Time (hour:minute:second)</b>	Allows you to set the time of the system. Use <Enter>, <Tab>, or <Shift> + <Tab> to move between fields, and then press <+> or <-> to change the value.
<b>System Date (day month/date/year)</b>	Allows you to set the date of the system. Use <Enter>, <Tab>, or <Shift> + <Tab> to move between fields, and then press <+> or <-> to change the value.

## Advanced menu

The **Advanced** menu allows you to configure the settings of CPU, I/O (Input/Output) settings, and other system devices.



**If you are not familiar with the items in the Advanced menu, you are advised to keep the default.**

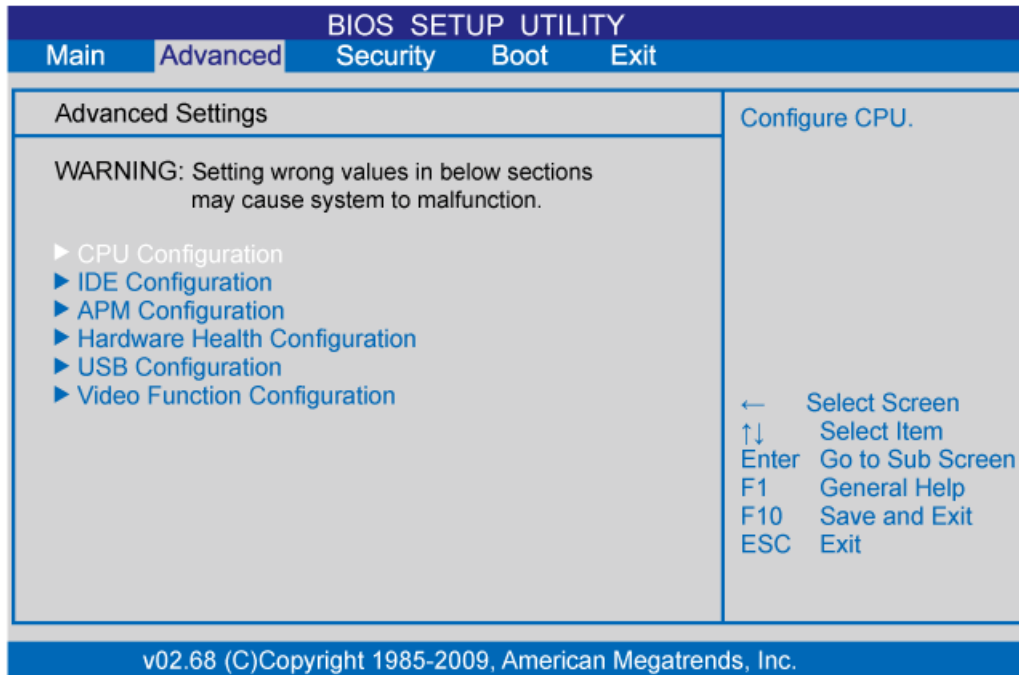

A brief description of the adjustable menus displays in the **Descriptions** box below.

Menu	Descriptions
<b>CPU Configuration</b>	Selects to display the information about your CPU.
<b>IDE Configuration</b>	Selects to display the basic information about your CD drives and hard disk drives.



<b>APM Configuration</b>	<p>Selects to make advanced power management settings.</p> <ul style="list-style-type: none"><li>• <b>USB Device Wakeup From S3:</b> Enabling this will allow you to use a USB device to wake up the system.</li><li>• <b>Restore on AC Power Loss:</b> Sets the system state when an unexpected power outage or shutdown occurs.<ul style="list-style-type: none"><li>• <b>Power Off:</b> The system remains off after power is restored.</li><li>• <b>Power On:</b> The system reboots after the power is restored.</li><li>• <b>Last State:</b> The system returns to the state at the time the power outage or shutdown occurred.</li></ul></li><li>• <b>Resume On LAN:</b> Enabling this will wake up the system when a wake-up signal is received from the network.</li><li>• <b>Resume On RTC Alarm:</b> Enabling this will allow you to specify the Date, Hour, Minute, and Second for the system to boot up.</li></ul>
<b>Hardware Health Configuration</b>	<p>Selects to make hardware health monitoring settings.</p> <ul style="list-style-type: none"><li>• <b>Shutdown Temperature:</b> Enabling this will allow you to set up the system shutdown temperature from a range of 95 °C to 105 °C.</li><li>• <b>H/W Health Function:</b> Enabling this will display the hardware condition of your system. Selecting <b>Disabled</b> will hide these information.</li></ul>
<b>USB Configuration</b>	<p>Selects to display the information about your USB.</p>

<b>Video Function Configuration</b>	<p>Selects to control the video memory allocation.</p> <ul style="list-style-type: none"><li>• <b>DVMT Mode Select:</b> Sets the allocation method of video memory.<ul style="list-style-type: none"><li>• <b>Fixed Mode:</b> A fixed portion of the system memory is reserved as video memory.</li><li>• <b>DVMT Mode:</b> Video memory is dynamically allocated from system memory depending on demand.</li></ul></li><li>• <b>DVMT/FIXED Memory:</b> Specifies the amount of DVMT / FIXED system memory to allocate for video memory.</li></ul>
-------------------------------------	--

## Security menu

The **Security** menu allows you to set password in order to safeguard your system against unauthorized use.

The first time you enter this menu, the **Supervisor Password** and **User Password** fields will display “**Not Installed**”. You may select **Change Supervisor Password** and **Change User Password** to set the passwords.

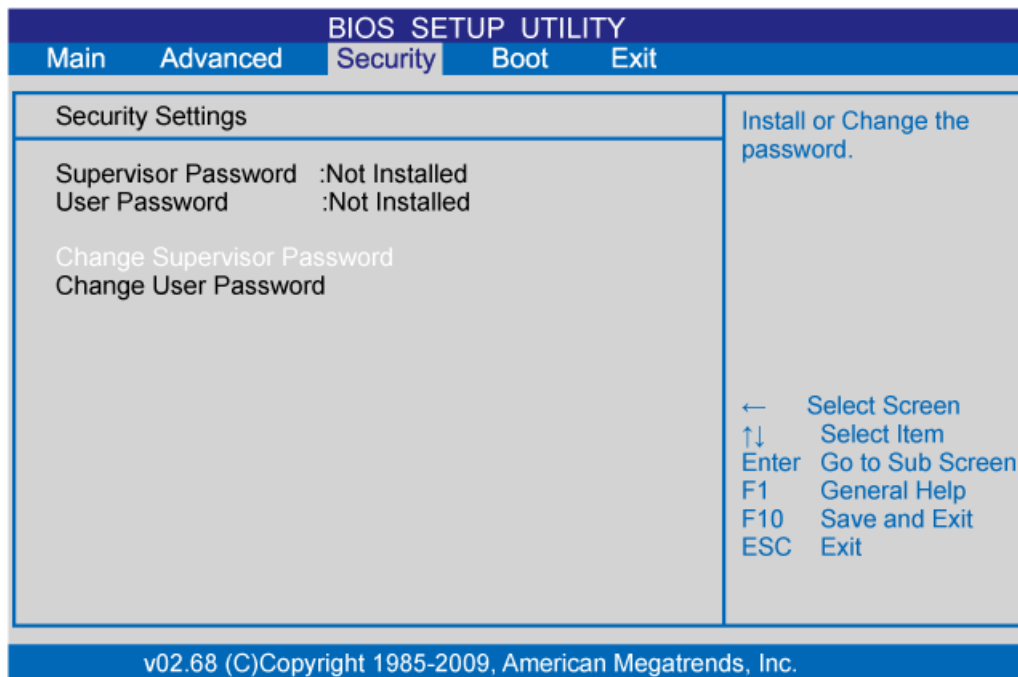

A brief description of the adjustable menus displays in the **Descriptions** box below.

Menu	Descriptions
<b>Change Supervisor Password</b>	<p>The <b>Supervisor Password</b> controls access to the whole BIOS setup menu. Sets or changes the password up to six characters, then press &lt;Enter&gt;. When asked to confirm the password, type the password again and press &lt;Enter&gt; to save the changes.</p> <p>When the <b>Supervisor Password</b> is installed, you may select the <b>User Access Level</b> option to further define the security level of users.</p>
<b>Change User Password</b>	<p>The <b>User Password</b> controls access to some of the BIOS setup options. Sets or changes the password up to six characters, then press &lt;Enter&gt;. When asked to confirm the password, type the password again and press &lt;Enter&gt; to save the changes.</p>
<b>Clear User Password</b>	<p>Cancels the installed <b>User Password</b>.</p>

## Password check

- **Setup:** The password is required when you access the BIOS setup main screen.
- **Always:** The password is required both at boot and when you access the BIOS setup main screen.



**Do NOT set the BIOS security password without having memorized it or written it down and stored it with your computer warranty documentation.**

## Boot menu

The **Boot** menu displays all the bootable devices present on the system. It offers options for setting boot device priority and boot setting configurations.

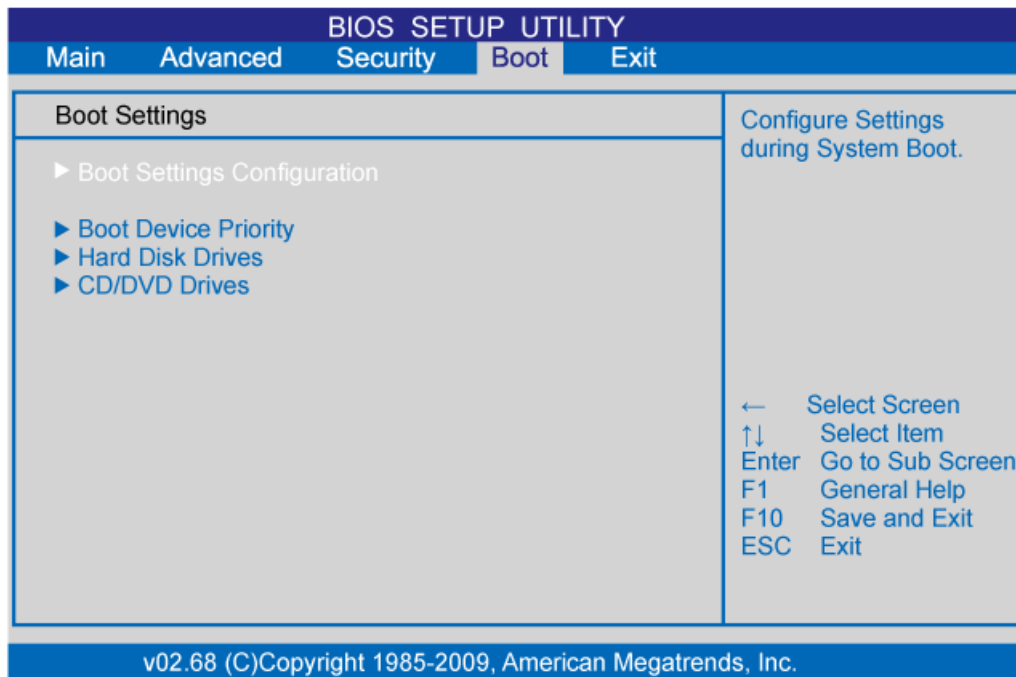

A brief description of the adjustable menus displays in the **Descriptions** box below.



**Depending on your computer and installed devices, the menus listed below may vary with those appeared on your menu.**

Menu	Option	Descriptions
<b>Boot Settings Configuration</b>	<ul style="list-style-type: none"> <li>• Quiet Boot</li> </ul>	<p><b>Enabled:</b> Skips the countdown progress bar during the boot process.</p> <p><b>Disabled:</b> Displays normal POST messages during the boot process.</p>
	<ul style="list-style-type: none"> <li>• Wait For 'F1' If Error</li> </ul>	<p><b>Enabled:</b> When an error is detected, the BIOS will halt the boot sequence. You have to press &lt;F1&gt; to access the BIOS setup menu.</p> <p><b>Disabled:</b> When an error is detected, the system will continue to boot into the operating system.</p>
<b>Boot Device Priority</b>	Sets the boot device priority sequence from the option list which displays the available devices.	

# BIOS Setup Utility

<b>Hard Disk Drives</b>	Specifies the boot device priority sequence from the available hard disks.
<b>CD/DVD Drives</b>	Specifies the boot device priority sequence from the available CD/DVD drives.

## Exit menu

This menu allows you to save or discard the new settings, and load the optimal or failsafe default settings.

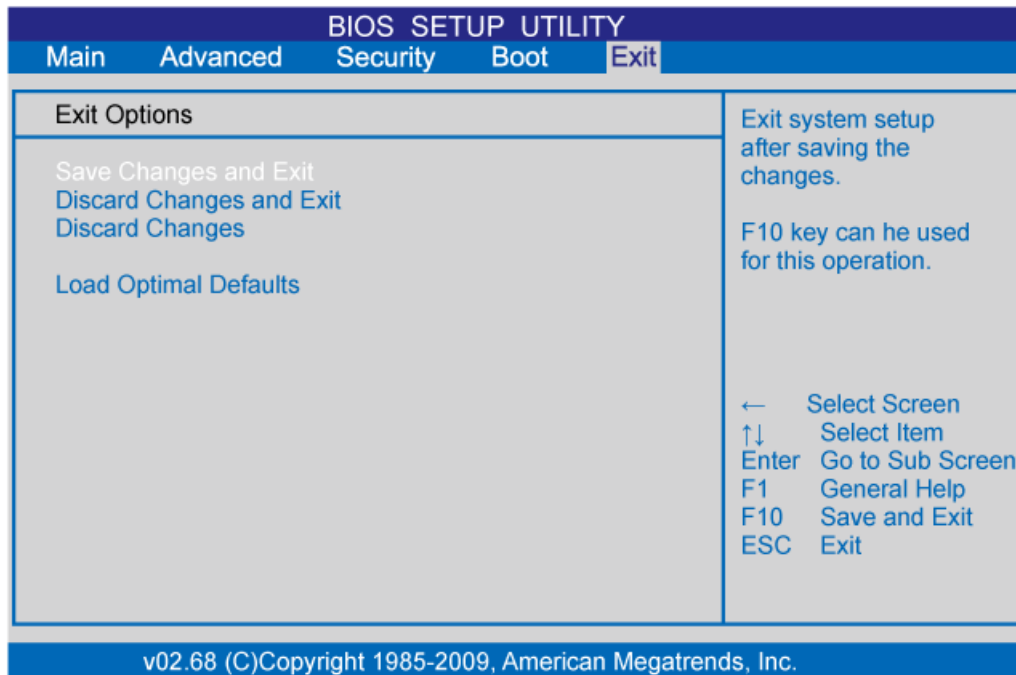

A brief description of the adjustable menus displays in the **Descriptions** box below.

Menu	Descriptions
<b>Save Changes and Exit</b>	Saves the configurations you have made and exits the BIOS setup screen. The <F10> key is the hotkey for this option.
<b>Discard Changes and Exit</b>	Allows you to exit BIOS setup without saving the settings and restarts the system. The <Esc> key is the hotkey for this option.
<b>Discard Changes</b>	Discards any changes. The <F7> key is the hotkey for this option.
<b>Load Optimal Defaults</b>	Loads the optimal default values to all the system settings. The <F9> key is the hotkey for this option.

# Troubleshooting

The section describes situations that you may encounter while using the computer and provides troubleshooting steps.

Before you begin troubleshooting, verify the following items:

- If you have added or removed a program or a hardware before the problem appeared, make sure that your computer has met all the pre-installation requirements, review if the installation procedures are correct, and check if the program or hardware is properly installed.
- If an error message appears while the program or hardware is in use, write down the message and follow the on-screen instruction if any. For further details, refer to the documentation or user manual of the program or hardware.

## Frequently asked questions (FAQ)

### Power problems

Symptom	Possible solution
<b>I have pressed the Power button, but my computer cannot start up.</b>	<ul style="list-style-type: none"><li>• Check the power cable and power adapter are connected.</li></ul>
	<ul style="list-style-type: none"><li>• Check the <b>Power</b> button indicator.<ul style="list-style-type: none"><li>- If the indicator does not light up, your computer is not being supplied power from an external power source via the power adapter. Check the connection between your computer, the power adapter, and the nearby outlet.</li><li>- If the indicator flashes in blue, your computer has entered Sleep mode. Move your mouse or click any button on the keyboard to wake the system.</li><li>- If the <b>Power</b> button indicator lights up in blue, the computer is being supplied normally with power. Reconnect the power adapter and restart the system.</li></ul></li></ul>
	<ul style="list-style-type: none"><li>• Check if the <b>LCD display power</b> indicator stays in blue.<ul style="list-style-type: none"><li>- If the indicator flashes white, your monitor has entered Sleep mode. Press the <b>Power</b> button on the front panel to turn on the screen.</li></ul></li></ul>
	<ul style="list-style-type: none"><li>• Certain operating system files may be damaged or missing. If so, you have to back up all your data first, and then recover your system. Check the supplied System Recovery DVD and Driver CD for details.</li></ul>



## Internet access problems

Symptom	Possible solution
<b>My computer cannot access a modem or a wireless router or access point.</b>	<ul style="list-style-type: none"><li>• Verify that you have performed a correct pre-installation for your Internet connection type.<ul style="list-style-type: none"><li>- If you are using a wireless Internet connection, make sure that your computer has installed a wireless LAN card in order to connect with a wireless router or access point. For details about setting up your wireless router or access point, refer to the documentation or user manual of the unit. For details about setting up your modem, contact your ISP (Internet service provider) for assistance.</li><li>- If you are using a wired Internet connection, make sure that your computer is using an Ethernet cable, instead of a telephone cable, to connect with the broadband modem which is purchased from your ISP. For assistance setting up your modem, contact your ISP.</li></ul></li></ul>
<b>The wireless Internet connection is unstable.</b>	<ul style="list-style-type: none"><li>• Check the wireless interference.<ul style="list-style-type: none"><li>- Reset your wireless router or access point to factory defaults and reconfigure the settings. For details about setting your wireless router or access point, refer to the documentation or user manual of the unit.</li><li>- Update the firmware of your wireless router or access point to the latest version available on the manufacturer's site.</li><li>- Try moving the wireless router or access point in a central position. A couple of feet will sometimes make a big difference in signal strength.</li><li>- If you are using an access point, try changing the channel, as another access point may be interfering.</li><li>- Contact your ISP to ensure they are not experiencing technical problems.</li></ul></li></ul>

## Optical discs problems

Symptom	Possible solution
When a CD or DVD is inserted into the optical disc drive, there is no response.	<ul style="list-style-type: none"> <li>• Check the optical disc drive indicator is on.</li> </ul>
	<ul style="list-style-type: none"> <li>• Check the inserted disc is not dirty, bent, or damaged. If you need to clean the disc, see <b>Cleaning the discs</b>.</li> </ul>
	<ul style="list-style-type: none"> <li>• Check if the disc is properly inserted into the optical drive, with the label side facing toward you and the disc is centered in the tray.</li> </ul>
	<ul style="list-style-type: none"> <li>• Try another CD or DVD (preferably an unused one) to test if the optical disc drive works well.</li> </ul>
	<ul style="list-style-type: none"> <li>• If you are inserting a DVD, check the region of the disc. It may not comply with the region set for your optical disc drive. Check the DVD package to learn if the region code is compatible with your optical disc drive.</li> </ul>
	<ul style="list-style-type: none"> <li>• Try using other programs to read the data on your CD or DVD.</li> </ul>
The inserted disc doesn't slide out when I press the Eject button.	<ul style="list-style-type: none"> <li>• Ensure the computer is on.</li> </ul>
	<ul style="list-style-type: none"> <li>• Ensure the optical disc driver indicator is on while you press the <b>Eject</b> button on the optical disc drive.</li> </ul>
	<ul style="list-style-type: none"> <li>• Click <b>Start &gt; Computer</b>, right-click the disc drive icon, and then select <b>Eject</b> from the menu to remove the disc.</li> </ul>
	<ul style="list-style-type: none"> <li>• Try restarting your computer and then try pressing the <b>Eject</b> button on the optical disc drive again.</li> </ul>
	<ul style="list-style-type: none"> <li>• If the <b>Eject</b> button does not work, open the tray by inserting a sharp, pointed object into the hole next to the <b>Eject</b> button.</li> </ul>
I cannot write (burn) a disc (CD or DVD).	<ul style="list-style-type: none"> <li>• Check if the disc is properly inserted into the optical drive, with the label side facing toward you and the disc is centered in the tray.</li> </ul>
	<ul style="list-style-type: none"> <li>• Check the inserted disc is not dirty, bent, or damaged. If recording stops during a recording session, the disc probably is damaged. Please remove it and insert a different disc.</li> </ul>
	<ul style="list-style-type: none"> <li>• Ensure that the inserted disc is writable, and it must be blank or appendable (with space to add more data files).</li> </ul>
	<ul style="list-style-type: none"> <li>• Try writing the disc with other recording programs as some programs cannot write certain disc types. <ul style="list-style-type: none"> <li>- If you intend to write data to DVD, make sure that you are recording the data with a DVD burning program.</li> </ul> </li> </ul>
	<ul style="list-style-type: none"> <li>• Select a slower write speed if you are not under a time constraint.</li> </ul>
	<ul style="list-style-type: none"> <li>• Check if the added data files exceed the available space on the inserted writable disc.</li> </ul>
	<ul style="list-style-type: none"> <li>• Ensure that there is enough space available on the hard disk drive to store the temporary files that are created during the writing process. <ul style="list-style-type: none"> <li>- Click <b>Start &gt; Computer</b> to check the space available on your hard disk drive.</li> </ul> </li> </ul>

## Display problems

Symptom	Possible solution
There is nothing visible on the screen.	<ul style="list-style-type: none"> <li>• Check the power cable and power adapter are well connected.</li> </ul>
	<ul style="list-style-type: none"> <li>• Check the <b>Power</b> button indicator.               <ul style="list-style-type: none"> <li>- If the indicator does not light up, your computer is not being supplied power from an external power source via the power adapter. Check the connection between your computer, the power adapter, and the nearby outlet.</li> <li>- If the indicator flashes in blue, your computer has entered Sleep mode. Move your mouse or click any button on the keyboard to wake the system.</li> <li>- If the <b>Power</b> button indicator lights up in blue, the computer is being supplied normally with power. Reconnect the power adapter and restart the system.</li> </ul> </li> </ul>
	<ul style="list-style-type: none"> <li>• Check if the <b>LCD display power</b> indicator stays in blue.               <ul style="list-style-type: none"> <li>- If the indicator flashes white, your monitor has entered Sleep mode. Press the <b>Power</b> button on the front panel to turn on the screen.</li> </ul> </li> </ul>
	<ul style="list-style-type: none"> <li>• Check if the brightness level of the display is adjusted correctly, and is not set too low or too high. Use the <b>Brightness</b> control by pressing the <b>Brightness/Increase</b> or <b>Decrease</b> buttons on the front panel to adjust the brightness level.</li> </ul>
The images on the screen are too large or too small, or the images are blurred.	<ul style="list-style-type: none"> <li>• Press the <b>Auto-adjust</b> button on the front panel of the computer.</li> </ul>
	<ul style="list-style-type: none"> <li>• Check if the monitor is running at its native resolution.               <ul style="list-style-type: none"> <li>- Right-click the desktop, and then select <b>Screen Resolution</b>. In the opened window, set the <b>Resolution</b> to 1920 x 1080, and then click <b>Apply</b> and <b>OK</b> to complete the settings.</li> </ul> </li> </ul>
The images on the screen are too bright or too dark.	<ul style="list-style-type: none"> <li>• Press the <b>Auto-adjust</b> button on the front panel of the computer.</li> </ul>
	<ul style="list-style-type: none"> <li>• Check if the brightness level of the display is adjusted correctly, and is not set too low or too high. Use the <b>Brightness</b> control by pressing the <b>Brightness/Increase</b> or <b>Decrease</b> buttons on the front panel to adjust the brightness level.</li> </ul>

## Keyboard and mouse problems

Symptom	Possible solution
Keyboard or mouse commands are not recognized by the computer.	<ul style="list-style-type: none"> <li>• If you are using a wired keyboard or mouse, check the cable connection between the unit and your computer.</li> <li>• If you are using a wireless keyboard or mouse, check the following items. <ul style="list-style-type: none"> <li>- Ensure the USB receiver is properly connected to the computer, and the keyboard or mouse is within its range.</li> <li>- If your keyboard or mouse has a power button, turn it on.</li> <li>- Press the <b>Connect</b> button on the keyboard or mouse to rebuild the connection between the unit and your computer.</li> <li>- Try replacing the batteries in the wireless keyboard or mouse.</li> <li>- Restarting the system to detect the wireless connection again.</li> </ul> </li> </ul>
I cannot type numbers using the numeric keypad.	<ul style="list-style-type: none"> <li>• Check if the <b>Num Lock</b> indicator on your keyboard is on. <ul style="list-style-type: none"> <li>- If the <b>Num Lock</b> indicator is off, that means the numeric keypad is not activated. Press the &lt;Num Lock&gt; key to activate the numeric keypad.</li> </ul> </li> </ul>
The cursor moves slowly and does not respond to the movement of the mouse.	<ul style="list-style-type: none"> <li>• If you are using a traditional mouse, check the following items. <ul style="list-style-type: none"> <li>- Use a mouse pad or other rough surface under the mouse.</li> <li>- Clean the mouse. Remove the mouse compartment cover and ball from the mouse and carefully wipe the mouse ball with a moistened cloth or scrap the rollers with a piece of firm paper to remove any dirt. Then leave the mouse ball for a while to dry out before reassembling the mouse.</li> </ul> </li> <li>• If you are using an optical mouse (either wired or wireless), refer the following items. <ul style="list-style-type: none"> <li>- Use a mouse pad or white sheet of paper under the mouse.</li> <li>- Clean the mouse by gently wiping the light sensor lens on the bottom of the mouse with a lint-free cloth.</li> </ul> </li> </ul>
The cursor moves too fast or too slow.	<ul style="list-style-type: none"> <li>• You may configure the cursor speed to meet your personal preferences. <ul style="list-style-type: none"> <li>- Click <b>Start &gt; Control Panel &gt; Mouse</b> to open the <b>Mouse Properties</b> dialog box.</li> </ul> <p>Click <b>Pointer Options</b> tab and drag the <b>Motion</b> slider toward <b>Slow</b> or <b>Fast</b> to adjust the speed at which the cursor responds to mouse movement.</p> <p>When done, click <b>OK</b> to finish the configuration.</p> </li> </ul>

## Sound and microphone problems

Symptom	Possible solution
I hear noise when connecting a headphone to the computer.	<ul style="list-style-type: none"> <li>• Check if the earphone works well.                             <ul style="list-style-type: none"> <li>- Connect the earphone to other devices, such as a radio, to see if you can still hear that noise. If the noise persists, the earphone may be out of order.</li> </ul> </li> </ul>
	<ul style="list-style-type: none"> <li>• If you hear the noise only while inserting the earphone to the computer, it is resulted from high instantaneous current. This is a normal phenomenon.</li> </ul>
I do not hear sound from the built-in speakers.	<ul style="list-style-type: none"> <li>• Check if the speaker volume is set too low or is muted.                             <ul style="list-style-type: none"> <li>- Click the volume icon, , in the system tray to check the Windows volume controls.</li> <li>- If you are using a program which has its own volume control, ensure the volume level is properly set.</li> </ul> </li> </ul>
	<ul style="list-style-type: none"> <li>• Unplug your headphone and external microphone if they have been connected to your computer.</li> </ul>
The external microphone does not work.	<ul style="list-style-type: none"> <li>• Check if the external microphone is properly connected into the microphone jack on your computer.</li> </ul>
Certain audio files cannot be played, and the Codec error messages appear.	<ul style="list-style-type: none"> <li>• Check if Windows Media Player is set to automatically download codecs.                             <ul style="list-style-type: none"> <li>- Right-click on the menu bar, select <b>Tools</b> from the opened menu, and then click <b>Options</b>. On the <b>Player</b> tab, in the <b>Automatic updates</b> area, select <b>Once a day</b>, and then click <b>Apply</b> and <b>OK</b> to complete the settings.</li> </ul> </li> <li>Then try playing the file again. If the audio file still cannot be played, it might require a codec that is not supported by Windows Media Player.</li> <li>For more information about available codecs, see the documentation for Windows Media Player at the Microsoft web site.</li> </ul>

## Miscellaneous problems

Symptom	Possible solution
<p><b>Certain video files cannot be played, and the Codec error messages appear.</b></p>	<ul style="list-style-type: none"> <li>• Check if Windows Media Player is set to automatically download codecs.               <ul style="list-style-type: none"> <li>- Right-click on the menu bar, select <b>Tools</b> from the opened menu, and then click <b>Options</b>.</li> <li>- On the <b>Player</b> tab, in the <b>Automatic updates</b> area, select <b>Once a day</b>, and then click <b>Apply</b> and <b>OK</b> to complete the settings.</li> </ul> </li> </ul> <p>Then try playing the file again. If the video file still cannot be played, it might require a codec that is not supported by Windows Media Player.</p> <p>For more information about available codecs, see the documentation for Windows Media Player at the Microsoft web site.</p>
<p><b>The media card reader cannot read my memory card.</b></p>	<ul style="list-style-type: none"> <li>• Ensure that the memory card is fully inserted into the card reader slot.</li> <li>• Ensure that the memory card is one of the supported types. For more information, see <b>Media card reader</b>.</li> <li>• Try restarting your computer.               <ul style="list-style-type: none"> <li>- When the computer is turned on, insert the card again.</li> <li>- Never insert or remove your memory cards when they are still in use, as this can cause loss of data or permanent damage to the card.</li> </ul> </li> </ul>
<p><b>USB devices quit working unexpectedly.</b></p>	<ul style="list-style-type: none"> <li>• Check if your USB devices are turned on.               <ul style="list-style-type: none"> <li>- Some USB devices are designed to conserve battery power by turning off automatically after a few minutes of inactivity. For example, your digital camera. Check if the connected USB device is turned on.</li> </ul> </li> <li>• Check if the USB port is working well.               <ul style="list-style-type: none"> <li>- Try using another USB port to connect your USB device and see if the device is detected.</li> <li>- Try connecting a low-powered USB device, such as a wired mouse, to the USB port to check if the port is working well.</li> </ul> </li> <li>• If you are using a USB hub, the power requirements of the USB port may be exceeded.               <ul style="list-style-type: none"> <li>- Try connecting your USB device directly to the USB port on your computer.</li> </ul> </li> <li>• Check if you need to pre-install software before connecting your USB device. Read the documentation or user manual of the product.</li> </ul>

# Specifications: SN22A1

## Specifications

Model	SN22A1
Processor	Intel® Pine-View (1.66Ghz, Dual Core) D510
Chipset	Tiger Point NM10
Operating System	Microsoft Windows 7 Home Premium
Memory Type	SODIMM type, two slots
Memory Capacity	3GB
Hard Drive	<ul style="list-style-type: none"><li>• One 2.5-inch hard-drive</li><li>• SATA 5400rpm 320GB</li></ul>
Graphics	Processor: Intel® GMA3150 integrated graphics
Adapter	65 Watt AC Adapter 100 - 240V at 50/60 Hz
Display	<ul style="list-style-type: none"><li>• 21.5" Widescreen Full HD TFT LCD (1920 x 1080 resolution)</li><li>• Brightness: 220 nits (typical)</li><li>• Contrast Ratio: 1000:1 (typical)</li><li>• Response Time: 5 ms (typical)</li><li>• Tilt: 10° - 55° (touch screen)</li></ul>
Ports and Connectors	<ul style="list-style-type: none"><li>• Audio in Jack: 1</li><li>• Headphone Jack: 1</li><li>• Microphone Input: 1</li><li>• Ethernet Port: 1</li><li>• USB Port(s): 4 (2.0 compliant)</li><li>• D-Sub (VGA) Input: 1</li><li>• HDMI Input: 1 (optional)</li><li>• DC-In: 1</li></ul>
Keyboard	USB keyboard and USB mouse
Media Card Reader	4-in-1 memory card reader (MS/MS-Pro/SD/MMC)
Network	Integrated 10/100/1000 (Gigabit) Ethernet
Wireless Network (for select models)	802.11 b/g/n Wireless Networking

Optical Drive (for select models)	8x super multi-format DVD +/- RW dual layer drive (up to 8.5 GB) <ul style="list-style-type: none"> <li>• Write Max.: 8x DVD+R, 8x DVD-R, 6x DVD+R DL, 6x DVD-R DL, 8x DVD+RW, 6x DVD-RW, 5x DVD-RAM, 24x CD-R, 24x CD-RW</li> <li>• Read Max.: 8x DVD-ROM, 24x CD-ROM</li> <li>• Slim form factor</li> </ul>
Web Camera (for select models)	1.3 Megapixel Web Cam and digital microphone
Audio	<ul style="list-style-type: none"> <li>• Sound System: 5.1 Chanel High Definition Audio</li> <li>• 3D stereo enhanced sound system</li> <li>• Speakers (Total): 2 W + 2 W stereo speakers</li> </ul>
Environment Requirements	<ul style="list-style-type: none"> <li>• Operating Temperature: 0 °C - 35 °C</li> <li>• Storage Temperature: -20 °C - 60 °C</li> <li>• Operating Relative Humidity: 10% ~ 85% Non-condensing</li> <li>• Storage Relative Humidity: 10% ~ 85% Non-condensing</li> </ul>
Dimension	527.4 mm (W) x 407.05 mm (H) x 52.4 (D) mm
Net Weight	5.93 kg
Gross Weight (including adaptor/power cord/keyboard/mouse/bag)	8.3 kg



**Intel®**, the Intel logo, Intel Core, and Core Inside are trademarks of Intel Corporation in the U.S. and other countries.

## Regulatory Information



This device complies with requirement of 1999/5/EC with regard to Radio and Telecommunications terminal equipment directive.

This device complies with requirement of EMC directive 2004/108/EC with regard to Electromagnetic Compatibility, and 2006/95/EC with regard to Low Voltage directive.



## Trademark Notice



Hannsree products incorporate High-Definition Multimedia Interface (HDMI™) technology.

HDMI, the HDMI logo and High-Definition Multimedia Interface are trademarks or registered trademarks of HDMI Licensing LLC in the United States and other countries.

## Free Manuals Download Website

<http://myh66.com>

<http://usermanuals.us>

<http://www.somanuals.com>

<http://www.4manuals.cc>

<http://www.manual-lib.com>

<http://www.404manual.com>

<http://www.luxmanual.com>

<http://aubethermostatmanual.com>

Golf course search by state

<http://golfingnear.com>

Email search by domain

<http://emailbydomain.com>

Auto manuals search

<http://auto.somanuals.com>

TV manuals search

<http://tv.somanuals.com>