

This guide is designed as a reference to help you start using your LCD TV quickly. Please refer to the User's Manual for more detailed installation and safety instructions.

### Front View

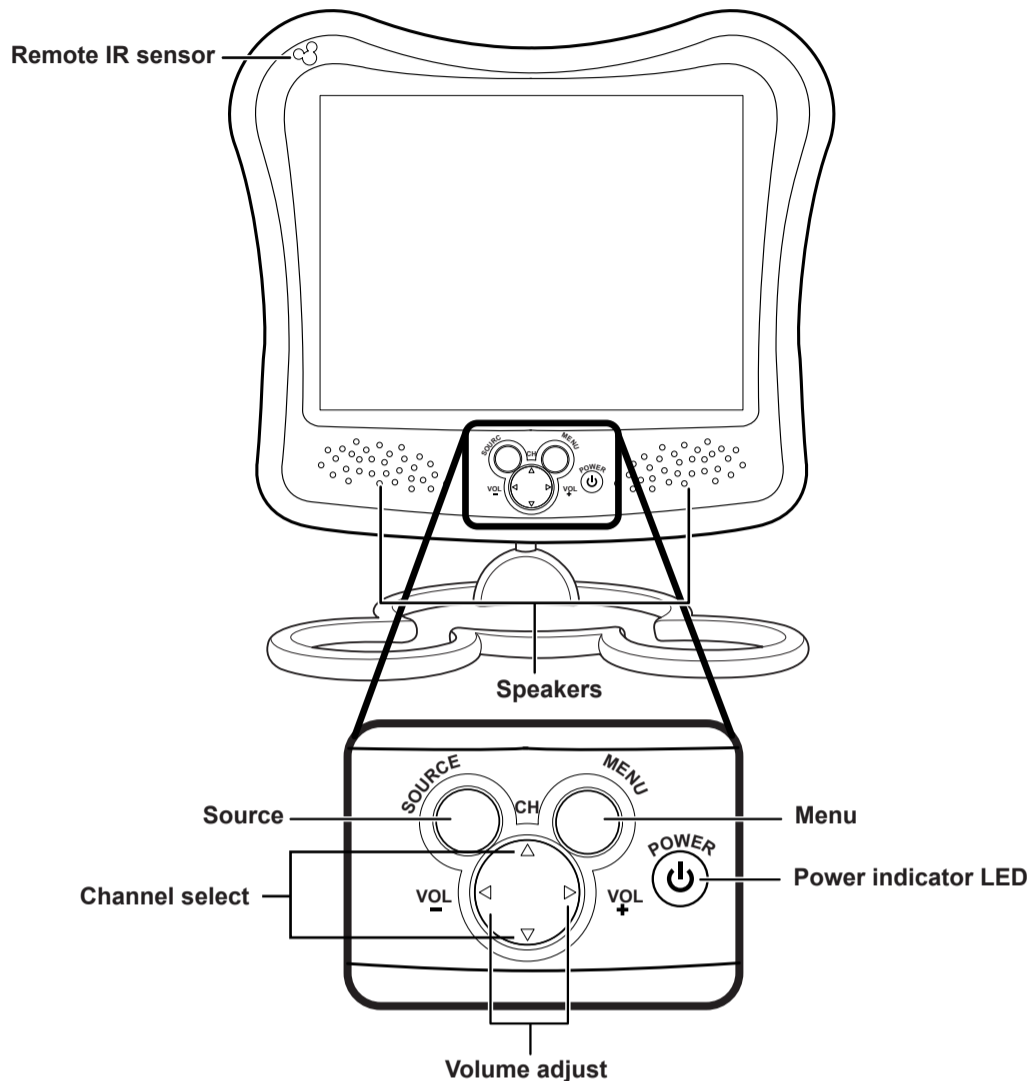

### Rear View

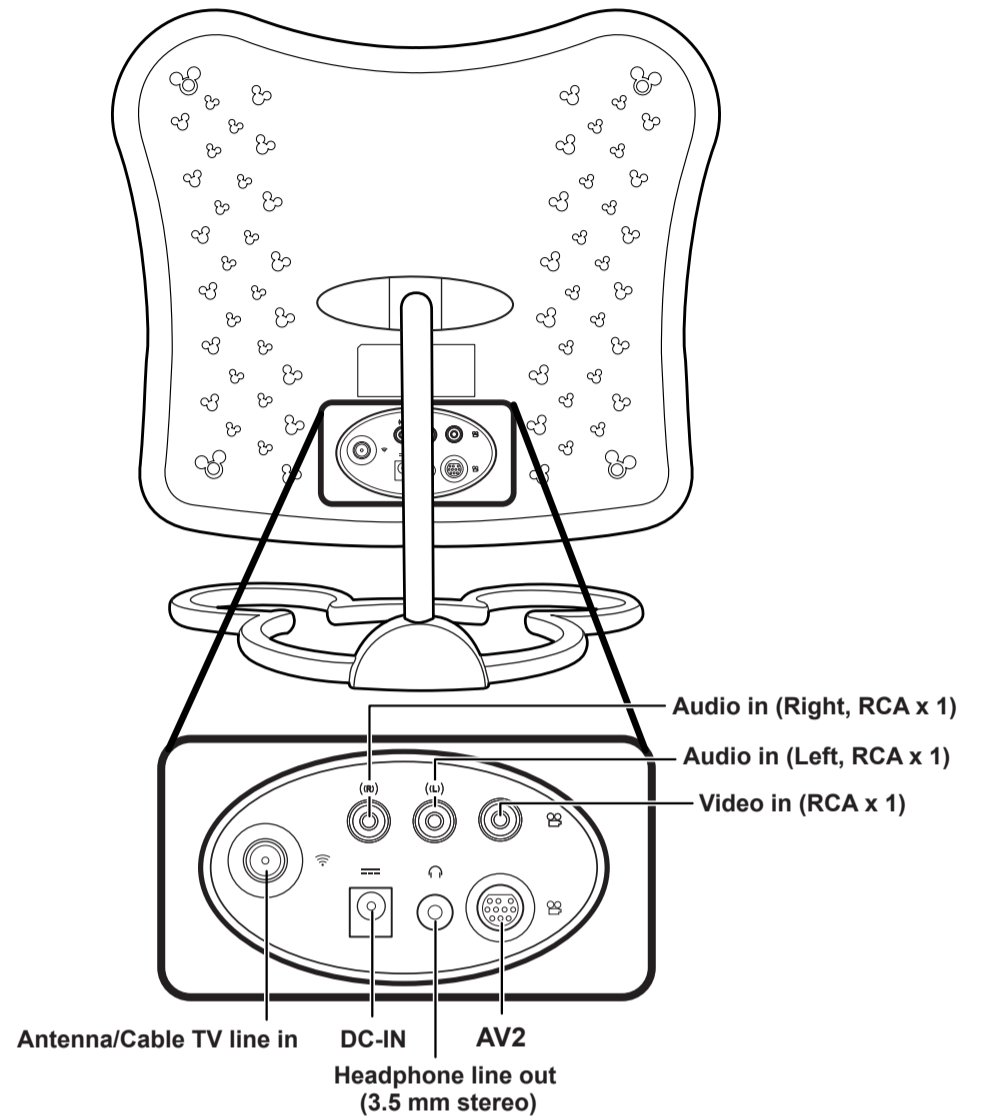

## Making Connections

### Connecting to Antenna/Cable TV

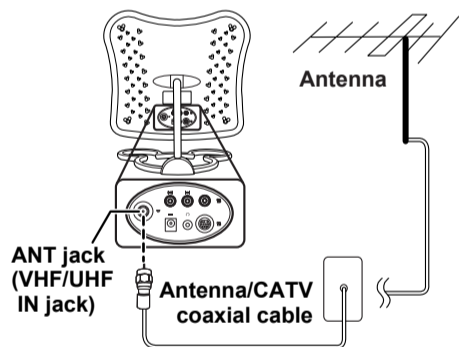

1. Connect one end of the VHF/UHF (Antenna) or CATV cable to ANT Jack (VHF/UHF IN Jack) on the back of the TV.
2. Connect the other end of the VHF/UHF (Antenna) or CATV cable to the Antenna or CATV socket.

### Connecting to a VCR, VCD, DVD Player, or Video Game Console

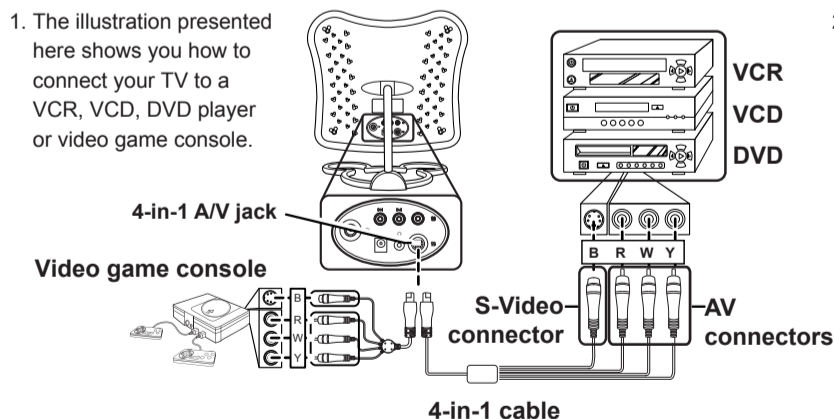

1. The illustration presented here shows you how to connect your TV to a VCR, VCD, DVD player or video game console.
2. The cables are color-coded (black, red, white, yellow). Connect each color-coded cable to the appropriate connector on your device.

### Connecting the Power Adapter

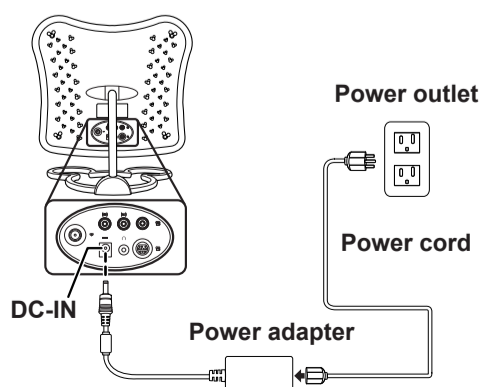

1. Connect the power cord to the power adapter as illustrated.
2. Plug the power adapter connector into the DC-IN input jack on the rear panel of the TV.
3. Insert the three-pronged plug at the other end of the power cord into a power outlet.

Note : For information on connecting your TV to a computer, refer to the user's manual.

## A/V and Channel Setup

### Watching Broadcast or Cable TV

1. After you have made the appropriate power and source connections, press the power button to turn on your television
2. Press the **SOURCE** button to select TV.
3. Press the **MENU** button on the control panel to enter the OSD menu.
4. Press the **CH**  $\Delta$  button to select the TV setting.
5. Press the **MENU** button.
6. Press the **CH**  $\Delta$  button to select TV/CATV.

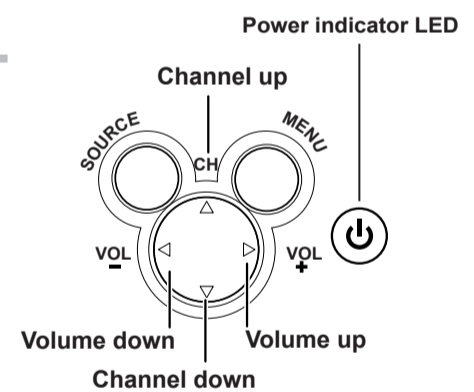

### Selecting A/V Sources

1. Make sure your TV is turned on and a device such as a DVD player is connected.
2. Press the **SOURCE** button on the control panel to select different source signals. TV/CATV channel number, AV1 or AV2 appear on the screen.

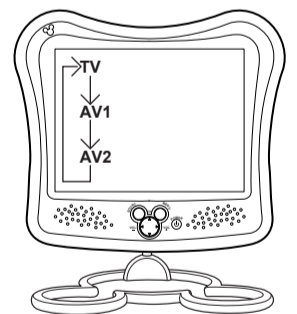

### Auto Channel Setup

1. Press the **MENU** button to enter the OSD menu.
2. Use the channel buttons on the control panel to select the "TV Setting" menu.
3. Press the **MENU** button to enter the TV Setting menu.
4. Press channel buttons to select Auto Program.
5. Press the **MENU** button to enter the Auto Program Setting submenu.
6. Press channel buttons to select ON or OFF and press the **MENU** button .
7. Your television will begin automatically memorizing the available channels.

### Auto Program

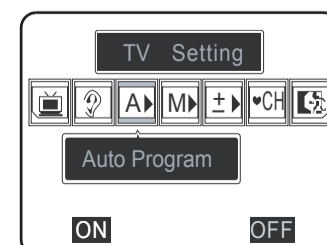

## Free Manuals Download Website

<http://myh66.com>

<http://usermanuals.us>

<http://www.somanuals.com>

<http://www.4manuals.cc>

<http://www.manual-lib.com>

<http://www.404manual.com>

<http://www.luxmanual.com>

<http://aubethermostatmanual.com>

Golf course search by state

<http://golfingnear.com>

Email search by domain

<http://emailbydomain.com>

Auto manuals search

<http://auto.somanuals.com>

TV manuals search

<http://tv.somanuals.com>