

HANNspree

HANNSPREE CALIFORNIA, INC.

843 Auburn Court,
Fremont, CA 94538, U.S.A.
TEL: 1-510-360-3000
FAX: 1-510-360-3001
www.hannspree.com

HANNspree

**9.6" Liquid Crystal Display
12.1" Television**

User's Manual

MAK-00001

Table of Contents

1. Regulatory Information.....	3
2. Description of Warning Symbols.....	5
3. Safety Notices.....	6
4. Preface.....	13
5. Introducing the TV.....	15
Features.....	15
6. Checking Package Contents.....	16
7. Getting Started.....	17
Control Panel.....	17
Input and Output Jacks.....	18
Remote Control.....	19
Inserting the Remote Control Battery/Batteries.....	21
8. Making Connections.....	24
Connecting to an Antenna or Cable TV.....	24
Connecting to AV Devices.....	25
Connecting to a VCR/VCD/DVD Player.....	25
Connecting to a Video Camera.....	26
Connecting External Speakers or Headphones.....	27
Connecting the Power Adapter.....	28
9. Using the TV.....	29
Using the Remote Control.....	29
Turning the TV On and Off.....	29
Selecting Channels.....	29
Switching Source Signals.....	29
Adjusting the Volume.....	29
10. Adjusting On-Screen Display (OSD) Settings.....	30
OSD Setting Menu.....	30
Brightness.....	31
Contrast.....	32
Video Setting.....	33
Hue.....	34
Saturation.....	35
Sharpness.....	36
Color Temperature.....	37

Table of Contents

Audio Setting	38
Treble	39
Bass	40
Balance	41
Mute	42
TV Setting	43
TV/CATV	44
MTS	45
Auto Program.....	46
Manual Program.....	47
Channel Add/Erase	48
Favorite Channel.....	49
Miscellaneous Setting	50
Language	51
Sleeper.....	52
OSD Display	53
Time Setting	54
Reset	55
Exit	55
11.Taking Care of Your TV & Remote Control.....	56
12.Troubleshooting.....	57
13.Warranty and Service	59
14.Specifications	60
15.Glossary	61

FCC Compliance Statement¹

This device complies with part 15 of the FCC Rules. Operation is subject to the following two conditions: (1) This device may not cause harmful interference, and (2) this device must accept any interference received, including interference that may cause undesired operation.

Additional Information

This equipment has been tested and found to comply with the limits for a Class B digital device, pursuant to part 15 of the FCC Rules. These limits are designed to provide reasonable protection against harmful interference in a residential installation. This equipment generates, uses and can radiate radio frequency energy and, if not installed and used in accordance with the instructions, may cause harmful interference to radio communications. However, there is no guarantee that interference will not occur in a particular installation. If this equipment does cause harmful interference to radio or television reception, which can be determined by turning the equipment off and on, the user is encouraged to try to correct the interference by one or more of the following measures:

- Reorient or relocate the receiving antenna
- Increase the separation between the equipment and receiver
- Connect the equipment into an outlet on a circuit different from that to which the receiver is connected
- Consult the dealer or an experienced radio/TV technician for help

Warning: You are cautioned that changes or modifications not expressly approved by the party responsible for compliance could void your authority to operate the equipment.

1. applies only to products purchased in the United States of America

DOC Compliance Notice¹

This digital apparatus does not exceed the Class B limits for radio noise emissions from digital apparatus as set out in the Radio Interference Regulations of the Canadian Department of Communications. This device complies with Canada ICES-003 Class B.

CE Conformity Statement²

This device complies with the requirements set out in the Council Directive on the approximation of the Laws of the Member States relating to Electromagnetic Compatibility (89/336/EEC) and the Amendment Directive (92/31/EEC), Low-Voltage Directive (73/23/EEC) and the Amendment Directive (93/68/EEC).

-
1. applies only to products purchased in Canada
 2. applies only to products purchased in the European Union

Description of Warning Symbols



Before You Proceed

1. Read all Safety Notices in Section 2 of this manual and instructions in the User's Manual carefully before either plugging in or turning the TV on.
2. Keep this User's Manual in a safe place for future reference. Keep the box and packaging in case the TV needs to be shipped in the future.
3. Follow the TV and warning label instructions.
4. Any uses, operations, changes, alterations or modifications of the TV that do not follow the instructions in this manual will void this TV's warranty.



CAUTION

RISK OF ELECTRIC SHOCK
DO NOT OPEN



WARNING



This symbol is used to alert users to pay attention to important descriptions regarding usage, maintenance (repair), and additional important information related to this TV.

CAUTION



This symbol is used to alert users to the risk of electric shocks due to dangerous and uninsulated components.

Electric Power Notice

Electric power may cause personal injury and mechanical damage if misused. Although safety has been taken into consideration during the design and production of this TV, electric shock or fire can result if the TV is misused. To prevent potential danger, read and follow the instructions and warnings contained in this manual when setting up, operating or cleaning the TV. In addition, please read all “Safety Notices” contained in this manual carefully before using the TV.

**Power Supply Safety Notes**

1. To avoid electric shocks, do not use an extended power cord or an outlet that does not match this TV's plug or leaves the plug exposed.
2. This TV has a 3-pin grounded plug. The third pin connects to ground; do not remove it or alter it in anyway.
3. If the power cord or plug is damaged or worn, unplug it immediately and contact an authorized service technician for maintenance.
4. To avoid fire or electric shocks, do not overload electric power outlets.



Installation Safety Notes

Antenna

We suggest that you use an outdoor antenna to get the best signal possible unless you have cable TV or a centralized indoor antenna system. You may, however, use an antenna indoors if it is placed in a location free from interference.

Location

Avoid prolonged exposure to sunlight or other strong sources of heat. Leave sufficient distance between the TV and the wall to provide enough space for the emission of heat.



WARNING

To reduce the risk of fire or electric shock, do not expose this apparatus to rain or moisture.

Apparatus shall not be exposed to dripping or splashing and no objects filled with liquids, such as vases, shall be placed on the apparatus.



Power

To avoid danger of fires or electric shock, only use those adapters listed below, which are compatible with this TV.

- EDAC POWER ELECTRONICS CO., LTD.: EA1050E-120
- LI SHIN INTERNATIONAL ENTERPRISE CORP.: 0217B1240

IMPORTANT SAFETY INSTRUCTIONS



- 1 Read these instructions.
 - 2 Keep these instructions.
 - 3 Heed all warnings.
 - 4 Follow all instructions.
-



- 5 Do not use this apparatus near water.
-



- 6 Clean only with dry cloth.
-



- 7 Do not block any ventilation openings. Install in accordance with manufacturer's instructions.
-



- 8 Do not install near any heat sources such as radiators, heat registers, stoves, or other apparatus (including amplifiers) that produce heat.
-

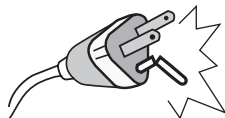

- 9 Do not defeat the safety purpose of the polarized or grounding-type plug. A polarized plug has two blades with one wider than the other. A grounding-type plug has two blades and a third grounding prong. The wide blade or the third prong are provided for your safety. If the provided plug does not fit into your outlet, consult an electrician for replacement of the obsolete outlet.
-

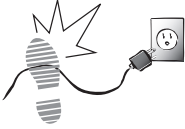

- 10 Protect the power cord from being walked on or pinched, particularly at plugs, convenience receptacles, and the point where they exit from the apparatus.



- 11 Only use attachments/accessories specified by the manufacturer.



- 12 Use only with the cart, stand, tripod, bracket, or table specified by the manufacturer, or sold with the apparatus. When a cart is used, use caution when moving the cart/apparatus combination to avoid injury from tip-over.



- 13 Unplug this apparatus during lightning storms or when unused for long periods of time.



- 14 Refer all servicing to qualified service personnel. Servicing is required when the apparatus has been damaged in any way, such as power-supply cord or plug is damaged, liquid has been spilled or objects have fallen into the apparatus, the apparatus has been exposed to rain or moisture, does not operate normally, or has been dropped.

CAUTION



These servicing instructions are for use by qualified service personnel only. To reduce the risk of electric shock, do not perform any servicing other than that contained in the operating instructions unless you are qualified to do so.

Personal Safety

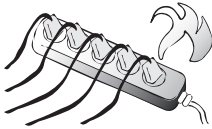

To avoid overloading the power supply, never plug too many electrical devices into an outlet, power strip, or extension cable.

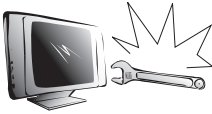

Dangerous high-voltage electric power components are located inside the TV. To avoid electric shock, do not disassemble the TV in any way.



Do not place or drop metals, small objects, or flammable materials into the vent of the TV.



If the TV is dropped, falls down, or is otherwise damaged, unplug the power cord immediately and contact an authorized service technician.



If any fluid is sprayed or dropped into the TV, contact an authorized service technician.



The screen of the TV is made of glass. Avoid hitting or scraping it. If the screen is broken, do not touch the broken glass.



Do not allow children to use the TV unattended.

Installation

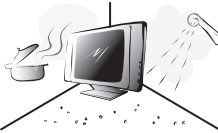

Do not place the TV in locations where there is excessive steam or dust.



Avoid blocking the TV's vents, do not place the TV on a bed, sofa, carpet, or in a sealed cabinet.

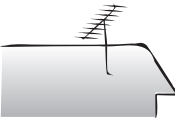

Install the outdoor antenna (not included) away from power transmission lines to avoid possible danger.



Unplug the power cord and antenna connector when there is a storm or when the TV is not in use for long periods to avoid electric shock from lightning.

Operation



This TV is designed for home power sources as labeled on the casing. Avoid using any other power accessories to avoid electric shock or other damage.



The plug can be inserted into an outlet in only one direction as shown to the left. Do not alter the plug. Contact an authorized service technician if you cannot plug it in correctly.



If there is any problem that cannot be resolved according to the instructions given in this manual, contact an authorized service technician immediately. Do not attempt any methods not covered in this manual.

Maintenance



Do not attempt to repair the TV by yourself. Contact an authorized service technician. Ask the service technician to complete a safety inspection before switching the power on after completing any maintenance.

Thank you for purchasing a Hannspree Liquid Crystal Display Television (LCD TV). Your new TV will allow you to enjoy superior audio and video while enriching your lifestyle with advanced technology.

Please carefully read this manual in its entirety before setting up, using or operating your TV. To ensure the safe and correct installation and operations of the TV, it is important that the safety and operation instructions in this manual are followed.

This instruction manual is designed to assist you in setting up and using the TV. The information in this manual has been carefully checked for accuracy; however, no guarantee is given to the correctness of the contents. The information in this manual is subject to change without notice.

To the extent allowed by applicable law, Hannspree California Inc. ("Hannspree") shall not be liable for direct, indirect, special, exemplary, incidental or consequential damages arising from any defect or omission in this manual, even if advised of the possibility of such damages in advance.

Copyright

© Copyright 2004 Hannspree California Inc.

All rights reserved. This manual is protected by copyright and distributed under licenses restricting its use, copying and distribution. No part of this manual may be reproduced in any form by any means without the prior written authorization of Hannspree. The TV described in this manual may include copyrighted software of Hannspree (or other third parties). Hannspree (or other third parties) preserves the exclusive rights for copyrighted software, such as the right to distribute or reproduce the copyrighted software. Accordingly, and to the extent allowed by applicable law, any copyrighted software contained in the product described herein shall not be distributed, modified, reverse engineered, or reproduced in any manner without the prior written authorization of Hannspree (or of other third parties).

The Hannspree logos presented herein are trademarks of Hannspree. All other product names, trademarks or logos mentioned herein are used for identification purpose only, and may be the trademarks or registered trademarks of their respective owners.

The purchase of the product described herein shall not be deemed to grant, either directly or by implication, estoppel or otherwise, any license under the copyrights, patents, patent applications or trademarks of Hannspree, except for the normal, non-exclusive use that arises by operation of law in the sale of a product.

Thank you for purchasing this LCD TV. Your LCD TV is designed to be safe, versatile, and easy to use. The design makes it a fun addition to any room.

You can watch broadcast or cable television channels, and easily connect a VCR, VCD or DVD player to the standard RCA and S-Video input ports that are included in the 4-IN-1 A/V cable.

Convenient control buttons located on the TV and a handy remote control let you change channels, adjust the volume, and change display settings through an easy-to-use on-screen display menu system. The built-in stereo speakers provide full rich sound and a convenient audio output port lets you connect to an external audio system or headphones.

Features

- Built-in TV tuner
- 4-IN-1 A/V cable
- On-Screen Display (OSD) menu system
- Built-in stereo speakers
- Audio/Video support

Checking Package Contents

Make sure the following components are included in the box. Please contact Hannspree Customer Service immediately if anything is missing or damaged.





- TV
- User's manual
- Quick start guide
- Warranty and service manual
- Power cord
- Power adapter
- 4-IN-1 A/V cable
- Remote control and battery/batteries
- RCA jack x 3
- S jack x 1
- Stop Card

Getting Started

Control Panel

Description	Icon	Function
Power	 Power	Turns the TV on and off.
Power LED		Indicates power status.
Source	SOURCE / TV/AV / TV	Selects the input source to be displayed (TV/CATV, AV1, or AV2).
Menu	MENU/M/●	Turns the On-Screen Display (OSD) menu on and off.
Select channel	channel up (▲ / ▲ / ► / +) channel down (▼ / ▼ / ◀ / -)	Changes channels. Press channel up to increase the channel number. Press channel down to decrease the channel number. In PC or AV mode, press either button to return to TV mode.
Adjust volume	volume up (* / + / ▲ / ►) volume down (* / - / ▼ / ◀)	Press volume up to increase the audio volume. Press volume down to decrease the audio volume.

Input and Output Jacks

Description	Connector	Function
AV1 (R-AUDIO/ L-AUDIO/VIDEO)		Connects to a right audio (red) or left audio (white) cable, or video (yellow) cable.
AV2		Use the included 4-IN-1 A/V cable to connect external devices, such as a VCR, VCD, DVD player, CVBS RCA cables or a game device. Audio Input: AV connector audio (white and red) cables. Video Input: AV connector video (yellow) or S-Video cable.
ANT		Connects to an antenna or CATV cable television line.
DC-IN		Connects to the included power adapter.
Headphone line out jack		Connects to headphones or external speakers

Remote Control

Description	Icon	Function
Menu	MENU/ENTER/MENU/M	Press this button to activate the OSD menu system and to adjust various settings and personal preferences.
Arrow	◀ / ▶ / < / >	Press ◀ and ▶ to scroll through the on-screen display menus. Favorite channels can be selected using the ◀ and ▶ buttons on the remote control.
Number	1 2 3 4 5 6 7 8 9 0	Use to select a channel directly. Press 0-9 to enter the channel number (press 1 and 0 for channel 10).
Recall	RECALL	Press this button to return to the last channel selected.
MTS	MTS	Press this button to enable the bilingual function when the program has stereo/SAP/MONO capabilities.
Power		Turns the TV power on or off.
Adjust volume	-VOL VOL+ ◀VOL VOL▶ ▼VOL VOL▲ ▶VOL VOL▼	Press volume up to increase the audio volume. Press volume down to decrease the audio volume.
Mute	MUTE	Press this button to eliminate sound. Press mute again or press the volume adjust buttons to restore sound.

Description	Icon	Function
Select channel	▼CH CH▲ ▲CH CH▼ -CH CH+	Changes channels. Press channel up to increase the channel number. Press channel down to decrease the channel number. In PC or AV mode, press either button to return to TV mode.
Source	SOURCE	Press this button to cycle the video input sources. The source is displayed on the screen.
Reset (selected models only)	RESET	Press this button to reset the TV.
Display (selected models only)	DISPLAY	Press this button to show messages on the screen, such as the channel number and other. Press this button again to show the real-time clock. Press this button again to close the displayed message.
Caption (selected models only)	CAPTION / CAPT.	Press this button to enable the closed captions/subtitles (Only available with 15-inch TVs). This option may not be available in your local area.
Auto (selected models only)	AUTO	Press this button to automatically adjust the screen parameters in PC mode (only available with 15-inch TVs).

Inserting the Remote Control Battery/Batteries

Lithium battery/batteries

- 1 Open the battery compartment cover at the back of the remote control (A).

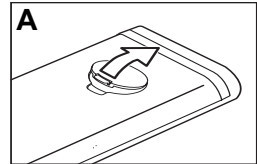

- 2 Slide the battery/batteries, with the positive (+) side facing up, underneath the shorter set of metal contacts (B).

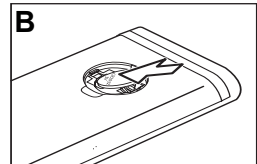

- 3 Press the battery/batteries firmly into place in the battery compartment (C)

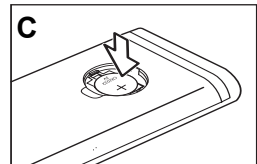

- 4 Replace the battery compartment cover (D).

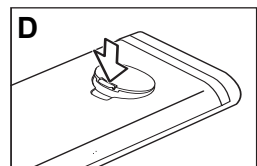

Note

Your remote control may have either AAA type batteries or CR2032 lithium battery/batteries.

AAA battery/batteries

- 1 Open the battery compartment cover at the back of the remote control (A).

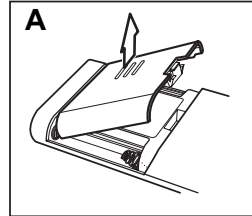

- 2 Insert the battery/ batteries paying attention to the polarity markings inside the battery compartment (B).

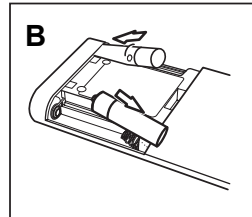

- 3 Replace the battery compartment cover (C).

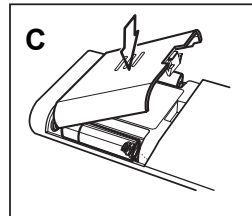

Note

Your remote control may have either AAA type batteries or CR2032 lithium battery/batteries.

CAUTION



- If the remote control is not used for a long period, remove the batteries and store them separately.
- Handle damaged or leaking batteries carefully, and wash hands after such handling.
- If your remote control has two batteries, do not mix new and old batteries because the life of the new batteries will be shortened. Chemical fluids may leak from the old batteries.
- Danger of explosion if battery is incorrectly replaced. Replace only with the same or equivalent type recommended by the equipment manufacturer. Discard used batteries according to manufacturer's instructions.
- Refer to your local recycling or waste disposal rules and contact a local waste disposal vendor to dispose of used batteries.
- The remote control may have a magnet in it, so do not place magnetic sensitive items such as watches, credit cards, or flash media close to the cover.
- Do not use force when pulling the remote control cover open; you may damage the hinge.

Making Connections

Connecting to an Antenna or Cable TV

- 1 Connect one end of the VHF/UHF (Antenna) or CATV cable to ANT Jack (VHF/UHF IN Jack) on the back of the TV.
- 2 Connect the other end of the VHF/UHF (Antenna) or CATV cable to the antenna socket or CATV cable.

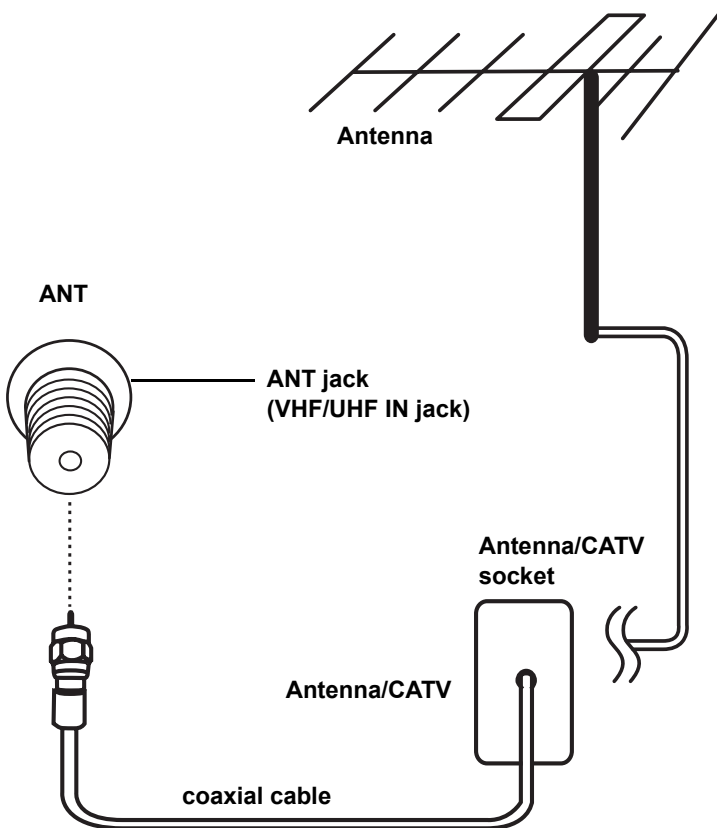

Note

If you cannot receive channels after connecting to an antenna or cable TV line, try scanning for channels. See "Auto Program" on page 46.

Connecting to AV Devices

Connect external devices such as a VCR, VCD or DVD player, or video game console to the TV using the supplied 4-IN-1 A/V cable.

Connecting to a VCR/VCD/DVD Player

The illustration presented here shows how to connect the TV to a VCR, VCD or DVD player. Actual connections may vary according to the make and model of the device. Refer to the user's manual included with the device for more detailed instructions.

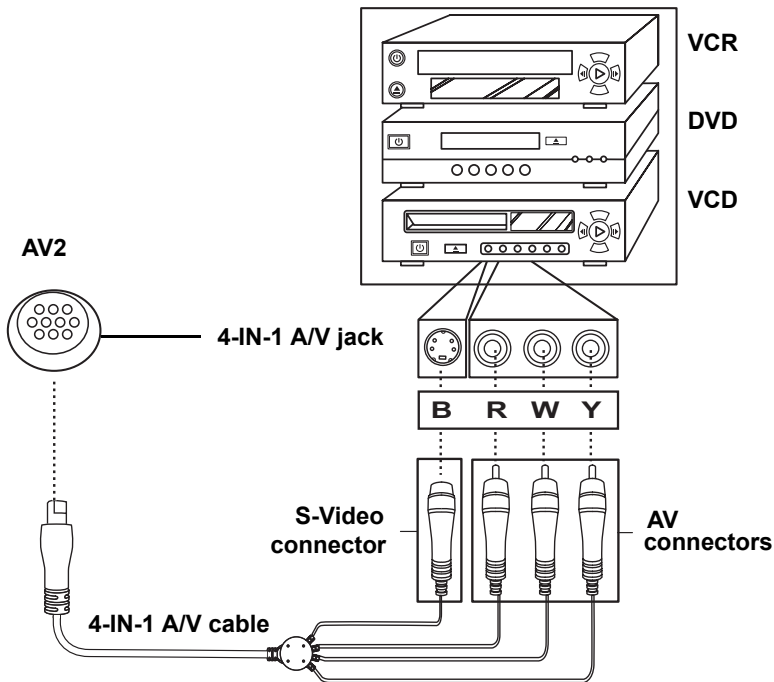

Note

- The cables are color-coded (black, red, white, yellow). Connect each color-coded cable to the appropriate connector on your device.
- When connecting the S-Video connector and AV connector at the same time, the priority is given to the S-Video connector.

Connecting to a Video Camera

The instructions presented here are a general guide to connecting the TV to a camcorder or other type of digital camera. Actual connections may vary according to the make and model of the device. Refer to the user's manual included with the camcorder or camera for more detailed instructions.

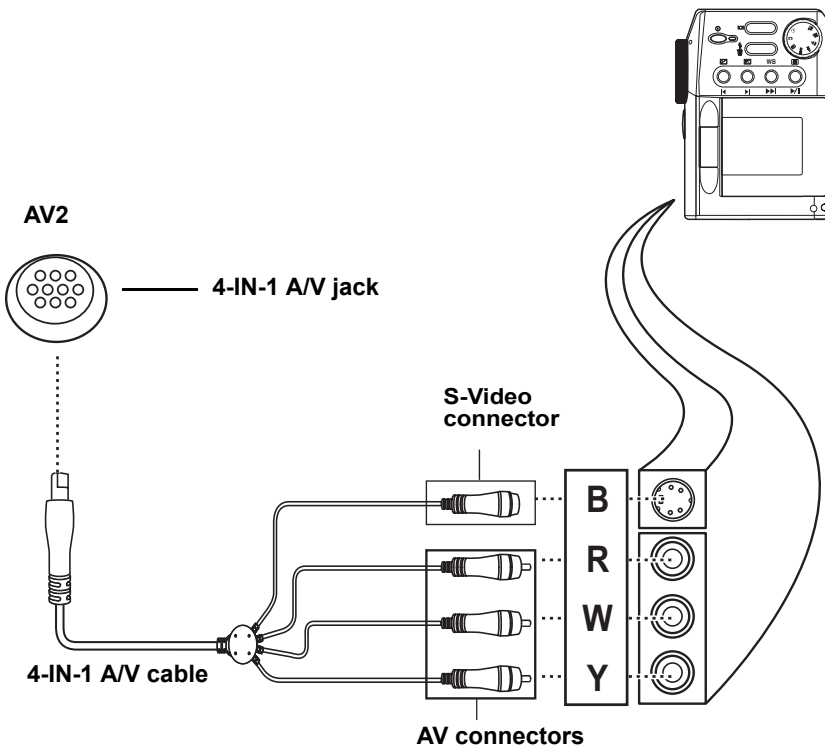

Note

The cables are color-coded (black, red, white, yellow). Connect each color-coded cable to the appropriate connector on your device.

Connecting External Speakers or Headphones

External speakers or headphones may be used to listen to the TV rather than using the built-in speakers. Connect external speakers to the speaker line out port or headphones to the headphone port as illustrated.

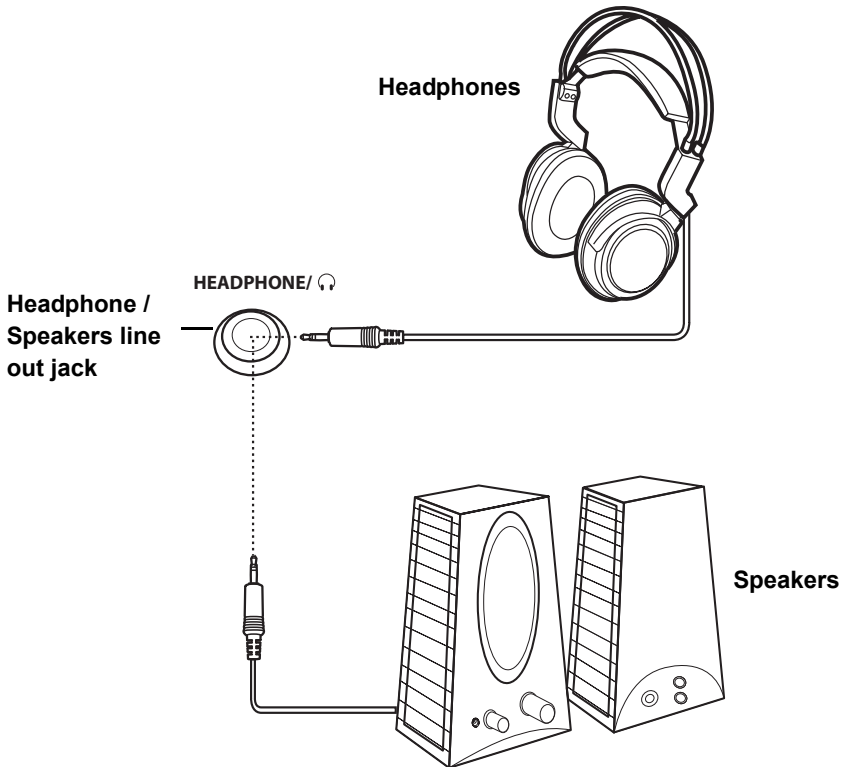

Notes

- External speakers or headphones are not included with the TV.
- The internal TV speakers will not output sound when headphones are plugged in.
- Use external speakers with built-in amplifiers only.

Connecting the Power Adapter

- 1 Connect the power cord to the power adapter as illustrated.
- 2 Plug the power adapter connector into the DC-IN input jack on the rear panel of the TV.
- 3 Insert the three-pronged plug at the other end of the power cord into a power outlet.

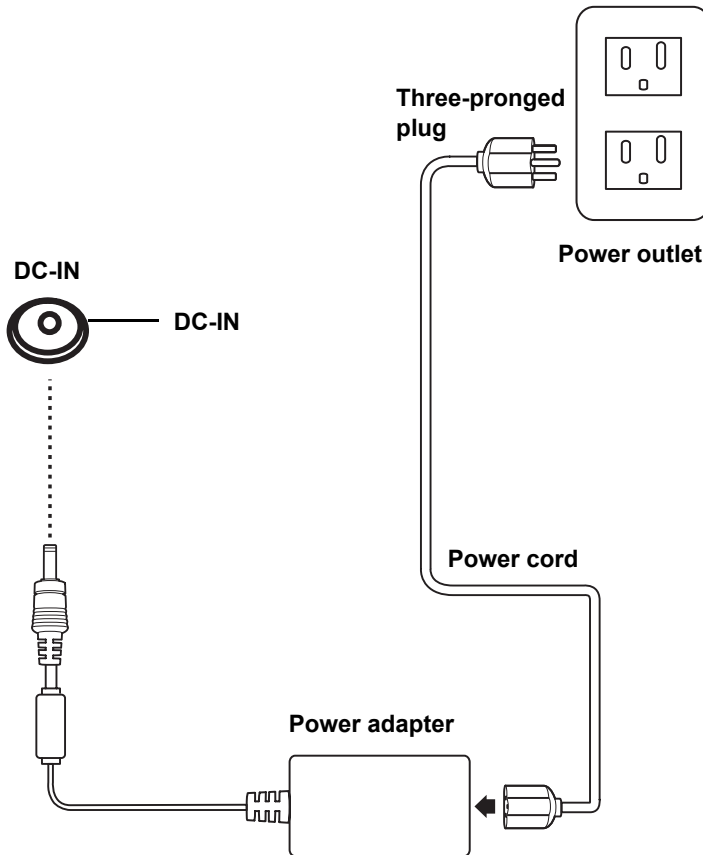



Using the Remote Control

For best results, use the remote control within a distance of 16 feet (5 meters) from the front of the TV. Do not exceed an angle of 30 degrees when pointing at the TV.

Notes

- The operational distance may be shortened when the signal sensor is directly exposed to strong light.
- Aim the transmitter on the remote control at the signal sensor and ensure that there are no obstacles between them.

Turning the TV On and Off

- 1 Press power  on the remote control or control panel to turn on the TV.
- 2 Press power  again; the TV is in off mode.

Selecting Channels

Press channel up or channel down on the control panel to select the channel or enter the specific channel number by pressing the number buttons on the remote control.

Switching Source Signals

Press source to select the incoming source signal.

The current source setting (TV/CATV, AV1, or AV2) appears on the upper left corner of the screen.

Adjusting the Volume

Press volume up to increase the volume. Press volume down to decrease the volume. The volume level is displayed on the screen.

10

Adjusting On-Screen Display (OSD) Settings

The On-Screen Display (OSD) menu system provides a quick and simple method to adjust your TV's settings. This chapter describes how to change each of the available settings.

The OSD can be used with either the remote control or the control panel.

Function	Control Panel Icon	Button	Remote Control Icon
Menu	Menu	Menu	menu/ENTER, M
Channel up	CH (▶ / ^ / + / ▲)	Right arrow	> / ▶
Channel down	CH (◀ / v / - / ▼)	Left arrow	< / ◀
Enter	Menu	Enter	menu/ENTER, M

Note

The following sections explain how to adjust settings in the OSD menus using the control panel.

OSD Setting Menu

Press menu to enter the OSD Main Menu screen.
The Main Menu appears

Note

To exit the OSD menu, press channel up or channel down to select Exit . Then press menu to exit the OSD menu. Also, after you finish setting OSD parameters, follow these instructions to exit the OSD menus.

Brightness

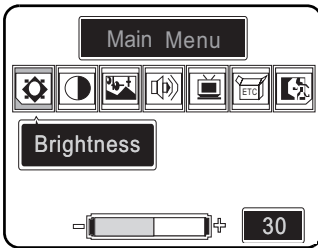

- 1 Press menu. The brightness slide bar is highlighted.
- 2 Press channel up to increase the brightness.
- 3 Press channel down to decrease the brightness.
- 4 Press menu to confirm the setting and return to the Main Menu.

Note
The new setting is confirmed automatically when the OSD times out.

Contrast

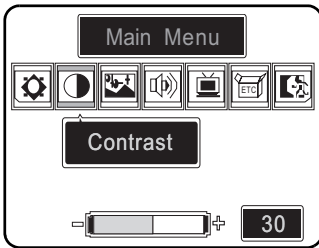

- 1 Press channel down or channel up to select Contrast.
- 2 Press menu. The contrast slide bar is highlighted.
- 3 Press channel up to increase the contrast.
- 4 Press channel down to decrease the contrast.
- 5 Press menu to confirm the setting and return to the Main Menu.

Note
The new setting is confirmed automatically when the OSD times out.

Video Setting

Press menu to enter the OSD Main Menu screen.

- 1** Press channel down or channel up to select Video Setting.
- 2** Press menu to enter the Video Setting menu.

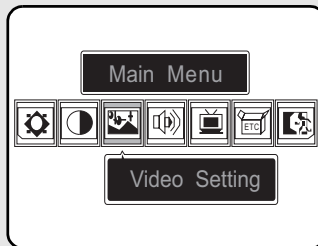

Hue

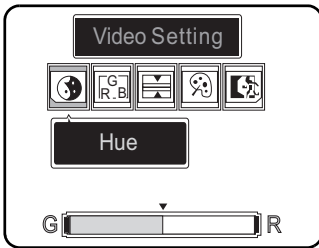

- 1 Press menu to enter the Hue submenu.
- 2 Press channel up to increase green and decrease red.
- 3 Press channel down to decrease green and increase red.
- 4 Press menu to confirm the setting and return to the Video Setting menu.

Note
The new setting is confirmed automatically when the OSD times out.

Saturation

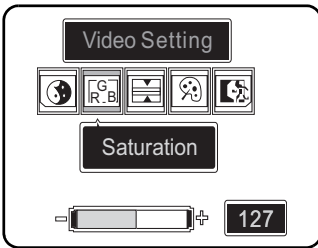

- 1** Press channel down or channel up to select Saturation.
- 2** Press menu to enter the Saturation submenu.
- 3** Press channel up to increase the saturation.
- 4** Press channel down to decrease the saturation.
- 5** Press menu to confirm the setting and return to the Video Setting menu.

Note
The new setting is confirmed automatically when the OSD times out.

Sharpness

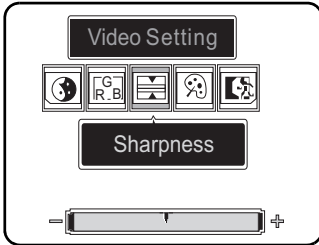

- 1** Press channel down or channel up to select Sharpness.
- 2** Press menu to enter the Sharpness submenu.
- 3** Press channel up to increase the sharpness.
- 4** Press channel down to decrease the sharpness.
- 5** Press menu to confirm the setting and return to the Video Setting menu.

Note
The new setting is confirmed automatically when the OSD times out.

Color Temperature

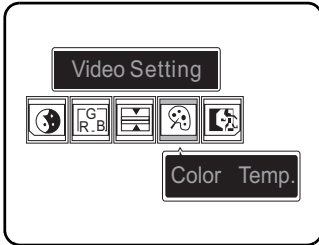

- 1 Press channel down or channel up to select Color Temp.
- 2 Press menu to enter the Color Temperature submenu. There are three default color temperatures to Choose from.

Standard Color

Press channel down or channel up to select Standard, then press menu.

Warm Color

Press channel down or channel up to select Warm, then press menu.

Cold Color

Press channel down or channel up to select Cold, then press menu.

Note

The new setting is confirmed automatically when the OSD times out.

Audio Setting

Press menu to enter the OSD Main Menu screen.

- 1** Press channel down or channel up to select Audio Setting.
- 2** Press menu to enter the Audio Setting menu.

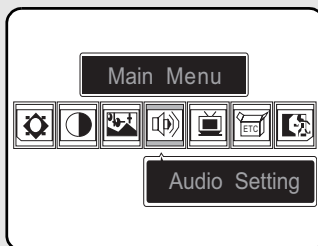

Treble

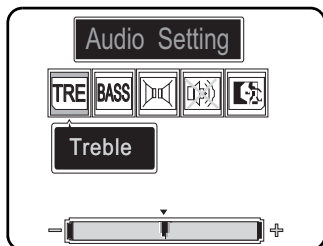

- 1** Press menu to enter the Treble sub-menu.
- 2** Press channel up to increase the treble.
- 3** Press channel down to decrease the treble.
- 4** Press menu to confirm the setting and return to the Audio Setting menu.

Note
The new setting is confirmed automatically when the OSD times out.

Bass

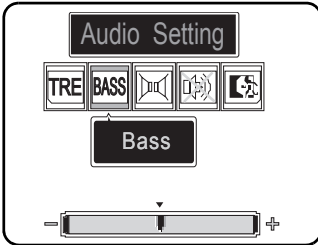

- 1** Press channel down or channel up to select Bass.
- 2** Press menu to enter the Bass submenu.
- 3** Press channel up to increase the bass.
- 4** Press channel down to decrease the bass.
- 5** Press menu to confirm the setting and return to the Audio Setting menu.

Note
The new setting is confirmed automatically when the OSD times out.

Balance

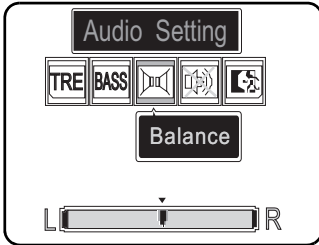

- 1** Press channel down or channel up to select Balance.
- 2** Press menu to enter the Balance submenu.
- 3** Press channel down to shift the balance to the left speaker.
- 4** Press channel up to shift the balance to the right speaker.
- 5** Press menu to confirm the setting and return to the Audio Setting menu.

Note
The new setting is confirmed automatically when the OSD times out.

Mute

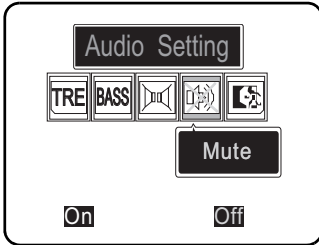

- 1** Press channel down or channel up to select Mute.
- 2** Press menu to enter the Mute submenu.
- 3** Press channel up to turn the mute off.
- 4** Press channel down to turn the mute on.
- 5** Press menu to confirm the setting and return to the Audio Setting menu.

Note
The new setting is confirmed automatically when the OSD times out.

TV Setting

Press menu to enter the OSD Main Menu screen.

- 1** Press channel down or channel up to select TV Setting.
- 2** Press menu to enter the TV Setting menu.

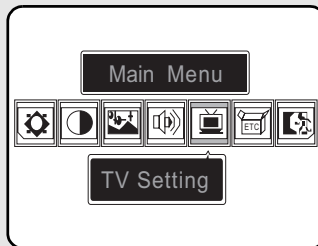

TV/CATV

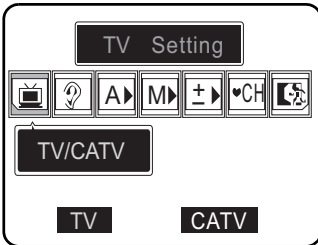

- 1 Press menu to enter the TV/CATV submenu.

Receiving Cable TV

Press channel up to select CATV, then press menu.

Receiving Broadcast TV

Press channel down to select TV, then press menu.

Note
The new setting is confirmed automatically when the OSD times out.

MTS

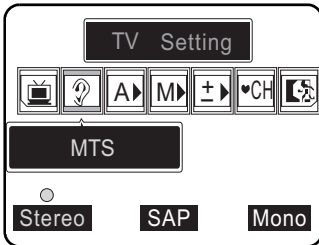

- 1 Press channel down or channel up to select MTS.
- 2 Press menu to enter the MTS submenu. Select from the following options.

Stereo

Press channel down to select Stereo. A green dot appears and Stereo is highlighted in yellow. Press menu again to confirm the selection.

SAP

Press channel up to select SAP. Press menu again to confirm the selection. If a green dot does not appear, then your service provider doesn't support SAP. This option may not be available in your local area.

Mono

Press channel up to select Mono. Press menu again to confirm Mono, which outputs sound through a signal channel.

Note
The new setting is confirmed automatically when the OSD times out.

Auto Program

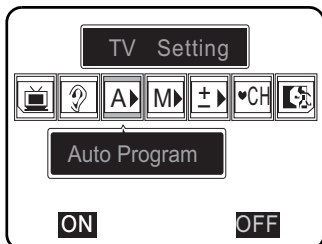

- 1** Press channel down or channel up to select Auto Program.
- 2** Press menu to enter the Auto Program Setting submenu.
- 3** Press channel down or channel up to select ON or OFF and press menu.

The screen shows “Auto Program...” and the channel indicator increments from 2 to 69 (ANT connection) or from 1 to 125 (CATV cable connection).

The screen displays the first channel that is successfully found after scanning is complete.

Manual Program

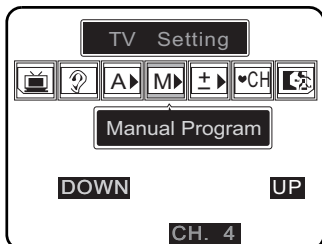

- 1** Press channel down or channel up to select “Manual Program”.
- 2** Press menu to enter the Manual Program submenu.
- 3** Press channel down or channel up to find the channel you want to add. Press menu to select the channel.
- 4** Press menu to exit, and then access Channel Add/Erase function to add a desired channel.

Channel Add/Erase

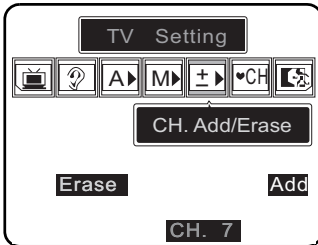

- 1 Select the channel you want to add or delete, for example, Channel 28.
- 2 Press channel down or channel up to select CH. Add/Erase.
- 3 Press menu to enter the Channel Add/Erase submenu. Select from the following options.

Add Channel

- 1 Press channel down or channel up to select Add.
- 2 Press menu to select channel.

Erase Channel

- 1 Press channel down or channel up to select Erase.
- 2 Press menu to select channel.
When you return to the normal TV screen and use channel up and channel down to browse channels, an erased channel (for example, Channel 28) will be skipped automatically.

Note

You can still access the erased channel by entering the channel number using the number keys on the remote control.

Favorite Channel

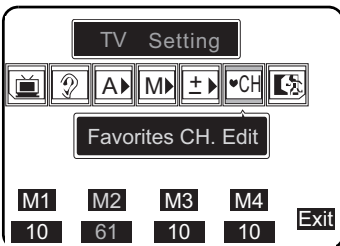
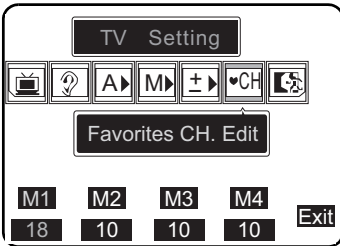
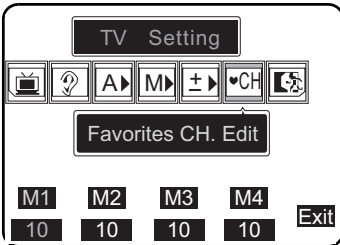

- 1 Press channel down or channel up to select Favorites CH. Edit.
- 2 Press menu to enter the Favorites CH. Edit submenu.
- 3 The screen displays the four favorite channels: M1, M2, M3, and M4.
- 4 Press channel down or channel up to select the channel number you want to set for M1. Press menu to confirm the setting and move to the next favorite channel, M2.
- 5 Repeat step 4 for M2, M3 and M4.

Note
Favorite channels can be selected using the ◀ and ▶ buttons on the remote control.

Miscellaneous Setting

Press menu to enter the OSD Main Menu screen.

- 1** Press channel down or channel up to select Miscellaneous Setting.
- 2** Press menu to enter the Miscellaneous Setting menu.

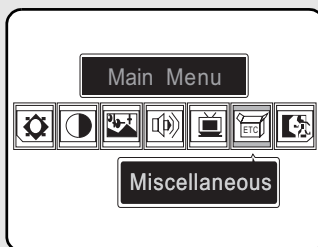

Language

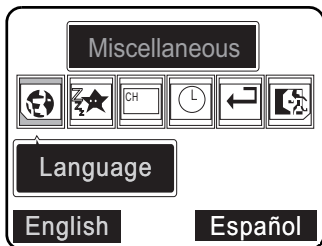

- 1** Press menu to enter the Language submenu.
- 2** The screen displays the available OSD languages: English and Español.
- 3** Press channel down or channel up to select a language. The OSD language changes as soon as you select a language.
- 4** Press menu to confirm your choice.

Sleeper

The sleeper turns the LCD TV off automatically after a set period of time.

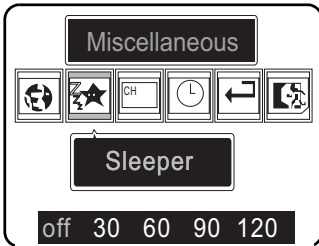

- 1** Press channel down or channel up to select Sleeper.
- 2** Press menu to enter the Sleeper submenu.
- 3** The screen displays the available sleeper setting:
 - OFF
 - 30 minutes
 - 60 minutes
 - 90 minutes
 - 120 minutes
- 4** Press channel down or channel up to select a value.
- 5** Press menu to confirm your choice.

OSD Display

This setting allows you to set the amount of information that appears on the LCD screen when display is pressed. You can choose from three settings: Off, Portion, or All.

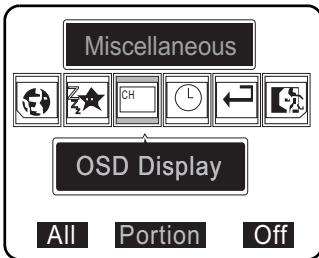

- 1** Press channel down or channel up to select OSD Display.
- 2** Press menu to enter the OSD Display submenu.
- 3** The screen displays the available settings: All, Portion, or Off.
- 4** Press channel down or channel up to select "All", "Portion", or "Off".
- 5** Press menu to confirm your choice.

Time Setting

This setting allows you to set the TV clock.

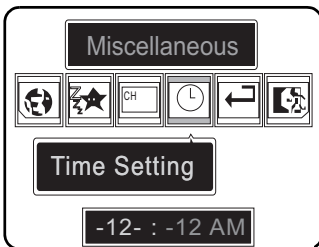
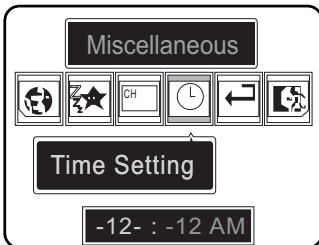
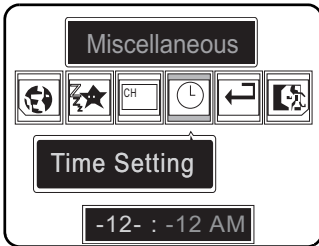

- 1 Press menu to enter the OSD menus.
- 2 Press channel up or channel down to select Miscellaneous.
- 3 Press menu to enter the Miscellaneous menu.
- 4 Press channel down or channel up to select Time Setting.
- 5 Press menu to enter the Time Setting submenu.
- 6 The screen displays the current setting. The hour is highlighted in yellow.
- 7 Press channel down or channel up to adjust the hour setting, then press menu.
- 8 The minutes are highlighted in yellow. Press channel down or channel up to adjust the minute setting.
- 9 Press menu to confirm the new time setting.

Note

The new setting is confirmed automatically when the OSD times out.

Reset

The Reset function returns all of your LCD TV's user settings to their factory defaults.

Warning:

The reset function erases all of your custom and favorite channel settings, and will reset all display settings (such as contrast, brightness, etc.) to the factory default values. The reset function cannot be reversed once it begins.

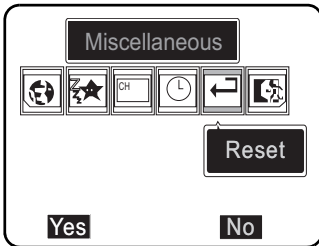

- 1 Press channel down or channel up to select Reset.
- 2 Press menu to enter the Reset submenu.
- 3 Press channel down or channel up to select "Yes" or "No". By default, "No" is already selected (highlighted in yellow).
- 4 Press menu to confirm your choice.

Exit

Exit turns off the OSD menus and returns you to TV mode.

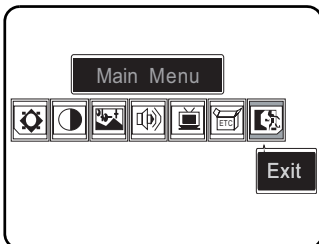

- 1 Press channel down or channel up to select Exit.
- 2 Press menu to exit the OSD menus.

Taking Care of Your TV & Remote Control



Turn the power off before you begin cleaning the TV.



For best results, use a clean lens cloth to remove dust and fingerprints from the screen.



Do not wipe the shell of the TV with alcohol, methanol, gasoline or oil products to avoid damaging the finish. Wipe the shell with a dry soft cloth and use neutral cleaning fluids.



If your model has leather components, wipe the leather parts with a dry cloth and keep the area dry. Place the TV far from sources of steam to avoid making the leather wet.



Be careful to disconnect the power plug correctly. Hold the plug. Do not attempt to disconnect the plug by pulling on the power cord.

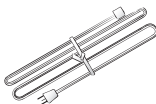

Arrange and store the power cord neatly as shown to the left to avoid knotting or bending which may cause fire due to damage or electric leakage.

Note

Protect the remote control from shock or vibration to avoid damage. Do not place the remote control in hot or humid locations.

Situation	Solution
No picture and sound.	<ul style="list-style-type: none"> • Connect the power cord properly. • Check if the power LED is on or not. • Press power on the control panel or remote control. • Press source to cycle through connected video sources. • Press channel up or channel down to switch to other TV stations. • Check the TV/CATV OSD settings. See "TV/CATV" on page 44. • Make sure all cables are connected properly.
No picture, or poor picture, sound is OK.	<ul style="list-style-type: none"> • Check the antenna and cable connections. • Adjust the brightness in the OSD menus. See "Brightness" on page 31.
Picture is not in color.	<ul style="list-style-type: none"> • Adjust the saturation in the OSD menus. See "Saturation" on page 35. • Make sure all cables are connected properly.
Picture is OK, no sound.	<ul style="list-style-type: none"> • Make sure the source device is functioning properly. • Make sure the audio cable is connected securely. • Turn the mute off. • Press volume up on the control panel or remote control. • Make sure the MTS option is set to Stereo, SAP, or Mono. See "MTS" on page 45.
One of the speakers has no sound.	<ul style="list-style-type: none"> • Adjust the balance in the OSD menus. See "Balance" on page 41. • Make sure the audio cable is connected securely.
Cannot receive some TV channels using cable TV.	<ul style="list-style-type: none"> • Try the Auto Program function in the OSD "TV Setting" menu. See "Auto Program" on page 46.
Want to reset TV settings.	<ul style="list-style-type: none"> • Use the Reset function in the OSD menu. See "Reset" on page 55.

Situation	Solution
Cannot operate menus.	<ul style="list-style-type: none"> If OSD items are colored in light blue, the system is in a state such that those settings are not available.
Screen image turns over.	<ul style="list-style-type: none"> Make sure the video signal cable is connected properly.
Snow appears on the screen.	<ul style="list-style-type: none"> Adjust the location of the antenna, placing it far from roads or sources of interference. Check the antenna and the video signal line connections.
Blurred or overlapped images.	<ul style="list-style-type: none"> Readjust the sharpness setting. Choose programs with high quality signals. Adjust the direction of the antenna or change the video signal cable.
Remote control doesn't work.	<ul style="list-style-type: none"> Make sure the battery is inserted correctly. Replace the battery with a new one. Make sure the TV power cord is plugged in. Make sure the path between the remote control and the sensor is clear. Try operating the remote control at a closer distance to the TV. Refer to "Using the Remote Control" on page 29.

For complete warranty service information, please refer to the “Warranty and Service Manual” enclosed with your TV.

9.6 / 12.1-inch LCD TV

LCD Panel Size	9.6 / 12.1-inch TFT
Aspect Ratio	4:3
Display Resolution	800 (horizontal) x 600 (vertical)
TV System	NTSC
Video System	AV1: RCA jack AV2: S-Video Input and Composite Video Input (through the 4-IN-1 A/V cable)
Audio System	AV1: RCA left & right jacks AV2: 10-pin mini-DIN (Audio Input with 4-IN-1 A/V cable) 3.5mm \varnothing headphone jack (Audio Output)
Built-in Speakers	2W + 2W / 3W + 3W
Power Supply	100-240V, 50/60 Hz, 12V DC
Power Consumption	40 W (Average)
Optional Accessories	External Speakers

Aspect Ratio: The ratio of width to height of a film, image or display screen.

Broadcast TV: Broadcasting video signals using high-frequency electromagnetic waves to distribute television channels to viewers (standard TV broadcast).

CATV: Community Antenna Television, the original name for cable TV. A television distribution system that uses coaxial cable instead of the traditional radio broadcasting (over-the-air) method to deliver television, FM radio, and other services to consumers.

Color Temperature: Adjusting the color temperature enables you to set the intensity of white light. Color temperature is measured in Kelvin (K). Higher color temperatures result in a blue tint. Lower temperatures result in a red tint.

Hue: Colors in a color system are measured by hue, saturation and luminance. Hue indicates the predominant color.

LCD (Liquid Crystal Display): A display technology that uses rod-shaped molecules (liquid crystals) that flow like liquid and bend light.

MTS: Multi-channel Television Sound. Enables reception of audio other than the primary (stereo) audio signal. SAP (Second Audio Program) enables reception of a separate channel that may be a different language or completely different information such as the news.

OSD (On-Screen Display): A control panel on the television screen that allows you to select viewing options.

Saturation: Chromatic purity indicating the amount of white contained in a color. Fully saturated colors are pure colors; less saturated colors appear as pastel shades.

Stereo: is the default audio signal belonging to a particular channel.

S-Video: Separate video, a video cabling standard used to transmit video by keeping brightness (Y) and color information (C) on

separate channels. Most often used with camcorders, VCRs, and quality receivers and amplifiers to provide sharper pictures.

Free Manuals Download Website

<http://myh66.com>

<http://usermanuals.us>

<http://www.somanuals.com>

<http://www.4manuals.cc>

<http://www.manual-lib.com>

<http://www.404manual.com>

<http://www.luxmanual.com>

<http://aubethermostatmanual.com>

Golf course search by state

<http://golfingnear.com>

Email search by domain

<http://emailbydomain.com>

Auto manuals search

<http://auto.somanuals.com>

TV manuals search

<http://tv.somanuals.com>