

HANNSpree

HANNSpree, Inc.
2F, No.362, Ruei-Guang Rd., Neihu District,
Taipei City 114, Taiwan, R.O.C.
TEL: 886-2-87520000
FAX: 886-2-87527092
www.hannspree.com

HANNSpree

23" Liquid Crystal Display Television LT11-23A1

User's Manual



NTSCTVTWEN0804
MAC-001225

Table of Contents

1. Warranty and Service	4
2. Preface	5
3. Description of Warning Symbols.....	6
4. Safety Notices	7
5. Regulatory Information	15
6. Introducing the TV	17
Features.....	18
7. Checking Package Contents	19
8. Getting to Know Your TV	20
Side Panel Controls	20
Side Panel Ports	22
Rear Panel Input and Output Ports	23
9. Getting Started.....	25
Connecting to an Antenna or Cable TV	25
Connecting to AV Devices	26
Connecting to a VCR, VCD, or DVD player using component video.....	26
Connecting to a Video Camera Using S-video	27
Connecting to a VCR, VCD, or DVD player using composite video	28
Connecting Earphone.....	29
Connecting an Amplifier or Speakers	30
Connecting to a PC.....	31
Connecting the Power Adapter	32
10. Using the TV	33
Using the Remote Control	33
Turning the TV On and Off	34
Selecting Channels	34
Adjusting the Volume	35
Switching Source Signals	35
Using PIP and POP.....	36

Table of Contents

11. Adjusting On-Screen Display (OSD) Settings	38
OSD Setting Menus	38
Picture Settings	39
Brightness	40
Contrast	41
Backligh (PC mode)	42
Hue	43
Saturation	44
Sharpness	45
Black Level	46
Color Temperature	47
Preset	48
Audio Settings	49
Treble	50
Bass	51
Balance	52
BBE, TruSurround, and EALA	52
Earphone	53
Preset	54
TV Settings	55
TV/CATV	56
MTS	57
Auto Scan	58
Channel Add/Erase	59
Favorite Channel	60
PC Settings	61
Phase	62
Clock	63
Auto Adjustment	64
DOS Mode	64
Horizontal Position	65
Vertical Position	66

Table of Contents

Miscellaneous Settings	67
Wide	68
Language	68
Sleeper.....	69
Time	70
12. Taking Care of Your TV	71
13. Troubleshooting.....	72
14. Specifications	74
PIP Operation Mode.....	75
Computer Compatibility Chart.....	76
15. Glossary	77

The instructions on this manual are for the model(s) listed on the front cover. Before you start reading, check your product number by looking at the rear of your TV.

Thank you for purchasing our Liquid Crystal Display Television (LCD TV). With this product, you will be able to enjoy superior audio and video while enriching your lifestyle with advanced technology.

The Hannspree TV is warranted for one year limited service from the date the product is received (as shown on the Warranty and Service Manual); please refer to the "Warranty and Service Manual" for the detailed warranty information.

Hannspree provides complete service information in the included "Warranty and Service Manual" or directly from the Hannspree customer service center. Our service representatives will be very happy to serve you to your satisfaction.

The Hannspree e-mail address:
service@hannspree.com

This manual is designed to assist users in setting up and using the LCD TV. Information in this document has been carefully checked for accuracy; however, no guarantee is given to the correctness of the contents. The information in this document is subject to change without notice.

Copyright

© Copyright 2004 Hannspree, Inc.

All rights reserved. This product and related documentation are protected by copyright and are distributed under licenses restricting their use, copying, and distribution. No part of this documentation may be reproduced in any form by any means without prior written authorization of Hannspree, Inc., and its licensors, if any.

BBE, SRS, EALA Statement

BBE[®]

- Manufactured under license from BBE Sound, Inc.
- Licensed by BBE Sound, Inc. under USP4638258, 5510752 and 5736897.
- BBE and BBE symbol are registered trademarks of BBE Sound, Inc.
- BBE High Definition Sound restores clarity and presence for better speech intelligibility and musical realism.

SRS **TruSurround**

is a trademark of SRS Labs, Inc. TruSurround technology is incorporated under license from SRS Labs, Inc.

eala

EALA is a trademark of New Japan Radio Co., Ltd.

Description of Warning Symbols

Warning



This symbol is used to remind users to pay attention to important descriptions regarding usage and maintenance (repair) or additional important information related to this product.

Caution



This symbol is used to remind users to pay attention to the danger of electric shocks due to dangerous internal non-insulated components.

Electric Power Notice

Electric power may cause personal injury and mechanical damage if it is misused. Although safety has been taken into consideration during the design and production of this product, electric shock or fire can result when the product is misused. To prevent potential danger, follow the instructions below when installing, operating and cleaning the product. In addition, read the following “Safety Notices” on page 7 carefully before using the product to ensure that your TV’s safety.

**Power Supply Safety Notes**

1. To avoid electric shocks, do not use an extended power cord or an outlet that does not match this product's plug or leaves the plug exposed.
2. This product has a 3-pin grounded plug. The third pin connects to ground; do not remove it.
3. If the power cord or plug is damaged or worn, unplug it immediately and contact a qualified service technician for maintenance.
4. To avoid fire or electric shocks, do not overload electric power outlets.

**Installation Safety Notes****Antenna**

We suggest that you use an outdoor antenna to get the best signal possible, unless you have cable TV or a centralized indoor antenna system. You may, however, use an antenna indoors if it is placed in a location free from interference.

Location

Avoid allowing the TV to get prolonged exposure to sunlight or other strong sources of heat. Leave sufficient distance between the TV and the wall to provide enough space for the emission of heat.



Before You Proceed

1. Read the Safety Notices and the User's Manual carefully before turning the product on.
2. Keep your User's Manual in a safe place for future reference. Keep the box and packaging in case the product needs to be shipped in the future.
3. Follow the product and warning label instructions.
4. Any changes or modifications that do not follow the instructions in this manual will void this product's warranty.



Warning

To reduce the risk of fire or electric shock, do not expose this product to rain or moisture.



Power

To avoid danger of fires or electric shock, make sure that you use a proper adapter. The TV is compatible with the following adapter:

- LI SHIN INTERNATIONAL ENTERPRISE CORP.:
LSE0226B20150

Optimal Viewing Distance

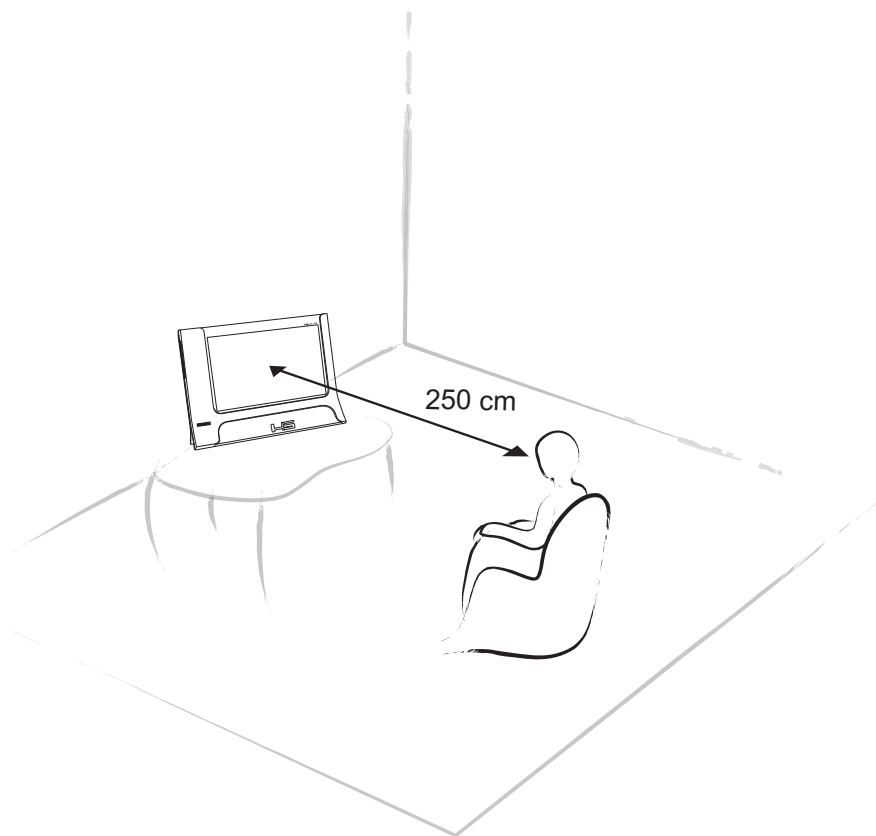

Important Safety Instructions



Read these instructions.
Keep these instructions.
Heed all warnings.
Follow all instructions.



Do not use this apparatus near water.



Clean only with a dry cloth.



Do not block any ventilation openings. Install in accordance with the manufacturer's instructions.



Do not install near any heat sources such as radiators, heat registers, stoves, or other apparatus (including amplifiers) that produce heat.

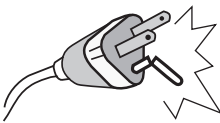

Do not defeat the safety purpose of the polarized or grounding-type plug. A polarized plug has two blades with one wider than the other. A grounding type plug has two blades and a third grounding prong. The wide blade or the third prong are provided for your safety. If the provided plug does not fit into your outlet, consult an electrician for replacement of the obsolete outlet.



Protect the power cord from being walked on or pinched, particularly at the plug, convenience receptacles, and the point where they exit from the apparatus.



Use only with a cart, stand, tripod, bracket, or table specified by the manufacturer, or sold with the apparatus. When a cart is used, use caution when moving the cart/apparatus combination to avoid injury from tip-over.



Only use attachments/accessories specified by the manufacturer.



Unplug this apparatus during lightning storms or when unused for long periods of time.



Refer all servicing to qualified service personnel. Servicing is required when the apparatus has been damaged in any way, such as if the power-supply cord or plug is damaged, liquid has been spilled or objects have fallen into the apparatus, the apparatus has been exposed to rain or moisture, does not operate normally, or has been dropped.

Personal Safety

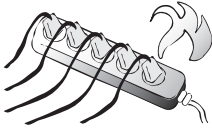

To avoid overloading the power supply, do not plug too many electrical devices into an outlet or extension cable.

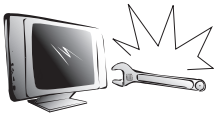

Dangerous high-voltage electric power components are located inside the TV. To avoid electric shock, do not disassemble the casing.



Do not place or drop metals, small objects, or flammable materials in the vent to avoid an electric shock or a fire.



If the TV is dropped, falls down, or is otherwise damaged, unplug the power cord immediately and notify a qualified service technician.



If any fluid is sprayed or dropped into the TV, remove the power plug immediately and notify a qualified service technician.



The screen of the TV is made of glass; be careful to avoid hitting or scraping it. If the screen is broken, avoid cutting yourself on the broken glass.



Do not allow children to use the TV unattended to avoid accidents caused by improper operation.

Installation



To avoid damage to power circuits, do not place the TV in locations where there is excessive steam or dust.



Do not place the TV on a bed, sofa, carpet, or in a sealed cabinet to avoid blocking the product's vents.

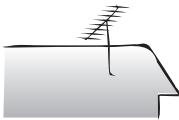

Install the outdoor antenna far from power transmission lines to avoid possible danger.



Remove the power cord and antenna connector when there is a storm or when the TV is not in use for a long period to avoid electric shock from lightning.

Operation



This product is designed for power sources as labeled on the casing. Avoid using any other power accessories to avoid electric shock or other damage.



The plug can be inserted into an outlet in only one direction. Notify a qualified service technician if you cannot plug it in correctly.



If there is any problem that cannot be resolved according to the instructions given in this manual, notify a qualified service technician immediately. Do not attempt any methods not covered in this manual.

Maintenance



Do not attempt to repair the TV by yourself. Notify a qualified service technician. Ask the service technician to complete a safety inspection before switching on the power after completing any maintenance.

FCC Compliance Statement¹

This device complies with part 15 of the FCC Rules. Operation is subject to the following two conditions: (1) This device may not cause harmful interference, and (2) this device must accept any interference received, including interference that may cause undesired operation.

This equipment has been tested and found to comply with the limits for a Class B digital device, pursuant to part 15 of the FCC Rules. These limits are designed to provide reasonable protection against harmful interference in a residential installation. This equipment generates, uses and can radiate radio frequency energy and, if not installed and used in accordance with the instructions, may cause harmful interference to radio communications. However, there is no guarantee that interference will not occur in a particular installation. If this equipment does cause harmful interference to radio or television reception, which can be determined by turning the equipment off and on, the user is encouraged to try to correct the interference by one or more of the following measures:

- Reorient or relocate the receiving antenna.
- Increase the separation between the equipment and receiver.
- Connect the equipment to an outlet on a circuit different from that to which the receiver is connected.
- Consult the dealer or an experienced radio/TV technician for help.

Warning: You are cautioned that changes or modifications not expressly approved by the party responsible for compliance could void your authority to operate the equipment.

1. applies only to products purchased in the United States of America

DOC Compliance Notice¹

This digital apparatus does not exceed the Class B limits for radio noise emissions from digital apparatus as set out in the Radio Interference Regulations of the Canadian Department of Communications. This device complies with Canada ICES-003 Class B.

CE Conformity Statement²

This device complies with the requirements set out in the Council Directive on the approximation of the Laws of the Member States relating to Electromagnetic Compatibility (89/336/EEC) and the Amendment Directive (92/31/EEC), Low-Voltage Directive (73/23/EEC) and the Amendment Directive (93/68/EEC).

-
1. applies only to products purchased in Canada
 2. applies only to products purchased in the European Union

Introducing the TV

Thank you for purchasing this Liquid Crystal Display TV. Your TV is designed to be safe, versatile, and easy to use. Its sturdy design makes it a decorative addition to your living room.

You can watch standard NTSC broadcast or cable television channels, and easily connect a VCR, VCD, or DVD player to the standard CVBS and S-Video input ports located at the rear and side of the unit. You can also use the TV as a monitor for your PC by connecting it through the DVI port.

Convenient control buttons located on the side panel let you change channels, adjust the volume, and change display settings through an easy-to-use on-screen menu system. The TV speakers provide full, rich stereo sound and a convenient audio output port lets you connect to an external audio system or earphone.

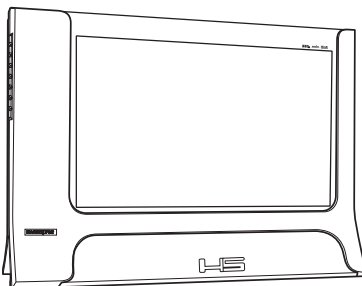

Features

- 23-inch color TFT LCD TV
- Safe, sturdy construction
- Built-in dual TV tuner
- Audio/video support:
 - Stereo audio inputs
 - Composite video inputs
 - Component video input
 - S-Video inputs
 - 3.5 mm stereo headphone output
 - DVI input
- On-screen display (OSD) menu system
- Multi-channel Television Sound (MTS) with SAP
- Built-in 7.5W+7.5W stereo audio amplifier
- PIP/POP
- Image Enhancement Technology
 - 3:2 pull down
 - DCDi
 - 3 D Y/C comb filter
- Noise Reduction
- De-interlace
- Edge Enhancement

7

Checking Package Contents

Make sure the following components are included in the box. Contact your vendor immediately if anything is missing or damaged.

TV

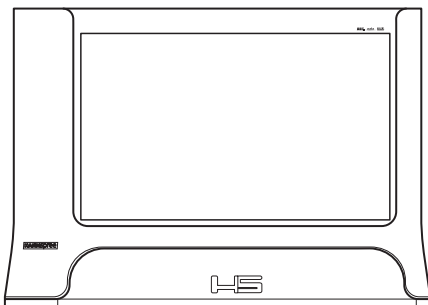

User's Manual



Quick Start Guide



Warranty and Service Manual



Cables

Power Cord

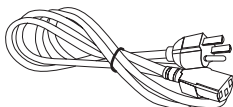

Power Adapter

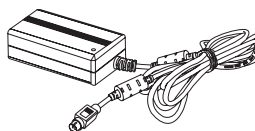

Side Panel Controls

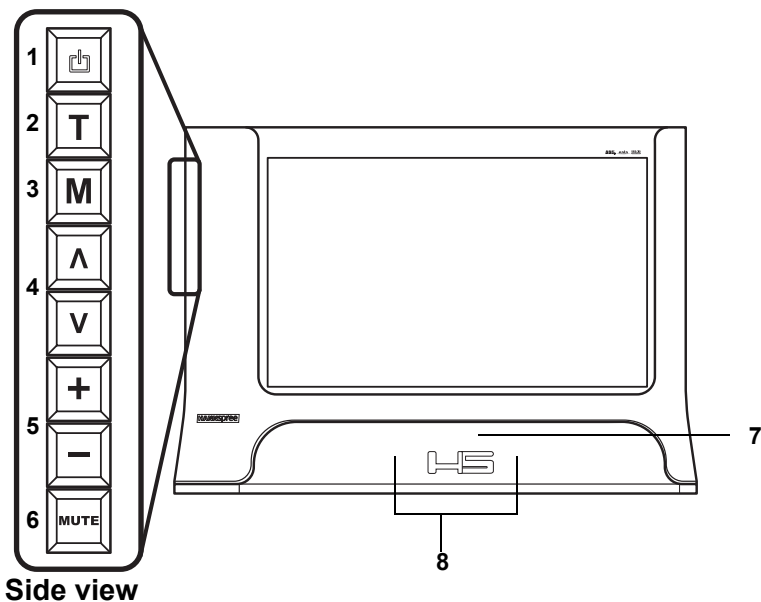

	Description	Function
1	Power button and LED	Turns the TV on and off. The green LED indicates power on. In PC mode, amber light indicates sleep status.
2	TV	Selects the input source to be displayed (TV, AV1, AV2, AV3, AV4, TV, or PC).
3	Menu	Turns the on-screen display (OSD) menus on and off.

Description	Function
4 Select channel	Changes the channel. Press \wedge to increase the channel number. Press \vee to decrease the channel number. These buttons are also used to navigate OSD menus.
5 Adjust volume	Press the $+$ button to increase the volume. Press the $-$ button to decrease the volume. These buttons are also used to navigate OSD menus.
6 Mute	Press this button to disable sound. Press this button again or press the volume adjust buttons directly to restore sound. In PC mode, press this button to automatically adjust the screen for your PC's display adapter.
7 Infrared sensor	Point the remote control towards the sensor to operate the TV.
8 Speakers	Produce high quality sound.

Side Panel Ports

Side view

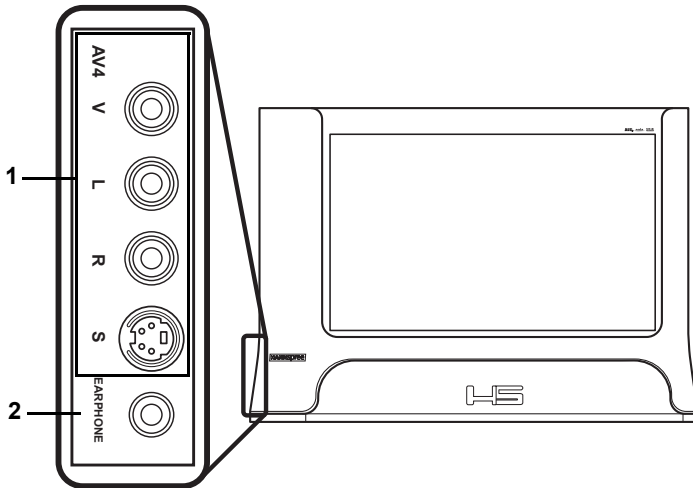

Description	Function
1 AV4	Use the AV4 input to connect an external device, such as a VCR or a VCD/DVD player. Audio Input (L, R): white and red audio cables. Video Input (S-Video or Video): yellow (video) or S-Video cable.
2 Earphone line out	Connects to earphone.

Rear Panel Input and Output Ports

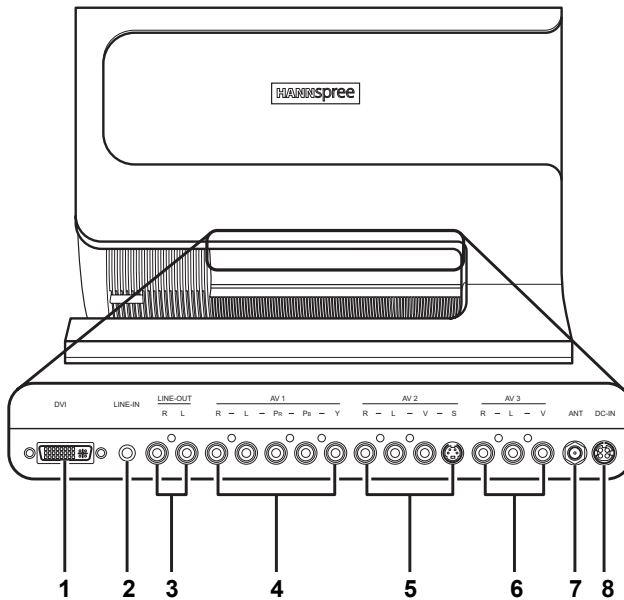

Description	Function
1 DVI	Connects to a PC's DVI port.
2 Line in	Connects to a PC's line/audio out port.
3 Line out	Connects to external amplifier or speakers.

Description	Function
4 AV1	<p>Use the AV1 input to connect an external device, such as a VCR or a VCD/DVD player with a component output.</p> <p>Audio Input (R, L): white and red audio cables.</p> <p>Video Input (PR, PB, Y): video cables.</p>
5 AV2	<p>Use the AV2 input to connect an external device, such as a VCR or a VCD/DVD player.</p> <p>Audio Input (R, L): white and red audio cables.</p> <p>Video Input (S or V): yellow (video) or S-Video cable.</p>
6 AV3	<p>Use the AV3 input to connect an external device, such as a VCR or a VCD/DVD player with a composite output.</p> <p>Audio Input (R, L): white and red audio cables.</p> <p>Video Input (V): yellow (video) cable.</p>
7 Antenna/cable TV line in	<p>Connects to an antenna or CATV cable television line.</p>
8 DC-IN	<p>Connects to the included power adapter.</p>

Connecting to an Antenna or Cable TV

- 1 Connect one end of the VHF/UHF (Antenna) or CATV cable to the ANT Jack (VHF/UHF IN Jack) on the back of the TV.
- 2 Connect the other end of the VHF/UHF (Antenna) or CATV cable to the Antenna or CATV socket.

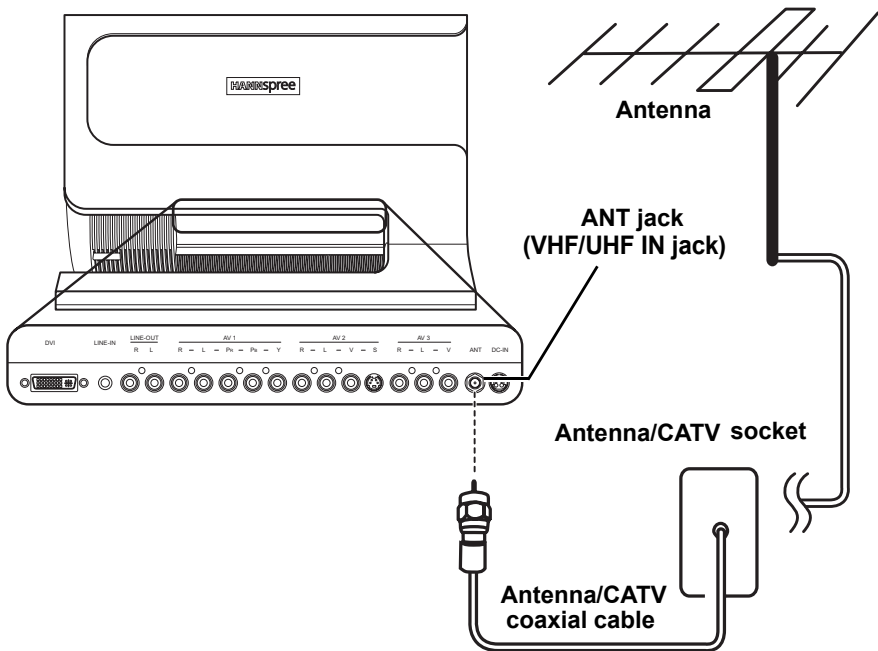

Note:

If you cannot receive channels after connecting to an antenna or cable TV line, try scanning for channels. See “Auto Scan” on page 58.

Connecting to AV Devices

Connect external devices such as VCD/DVD players or VCRs to the TV using the AV1, AV2, AV3, and AV4 ports on the back or side of the TV.

Connecting to a VCR, VCD, or DVD player using component video

The illustration presented here shows how to connect your TV to a VCR, VCD or DVD player using the AV1 component video port. Actual connections may vary according to the make and model of your device. Refer to the user's manual included with the AV device for more detailed instructions.

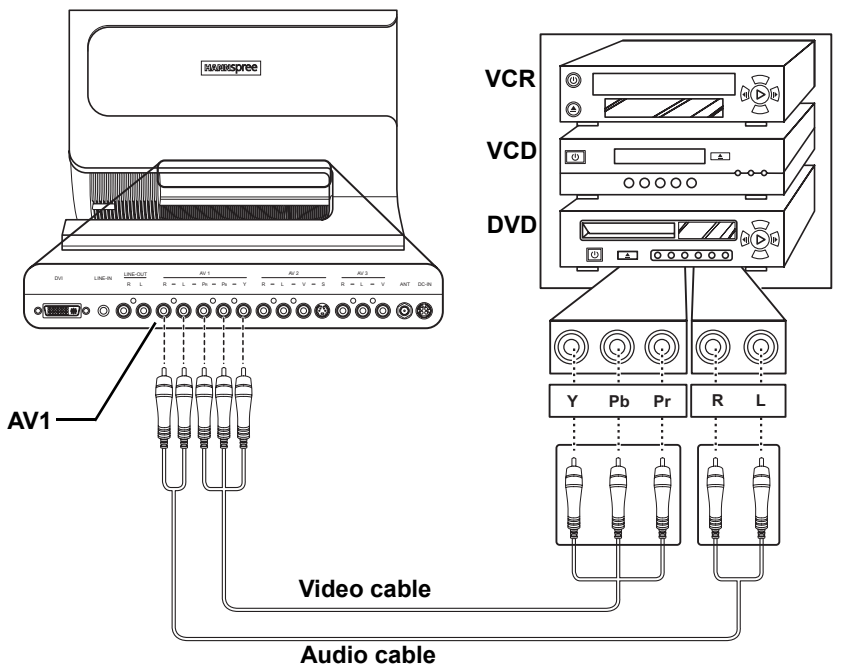

Cables and connectors are color-coded (red, blue, green).

Connecting to a Video Camera Using S-video

The following illustration shows how to connect the TV to a camcorder using the AV2 S-video port. Actual connections may vary according to the make and model of the device. Refer to the user's manual included with the camcorder for more detailed instructions.

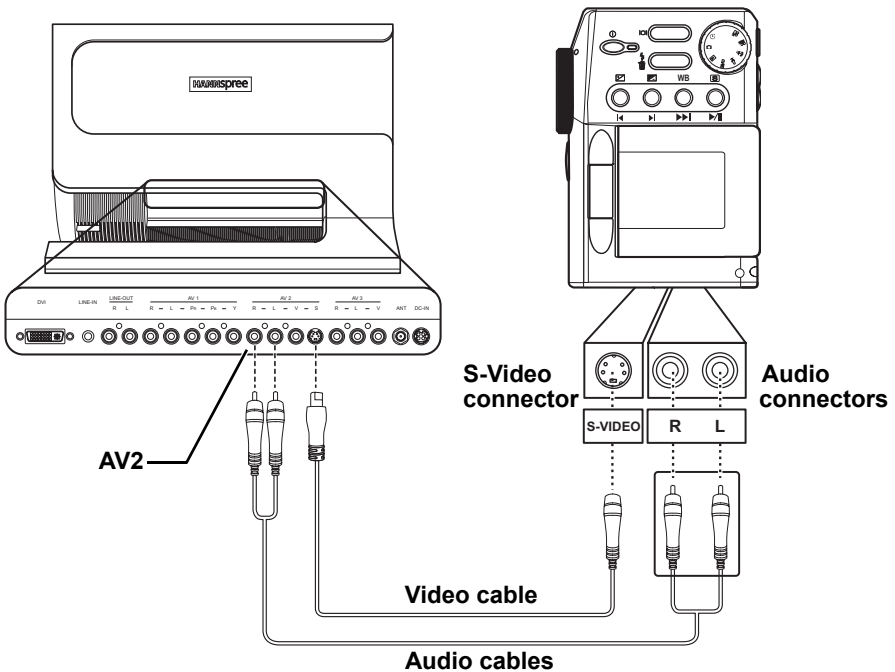

Note: When connecting the S-Video connector and AV connectors at the same time, the priority is given to the S-Video connector.

Cables and connectors are color-coded (red, white, yellow).

Connecting to a VCR, VCD, or DVD player using composite video

The illustration presented here shows how to connect your TV to a VCR, VCD or DVD player using the AV3 composite video port. Actual connections may vary according to the make and model of your device. Refer to the user's manual included with the AV device for more detailed instructions.

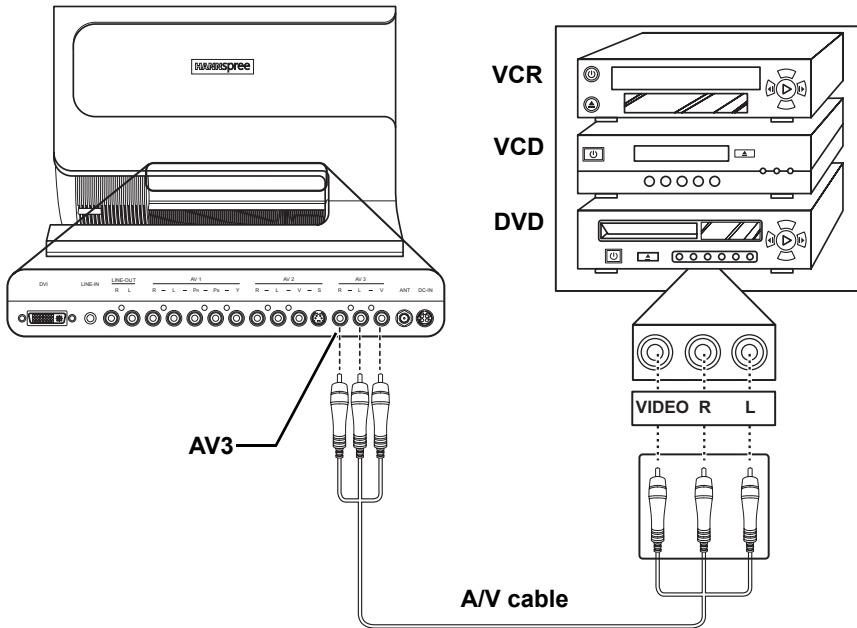

Cables and connectors are color-coded (red, white, yellow).

Connecting Earphone

You can use earphone to listen to the TV instead of using the built-in speakers. Connect earphone to the earphone line out port as illustrated.

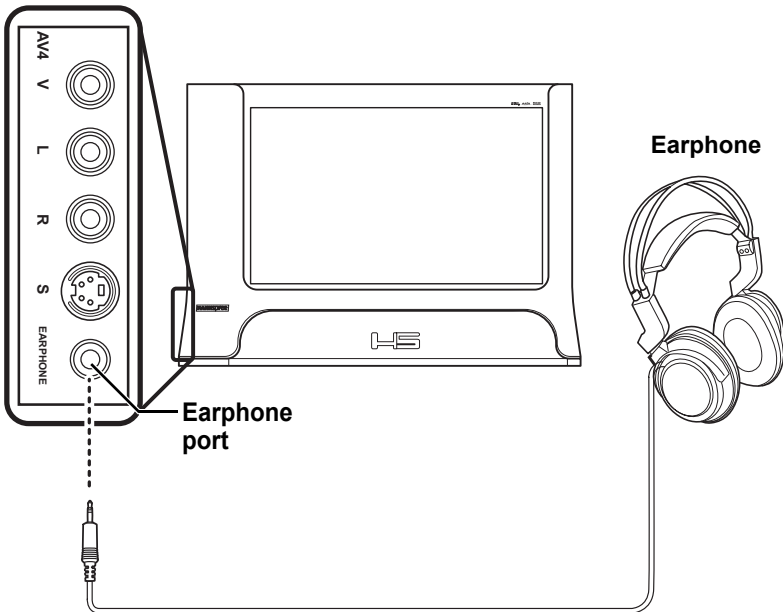

Note: Earphone is not included with the product.

Connecting an Amplifier or Speakers

Connect an external amplifier or speakers to the line out port to provide better sound quality. Refer to the following illustration.

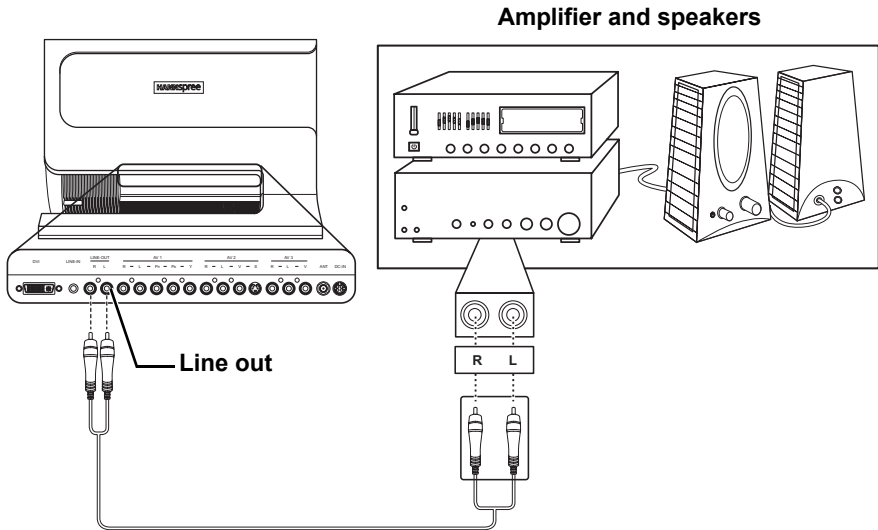

Connecting to a PC

Connect the TV to your PC to use it as the monitor using the DVI port as shown. Connect the DVI port of the TV to the DVI output of the PC. Connect the line out port of the PC to the line in port of your TV to listen to audio from the PC.

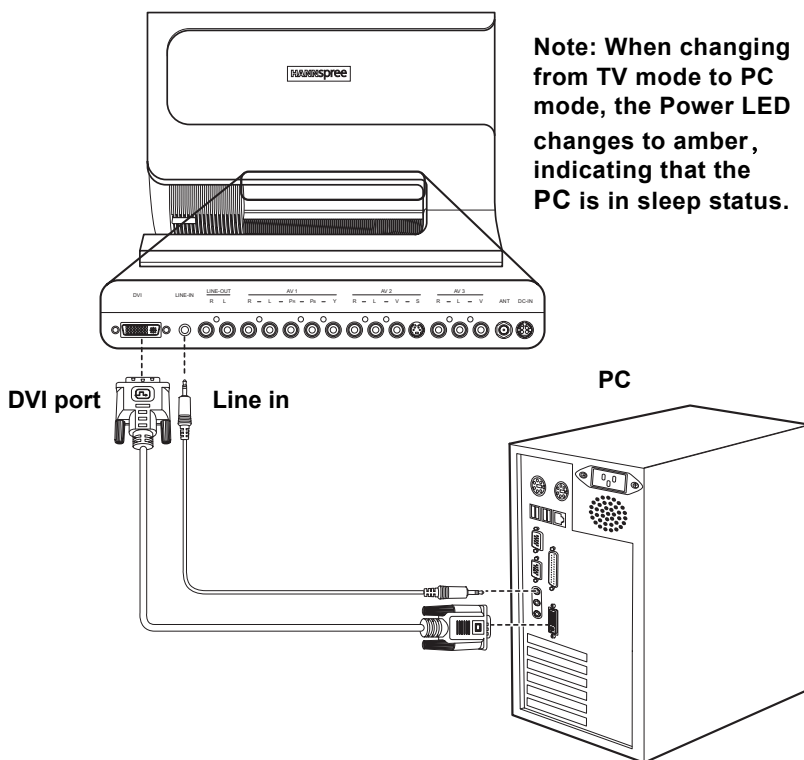

Connecting the Power Adapter

- 1 Connect the power cord to the power adapter as illustrated.
- 2 Plug the power adapter connector into the DC-IN on the rear panel of the TV.
- 3 Plug the three-pronged plug at the other end of the power cord into a power outlet.

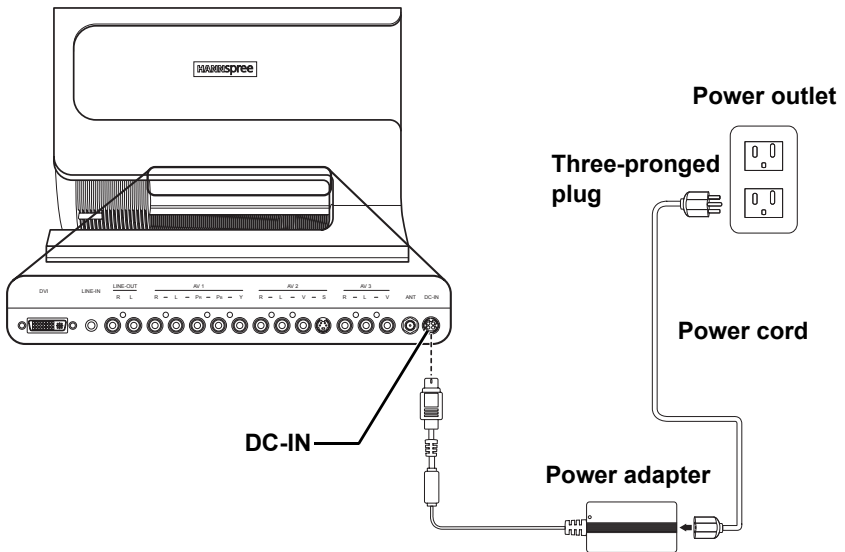

Using the Remote Control

For best result, use the remote control within a distance of 6 meters (20 feet) from the front of the TV's signal sensor. Do not exceed an angle of 30 degrees when pointing at the signal sensor. Refer to the following illustration.

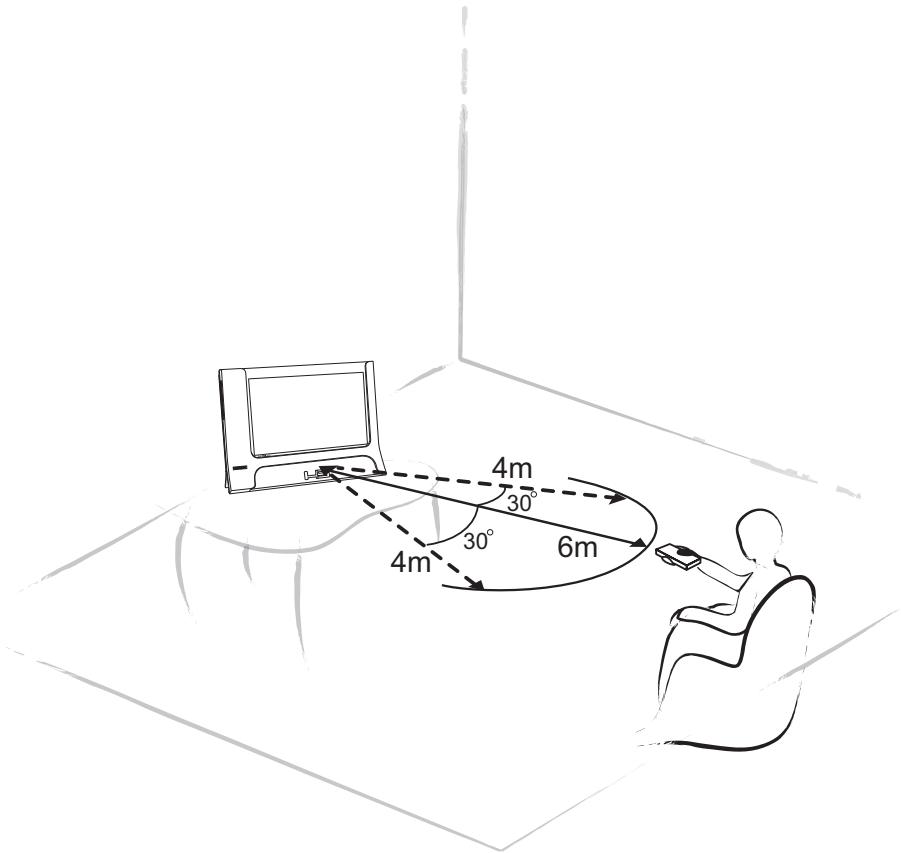

Turning the TV On and Off

- 1 Press the **POWER** button on the remote control or on the TV control panel. The power LED indicator on the side of the TV changes from red to green, indicating that the power is on.
- 2 Press the **POWER** button again. The power LED changes from green to red, indicating that the TV is off mode.

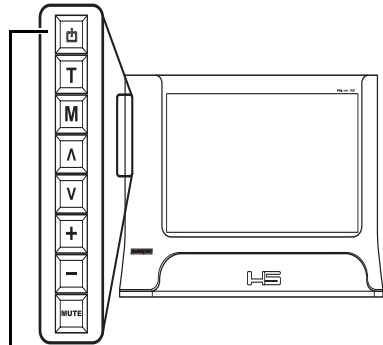

Power button and LED

Selecting Channels

- 1 Press the **CH ^** button to increase the channel number by one.
- 2 Press the **CH v** button to decrease the channel number by one.
- 3 Enter the specific channel number by pressing the number buttons on the remote control. The channel is displayed on the LCD panel.

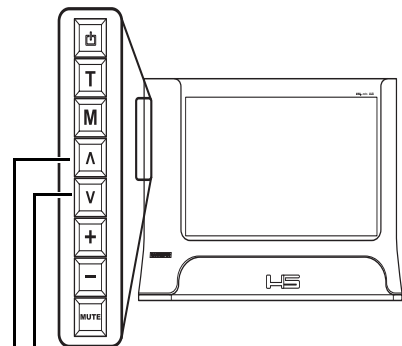

Channel down
Channel up

Adjusting the Volume

- 1 Press the **VOL +** button to increase the volume.
- 2 Press the **VOL –** button to decrease the volume.
- 3 Press the **MUTE** button. The word “MUTE” appears on the bottom right corner of the screen and sound is turned off.
- 4 Press the **MUTE** button again to restore the original volume.

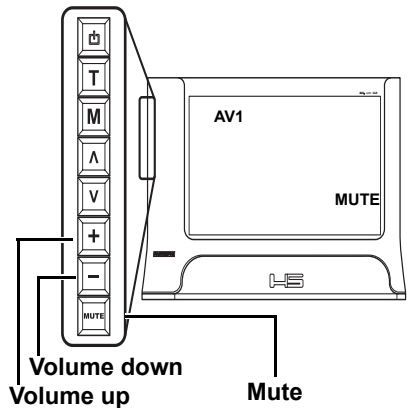

Switching Source Signals

Press the **TV** button repeatedly to select different source.

The selected source – TV, PC, AV1, AV2, AV3 and AV4 – appear on the top left corner of the screen in that order.

Note:

The TV supports S-Video input in addition to normal video and audio signals. The TV detects the signal type automatically and gives priority to S-video when two signals are detected at the same time.

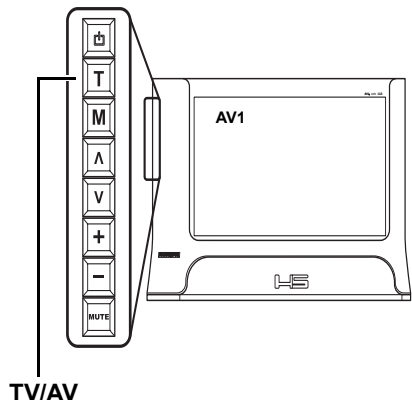

Using PIP and POP

The TV features Picture-in-Picture (PIP) and Picture-outside-Picture(POP), enabling you to view two sources at the same time. Follow these instructions.

- 1 Turn on the TV and select a source signal.



- 2 Press the PIP button on the remote control.

A picture-in-picture window appears on the display, using the last selected source signal for the PIP.

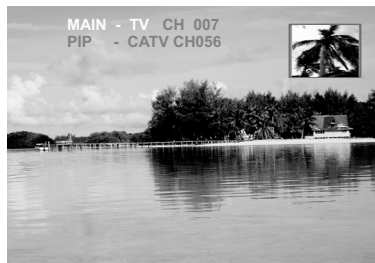

Note:

Refer to “PIP Operation Mode” on page 75 for information on which sources are compatible with each other in PIP and POP mode.

- 3 Press the SWAP button on the remote control to switch the focus from the PIP to the main source. The PIP identification line disappears and the PIP window border disappears.



-
- 4** Press the POSITION button on the remote control to move the PIP window to one of the four corners of the screen as shown.

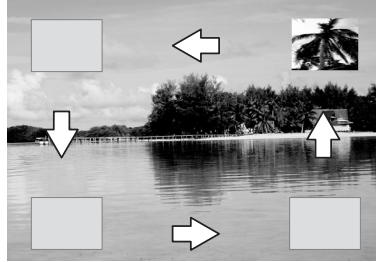

- 5** Press the PIP button to switch to POP mode.
The two signals are displayed side-by-side.



- 6** Press the PIP button again. The screen displays the main source signal again.



The On-Screen Display (OSD) menu system provides a quick and simple method to adjust your TV's setting. This chapter describes how to change each of the available settings. The OSD menu can be accessed through either the side control panel or the remote control.

Button Descriptions	Side Panel Control
Menu	MENU
CH Up	^
CH Down	v
VOL Up	+
VOL Down	-

The following sections explain how to adjust settings in the OSD menu using the side panel control.

OSD Setting Menus

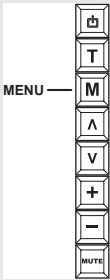

MENU —

MAIN MENU
 PICTURE
 AUDIO
 TV
 MISCELLANEOUS
 EXIT

⬇ : SELECT ⬅ : ENTER MENU : CLOSE

Press **MENU** to enter the OSD Main Menu screen.

The Main Menu appears.

Notes:

- Press the **MENU** button to open and close the OSD menu at any time.
- Alternatively, select the **CLOSE** option in the menu to return to the previous menu.

Picture Settings

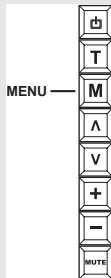

Press **MENU** to enter the OSD Main Menu screen.

MAIN MENU
PICTURE
AUDIO
TV
MISCELLANEOUS
EXIT

◄ : SELECT ◀▶ : ENTER MENU : CLOSE

- 1 Press CHANNEL \wedge or \vee to select PICTURE.
- 2 Press VOLUME + or - to enter the PICTURE Menu.

Notes:

- You can control the OSD with either the remote control or the side panel control.
- PC picture mode and TV picture mode have different menu items; PC picture mode includes a Backlight adjustment.

Brightness

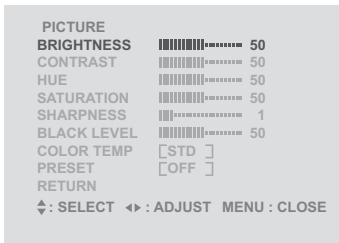

- 1 Press the CHANNEL \wedge or \vee button to select BRIGHTNESS. The slider bar shows the current setting.
- 2 Press the VOLUME + button to increase the brightness.
- 3 Press the VOLUME – button to decrease the brightness.

Note:

The new setting is confirmed automatically when the OSD times out.

	MIN	MID	MAX
BRIGHTNESS	0	50	100

Contrast

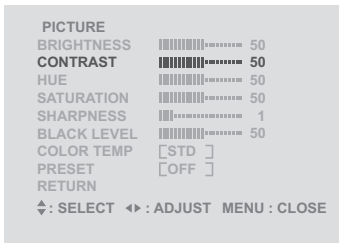

- 1 Press the CHANNEL \wedge or \vee button to select CONTRAST. The slider bar shows the current setting.
- 2 Press the VOLUME + button to increase the contrast.
- 3 Press the VOLUME - button to decrease the contrast.

Note:

The new setting is confirmed automatically when the OSD times out.

	MIN	MID	MAX
CONTRAST	0	50	100

Backligh (PC mode)

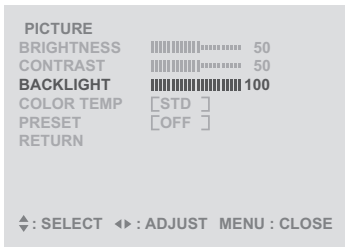

- 1 Press the CHANNEL \wedge or \vee button to select BACKLIGHT. The slider bar shows the current setting.
- 2 Press the VOLUME + button to increase the backlight intensity.
- 3 Press the VOLUME – button to decrease the backlight intensity.

Note:

The new setting is confirmed automatically.

	MIN	MID	MAX
BACKLIGHT	0	50	100

Hue

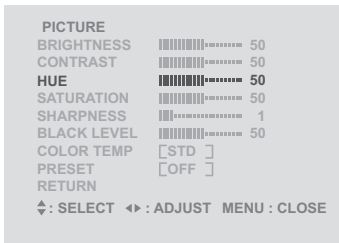

- 1 Press the CHANNEL \wedge or \vee button to select HUE. The slider bar shows the current setting.
- 2 Press the VOLUME + button to increase the hue.
- 3 Press the VOLUME - button to decrease the hue.

Note:

The new setting is confirmed automatically when the OSD times out.

	MIN	MID	MAX
HUE	0	50	100

Saturation

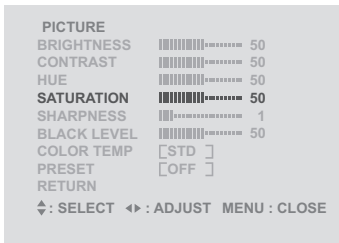

- 1 Press the CHANNEL \wedge or \vee button to select SATURATION. The slider bar shows the current setting.
- 2 Press the VOLUME + button to increase the saturation.
- 3 Press the VOLUME – button to decrease the saturation.

Note:

The new setting is confirmed automatically when the OSD times out.

	MIN	MID	MAX
SATURATION	0	50	100

Sharpness

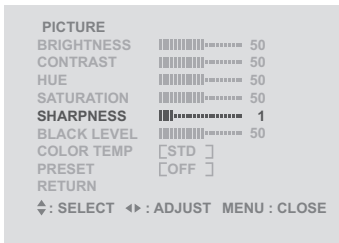

- 1 Press the CHANNEL \wedge or \vee button to select SHARPNESS. The slider bar shows the current setting.
- 2 Press the VOLUME + button to increase the sharpness.
- 3 Press the VOLUME - button to decrease the sharpness.

Note:

The new setting is confirmed automatically when the OSD times out.

	MIN	MID	MAX
SHARPNESS	0	1	7

Black Level

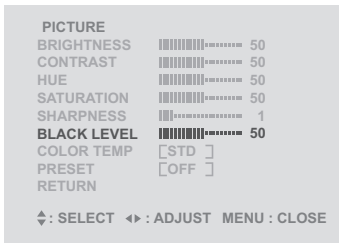

- 1 Press the CHANNEL \wedge or \vee button to select BLACK LEVEL. The slider bar shows the current setting.
- 2 Press the VOLUME + button to increase the black level.
- 3 Press the VOLUME - button to decrease the black level.

Note:

The new setting is confirmed automatically when the OSD times out.

	MIN	MID	MAX
BLACK LEVEL	0	50	100

Color Temperature

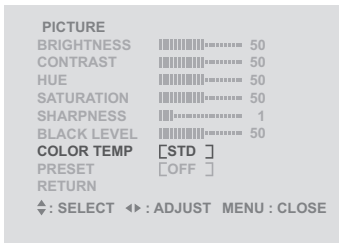

- 1 Press the CHANNEL \wedge or \vee button to select COLOR TEMP.
- 2 Press the VOLUME + or – button to change the color temperature. The current setting is shown in brackets. The following options are available:
 - **STD Color** – for standard color settings.
 - **WARM Color** – for color settings with red as the dominant color.
 - **COLD Color** – for color settings with blue as the dominant color.

Notes:

- The new setting is confirmed automatically when the OSD times out.
- The default color temperature is STD.

Preset

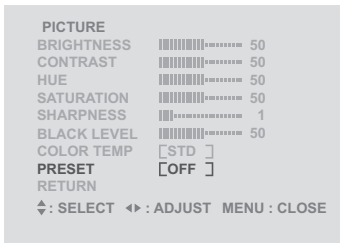

- 1 Press the CHANNEL \wedge or \vee button to select PRESET.
- 2 Press the VOLUME + or - button. "ON" appears in the brackets. All picture settings are returned to the factory-set default values.

Note:

The preset function erases all of your custom picture settings.

Audio Settings

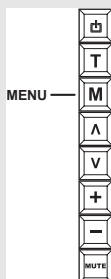

Press **MENU** to enter the OSD Main Menu screen.

MAIN MENU
PICTURE
AUDIO
TV
MISCELLANEOUS
EXIT

◄ : SELECT ◀▶ : ENTER MENU : CLOSE

- 1 Press CHANNEL \wedge or \vee to select **AUDIO**.
- 2 Press VOLUME $+$ or $-$ to enter the **AUDIO Menu**.

Note:

You can control the OSD with either the remote control or the side panel control.

Treble

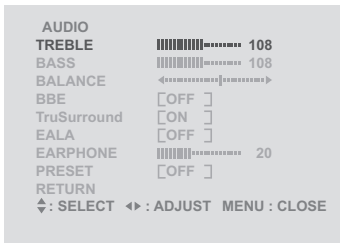

- 1 Press the CHANNEL \wedge or \vee button to select TREBLE. The slider bar shows the current setting.
- 2 Press the VOLUME + button to increase the treble.
- 3 Press the VOLUME – button to decrease the treble.

Note:

The new setting is confirmed automatically when the OSD times out.

	MIN	MID	MAX
TREBLE	0	108	216

Bass

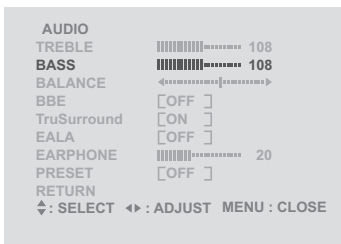

- 1 Press the CHANNEL \wedge or \vee button to select BASS. The slider bar shows the current setting.
- 2 Press the VOLUME + button to increase the bass.
- 3 Press the VOLUME – button to decrease the bass.

Note:

The new setting is confirmed automatically when the OSD times out.

	MIN	MID	MAX
BASS	0	108	216

Balance

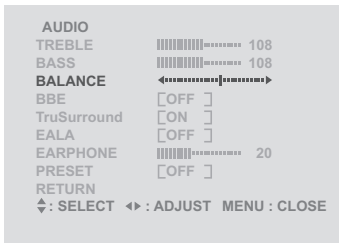

- 1 Press the CHANNEL \wedge or \vee button to select BALANCE. The slider bar shows the current setting.
- 2 Press the VOLUME + button to shift the balance to the right speaker.
- 3 Press the VOLUME - button to shift the balance to the left speaker.

Note:

The new setting is confirmed automatically when the OSD times out.

BBE, TruSurround, and EALA

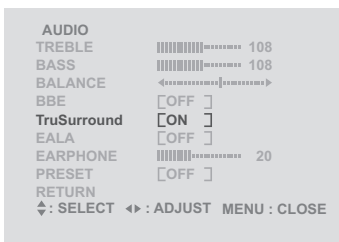

- 1 Press the CHANNEL \wedge or \vee button to select BBE, TruSurround, or EALA.
- 2 Press the VOLUME + or - button to select a setting for each effect:
 - BBE: off, high, low
 - TruSurround: on, off
 - EALA: on, off

Note:

Only one sound effect can be selected at a time.

Earphone

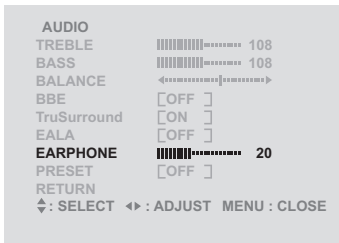

- 1 Press the CHANNEL \wedge or \vee button to select EARPHONE. The slider bar shows the current setting.
- 2 Press the VOLUME + button to increase the earphone volume.
- 3 Press the VOLUME – button to decrease the earphone volume.

Note:

The new setting is confirmed automatically when the OSD times out.

	MIN	MID	MAX
EARPHONE	0	20	50

Preset

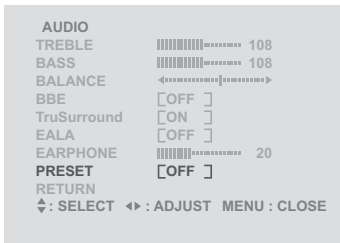

- 1 Press the CHANNEL \wedge or \vee button to select PRESET.
- 2 Press the VOLUME + or - button. "ON" appears in the brackets. All audio settings are returned to the factory-set default values.

Note:

The preset function erases all of your custom audio settings.

TV Settings

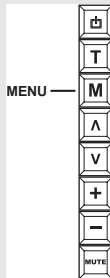

Press **MENU** to enter the OSD Main Menu screen.

MAIN MENU
PICTURE
AUDIO
TV
MISCELLANEOUS
EXIT

◆ : SELECT ◀▶ : ENTER MENU : CLOSE

- 1 Press CHANNEL \wedge or \vee to select TV.
- 2 Press VOLUME + or - to enter the TV Menu.

Notes:

- Operate the OSD with either the remote control or the side panel control.
- The TV OSD menu is not available if the input source is not TV.

TV/CATV

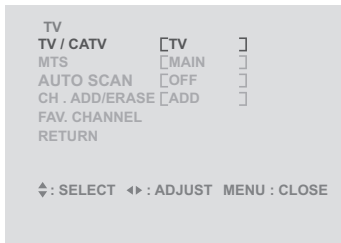

- 1 Press the CHANNEL \wedge or \vee button to select TV/CATV. The current setting is shown in brackets.
- 2 Press the VOLUME + button to select CATV in order to receive cable TV signals.
- 3 Press the VOLUME – button to select TV in order to receive broadcast TV signals.

Note:

The default TV setting is “CATV”.

MTS

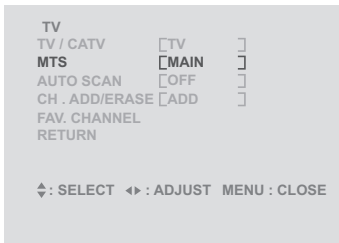

- 1 Press the CHANNEL \wedge or \vee button to select MTS. The current setting is shown in brackets.
- 2 Press the VOLUME + or - button to select from the various MTS options:
 - **MAIN** – select the main audio signal.
 - **SAP** – select the secondary audio signal
 - **DUAL** – enable both primary and secondary audio signals. The primary signal is output through the speakers. The secondary signal is output through the earphone.
 - **EX. DUAL** – exchange the primary and external secondary audio signals for speakers and earphones. i.e, the primary signal is output through the earphones and the secondary signal is output through the speaker.

Note:

If no secondary language is available, the MTS setting is always set to the main audio signal.

Auto Scan

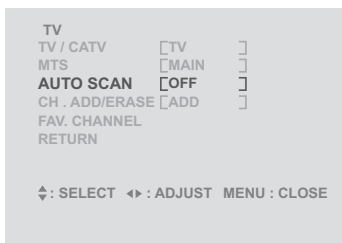

- 1 Press the CHANNEL \wedge or \vee button to select AUTO SCAN. The current setting is shown in brackets.
- 2 Press the VOLUME + button to enable auto scanning. "ON" is displayed in brackets and the TV starts scanning automatically for TV channels.

Note:

The TV screen displays the current channel that is successfully tuned after scanning is completed.

Channel Add/Erase

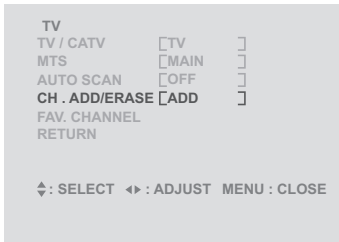

- 1 Press the CHANNEL \wedge or \vee button to select CH. ADD/ERASE. The current setting is shown in brackets.
- 2 Press the VOLUME + button to add the current channel.
- 3 Press the VOLUME – button to delete the current channel.

Note:

You can still access the erased channel by entering the channel number using the number buttons on the remote control. Add the channel again if it was erased accidentally.

Favorite Channel

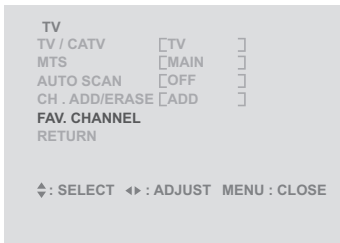

- 1 Press the CHANNEL \wedge or \vee button to select FAV.CHANNEL.
- 2 Press the VOLUME + or - button to enter the FAV.CHANNEL menu.



- 3 Press the CHANNEL \wedge or \vee button to select a favorite channel number 1 ~ 4.
- 4 Press the VOLUME + or - button to choose a channel to assign to the favorite channel number you selected in step 3.

Note:

Assigning a channel to one of the four favorite channel numbers replaces a previously stored channel assignment.

PC Settings

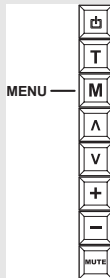

Press **MENU** to enter the OSD Main Menu screen.

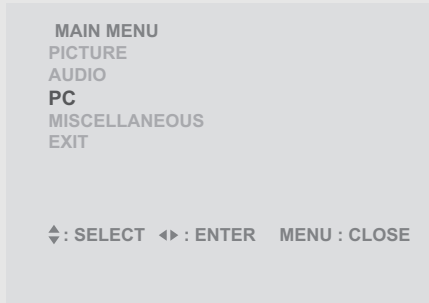

- 1 Press CHANNEL \wedge or \vee to select PC.
- 2 Press VOLUME + or - to enter the PC Menu.

Notes:

- Operate the OSD with either the remote control or the side panel control.
- The PC OSD menu is not available if the input source is not PC.

Phase

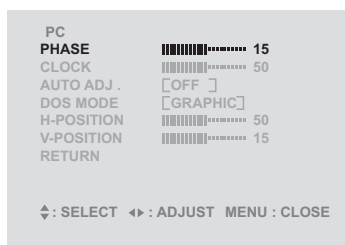

- 1 Press the CHANNEL \wedge or \vee button to select PHASE. The slider bar shows the current setting.
- 2 Press the VOLUME + button to increase the phase.
- 3 Press the VOLUME – button to decrease the phase.

Note:
The new setting is confirmed automatically.

	MIN	MAX
PHASE	0	31

Clock

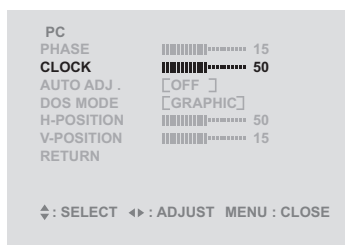

- 1 Press the CHANNEL \wedge or \vee button to select CLOCK. The slider bar shows the current setting.
- 2 Press the VOLUME + button to increase the clock.
- 3 Press the VOLUME – button to decrease the clock.

Note:
The new setting is confirmed automatically.

	MIN	MAX
CLOCK	0	100

Horizontal Position

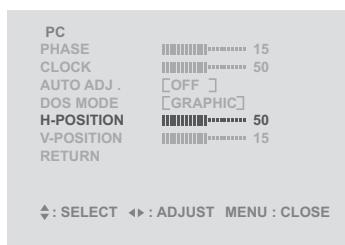

- 1 Press the CHANNEL \wedge or \vee button to select H POSITION. The slider bar shows the current setting.
- 2 Press the VOLUME + button to move the display to the right.
- 3 Press the VOLUME – button to move the display to the left.

Note:

The new setting is confirmed automatically.

	MIN	MID	MAX
H POSITION	0	50	100

Miscellaneous Settings

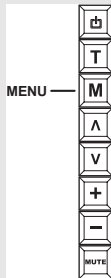

MENU —

Press **MENU** to enter the OSD Main Menu screen.

MAIN MENU
PICTURE
AUDIO
TV
MISCELLANEOUS
EXIT

◄ : SELECT ◀▶ : ENTER MENU : CLOSE

- 1 Press CHANNEL \wedge or \vee to select MISCELLANEOUS.
- 2 Press VOLUME + or - to enter the MISCELLANEOUS Menu.

Note:

Operate the OSD with either the remote control or the side panel control.

Wide

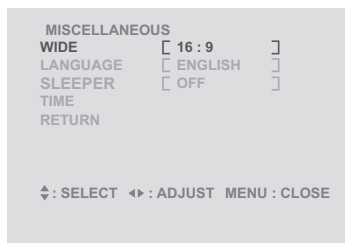

- 1 Press the CHANNEL \wedge or \vee button to select WIDE. The current setting is shown in brackets.
- 2 Press the VOLUME + or – button to select the screen format from the following:
 - 16:9
 - 4:3
 - Anamorphic

Language



- 1 Press the CHANNEL \wedge or \vee button to select LANGUAGE. The current setting is shown in brackets.
- 2 Press the VOLUME + or – button to select the language from the following:
 - English
 - Traditional Chinese

Note:

The default language setting is Traditional Chinese.

Sleeper

The sleep timer turns the TV off automatically after a set time.



- 1 Press the CHANNEL \wedge or \vee button to select SLEEPER. The current setting is shown in brackets.
- 2 Press the VOLUME + or – button to select a sleep timer value from the following: OFF, 30, 60, 90, or 120 minutes

You can also press **SLEEP** on the remote control to select OFF, 30, 60, 90 or 120 minutes. Press Display; the setting appears on the TV screen.

The remaining time is updated every 1 minute on the display.

Time

This setting allows you to set the system time.

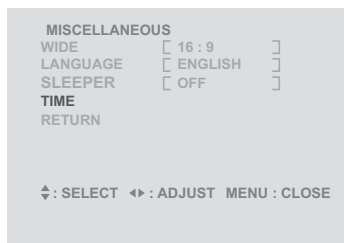

1 Press the CHANNEL \wedge or \vee button to select TIME.

2 Press the VOLUME + button to change the time.

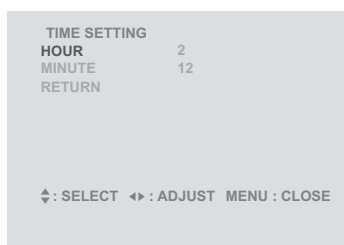

3 Press the CHANNEL \wedge or \vee button to select HOUR. Press the VOLUME + or - button to increase or decrease the hour.

4 Press the CHANNEL \wedge or \vee button to select MINUTE. Press the VOLUME + or - button to increase or decrease the minutes.

Taking Care of Your TV



Turn the power off before you begin cleaning the TV.



For best results, use a clean lens cloth to remove dust and fingerprints from the screen.



Do not wipe the shell of the TV with alcohol, methanol, gasoline or oil products to avoid damaging the finish. Wipe the shell with a dry soft cloth and use neutral cleaning fluids.

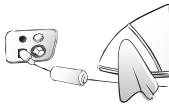

If your TV model has leather components, wipe the leather parts with a dry cloth and keep the area dry. Place the TV far from sources of steam to avoid making the leather wet.



Be careful to remove the power plug correctly. Hold the plug instead of pulling the power cord.

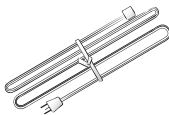

Arrange the power cord with other cords to avoid knotting or bending which may cause fire due to damage or electric leakage.

Situation	Solution
No picture and sound.	<ul style="list-style-type: none"> • Connect the power cord properly. • Press the POWER button on the control panel or remote control. • Press the TV button to cycle through connected video sources. • Press the CHANNEL UP or CHANNEL DOWN button to switch to other TV stations. • Check the TV/CATV OSD settings. See "TV/CATV" on page 56. • Make sure all cables are connected properly.
No picture, or poor picture, sound is OK.	<ul style="list-style-type: none"> • Check the antenna and cable connections. • Adjust the brightness in the OSD menus. See "Brightness" on page 40.
Picture is not in color.	<ul style="list-style-type: none"> • Adjust the saturation in the OSD menus. See "Saturation" on page 44.
Picture is OK, no sound.	<ul style="list-style-type: none"> • Press the VOLUME UP button on the control panel or remote control. • Make sure the MTS option is set to MAIN.
One of the speakers has no sound.	<ul style="list-style-type: none"> • Adjust the balance in the OSD menus. See "Balance" on page 52.
Can't receive some TV channels using cable TV.	<ul style="list-style-type: none"> • Try the Auto Program function in the TV Settings menu. See "Auto Scan" on page 58.
Want to reset TV settings.	<ul style="list-style-type: none"> • Use the Preset function in the OSD Picture and Audio menu.
Cannot operate menus.	<ul style="list-style-type: none"> • If OSD items are colored light blue, it means that these settings are not available. For example, TV settings are available in TV mode (when source is selected to be TV), but are not available in other modes.
No image but sound available.	<ul style="list-style-type: none"> • Make sure the video signal cable is connected properly.

Situation	Solution
No sound but have image.	<ul style="list-style-type: none"> • Make sure the source device is functioning properly. • Set the volume to a higher level. • Make sure the audio cable is connected securely. • Turn the mute off.
Screen image turns over.	<ul style="list-style-type: none"> • Make sure the video signal cable is connected properly.
Snow appears on the screen.	<ul style="list-style-type: none"> • Adjust the location of the antenna, placing it as far as possible from roads or sources of interference. • Check the antenna and the video signal line connections.
Blurred or overlapped images.	<ul style="list-style-type: none"> • Readjust the sharpness setting. • Choose programs with high quality signals. • Adjust the direction of the antenna or change the video signal cable.

LT11-23A1	
LCD Panel Size	23-inch TFT
Aspect Ratio	15:9
Best Resolution	1280 (horizontal) x 768 (vertical)
Maximum Display Area	303 mm (H) x 503 mm (V)
TV System	NTSC
Video System	AV1: Component Video (Audio in (R,L), YPbPr) AV2: Composite Video (RCA jack; + S-Video) AV3: Composite Video (RCA jack) AV4: Composite Video (RCA jack; + S-Video)
Component Format	480i, 480p, 576i, 576p, 720p, 1080i
Audio System	AV1, AV2, AV3, AV4: L/R RCA jacks (audio input) 8 mm line in jack (audio input) 3.5 mm earphone and L/R line out jacks (audio output)
Built-in stereo audio amplifier	7.5W + 7.5W
Power Supply	100~240V, 50/60 Hz, 20V DC
Power Consumption	< 150W
Weight (including base)	13.6 KG
Dimensions (including base)	487 mm (H) x 669 mm (W) x 199 mm (D)

PIP Operation Mode

The following table shows which main sources are compatible with PIP and POP sources.

Main Source	PIP Source	POP Source
AV1 (YPbPr or YCbCr)	AV2	—
	AV3	—
	AV4	—
	TV2	—
AV2 (S or CVBS)	AV2	AV2
	AV3	AV3
	AV4	AV4
	TV2	TV2
AV3(CVBS)	AV2	AV2
	AV3	AV3
	AV4	AV4
	TV2	TV2
AV4 (S or CVBS) "Front"	AV2	AV2
	AV3	AV3
	AV4	AV4
	TV2	TV2
TV	AV2	AV2
	AV3	AV3
	AV4	AV4
	TV2	TV2
PC	AV2	AV2
	AV3	AV3
	AV4	AV4
	TV2	TV2

Computer Compatibility Chart

The following table shows resolution and frequency values supported by the TV.

Resolution	Frequency	Remarks
640 X 400	70 Hz	—
	60 Hz	—
640 X 480	67 Hz	Mac
	72 Hz	—
	75 Hz	—
	56 Hz	—
800 X 600	60 Hz	—
	72 Hz	—
	75 Hz	—
	75 Hz	Mac
1024 X 768	60 Hz	—
	70 Hz	—
	75 Hz	—
	75 Hz	Mac

Aspect Ratio The ratio of width to height of a film, image or display screen.

BBE A proprietary audio enhancement technology. BBE compensates for distortion common to loudspeakers.

Broadcast TV Broadcasting video signals using high-frequency electromagnetic waves to distribute television channels to viewers (standard TV broadcast).

CATV Community Antenna Television, the original name for cable TV. A television distribution system that uses coaxial cable instead of the traditional radio broadcasting (over-the-air) method to deliver television, FM radio, and other services to consumers.

Color Temperature Adjusting the color temperature enables you to set the intensity of white light. Color temperature is measured in Kelvin (K). Higher color temperatures result in a blue tint. Lower temperatures result in a red tint.

EALA 3D surround sound enhancement technology that provides a more immersive and realistic soundscape.

Hue Colors in a color system are measured by hue, saturation and luminance. Hue indicates the predominant color.

LCD Liquid Crystal Display. A display technology that uses rod-shaped molecules (liquid crystals) that flow like liquid and bend light.

MTS Multi-channel Television Sound. Enables reception of audio other than the primary (MAIN) audio signal. DUAL enables reception of a stereo audio signal, while SAP (Second Audio Program) enables reception of a separate channel that may be a different language or completely different information such as the news.

Saturation Chromatic purity indicating the amount of white contained in a color. Fully saturated colors are pure colors; less saturated colors appear as pastel shades.

S-Video Super-video, a video cabling standard used to transmit video by keeping brightness (Y) and color information (C) on separate channels. Most often used with camcorders, VCRs, and quality receivers and amplifiers to provide sharper pictures.

TruSurround 3D audio surround technology that delivers virtual surround sound experience through any two speaker system, including internal television speakers and headphones.

VCD A compact disk format developed in 1993 by Sony and Philips to capture full-motion video. A standard Video CD can hold 74 minutes of near VHS-quality video and CD-quality sound.

Free Manuals Download Website

<http://myh66.com>

<http://usermanuals.us>

<http://www.somanuals.com>

<http://www.4manuals.cc>

<http://www.manual-lib.com>

<http://www.404manual.com>

<http://www.luxmanual.com>

<http://aubethermostatmanual.com>

Golf course search by state

<http://golfingnear.com>

Email search by domain

<http://emailbydomain.com>

Auto manuals search

<http://auto.somanuals.com>

TV manuals search

<http://tv.somanuals.com>