

This guide is designed as a reference to help you start using your LCD TV quickly. Please refer to the User's Manual for more detailed installation and safety instructions.

### Front View

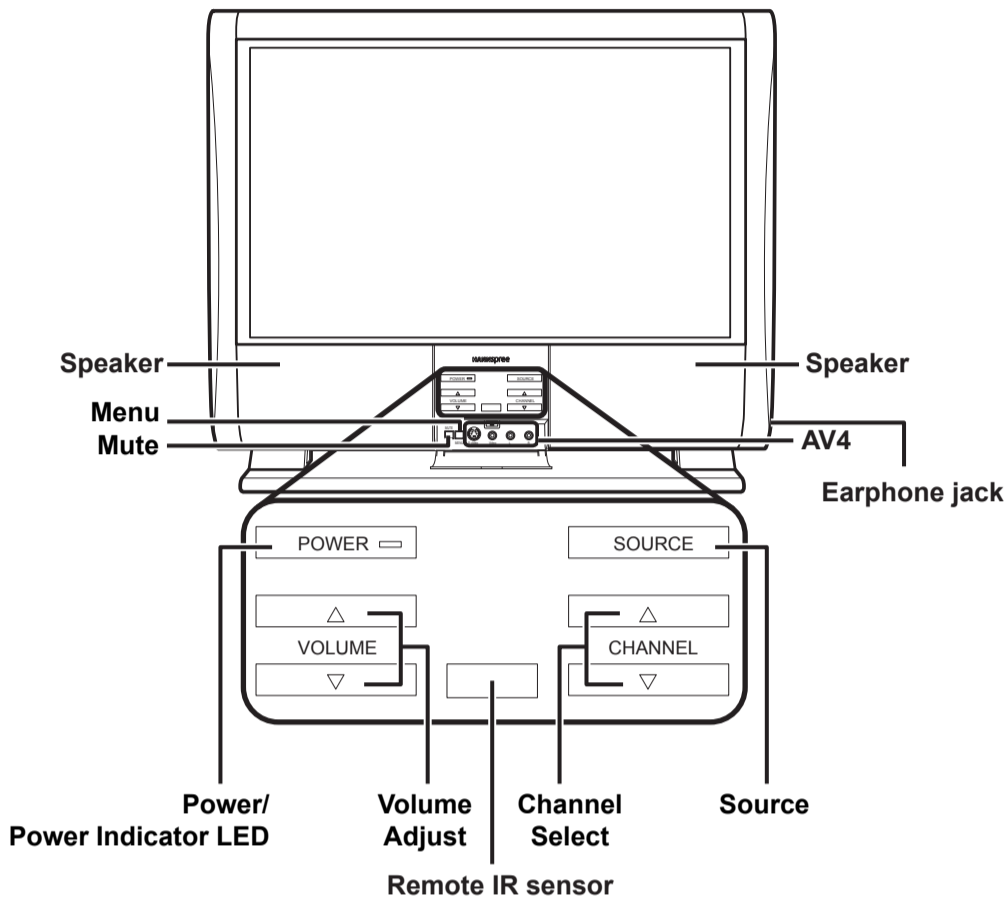

### Rear View

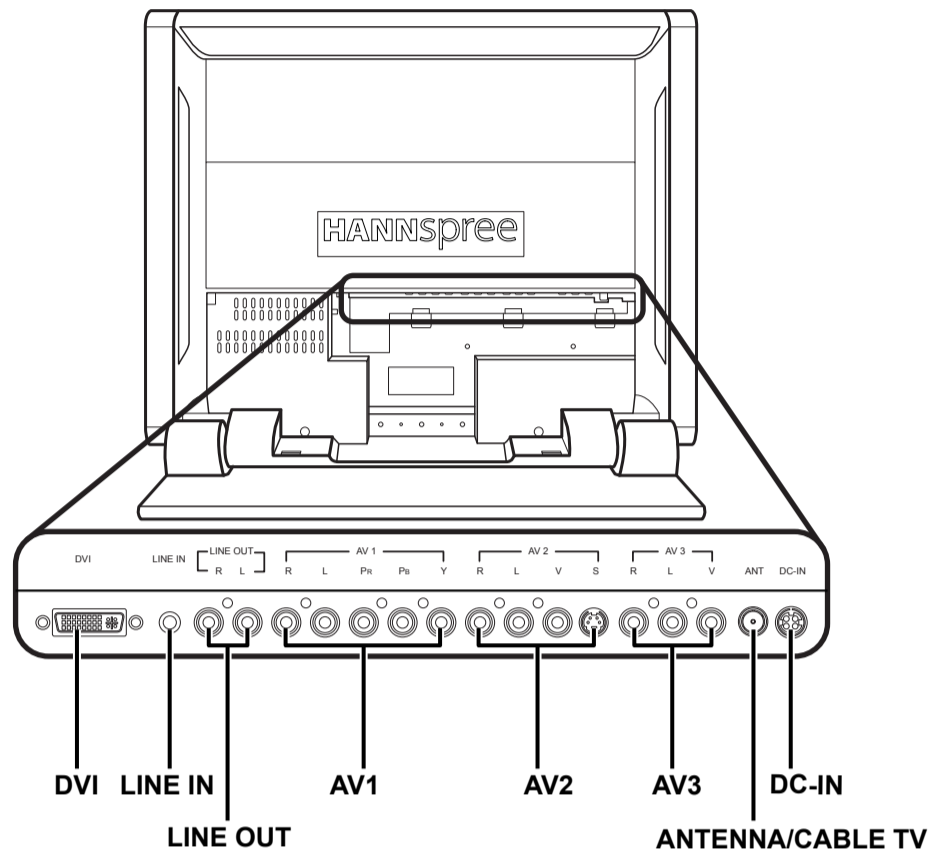

## Making Connections

### Connecting to Antenna/Cable TV/PC/AV Devices

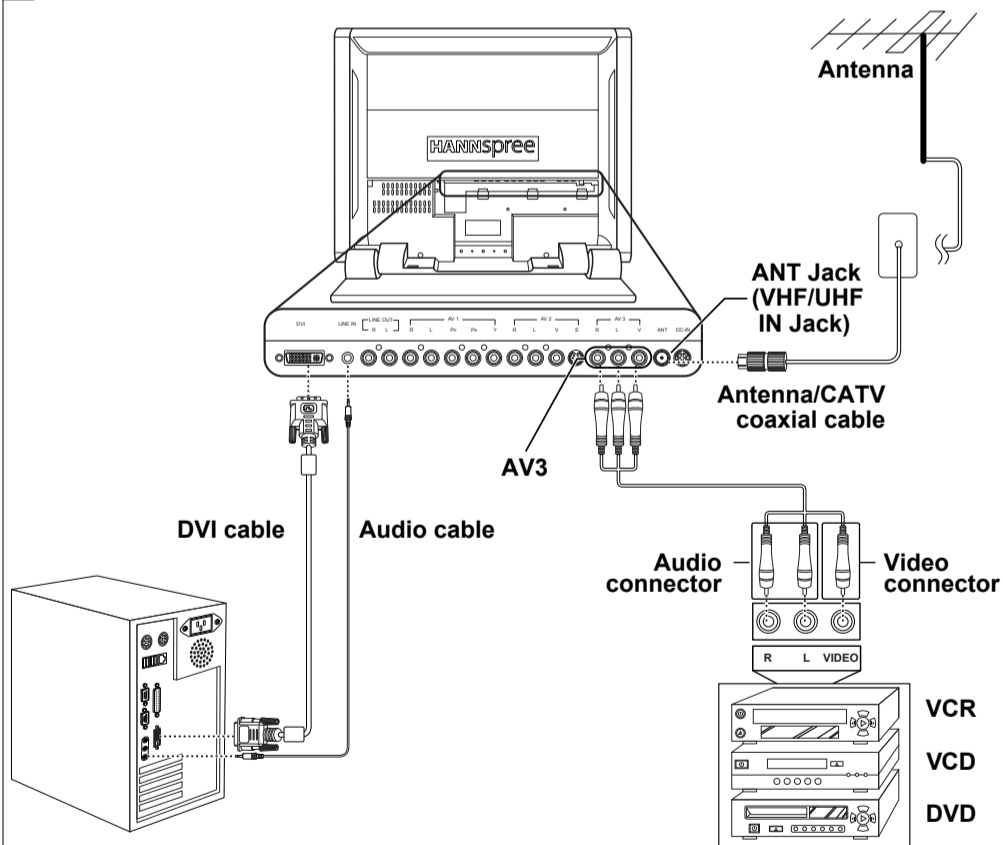

### Connecting the Power Adapter

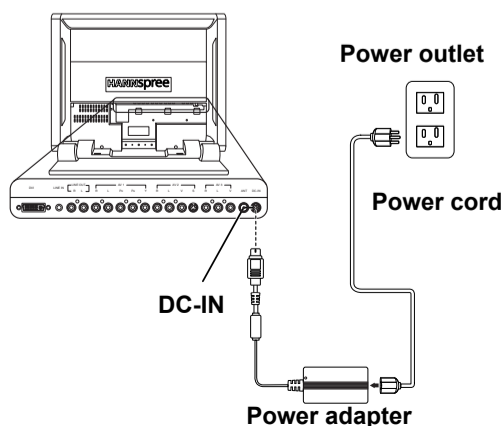

1. Connect the power cord to the power adapter as illustrated.
2. Plug the power adapter connector into the DC-IN input jack on the rear panel of the TV.
3. Insert the three-pronged plug at the other end of the power cord into a power outlet.

Note :  
Images are for illustration only and may vary by model or region.

## Getting Started

### Watching Broadcast or Cable TV

1. Press the power button to turn on your LCD TV.
2. Press the **SOURCE** button to select TV.
3. Press the **MENU** button to open the OSD menu.
4. Press the **CH**  $\Delta$  or  $\nabla$  button to select the "TV".
5. Press the **VOL**  $\Delta$  button to enter "TV MENU".
6. Press the **CH**  $\Delta$  or  $\nabla$  button to select "SYSTEM".
7. Press the **VOL**  $\Delta$  button to select "AUTO, B/G, D/K, I".

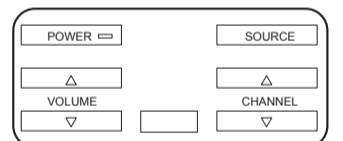

### Selecting A/V Sources

1. Make sure your TV is turned on and a device such as a DVD player is connected.
2. Press **SOURCE** key on the control panel to select different source signals.  
The TV channel number, PC or AV1 ~ AV4 appears on the screen.

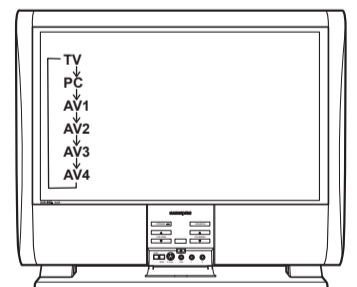

### Auto Channel Setup

Please follow the instructions by using the control panel.

1. Press the **MENU** button to enter the OSD menu.
2. Use the **CH**  $\nabla$  button to select "TV".
3. Press the **VOL**  $\Delta$  button to enter the TV setting.
4. Press the **CH**  $\nabla$  button until the "AUTO PROGRAM" feature is selected.
5. Press the **VOL**  $\Delta$  button to begin "AUTO PROGRAM".
6. Your television will begin automatically memorizing the available channels.

#### TV Menu



#### Auto Program

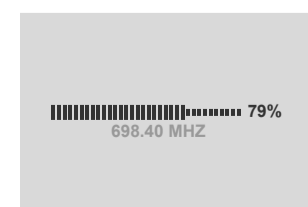

## Free Manuals Download Website

<http://myh66.com>

<http://usermanuals.us>

<http://www.somanuals.com>

<http://www.4manuals.cc>

<http://www.manual-lib.com>

<http://www.404manual.com>

<http://www.luxmanual.com>

<http://aubethermostatmanual.com>

Golf course search by state

<http://golfingnear.com>

Email search by domain

<http://emailbydomain.com>

Auto manuals search

<http://auto.somanuals.com>

TV manuals search

<http://tv.somanuals.com>