

HANNspree

HANNSPREE HONG KONG LIMITED

Unit 6, 2/F., No. 1, Hung To Road,
Kwun Tong, Kowloon, Hong Kong

TEL: 2345-3822

FAX: 2345-3790

www.hannspree.com

HANNspree

15" Liquid Crystal Display Television

T153

User's Manual



MAK-000019

Table of Contents

Regulatory Information	3
Description of Warning Symbols	4
Safety Notices	5
Preface	12
1. Getting Started	14
1.1 Package Contents	14
1.2 Product Introductions.....	15
1.2.1 Features.....	15
1.2.2 Control Panel	16
1.2.3 Input and Output Jacks	17
1.2.4 Remote Control	18
1.2.5 Inserting the Remote Control Batteries	21
2. Setting up your TV	23
2.1 Basic Connections.....	23
2.1.1 Power Connection.....	23
2.1.2 Antenna/Cable Connections	24
2.2 Connecting External Devices	25
2.2.1 Connecting to Earphones	25
2.2.2 Connecting to an Amplifier/Powered Speaker...	26
2.2.3 Connecting to AV Devices	27
2.2.4 Connecting to a PC.....	28
2.2.5 Connecting to a Video Game Console	29
2.3 Basic Operations	30
2.3.1 Power on/off	30
2.3.2 Switching Source Signals	30
2.3.3 Selecting Channels	30
2.3.4 Adjusting the Volume	30
2.3.5 Mute	30

2.3.6	Using the Remote Control	31
3.	Menu Setting	32
3.1	TV mode	34
3.1.1	Picture Setting	34
3.1.2	Audio Setting	37
3.1.3	TV Setting	39
3.1.4	Parental Control Setting(available in U.S. only)	44
3.1.5	Customize Setting	50
3.2	PC Mode.....	52
3.2.1	Picture Setting	52
3.2.2	Audio Setting	52
3.2.3	Image Setting	52
3.2.4	Customize Setting	54
4.	Technical Information	55
4.1	Maintenance	55
4.2	Troubleshooting	56
4.3	Specifications	59
4.4	PC Mode Support Timing	60
5.	Warranty and Service	61
Appendix A.	Glossary	62



Regulatory Information

FCC Compliance Statement¹

This device complies with part 15 of the FCC Rules. Operation is subject to the following two conditions: (1) This device may not cause harmful interference, and (2) this device must accept any interference received, including interference that may cause undesired operation.

Additional Information

This equipment has been tested and found to comply with the limits for a Class B digital device, pursuant to part 15 of the FCC Rules. These limits are designed to provide reasonable protection against harmful interference in a residential installation. This equipment generates, uses and can radiate radio frequency energy and, if not installed and used in accordance with the instructions, may cause harmful interference to radio communications. However, there is no guarantee that interference will not occur in a particular installation. If this equipment does cause harmful interference to radio or television reception, which can be determined by turning the equipment off and on, the user is encouraged to try to correct the interference by one or more of the following measures:

- Reorient or relocate the receiving antenna
- Increase the separation between the equipment and receiver
- Connect the equipment into an outlet on a circuit different from that to which the receiver is connected
- Consult the dealer or an experienced radio/TV technician for help

WARNING: The Federal Communications Commission warns that changes or modifications of the TV not expressly approved by the party responsible for compliance could void your authority to operate the equipment.

DOC Compliance Notice²

This digital apparatus does not exceed the Class B limits for radio noise emissions from digital apparatus as set out in the Radio Interference Regulations of the Canadian Department of Communications. This device complies with Canada ICES-003 Class B.

CE Conformity Statement³

This device complies with the requirements set out in the Council Directive on the approximation of the Laws of the Member States relating to Electromagnetic Compatibility (89/336/EEC) and the Amendment Directive (92/31/EEC), Low-Voltage Directive (73/23/EEC) and the Amendment Directive (93/68/EEC).

-
1. applies only to products purchased in the United States of America
 2. applies only to products purchased in Canada
 3. applies only to products purchased in the European Union

Description of Warning Symbols



Before You Proceed

1. Read all Safety Notices and instructions in this User's Manual carefully before either plugging in or turning the TV on.
2. Keep this User's Manual in a safe place for future reference. Keep the box and packaging in case the TV needs to be shipped in the future.
3. Follow the TV and warning label instructions.
4. Any uses, operations, changes, alterations or modifications of the TV that do not follow the instructions in this manual will void this TV's warranty.



CAUTION

RISK OF ELECTRIC SHOCK
DO NOT OPEN



WARNING



This symbol is used to alert users to pay attention to important descriptions regarding usage, maintenance (repair), and additional important information related to this TV.

CAUTION



This symbol is used to alert users to the risk of electric shocks due to dangerous and uninsulated components.



Safety Notices

Electric Power Notice

Electric power may cause personal injury and mechanical damage if misused. Although safety has been taken into consideration during the design and production of this TV, electric shock or fire can result if the TV is misused. To prevent potential danger, read and follow the instructions and warnings contained in this manual when setting up, operating or cleaning the TV. In addition, please read all "Safety Notices" contained in this manual carefully before using the TV.



Power Supply Safety Notes

1. To avoid electric shocks, do not use an extended power cord or an outlet that does not match this TV's plug or leaves the plug exposed.
2. This TV has a 3-pin grounded plug. The third pin connects to ground; do not remove it or alter it in any way.
3. If the power cord or plug is damaged or worn, unplug it immediately and contact an authorized service technician for maintenance.
4. To avoid fire or electric shocks, do not overload electric power outlets.



Installation Safety Notes

Antenna

We suggest that you use an outdoor antenna to get the best signal possible unless you have cable TV or a centralized indoor antenna system. You may, however, use an antenna indoors if it is placed in a location free from interference.

Location

Avoid prolonged exposure to sunlight or other strong sources of heat. Leave sufficient distance between the TV and the wall to provide enough space for the emission of heat.



WARNING

To reduce the risk of fire or electric shock, do not expose this apparatus to rain or moisture.

Apparatus shall not be exposed to dripping or splashing and no objects filled with liquids, such as vases, shall be placed on the apparatus.



Power

To avoid danger of fires or electric shock, only use those adapters listed below, which are compatible with this TV.

- EDAC POWER ELECTRONICS CO., LTD.: EA1050A-120
- LI SHIN INTERNATIONAL ENTERPRISE CORP.: 0218B1260

IMPORTANT SAFETY INSTRUCTIONS



- 1 Read these instructions.
 - 2 Keep these instructions.
 - 3 Heed all warnings.
 - 4 Follow all instructions.
-



- 5 Do not use this apparatus near water.
-



- 6 Clean only with dry cloth.
-



- 7 Do not block any ventilation openings. Install in accordance with manufacturer's instructions.
-



- 8 Do not install near any heat sources such as radiators, heat registers, stoves, or other apparatus (including amplifiers) that produce heat.
-

- 9 If the provided plug does not fit into your outlet, consult an electrician for replacement of the outlet.
-

- 10 Protect the power cord from being walked on or pinched, particularly at plugs, convenience receptacles, and the point where they exit from the apparatus.
-



- 11 Only use attachments/accessories specified by the manufacturer.



- 12 Use only with the cart, stand, tripod, bracket, or table specified by the manufacturer, or sold with the apparatus. When a cart is used, use caution when moving the cart/apparatus combination to avoid injury from tip-over.

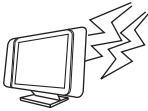

- 13 Unplug this apparatus during lightning storms or when not in use for long periods of time.



- 14 Refer all servicing to qualified service personnel. Servicing is required when the apparatus has been damaged in any way, such as power-supply cord or plug is damaged, liquid has been spilled or objects have fallen into the apparatus, the apparatus has been exposed to rain or moisture, does not operate normally, or has been dropped.

CAUTION



These servicing instructions are for use by qualified service personnel only. To reduce the risk of electric shock, do not perform any servicing other than that contained in the operating instructions unless you are qualified to do so.

Personal Safety

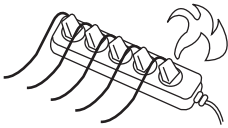

- 1 To avoid overloading the power supply, never plug too many electrical devices into an outlet, power strip, or extension cable.



- 2 Dangerous high-voltage electric power components are located inside the TV. To avoid electric shock, do not disassemble the TV in any way.

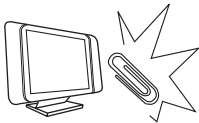

- 3 Do not place or drop metals, small objects, or flammable materials into the vent of the TV.



- 4 If the TV is dropped, falls down, or is otherwise damaged, unplug the power cord immediately and contact an authorized service technician.



- 5 If any fluid is sprayed or dropped into the TV, contact an authorized service technician.



- 6 The screen of the TV is made of glass. Avoid hitting or scraping it. If the screen is broken, do not touch the broken glass.

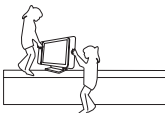

- 7 Do not allow children to use the TV unattended.
-

Installation



- 1 Do not place the TV in locations where there is excessive steam or dust.



- 2 Avoid blocking the TV's vents, do not place the TV on a bed, sofa, carpet, or in a sealed cabinet.

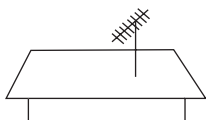

- 3 Install the outdoor antenna (not included) away from power transmission lines to avoid possible danger.



- 4 Unplug the power cord and antenna connector when there is a storm or when the TV is not in use for long periods to avoid electric shock from lightning.
-

Operation



1 This TV is designed for home power sources as labeled on the casing. Avoid using any other power accessories to avoid electric shock or other damage.

2 The plug can be inserted into an outlet in only one direction. Do not alter the plug. Contact an authorized service technician if you cannot plug it in correctly.



3 If there is any problem that cannot be resolved according to the instructions given in this manual, contact an authorized service technician immediately. Do not attempt any methods not covered in this manual.

Maintenance

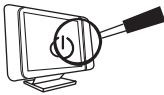

Do not attempt to repair the TV by yourself. Contact an authorized service technician. Ask the service technician to complete a safety inspection before switching the power on after completing any maintenance.



Preface

Thank you for purchasing a Hannspree Liquid Crystal Display Television (LCD TV). Your new TV allows you to enjoy superior audio and video while enriching your lifestyle with advanced technology.

Please carefully read this manual in its entirety before setting up, using or operating your TV. To ensure the safe and correct installation and operations of the TV, it is important that the safety and operation instructions in this manual are followed.

This instruction manual is designed to assist you in setting up and using the TV. The information in this manual has been carefully checked for accuracy; however, no guarantee is given to the correctness of the contents. The information in this manual is subject to change without notice.

To the extent allowed by applicable law, Hannspree, Inc. (“Hannspree”) shall not be liable for direct, indirect, special, exemplary, incidental or consequential damages arising from any defect or omission in this manual, even if advised of the possibility of such damages in advance.

This TV supports both NTSC and PAL system. Please refer to the following list for your local TV system.

TV system:

NTSC M: Japan, Taiwan, U.S.

PAL B/G: Singapore

PAL I: Hong Kong

PAL D/K: China

Copyright

© Copyright 2005 Hannspree, Inc.

All rights reserved. This manual is protected by copyright and distributed under licenses restricting its use, copying and distribution. No part of this manual may be reproduced in any form by any means without the prior written authorization of Hannspree. The TV described in this manual may include copyrighted software of Hannspree (or other third parties).

Hannspree (or other third parties) preserves the exclusive rights for copyrighted software, such as the right to distribute or reproduce the copyrighted software. Accordingly, and to the extent allowed by applicable law, any copyrighted software contained in the product described herein shall not be distributed, modified, reverse engineered, or reproduced in any manner without the prior written authorization of Hannspree (or of other third parties).

The Hannspree logos presented herein are trademarks of Hannspree. All other product names, trademarks or logos mentioned herein are used for identification purpose only, and may be the trademarks or registered trademarks of their respective owners.

The purchase of the product described herein shall not be deemed to grant, either directly or by implication, estoppel or otherwise, any license under the copyrights, patents, patent applications or trademarks of Hannspree, except for the normal, non-exclusive use that arises by operation of law in the sale of a product.

1.1 Package Contents

Please make sure your package coming with the following items. If any item is found missing or damaged, contact Hannspree Customer Service Center immediately.

- TV
- User's manual
- Quick start guide
- Warranty and service manual
- Power cord
- Power adapter
- 4-In-1 AV cable
- Remote control and battery/batteries
- PC Link cable or VGA cable
- Antenna Cable (Hong Kong only)
- Mounting device (selected models only- ST06)
- Stop Card (U.S. only)

1.2 Product Introductions







1.2.1 Features

This LCD TV allows viewers to watch NTSC/PAL television channels, and easily connect a VCR, VCD, or DVD player to the standard Video and S-Video input ports located at the rear of the unit. Moreover, you may connect your LCD TV to a PC, serving as a monitor.









Convenient control buttons located on the control panel allows you to change channels, adjust the volume, and change display settings through an easy-to-use on-screen display system. The TV speakers provide full, rich stereo sound and a convenient audio output port allows you to connect to an external audio system or earphones. Detailed features are described as follows:

- 15-inch color TFT LCD TV
- Safe, sturdy construction
- Built-in TV tuner
- Audio/Video support
 - Stereo audio inputs (L/R)
 - Composite video input
 - S-Video input
- PC function
- On-screen display (OSD) menu system
- To support multi-channel broadcasting sound system
 - Stereo/ Mono or bilingual languages
- Built-in stereo audio speakers
- SRS WOW sound effect
- NTSC/PAL system
- 3D comb filter
- Advanced de-interlacing

1.2.2 Control Panel

Description	Button	Function
Power	-  - On/Off	Turn the TV on or off.
Source	- Source - S	Select the input source to be displayed.
Menu	- Menu - M	Press to open the OSD menu.
Channel select	CH UP ( />>/  /+/^) CH DOWN ( /</  /-/∨)	Channel UP increases the channel number or moves upward to the previous item on the OSD menu. Channel DOWN decreases the channel number or moves downward to the next item on the OSD menu.
Volume adjust	VOL UP (+)>/  /∧/▲) VOL DOWN (-)</  /∨/▼)	Volume UP increases the volume or moves to the right on the OSD menu. Volume DOWN decreases the volume or moves to the left on the OSD menu.
Mute/ Auto	Mute Auto A	Under TV mode, press the button to eliminate the sound. Press it again or press the volume adjust buttons directly to restore sound. Under PC mode, press it to adjust H. position and V. position of the screen.
Power indicator LED		Indicates power status.

1.2.3 Input and Output Jacks

Description	Connector	Function
Power connector	- DC-IN  - DC 12V	Connect to the included power adapter.
Video & Audio connector	R/L/Video 	Use the AV1 input to connect an external device, such as a VCR, VCD, or DVD player. Audio Input: AV connector audio (white and red) cables. Video input: AV connector video (yellow) or S-Video cable.
Video & Audio Connector	- AV2  - AV In	Use the included 4-IN-1 AV cable to connect external devices, such as a VCR, VCD, DVD player or game console. Audio Input: AV connectors audio (white and red) cables. Video Input: AV connector video (yellow) or S-Video cable.
Audio output	Line Out 	Connect to external stereo speakers with built-in amplifier.
Audio input	Line In 	Connect to a PC's line out jack.
VGA/PC IN		Connect to a PC.
Antenna	ANT 	Connect to an antenna or CATV cables television line.
Earphone	-  - Earphone 	Connect to earphones or external speaker with built-in amplifier.

1.2.4 Remote Control

Description	Icon	Function
Menu/Enter (Enter: not for all remote control)	MENU/ ENTER	Turn the on-screen display (OSD) menu on and off/ confirm your selection or setting.
Arrow	▲/▼/◀/▶ </>	Press up, down, left or right to scroll through the on-screen display menus. You can assign the favorite channels to the arrow buttons.
Number	1 2 3 4 5 6 7 8 9 0	Use to select a channel directly. Press 0-9 to enter the channel number (press 1 and 0 for channel 10).
Last/Recall (not for all remote control)	LAST/ RECALL	Press this button to the last channel selected.
CC (not for all remote control)	CC Caption	Press this button to enable the closed captions/subtitles (only available with 15" TVs in the United States of America.) This option may not be available in your local area.
Display	DISPLAY	Press this button to show messages on the screen, such as the channel number, MTS mode and others. Press the button again to close the displayed message.

Description	Icon	Function
MTS (NTSC system only)	MTS	MTS: Multi-channel Television Sound-MAIN/SAP/MONO MPX: (Stereo/Mono/I/II)
MPX (PAL system only)		The indicator on the top right corner of the screen is yellow when the program has bilingual capabilities. Press to enable the function.
Mute	MUTE	Press this button to eliminate sound. Press it again or press the volume adjust buttons to restore sound.
Sleep (Not for all remote control)	SLEEP	Press this button repeatedly to set the TV timer(30, 60, 90, or 120 minutes). A timer appears on the top right corner of the screen to show the time remaining. Cancel the timer by pressing the button until the displayed time disappears.
Power		Turn the TV power on or off.
Volume adjust	VOL UP (+/▲/>) VOL DOWN (-/▼/⟨)	VOL UP increases the volume. VOL DOWN decreases the volume.
Channel select	CH UP (▲/+/^) CH DOWN (▼/-/∨)	CH UP increases the channel number. CH DOWN decreases the channel number.
Source	SOURCE	Select the input source to be displayed. The source is displayed on the top right corner of the screen.

Description	Icon	Function
Parental (available in U.S. only/ not for all remote control))	Parental	Open the parental setup menu. This button allows you to change parental settings.
Auto (not for all remote control)	AUTO	Under PC mode, press to adjust H. position and V. position. Press the button to automatically adjust the screen parameters in PC mode.
Reset (not for all remote control)	RESET	Recover the default value.

1.2.5 Inserting the Remote Control Batteries

1. Open the battery compartment cover at the back of the remote control (A).
2. **For AAA batteries**, insert the batteries paying attention to the polarity markings inside the battery compartment (B).
For lithium batteries, insert the battery/batteries with the positive side (+) facing up (B). Remember to slide the battery/batteries underneath the metal contacts. Press downward to set the battery/batteries in place.
3. Replace the battery compartment cover (C)/(D).

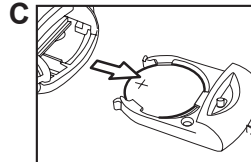
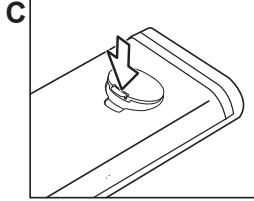
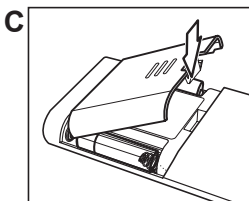
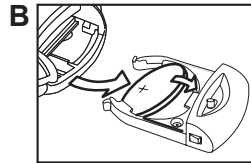
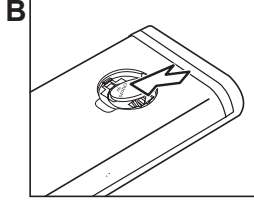
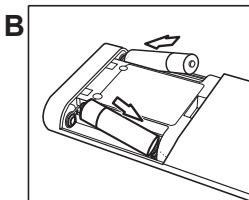
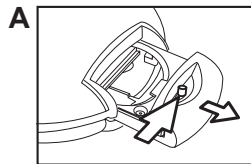
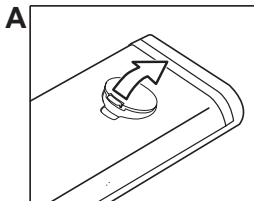
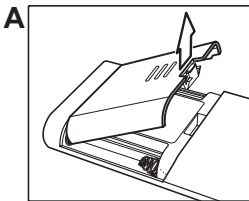

AAA batteries

Lithium batteries 1

Lithium batteries 2

Note: Replace new batteries that are of the same type included in your remote control.

CAUTION



- If the remote control is not used for a long period, remove the batteries and store them separately.
- Handle damaged or leaking batteries carefully, and wash hands after such handling.
- Refer to your local recycling or waste disposal rules and contact a local waste disposal vendor to dispose of used batteries.
- If your remote control has two batteries, do not mix new and old batteries because the life of the new batteries will be shortened. Chemical fluids may leak from the old batteries.
- Danger of explosion if battery is incorrectly replaced. Replace only with the same or equivalent type recommended by the equipment manufacturer. Discard used batteries according to manufacturer's instructions.
- Your remote control may have a magnet in it, so do not place magnetic sensitive items such as watches, credit cards, or flash media close to it.
- Do not use force when pulling the remote control cover open; you may damage the hinge.

2.1 Basic Connections

The following sections provide users with some basic instructions to use the TV. Please read them carefully before you start utilizing the functions.

2.1.1 Power Connection

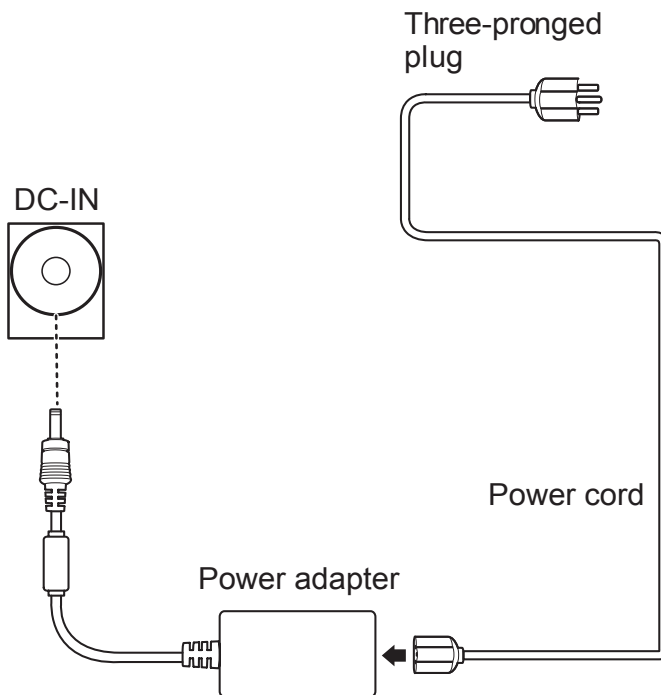

- 1 Connect the power cord to the power adapter as illustrated.
- 2 Plug the power adapter connector into the DC-IN jack on the rear panel of the TV.
- 3 Plug the three-pronged plug at the other end of the power cord into a power outlet.

Note: *Images are for illustration only and may vary by model or region*

2.1.2 Antenna/Cable Connections

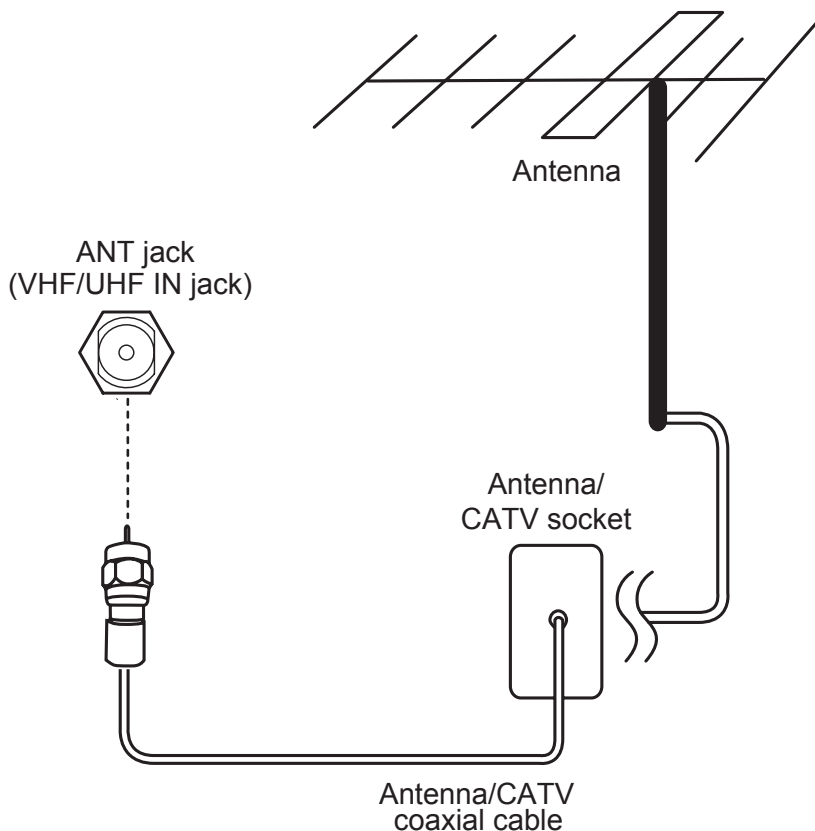

- 1 Connect one end of the VHF/UHF (Antenna) or CATV cable to the ANT jack (VHF/UHF IN jack) on the back of the TV.
- 2 Connect the other end of the VHF/UHF (Antenna) or CATV cable to the antenna or CATV socket.

Note: *If you cannot receive channels after connecting to an antenna or cable TV line, try scanning for channels (please refer to “TV Setting” on page 39).*

2.2 Connecting External Devices

2.2.1 Connecting to Earphones



You may use earphones or external speakers with built-in amplifier instead of built-in speakers to listen to the TV. Connect earphones to the earphone jack as illustrated.

- Note:**
- *Earphones are not included in the package.*
 - *The built-in TV speakers will not output sound when earphones are plugged in.*

2.2.2 Connecting to an Amplifier/Powered Speaker

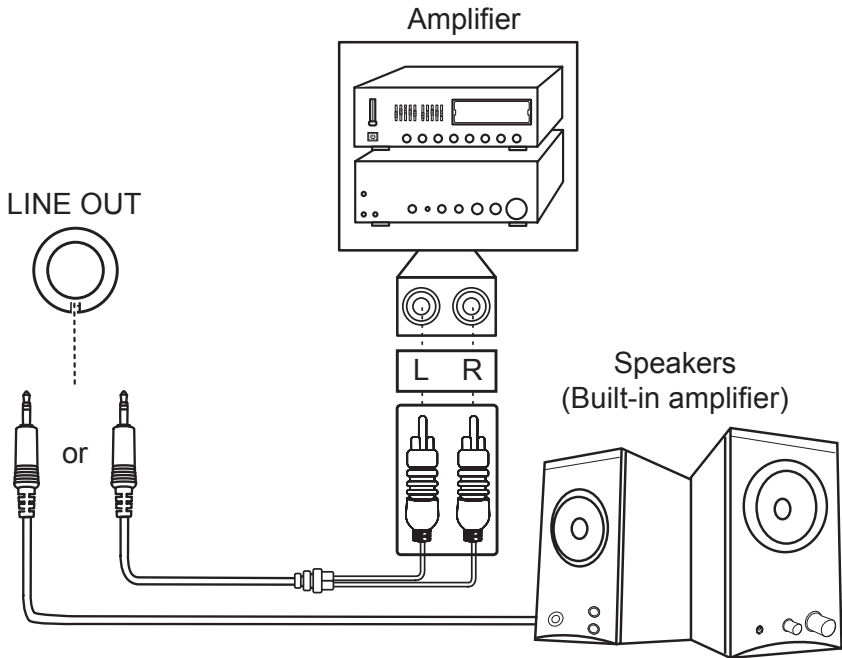

Connect an external amplifier or powered speakers to the line out port to provide better sound quality. Refer to the above illustration.

Note: Only one external device for sound can be connected at a time.

2.2.3 Connecting to AV Devices

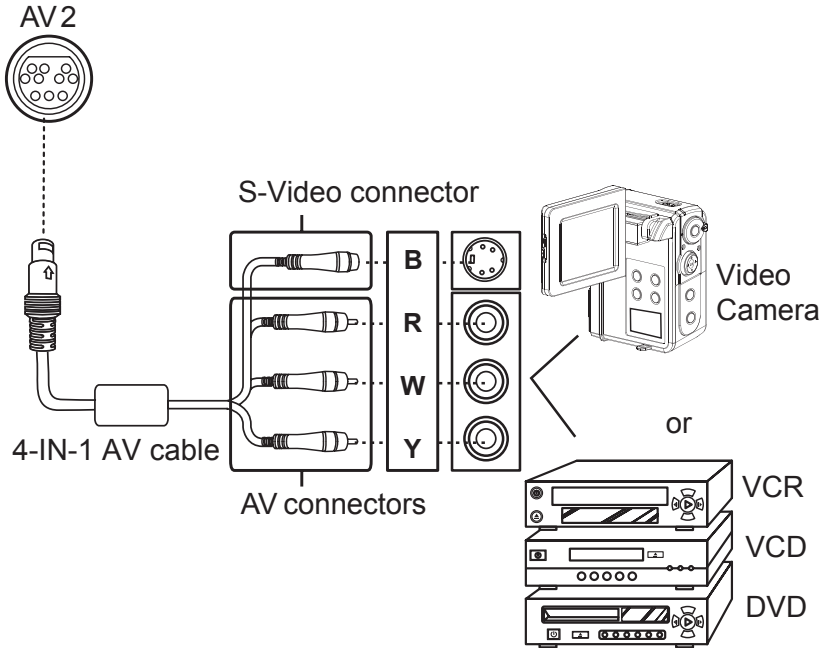

The above illustration shows you how to connect your TV to a video camera, VCR, VCD or DVD player. Actual connections may vary according to the make and model of your device. Refer to the user's manual included with the AV device for more detailed instructions.

- Note:**
- *When connecting the S-Video connector and AV connectors at the same time, the priority is given to the S-Video connector.*
 - *The cables are color-coded (black, red, white, and yellow). Connect each color-coded cable to the appropriate connector on your device.*

2.2.4 Connecting to a PC

For VGA Jack

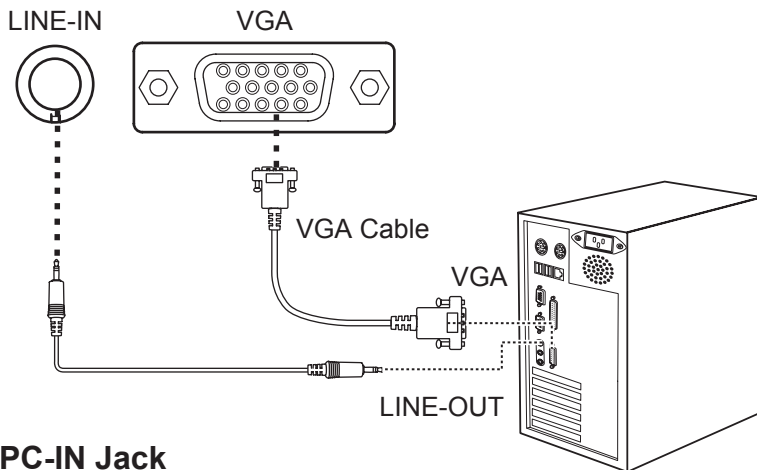

For PC-IN Jack

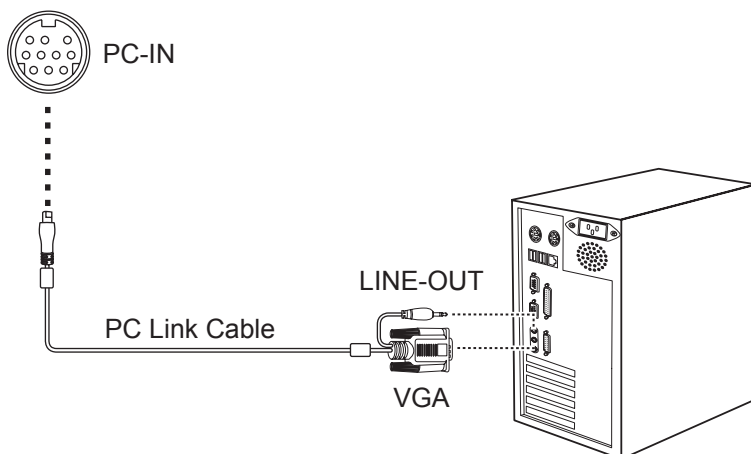

The above illustrations demonstrate how to connect to a PC. For VGA jack, please refer to the first picture. For PC-IN jack, please refer to the second picture.

2.2.5 Connecting to a Video Game Console

The instructions presented here are a general guide to connecting the TV to a game console using the RCA jacks (some game devices may require a unique adapter that is not provided.) Actual connections may vary according to the make and model of the game device. Refer to the user's manual included with the game console for more detailed instructions.

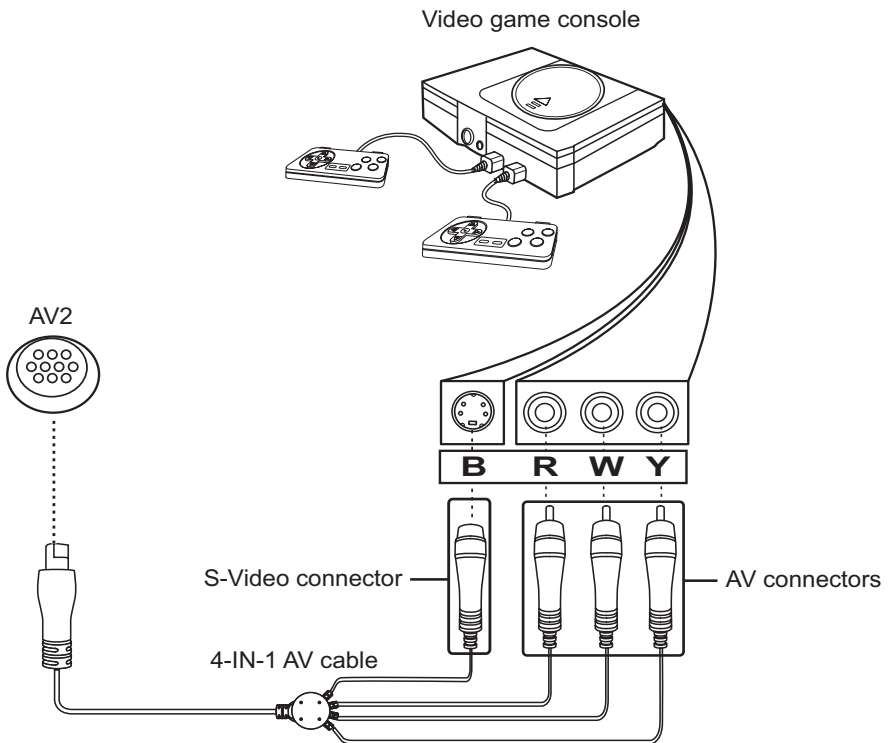

- Note:**
- Connect the 4-IN-1 AV cable connections to the corresponding connectors on your game console adapter.
 - If the 4-IN-1 AV cable does not fit the game device, then insert RCA adapters between the 4-IN-1 AV cable and game console (RCA adapters are not provided).

2.3 Basic Operations

2.3.1 Power on/off

Press the POWER button on the remote control or control panel to turn on the TV.

Press the POWER button again; the TV is in off mode.

2.3.2 Switching Source Signals

Press the SOURCE button to select different source signals. The selected source signal appears on the top right corner of the screen.

2.3.3 Selecting Channels

Press CH UP to increase the channel number by one.

Press CH DOWN to decrease the channel number by one.

Enter the specific channel number by pressing the number buttons on the remote control. The channel is displayed on the screen.

2.3.4 Adjusting the Volume

Press VOL UP to increase the volume.

Press VOL DOWN to decrease the volume.

2.3.5 Mute

Under certain circumstances, you might need a silent environment.

Press the MUTE button. The word "MUTE" appears on the top right corner of the screen and sound is turned off.

Press the MUTE button again to restore the original volume. Or you may press VOL UP or VOL DOWN to restore sound.

2.3.6 Using the Remote Control

Aim the transmitter on the remote control at the remote IR sensor of the TV and ensure that there is no obstacle between them. The operational distance may be shortened when the remote IR sensor is directly exposed to strong light.

For best results, use the remote control within a distance of 16 feet (5 meters) from the front of the TV. Do not exceed an angle of 30 degrees when pointing at the TV.

Menu Setting

This Chapter guides you through adjusting the On-Screen Display (OSD) menu system under TV and PC mode. You may adjust the setting from your remote control or the buttons located on the TV's front control panel.

TV & Remote Control button

Control Panel	Remote Control
-Menu -M	Menu/Enter
CH UP (△/▷/▲/+/^) CH DOWN (▽/◁/▼/-/v)	CH UP / Arrow (▲/+/ ▲/^) CH DOWN (▼/-/ ▼/v)
VOL UP (+ /▷/△/^) VOL DOWN (- /◁/△/ v)	VOL UP / Arrow (+ /▲/ ► /▷) VOL DOWN / Arrow (- /▼/ ◀ /<)

Note: Follow the instructions indicated on the bottom of the OSD Function menu. In the following example, press VOL UP or ► arrow key to enter your setting, CH UP or DOWN or ▲ / ▼ arrow key to navigate through item, or MENU to exit the OSD menu.



OSD Function Menu

Before going to details of each OSD item, you may get acquainted with the placement of the OSD system:

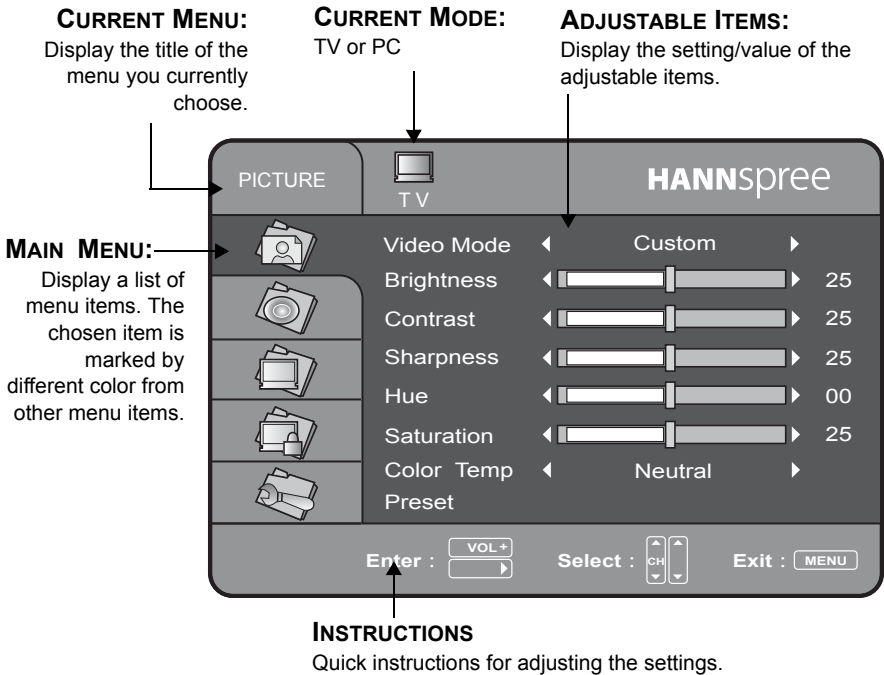

The following menus can be set by different adjustment methods. Adjustment methods are described after function description of each setting's menu.

3.1 TV mode

3.1.1 Picture Setting

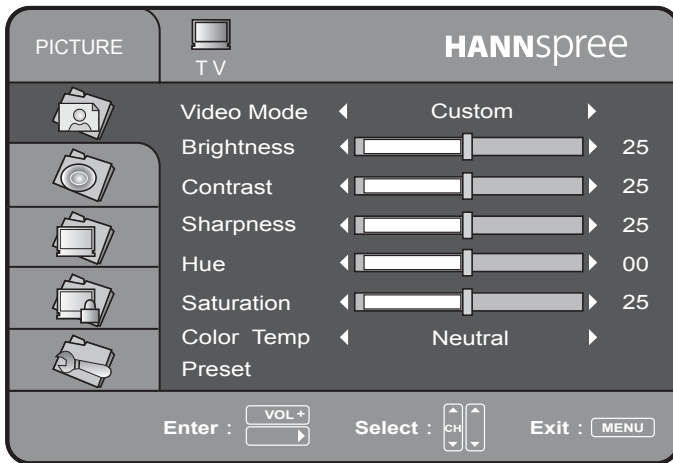

Function Description:

Video mode

The Video mode enables you to customize the video display. The following options are:
Standard: Set the display for normal viewing (default).

Vivid: Set the display for enhanced picture contrast and sharpness.

Movie: Set the display to emulate a movie display.

Custom: Enable you to set user defined values. Cycle through the desired mode among Standard, Vivid, Movie, and Custom.

Brightness	Brightness is the quality where a source appears to emit a given amount of light. The brightness ranges from 0 to 50. The default value is 25.
Contrast	Contrast is the difference in visual properties between the brightest and the darkest. The contrast ranges from 0 to 50. The default value is 25.
Sharpness	Sharpness is an image degree of clarity in terms of focus and contrast. The sharpness ranges from 0 to 50. The default value is 25.
Hue (NTSC system only)	The aspect of color that distinguished it from another color (what makes a color red, green, or blue). The hue ranges from -25 to 25. The default value is 0. This function is available under NTSC mode but not PAL system.
Saturation	Saturation is the vividness or purity of a colour; the less gray a colour contains, the more saturated it is. The saturation ranges from 0 to 50. The default value is 25.
Color Temp	The temperature (measured in degrees Kelvin) to which an object would have to be heated before it would radiate a given colour. Each type of light can also be represented by a numerical colour temperature. Cycle through the desired Color Temp mode among Cold, Neutral, and Warm.
Preset	Restore the settings to the default value.

Adjustment (Picture setting)

- 1 Press Menu key to display the OSD Main Menu.
- 2 Go to Picture setting by pressing CH UP or CH DOWN and confirm by pressing VOL UP.

For Video Mode and Color Temp

- 3 Go to (Video Mode or Color Temp) by pressing CH UP or CH DOWN.
- 4 Press VOL DOWN or VOL UP to navigate through available options.
- 5 Press Menu key to confirm and return to Main Menu.

For Brightness, Contrast, Sharpness, Hue and Saturation:

- 3 Go to (Brightness, Contrast, Sharpness, Hue or Saturation) by pressing CH UP or CH DOWN.
- 4 Press VOL UP or VOL DOWN to change the value.
- 5 Press Menu key to confirm and return to Main Menu.

For Preset:

- 3 Go to Preset by pressing CH UP and CH DOWN.
- 4 Press VOL UP or VOL DOWN to execute Preset function.
- 5 Press Menu key to return to Main Menu.

3.1.2 Audio Setting

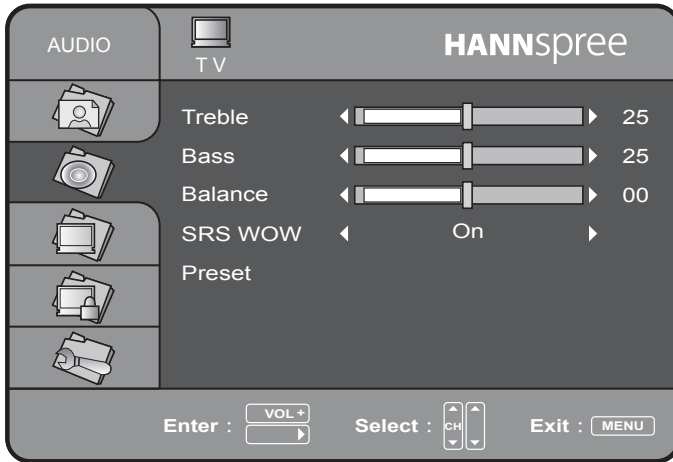

Function Description:

Treble	Treble allows you to adjust high sound tones. The treble ranges from 0 to 50. The default value is 25.
Bass	Bass allows you to adjust low sound tones. The bass ranges from 0 to 50. The default value is 25.
Balance	Balance is the sound level adjustment between right and left speaker. The balance ranges from -25 to 25. The default value is 0.

SRS WOW	SRS WOW is a surround sound technology. You may switch to turn on/off the feature. The default setting is set to Off.
Preset	Restore the settings to the default value.

Adjustment (Audio setting)

- 1 Press Menu key to display the OSD Main Menu.
- 2 Go to Audio setting by pressing CH UP or CH DOWN and confirm by pressing VOL UP.

For Treble, Bass, and Balance

- 3 Go to (Treble, Bass or Balance) by pressing CH UP or CH DOWN.
- 4 Press VOL UP or VOL DOWN to change the value.
- 5 Press Menu key to confirm and return to Main Menu.

For SRS WOW

- 3 Go to SRS WOW by pressing CH UP or CH DOWN.
- 4 Press VOL DOWN or VOL UP to navigate through On and Off.
- 5 Press Menu key to confirm and return to Main Menu.

For Preset:

- 3 Go to Preset by pressing CH UP and CH DOWN.
- 4 Press VOL UP or VOL DOWN to execute Preset function.
- 5 Press Menu key to return to Main Menu.

3.1.3 TV Setting

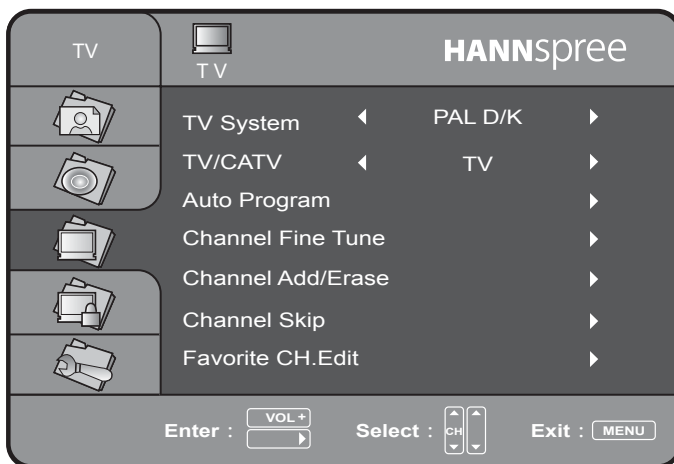

Function Description:

TV system	TV system allows you to select the one available system in your region. Cycle through NTSC M, PAL B/G, PAL I, and PAL D/K.
TV/CATV (NTSC system only)	Select TV or cable TV channels. Cycle through TV and CATV. This feature is for NTSC only.
Auto Program	Auto program allows you to search programs automatically.
Channel Fine Tune (PAL system only)	Adjust fine tune frequency. This feature is for PAL only.

Channel Add/Erase (NTSC system only)	Add or erase TV channels. This feature is for NTSC only.
Channel Skip (PAL system only)	Channel Skip allows you to skip certain channels. Turn on/off Channel Skip feature. This is for PAL only.
Favorite CH. Edit	Set your arrow keys with four of your favorite programs so that you can quickly access them by pressing arrow keys.

Adjustment (TV setting)

- 1 Press Menu key to display the OSD Main Menu.
- 2 Go to TV setting by pressing CH UP or CH DOWN and confirm by pressing VOL UP.

For TV System, TV/CATV

- 3 Go to (TV System or TV/CATV) by pressing CH UP or CH DOWN.
- 4 Press VOL DOWN or VOL UP to navigate through available options.
- 5 Press Menu key to confirm and return to Main Menu.

For Auto Program

- 3 Go to (Auto Program) by pressing CH UP or CH DOWN and press VOL UP to start automatic search. The screen displays adjustment boxes as below:



- 4 It stops when the channels are located.

For Channel Skip

- 3 Go to Channel Skip by pressing CH UP or CH DOWN and confirm by pressing VOL UP. The screen displays the following adjustment box:

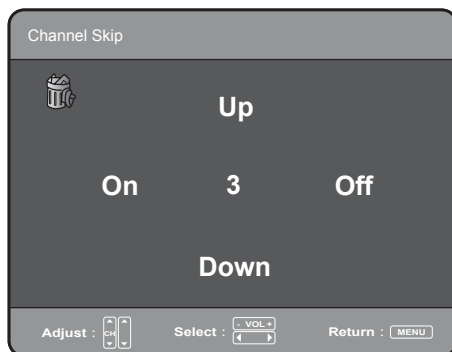

- 4 Press CH UP or DOWN to select a channel to be skipped.
- 5 Press VOL UP or VOL DOWN to turn on/off the function.
- 6 Press MENU key to confirm and return to Main menu.

For Channel Fine Tune

- 3 Go to Channel Fine Tune and press VOL UP to confirm. The screen displays the following adjustment box:

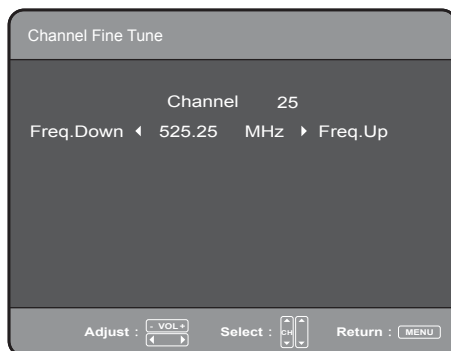

- 4 Press CH UP or DOWN to select a channel to be fine tuned.
- 5 Press VOL UP or VOL DOWN to adjust frequency.

-
- 6 Press MENU key to confirm and return to Main menu.

For Channel Add/Erase

- 3 Go to Channel Add/Erase and press VOL UP to confirm. The screen displays the following adjustment box:

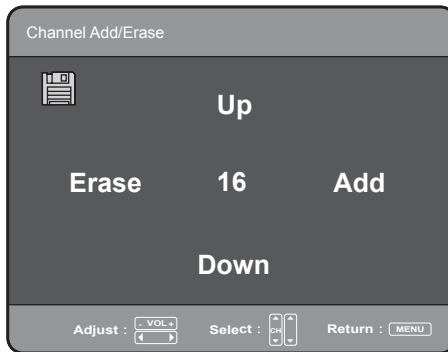

- 4 Press CH UP or CH DOWN to select a channel. Press VOL UP or VOL DOWN to add or erase channels.
- 5 Press MENU key to confirm and return to Main menu.

For Favorite CH. Edit

- 3 Go to Favorite CH. Edit and press VOL UP to confirm. The screen displays the following adjustment box:



-
- 4 Press CH UP or CH DOWN to select the favorite channel to be edited (Favorite 1 to Favorite 4).
 - 5 Press VOL UP once to set the currently viewed channel as your favorite channel or press VOL UP or VOL DOWN again to select a channel other than the currently viewed channel.
 - 6 Then press CH UP or DOWN to edit other favorite channels.
 - 7 Press MENU key to confirm the setting and return to Main menu.

3.1.4 Parental Control Setting (available in U.S. only)

The Parental Control Function is used to block program viewing based on the ratings sent by the broadcast stations in the United States of America. It is contingent upon the availability of the TV network programming. There are two rating systems for viewing contents: TV Parental Guidelines and movie ratings.

The TV Parental Guidelines help parents screen out inappropriate television programs for their children. Movie ratings are used for original movies rated by the Motion Picture Association of America (MPAA) as watched on cable TV and not edited for television. The Parental Control Function can also be set to block MPAA-rated movies.

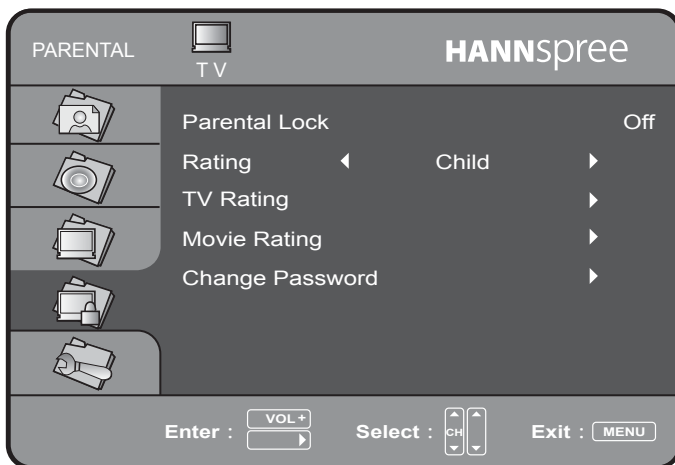

Be sure to enter the default password 0000 to go into this manu.

Input Password

Function Description:

Parental Lock	The feature allows parents to lock certain programs that are unappropriate for children. Select to turn on or off.
Rating	Programs are sorted according to different ratings you set. Cycle through the following settings: Child, Custom, Youth, and Youth Adult.
TV Rating	TV Rating displays a chart of TV Rating. Choose to either lock or unlock the item that you desired.
Movie Rating	Movie Rating displays a chart of MPAA Rating. Choose to either lock or unlock the item that you desired.
Change Password	Select to change your password. Enter your old password first, and then new password. Note that the system asks you to confirm your new password again. The default password is 0000. If you forget your password, refer to page 55 4.2 Troubleshooting.

- Note:**
- *Once you enter Parental Control menu, the system asks you to specify your password before you change any setting.*
 - *You can only use the remote control to enter or change the password.*
 - *If the wrong password is entered, "Wrong Password" displays on the screen.*
 - *TV Rating and Movie Rating are available when the Rating is set to Custom.*

Adjustment (Parental control setting)

- 1 Press Menu key to display the OSD Main Menu.
- 2 Go to Parental control setting by pressing CH UP or CH DOWN and confirm by pressing VOL UP, then enter the password.

For Parental Lock and Rating

- 3 Go to (Parental Lock or Rating) by pressing CH UP or CH DOWN and confirm by pressing VOL UP.
- 4 Press VOL DOWN or VOL UP to navigate through available options.
- 5 Press Menu key to confirm and return to Main Menu.

Note: • *Selecting Custom under Rating menu allows you to adjust the following items including TV Rating, Movie Rating.*

For TV Rating

- 3 Go to TV rating by pressing CH UP or CH DOWN and VOL UP to confirm. A box pops out:

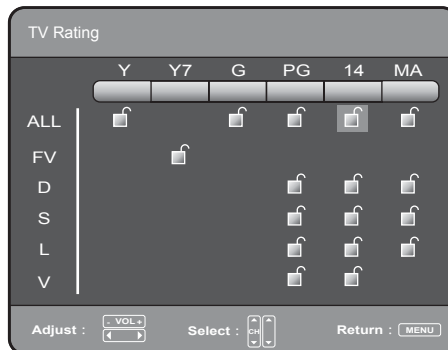

- 4 Press CH UP to move the cursor down to up or right to left, or press CH DOWN to move the cursor up to down or left to right.
- 5 Press VOL UP or VOL DOWN to lock or unlock the highlighted item .
- 6 Press Menu key to return to Main Menu.

For Movie Rating

- 3 Go to Movie Rating by pressing CH UP or CH DOWN and VOL UP to confirm. A box pops out:

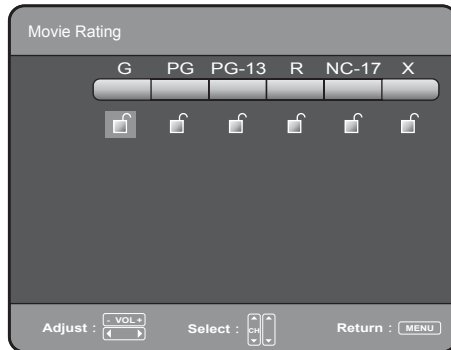

- 4 Press CH UP or CH DOWN to move the cursor.
- 5 Press VOL UP or VOL DOWN to lock or unlock the highlighted item .
- 6 Press Menu key to return to Main Menu.

For Change Password

- 3 Go to Change Password by pressing CH UP or CH DOWN key and VOL UP to confirm. A box pops out:

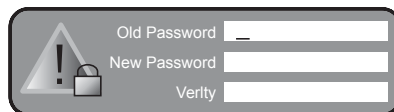

- 4 Enter your old password with your remote control. You can enter for digits 0-9. If the password is mistaken,try it again. If the password is correct, go to New Password.
- 5 Enter your new password.
- 6 Verify your new password.

Ratings

MPAA Ratings	MPAA Ratings allow you to block or unblock broadcast programs based on their movie ratings.
G	Suitable for a general audience, all children
PG	Parental guidance suggested
PG-13	Parental guidance for children under 13 suggested
R	Restricted viewing. Parental guidance suggested for children under 17
NC-17	No one under 17 is allowed to view
X	Adults only

TV Ratings (Age based)	The TV rating menu allows you to block or unblock broadcast programs based on their TV rating.
TV-Y	Suitable for a general audience, all children
TV-Y7	Directed at children aged 7 and older
TV-G	General audience
TV-PG	Parental guidance suggested
TV-14	Parents strongly cautioned
TV-MA	Mature audience only
Content based	
FV	Fantasy violence
D	Suggestive dialogue
L	Strong language
S	Sexual situations
V	Violence

Note: • *More information about the rating system can be found by visiting these websites: <http://www.mpa.org>, <http://www.tvguidelines.org>*

3.1.5 Customize Setting

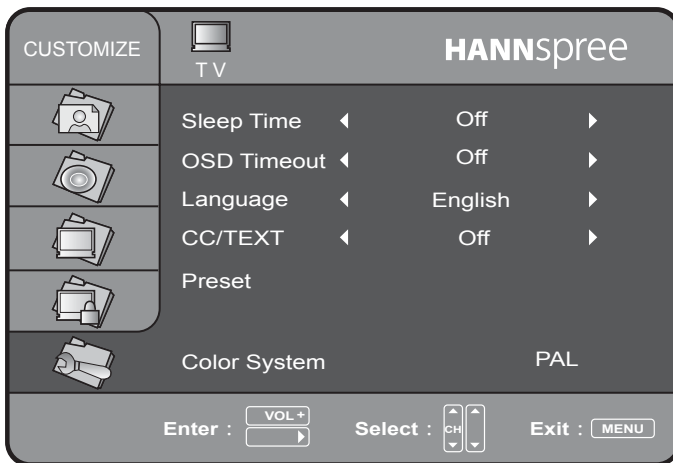

Function Description:

Sleep Time	Sleep time allows the TV to be turned off automatically after a certain period of time. Cycle to the desired sleep time: 30min., 60 min., 90min., 120min., or off.
OSD Timeout	Set the duration before the OSD disappears from the screen. Cycle to the desired period for OSD Timeout: 20sec., 40sec., 60sec., or off
Language	Available languages for the TV. Cycle to the desired language among English, Traditional Chinese, Simplified Chinese and Spanish.

CC / TEXT (U.S. only)	C.C Text is the enclosed captioning text included with TV programs as they air. Cycle to the desired mode: Off, CC1-CC4, TEXT1-TEXT4, and XDS.
Preset	Restore the settings to the default value.

Note: *The Color System is indicated on the bottom part of the screen.*

Adjustment (Customize setting)

- 1 Press Menu key to display the OSD Main Menu.
- 2 Go to Customize setting by pressing CH UP or CH DOWN and confirm by pressing VOL UP.

For Sleep Time, OSD Timeout, Language and CC/TEXT:

- 3 Go to (Sleep Time, OSD Timeout, Language, or CC/TEXT) by pressing CH UP or CH DOWN.
- 4 Press VOL DOWN or VOL UP to navigate through available options.
- 5 Press Menu key to confirm and return to Main Menu.

For Preset

- 3 Go to Preset by pressing CH UP and CH DOWN.
- 4 Press VOL UP or VOL DOWN to execute Preset function.
- 5 Press Menu key to return to Main Menu.

3.2 PC Mode

3.2.1 Picture Setting

The setting provides four options: Brightness, Contrast, Color Temp and Preset. Please refer to 3.1.1 for detailed description.

Note: *Make sure the TV's power cord is plugged in before turning on the PC.*

3.2.2 Audio Setting

The Audio setting provides four options: Treble, Bass, Balance, and Preset. Please refer to 3.1.2 for detailed description.

3.2.3 Image Setting

The Image setting provides five options: H. Position, V. Position, Phase, Clock, and DOS Mode.

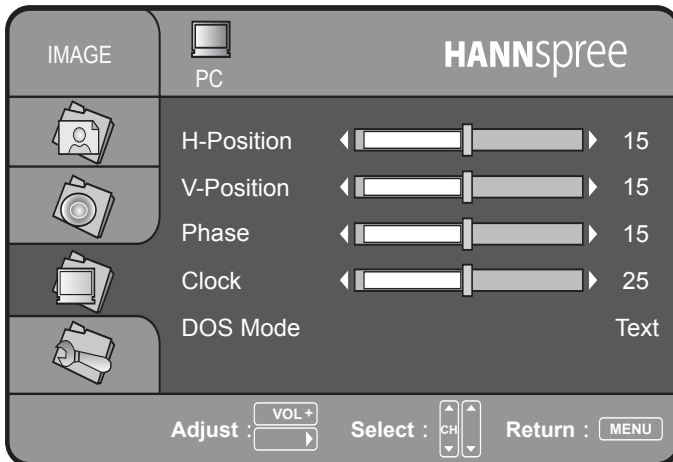

Function Description:

H. Position	The option allows users to adjust the horizontal position of the screen. The H position ranges from 0~31. The default value is 15.
V. Position	The option allows users to adjust the vertical position of the screen. The V position ranges from 0~31. The default value is 15.
Phase	A measure of how well two waves are aligned. "In phase" means the crests align perfectly and add together. The Phase ranges from 0-31. The default value is 15.
Clock	The computer is measured by electronic circuits in an internal timing device. It stands for the signal clock rate generated from the PC graphic card. This item allows users to fine tune the clock rate to match the PC source perfectly for reducing the vertical band noise. The Clock ranges from 0-50. The default value is 25.
DOS Mode	Select the mode from Text / Graphic. Dedicated for DOS screen. Two Text/Graphic moves available.

Adjustment (Image setting)

- 1 Press Menu key to display the OSD Main Menu.
- 2 Go to Image setting by pressing CH UP or CH DOWN and confirm by pressing VOL UP.

For H. Position, V. Position, Phase, and Clock

- 3 Go to (H. Position, V. Position, Phase, or Clock) setting by pressing CH UP or CH DOWN and VOL UP to confirm.
- 4 Press VOL UP or VOL DOWN to change the value.
- 5 Press Menu key to confirm and return to Main Menu.

For DOS Mode

- 6 Go to DOS Mode by pressing CH UP or CH DOWN and confirm by pressing VOL UP.
- 7 Press VOL DOWN or VOL UP to navigate through Text and Graphic.
- 8 Press Menu key to confirm and return to Main Menu.

3.2.4 Customize Setting

The Customize setting provides four options: Sleep time, OSD Timeout, Language, and Preset. Please refer to 3.1.5 for detailed description. Below the screen displays the monitor's Resolution. Please be noted that Phase and Clock have to be adjusted manually even though the Preset function is executed.

4.1 Maintenance

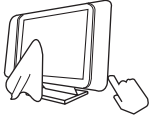

Turn the power off before you begin cleaning the TV.



For best results, use a clean lens cloth to remove dust and fingerprints from the screen.



Do not wipe the shell of the TV with alcohol, methanol, gasoline or oil products to avoid damaging the finish. Wipe the shell with a dry soft cloth and use neutral cleaning fluids.

If your model has leather components, wipe the leather parts with a dry cloth and keep the area dry. Place the TV far from sources of steam to avoid making the leather wet.

Be careful to disconnect the power plug correctly. Hold the plug. Do not attempt to disconnect the plug by pulling on the power cord.

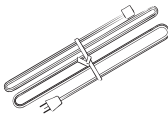

Arrange and store the power cord neatly as shown to the left to avoid knotting or bending which may cause fire due to damage or electric leakage.

-
- | | |
|--------------|--|
| Note: | <ul style="list-style-type: none">• <i>Do not place the remote control in hot or humid locations. Protect the remote control from shock or vibration to avoid damages.</i>• <i>Check the remote control batteries on a regular basis. Clean any stain on the rear battery cover immediately and use new batteries if fluid is leaking from old batteries.</i> |
|--------------|--|

4.2 Troubleshooting

- | | |
|-----------------------|---|
| No picture and sound. | <ul style="list-style-type: none">• Connect the power cord properly.• Press the POWER key on the control panel or remote control.• Press the SOURCE key to cycle through connected video sources.• Press CH UP or CH DOWN to switch to other TV stations.• Check the TV/CATV OSD settings.• Make sure all cables are connected properly.• Make sure the video signal cable is connected properly. |
|-----------------------|---|
-

- | | |
|---|--|
| No picture, or poor picture, but sound is OK. | <ul style="list-style-type: none">• Check the antenna and cable connections.• Adjust the brightness in the OSD menus. |
|---|--|
-

- | | |
|--------------------------|--|
| Picture is not in color. | <ul style="list-style-type: none">• Adjust the saturation in the OSD menus.• Make sure all cables are connected properly. |
|--------------------------|--|
-

Picture is OK, but no sound.	<ul style="list-style-type: none"> • Press the VOL UP or VOL DOWN key on the control panel or the remote control. • Make sure the MTS option is set to MAIN or MONO. • Make sure the source device is functioning properly. • Set the volume to a higher level. • Make sure the audio cable is connected securely. • Turn the mute off.
One of the speakers has no sound.	<ul style="list-style-type: none"> • Adjust the balance in the OSD menus. • Make sure the audio cable is connected properly.
Cannot receive some TV channels when using cable TV.	<ul style="list-style-type: none"> • Try the Auto Program function in the OSD TV Setting menu.
Want to reset TV settings	<ul style="list-style-type: none"> • Use the Preset function in the OSD Picture and Audio menu.
Cannot operate menus.	<ul style="list-style-type: none"> • If OSD items are colored light blue, the system is in a state such that those settings are not available. For example, video setting is available in TV mode.
Screen image turns over.	<ul style="list-style-type: none"> • Make sure the video signal cable is connected properly.
Snow appears on the screen.	<ul style="list-style-type: none"> • Adjust the location of the antenna, placing it far from roads or sources of interference. • Check the antenna and the video signal line connections.

Blurred or overlapped images.	<ul style="list-style-type: none"> • Readjust the sharpness setting. • Choose programs with high quality signals. • Adjust the direction of the antenna or change the video signal cable.
Forgot parental control password.	<ul style="list-style-type: none"> • Use the master password 0928.
Remote control does not work.	<ul style="list-style-type: none"> • Make sure the battery/batteries is/are inserted correctly. • Replace the batteries with new ones. • Make sure the TV power cord is plugged in. • Make sure the path between the remote control and the remote IR sensor is clear. • Try operate the remote control at a closer distance to the TV. Refer to 2.3.1 on page 30.
In PC mode, horizontal band noise appears.	<ul style="list-style-type: none"> • To adjust the value of Phase in Image setting of OSD menu. • Refer to 3.2.3 on page 54.
In PC mode, vertical band noise appears.	<ul style="list-style-type: none"> • To adjust the value of Clock in Image setting of OSD menu. • Refer to 3.2.3 on page 54.

4.3 Specifications

LCD Panel Size	15-inch TFT
Aspect Ratio	4:3
Display Resolution	1024 (horizontal) x 768 (vertical)
Maximum Display Area	304.1 mm (H) x 228.1 mm (V)
TV System	NTSC M, PAL B/G, PAL I, PAL D/K
Video System	AV1: Composite Video (RCA jacks) AV2: 4-IN-1 A/V Cable (Composite + S-Video)
Audio System	AV1: L/R RCA jacks AV2: 4-IN-1 A/V cable L/R RCA jacks 3.5 mm earphone port (audio output)
Built-in Stereo Audio Amplifier	2W+2W/ 3W+3W
Power Supply	220V, 50 Hz, 12V DC
Power Consumption	60W (Max.)

4.4 PC Mode Support Timing

	Pixel Format	Hor. Freq. (kHz)	H. Polarity	V. Freq. (Hz)	V. Polarity	Standard
1	640*400	31.47	-	70	+	DOS Graphic
2	720*400	31.47	-	70	+	DOS Text
3	640*480	31.47	-	60	-	VESA
4	640*480	37.861	-	72	-	VESA
5	640*480	37.5	-	75	-	VESA
6	800*600	35.156	+	56	+	VESA
7	800*600	37.879	+	60	+	VESA
8	800*600	48.077	+	72	+	VESA
9	800*600	46.875	+	75	+	VESA
10	1024*768	48.363	-	60	-	VESA
11	1024*768	56.476	-	70	-	VESA
12	1024*768	60.023	+	75	+	VESA
13	832*624	49.7	-	75	-	MAC
14	1024*768	60.2	-	75	-	MAC
15	640*480	35	-	67	-	MAC

Warranty and Service

For complete warranty service information, please refer to the “Warranty and Service Manual” enclosed with your TV.

Aspect Ratio: The ratio of width of a film, image or display screen.

Broadcast TV: Broadcasting video signals using high-frequency electromagnetic waves to distribute television channels to viewers (standard TV broadcast).

CATV: Community Antenna Television, the original name for cable TV. A television distribution system that uses coaxial cable instead of the traditional radio broadcasting (over-the-air) method to deliver television, FM radio and other services to consumers.

Color Temperature: Adjusting the color temperature enables you to set the intensity of white light. Color temperature is measured in Kelvin (K). Higher color temperature results in a blue tint. Lower temperature results in a red tint.

Hue: Colors in a color system are measured by hue, saturation and luminance. Hue indicates the predominant color.

LCD (Liquid Crystal Display): A display technology that uses rod-shaped molecules (liquid crystals) that flow like liquid and bend light.

MAIN: It is the default audio signal belonging to a particular channel.

MTS(NTSC system only): Multi-channel Television Sound. Enables reception of audio other than primary (MAIN) audio signal. SAP (Second Audio Program) enables reception of a separate channel that may be a different language or completely different information such as the news.

Saturation: Chromatic purity indicating the amount of white contained in a color. Fully saturated colors are pure colors; less saturated colors appear as pastel shades.

S-Video: Super-video, a video cabling standard used to transmit video by keeping brightness (Y) and color information on separate channels. Most often used with camcorders, VCRs, and quality receivers and amplifiers to provide sharper pictures.

OSD: On-Screen Display. A control panel on the television screen that allows you to select viewing options.



is a trademark of SRS Labs, Inc.
WOW technology is incorporated
under license from SRS Labs, Inc.

Free Manuals Download Website

<http://myh66.com>

<http://usermanuals.us>

<http://www.somanuals.com>

<http://www.4manuals.cc>

<http://www.manual-lib.com>

<http://www.404manual.com>

<http://www.luxmanual.com>

<http://aubethermostatmanual.com>

Golf course search by state

<http://golfingnear.com>

Email search by domain

<http://emailbydomain.com>

Auto manuals search

<http://auto.somanuals.com>

TV manuals search

<http://tv.somanuals.com>