

HANNSPREE



26"/32"/37"

Liquid Crystal Display
Television

MAK-000050

User's Manual

HANNSPREE, INC.
www.hannspree.com

Table of Contents

Regulatory Information	3
Description of Warning Symbols	5
Safety Notices.....	6
Preface	11
1. Getting Started	14
1.1 Package Contents	14
1.2 Introducing the TV	15
1.2.1 Features	15
1.2.2 Control Panel	16
1.2.3 Input and Output Jacks	17
1.2.4 Remote Control.....	19
1.2.5 Inserting the Remote Control Batteries	23
2. Setting up your TV	25
2.1 Basic Connections	25
2.1.1 Connecting the Power Cord and Turning On	25
2.1.2 Connecting an Antenna or Cable TV	26
2.2 Connecting External Devices	27
2.2.1 Connecting External Earphones.....	27
2.2.2 Connecting an Amplifier Using Analog Audio	28
2.2.3 Connecting an Amplifier Using Digital Audio	29
2.2.4 Connecting a VCR/STB/DVD Player Using Component Video	30
2.2.5 Connecting a VCR/STB/DVD Player Using S-Video	31
2.2.6 Connecting a VCR/STB/DVD Player Using Composite Video	32
2.2.7 Connecting a Video Game Console.....	33
2.2.8 Connecting a PC.....	34
2.2.9 Connecting HDMI.....	35
2.2.10 Connecting Digital TV	36

Table of Contents

2.3	Inserting a Memory Card	37
2.4	Using the TV	39
2.4.1	Using the Remote Control	39
2.4.2	Turning the TV On and Off	39
2.4.3	Selecting Channels	39
2.4.4	Switching Source Signals	40
2.4.5	Adjusting the Volume	41
2.5	Using the E-CARD Function (For built-in E-CARD only)	42
2.5.1	Remote Control Keys in E-CARD Mode	44
2.5.2	Viewing Photos	46
2.5.3	Listening to Music	51
2.5.4	Watching Videos	53
2.5.5	Viewing Memory Card Files	54
2.6	Using the Digital TV (For built-in DTV only)	55
2.6.1	Switching Signal Source	55
2.6.2	Searching for Digital Channels	57
2.6.3	Digital Customize Settings	62
2.6.4	Using the Electronic Program Guide (EPG) ...	65
3.	Adjusting On-Screen Display (OSD) Settings	70
3.1	OSD Setting Menus	70
3.2	Adjusting Video Settings	72
3.3	Adjusting Audio Settings	75
3.4	Adjusting PC Settings	77
3.5	Adjusting TV Settings	79
3.6	Making Customize Settings	81
3.7	Setting Parental Controls (Available in the US and Canada only)	83
4.	Troubleshooting	91
5.	Warranty and Service	93
6.	Specifications	94
6.1	PC Mode Support Timing	95
7.	Glossary	96

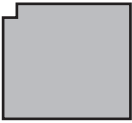

Regulatory Information

FCC Compliance Statement¹

This device complies with part 15 of the FCC Rules. Operation is subject to the following two conditions: (1) This device may not cause harmful interference, and (2) this device must accept any interference received, including interference that may cause undesired operation.

Additional Information

This equipment has been tested and found to comply with the limits for a Class B digital device, pursuant to part 15 of the FCC Rules. These limits are designed to provide reasonable protection against harmful interference in a residential installation. This equipment generates, uses and can radiate radio frequency energy and, if not installed and used in accordance with the instructions, may cause harmful interference to radio communications. However, there is no guarantee that interference will not occur in a particular installation. If this equipment does cause harmful interference to radio or television reception, which can be determined by turning the equipment off and on, the user is encouraged to try to correct the interference by one or more of the following measures:

- Reorient or relocate the receiving antenna
- Increase the separation between the equipment and receiver
- Connect the equipment into an outlet on a circuit different from that to which the receiver is connected
- Consult the dealer or an experienced radio/TV technician for help

Warning: The Federal Communications Commission warns that changes or modifications of the TV not expressly approved by the party responsible for compliance could void your authority to operate the equipment.

1. applies only to products purchased in the United States of America

DOC Compliance Notice¹

This digital apparatus does not exceed the Class B limits for radio noise emissions from digital apparatus as set out in the Radio Interference Regulations of the Canadian Department of Communications. This device complies with Canada ICES-003 Class B.

CE Conformity Statement²

This device complies with the requirements set out in the Council Directive on the approximation of the laws of the Member States relating to Electromagnetic Compatibility (89/336/EEC) and the Amendment Directive (92/31/EEC), Low-Voltage Directive (73/23/EEC) and the Amendment Directive (93/68/EEC).

-
1. applies only to products purchased in Canada
 2. applies only to products purchased in the European Union

Description of Warning Symbols



Before You Proceed

1. Read all Safety Notices and instructions in this User's Manual carefully before either plugging in or turning the TV on.
2. Keep this User's Manual in a safe place for future reference. Keep the box and packaging in case the TV needs to be shipped in the future.
3. Follow the TV and warning label instructions.
4. Any uses, operations, changes, alterations or modifications of the TV that do not follow the instructions in this manual will void this TV's warranty.



CAUTION

RISK OF ELECTRIC SHOCK
DO NOT OPEN



WARNING



This symbol is used to alert users to pay attention to important descriptions regarding usage, maintenance (repair), and additional important information related to this TV.

CAUTION



This symbol is used to alert users to the risk of electric shocks due to dangerous and uninsulated components.



Installation Safety Notes

Antenna

We suggest that you use an outdoor antenna to get the best signal possible unless you have cable TV or a centralized indoor antenna system. You may, however, use an antenna indoors if it is placed in a location free from interference.

Location

Avoid allowing the TV to get prolonged exposure to sunlight or other strong sources of heat. Leave sufficient distance between the TV and the wall to provide enough space for the emission of heat.



WARNING

To reduce the risk of fire or electric shock, do not expose this apparatus to rain or moisture.

Apparatus shall not be exposed to dripping or splashing and no objects filled with liquids, such as vases, shall be placed on the apparatus.



Power

The packaged power cord is used for 110V power source. To reduce the risk of fire, do not plug the power cord into an outlet with voltage over 110V.

IMPORTANT SAFETY INSTRUCTIONS



- 1 Read these instructions.
 - 2 Keep these instructions.
 - 3 Heed all warnings.
 - 4 Follow all instructions.
-



- 5 Do not use this apparatus near water.
-



- 6 Clean only with dry cloth.
-



- 7 Do not block any ventilation openings. Install in accordance with manufacturer's instructions.
-



- 8 Do not install near any heat sources such as radiators, heat registers, stoves, or other apparatus (including amplifiers) that produce heat.
-

-
- 9 Do not defeat the safety purpose of the polarized or grounding-type plug. A polarized plug has two blades with one wider than the other. A grounding-type plug has two blades and a third grounding prong. The wide blade or the third prong are provided for your safety. If the provided plug does not fit into your outlet, consult an electrician for replacement of the obsolete outlet.

NOTE: Applies to US only.

-
- 10 Protect the power cord from being walked on or pinched, particularly at plugs, convenience receptacles, and the point where they exit from the apparatus.



-
- 11 Only use attachments/accessories specified by the manufacturer.



-
- 12 Use only with the cart, stand, tripod, bracket, or table specified by the manufacturer, or sold with the apparatus. When a cart is used, use caution when moving the cart/apparatus combination to avoid injury from tip-over.

-
- 13 Unplug this apparatus during lightning storms or when unused for long periods of time.
-



- 14 Refer all servicing to qualified service personnel. Servicing is required when the apparatus has been damaged in any way, such as power-supply cord or plug is damaged, liquid has been spilled or objects have fallen into the apparatus, the apparatus has been exposed to rain or moisture, does not operate normally, or has been dropped.

CAUTION



These servicing instructions are for use by qualified service personnel only. To reduce the risk of electric shock, do not perform any servicing other than that contained in the operating instructions unless you are qualified to do so.

Notes:

- The LCD TV is for entertainment use only and visual display tasks are excluded.
- This device uses a VGA connector to connect to a PC. To reduce the influence of mains frequency on the source signal, use a VGA monitor cable with ferrite shield.

Personal Safety

1. To avoid overloading the power supply, never plug too many electrical devices into an outlet, power strip, or extension cable.
 2. Dangerous high-voltage electric power components are located inside the TV. To avoid electric shock, do not disassemble the casing.
 3. Do not place or drop metals, small objects, or flammable materials in the vent of the TV.
 4. If the TV is dropped, falls down, or is otherwise damaged, unplug the power cord immediately and contact an authorized service technician.
 5. If any fluid is sprayed or dropped into the TV, contact an authorized service technician.
 6. The screen of the TV is made of glass. Avoid hitting or scraping it. If the screen is broken, do not touch the broken glass.
 7. Do not allow children to use the TV unattended.
 8. Be careful when disconnecting the power plug. Hold the plug. Do not attempt to disconnect the plug by pulling on the power cord.
-

Installation

1. Do not place the TV in locations where there is excessive steam or dust.
 2. Avoid blocking the TV's vents, do not place the TV on a bed, sofa, carpet, or in a sealed cabinet.
 3. Install the outdoor antenna away from power transmission lines to avoid possible danger.
-



Preface

Thank you for purchasing a Hannspree Liquid Crystal Display Television (LCD TV). Your new TV will allow you to enjoy superior audio and video while enriching your lifestyle with advanced technology.

Please carefully read this manual in its entirety before setting up, using or operating your TV. To ensure the safe and correct installation and operations of the TV, it is important that the safety and operation instructions in this manual are followed.

This instruction manual is designed to assist you in setting up and using the TV. The information in this manual has been carefully checked for accuracy; however, no guarantee is given to the correctness of the contents. The information in this manual is subject to change without notice.

To the extent allowed by applicable law, Hannspree Inc. (“Hannspree”) shall not be liable for direct, indirect, special, exemplary, incidental or consequential damages arising from any defect or omission in this manual, even if advised of the possibility of such damages in advance.

Copyright

© Copyright 2005 Hannspree, Inc.

All rights reserved. This manual is protected by copyright and distributed under licenses restricting its use, copying and distribution. No part of this manual may be reproduced in any form by any means without the prior written authorization of Hannspree. The TV described in this manual may include copyrighted software of Hannspree (or other third parties). Hannspree (or other third parties) preserves the exclusive rights for copyrighted software, such as the right to distribute or reproduce the copyrighted software. Accordingly, and to the extent allowed by applicable law, any copyrighted software contained in the product described herein shall not be distributed, modified, reverse engineered, or reproduced in any manner without the prior written authorization of Hannspree (or of other third parties).

The Hannspree logos presented herein are trademarks of Hannspree. All other product names, trademarks or logos mentioned herein are used for identification purpose only, and may be the trademarks or registered trademarks of their respective owners.

The purchase of the product described herein shall not be deemed to grant, either directly or by implication, estoppel or otherwise, any license under the copyrights, patents, patent applications or trademarks of Hannspree, except for the normal, non-exclusive use that arises by operation of law in the sale of a product.

BBE, SRS, HDMI License Statements



Manufactured under license from BBE Sound, Inc. Licensed by BBE Sound, Inc. under one or more of the following US patents: 5510752, 5736897. BBE and BBE symbol are registered trademarks of BBE Sound, Inc.

BBE ViVA HD3D (High Definition 3D) Sound provides musically accurate natural 3D images with Hi-Fi sound. The clarity of the sound is improved by BBE while the width, depth and height of sound image are expanded by BBE's proprietary 3D sound process. BBE ViVA HD3D Sound is compatible with all TV programs including news, music, dramas, movies, sports and electronic games.



is a trademark of SRS Labs, Inc. TruSurround XT technology is incorporated under license from SRS Labs, Inc.



Hannspree products incorporate High-Definition Multimedia Interface (HDMI™) technology.

HDMI, the HDMI logo and High-Definition Multimedia Interface are trademarks or registered trademarks of HDMI Licensing LLC.

1.1 Package Contents

Make sure the following components are included in the box. Please contact Hannspree Customer Service immediately if anything is missing or damaged.

- TV
- User's manual
- Quick start guide
- Warranty and service manual
- Power cord
- Remote control and batteries
- A/V cable kit

1.2 Introducing the TV

You can watch NTSC broadcast or cable television channels, and easily connect a VCR, STB or DVD player to the standard CVBS and S-Video input ports located at the rear and/or side of the unit. You can also use the TV as a monitor for your PC by connecting it through the D-sub port.

Convenient control buttons located on the TV and a handy remote control let you change channels, adjust the volume, and change display settings through an easy-to-use on-screen display menu system. The built-in stereo speakers provide full rich sound and a convenient audio output port lets you connect to an external audio system or earphones.













1.2.1 Features

- Built-in analog and digital (for US and Canada only) TV tuner
- Audio/Video support:
 - Stereo audio inputs
 - Composite video inputs
 - Component video inputs
 - S-Video inputs
 - 3.5 mm stereo headphone output
 - VGA input
 - HDMI input
 - SPDIF (optical) out
 - R/L/Subwoofer (2.1ch) out
- On-Screen Display (OSD) menu system
- Multi-channel Television Sound (MTS) with SAP
- Built-in stereo speakers
- Image Enhancement Technology
 - 3:2 pull down
 - 3D Comb Filter
- Noise Reduction
- Advanced de-interlacing
- Edge Enhancement
- Memory card reader (support CF, MD, SM, SD, MMC, and MS-Pro cards)





Note:









The supporting devices mentioned in this manual may vary on different models. For more information, please refer to the manufacturer's user manual or the Quick Start Guide of your TV model.

1.2.2 Control Panel

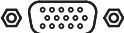
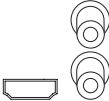



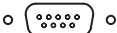

Description	Icon	Function
Power/ Power LED	 	Turns the TV on and off. Indicates power status.
Source		<p>Selects the input source to be displayed (TV, DTV, AV1, AV2, AV3, AV4, AV5, AV6(PC), AV7(HDMI), AV8 (E-CARD)).</p> <p>Notes:</p> <ul style="list-style-type: none"> • DTV is available for U.S. and Canada only. • AV8 is available on selected models only.
Menu		Turns the On-Screen Display (OSD) menu on and off.
Select channel	 	<p>Change channels. Press  to increase the channel number.</p> <p>Press  to decrease the channel number.</p>
Adjust volume	 	<p>Press  to increase the audio volume.</p> <p>Press  to decrease the audio volume.</p>
Memory card slots		Insert a Compact Flash (CF), Micro drive (MD), Smart Media (SM), Secure Digital (SD), Multi Media Card (MMC), or Memory Stick (MS-Pro) card into this slot to view the contents of the memory card. Use the E-CARD mode to view the contents.





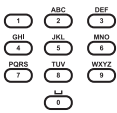



1.2.3 Input and Output Jacks

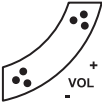

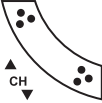

Description	Connector	Function
AV1 (R/L/V)		Use the AV1 input to connect an external device, such as a VCR, STB, or a DVD player with a composite output. Audio Input (R/L): red and white audio cables. Video Input (V): yellow (video) cable.
AV2 (S/V/L/R)		Use the AV2 input to connect an external device, such as a VCR, STB, or a DVD player. Audio Input (L/R): white and red audio cables. Video Input (S-Video or Video): S-Video cable or yellow (video).
AV3 (R/L/S)		Use the AV3 input to connect an external device, such as a VCR, STB, or a DVD player. Audio Input (R/L): red and white audio cables. Video Input (S): S-Video cable.
AV4 / AV5 (R/L/Y/Pb/Pr)		Use the AV4 / AV5 inputs to connect an external device, such as a VCR, STB, or a DVD player with a component output. Audio Input (R/L): red and white audio cables. Video Input (Y/PB/PR): video cables.





Description	Connector	Function
ANT (Antenna/ Cable TV line in)		Connects to an antenna or CATV cable television line.
ANT (RF-in digital)		Connects to an ATSC antenna such as a digital TV cable system.
AC IN		Connects to the included power cord.
AV6 (PC)		Connects to a PC's VGA port.
AV7 (HDMI)		Connects to devices such as a DVD player or set-top box.
LINE IN		Connects to a PC's line/audio out port.
LINE OUT (R/L)		Connects to external audio amplifier.
SUBWOOFER OUT		Connects to a subwoofer speaker with audio amplifier.
EARPHONE OUT		Connects to earphones.
RS-232		For factory use only. Not available for users.
OPTICAL OUT		Use the optical digital out connector to connect an audio decoder or audio/video processor.

1.2.4 Remote Control

Description	Icon	Function
Menu		Press this button to turn the On-Screen Display (OSD) menu on and off.
Arrow		Press ▲ / ▼ / ◀ / ▶ to scroll through the on-screen display menus. In memory card mode, press the arrow buttons to navigate menus, or to pan a picture when zooming in on a photo in Photo mode.
Numbers 0 ~ 9		Use to select a channel directly. Press 0-9 to enter the channel number (press 1 and 0 for channel 10). You can key in the alphabet in channel name editing function.
Recall		Press this button to return to the last channel selected. In memory card mode, press this button to start and end the slideshow.
CC		Press this button to enable the closed captions/subtitles (Only available in the United States of America). In memory card mode, press this button to rotate a picture when in Photo mode.
Power		Press this button to turn the TV power on or off.

Description	Icon	Function
Adjust volume		Press VOL + to increase the audio volume. Press VOL - to decrease the audio volume.
Mute		Press this button to eliminate sound. Press mute again or press the volume adjust buttons to restore sound.
Select channel		Changes channels. Press CH ▲ to increase the channel number. Press CH ▼ to decrease the channel number.
MTS		Press this button to change the multi sound selection of the TV channel.
Wide		Press this button to switch between wide screen and other modes (4:3 – 16:9 – Zoom). (Panoramic mode is available only for selected models.) In memory card mode, press this button to stop proceeding operation.
Hold		Press this button to hold. In memory card mode, press this button to go to the next track or picture.
Favorite		Press these buttons to select or store your favorite channels. (e.g. To set Ch. 33 as FAV1, go to Ch. 33 and press  , and then press  to save your settings.)

Description	Icon	Function
TV		Press this button to select TV source mode. Press this button again to enter DTV mode (available only for selected models).
Source		Press this button to display the AV source list on the screen.
OK		Press this button to execute the selection or setting and return to the last menu when using on screen display menus. In memory card mode, press this button to confirm a selection or play/pause the file playback.
Sleep		Press this button repeatedly to set the length of time until the TV turns off. Cancel the timer by pressing until the displayed time disappears. In memory card mode, press this button to zoom in a picture (magnification varies by input format).
Display		Press this button to show messages on the screen, such as the channel number, mode and others. Press this button again to close the displayed message.

Description	Icon	Function
Electronic Program Guide		Press this button to view the electronic program guide (EPG) (available only for selected models). In memory card mode, press this button to toggle between the EQ mode for music or the slideshow mode for photo.
DTV Information		Press this button to display information about the current channel (available only for selected models). In memory card mode, press this button to repeat the playing operation.
Twin Mode		Press this button to activate the picture by picture mode (available only for selected models). In memory card mode, press this button to return to the previous file.
Swap		Press this button to swap the activation of the primary and secondary sources for Twin mode (available only for selected models). In memory card mode, press this button to fast rewind.
Fast Forward		In memory card mode, press this button to fast forward.

Note:

The four color buttons (red, green, yellow, and blue) act as favorite channel function when the TV standard is set to NTSC.

1.2.5 Inserting the Remote Control Batteries

- 1 Open the battery compartment cover at the back of the remote control (A).

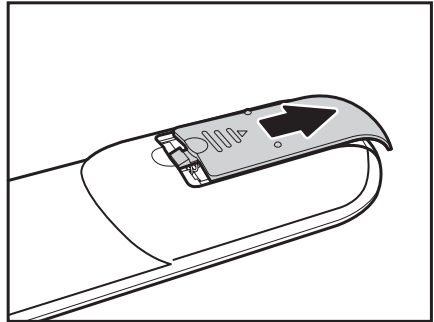

- 2 Insert the batteries paying attention to the polarity markings inside the battery compartment (B).

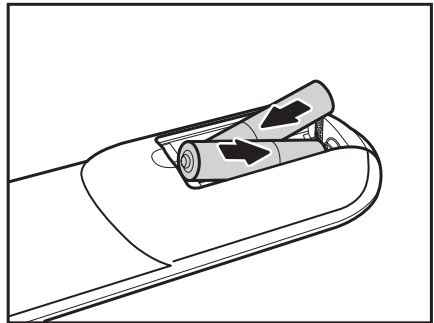

- 3 Replace the battery compartment cover (C).

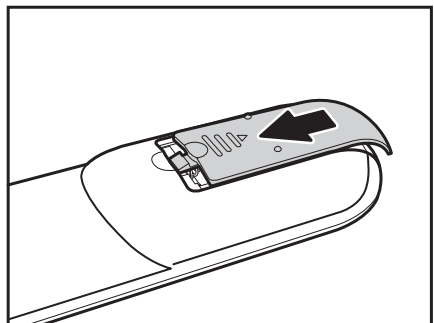

CAUTION



- If the remote control is not used for a long period, remove the batteries and store them properly.
- Handle damaged or leaking batteries carefully, and wash hands with soap if they come in contact with leaked chemical fluids.
- If your remote control has two batteries, do not mix new and old batteries or the life of the new batteries will be shortened. Chemical fluids may leak from the old batteries.
- Danger of explosion if battery is incorrectly replaced. Replace only with the same or equivalent type recommended by the equipment manufacturer. Discard used batteries according to manufacturer's instructions.
- Refer to your local recycling or waste disposal rules and contact a local waste disposal vendor to dispose of used batteries.
- The remote control cover may have a magnet in it, so do not place magnetic sensitive items such as watches, credit cards, or flash media close to the cover.
- Do not use force when pulling the remote control cover open; you may damage the hinge.

2.1 Basic Connections

The following sections provide users with some basic instructions to use the TV. Please read them carefully before you start utilizing the functions.

2.1.1 Connecting the Power Cord and Turning On

- 1** Connect the power cord to AC IN input jack on the rear panel of the TV.
- 2** Insert the plug at the other end of the power cord into a power outlet.
- 3** Move the Main Power Switch to the ON position to supply power to the TV.

Note:

If the TV is not going to be used for a long period, turn off the main power switch.

2.1.2 Connecting an Antenna or Cable TV

- 1 Connect one end of the VHF/UHF (Antenna) or CATV cable to ANT Jack (RF-in Analog) on the back of the TV.
- 2 Connect the other end of the VHF/UHF (Antenna) or CATV cable to the antenna socket or CATV socket.

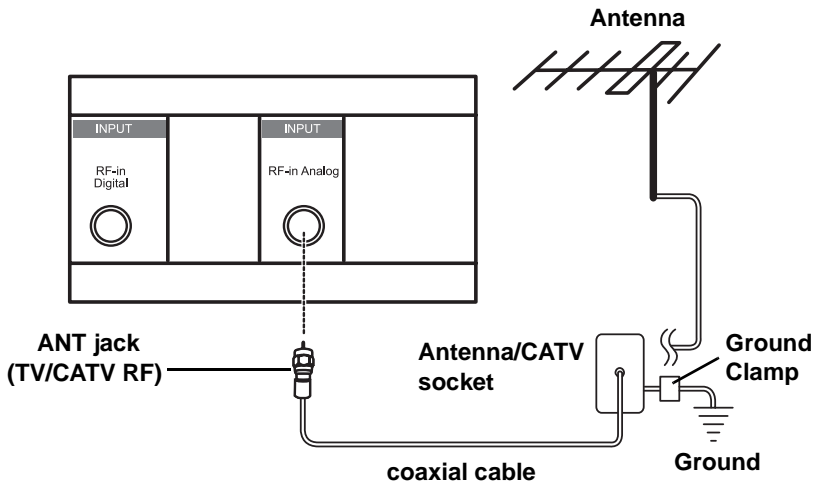

Notes:

- If you cannot receive channels after connecting to an antenna or cable TV line, try scanning for channels. See “Auto Search” on page 80.
- RF-in digital input is available for built-in DTV models only.

2.2 Connecting External Devices

Connect external devices such as VCRs, STBs, or DVD players to the TV using the AV1, AV2, AV3, AV4, and AV5 ports on the back or side of the TV.

2.2.1 Connecting External Earphones

External earphones may be used to listen to the TV rather than using the built-in speakers. Connect external headphones to the earphone line out port as illustrated.

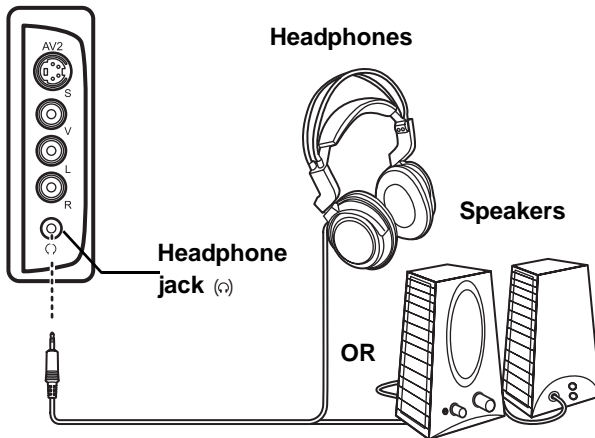

Notes:

- External earphones are not included with the TV.
- The built-in TV speakers do not output sound when earphones are plugged in.
- Location of the connectors varies according to the TV model. For more information, please refer to manufacturer's user manual or the the Quick Start Guide of your TV model.

2.2.2 Connecting an Amplifier Using Analog Audio

Connect an external amplifier of speakers to the line out port to provide better sound quality. Refer to the following illustration.

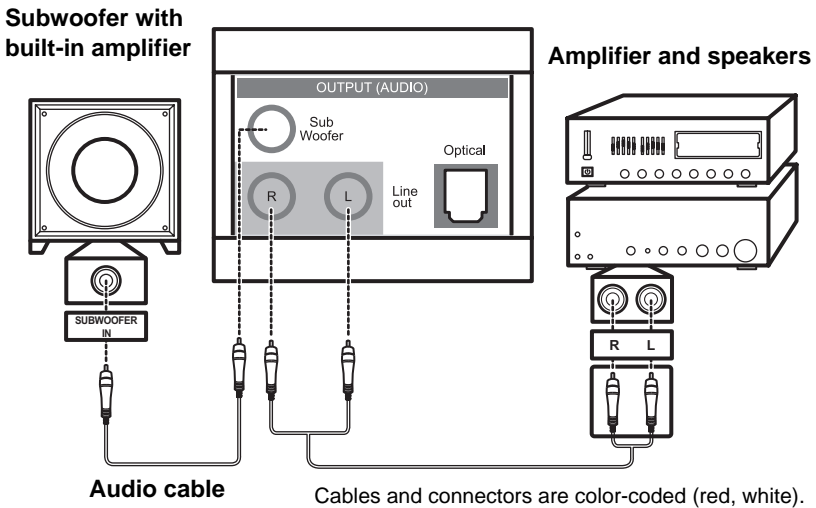

2.2.3 Connecting an Amplifier Using Digital Audio (Digital output is available for built-in DTV models only.)

Use the optical digital out connector to connect an audio decoder or audio/video processor when using a Digital TV (ATSC) receiver.

Refer to the following illustration to connect optical digital out.

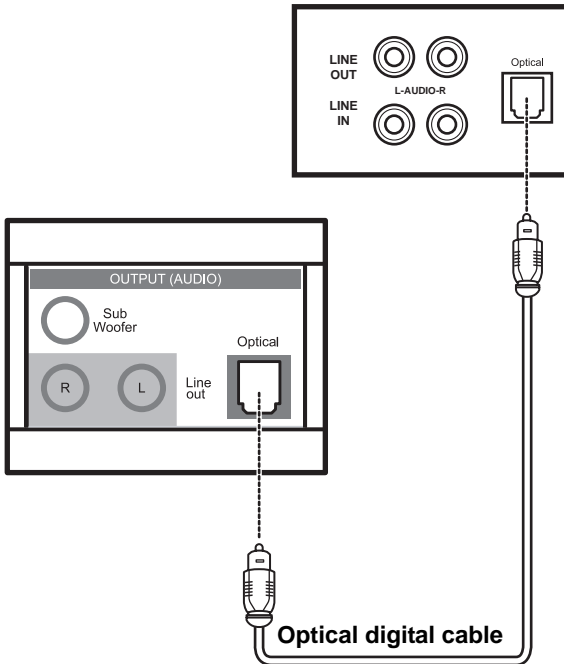

Note:

The supporting devices mentioned in this manual may vary on different models. For more information, please refer to the manufacturer's user manual or the Quick Start Guide of your TV model.

2.2.4 Connecting a VCR/STB/DVD Player Using Component Video

The illustration presented here shows how to connect your TV to a VCR / STB / DVD player using the AV4/AV5 component video ports. Actual connections may vary according to the make and model of your device.

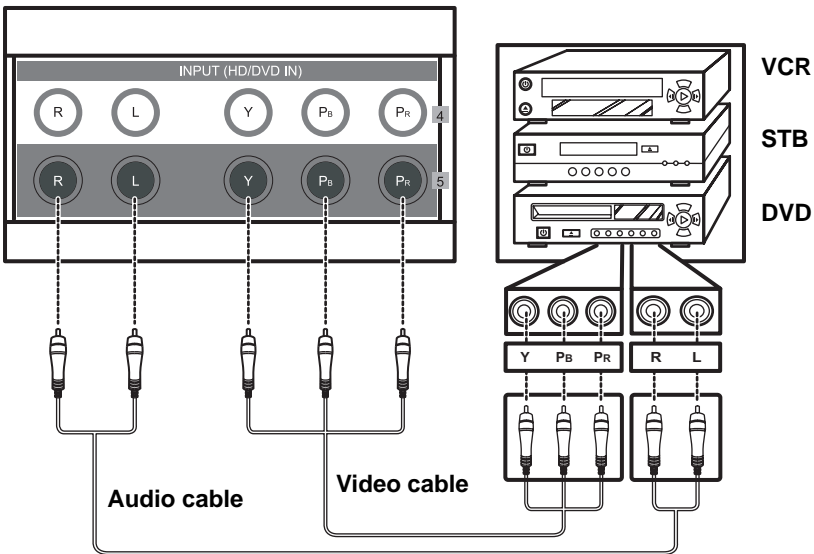

Cables and connectors are color-coded (red, white, green, blue, red).

2.2.5 Connecting a VCR/STB/DVD Player Using S-Video

The following illustration shows how to connect the TV to a VCR / STB / DVD player using the AV3 S-Video port. Actual connections may vary according to the make and model of the device.

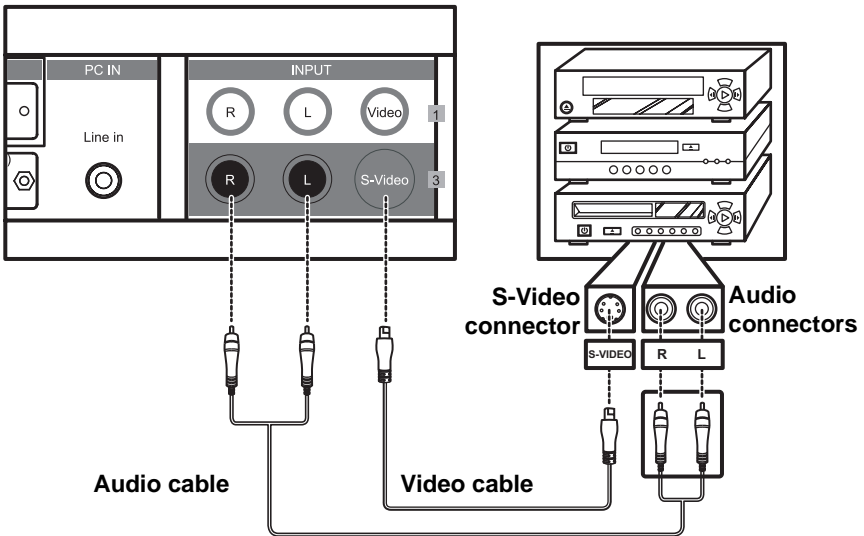

Cables and connectors are color-coded (red, white, black).

2.2.6 Connecting a VCR/STB/DVD Player Using Composite Video

The illustration presented here shows how to connect your TV to a VCR / STB / DVD player using the AV1 composite video port. Actual connections may vary according to the make and model of your device.

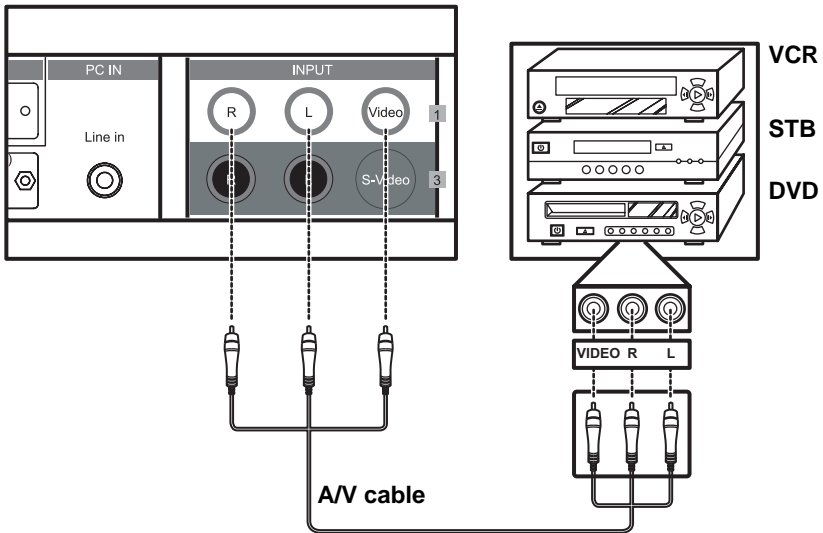

Cables and connectors are color-coded (red, white, yellow).

2.2.7 Connecting a Video Game Console

The following illustration shows how to connect the TV to a video game console using the AV2 port. Actual connections may vary according to the make and model of the device.

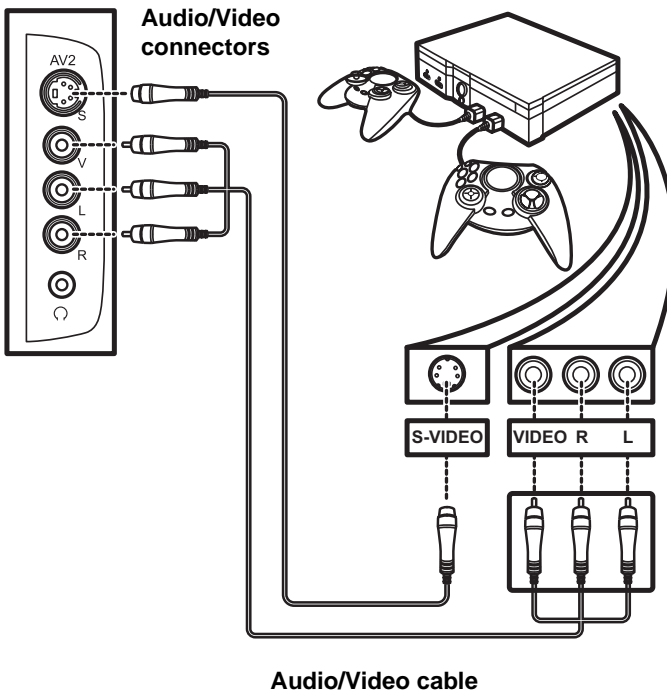

Notes:

- When connecting the S-Video connector and AV connectors at the same time, the priority is given to the S-Video connector.
- Location of the connectors varies according to the TV model. For more information, please refer to the manufacturer's user manual or the Quick Start Guide of your TV model.

2.2.8 Connecting a PC

Connect the TV to your PC to use it as the monitor using the D-Sub port as shown. Connect the D-Sub port of the TV to the D-Sub output of the PC. Connect the line out port of the PC to the line in port of your TV to listen to audio from the PC.

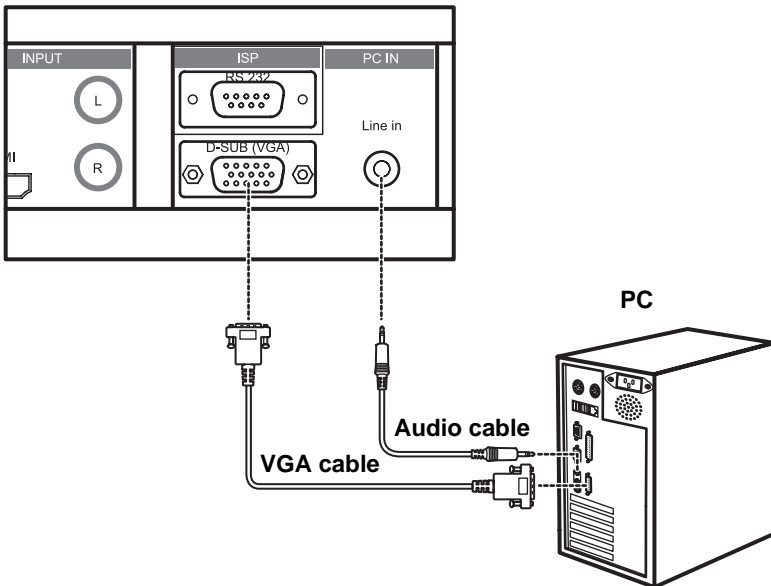

Notes:

- Location of the connectors varies according to the TV model.
- For more information, please refer to the manufacturer's user manual or the Quick Start Guide of your TV model.

2.2.9 Connecting HDMI

HDMI (High Definition Multimedia Interface) with HDCP (High Definition Copy Protection) assures that the best video signal is always sent from source (HDTV signal, DVD player) to the TV.

Refer to the following illustration to connect an HDMI device to the TV.

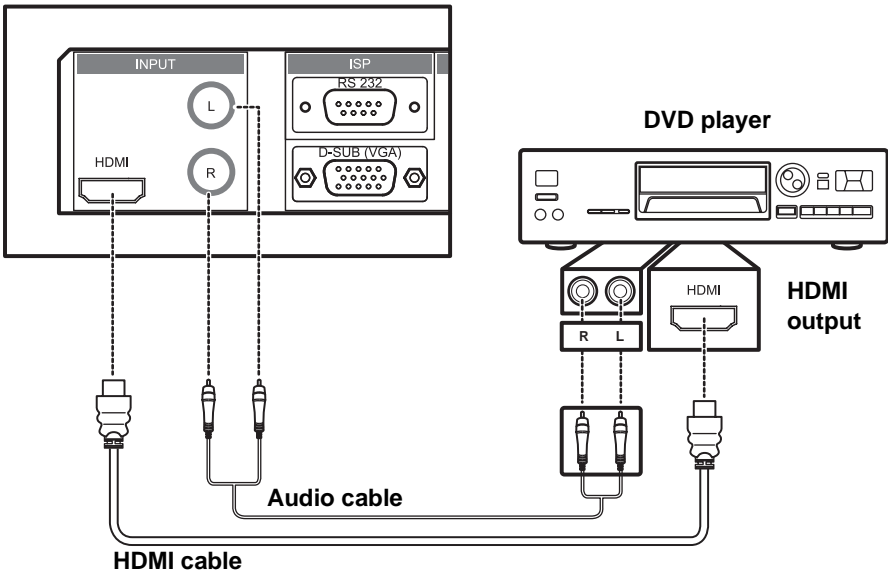

Note:

When the HDMI cable is connected, connecting the audio cable is not necessary. However, it is necessary to do so if the HDMI-DVI-D adapter cable is connected.

2.2.10 Connecting Digital TV

- 1 Connect one end of the VHF/UHF (Antenna) or CATV cable to ANT Jack (RF-in Digital) on the back of the TV.
- 2 Connect the other end of the VHF/UHF (Antenna) or CATV cable to the antenna socket of the digital TV device.

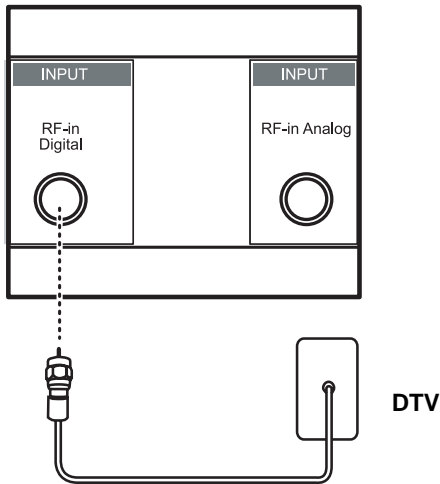

Notes:

- If you cannot receive channels after connecting to an antenna or cable TV line, try scanning for channels. See “Auto Search” on page 80.
- RF-in digital input is available for DTV built-in models only.

2.3 Inserting a Memory Card

- 1 Insert the memory card(s) into the appropriate card reader slot(s) on the control panel of the TV as shown.

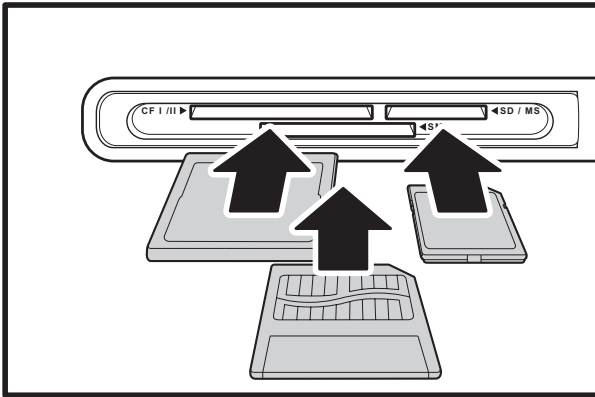

- 2 Push the card(s) gently until they stop. Make sure the card(s) are inserted in the correct way.
- 3 When inserted, the memory card(s) will protrude as shown.

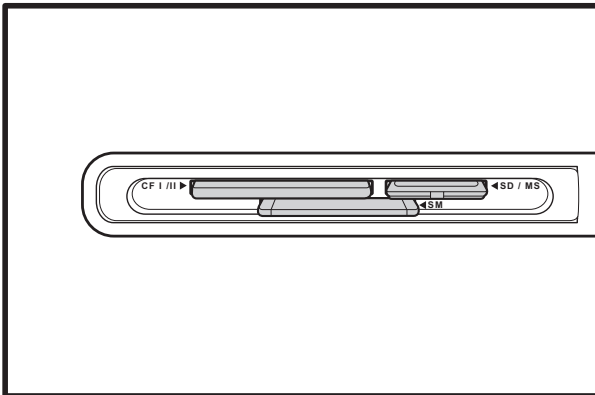

- 4 To remove a card, pull it from the card slot.

Notes:

- To prevent data loss, end tasks that retrieve data from the memory card before removing it from the card slot.
- Use only certified memory cards.
- Supports memory cards with a capacity of up to 1GB.
- E-CARD related functions and file names are only shown in English.
- Be careful when removing memory cards; removing them too quickly may result in damage to the card and possible data loss.
- Please refer the flash card website below:
SM CARD: <http://www.ssfdc.or.jp/english/index.htm>
SD CARD: <http://www.sdcard.org/>
CF CARD: <http://www.compactflash.org/>
MS CARD: <http://www.memorystick.com/en/>
MMC CARD: <http://www.mmccard.org/>
- Supports play format: JPEG/MPEG, MPEG/II, MP3, MPEG4.

2.4 Using the TV





2.4.1 Using the Remote Control

For best results, use the remote control within a proper distance from the front of the TV. Do not exceed an angle of 30 degrees when pointing at the TV.



Notes:

- The operational distance may be shortened when the signal sensor is directly exposed to strong light.
- Aim the transmitter on the remote control at the signal sensor and ensure that there are no obstacles between them.

2.4.2 Turning the TV On and Off

- 1 Press  on the remote control or  on the control panel. The power LED indicator on the front of the TV changes from red to green, indicating that the power is on.
- 2 Press  or  again. The power LED changes from green to red, indicating that the TV is off.

2.4.3 Selecting Channels

- Press **CH▲** on the remote control or  on the control panel to increase the channel number by one. Press **CH▼** or  to decrease the channel number by one.
- Enter the specific channel number by pressing the number buttons on the remote control. The channel number is displayed on the screen.

2.4.4 Switching Source Signals

Press **SOURCE** on the control panel or **Source** on the remote control to select the incoming source signal. A screen appears with all sources listed. (Some of the sources are available only for selected models.)

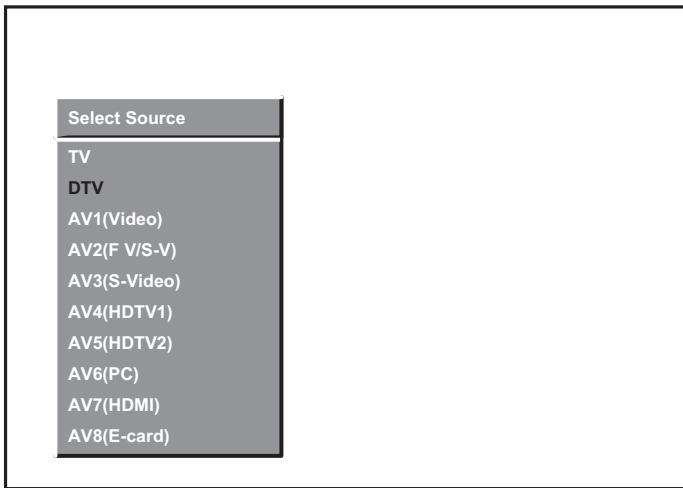

- 1 Press **▲** or **▼** on the remote control or **CH▲** or **CH▼** on the control panel to select the source you wish to use.
- 2 Press **OK** on the remote control or **SOURCE** on the control panel to confirm the setting.
- 3 Press **Menu** on the remote control or **MENU** on the control panel to exit.





2.4.5 Adjusting the Volume

- 1 Press **VOL+** to increase the volume.
- 2 Press **VOL-** to decrease the volume.
- 3 Press **Mute** to eliminate sound. A mute icon appears on the top left corner of the screen and sound is turned off.
- 4 Press **Mute** again or press the volume buttons to restore the original volume.

2.5 Using the E-CARD Function (For built-in E-CARD only)

The E-CARD function enables you to view photos, watch movies, and listen to MP3 files on the memory card inserted in the card slot. The device supports Compact Flash (CF), Micro drive (MD), Smart Media (SM), Secure Digital (SD), Multi Media Card (MMC), and Memory Stick (MS-Pro) cards. Use the E-CARD mode (AV8) to view the contents.

The following describes the E-CARD function:

- 1 Insert a memory card into the appropriate card slot. Refer to “Inserting a Memory Card” on page 37.
- 2 Press  on the remote control to display all available sources. Use the  button on the remote control to switch source to AV8 (E-CARD).
- 3 If more than one memory card is inserted to the card slots, a screen displaying the inserted cards is displayed. Use the  button on the remote control to select the memory card and press  to view the contents.

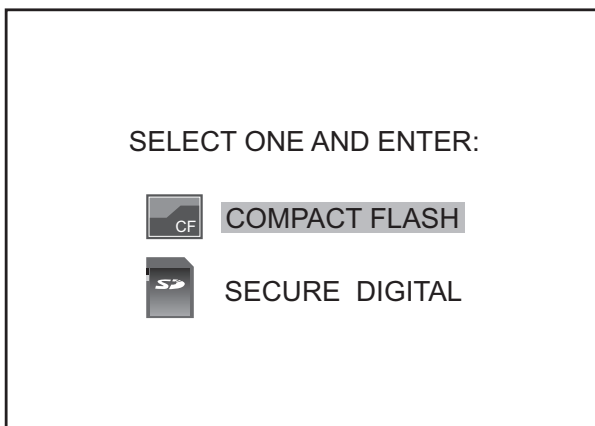



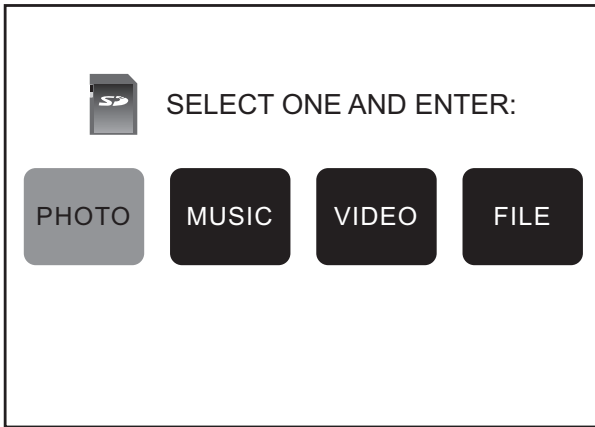



-
- 4 The E-CARD main screen appears. You can choose to view photos, listen to music, watch videos, or look at the contents of the memory card.







E-CARD main screen

2.5.1 Remote Control Keys in E-CARD Mode

The following table lists the remote control buttons used to operate the E-CARD feature.



Button	Description	Function
	Cursor up / down / left / right	Press these buttons to navigate the E-CARD menus. In Photo mode, use these buttons to pan a picture when zooming in.
	Play / Pause	Press this button to confirm a selection or to play/pause a music/video file.
	Stop	Press this button to return to the E-CARD main screen. In Music or Video mode, press to stop playing back a file.
	Slide Show	Press this button to start and stop the slide show.
	Zoom	Press this button to zoom in on a picture. (Magnification varies by input format).
	Rotate	Press this button to rotate a picture when in Photo mode.
	Previous	Press this button to play the previous file on the memory card.

Button	Description	Function
	Next	Press this button to play the next file on the memory card.
	Effect	Press this button to toggle between the EQ mode for music or photo slideshow mode.
	Repeat	Press this button to repeat the playing operation.
	Fast rewind	Press this button to fast rewind.
	Fast forward	Press this button to fast forward.



2.5.2 Viewing Photos

- 1 When the E-CARD main screen appears, use the ◀/▶ button on the remote control to select PHOTO.



- 2 Press  to display the thumbnails of images on the memory card.
- 3 Use the ▲ / ▼ / ◀ / ▶ button to select a thumbnail image.
- 4 Press  to expand the selected thumbnail to full screen mode.



-
- 5 Press the ► / ▼ /  button to go to the next picture. Press the ◀ / ▲ /  button to go to the previous picture.

Note:

If the image is not in the standard size/resolution (i.e. 800x600, 1024x768), it may appear deformed or with a blue/black background.

Zooming and Panning

The E-CARD function enables you to zoom in on images and pan the view. Follow these instructions.

- 1 View an image in full screen mode as described in the previous section.
- 2 Press  on the remote control to zoom in on the image.
(Magnification varies by input format).

When zooming in on an image, press the ▲ / ▼ / ◀ / ► button on the remote control to pan the image.

Rotating Images

Follow these instructions to rotate images when in Photo mode.

- 1 View an image in full screen mode as described in the previous section.
- 2 Press  on the remote control.
- 3 The image is rotated 90 degrees (90°) in a clockwise direction.

Note:

You cannot rotate an image when the image is being zoomed.

Viewing a Slide Show

The E-CARD function has a slide show feature that enables you to view all the images by order.

- 1 Press  on the remote control to start the slide show.

The files are viewed sequentially, and files in your music library are also played in sequence.

- 2 Press  again to stop the slide show.

To pause a slide show, press  on the remote control.

- 3 Press  on the remote control to turn the repeat function on/off.

Folder Repeat mode has the following options:

- **ON:** runs the slide show again in the selected folder.
- **OFF:** turns the folder repeat mode off.

- 4 **Transition:** Press  on the remote control to choose different transition effects when playing the slide show.

Transition Table

Transition	Description
1 FULL SCREEN	Image appears full screen.
2 ROLL: TOP TO BOTTOM	Image rolls in from top to bottom.
3 ROLL: BOTTOM TO TOP	Image rolls in from bottom to top.
4 ROLL: TOP/BOTTOM TO CENTER	Image rolls in from top and bottom to center.
5 ROLL: CENTER TO TOP/BOTTOM	Image rolls in from center to top and bottom.
6 BLIND: TOP TO BOTTOM	Image rolls in blinds from top to bottom.
7 ROLL: LEFT TO RIGHT	Image rolls in from left to right.
8 ROLL: RIGHT TO LEFT	Image rolls in from right to left.
9 ROLL: LEFT/RIGHT TO CENTER	Image rolls in from left and right to center.
10 ROLL: CENTER TO LEFT/RIGHT	Image rolls in from center to left and right.
11 ROLL: IMplode	Image closes into center point.

Transition	Description
12 BLIND: LEFT TO RIGHT	Image rolls in blinds from left to right.
13 CROSS FADE	Image fades in and out.
14 SLIDE MODE: RANDOM	Transition effects are chosen randomly.

2.5.3 Listening to Music

- 1 When the E-CARD main screen appears, use the ◀/▶ button on the remote control to select MUSIC.

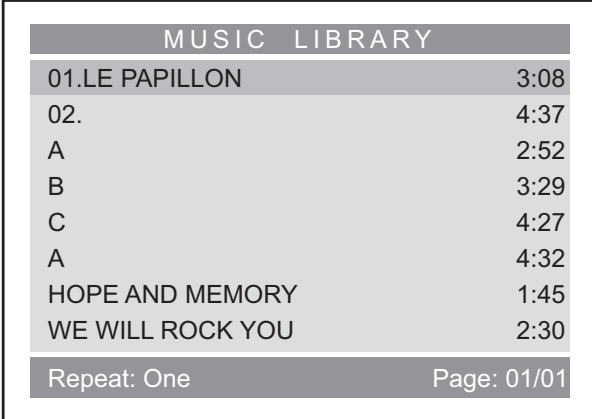

MUSIC LIBRARY	
01.LE PAPILLON	3:08
02.	4:37
A	2:52
B	3:29
C	4:27
A	4:32
HOPE AND MEMORY	1:45
WE WILL ROCK YOU	2:30
Repeat: One	Page: 01/01

- 2 Press . A screen appears displaying a list of the music stored on your memory card.
- 3 Use the ▲/▼/◀/▶ button to select a music file. The selected file starts playing. When the file finishes playing, the next file in the list is played.

-
- 4 Press  to display the Music Equalizer screen. This screen enables you to view information about the file you are playing.

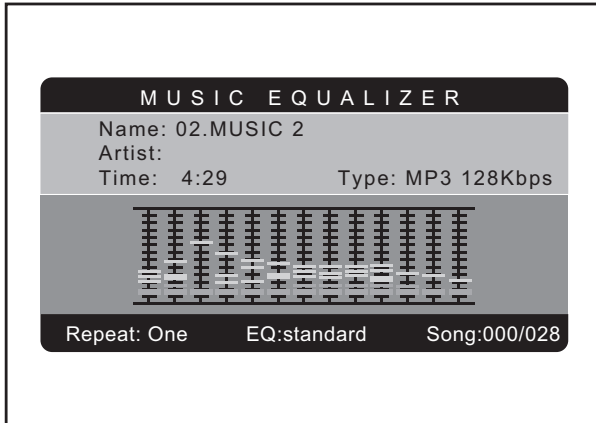

Repeat mode

Press  to switch among the following repeat modes:

- **ONE:** repeats one file
- **ALL:** repeats all files in sequence
- **OFF:** turns repeat mode off

EQ mode



Press  to toggle EQ mode:

- Choose from Jazz / Rock / Pops / Ballad / Dance / Standard / Classic

2.5.4 Watching Videos

- 1 When the E-CARD main screen appears, use the ◀/▶ button on the remote control to select VIDEO.





- 2 Press . A screen appears displaying thumbnails of the videos on your memory card.
- 3 Use the ▲/▼/◀/▶ button on the remote control to select a video file.
- 4 Press . The selected video file begins playing.

2.5.5 Viewing Memory Card Files

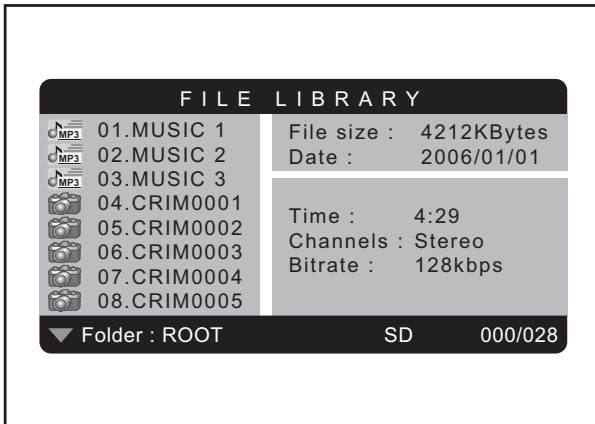
- 1 When the E-CARD main screen appears, use the ◀/▶ button on the remote control to select FILE.



- 2 Press . A screen appears displaying a list of the files on your memory card. The file type is denoted by the icons, and the file size, creation date, and thumbnail view of the file provides additional information.
- 3 Use the ▲ / ▼ / ◀ / ▶ button to select a file and press . The selected file is displayed or played.

2.6 Using the Digital TV (For built-in DTV only)



The built-in DTV function provides viewers to enjoy TV in many ways through enhanced and interactive services that add to the viewing experience.

2.6.1 Switching Signal Source

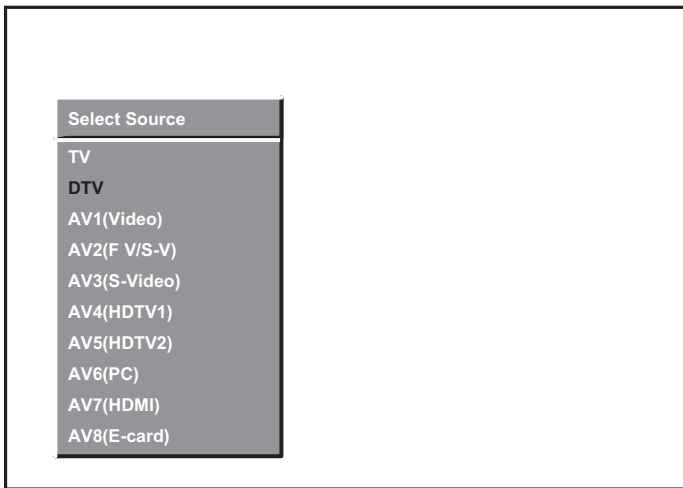
Press **SOURCE** on the control panel or **Source** on the remote control to select the incoming source signal. A screen appears with all sources listed. (Some of the sources are available only for selected models.)



- 1 Press **▲** or **▼** on the remote control or **CH▲** or **CH▼** on the control panel to select DTV.
- 2 Press **OK** on the remote control or **Source** on the control panel to confirm the setting.

3 Press  on the remote control or  on the control panel to exit.





Note:

Use the Auto Search function to scan all available digital TV channels before viewing digital TV programs for the first time.

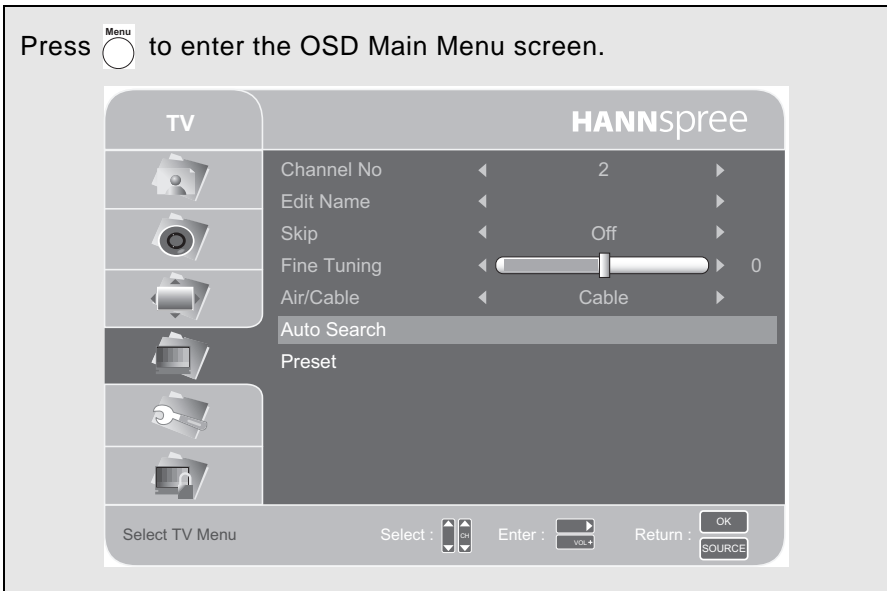
2.6.2 Searching for Digital Channels

Before you start viewing the digital TV programs, you must perform Auto Search to scan for all available ATSC and cable channels on DTV source signals.



- 1 Press  or the  button to enter the TV Menu.
- 2 Press the   or **CH▲/CH▼** button to select Auto Search.

-
- 3** Press  to start searching for all the available channels. A banner appears on the screen showing the number of available channels scanned.

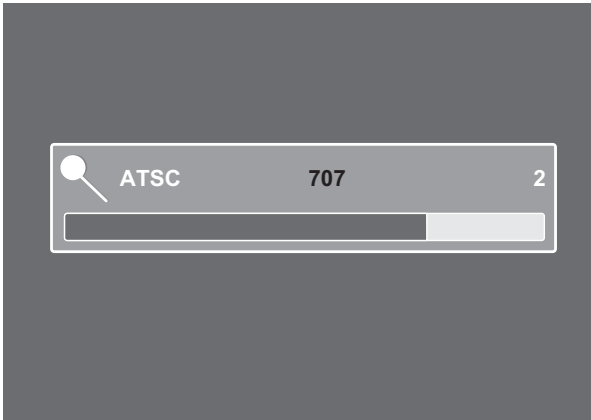

- 4** After searching all the channels, the last available channel scanned is displayed on the screen. The Channel Banner appears showing information of the current program.

Channel Banner

The Channel Banner located at the bottom of the screen provides viewers with basic information of the chosen channel and the currently broadcast program. Press  in normal viewing mode to display the Channel Banner.

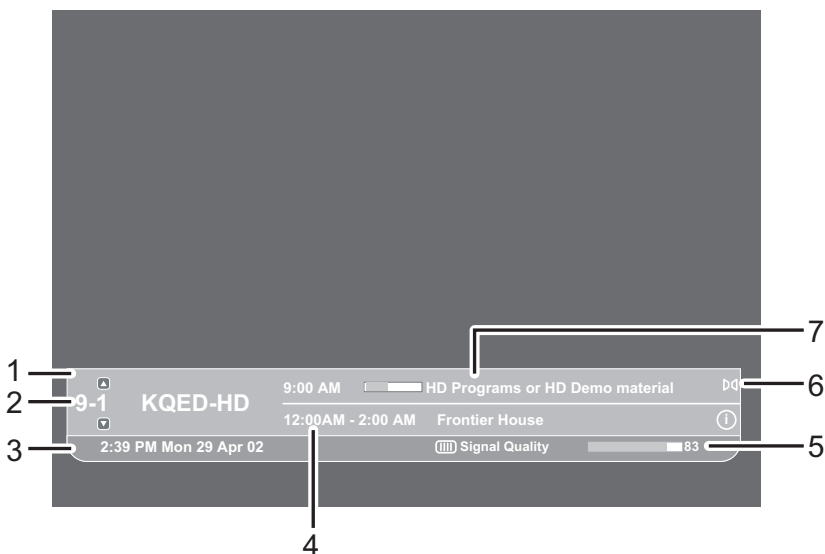









No.	Item	Description
1	Up/Down arrows	Appear when there is more than one channel on the list.
2	Channel no.	The first two digits stand for the number of available channels on the list. The two digits after the dash stand for its order on the list.
3	Date/Time	Indicates current time.

No.	Item	Description
4	Next on	Indicates the next program and its schedule.
5	Quality indicator	Indicates the signal quality. The better the signal, the longer the bar.
6	Icon	Indicates additional information about the program.
7	Current program	Displays the name and the starting time of the program. The bar extending to the right shows the elapsed time.

Note:

The content in the channel banner is sent by the broadcaster. Information that is displayed may vary from broadcaster to broadcaster.







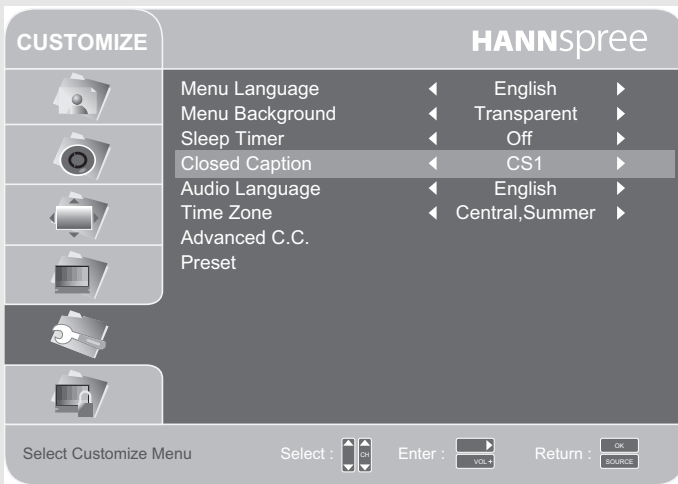

The following table describes the definition of the icons displayed in the Channel Banner.

Icon	Description
	Indicates that the channel has been set as one of the favorite channels. The color of the face mark corresponds to the color of the favorite key on the remote control.
	Indicates that the program is under parental rating.
	Indicates that extended information is available for the program.
	Indicates that the channel is digital standard.
	Indicates that the channel is digital high definition.
	Indicates that AC3 is available for the program.
	Indicates that alternative soundtracks are available for the program.
	Indicates that closed captions are available for the current program.



2.6.3 Digital Customize Settings

Press  to enter the OSD Main Menu screen.



- 1 Press  or  to enter the CUSTOMIZE Menu.
- 2 Press   or **CH▲/CH▼** button to select an option.
- 3 Press  or  to change the mode setting.
- 4 Press  to select the changed setting and return to the CUSTOMIZE Menu.
- 5 Press  to exit the CUSTOMIZE menu.

The Customize Mode menu includes the following options.

Option	Description
Menu Language	Select from the following language options: <ul style="list-style-type: none">• English• Español• Français Note: OSD language may vary from region to region.
Menu Background	Enables you to set the OSD background to be transparent or solid.
Sleep Timer	Enables you to set the TV to turn off after a set time. Select from the following sleep timer options: <ul style="list-style-type: none">• 120 minutes• 90 minutes• 60 minutes• 30 minutes• Off You can also press  on the remote control to enable sleep mode. Press  again to reset the timer.
Closed Caption	Enables closed captions. Select from the following options: <ul style="list-style-type: none">• CS1 ~ CS6
Audio Language	Select from the following audio language options: <ul style="list-style-type: none">• English• Spanish• French• German• Italian

Option	Description
--------	-------------

Time Zone

Enables you to select the specific time zone for your area.

Enables you to configure settings for font type, size, style, color, opacity, edge, edge color, background color, and background opacity of closed caption.

Advanced C.C.

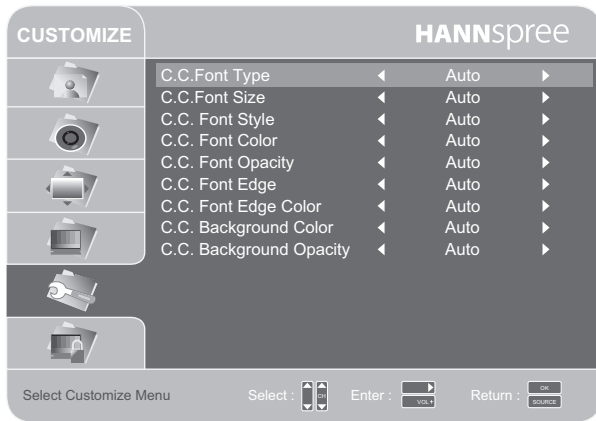

Note: This function is only available when Closed Caption value is set to CS1 ~ CS6.





Preset



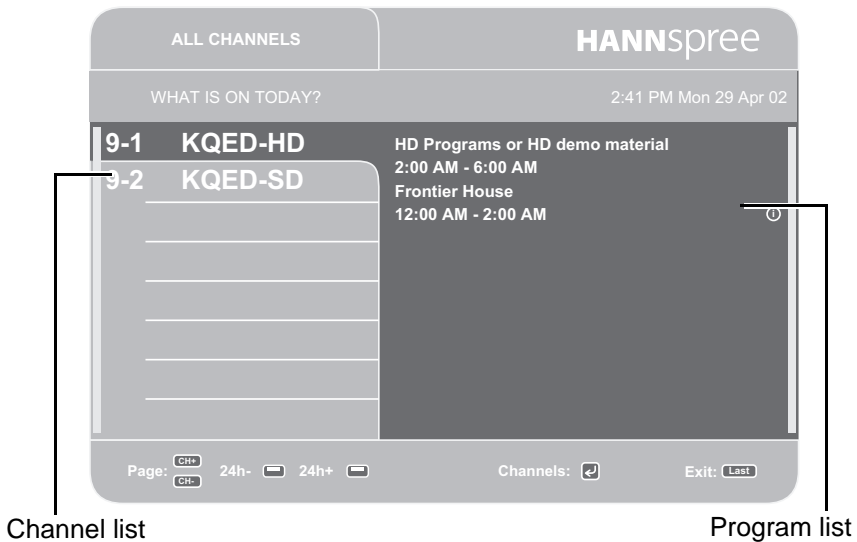

Erases all customized settings and return all values to factory defaults.

2.6.4 Using the Electronic Program Guide (EPG)

The Electronic Program Guide (EPG) provides viewers a quick glance at the program schedule and information for all available channels. The **Navigator** displays the channel list on the left column and the programs broadcast on the current channel for the day and the six following ones.









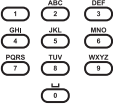

- 1 Press  to display the **Navigator** window.
- 2 Use  or  button to select a specific channel from the channel list.
- 3 Press  to enter the program list of the selected channel. The program currently being broadcast on the selected channel is highlighted.

-
- 4 Press  or  button to select programs from the list. And press  to display extended information of the selected program.
- 5 Press  to exit EPG and return to the broadcast program screen.

Notes:

- **Data displayed in EPG is updated in real time. Current broadcast program disappears from the list when the program has ended.**
- **EPG information will vary from region to region depending on the broadcasters and/or CATV system in your area.**



Using the Remote Control in Navigator

Button	Description
	Press to tune to selected channels.
	Press to toggle between Navigator and the normal viewing mode.
	Press to change the soundtrack.
	Press to turn the closed caption on and off.
	Press to display the Program Info window.
	Press to shift focus up/down and tune the highlighted channel.
	Press to switch between program list and channel list.
	Press to return to normal viewing mode.
	Press to change the day.

Viewing Program Information

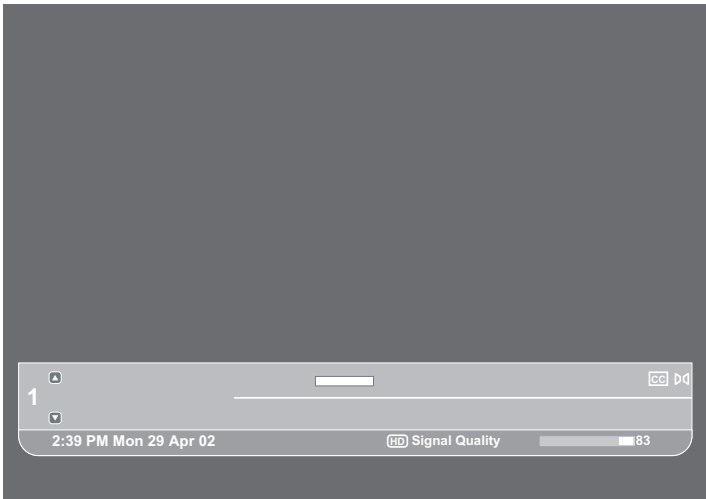
Press  to view program information for the selected program. A window pops up to display a brief introduction of the chosen program and its broadcast schedule.



- If the information exceeds one page, press  again to go to the next page of the Program Information window. In the last page, press  closes the Program Information window.

-
- Press  to exit the Program Information window and return to the normal viewing mode.



Note:

The message “No information is available for the selected program” is displayed in the center of the window if no program information is broadcast for the chosen program.

Adjusting On-Screen Display (OSD) Settings

The On-Screen Display (OSD) menu system provides a quick and simple method to adjust the TV settings. This chapter describes how to change each of the available settings. The OSD menu can be accessed through the buttons either on the front control panel or the remote control.

Function	TV Control Panel	Remote Control
OSD Menu	MENU	Menu
Up	CH ▲	▲ / CH ▲
Down	CH ▼	▼ / CH ▼
Add/Enter	VOL+	▶ / VOL+
Decrease	VOL-	◀ / VOL-
Return	SOURCE	OK / Source

3.1 OSD Setting Menus

Menu Icon Description



Enables you to make adjustments to picture settings such as brightness, contrast, saturation, sharpness, hue, and create custom configurations.

VIDEO



Enables you to adjust audio characteristics such as bass and treble, and also enables enhanced audio options such as Surround.

AUDIO



In PC mode, enables you to set characteristics such as phase and clock.

PC



Enables you to choose TV or CATV, autoscan for channels, add and delete channels, and edit channel names.

TV



Enables you to set the OSD language, set the sleep timer and enable closed captions.



CUSTOMIZE



Enables you to set parental controls to prevent unauthorized access to certain TV content (available in the US and Canada only).

PARENTAL







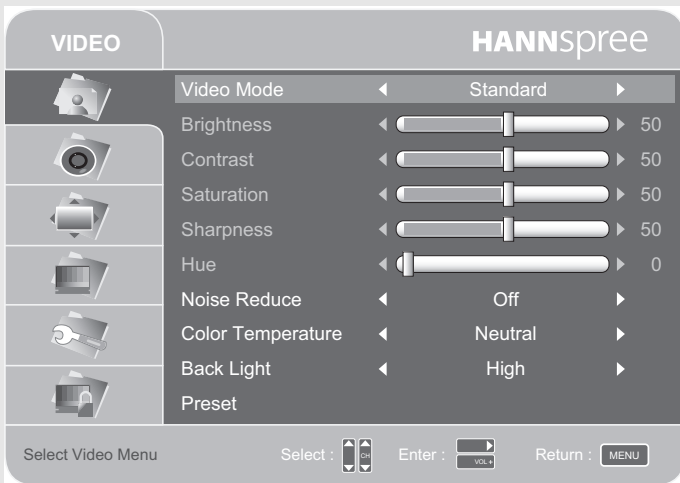

Notes:

- Press  /  to exit the menus at any time.
- You can control the OSD with either the remote control or the TV control panel.
- The new setting is confirmed automatically when the OSD times out.

3.2 Adjusting Video Settings

Press  to enter the OSD Main Menu screen.



- 1 Press  or  to enter the VIDEO Menu.
- 2 Press   or **CH▲/CH▼** button to select an option.
- 3 Press  or  to change the mode setting.
- 4 Press  to select the changed setting and return to the VIDEO Menu.
- 5 Press  to exit the VIDEO menu.

The Video Mode menu includes the following options.







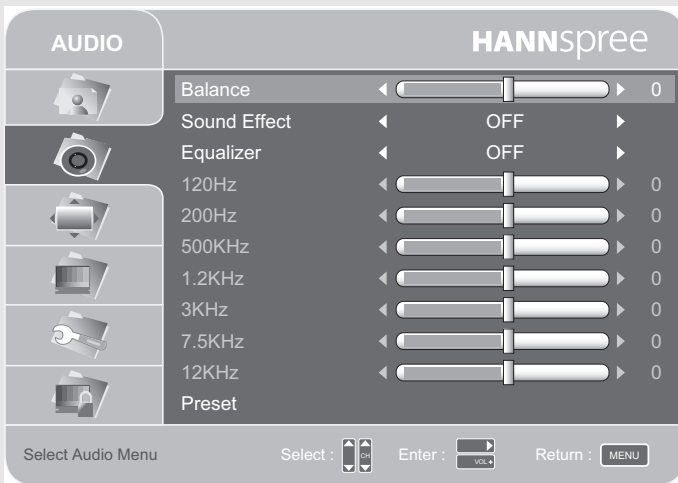

Option	Description
Video Mode	Enables you to customize the video display. The following options are available:
	Vivid Sets the display for enhanced picture contrast and saturation.
	Standard Sets the display for normal viewing (default).
Custom Enables you to set user defined values.	
Brightness	Brightens or darkens the picture.
Contrast	Increases or decreases the contrast. Increasing the contrast makes the colors deeper. Decreasing the contrast makes the colors softer.
Saturation	Adjusts the intensity of the color.
Sharpness	Sharpens or softens picture clarity. Decrease this value to make the pictures softer.
Hue	Increases or decreases the red tint.
Noise Reduce	Noise reduction enables you to reduce the amount of interference in the signal. The following options are available:
	<ul style="list-style-type: none">• High• Middle• Low• Off
	Note: Noise reduction only works in TV and AV1 ~ AV3 modes.

Option	Description
Color Temperature	Color temperature refers to the warm or cool feeling of a color, rather than actual temperature. The following options are available: Cold Gives white colors a bluish tint. Neutral Gives white colors a neutral tint. Warm Gives white colors a reddish tint.
Back Light	Sets the LCD backlight. Set this to low to conserve power.
Preset	Erases all customized picture settings and returns all values to factory defaults.

3.3 Adjusting Audio Settings

Press  to enter the OSD Main Menu screen.



- 1 Press  or  to enter the AUDIO Menu.
- 2 Press   or **CH▲/CH▼** button to select an option.
- 3 Press  or  button to change the mode setting.
- 4 Press  to select the changed setting and return to the AUDIO Menu.
- 5 Press  to exit the AUDIO menu.







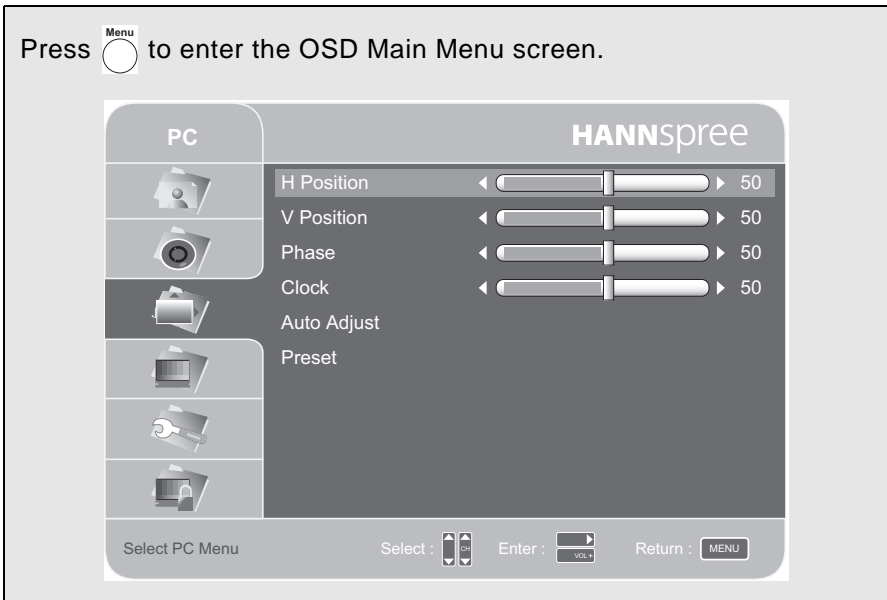

The Audio Mode menu includes the following options.

Option	Description
Balance	Changes the balance between the left and right speakers.
Sound Effect	Toggles between the TruSurround XT and BBE ViVA HD3D sound features.
Equalizer	Enables you to adjust equalizer settings. Select Custom to adjust individual equalizer frequencies. <ul style="list-style-type: none">• LIVE• POP• ROCK• CUSTOM
Preset	Erases all customized audio settings and return all values to factory defaults.

3.4 Adjusting PC Settings

If a PC is connected, the PC mode menu items become available. The PC Mode menu includes the following options.



- 1 Press  or  to enter the PC Menu.
- 2 Press   or **CH▲/CH▼** button to select an option.
- 3 Press  or  button to change the mode setting.
- 4 Press  to select the changed setting and return to the PC Menu.
- 5 Press  to exit the PC menu.

The PC Settings menu includes the following options:

Option	Description
H Position	Press ◀ or ▶ to adjust the horizontal position of the display.
V Position	Press ◀ or ▶ to adjust the vertical position of the display.
Phase	Press ◀ or ▶ to adjust the phase timing.
Clock	Press ◀ or ▶ to adjust the clock timing.
Auto Adjust	Press ▶ to allow the TV to adjust the display automatically for best results.
Preset	Press ▶ to erase all customized PC settings and return all values to factory defaults.







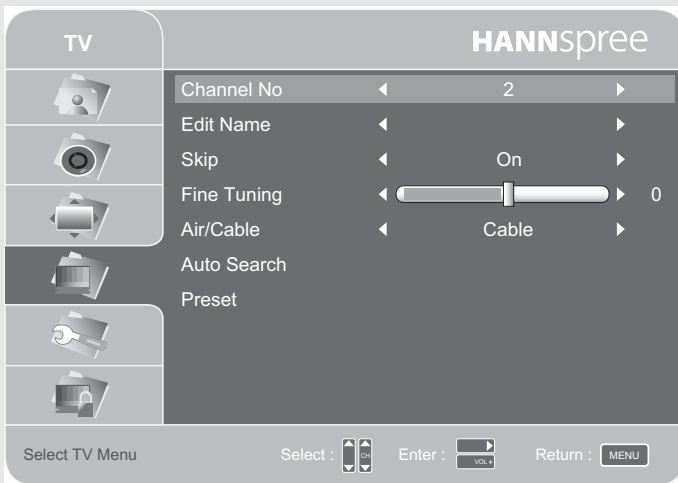

Note:

The display resolution is based on the PC input signal.



3.5 Adjusting TV Settings

Press  to enter the OSD Main Menu screen.



- 1 Press  or  to enter the TV Menu.
- 2 Press   or **CH▲/CH▼** button to select an option.
- 3 Press  or  to change the mode setting.
- 4 Press  to select the changed setting and return to the TV Menu.
- 5 Press  to exit the TV menu.



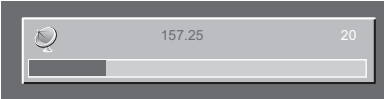



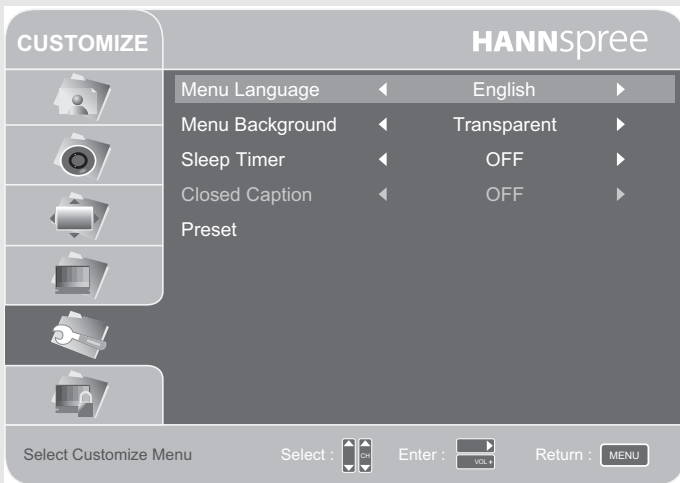

The TV Mode menu includes the following options.

Option	Description
Channel No	Use to select a channel to adjust its settings.
Edit Name	Use the alphanumeric keypad on the remote control to enter a name for the channel. You can use up to five alphanumeric characters for the name.
Skip	Select ON to remove the selected channel number from the channel list. Select OFF to add the selected channel number to the channel list.
Fine Tuning	Select this item and press  or  to fine tune a channel for better picture quality.
Air/Cable	Enables you to select the TV source signal. The following options are available: Air Selects the antenna. Cable Selects cable TV.
Auto Search	Press  to have the TV automatically scan through all the available channels and assign channel numbers to them. 
Preset	Select this to erase all customized TV settings and return all values to factory defaults.



3.6 Making Customize Settings

Press  to enter the OSD Main Menu screen.



- 1 Press  or  to enter the CUSTOMIZE Menu.
- 2 Press   or **CH▲/CH▼** button to select an option.
- 3 Press  or  to change the mode setting.
- 4 Press  to select the changed setting and return to the CUSTOMIZE Menu.
- 5 Press  to exit the CUSTOMIZE menu.



The Customize Mode menu includes the following options.

Option	Description
Menu Language	<p>Select from the following language options:</p> <ul style="list-style-type: none">• English• Español• Français• 繁體中文 <p>Note: OSD language may vary from region to region.</p>
Menu Background	<p>Enables you to set the OSD background to be transparent or solid.</p>
Sleep Timer	<p>Enables you to set the TV to turn off after a set time. Select from the following sleep timer options.</p> <ul style="list-style-type: none">• 120 minutes• 90 minutes• 60 minutes• 30 minutes• Off <p>You can also press  on the remote control to enable sleep mode. Press  again to reset the timer.</p>
Closed Caption (available in the US only)	<p>Enables closed captions. Select from the following options:</p> <ul style="list-style-type: none">• CC1 ~ CC4• TEXT1 ~ TEXT4
Preset	<p>Erases all customized settings and return all values to factory defaults.</p>

3.7 Setting Parental Controls (Available in the US and Canada only)

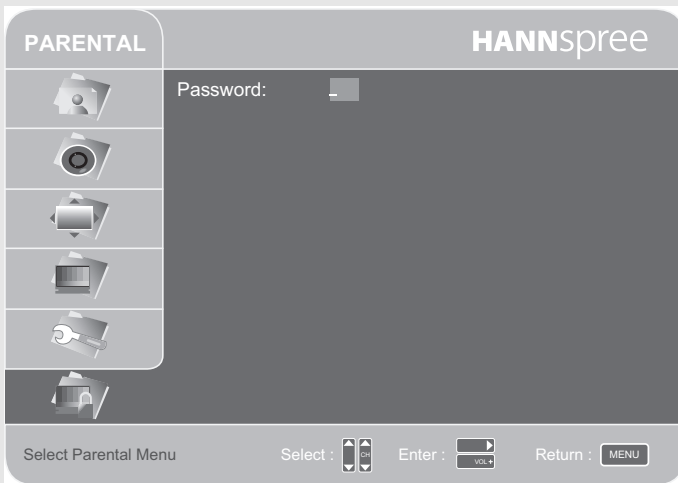

Press  to enter the OSD Main Menu screen.



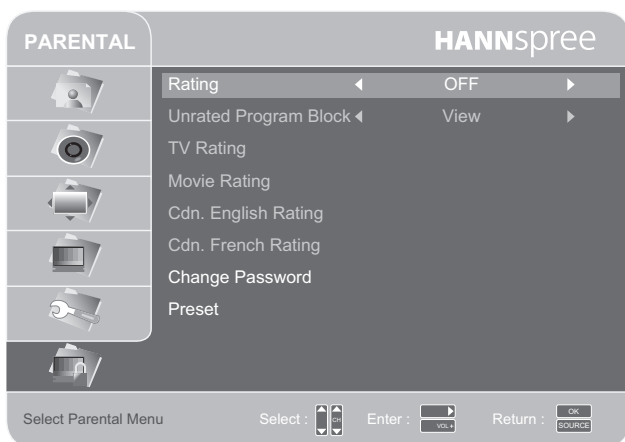

- 1 Press  or  to enter the PARENTAL Menu. You are prompted for the password:
- 2 Enter the password using the numeric keys on the remote control. The default password is 0000.
- 3 Press  to confirm if the password is correct.

4 Press   or **CH▲/CH▼** button to select an option.



5 Press  or  to change the mode setting.

6 Press  to select the changed setting and return to the PARENTAL Menu.

7 Press  to exit the PARENTAL menu.

The Parental Control Function (V-CHIP) is used to block program viewing based on the ratings sent by the broadcast stations¹. The United States has two rating systems for viewing contents, TV Parental Guidelines, and movie ratings. The TV Parental Guidelines work in conjunction with the V-CHIP to help parents screen out inappropriate television programs from their children.

Movie ratings are used for original movies rated by the Motion Picture Association of America (MPAA) as watched on cable TV and not edited for television. The V-CHIP can also be set to block MPAA-rated movies.

The Parental menu includes the following options.

Option	Description
Rating	Enables you to select a rating setting. Select Custom to customize all other settings. <ul style="list-style-type: none">• OFF• Child• Youth• Youth Adult• Custom
Unrated Program Block	Enables you to block or allow viewing of selected unrated content.

1. Parental functions are only available in the United States of America and Canada and are contingent upon the availability of the TV network programming.



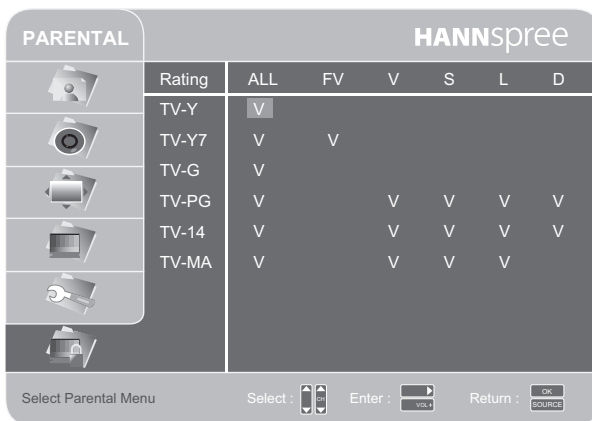

Option**Description**

Enables you to block or allow viewing of rated television content.

TV Rating



Rating	ALL	FV	V	S	L	D
TV-Y	V					
TV-Y7	V	V				
TV-G	V					
TV-PG	V		V	V	V	V
TV-14	V		V	V	V	V
TV-MA	V		V	V	V	



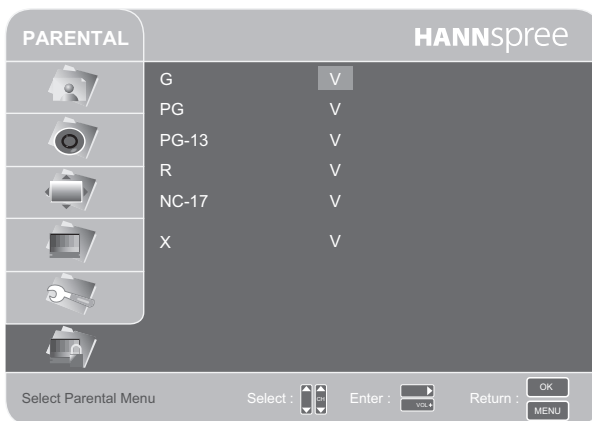

Select Parental Menu Select :   Enter :  Return : 

Enables you to block or allow viewing of rated movie content.

Movie Rating



Rating	ALL	FV	V	S	L	D
G			V			
PG			V			
PG-13			V			
R			V			
NC-17			V			
X			V			

Select Parental Menu Select :   Enter :  Return : 

Option**Description**

Enables you to block or allow viewing of content rated according to Canadian English standards.

Cdn. English Rating

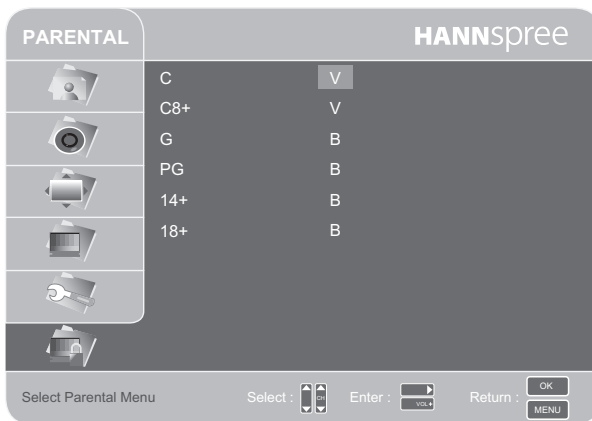

Enables you to block or allow viewing of content rated according to Canadian French standards.

Cdn. French Rating

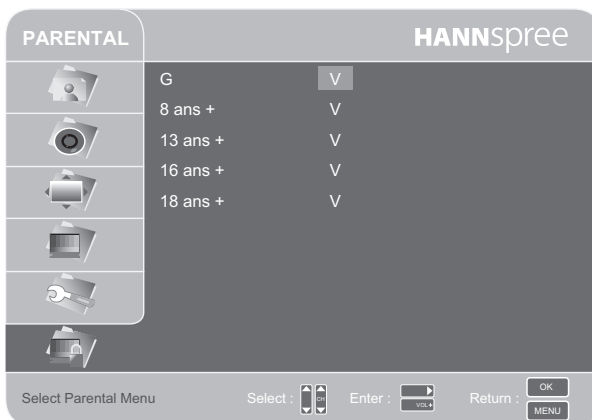

Option	Description
--------	-------------

Enables you to change the password. Enter the old password followed by the new password to change it.

Change Password

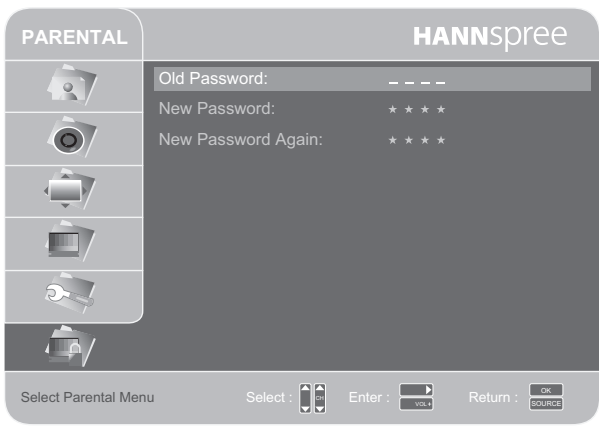

Preset	Erases all customized PARENTAL settings and return all values to factory defaults.
--------	--

Note:
The French and English ratings are for the US and Canada only.

Refer to the following table for TV rating information:

TV RATINGS	FV <i>Fantasy Violence</i>	V <i>Violence</i>	S <i>Sexual Situations</i>	L <i>Adult Language</i>	D <i>Sexually Suggestive Dialog</i>
TV-Y (All children)	☑	☑	☑	☑	☑
TV-Y7 (Directed to older children)	☒	☑	☑	☑	☑
TV-G (General audience)	–	☑	☑	☑	☑
TV-PG (Parental guidance suggested)	–	☒	☒	☒	☒
TV-14 (Parents strongly cautioned)	–	☒	☒	☒	☒
TV-MA (Mature audience only)	–	☒	☒	☒	
Block Content	☒	☒	☒	☒	☒

☑: The content rating can be set, but this rating is not normally broadcast by TV stations.

☒: The content rating can be set.

Refer to the following table for movie rating information.

MPAA RATINGS		
G	GENERAL AUDIENCES	Suitable for all ages.
PG	PARENTAL GUIDANCE SUGGESTED	Some material may not be suitable for children.
PG-13	PARENTS STRONGLY CAUTIONED	Some material may be inappropriate for children under 13.
R	RESTRICTED	Under 17 requires accompanying parent or guardian.
NC-17	NO ONE 17 OR UNDER ADMITTED	
X	NO ONE UNDER 18 ADMITTED. X is an older rating that may be used in some older movies.	

More information about the rating systems can be found by visiting these websites:

<http://www.mpa.org>

<http://www.tvguidelines.org>

Situation	Solution
No picture and sound.	<ul style="list-style-type: none"> • Connect the power cord properly. • Check if the power LED is on or not. • Press power on the control panel or remote control. • Press source to cycle through connected video sources. • Press channel up or channel down to switch to other TV stations. • Check the Air/Cable OSD settings. See “Air/Cable” on page 80. • Make sure all cables are connected properly.
No picture, or poor picture, sound is OK.	<ul style="list-style-type: none"> • Check the antenna and cable connections. • Adjust the brightness in the OSD menus. See “Brightness” on page 73.
Picture is not in color.	<ul style="list-style-type: none"> • Adjust the saturation in the OSD menus. See “Saturation” on page 73.
Picture is OK, no sound.	<ul style="list-style-type: none"> • Make sure the source device is functioning properly. • Make sure the audio cable is connected securely. • Turn the mute off. • Press volume up on the control panel or remote control.
One of the speakers has no sound.	<ul style="list-style-type: none"> • Adjust the balance in the OSD menus. See “Balance” on page 76.
Cannot receive some TV channels using cable TV.	<ul style="list-style-type: none"> • Try the Auto Program function in the OSD “TV Setting” menu. See “Auto Search” on page 80.
Want to reset TV settings.	<ul style="list-style-type: none"> • Use the Reset function in the OSD menu.
Cannot operate menus.	<ul style="list-style-type: none"> • If OSD items are colored in light blue, the system is in a state such that those settings are not available.
Forgot parental control password.	<ul style="list-style-type: none"> • Use the master password 0928

Situation	Solution
Screen image turns over.	<ul style="list-style-type: none"> • Make sure the video signal cable is connected properly.
Snow appears on the screen.	<ul style="list-style-type: none"> • Adjust the location of the antenna, placing it far from roads or sources of interference. • Check the antenna and the video signal line connections.
Blurred or overlapped images.	<ul style="list-style-type: none"> • Readjust the sharpness setting. • Choose programs with high quality signals. • Adjust the direction of the antenna or change the video signal cable.
Remote control doesn't work.	<ul style="list-style-type: none"> • Make sure the battery is inserted correctly. • Replace the battery with a new one. • Make sure the TV power cord is plugged in. • Make sure the path between the remote control and the sensor is clear. • Try operating the remote control at a closer distance to the TV. Refer to "Using the Remote Control" on page 39.

For complete warranty service information, please refer to the “Warranty and Service Manual” enclosed with your TV.

LCD Panel Size	26/32/37 inch TFT
Aspect Ratio	16:9
Best Resolution	1366 (horizontal) x 768 (vertical)
TV System	Built-In analog and digital (for US and Canada Only) TV Tuner
Video System	AV1: Composite Video (CVBS) AV2: Composite Video (CVBS + S-Video) AV3: Composite Video (S-Video) AV4/AV5: Component Video (YPbPr) VGA: PC in HDMI Ver. 1.1 E-CARD (Selected models only)
Audio System	AV1, AV2, AV3, AV4, AV5, HDMI: L/R RCA jacks (audio input) 3.5 mm earphone out PC Audio-in R/L/Subwoofer (2.1 ch out) Optical out (For built-in DTV only) E-CARD (Selected models only)
Built-in Stereo Speakers Output	26"/32" - 8 W x 2, 37" - 15 W x 2
Power Supply	100-240V, 50/60 Hz
Power Consumption	26"/32" - 200W (max.), 37" - 250W (max.)
Component Format	480i, 480p, 576i, 576p, 720p, 1080i

6.1 PC Mode Support Timing

	Pixel Format	Hor. Freq. (kHz)	Hor. Polarity	Ver. Freq. (Hz)	Vertical Polarity	Standard
1	640*480	31.47	-	60	-	VESA
2	640*480	37.861	-	72	-	VESA
3	640*480	37.5	-	75	-	VESA
4	640*480	NA	NA	85	NA	VESA
5	800*600	35.156	+	56	+	VESA
6	800*600	37.879	+	60	+	VESA
7	800*600	48.077	+	72	+	VESA
8	800*600	46.875	+	75	+	VESA
9	800*600	NA	NA	85	NA	VESA
10	1024*768	48.363	-	60	-	VESA
11	1024*768	56.476	-	70	-	VESA
12	1024*768	60.023	+	75	+	VESA
13	1280*1024	NA	NA	60	NA	VESA
14	640*400	NA	NA	70	NA	VESA
15	720*400	NA	NA	70	NA	VESA

Broadcast TV: Broadcasting video signals using high-frequency electromagnetic waves to distribute television channels to viewers (standard TV broadcast).

CATV: Community Antenna Television, the original name for cable TV. A television distribution system that uses coaxial cable instead of the traditional radio broadcasting (over-the-air) method to deliver television, FM radio, and other services to consumers.

Color Temperature: Adjusting the color temperature enables you to set the intensity of white light. Color temperature is measured in Kelvin (K). Higher color temperatures result in a blue tint. Lower temperatures result in a red tint.

Hue: Colors in a color system are measured by hue, saturation and luminance. Hue indicates the predominant color.

LCD (Liquid Crystal Display): A display technology that uses rod-shaped molecules (liquid crystals) that flow like liquid and bend light.

Saturation: Chromatic purity indicating the amount of white contained in a color. Fully saturated colors are pure colors; less saturated colors appear as pastel shades.

Stereo: The default audio signal belonging to a particular channel.

S-Video: Separate video, a video cabling standard used to transmit video by keeping brightness (Y) and color information (C) on separate channels. Most often used with camcorders.

HANNSPREE CALIFORNIA, INC.

TEL: 1-510-360-3080

Toll Free : 1-888-808-6789

FAX:1-510-360-3001

Corporate website :

<http://www.hannspree.com/us>

Service website :

<http://usservice.hannspree.net>

Service Email :

webservice_us@hannspree.com

Australia

Phone: 1-300-HANNSPREE (1-300-426677)

Corporate website :

<http://www.hannspree.com/au>

Service website :

<http://auservice.hannspree.net>

New Zealand

Phone: 0-800-HANNSPREE(0-800-426677)

Corporate website :

<http://www.hannspree.com/nz>

Service website :

<http://nzservice.hannspree.net>

Europe GmbH

TEL: +49 (0) 2154 953 23-0

FAX: +49 (0) 2154 953 23-123

Corporate website :

<http://www.hannspree.com/eu>

Service website :

<http://euservice.hannspree.net>

瀚斯寶麗股份有限公司

電話：886-2-87518000

傳真：886-2-87514755

Corporate website :

<http://www.hannspree.com/tw>

Service website :

<http://twservice.hannspree.net>

瀚斯宝丽科技(上海)有限公司

电话: +86.21.3912.6999

传真: +86.21.3912.6969

Corporate website :

<http://www.hannspree.com/cn>

Service website :

<http://cnservice.hannspree.net>

Hannspree Hong Kong Service Center

TEL: (852) 23453822

FAX: (852) 23453790

Corporate website :

<http://www.hannspree.com/hk>

Service website :

<http://hkservice.hannspree.net>

Japan

電話番号: 03.6914.5088

ファクス: 03.6914.5087

Corporate website :

<http://www.hannspree.com/jp>

Service website :

<http://jpservice.hannspree.net>

MEMO

MEMO

MEMO

Free Manuals Download Website

<http://myh66.com>

<http://usermanuals.us>

<http://www.somanuals.com>

<http://www.4manuals.cc>

<http://www.manual-lib.com>

<http://www.404manual.com>

<http://www.luxmanual.com>

<http://aubethermostatmanual.com>

Golf course search by state

<http://golfingnear.com>

Email search by domain

<http://emailbydomain.com>

Auto manuals search

<http://auto.somanuals.com>

TV manuals search

<http://tv.somanuals.com>