

Haier

Dishwasher

HDW100WHT

HDW100SST

User instructions

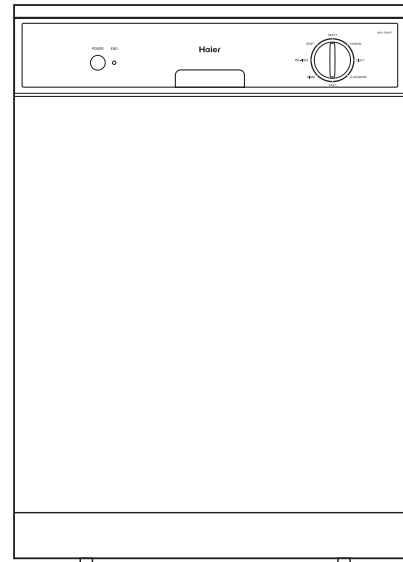

GB

Code: 0120505591

Safety Is Very Important

Carefully read the instructions contained in this manual, as it provides information that is essential to safe and proper installation, use and maintenance of this appliance.

- Carefully remove and dispose of the packing material.
- Check to make sure that the appliance is not damaged. If in doubt, contact the retailer it was purchased from.
- This dishwasher is designed for washing household dishes and cooking utensils.
- Do not install this appliance outdoors, even if a roof covers the area.
- Do not lean or sit on the door when it is open, as it may over turn the dishwasher.
- Do not touch the heating element during or after a wash cycle.
- If the appliance malfunctions, turn off water supply to the appliance and disconnect the plug from the wall socket and refer to the section entitled, "Troubleshooting". If you cannot solve the problem, contact an authorised service centre/agent.
- Only selected service centres/agents are authorised to make repairs.
- If the supply cord is damaged, it must be replaced by the manufacture, a service agent of similar qualified persons in order to avoid a hazard.

- The appliance is not instruct for use of young children of infirm persons without supervision. Young children should be supervised to ensure that they do not play with the appliance.
- Dishwasher detergents are strongly alkaline. They can be extremely dangerous if swallowed. Avoid contact with the skin and eyes and keep children away from the dishwasher when the door is open. Check that the detergent receptacle is empty after completion of the wash cycle.
- Do not use extension cords or multiple sockets.
- The plug must be accessible after installation.
- During installation the power cord must not be bent or flattened excessively.
- If the appliance is not operating properly, disconnect the appliance from the power supply.

Warning: Dishwasher detergents can be extremely dangerous if swallowed. Avoid contact with skin, eyes and keep children away from the dishwasher when the door is open. Check that the detergent receptacle is empty after completion of the wash cycle.

To maintain the EFFICIENCY and SAFETY of this appliance:

- Only call a authorised service centre.
- Always use original Spare Parts.
- Children and infirm must be supervised at all times during use of the dishwasher by an adult.

Close-up View (Control Panel)

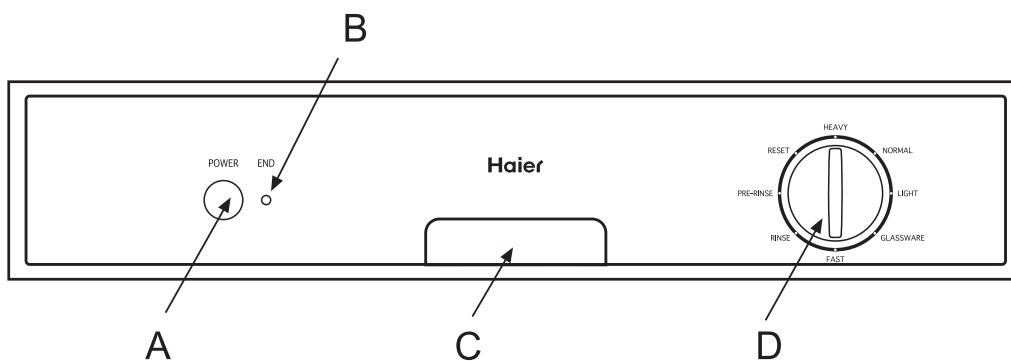

A "POWER" Button

B "END" Light

C Handle For Opening Door

D Knob For Selecting Cycle

Close-up View (Interior)



A Upper Rack
B Rack Height Adjustor
C Top Spray Arm
D Lower Rack

E Bottom Spray Arm
F Washing Filter
G Detergent and Rinse Aid Dispenser

Technical Characteristics

Width	60 cm
Depth	60 cm
Height	85 cm
Capacity	12 standard place settings
Mains water pressure	0.03-1 MPa
Power voltage	220-240V~ 50Hz
Total absorber power	2100W

Detergent and Rinse Aid.....

Detergent

Detergent specifically intended for use with dishwashers must be used. The dispenser must be refilled before the start of each wash cycle following the instructions provided in the "Wash Cycle Table." The detergent dispenser is located on the inside panel the door.

Loading the detergent

To open the "A" cover on the dispenser, press the "B" button. The detergent for the wash cycle should be poured into the "C" compartment. The detergent for the pre-wash cycle should be poured into the "D" compartment.

After the detergent has been placed in the dispenser, close the cover and press down until it clicks in place.

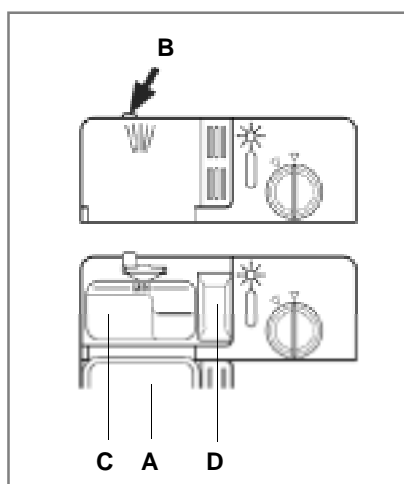

Notice:

To facilitate closing the cover, remove any excess detergent on the edges of the dispenser.

Dishwasher detergents are strongly alkaline. They can be extremely dangerous if swallowed. Avoid contact with the skin and eyes and keep children away from the dishwasher when the door is open. Check that the detergent receptacle is empty after completion of the wash cycle.

Rinse Aid

This product makes dishes sparkle and helps them to dry without spotting. The dispenser is located on the inside panel of the door and should be filled after every 80 wash cycle (or when the rinse aid indicator light comes on for models with this feature).

Loading the Rinse Aid

To open the dispenser, turn the "C" cap in an anti-clockwise direction and then pour in the rinse aid, making sure not to overfill. The amount of rinse aid used for each cycle, turn the dosage adjuster "F", beneath the cap, with a screwdriver. There are 6 different settings; the normal dosage setting is 3.

Important

Proper dosage of the rinse aid improves drying.

If drops of water remain on the dishes or spotting occurs, the dosage adjuster should be turned to a higher setting.

If the dishes have white streaks, turn the dosage adjuster to a lower setting.

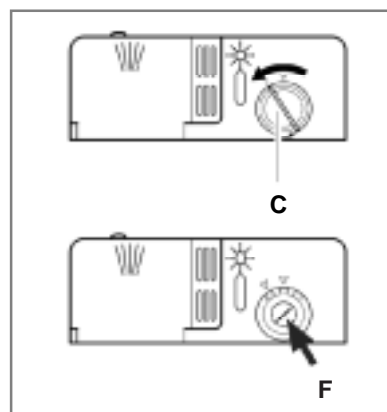

Loading the Dishwasher

Before placing the dishes in the dishwasher, remove the larger food particles to prevent the filter from becoming clogged.

If the pots and pans have baked-on food that is extremely hard to remove, we recommend they are soaked before washing. This will eliminate the need for extra wash cycles.

Pull out the rack to load the dishwasher.

The lower rack

Place the most difficult to clean items on the bottom rack: pots, pans, lids, serving dishes and bowls.

It is preferable to place serving dishes and lids on the sides of the racks in order to avoid blocking the rotation of the top spray arm.

- Pots, serving bowls, etc. must always be placed face down.
- Deep pots should be tilted to allow the water to flow out.

The upper rack

The upper rack is designed to hold more delicate and lighter dishes, such as glasses, cups and saucers, plates and small bowls.

- Position the dishes so that they do not move by the spray of the water.

To adjust the height of the upper rack, rotate the caps located on the end of the rack guide rails to the side, remove the rack completely and refit using the alternate set of wheels (see fig.D).

Adjust the upper basket to the higher level to allow more height in the bottom basket for large items.

Information on comparability tests implemented in compliance with AS/NZS 2007

Appliance loaded in accordance with standard specifications.

Example of loaded dishwasher: See fig. A and B.

Capacity: 12 place settings

Comparability programme: NORMAL wash

Rinse-aid setting: 5

Detergent: 25+5g

Height-adjustable top-basket must be inserted in the uppermost position.

If the comparability tests do not comply fully with AS/NZS 2007, e.g., degree of soiling, type of dishes

and cutlery, etc., contact the appliance manufacturer before starting the test.

Lower Rack

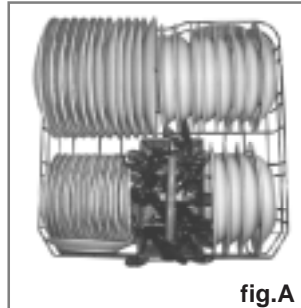

fig.A

Upper Rack

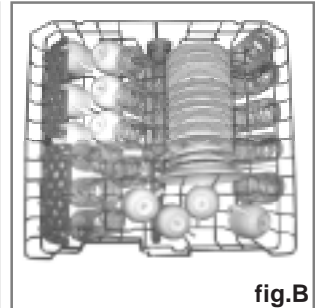

fig.B

Load for 12 Standard Settings



fig.C

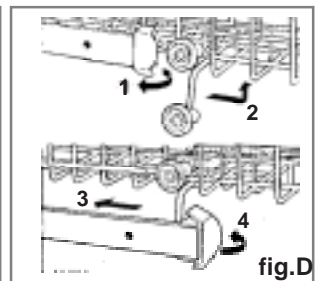

fig.D

Turning on the Appliance

Starting a wash cycle...

- Make sure that the plug for the appliance is inserted into the wall socket.
- Make sure that the water supply is turned on to full pressure.
- Load the dishes.
- Pour in the detergent.
- Press the "POWER" button, and the "END" light will turn on.
- Turn the knob located on the right of the control panel until the number or symbol for the cycle setting is aligned with the reference mark (see the section entitled, program overview). If the knob is correctly aligned with the reference mark you want to choose, you must turn the knob to with the mark of "RESET" . Then back to first step.
- After five seconds the "END" light will turn off, the wash cycle will begin.

At the end of the wash cycle...

When the buzzer constantly beeps six times, the "END" light will turn on and the cycle has finished. Turn off the appliance using the "POWER" button, turn off the water supply and open the door of the dishwasher.

Wait a few minutes before unloading the dishwasher to avoid handling the dishes and utensils while they are still hot and more susceptible to breakage. They will also dry better.

Cancelling or modifying a wash cycle setting...

A cycle that is underway can only be modified if it has been running for a short time. Otherwise, the detergent may have already been used, and the appliance may have already drained the wash water. If this is the case, the detergent dispenser must be refilled (see the paragraph entitled, "Loading the Detergent"). Rotate the knob to the mark of "RESET" then select right programme.

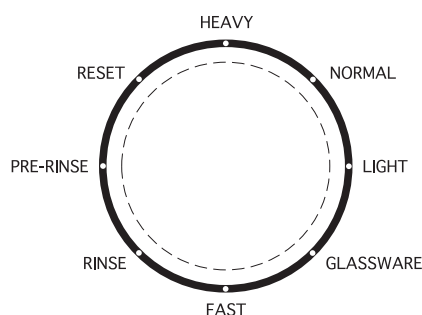

Energy Saving Tips

- It is important to try and run the dishwasher when it is fully loaded to save on energy.
- Rather than run a full cycle for a half load, you can run the "PRE-RINSE" cycle which will prevent odours from forming and food from caking onto the dishes.
- Choose the right wash cycle: the choice of cycle depends on the type of dishware, cookware and utensils being washed and how dirty they are.
- Use the right amount of detergent: if you use too much detergent, the result will not be cleaner dishes, but, rather, a greater negative impact on the environment.

How to Keep Your Dishwasher in Shape

After Every Wash

After every wash, turn off the water supply to the appliance and leave the door slightly ajar so that moisture and odors are not trapped inside.

Remove the Plug

Before cleaning or performing maintenance, always remove the plug from the socket.

Solvents or Abrasive Cleaning Products

Do not use solvents or abrasive cleaning products to clean the exterior and rubber parts of the dishwasher, use only a cloth and warm soapy water.

To remove spots or stains from the surface of the interior, use a cloth dampened with water and a little white vinegar, or a cleaning product made specifically for dishwashers.

Moving the Appliance

If the appliance must be moved, try to keep it in the vertical position. If absolutely necessary, it can be laid on its back.

DO NOT LAY THE MACHINE ON ITS RIGHT HAND SIDE

Seals

One of the reasons that odours form in the dishwasher is that food get trapped in the seals. Periodic cleaning with a sponge will prevent this.

When You Go on Holiday

When you go on holiday, it is recommended that you run a wash cycle with the dishwasher empty and then remove the plug from the socket, turn off the water supply and leave the door of the appliance slightly ajar. This will help the seals last longer and prevent odours from forming.

Wash Cycle Table

Wash programme	Types of load	Description of cycle	Detergent		Rinse Aid
			Prewash	Extended Wash	
HEAVY	Very dirty dishes, pots and pans. (Not to be used with delicate items.)	Pre-wash with hot water. Extended wash at 70°C. Rinse with cold water. Rinse with hot water. Drying.	5g	25g	●
NORMAL (AS/NZS 2007)	Normal load of dirty dishes, pots and pans, Standard daily cycle.	Prewash use cold water. Extended wash at 50°C. Rinse with cold water. Rinse with hot water. Drying.	5g	25g	● (*)
LIGHT	Lightly soiled delicate items.	Prewash use cold water. Extended wash at 50°C. Rinse with cold water. Rinse with hot water. Drying.	5g	25g	●
GLASSWARE	Economic cycle for delicate items. Run immediately after dishes are used.	Wash at 45°C. Rinse with cold water. Hot rinse. Drying.	—	25g	●
FAST	Very lightly soiled mixed dishes.	Short wash at 40°C. Cold rinse.	—	15g	●
RINSE	For dishes that only require a rinse and dry.	Hot rinse at 65°C. Drying.	—	15g	●
PRE-RINSE	Pre-rinse of dishes while waiting for a full load.	Short cold wash to prevent food residue from drying on the dishes .	—	—	—

(*) AS/NZS 2007 test with rinse aid setting 5

Cleaning and Special Maintenance

Filter Assembly

For the best performance and results, the filter assembly must be kept clean.

The filter removes food particles from the wash water, allowing the water to be recirculated during the cycle. For this reason, it is a good idea to remove any food particles trapped in the filter after each wash cycle by rinsing the semi-circular filter and cup ("A") under running water. To remove the filter assembly, pull the handle in an upward direction. The entire filter assembly (made up of the semicircular filter "A" and the fine filter "B") should be cleaned at least once a month use a soft brush. To reassemble, insert the entire assembly into the dishwasher, locate it correctly in its seat and pressing downward.

The dishwasher must not be used without the filters. Improper replacement of the filters may reduce the performance of the appliance.

Cleaning the Spray Arms

Food particles may become encrusted on the spray arms and block the hole (see "Close up view [interior]" on page 3, letters C-E). Check the spray arms periodically and clean them when needed.

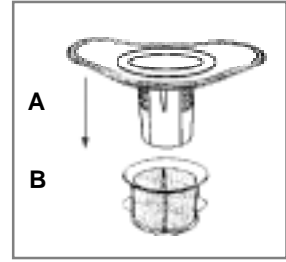
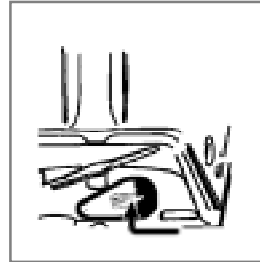

Troubleshooting

Resolving minor problems yourself

Experience has shown that you can resolve most problems that arise during normal daily usage yourself, without having to call out a service engineer. Not only does this save costs, but it also means that the appliance is available for use again that much sooner. The following list of common occurrences and their remedies should help you identify the causes of most problems.

Problems...

...when the appliance is switched on

Appliance does not start up

- Fault with fuse in mains electricity supply.
- Plug not inserted in wall socket.
- Appliance door not closed properly.
- Knob stay at the mark of "RESET"
- Water tap not turned on.
- Blocked strainer in water intake hose.
 - The strainer is situated in the Aquastop or supply-hose connection.



Caution

Do not forget that repairs should only be carried out by a qualified specialist. Improper repairs can lead to considerable equipment damage as well as danger to the user.

...with the appliance itself

When the alarm sounds in a series of 2 beeps, pause, 2 beeps, pause ...

- the water is turned on and the hose is connected properly;
- the water supply to the house is on and has sufficient pressure;
- the water supply hose is crimped or bent;
- the filter for the water supply hose is clogged.
- the drain hose is too low.

When the alarm sounds in a series of 3 beeps, pause, 3 beeps, pause ...

- the drain hose is crimped or bent.
- the drain hose is too high.

When the alarm sounds in a series of 4 beeps, pause, 4 beeps, pause ...

- Temperature sensor failed and call your Authorised Service Center.

When the alarm sounds in a series of 5 beeps, pause, 5 beeps, pause ...

- Flood switch has been activated and call your Authorised Service centre.

When the alarm sounds in a series of 6 beeps, pause, 6 beeps, pause ...

- the drain hose is too low.

When the "END" indicator is on, at the moment, the alarm sounds in a series of 7 beeps, pause, 7 beeps, pause ...

- the door is not properly closed.

If you take all these checks and the dishwasher still does not function or your dishwasher have any other error display, you can power the dishwasher OFF, and wait a few minutes. You can power the dishwasher on, try it again, if the dishwasher still does not function and/or the problem persists, contact the nearest authorised service center and provide them with the following information:

- the nature of the problem.
- the model type number (Mod...) And the serial number (S/N...), which are indicated on the plate located on the side of the inner part of the door.

Lower spray arm rotates with difficulty

- Spray arm is blocked by small items or food remains.

Troubleshooting

Lid in detergent compartment cannot be closed

- Detergent compartment has been overfilled.
- Mechanism is clogged with remnants of detergent.

Remnants of detergent stuck inside dispenser

- Compartment was damp when it was filled up with detergent. Compartment must be dry before detergent is added.

Water remains inside appliance after programme has ended

- Blockage or kind in drainage hose.
- Pump is jammed.
- Filters are blocked.
- The programme is still running. Wait for the programme to end.

...during washing

Unusual amount of foam is created

- Normal washing up liquid has been poured into the rinse-aid container.
- Remove any spilled rinse aid with a cloth as it could otherwise lead to excessive foaming during the next washing cycle.

Appliance stops suddenly while washing is taking place

- Cut off electricity supply to appliance.
- Water supply has been interrupted.

Knocking sound can be heard while washing is taking place

- A spray arm is knocking against the dishes inside the appliance.

Rattling sound can be heard while washing is taking place

- Crockery has not been stacked properly inside the appliance.

Knocking sound coming from inlet valves

- This is caused by the way the water pipes have been laid and it has no effect upon the way the appliance functions. There is no remedy for this.

...with the dishes, cutlery, etc.

Remnants of food are stuck to the dishes, cutlery, etc.

- Dishwasher was not loaded properly. Jets of water could not reach all parts of the dishes, etc.
- Too many items in the rack.
- Items in the rack were touching each other.
- Not enough detergent was added to dispenser.
- Selected wash programme was not intensive enough.
- Rotation of spray arm was obstructed by dishes, etc.
- Nozzles in spray arm are blocked by remnants of food.
- Filters are blocked.
- Filters have been incorrectly fitted.
- Waste-water pump is jammed.

Plastic items are discoloured

- Not enough detergent was added to dispenser.
- Detergent has insufficient bleaching properties. Use a detergent containing a chemical bleaching agent.

White stains are left on crockery, glasses have a milky appearance

- Not enough detergent was added to dispenser compartment.
- Amount of rinse-aid was set too low.
- Although water is quite hard, no salt has been put in appliance.
- Water softener was set too low.
- If you used a phosphate-free detergent, try a detergent containing phosphates and compare results.

Dishes, cutlery, etc. have not been dried

- Selected programme did not include drying function.
- Amount of rinse-aid was set too low.
- Items were removed from dishwasher too soon.

Glasses have a dull appearance

- Amount of rinse-aid was set too low.

Tea stains or traces of lipstick have not been completely removed

- Detergent does not have a sufficient bleaching effect.
- Washing temperature was set too low.

Traces of rust on cutlery

- Cutlery is not sufficiently rustproof.

Glasses become clouded and discoloured; coating cannot be wiped off

- Unsuitable detergent was used.
- Glasses are not dishwasher-proof.

Smears left behind on glasses and cutlery; glasses have acquired a metallic appearance

- Amount of rinse-aid set too high.

Installation

Positioning the Appliance

Position the appliance in the desired location. The dishwasher is equipped with water supply and drain hoses that can be positioned to the right or left to allow correct installation.

Levelling the Appliance

Once the appliance is positioned, adjust the feet by screwing them in or out. The appliance should not be inclined more than 2 degrees, to ensure proper performance.

Cold Water Connection

Connect the cold water supply hose to a threaded 3/4 bsp connector and make sure that it is fastened tightly (see fig.1).

If the water pipes are new or have not been used for an extended period of time, let the water run first, till it is clear and free of impurities. Otherwise the water inlet filter may get blocked.

Hot Water Connection

The appliance can also be connected to the house's hot water supply following the same procedure as for the cold water connection.

DO NOT CONNECT TO A PUSH THROUGH HOT WATER SYSTEM OR ONE THAT EXCEEDS A TEMPERATURE OF 60°C.

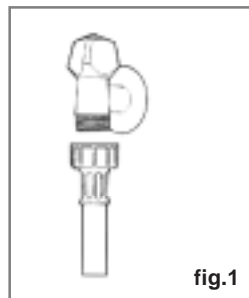

Drain Hose Connection

Insert the drain hose into a drain pipe with a minimum diameter of 40mm, or let it run into the sink. Use the plastic support that comes with the appliance (see fig .2) and ensure there are no tight bends or kinks. The free end of the hose must be at a height between 40 and 100 cm and must not be immersed in water.

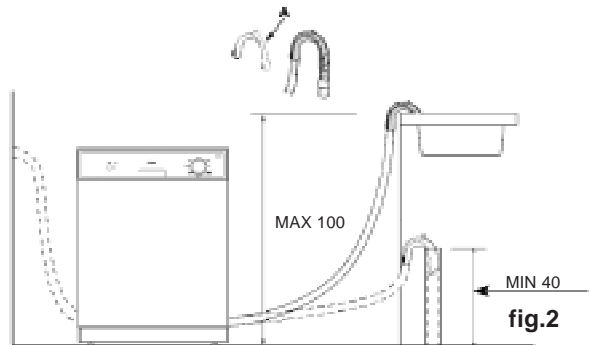

Attention:

The plastic hose support must be fastened to the wall to prevent the drain hose from moving.

Electrical Connection

After making sure that the voltage and frequency in the home correspond to those on the rating plate of the appliance (located on the side of the stainless steel inner door) and that the electrical system can cope with the maximum voltage on the rating plate, insert the plug into an earthed electrical socket.

DO NOT USE ADAPTORS OR EXTENSION LEADS.

Installation

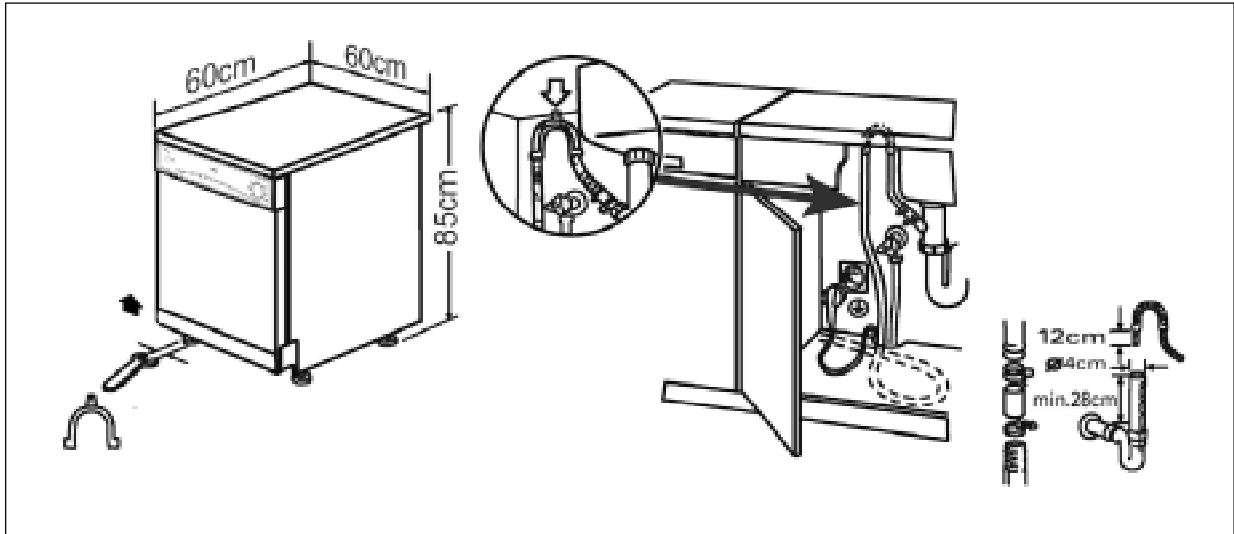

Diagram

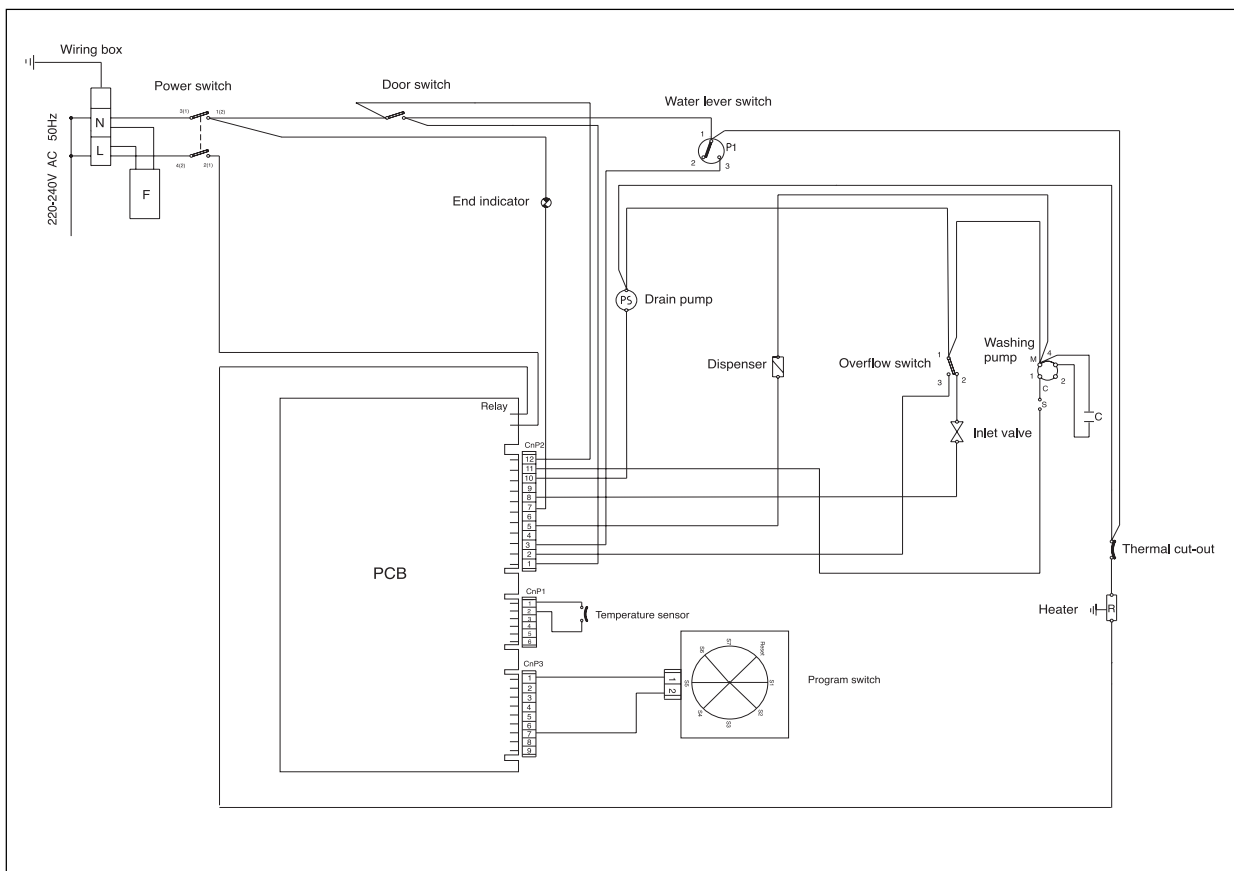

Free Manuals Download Website

<http://myh66.com>

<http://usermanuals.us>

<http://www.somanuals.com>

<http://www.4manuals.cc>

<http://www.manual-lib.com>

<http://www.404manual.com>

<http://www.luxmanual.com>

<http://aubethermostatmanual.com>

Golf course search by state

<http://golfingnear.com>

Email search by domain

<http://emailbydomain.com>

Auto manuals search

<http://auto.somanuals.com>

TV manuals search

<http://tv.somanuals.com>