

# Table of Contents

<b>Characteristic Functions</b>	1
<b>Important Safety Instructions</b>	2
<b>Technical Specifications</b>	5
The Technical Specifications for Final Product	5
Technical Specifications for TV	6
VGA Display Mode	6
Power Management	6
Packing Listing	6
<b>Installation &amp; Connection</b>	7
Antenna Connection	7
Power Connection	8
Computer Connection	8
HDMI digital port Connection	8
AV1 Video Signal Connection	9
AV2 Video Signal Connection	10
YPbPr/YCbCr Input Connection	11
<b>Position of Control Keys</b>	12
<b>Remote Control</b>	13
<b>Basic Operation Instruction</b>	15
Power On	15
Standby	15
Signal Source Selection	15
Menu Operation Instruction	15
PICTURE	16
SOUND	17
OSD	18
ADVANCE	18
TV	19
<b>Simple Troubleshooting</b>	22

# Characteristic Functions

1. LCD panel with no glint and low radiation can ease eyes' fatigue and protect eyes.
2. High-quality LCD panel is adopted with high brightness, high contrast, wide viewing angle, and super fast response time. Super fast response time can greatly eliminate the shadow of moving images.
3. TV/Monitor with two in one and multiple input ports can easily switch among the Modes.
4. De-interlacing image disposal is adopted. Today's most advanced technique for movement compensation, can completely improve the saw tooth and vague edges of the athletic picture.
5. There are four smart sound modes and four smart image modes.
6. Dynamic contrast technology can obviously improve the definition and contrast of the picture
7. Tuner for frequency synthesis can support full auto search and manual search.
8. With perfect timing function, you can set time to turn off. It will be turned off in state of no signals, too.
9. Auto Adjustment can help you to setup the image into the best performance in a few seconds instead of complicated adjustment in PC mode.
10. Auto color balance adjustment technology can make the machine to reach the best color setting in PC mode.
11. Support hi-definition YPbPr and double HDMI.
12. All functions can be realized with remote control, which is really a convenient operation.
13. Power is designed to save energy. The standby power consumption is less than 1.5W.
14. Input ports include VGA, YPbPr, HDMI, S-Video, CVBS, USB and TV.
15. Output ports include AV and Earphone.
16. Support USB interface, you can look through picture of JPG format and play music files of Mp3 format.

# Important Safety Instructions

Thank you to choose the LCD TV made by our company, a valuable product with excellent quality and multiple functions. This machine will bring you more audiovisual enjoyment. Its design can insure user's safety. All machine are strictly tested before leaving factory. But incorrect use can lead to electric shock or fire. In order to insure safety and extend its life, please read below regulations carefully before using it and comply with the following safety instructions.

- When the following troubles occur, please pull out the plug and call the professional engineers to repair.

- A. The cable or plug is damaged.
- B. The product was fallen down or the case is damaged.
- C. Obvious abnormal situation occurs. In spite of correct operation according to the user manual but it still can't work normally.
- D. Some abnormal substances or liquid fall into it.
- E. Unusual sound or smell sends out.

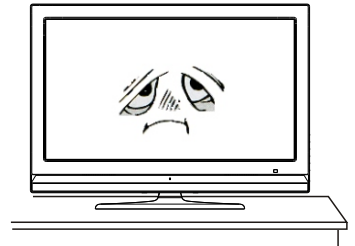

- There is high voltage inside the machine but no parts which can be repaired by users themselves. In order to assure the people's safety, please do not open the case to repair it by yourself. If it is needed to repair, please contact qualified engineer to repair.

- Please put this machine in the place of well ventilation, instead of extremely hot, cool or moist, and direct sunlight.

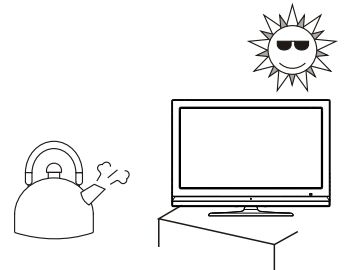

- The slots on the case is designed to release heat so as to assure that all inside components will not reach an extra high temperature and can work normally for a long time. Please do not cover the holes while place it.

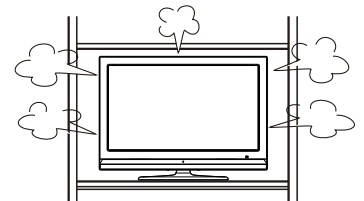

- Unless there is good ventilation installation, please do not put this machine in inlaid device.

- Please do not place it on an unstable position so as to avoid falling off.



- Do not place the LCD TV near water source, like a bathtub, pool, washing machine, or moist

# Important Safety Instructions

cellar and similar environment.

- During a thunder rain weather, do not touch the power cord and antenna cable. Please pull out the power line and aerial plugs for preventing thunder and lightning damage to this machine.

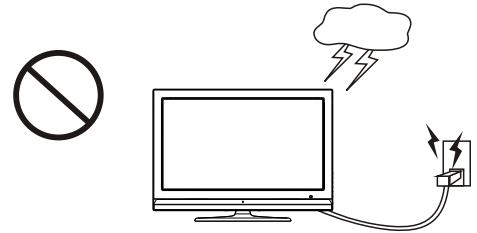

- All cables can be connected or pull out only after power supply is turned off.

- The power cord must be taken off before you clean the machine. Do not use the liquid cleanser or aerosol cleanser. It is recommended to use a wet soft cloth to clean the machine. Do not use the alcohol, impregnant or ammoniac liquid to wipe the screen.

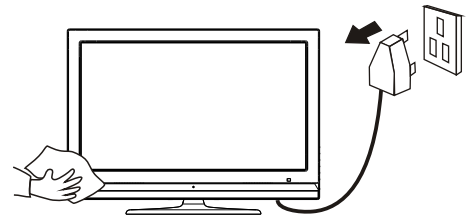

- If you will not use the machine for a long time, please pull out the power cord. Do not keep the sleeping mode for too long time.
- Read the manual and marking label before using the machine, and keep the user manual for later use.
- Don't use the attachments which are not recommended by the machine manufacturer as they may cause hazards.
- The power cord must be placed correctly so as to avoid be trample or crush.
- Please do not make the power socket overloaded or the power cord extended. Otherwise it will cause fire or electrical shock.
- The LCD panel is fragile and expensive. The surface of the panel is easy to be scratched. Please do not use the hard thing to knock, press, score the panel. Otherwise it will be harmful for the panel. The exchange cost is very high.
- All technical specification on this instruction book and outer package are subject to change without notice. If the instruction book has slight difference with actual operation, please take the actual operation as standard.

# Important Safety Instructions

- When the MAINS plug or an appliance coupler is used as the disconnect device, the disconnect device shall remain readily operable.
- The machine should not suffer from waterdrop or watersplash, do not place the vessel with water (or other liquids) on it, for like this it is possibly to cause fire or electric shock.
- The attaching plug should be inserted into the power point completely, otherwise it may cause spark to bring fire.
- Please do not put candle, ash-tray, incense, inflammables or explosive nearby this machine.
- Please do not stretch into any sharp object, metal or liquid, or touch the signal attachment or the inner of radiation hole, in order to avoid short circuit and product damage, or possibly causing electric shock. Especially pay attention when there are children on the spot.
- Please do not use the machine immediately when moving the machine from low temperature place to high temperature one, or install and use at the place of facing air conditioning, otherwise it may cause the condensation in the machine, to cause fault.
- Must be careful when moving this machine, avoiding being struck, especially pay attention to protect the screen part. In addition, if using handcart, must note the injury as the product is overturned from the handcart because of hard braking, overexerting and uneven ground.

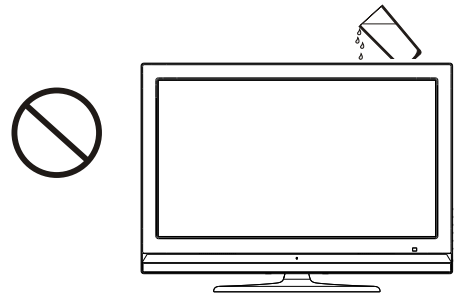

# Technical Specifications

## The Technical Specifications for Final Product

Panel size	26"	32"
Max. Resolution	1366×768	1366×768
Best Resolution	1360×768@60Hz	1360×768@60Hz
Pixel Pitch	0.4215mm×0.4215mm	0.51075mm×0.51075mm
Active Area	575.770mm×323.710mm	697.6845mm×392.256mm
Color	16.7M	16.7M
Panel Surface Disposal	Anti Glare	Anti Glare
Power Supply	100V-240VAC 60/50Hz	100V-240VAC 60/50Hz
Power Consumption of Speaker	10W+10W	10W+10W
Control Area of Remote Control	≥8M±30°	≥8M±30°
Operating Environment		
Temperature	5°C ~ 40°C	5°C ~ 40°C
Humidity	10%~85%	10%~85%
Atmosphere Pressure	86kpa-104kpa	86kpa-104kpa
Storage Environment:		
Temperature	-20°C ~55°C	-20°C ~55°C
Humidity	5%~95%	5%~95%
Atmosphere Pressure	86kpa-104kpa	86kpa-104kpa
Dimension (L×H×W)		
Unpacking: Excluding base	652×449×104mm	786×531×110mm
Including base	652×498×104mm	786×577×110mm
Packing	770×570×200mm	900×660×220mm
Weight		
Net Weight	10.5Kg	12.5Kg
Gross Weight	12.5Kg	16.0Kg

# Technical Specifications

## Technical Specifications for TV

1. Supported Systems: PAL+SECAM or PAL+NTSC
2. Storage channels: 199
3. TV(RF): 75Ω Imbalance
4. AV Video-Input: 75Ω, 1VP-P, RCA
5. AV Audio-Input: 20KΩ, 500mV RMS
6. YPbPr/HDMI Video Input: 480i, 480p, 576i, 576p, 720p, 1080i, 1080p

## VGA Display Mode

No.	Mode	Resolution	Refresh
1	VGA	720X400	70Hz
		640X480	60Hz
2	SVGA	800X600	60Hz
3	XGA	1024X768	60Hz
4	WXGA	1360X768	60Hz

**Note:** Recommended mode: 1360X768@60Hz

## Power Management

This product is complied with EPA Energy Star Standard and compatible with VESA DPMS Standard. Details are listed as follows:

Mode	LED Indicator	Power Consumption
On	Off	≤140W (26")
		≤170W (32")
Standby	Lighting	≤1.5W

**Note:** All the specifications in the user manual or on the packing carton may be changed without additional notice.

## Packing Listing

1. LCD TV (Excluding base subassembly)
2. User Manual
3. Power Cable (or the machine itself has power cable)
4. Remote Control

# Installation & Connection

## Antenna Connection

It is better to use outdoor antenna or CATV cable if you want to watch the colorful and hi-definition pictures.

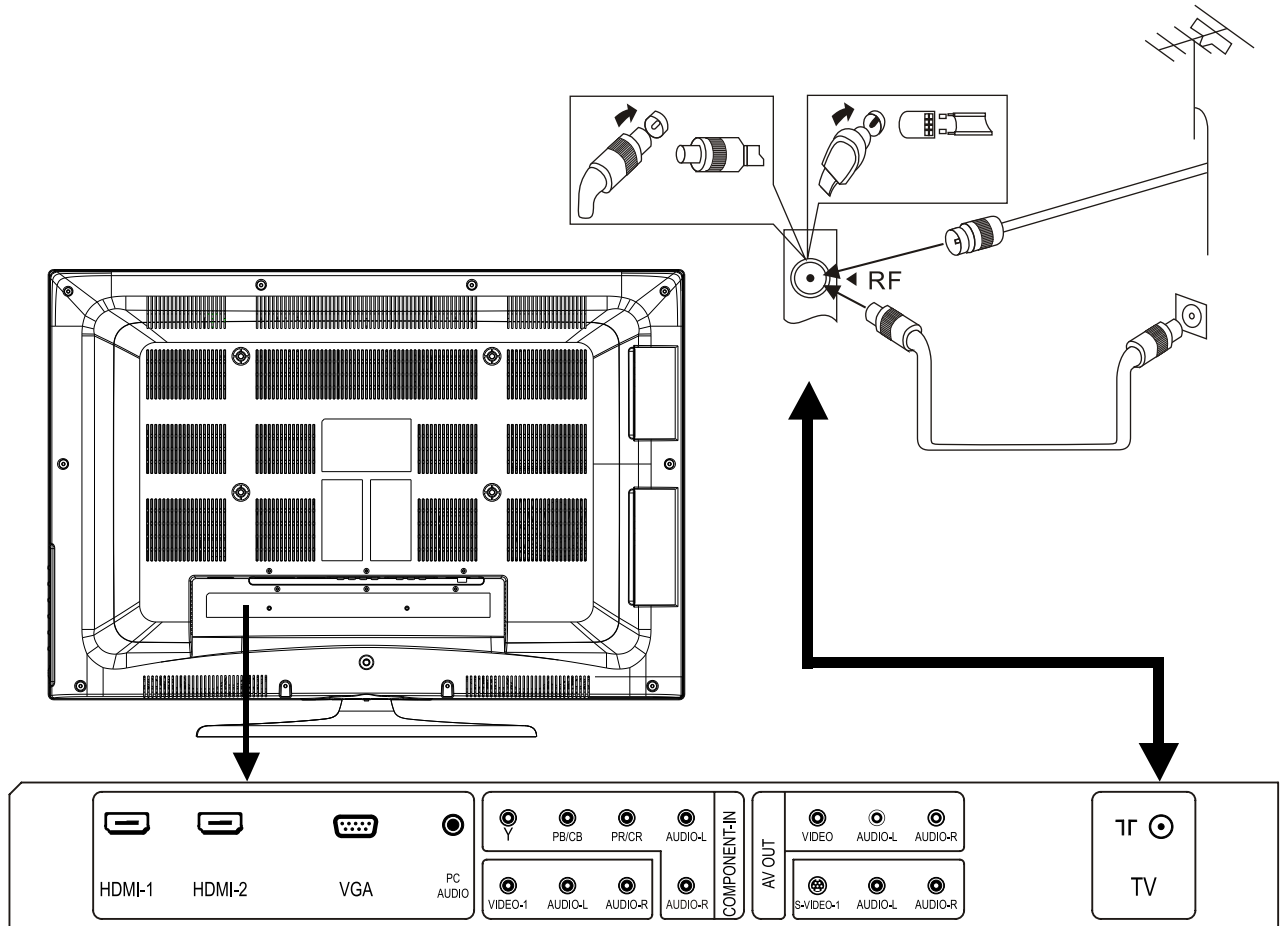

### Attention:

Please turn off TV power before the outdoor antenna is connected to the TV signal input port. Outdoor antenna can't be located near the high voltage cables. Please pull out the plug of outdoor antenna to avoid thunder shock in thunder weather.



# Installation & Connection

## Power Connection

Notes:

1. This machine uses AC 100-240V, 60/50Hz.
2. If a long time at leisure, please disconnect it from power supply.

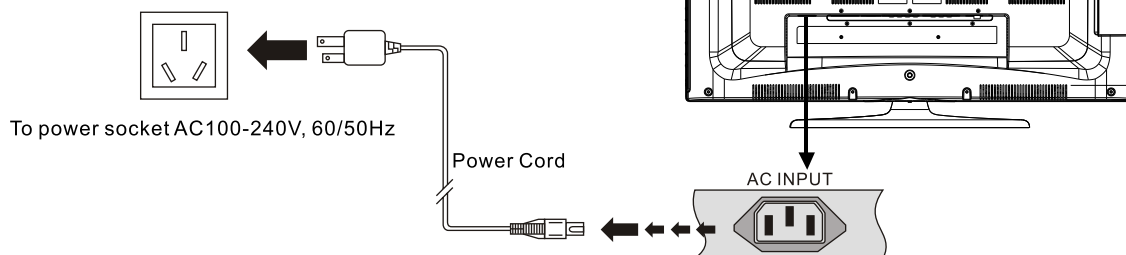

## Computer Connection

Please connect one end of VGA cord with the output port of the computer (available for both desktop or laptop computer), and another end of VGA cord with the input port of the VGA on its rear cover.

## HDMI digital port Connection

Connect external HDMI high signal source to HDMI digital input port of this machine through HDMI digital connector cable; push "SOURCE" button to select "HDMI" signal source.

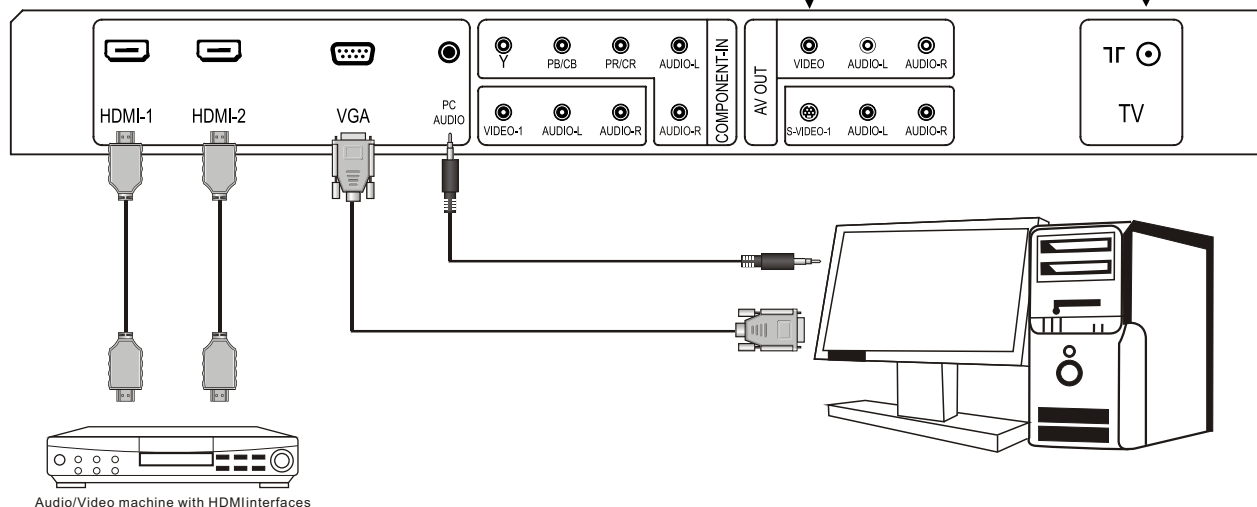
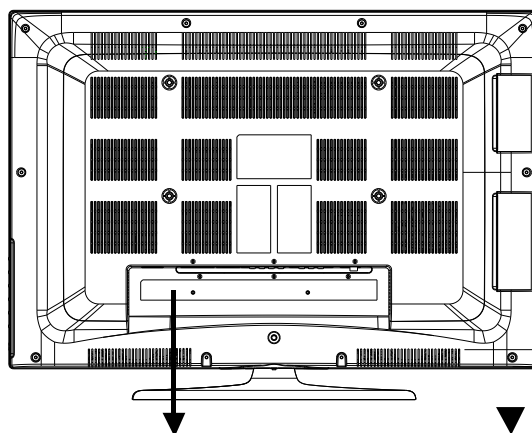

# Installation & Connection

## AV1 Video Signal Connection

Through composite cable, connect AV equipment VIDEO output termination to this machine VIDEO input, and AV equipment AUDIO output termination to this machine AUDIO input, respectively.

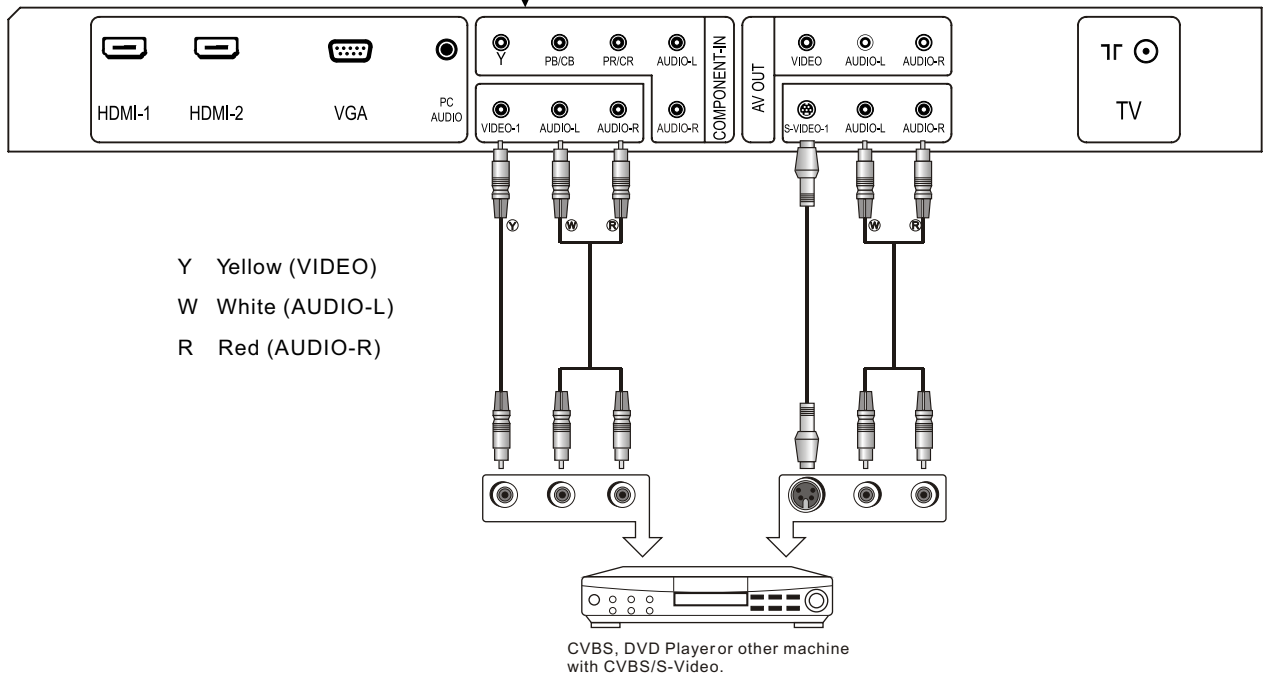
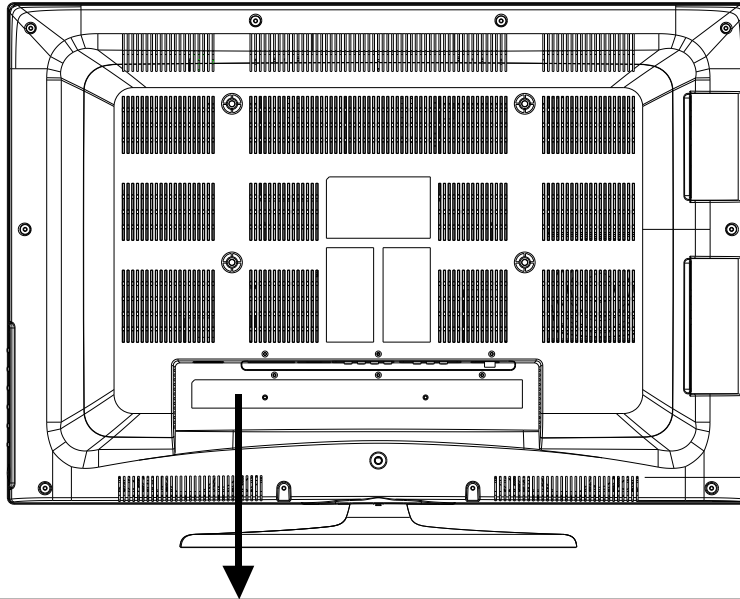

# Installation & Connection

## AV2 Video Signal Connection

For easy connection to AV Video Signal, there are a group of AV Video Signal input ports on the down part on the left side of the machine. The connection method is the same as AV1.

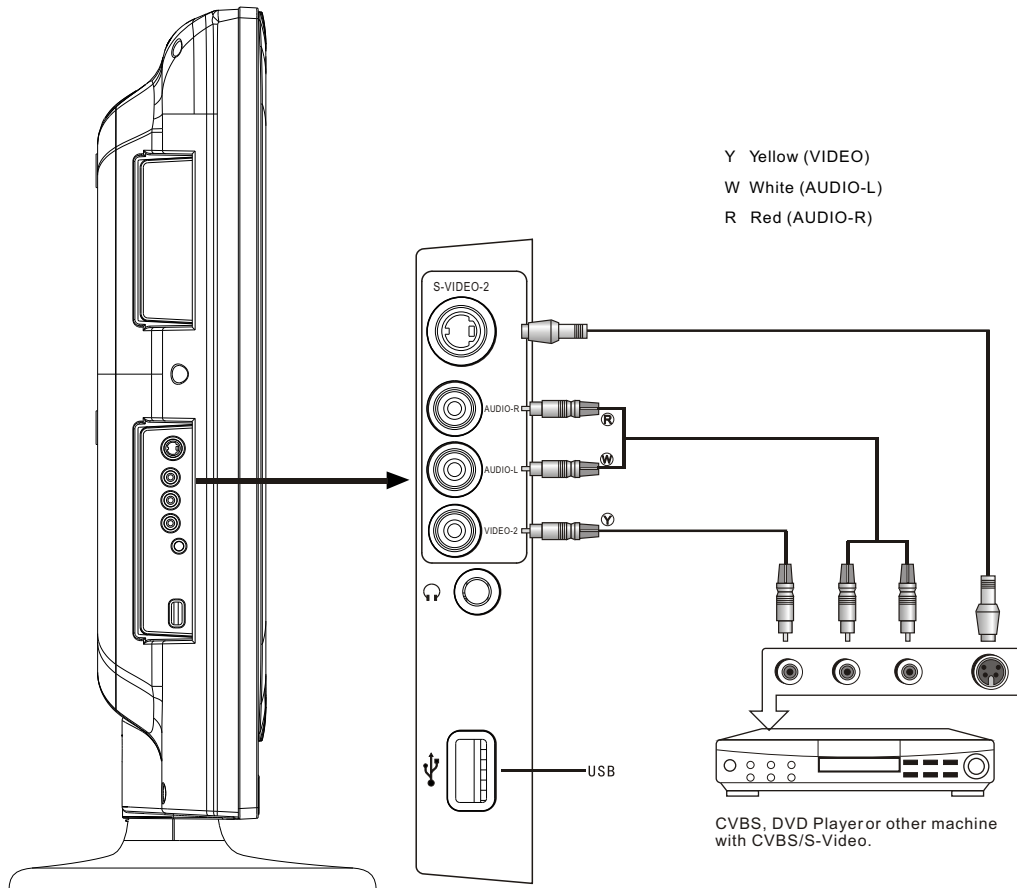

**Earphone Socket:** The TV speakers will be shut off when earphone is inserted into this socket.

# Installation & Connection

## YPbPr/YCbCr Input Connection

If the signal source is DVD, Digital wired receiver or equipments with the YPbPr/YCbCr output, recommends you to connect YPbPr or YCbCr output with the TV YPbPr/YCbCr input. In order to obtain the better picture quality, at the same time, please connect its audio output with TV audio input as shown in the following chart. If you choose the YPbPr/YCbCr signal, please set signal source selection under YPbPr pattern.

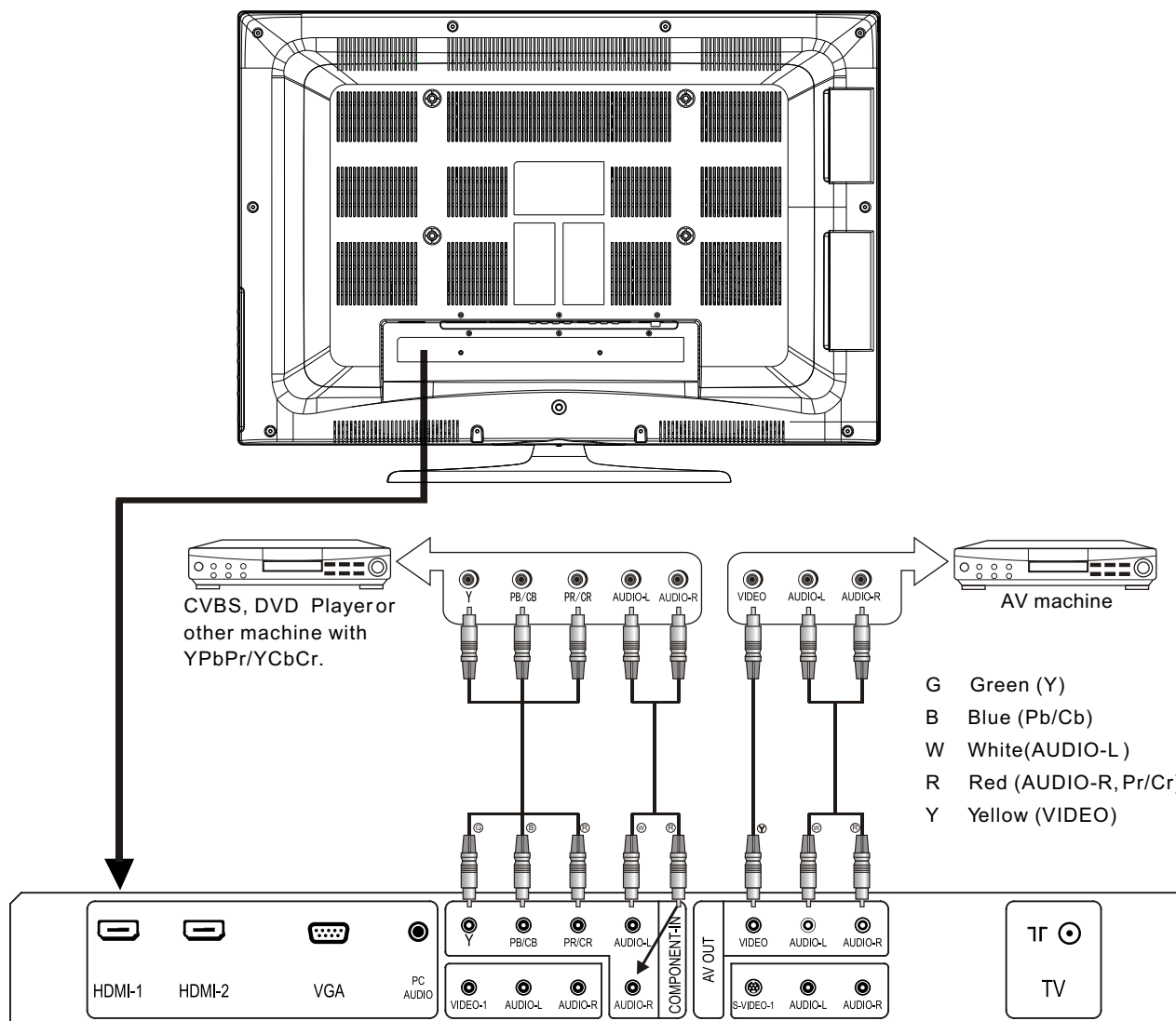

# Position of Control Keys

## Front Panel Control Keys

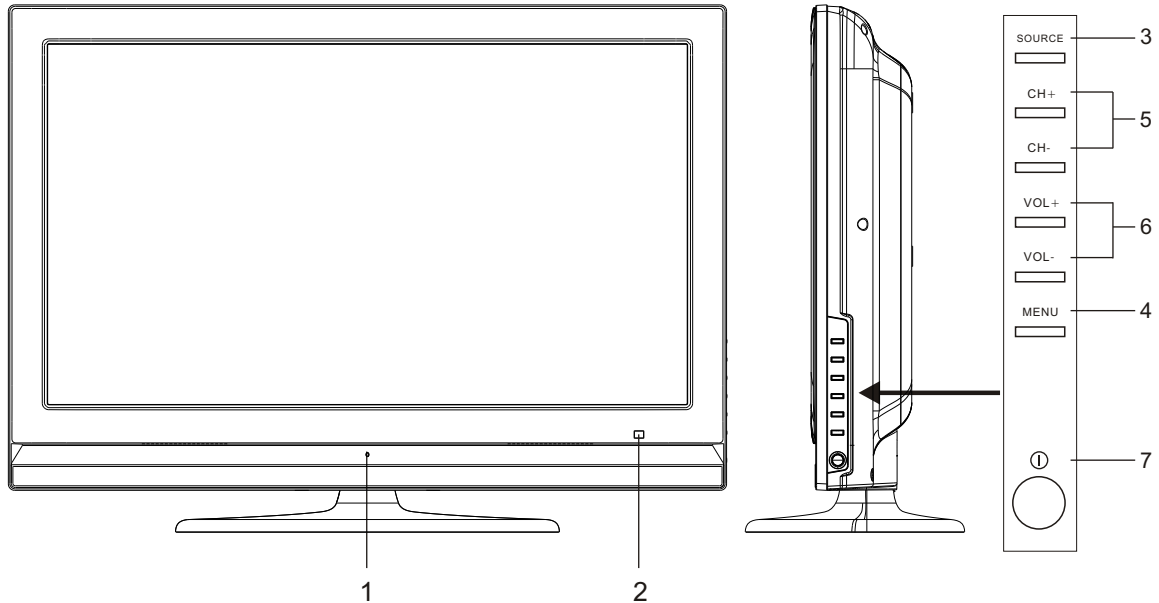

- 1) Power Indicator
- 2) Remote Receiving Sensor
- 3) SOURCE: Press this key to enter the menu of signal source and choose signal source.
- 4) MENU: Press this key to enter main menu
- 5) CH+/CH-: Press these two keys to select the channel, and adjust the options you need under OSD operation.
- 6) VOL+/VOL-: Press these two keys to add or reduce volume, and adjust the analog value under OSD operation.
- 7) Ⓜ Power On/Off

**Note:** There are some apparent differences between modes, please according to practicality.

# Remote Control

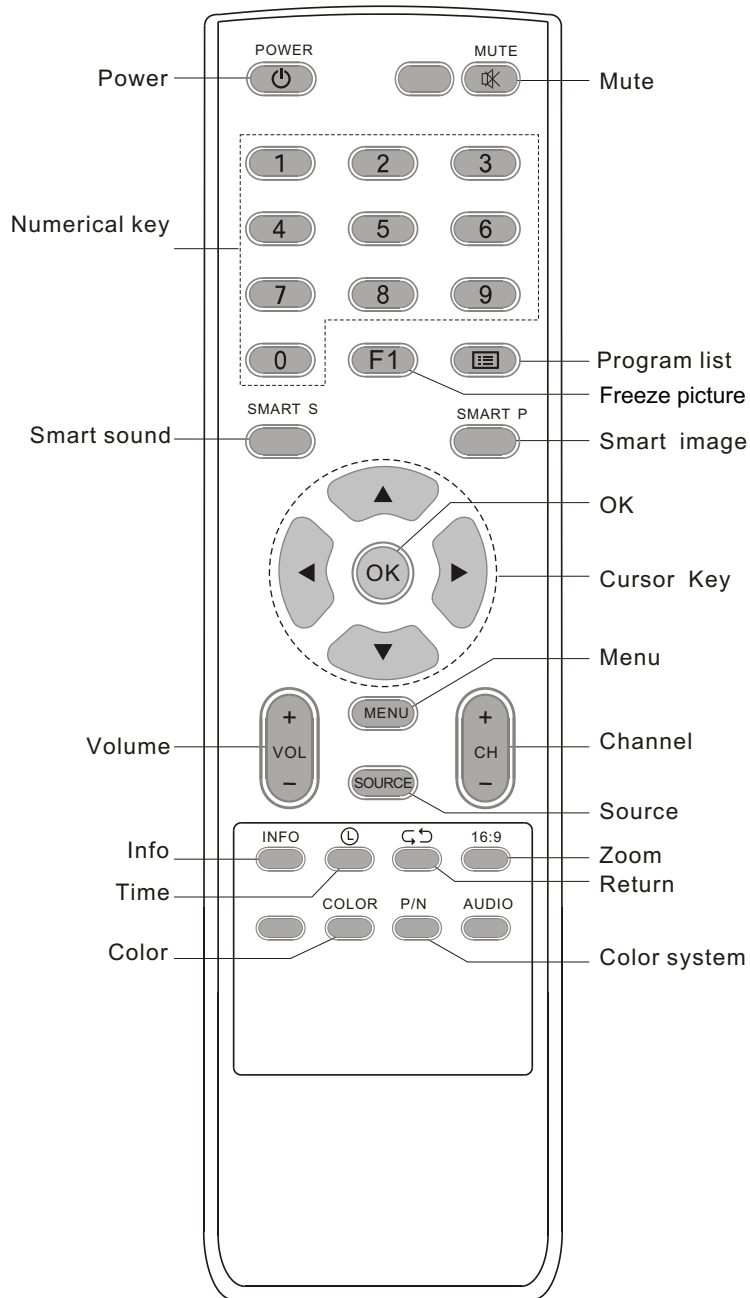

## Telecontrol battery installation method

Take off the cover of battery box, fix two AAA batteries with 1.5 volt, and conform with the polarity of remote control battery box.

**Note:** Appearance of the remote control may be different from this picture, please according to practicality.

# Remote Control

## Remote Control Key Instruction

Key	Function
POWER	Turn on or standby
MUTE	Eliminate sound
Numerical key	Number input button
F1	Freeze picture
Program list	Look through or edit Program list
MENU	Press this button to display menu
SMART S	Intelligent sound mode selection: STANDARD, NEWS, MUSIC, PERSONAL
SMART P	Intelligent image mode selection: STANDARD, DYNAMIC, SOFT, PERSONAL
SOURCE	Press this button to display signal source selection menu
Cursor key	Up or Down cursor button: function select Left or right cursor button: analog add or reduce
VOL+/VOL-	Sound volume add or reduce button
CH+/CH-	Select channel Number
INFO	System information display switch
Time	Timer setting button, press this key can set time of turning down. ▶OFF ▶15 ▶30 ▶45 ▶60 ▶120 ◻
Return	Press this button to return to last watching channel
16:9	"FULL", "MOVIE", "CAPTION", "4:3", "PANORAMA"
Color	Color temperature mode selection button: Normal, Warm, Cool
P/N	Color system mode selection button: PAL, NTSC(SECAM), Auto
AUDIO	Optional
OK	Confirm operation

### Precautions for use of remote control:

1. When using remote control you should point it to the remote-control inductive window. The goods between remote control and inductive window may hinder normal operation.
2. Do not cause the remote control to receive fierce vibration. In addition, do not set or place the remote control under direct sunlight, for the thermal energy will cause the distortion of remote control.
3. When remote-control inductive window of main machine is under direct sunlight or intense illumination, the remote control may malfunction, by now, please change the angle of illumination or this machine, or approach the inductive window to operate the remote control.
4. When the battery voltage is insufficiency it influences the remote control distance, you should replace with new battery; when not to use the remote control for long or the battery is exhausted, please take out the battery, in order to avoid bringing the battery leakage to corrode the remote control and thus cause it out of commission.
5. Do not use different batteries. The mix use of new and old batteries is not allowed, you should use battery pair.
6. Do not throw battery into fire, charge or disassembly, especially do not charge, assemble and disassemble, heat or burn to the used battery. Please observe the related environmental protection stipulation on wasted battery.

# Basic Operation Instruction

## Power On

Plug power cord into the electrical socket and press "ⓘ" key on the front panel, then press "Power" key on the remote control to turn on the TV.

## Standby

Press "Power" key on the remote control. TV will be in standby.

### ★Special Attention:

1. TV set will automatically turn to standby if there is no signal input for 5 minutes when TV turns on.
2. TV set will automatically turn to standby when the preset time of turning off reaches.

## Signal Source Selection

Press "SOURCE" key either on the remote control or on the front panel. "MENU OF SIGNAL SOURCE" will be displayed on the screen. Then press "Up/Down" key on remote control or "CH+/CH-" key on the front panel to choose the signal source such as TV, AV1, AV2, S-VIDEO1, S-VIDEO2, YPBPR, HDMI1, HDMI2, PC, USB. Press "OK" key on the remote control or "MENU" key on the front panel and TV will switch the current signal source to the signal source you choose.

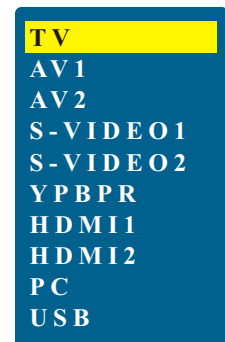

## Menu Operation Instruction

Press "MENU" key on the remote control or on the front panel. The TV will display the main menu.

1. Press "Left/Right" key on the remote control or "VOL+/VOL-" key on the front panel to select the adjustment sort menu, which includes 5 sorts: PICTURE, SOUND, OSD, ADVANCE, TV.
2. Press "Down" key on the remote control or "CH-" on the front panel to enter the adjustment sort menu.
3. Press "Up/Down" key on the remote control or "CH+/CH-" on the front panel to select what is needed to adjust in sort menu.
4. Press "Left/Right" key on the remote control or "VOL+/VOL-" on the front panel to adjust the value or setting.
5. Press "Menu" key to exit the main menu when the TV displays the Main Menu; Press "Menu" key to return to previous menu when the TV displays the submenu;

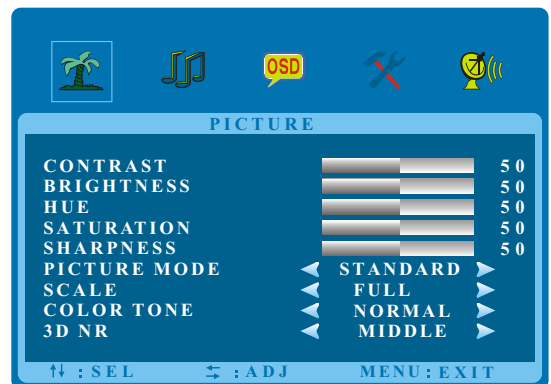



# Basic Operation Instruction

Press "Source"key to display the signal source menu or exit signal source menu.

- During the operation, the selections which can not be adjusted at current mode will be hidden automatically and the color of the selections will be changed into gray.
- Menu Operation Instruction in this manual is explained according to TV mode. The operations in other modes are similar to the one in TV mode. Users can take it as reference.

## PICTURE

Select  to enter the PICTURE submenu. Press "Up/Down" key on the remote control or "CH+/CH-" key on the front panel to choose what you need. Press the "Left/Right" key on the remote control or the "VOL+/VOL-" key on the front panel to adjust analog value or state (see below table).



### ★Special Attention

- The Hue function is available only for NTSC system.
- The value adjusted by user, such as Contrast, Brightness, Saturation, Hue, and Sharpness will be saved automatically by the machine as personal mode.

### ★Remote Control Shortcut Keys

SMART P: Press SMART P key on the remote control. You can switch the function among the "STANDARD", "DYNAMIC", "SOFT", "PERSONAL" four modes .

16:9: Press 16:9 key on the remote control, you can switch the mode among the "FULL", "MOVIE", "CAPTION", "4:3", "PANORAMA" five modes.

Option	Function	Description
CONTRAST	Adjust the contrast of whole picture	Increasing analog value increases Contrast; Decreasing analog value decreases Contrast(0-100).
BRIGHTNESS	Adjust brightness and blackness of whole picture	Increasing analog value increases brightness; Decreasing analog value decreases brightness(0-100).
HUE	Adjust the hue of whole picture	Increasing analog value increases green; Decreasing analog value increases purple(0-100).
SATURATION	Adjust the saturation of whole picture	Increasing analog value increases color; Decreasing analog value decreases color (0-100).
SHARPNESS	Adjust the sharpness of whole picture	Increasing analog value increases definition; Decreasing analog value decreases definition (0-100).
PICTURE MODE	Select picture mode	"STANDARD", "DYNAMIC", "SOFT", "PERSONAL" four modes.
SCALE	Select picture scale	"FULL", "MOVIE", "CAPTION", "4:3", "PANORAMA",
COLOR TONE	Select color temperature mode of the picture	There are three Color Temperature modes, "NORMAL", "WARM", "COOL".
3D NR	Select model of 3D NR	"MIDDLE", "STRONG", "WEAK", "OFF".

# Basic Operation Instruction

## SOUND

Select  to enter the SOUND submenu. Press " Up/Down " key on the remote control or the key "CH+/CH-" on the front panel to choose what you need. Press the "Left / Right" key on the remote control or the "VOL+/VOL-" key on the front panel to adjust analog value or state (see below table).



### ★Special Attention

1. Normally, 50 value of adjustment is recommended;
2. The treble or bass analog value which is adjusted by the users will be saved as the personal mode by the machine

### ★Remote Control Shortcut Keys

**SMART S:** Press SMART S key on the remote control. You can switch the function among the, "STANDARD", "NEWS", "MUSIC", "PERSONAL" four modes.

**MUTE:** Open or close sound.

**VOL+/VOL-:** Add or reduce volume.

Option	Function	Description
BASS	Adjust bass value	Increasing analog value increases bass; Decreasing analog value decreases bass (0-100).
TREBLE	Adjust treble value	Increasing analog value increases treble; Decreasing analog value decreases treble (0-100).
BALANCE	Adjust balance of left or right sound	Increasing analog value decreasing left volume; Decreasing analog value decreases right volume(0-100).
SOUND MODE	Adjust audio effect mode	"STANDARD", "NEWS", "MUSIC", "PERSONAL" four modes.

# Basic Operation Instruction

## OSD

Select  to enter the OSD submenu. Press "Up/Down" key on the remote control or "CH+/CH-" key on the front panel to choose what you need. Press the "Left/Right" key on the remote control or the "VOL+/VOL-" key on the front panel to adjust analog value or state (see below table).



Option	Function	Description
OSD-H POSITION	Adjust H-position of OSD menu	Increasing analog value, OSD menu move toward right; Decreasing analog value, OSD menu move toward left (0-100).
OSD-V POSITION	Adjust V-position of OSD menu	Increasing analog value, OSD menu move toward down; Decreasing analog value, OSD menu move toward up (0-100).
OSD-DURATION	Adjust duration of OSD menu	Increasing analog value, extend duration time of OSD menu; (5-60).
OSD-HALFTONE	Adjust halftone of OSD menu	Increasing analog value increases halftone; Decreasing analog value decreases halftone (0-100).
OSD LANGUAGE	Choose OSD menu display language	There are many languages to select

## ADVANCE

Select  to enter the ADVANCE submenu. Press "Up/Down" key on the remote control or "CH+/CH-" key on the front panel to choose what you need. Press the "Left/Right" key on the remote control or the "VOL+/VOL-" key on the front panel to adjust analog value or state (see below table).

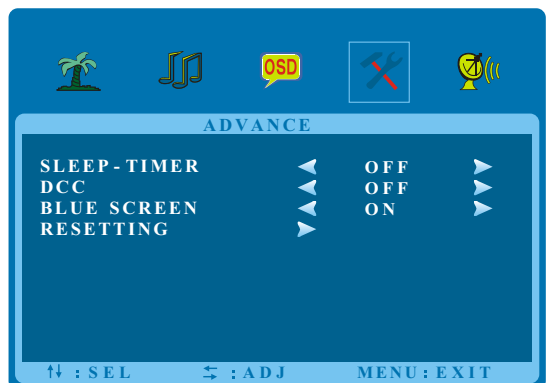

Option	Function	Description
SLEEP - TIMER	Set sleep time of the machine	"Off, 15M, 30M, 45M, 60M, 120M", unit: minute.
DCC	Open or close DCC	"ON/OFF", two states.
BLUE SCREEN	Open or close BLUE SCREEN	"ON/OFF", two states.
RESETTING	Resume to setting of factory	Reset all values to setting of factory.

# Basic Operation Instruction

## TV

Select  to enter the TV submenu. Press "Up/Down" key on the remote control or "CH+/CH-" key on the front panel to choose what you need. Press the "Left/Right" key on the remote control or the "VOL+/VOL-" key on the front panel to adjust analog value or state (see below table).

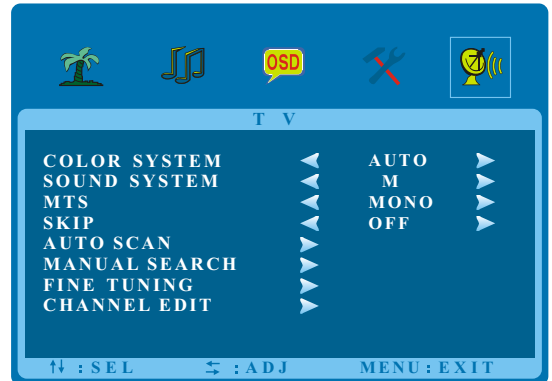

Option	Function	Description
COLOR SYSTEM	Select color system	"PAL, NTSC, AUTO" three modes.
SOUND SYSTEM	Select sound system	"I, D/K, M, AUTO, B/G" five modes.
MTS	Select MTS modes	"STEREO, MONO, DUAL I , DUAL II " four modes.
SKIP	Select skip or not	"ON/OFF" two states.
AUTO SCAN	Select auto scan	Please refer to "AUTO SCAN"
MANUAL SEARCH	Select manual search	Please refer to "MANUAL SEARCH"
FINE TUNING	Select fine tuning	Please refer to "FINE TUNING"
CHANNEL EDIT	Select channel edit	Please refer to "CHANNEL EDIT"

### AUTO SCAN

Select  to enter the submenu of TV. Then press "Up/Down" key on the remote control or "CH+/CH-" on the front panel to select "AUTO SCAN". The machine perform search after pressing "Right "key on the remote control or "VOL+" on the front panel. (In the process of searching the channel automatically, press the key of "MENU" on the remote control to stop searching). Meanwhile, it will show Current Channel, Frequency. All of the TV programs will be saved automatically.



### MANUAL SEARCH

Select  to enter the submenu of TV. Then press "Up/Down" key on the remote control or "CH+/ CH-" on the front panel to select "MANUAL SEARCH". Then press the key of "Right" on the remote control or "VOL+" on the front panel to enter submenu of MANUAL SEARCH. Press "Left/Right" key on the remote control or "VOL+/VOL-" on the front panel to select channel No.. Press "Up/Down" key on the remote control to select "SEARCH ", press "Left/Right" key on the remote control again, the machine begin searching toward low frequency or high frequency. (In the process of searching the channel automatically, press the key of "MENU" on the remote control to stop searching).



# Basic Operation Instruction

## FINE TUNING

Select  to enter the submenu of TV. Then press "Up /Down" key on the remote control or "CH+/ CH-" on the front panel to select "FINE TUNING". Press "Right" key on the remote control to enter submenu of "FINE TUNING". Press "Left/Right" key on the remote control to adjust from low frequency or high frequency.



## CHANNEL EDIT

Select  to enter the submenu of TV. Then press "Up/Down" key on the remote control or "CH+/CH-" on the front panel to select "CHANNEL EDIT". Press "Right" key on the remote control to enter submenu of "CHANNEL EDIT" (Press program list key on the remote control to enter submenu of "CHANNEL EDIT").

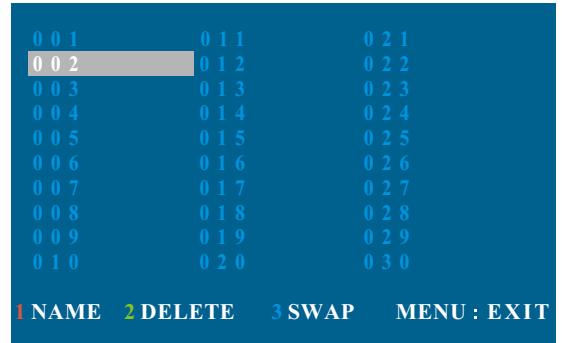

**NAME:** Press "Cursor" key on the remote control to select channel. Press "1" key on the remote control to name. Press "UP/Down" key on the remote Control to select letter or number. Press "Left/Right " key on the remote control to move digit and then press "UP/Down" key on the remote control to select letter or number. Press "1" key on the remote control to confirm.

**DELETE:** Press "Cursor" key on the remote control to select channel which you wish delete. Press "2" key on the remote control, and then press "1" to confirm.

**SWAP:** Press "Cursor" key on the remote control to select channel which you wish change name's position, press "3" key on the remote control, then press "UP/Down" key on the remote control to select channel, press "1" to confirm.

## Select Channels with "CH+/CH-" Key

Press Program key on the remote control or "CH+/ CH-" key on the front panel to select the channels.

Select channels with the Return key you can go to the last channel when pressing the Return key. For example, if the last channel is 10 and the current channel is 20, you will go to channel 10 when pressing the Return key. You can switch the two favourite channels as you like.

# Basic Operation Instruction

## Select Channels with Numeric Keys

1. Operations to select channels with 1 digit (0-9):  
Press the number keys (0-9) on the remote control to select TV channel directly.
2. Operations to select channels with 2 digits (10-99):  
Press the number keys with 2 digits (10-99) on the remote control to select TV channels.
3. Operations to select channels with 3 digits (100-199):  
Press the number keys with 3 digits (100-199) on the remote control to select TV channels.

**Note: With the mode of AV1, AV2, S-VIDEO1, S-VIDEO2, YPBPR, HDMI1, HDMI2, PC all functions and adjustments are similar with TV. User can check it at convenience. HDMI connector can realize DVI connector function with external HDMI/DVI commutator.**

## USB signal source operation

please insert USB memory card into USB interface of TV, press "source" key on the remote control or front panel to select USB signal source (if you don't insert the USB memory card into USB interface of TV, operation is invalid), press "OK" key to enter.

Notice: This USB interface only support move U dish, can't connect move hard drive, also can't connect to USB interface of computer. USB support file format with Mp3/ JPG. It isn't compatible with some of move U dishes, please replace move U dish.

# Simple Troubleshooting

Symptom	Factor	Solution
Snowflake speckle and sound noise.	<ol style="list-style-type: none"> <li>1. Antenna cable connector is loose, cable is damaged.</li> <li>2. Channel setting is incorrect.</li> <li>3. Antenna cable type is not matching.</li> <li>4. Direction or position of antenna cable is incorrect.</li> <li>5. Signal is weak.</li> </ol>	<ol style="list-style-type: none"> <li>1. Check the antenna cable connector plug whether or not loose, cable whether or not perfect.</li> <li>2. Refer to channel setting method, resetting again.</li> <li>3. Check antenna cable type (VHF/UHF)</li> <li>4. Adjust direction or position of antenna cable.</li> <li>5. Attempt to use signal amplifier.</li> </ol>
TV image is better, but has noise.	TV system setting is incorrect.	Enter to "TV" menu, reset sound system again.
No image. No sound.	Power plug is loose, power cord don't connect well.	<ol style="list-style-type: none"> <li>1. Check power cord whether or not connect well.</li> <li>2. Check if "Ⓜ" on the front panel is on.</li> <li>3. Press "power" on the remote control.</li> </ol>
TV image have stripe.	Signal is exposed to disturb, such as car, neon light, electric blower etc.	Don't use electric blower around machine, adjust antenna cable direction to reduce disturb.
TV image have shadow.	<ol style="list-style-type: none"> <li>1. TV signal is reflected by valley or building.</li> <li>2. Toward direction of antenna cable is incorrect.</li> </ol>	<ol style="list-style-type: none"> <li>1. Use high directional antenna cable. Use FINE TUNING of "TV".</li> <li>2. Adjust toward direction of antenna cable.</li> </ol>
No color.	<ol style="list-style-type: none"> <li>1. Color saturation is too low.</li> <li>2. Color system is incorrect.</li> </ol>	<ol style="list-style-type: none"> <li>1. Enter "PICTURE" to add up color saturation.</li> <li>2. Enter "TV" to change color system.</li> </ol>
TV no sound.	<ol style="list-style-type: none"> <li>1. Volume setting is too low.</li> <li>2. Sound is muted.</li> <li>3. Sound system is incorrect.</li> </ol>	<ol style="list-style-type: none"> <li>1. Adjust volume to proper value.</li> <li>2. Press "MUTE" button on remote control to eliminate mute.</li> <li>3. Enter "TV" to change sound system.</li> </ol>
Computer no display, and prompt no signal input, red indicator LED twinkling.	Signal cable is loose or fall off.	Check signal cable whether or not loose, fall off, reconnect well again.
Remote control distance is short, lose control.	<ol style="list-style-type: none"> <li>1. Receive window of remote continue was covered by objects.</li> <li>2. The battery energy of remote control is too low.</li> </ol>	<ol style="list-style-type: none"> <li>1. Remove objects, avoiding cover the receive window of remote control.</li> <li>2. Change battery.</li> </ol>
Computer display faintly.	<ol style="list-style-type: none"> <li>1. Adjustment is incorrect.</li> <li>2. Display mode is incorrect.</li> </ol>	<ol style="list-style-type: none"> <li>1. Use auto-adjustment function.</li> <li>2. Use commend mode.</li> </ol>
Computer display image excursion, not full screen, over screen.	<ol style="list-style-type: none"> <li>1. Adjustment is incorrect.</li> <li>2. Display mode is incorrect.</li> </ol>	<ol style="list-style-type: none"> <li>1. Use auto-adjustment function.</li> <li>2. Enter "GEOMETRY" to adjust horizontal or vertical position.</li> <li>3. Use recommended mode.</li> </ol>
Noise Signals at turning off.	Electrical release at turning off.	It is normal.
Can not operate this machine.	Exterior influence, for example lightning, static electricity and so on, which are possibly to disturb the normal operation of this machine.	Press "Ⓜ" button on the front panel to turn off electrical source, then press "Ⓜ" button to turn on the TV again after 1-2 minutes.

**CAUTION:** Don't let your machine display the same picture for a long time, please set up a screen protection procedure. If a high contrast picture remains for a long time, this picture will bring a 'leave shadow' in screen. Usually the 'leave shadow' will disappear gradually when you turn off the machine power. However, this trouble can't be repaired, Which isn't in range of warranty.

## Free Manuals Download Website

<http://myh66.com>

<http://usermanuals.us>

<http://www.somanuals.com>

<http://www.4manuals.cc>

<http://www.manual-lib.com>

<http://www.404manual.com>

<http://www.luxmanual.com>

<http://aubethermostatmanual.com>

Golf course search by state

<http://golfingnear.com>

Email search by domain

<http://emailbydomain.com>

Auto manuals search

<http://auto.somanuals.com>

TV manuals search

<http://tv.somanuals.com>