



Haier

Microwave Oven

Owner's Manual

Model: EO-2080EGV

Haier

READ ALL INSTRUCTIONS CAREFULLY BEFORE USING THE OVEN.



DECLARATION OF CONFORMITY

The manufacturer of the product/s described herein, to which this description refers, declares on its sole responsibility that the product/s meet the relevant fundamental safety health and protection requirements of the relevant EU guidelines and that the corresponding test reports are available for examination by the relevant authorities and can be requested from the seller of the appliance, especially with regard to CE Declaration of Conformity issued by the manufacturer or with the Manufacturer's approval.

Moreover, the manufacturer declares that the parts of the appliance described in this user manual, which come into contact with fresh food, do not contain any toxic substances.

■ Electricity schematic diagram

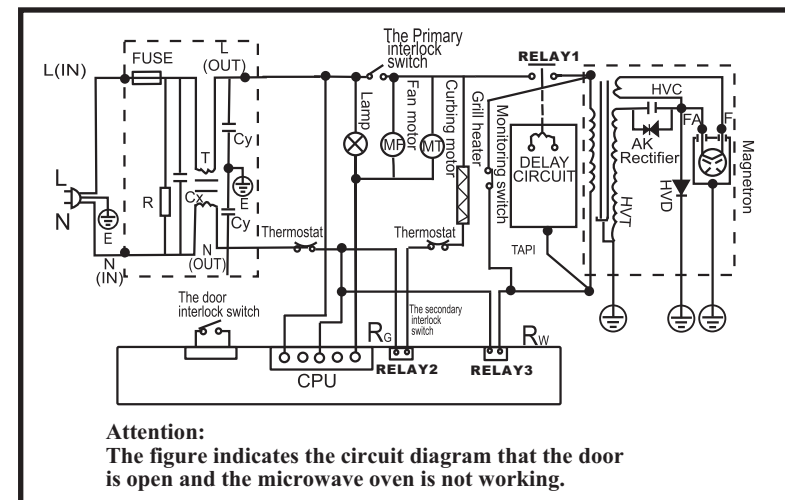

Contents**Page**

Electricity schematic diagram	Front page
1 Potential dangers	2
2 Where to Install the Oven	3
3 Installing the Oven	3
4 Rating plate	4
5 Plugging in your appliance	4
6 Using the Microwave Oven	5
7 Components	7
8 Operating panel	8
9 How to operate your microwave oven	9
10 Cleaning and care	15
11 Customer Support Service	15
12 Calling the Customer Support Service	16
13 Guarantee	16
14 WARNING	17

Caution ! Microwave ovens may only be installed, plugged in and started up in full compliance with the instructions for use. Therefore, please read the instruction manual carefully from start to finish before you start to use your appliance. **The manufacturer is not liable for any damage caused by failure to pay heed to the operating instructions when operating the appliance.** Highlight the points that are especially important to you and keep this document in a place where it can be consulted at any time and be passed on to future owners. **This appliance must be kept out of children's reach.**

Important !

The appliance(s) described in this instruction manual is / are solely designed for domestic use and may not be used for professional or commercial purposes.

You have chosen an excellent appliance which will serve you reliably for many years, if it is operated and maintained properly.

Detailed drawings (FIG.A) with a legend you shall find on page 7 of this manual.

Should your newly purchased appliance replace an old microwave oven, cut off the power cable of the old appliance as close as possible to the cabinet. Please have the old appliance ecologically disposed off by a company specialised in environmental protection. (ask your civic Centre)

23. The door seal and all of the relative parts shall be cleaned with soap liquor once each week to keep the cavity clean.
24. If the power cord is damaged, only the sellers or professional technicians authorized by the manufacturer can make maintenance to avoid any electric shock danger.
25. If you use cook utensils not recommended by us, be sure to watch out for the cooking proceeding in the microwave oven.
26. If you heat liquor , in handling the liquor , please notice that the boiled liquor may have delayed bursting and cause scalding.
27. Small amount of food require shorter cooking or heating time .If normal times are allowed they overheat and burn.

14 WARNING !

IMPORTANT SAFETY INSTRUCTIONS: READ CAREFULLY AND KEEP FOR FUTURE REFERENCE

1. No one except the professional technicians can decompose the microwave oven. Electric shock danger may occur!
2. Do not put metal stick into the interlock hole at the front of the cavity. It may cause microwave leakage!
3. Do not add excessive force to opposite direction on the door. Otherwise the door may be deformed and cause microwave leakage.
4. Do not cook food with vacuum package or packed into enclosed container. For the food with skin, remember to puncture it before cooking.
5. Do not cook eggs with shell. It may cause bursting.
6. Remove the grease remained in the cavity . Otherwise it may cause smoking or fire in heating.
7. Do not use the microwave oven for purposes other than cooking.
8. Be sure to earth the microwave oven reliably in installation and usage.
9. Reserve enough space for the rotation of the tray At least 5cm space above the microwave oven is required for heat radiation.
10. Do not put microwave oven in humid or high-temperature environment.
11. Do not touch the upper part of the shell and the outer screen of the door . It may cause scalding.
12. Do not run the microwave oven without load. It may damage the microwave oven.
13. Do not use metal container to cook with microwave oven. It may cause igniting phenomenon.
14. After long time cooking, the cavity is under high temperature. It is suggested to wait for some time to cool it down before next usage.
15. Before usage, please check if the cooking utensils are applicable for microwave oven.
16. When cooking food with plastic or paper package, be sure to check if it strikes a fire.
17. If there's smoking during cooking with microwave oven, please keep the oven door closed and pull off the power plug.
18. If you heat beverage, it will slowly expand. Be sure to watch out for bursting.
19. For those drinks or food prepared for children, be sure to stir or shake evenly and check the temperature before feeding to avoid scalding.
20. If the door , door frame or door seal is damaged, do not use the oven before it is repaired by the professional technicians.
21. During maintenance, be sure to switch off the power supply . To decompose the shell of the oven, be sure to have it done by professional technicians. The inner components are electrified, and may cause electric shock.
22. Children shall use the microwave oven under the instruction of adult, or use the oven by self after they have received complete instruction and description from the adult. The adult shall teach the children the general knowledge on the danger of operating the microwave oven.

Using Your Oven

In the following, please find all important instructions for the use of the oven.

As this manual applies to several microwave ovens, some specifications may differ from model to model.

1 Potential dangers

Caution !

Microwave ovens may only be used to warm up or heat up food or drinks. Never use your microwave oven for other purposes such as drying textiles or other objects, let alone life animals. This may cause acute fire(s) or accident hazard.

1. If you install or start up your microwave oven without first reading the instructions for use:

- Misuse may damage **your health and endanger your life.**
- Mistakes made in installation and connection may potentially damage the appliance itself and your kitchen furniture

2. Over boiling

- When heated in a microwave oven, liquids may overheat beyond their boiling point without you being able to see it (**boiling causes non visible bubbling**).

Caution: By merely touching a serving dish as you take it out, steam bubbles may unexpectedly and suddenly form and the liquid in the serving dish may unexpectedly boil over.
(Danger to get severely scalded)

You can prevent such an occurrence, by simply putting a clean glass rod into the dish, filled with liquid. However before removing the serving dish, observe if the boiling liquid bubbles up as usual.

- **In mixed food** with different moisture levels, the microwaves heat up the moister ingredients far stronger.
- **Baby food heated up** in glasses or bottles may only be handed to your child after having checked the temperature of the food or drink.
- As different ingredients may be warmed up at varying degrees, the dish/bottle containing baby food may feel only lukewarm, whereas the food inside is far more heated up. **For this reason, always shake or stir the baby food evenly so that the heat is distributed.**

3. Suitable cooking ware

Always ensure that your dishes and pots are compatible with microwave ovens.

Cooking ware made of the following materials is best suited:

- Fire-resistant glass or ceramics
- Heat-resistant and microwave suited plastic
- Heat-resistant porcelain / stoneware

The following materials may be used **only for brief operation** (e.g. warming up) **as long as it is under constant supervision in case of fire** and the manufacturer explicitly states that the materials are suitable for microwaves.

- Wickerwork
- Wood / wooden skewer
- Plastic cups / dishes etc.
- White paper trays / cartons

1.1 Very important !

The following items **are under no circumstances suitable** for microwave cooking:

- Metal containers, cutlery or skewers
- Containers with metal trimming (e.g. gold rim)
- Bags sealed with metal parts (clips)
- Cartons coated with plastic film or foil
- Coloured or recycled paper

Metal objects may trigger off unwanted sparking and potentially damage the appliance.

Coated cartons, coloured or recycled paper may contain substances that may lead to overheating and fire.

If your appliance is also equipped with a fan or a grill function, **make sure** the dishes you use have a **high heat resistance**.

2 Where to Install the Oven

1. **Before installing** your new appliance, **you need to check** as for visible external damage.

Under no circumstances should the appliance be started, if it is damaged.

Therefore, thoroughly check the appliance as for:

- **Damaged packaging**, indicating that the appliance may have been damaged during shipment
- **Damaged cabinet**
- **Damaged door glass panel**
- **Visible damage to the cable / plug**

If you suspect any damage, please have the appliance tested by the customer support service.

At all costs prevent the emission of any hazardous microwave radiation by not starting up a damaged oven.

3 Installing the Oven:

(FIG. A)

- a) Unpack the appliance
- b) Remove all objects from the inside of the oven.
- c) Carefully remove all plastic films and stickers from:
 - the cabinet
 - the door
 - the Turntable axle - drive shaft

Failure to carefully remove plastic films and stickers may lead to a fire hazard.

- d) Clean the oven interior with a damp cloth.

Do not use sharp cleansers or scouring agents!

- e) Unpack the turntable (not all models are equipped with) and its undercarriage

Customer service jobs resulting from improper operation of the oven are liable for payment even during the guarantee period.

What is when.....

- Is the plug firmly inserted in the socket?
- Is the power socket under current?

(test this by plugging in another kitchen appliance)

- Is the fuse intact?
- Was the timer set properly? (first turn beyond the required time and then back accordingly)
- Does the oven door close tightly?
- Is anything stuck in the door?

Under no circumstances should you subject the appliance to any tests other than those described here or attempt to repair it yourself by technical means.

Warning !

The interior lamp may only be replaced by specially trained customer service personnel who is aware of the related dangers.

The appliance works independently from the interior light. It can thus also be operated easily even if the interior lamp has failed.

Steam escaping from the air vent is quite normal during operation. This is not a malfunction.

12 Calling the Customer Support Service

To ensure prompt help when needed, please have ready the following data before calling the customer support service:

- Appliance Type / Model (see rating plate)
- Date of purchase
- Name and location of your dealer
- Description of the malfunction

The address and phone number of the customer support service centre responsible for your appliance can be found in the attached customer support service directory, or in the guarantee card. Otherwise contact your dealer .

13 Guarantee

Please note the general guarantee terms and the guarantee period stated in the attached guarantee card. If the appliance documentation does not include a guarantee card, please contact your dealer .

The manufacturer works constantly at the further development of all products. Please therefore bear this in mind as the form, set up and technology are subject to change, without prior notice.

10 .Cleaning and care

Caution !

The microwave oven must be unplugged from the power supply before cleaning it (on the external or interior side).

Pull out the power plug, or activate fuse safety switch.

If you cannot reach the plug, keep the oven door open (also when cleaning the outside).

Only in this way you can prevent the appliance from being switched on when the function keys or switches are inadvertently activated.

1. Cleaning the Cabinet

Caution ! Under no circumstances should water or a cleaning fluid get into the inside of the oven.

This is particularly important when cleaning around the air vents or rear wall.

Otherwise serious accidents may ensue due to electric shock and the appliance may be damaged.

- Only use clear water with just a little washing-up liquid for cleaning. Do not under any circumstances use sharp cleaning or scouring agent. Lastly wipe the cabinet dry with a soft cloth.
- Carefully remove food particles and dirt deposits between the door and cabinet, so that the door always shuts properly and tightly.

Warning !

Under no circumstances should you continue to use the appliance if you have detected any damage on the door seal or on the adjoining surfaces. The same applies to damage detected on the door itself or door hinges. Otherwise hazardous microwave radiation may escape from these locations. This kind of damage must be repaired by a trained customer service engineer, before you can use your appliance again.

2. Cleaning the inside of the oven

Never pour water into the oven interiors. Water may enter the interior of the oven through the air vents and damage the appliance. Moreover serious accidents can ensue due to electric shock.

- Clean the oven interior thoroughly. Particles of fat and food may overheat and potentially cause fire hazard. Moreover food and dirt deposits inside the oven affect the performance of the microwave oven.
- Use only clear water with a little washing-up liquid to clean the interior of the oven. Do not under any circumstances use sharp cleaning or acids. Lastly wipe the cooking chamber dry with soft cloth.

11 Customer Support Service

Check on the enclosed guarantee card or the separately enclosed customer service directory which firm is responsible for the customer support service of your appliance.

If your appliance documentation does not mention the responsible customer support service, please contact your dealer.

If your appliance does not work despite observance and compliance with all tips and guidelines described in these instructions for use, then please do the following check "What is when...", before you call the customer support service:

- f) Place the undercarriage in the circular track on the oven interior floor.
- g) Lay the turntable onto the undercarriage. By gently turning it, the guide fits into the drive shaft.

■ Place the appliance on an even and non-skid surface.

It must be stable enough to easily support the appliance even if the oven contains goods.

■ Leave a space of at least 10 cm between the foremost edge of the worktop and the front of the oven door.

You will thus prevent the appliance from tilting forward when the door is open.

■ Install the oven in a place where it is protected against splashing water or dripping liquids.

■ Never operate the appliance outdoors.

Sunlight and humidity may impair operational safety.

■ Never expose your microwave oven to direct sunlight (overheating hazard).

■ Do not install the appliance in the immediate vicinity of heat sources such as radiators or cookers.

■ The following minimum clearances between other objects / walls must be maintained for safety purposes:

- Side l/r clearance at least 5 cm
- Rear clearance at least 30 cm
- Upper clearance at least 30 cm

■ The appliance must not be built into a cupboard.

The oven must not be built in underneath a panel or a cupboard.

- For some models a built under - mounting set is commercially available. Please ask your dealer or the respective customer support service.

CAUTION!

During operation clouds of steam escape through the air vents of the appliance and it may get very hot within the space of the above mentioned minimum clearances. The microwave oven should thus be installed so that no objects sensitive to heat or moisture are located near the minimum clearances. Avoid any possible overheating of the oven caused by unintentionally covering or sealing the air vents. When in operation the base of the oven may become very hot. The worktop must thus be accordingly heat-resistant.

4 Rating plate

The rating plate with technical specifications is located on the cabinet, at the rear of the oven.

5 Plugging in your appliance

Your appliance must be connected to a power socket with grounded connection, which complies with the respective regulations and has been installed by an authorised specialists.

Before plugging the appliance into the wall socket, make sure that the voltage(V) and fuse amperage (A) specified on the rating plate of the oven correspond with the electrical power supply in your home.

If these specifications do partly or not at all correspond, immediately contact your local customer support service or your dealer and do not plug in the appliance under any circumstances.

When operating the microwave oven for the first time, make sure that:

- The power cable of the oven is not led underneath the oven base, which does get hot, and does not come into contact with sharp edges or hot objects.
- The power cable does not extend into the other kitchen work areas.
- The power cable does not droop from the worktop and nobody can get caught in it.
- The power cable does not come into contact with moisture (e.g. when wiping the worktop or rinsing).
- The power plug is easily accessible and can quickly be unplugged in case of danger.
- The power plug is always firmly inserted in the socket and loose contact cannot cause any fire hazards.
- Slack power plugs or sockets must be immediately repaired by a skilled electrician.
- No curtains are nearby.

6 Using the Microwave Oven**1. Before switching on the appliance, you should familiarize yourself with the following guidelines:**

- Before your first use, please **NOT** unveil the film on the surface of the door joining group.
- **Never operate the oven when it is empty, otherwise it could get damaged.**

To prevent the oven from being operated inadvertently without contents, **always leave a glass of water in the cavity** when the appliance is out of use.

■ Never heat liquids or food(s) in sealed dishes

Within sealed dishes over pressure can quickly develop and thus cause the dish to burst. This leads to potentially serious accidents.

■ The following items are also liable to burst due to developing overpressure: eggs in shells, nuts in shells or any food(s) vacuum packed in plastic foil.

Therefore, always pierce raw eggs on two sides and remove the foil or at least cut it open on one whole side, before you put it into the oven. Remove nutshells.

■ Should the use of aluminium foil be recommended in a recipe, make sure that it tightly adheres to the cookware or food and a gap of at least 2.5 cm is left between the aluminium foil and the cooking compartment walls.

Otherwise sparking may occur inside the oven and the appliance could consequently get damaged.

■ In order to ensure that the seal is constantly protected adequately against hazardous escaping microwaves, always make sure that:

- a) **No objects** (dishcloths, parts of food packaging etc.) **are caught between the door and cabinet.**
- b) **Door seal or door hinges are not damaged or soiled (also see section on "Cleaning and Care").**

Do not touch - Scalding hazard:

During operation your microwave oven may present **scalding** hazards in the following components:

- **on the door - glass panel**
- **on the lateral air vents**
- **on the underside of the oven**
- **on the top of the oven**

2. Prevention of smoke or fire in the microwave oven.

If food(s) overheats, smoke may develop or smouldering may start inside the oven.

Food(s) with a high sugar or fat content are particularly prone to this hazard.



DEFROST SETUP

FOOD	DISPLAY
Meat	DE-1
Chicken	DE-2
Fish	DE-3

Child Lock**1. Lock on**

Procedure: In Standby mode, press and hold  /STOP button for about 3 seconds until two short beeps are heard and indicator  appears on the display screen. In such case, any of cooking functions of the oven cannot be reset.



2. Lock off

Procedure: In Child lock-on mode, press and hold  /STOP button for about 3 seconds until two short beeps are heard, and indicator  disappears from the display screen.

Ventilation

This pattern of higher microwave oven is ventilated automatically to get rid of abnormal odor occurred inside the oven.

Procedure:

Press and hold  for about 3 seconds; the oven will countdown 5 minutes. In such case, the ventilation indicator  lights. When ventilation finishes, **End** appears on the display screen and 5 beeps are heard. Finally, the oven will enter Standby mode.

Note:

- If **+30s** button is rotated clockwise, the menu codes change from S-01 to S-05.
If **+30s** button is rotated counterclockwise, the menu codes change from S-05 to S-01.
- On the vessel sees scale of 150ml, 300ml and 500ml for options. It is suggested using HOT water to save time under steam cooking.

Warning:

- The vessel provided by the manufacturer can only be used in this oven for steaming performance, Do not use the vessel in other microwave ovens (Both Haier and other brand).
- The vessel cannot be used when the oven is not loaded or set for light wave status. The vessel can only be used when the oven is set for microwave performance and filled with water for steaming of food.
- Always observe the appliance until the end of the set cooking time.
- Wear gloves when the vessel is taken from the oven, otherwise your hands might be injured.

Automatic defrosting



In Standby mode, press button and rotate **+30s** knob to adjust food weight, and then press **+30s** button to confirm. The program starts performance. In the process of operation, the indicator of automatic defrosting light appears on the screen. The microwave oven will enter the Standby mode when set countdown display finishes and control panel sounds for reminder.

Defrosting function

Example: Set defrosting mode for 400g frozen meat

- Wrap 400g frozen meat with dedicated membrane and place wrapped meat in an appropriate container. Place the container inside the oven cavity and close the oven door.
- Press defrost button once, press **+30s** to confirm the menu.
- Rotate **+30s** until the screen appears **04:00**. Press the button to start the oven.

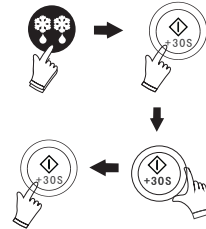

Note:

- When defrost time is set, rotate **+30s** knob, and the weight display cycles between 100g to 1000g. The figure of weight is integral multiple of 100. When the oven is in operation, the oven door can be opened by press of **+30s** button. The defrost mode can be resumed if **+30s** button is pressed after the oven door is closed.
- When the cooking finished you will heard 5 short beep, and the screen display **End**, It will return clock states automatically in seconds.
- Cooking time could be adjusted more or less, for better defrosting;

Warning:

- Do not open the oven door unless it is necessary in the process of operation.

The microwave oven is therefore not suitable for:

- frying
- Making popcorn
- melting sugar or fats
- cooking dried beans etc.
- **When preparing food(s) with uncertain compositions, you should keep an eye on the appliance until the end of the set cooking time.**

2.1 How to react when smoke develops inside the oven

Should smoke or fire develop inadvertently inside the oven, this problem can usually be easily overcome by taking the following correct steps:

- Whatever happens, keep the oven door closed.
- First thing, switch off the appliance immediately
- Then switch off the power supply by unplugging the appliance or activating the fuse safety switch.
- Open the oven to take out the burnt food only when you can no longer detect any smoke.

CAUTION ELECTRIC SHOCK

Under no circumstances should you attempt to extinguish smouldering or burning food inside the oven with water. In this case serious accidents may be caused by electric shock.

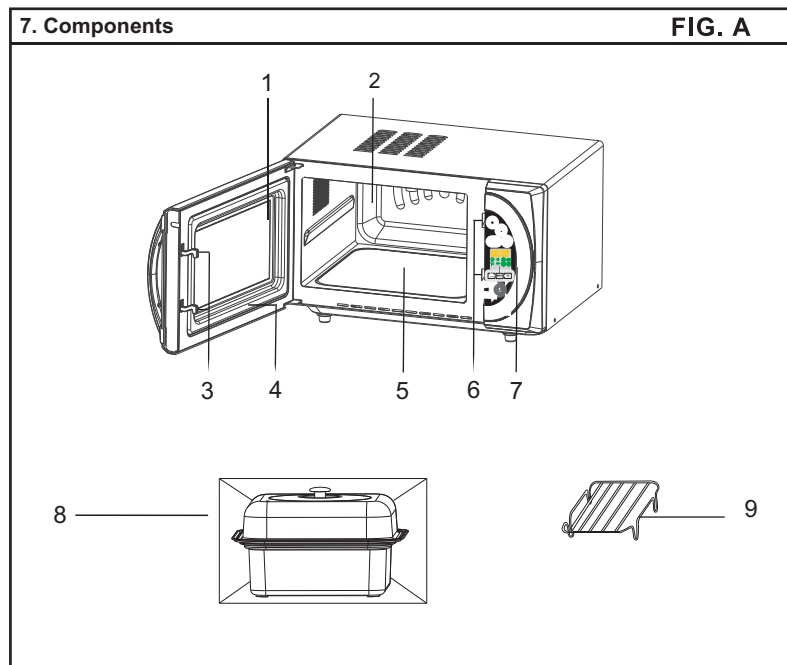
**Legend of Components**

Availability of components depending on Mod. / Type of appliance

1. Oven Window
2. Oven cavity
3. Door hook
4. Door seal
5. Bottom tray
6. Door hook inset
7. Control panel
8. Steam Container, frame, special glove inside (only for steam function)
9. Gridiron (only for grill function)

Suggestion: If the quantity of food you cook is small, please put the food in the center of the bottom tray.

CAUTION: Do not put erosive things (such as salt, sugar on the bottom tray, it could damage the bottom tray).

Auto menu	Display	Weight	Total time
Meat	A-1	100g	4'00"
		200g	6'30"
		300g	7'30"
Fish	A-2	200g	10'00"
		400g	12'00"
		600g	14'30"
Pizza	A-3	100g	1'20"
		200g	2'00"
		200g	5'30"
Vegetable	A-4	400g	6'30"
		600g	10'30"
		200g	1'20"
Beverage	A-5	400g	2'20"
		600g	3'50"
		100g	50"
Bread	A-6	100g	50"
		200g	1'10"
Popcorn	A-7	100g	2'30"

Steam Menu

Example: Set the oven for 500g fish

1. Water the vessel with hot water.
2. Place the fish in the vessel with the lid on, place the vessel in the cavity of oven, and close the oven door.
3. In Standby mode, press **Steam** button, rotate \diamond **+30s** button to the position **S-02**, and press \diamond **+30s** to confirm selected item.
4. The indicator of **05:00** appears on the display screen.
5. Press \diamond **+30s** to initiate the oven.

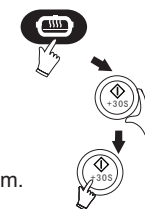

Steam Menu	Display	Weight/Quantity	Time	Water(g)
Chicken	S-01	200g	24'00"	500g
Fish	S-02	500g	26'15"	500g
Egg	S-03	500g	15'45"	300g
Corn	S-04	500g	26'15"	500g
Vegetable	S-05	500g	8'45"	300g

In addition to the menu recommended by the manufacturer, you can also set menus of your favorite dishes.

Example: Set the oven to steam shrimps for 10 minutes.

Procedure:

1. Water the vessel with hot water.
2. Place the shrimps in the vessel with the lid on, place the vessel in the cavity of oven, and close the oven door.
3. Select Rotary Wave (microwave) mode and steaming time, and press \diamond **+30s** button.

3.COMBI 2

50% microwave and 50% light wave output with C2 on display;
Applicable for meat, chicken and duck meat ;
Maximum cooking period to 60 minutes.

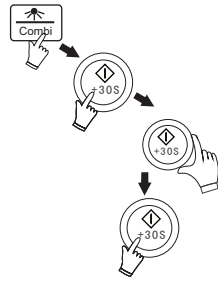

Light Wave cooking

Example: Cooking something at COBMI 1 mode for 14 minutes.

- 1.Place the plate of food in the cavity of the oven, and close the oven door.
- 2.In Standby mode, press button twice, press button to confirm the setting.
- 3.Rotate until **14m 00s** appears on the display screen. Press the button to confirm the setting and the oven starts operation.

Note:

- 1.When light wave or COMBI mode is selected, turn over the food regularly for better result.
- 2.Press the , the G, C-1 and C-2 will cycle apperas on display screen.
- 3.The button can be rotated for the longest cooling period of 60 minutes. However, it is not suggested the maximum length of cooking time be exceeded by continuous operation of the oven.
- 4.If COMBI mode is selected, indicators of both light wave and microwave light on . When light wave is in operation, the indicator flashes while microwave indicator goes on. When microwave is in operation, the indicator flashes while light wave indicator goes on.
- 5.When the cooking finished you will heard 5 short beep, and the screen display **End**, It will return clock states automatically in seconds.

Warning:

- 1.Do not let electric cord contact the light wave tube on the top of cabinet, otherwise the electric cord might be damaged due to high temperature when the GRILL mode is in set.
- 2.Do not touch the cabinet of the oven while the oven is in operation to avoid scalding.

Auto Menu

This button have 7 kind of auto menu.

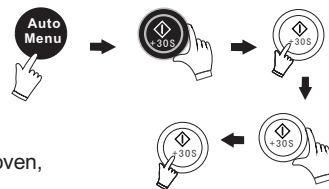

Example: Set the oven for 400g vegetables

Procedure:

- 1.Place a plate of vegetable about 400g in the cavity of the oven, and close the oven door.
- 2.In Standby mode, press **Auto Menu** button, rotate until the screen appears **A-04**, and press to confirm selected item.
- 3.Rotate until **0400g** appears on display.
- 4.Press to start the oven.

Note:

- 1.If button is rotated clockwise, the menu codes change from A-01 to A-07.
- If button is rotated counterclockwise, the menu codes change from A-07 to A-01.
- 2.When the cooking finished you will heard 5 short beep, and the screen display **End**, It will return clock states automatically in seconds.
- 3.Not all of the auto menu are suitable for you, please adjust the cooking time according to your taste, In addition, it is suggested mixing round food 1~3 times for better cooking.

8. Operating panel

Screen Display and key functions

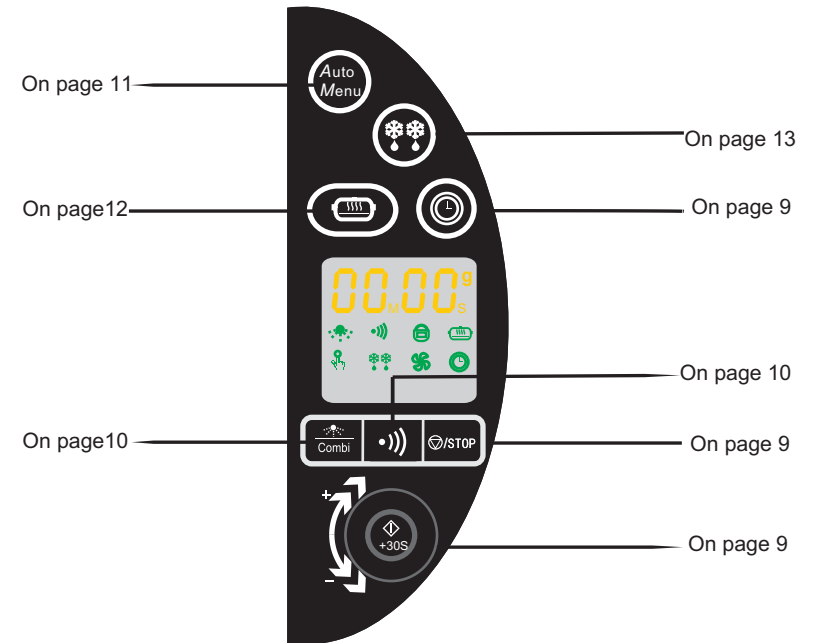

Visual Displays

The drawing on underside will light to indicate which function in progress. Please see the following pages.

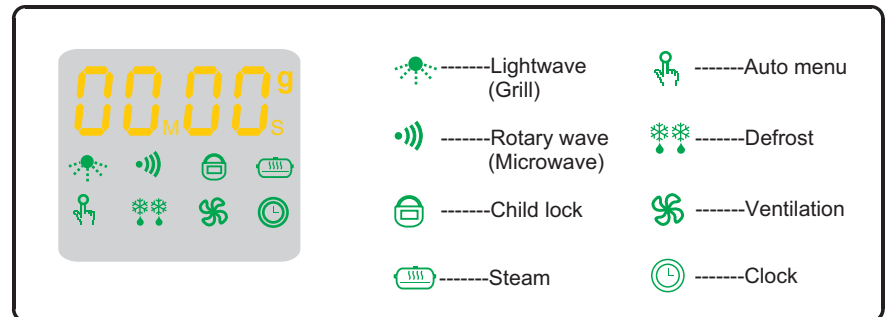

9. How to operate your microwave oven

Please read and fully understand the instructions before operating the Oven.

(Look at the operate panel of the page 8)

Clock



In Standby mode, press **Clock** button to set the clock. Press $\diamond + 30s$ to enter time setting.

Instruction as follows:

For example: You desire to set the clock 11:30.

1. Press **Clock** button, the indicator of digits at left side of time will flash.

2. Rotate the dial $\diamond + 30s$ to enter hour.

Press the button when "11" is on display.

3. Rotate the dial $\diamond + 30s$ again to enter minute.

Press the button until "30" is on display.

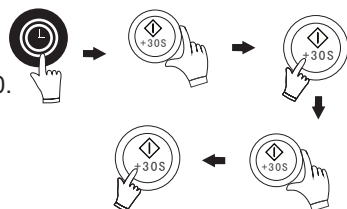

1. Setting **hour**: If the dial rotates clockwise, the indicator will cycle from "00" to "23". If the dial rotates counterclockwise, the indicator will cycle from "23" to "00".
2. Setting **minute**: If the dial rotates clockwise, the indicator will cycle from "00" to "59". If the dial rotates counterclockwise, the indicator will cycle from "59" to "00".
3. If "s" flashes on the display screen, it indicates that clock is in function, and lights on the screen.
4. When **Clock** is set, after other function procedures finish, the clock mode will be resumed automatically.
5. If power supply is interrupted and electrify again, the clock will display "12 00" and should be reset.

Start Button



Rotate the button to adjust auto menu food weight and cooking time. Press the button to confirm and initiate the set performance.

If Max. microwave power is desired for cooking, just press $\diamond + 30s$ button can also start the oven, The button can be set for a maximum length of 5 minutes.

Pause/Stop



When the oven is in operation, if the button is pressed once, cooking can be paused. If the button is pressed twice continuously, cooking can be canceled. In such case, the oven will enter standby mode. If the button is pressed once and then $\diamond + 30s$ button is also pressed, the oven will resume previous performance.

The button can be used to set Child Lock-on or Lock-off mode.

Rotary Wave

1. Options of cooking power
2. While the oven is in operation, the keeps lighting on the display.
3. Five scales (P-1 to P-5) of power level are available for options.
4. The max. scale of power rating will be automatically set unless the oven is preset before performance initiation.

Rating scale and output power

Press time	Power level	Display
Once	Max	P-1
Twice	Med+	P-2
Third	Med.	P-3
Quartic	Med-	P-4
Quintic	Min	P-5

Revolving wave cooking

Example: Cook something at Med+ mode for 10 minutes.

1. Place the plate of food in the cavity of the oven, and close the oven door.
2. Press twice, press $\diamond + 30s$ button.
3. Rotate $\diamond + 30s$ button until the screen appears **10m 00s**, and press the button to start the cooking.

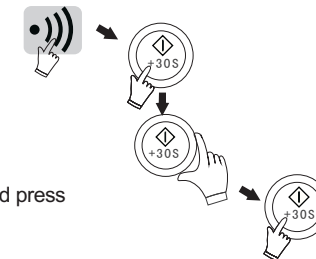

Note:

1. The button can be rotated for the longest cooking period of 60 minutes. However, it is not suggested the maximum length of cooking time be exceeded by continuous operation of the oven.
2. When the cooking finished you will heard 5 short beep, and the screen display **End**, It will return clock states automatically in seconds.

Lightwave/Combi

This button can be used for 3 options:

1. Light wave (Grill)
100% light wave performance with G on display;
Applicable for sliced meat;
Maximum cooking period to 60 minutes.

2. COMBI 1
20% microwave and 80% lightwave output with C1 on display;
Applicable for seafood;
Maximum cooking period to 60 minutes.

Free Manuals Download Website

<http://myh66.com>

<http://usermanuals.us>

<http://www.somanuals.com>

<http://www.4manuals.cc>

<http://www.manual-lib.com>

<http://www.404manual.com>

<http://www.luxmanual.com>

<http://aubethermostatmanual.com>

Golf course search by state

<http://golfingnear.com>

Email search by domain

<http://emailbydomain.com>

Auto manuals search

<http://auto.somanuals.com>

TV manuals search

<http://tv.somanuals.com>