

海爾家用微波爐  
Haier Household Microwave Oven

使用說明書  
User's Manual

# Haier

MA-2270EGC

MA-2270EGC (VC)

MA-2270EGC (MS)

安裝、使用產品前，請仔細閱讀  
本使用說明書

- 微波爐外觀、顏色和圖案見實物
- 本說明書中型號後面出現的所有  
的“●●●●”“(MS)”均為企業廠標  
識，並非企業型號的一部分，其中  
“MS”表示不鏽鋼膽。

- Please read the manual before use.
- Please refer to the physical product for the appearance, color and pattern.
- The mentioned product is for usage in mainland of China only. For usage in other nation or region please contact us on customization.
- All of the marks following the model number of the product, such as (VC), (MS) etc are internal symbols of the factory, not belonging to any part of the model number, in which “MS” refers to stainless cavity.

## 目錄

### 使用之前

產品特點 .....	2
產品規格 .....	2
電氣原理圖 .....	3
各部分構件名稱 .....	3
安全注意事項 .....	4-5
放置環境 .....	5
拆箱 · 安裝 .....	5

### 使用方法

操作板功能介紹 .....	6
使用方法 .....	7-11
微波爐的烹調技巧 .....	11

### 保養 · 維修

保養 · 維修 .....	11-12
疑難解答 .....	12-13
烹調器皿的選用 .....	14

注：本說明書已經過嚴格核對以求準確，但仍可能存在編制、排版或其他疏漏，致使說明書的內容可能會與實際情況有輕微差別。如給您的使用帶來不便，請及時與我們取得聯繫。

•

## 使用之前

該系列微波爐執行國家標準：

GB 4706.21-2002 《家用和類似用途電器的安全 微波爐的特殊要求》

GB/T 18800-2002 《家用微波爐 性能測試方法》

GB 4706.22-2002 《家用和類似用途電器的安全 駐立式電竈、竈台、烤爐及類似用途器具的特殊要求》

尊敬的海爾用戶：

感謝您選擇、使用海爾產品！

海爾產品質量優、性能佳。為了方便您使用，請仔細閱讀說明書，並按照說明書的步驟操作。

海爾的“國際星級服務”將自始至終伴隨著您，使用時無論有什麼問題，都可以按保修證中的電話、地址與我們聯系，我們時刻恭候著為您服務。

再次感謝您選擇、使用海爾產品！由於產品的不斷改進，您所買的海爾微波爐外觀可能與說明書中圖示不完全一致，謹此致歉。

重要的安全說明：請仔細閱讀並妥善保管此說明書，以備將來參考。

## 產品特點

### 1、外觀超群

海爾特有專利外觀，新穎獨特，卓然不群。

### 2、操作方便

全部功能實現採用薄膜開關按鍵分配完成，功能全，操作簡單、靈活。

### ●、使用安全

門體採用獨特的抗流結構，整體沖壓成形，更有效地防止微波泄漏。

採用兩級聯鎖開關及開門監控系統，確保微波系統開門斷電，使用更安全。

### ●、健康殺菌

利用微波及光波特有性能，能在一定程度上殺滅食物中的細菌和病毒。

### ●、光波燒烤功能

利用特有的光波燒烤技術，使食物燒烤效果更好。

## 產品規格

型號	電源電壓 (V/Hz)	輸入 功率 (W)	輸出 功率 (W)	燒烤 功率 (W)	微波 頻率 (MHz)	爐內 容積 約(L)	外形尺寸 (mm) (高 X 闊 X 深)	爐內淨容積約 (mm) (高 X 闊 X 深)
MA-2270EGC	~220/50	1200	700	950	2450	22	288X486X376	196X311X312

所列尺寸為約數，由於我們在不斷地改進我們的產品，因此如果技術參數有任何變動，恕不另行通知。

## 電氣原理圖

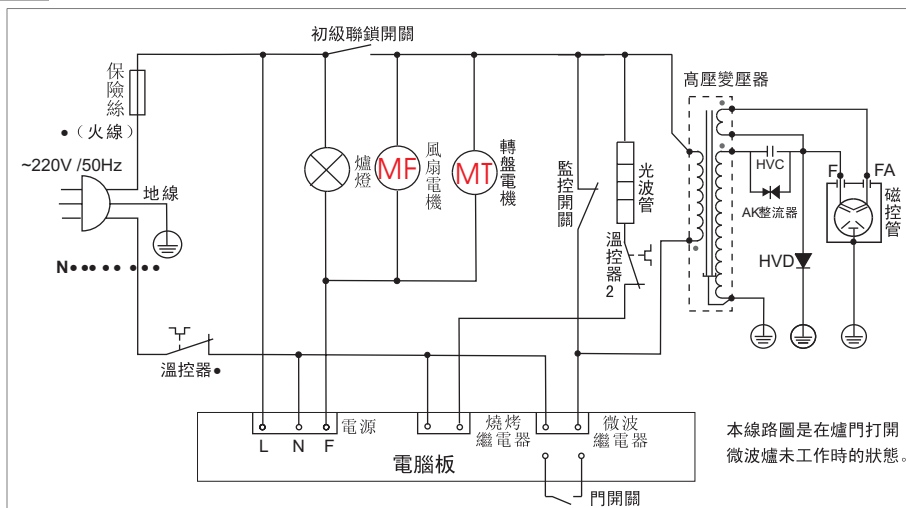

## 各部分構件名稱

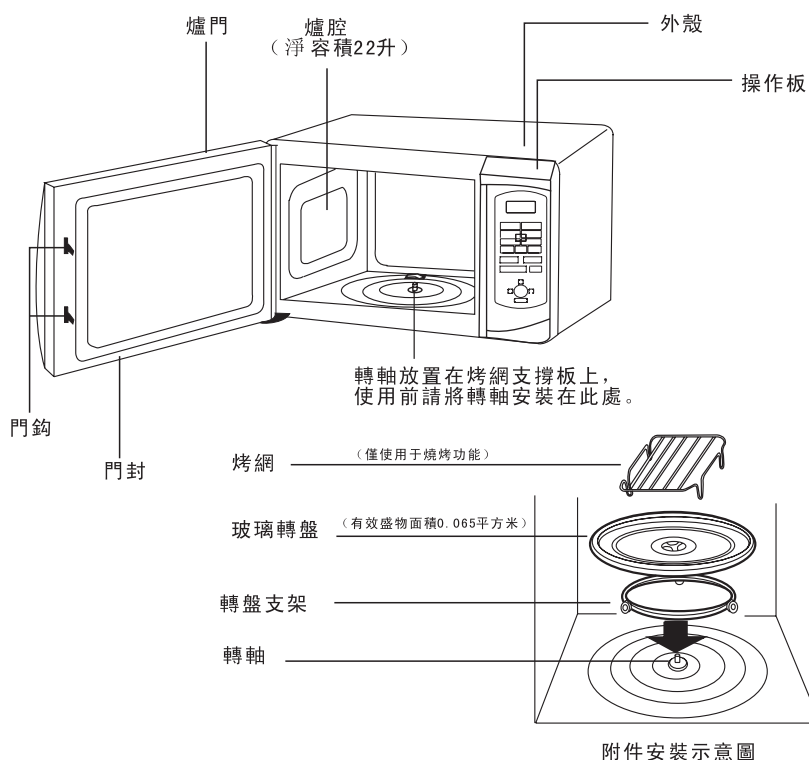

## 安全注意事項

請仔細閱讀安全注意事項，這樣您可以安全方便地使用海爾微波爐！



除專業維修人員外，任何人不得拆卸微波爐，否則，可能有觸電危險。



不能使用金屬棒探入爐腔前部的聯鎖開關孔，此舉可能導致危險。



禁止對爐門的反方嚮用力過大，可能會造成爐門變形，導致微波洩漏。



禁止使用密閉容器，對帶皮食物要進行刺孔處理。



禁止對帶殼雞蛋進行烹飪，防止崩濺。



注意清理爐腔內殘留油脂，不推薦使用塑料等可燃器皿，否則加熱時可能會冒煙或者著火，務必不要遠離，時時觀察。



食品烹調完畢後，在打開容器蓋子或撕開保鮮膜時，注意避免被高溫蒸氣燙傷。

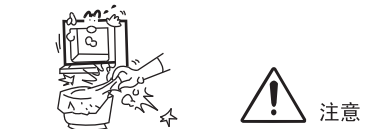

微波爐安裝使用時必須可靠接地。



燒烤烹調時，注意不要觸摸門屏及外殼上部，避免燙手。

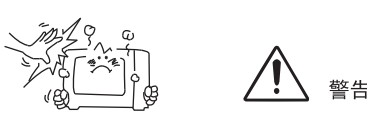

不得空腔使用，這樣會損傷微波爐。

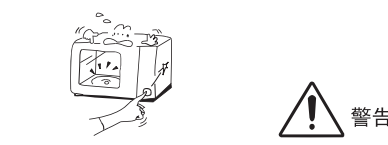

微波加熱或組合燒烤時，不得使用金屬器皿進行烹調，否則會發生打火現象。



爐腔處於高溫狀態時（如燒烤烹調結束後）不能立即使用微波烹調，直至爐腔充分冷卻後，方可使用。



## 安全注意事項

### 警告

- 警告：如果微波爐門或門封已損壞，則不得再使用，直到經有資格的維修人員修好為止。
- 警告：除有資格的維修人員外，其他人來執行檢修操作都是危險的，包括拆下防止微波能量泄漏的防護蓋等操作。
- 警告：不要直接加熱裝在密封容器內的液體或其他食物，因為這樣有可能發生爆炸。
- 警告：只有在已經提供充分的指導以至於兒童能夠採用安全的方法使用微波爐，並且明白不正確的使用會造成危險時，才能允許兒童在無人監控的情況下使用微波爐。
- 在微波爐內僅能使用適合的器皿。（參看“烹調器皿的選用”部分）
- 當加熱用塑料或紙包裝的食物時，應注意觀察微波爐內食品，因為有著火的可能。
- 如發現有煙霧，應立即拔掉器具電源插頭，並保持爐門關閉，以抑制火焰蔓延。
- 微波加熱液體（飲料等）會導致延遲噴濺沸騰，因此取出時必須小心謹慎。
- 奶瓶和嬰兒食品罐應經過充分攪拌或搖動，喂食前應檢查瓶內食物的溫度，避免燙傷。
- 微波爐不能用來加熱帶殼的鮮蛋和已煮熟的蛋，因為在用微波加熱時甚至在加熱之後它們可能會發生爆炸。
- 微波爐內無食物時，請不要使用微波爐，以免空載運行損壞機器。
- 在微波爐附近不要放置易燃、可燃物品，微波爐在工作期間，務請隨時監控微波爐烹調情況，並正確設定烹調時間，因為超時烹調可能引起火災。
- 含水量較少的輕負載食品在烹調過程中，由于不同物質對微波的吸收能力不同，可能存在冷熱不均，屬正常現象。
- 在使用燒烤或微波長時間加熱後，不能立即進行解凍，需等玻璃轉盤冷卻後再進行解凍。
- 不可使用尖銳利器（如清潔球、鏟勺等）清潔玻璃轉盤。
- 不要戳穿爐門網孔，否則會造成微波泄漏。

本品不得用于工業及商用目的

## 放置環境

微波爐安裝時應留有散熱空間，不能放置在潮濕、高溫的環境中。



不要接近電視機、收音機等，否則會幹擾圖像和產生噪音。用收音機測試微波泄漏是錯誤的，必須用專門儀器來測定。

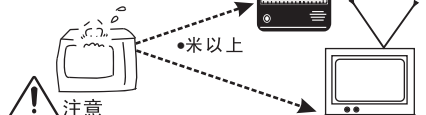

## 拆箱 • 安裝

拆箱

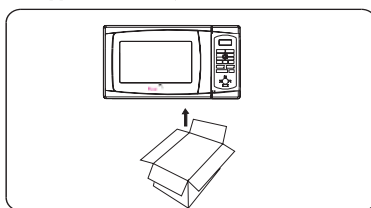

安裝

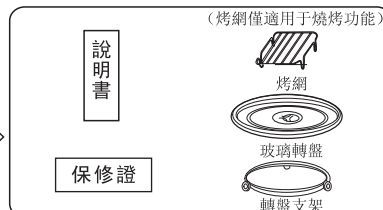
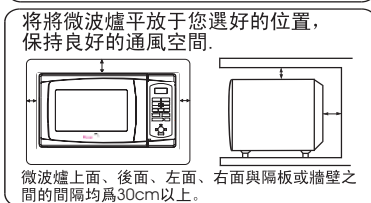

## 操作板功能介紹

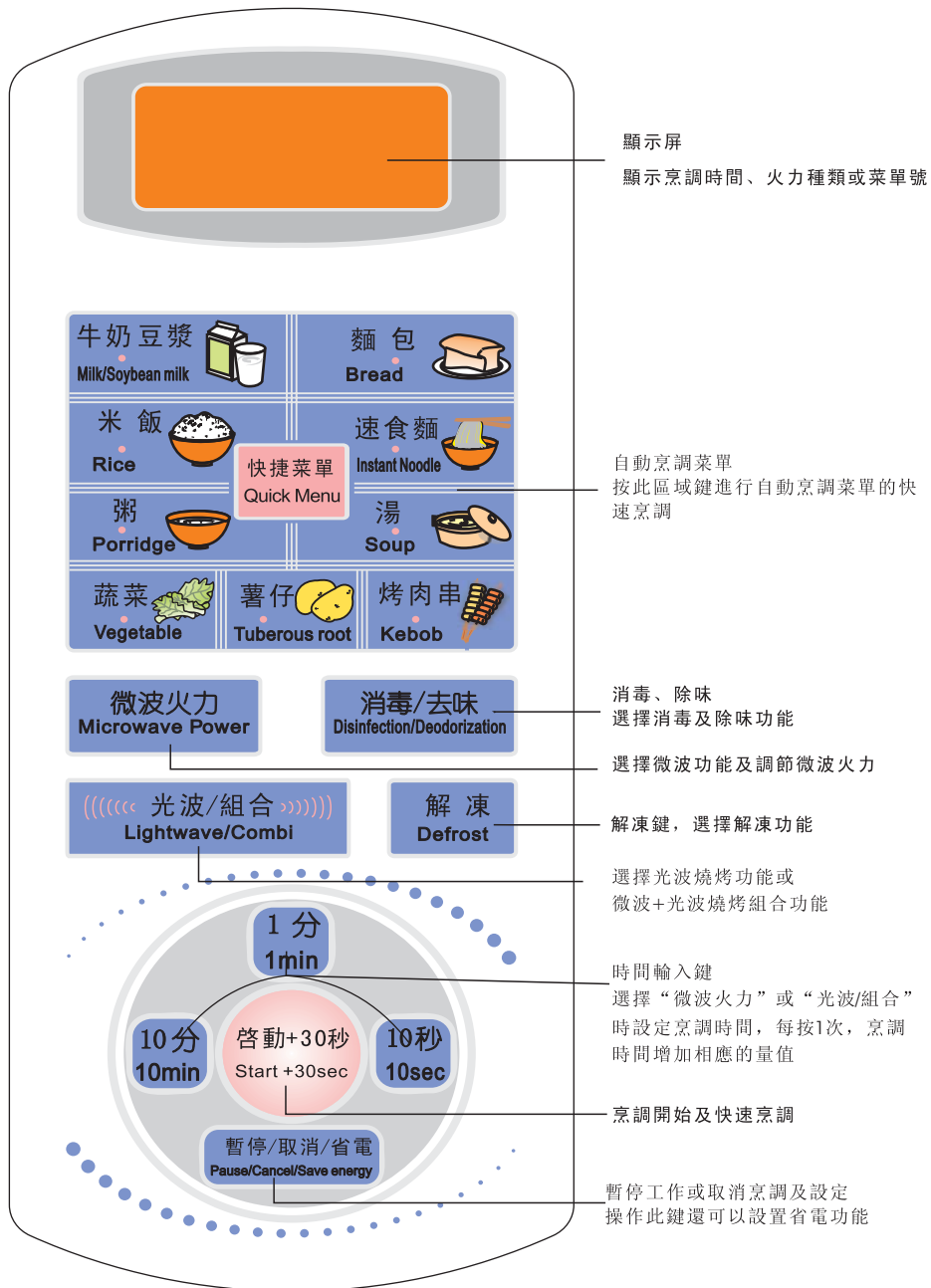



“啓動+30秒”鍵後，微波爐開始工作。最大烹調時間爲60分鐘。

## 使用方法

### 1、微波火力設定和加熱

本微波爐共設有5檔微波火力：高火700W、中高火600W、中火450W、中低火250W、低火120W，連續按“微波火力”鍵，顯示屏依次循環顯示P-1、P-2、P-3、P-4、P-5，（其中P-1表示100%火力）使用微波火力進行烹調要先設定烹調火力，後設定烹調時間，按“啓動+30秒”鍵後，微波爐開始工作。最大烹調時間爲60分鐘。

#### 例 用600W微波火力烹調10分鐘



- 1、將食物放入爐腔後關上爐門；
- 2、微波爐通電，處於待機狀態，屏幕顯示：
- 3、按“微波火力”鍵2次，屏幕顯示：
- 4、按1次時間輸入鍵“10”分，屏幕顯示：
- 5、按“啓動+30秒”鍵，微波爐開始工作，屏幕設定時間倒計時動態顯示；
- 6、工作終了，控制板提示音響起，提醒您。微波爐回到待機狀態。

### 2、燒烤火力設定和加熱

爲方便您使用，本微波爐共設有3種燒烤方式供選擇，其設定方法爲：在待機狀態下（屏幕大字顯示0000）連續按“光波/組合”鍵，屏幕循環顯示[0]、[-1]、[-2]。[0]表示100%光波工作，[-1]標是組合燒烤（12/60微波及48/60光波工作），[-2]表示組合燒烤（30/60微波及30/60光波工作）。使用光波或組合烹調要先設定燒烤方式，在設定烹調時間，按“啓動+30秒”鍵後，微波爐開始工作，最大烹調時間爲60分鐘。

（備注：[-1]適合薄塊燒烤，[-2]適合大塊燒烤）

#### 例 用[-1]烹調16分鐘

- 1、將食物放入爐腔後關上爐門；
- 2、在待機狀態下，按“光波/組合”鍵2次，屏幕顯示：
- 3、按1次時間輸入見“10”分，再連續按“1分”鍵6次，屏幕大字顯示：；
- 4、按“啓動+30秒”鍵，微波爐開始正常工作，屏幕設定的時間倒計時動態顯示；
- 5、工作終了，控制板提示音響起，提醒您。微波爐回到待機狀態。

### 3、“自動烹調菜單”的使用

自動烹調菜單包括牛奶/豆漿、速食麵、麵包、米飯、粥、湯、蔬菜、薯仔、烤肉串在待機狀態下，按某個鍵1次，微波爐即按選中的菜單即默認的食物重量啓動工作。



## 使用方法

此時，屏幕按照程序設定好的烹調時間倒計時動態顯示。

### 例 煮速食麵一包

- 將1包速食麵和適量室溫水（約400ml）盛放在大小合適的微波爐可用容器中，蓋上蓋，（也可以用微波爐專用保鮮膜做蓋，膜邊留2mm左右的間隙）放入爐腔後關上爐門；
- 按“自動烹調菜單”的“速食麵”微波爐即按默認的速食麵重量0.1kg和默認的烹調時間5分鐘開始烹調。此時，屏幕上的烹調時間 **5:00** 倒計時動態顯示；

- 工作終了，控制板提示音響起，提醒您，微波爐回到待機狀態。

### 例 烤肉串0.1kg

- 將上面鋪有菜葉的烤網放到爐腔中，將肉串0.1kg放到菜葉上，然後關上爐門；
- 按“自動烹調菜單”的“烤肉串”鍵，微波爐即按默認的肉串重量0.1kg和默認的烹調時間12分鐘開始烹調。此時，屏幕上的烹調時間 **12:00** 倒計時動態顯示；

- 烹調時間剩余3分鐘時，控制板蜂鳴器鳴響三聲，您可以直接打開爐門並根據個人口味添加調料；

- 工作終了，控制板提示音響起，提示您，微波爐回到待機狀態。

### “自動烹調菜單”使用說明

菜譜	食物重量 (kg)	使用说明
牛奶/豆漿	0.25	本菜譜用來加熱冷藏牛奶或豆漿。請先將牛奶、豆漿的原包裝去掉，再倒入微波可用瓷質或玻璃杯禁止使用塑料袋或鋁箔紙包將容器放入中，裝。微波爐中，選擇“牛奶豆漿”菜單自動加熱，加熱結束後請倒入另外的器皿中輕微攪勻後再飲用。
速食麵	0.10	將水(室溫):400ml水的用量供參考將速食麵和適量水盛放在大小合適的微波爐可用容器中，蓋上蓋，（也可用微波專用保鮮膜作蓋，膜邊留2mm左右的間隙）放入爐腔後關上爐門；
麵包	0.10	將麵包放入微波爐可用盤子上，然後覆上保鮮膜，以免水分散發；選擇“麵包”菜單自動加熱
米飯	0.20	將洗淨的米和適量室溫水一起放入大小合適的微波可用容器中，蓋上容器蓋，入爐。選擇“米飯”菜單後自動烹調，烹調結束後即可食用，也可適量擱置3-5分鐘。 注：食物重量是指米的重量。容器中水的量不要太多，米和水的總量不能超過容器的一半，否則容易導致食物沸出。 以下用量參考容器中的水（室溫）：400ml
粥	0.10	米洗淨，和適量水一起放入較深的微波可用容器中，蓋上蓋子後入爐。將選擇“粥”自動菜單後自動烹調。烹調結束後適當放置3-5分鐘。 注：食物重量是指米的重量，米和水的總量不能超過容器的一半，而且盡量不要使用保鮮膜，否則容易導致食物沸出。 以下用量供參考：水(室溫)1200ml

## 使用方法

菜譜	食物重量 (kg)	使用說明
湯	0.50	適用本菜譜可制作銀耳湯、豆腐湯等多種湯。將以下所有的材料攪拌均勻後放入微波可用容器中，蓋上蓋子，入爐。選擇“湯”自動菜單後啓動烹調。烹調結束後可以根據個人口味擱置2-3分鐘。 1. 銀耳湯：銀耳70g 冰糖50g 開水500g 枸杞子50g 桂花50g 鹽5g 2. 豆腐湯：豆腐20g 海苔片5片 開水500g 鹽15g 油5g以上 芹菜末1/2匙 冰糖1/2匙。 注：食物重量是指加入的開水的重量，盡量不要用保鮮膜做蓋。
蔬菜	0.20	以葉狀蔬菜白菜為例。將白菜洗淨並切成約2-3厘米的長條狀，與適量鹽、油、醬油及其他佐料攪拌均勻，放入微波可用容器，覆蓋上微波專用保鮮膜，入爐。選擇“蔬菜”自動菜單後啓動烹調，在烹調過程中可打開爐門，翻轉食物2-3次，烹調結束後可以根據個人口味擱置2-3分鐘以便使蔬菜莖部分熟透。 注：蔬菜是指葉狀蔬菜，如白菜、菠菜等。食物重量是指蔬菜的重量。
薯仔	0.20	以塊狀蔬菜馬鈴薯為例。將馬鈴薯洗淨並切成厚度約2-3厘米的圓片，加入與適量鹽、油、醬油及其他佐料攪拌均勻，放入微波可用容器，在容器中倒入約10-15克室溫水，覆蓋上微波專用保鮮膜，入爐。選擇“薯仔”自動菜單後啓動烹調，在烹調過程中可打開爐門，翻轉食物2-3次，烹調結束後可以根據個人口味擱置2-3分鐘以便使蔬菜莖部分熟透。 注：食物重量是指蔬菜的重量。
烤肉串	0.10	把鋪有菜葉的烤網放入爐腔，將肉串放在菜葉上，然後關上爐門，按自動菜單的“烤肉串”按鈕後啓動烹調。在烹調過程中，可以打開爐門翻轉食物2-3次。烹調時間剩餘3分鐘時，控制板蜂鳴器響三聲，您可以直接打開爐門並根據個人口味添加調料。

注：（1）速食麵、米飯、粥的重量均不包含水；  
（2）由於受個人口味等客觀因素的影響，以上烹調時間僅供參考。

### 5、自動解凍功能

連續按“解凍”鍵，表示選中重量依次為0.2、0.4、0.6千克，同時屏依次顯示相應的解凍時間，您首先需選定好食物重量，然後直接按“啓動+30”秒鍵，微波爐即按設定好的時和程序開始工作。工作過程中，屏幕解凍時間倒計時動態顯示。工作終了，控制板提示音響起，提示您，微波爐回到待機狀態。

注：選擇“解凍”解凍0.6千克食物時，剩餘一定解凍時間時控制板蜂鳴器響三聲，您可以直接打開爐門將食物翻面，再關閉爐門，按“啓動+30秒”鍵，繼續解凍。

### 例 用自動解凍菜單功能解凍0.6kg冷凍肉

- 1、將0.6kg冷凍肉用微波爐專用保鮮膜包好，盛放在合適的容器中，放入爐腔後關上爐門；
- 2、在待機狀態下按“解凍”鍵3次，表示已選中食物重量為0.6kg；
- 3、按“啓動+30秒”鍵，微波爐開始工作，屏幕顯示解凍時間 **10:06** 倒計時動態顯示；
- 4、解凍時間剩餘5分03秒時，控制板上的蜂鳴器鳴響三聲，您可以直接打開爐門將食物翻面，再關閉爐門，按“啓動+30秒”鍵，繼續解凍。

## 使用方法

- 、工作終了，控制板提示音響起，提醒您。微波爐回到待機狀態。

	食物重量 (kg)	解凍時間	蜂鳴器動作
解凍	0.20	3' 22"	
	0.40	6' 44"	
	0.60	10' 06"	剩余5' 03"時響三聲

- 注：(1)將待解凍食品放在蒸布上解凍效果更好；  
(2)除工作過程中提示食物翻面以外，解凍時不要打開爐門；  
(3)建議您去除此類包裝食品的紙或塑料，否則將會產生蒸汽或水分，引起食物表面過分解凍；  
(4)為防止過分解凍，較薄部分需要用鋁箔包裹；  
(5)解凍結束後，最好繼續放置5分鐘；  
(6)由于食物密度等因素的影響，以上解凍時間僅供參考。

## 6、消毒、去味功能

- (1)使用消毒功能：工作時間為5分鐘。在待機狀態下按“去味/消毒”鍵次即選中消

毒。此時，屏幕顯示消毒功能標識 **A**，將需要消毒的餐具、毛巾等放入微波爐中，關上爐門，直接按“啓動+30秒”鍵，微波爐即開始以消毒功能工作5分鐘。工作過程中，

屏幕默認的時間 **5:00** 倒計時動態顯示。工作終了，控制板提示音響起，提示您微波爐回到待機狀態。

- (2)使用去味功能：工作時間為五分鐘，在待機狀態下按“消毒/去味”鍵二次即選中去

味功能。此時，屏幕顯示去味功能標識 **AA**。直接按“啓動+30秒”鍵，微波爐即開始以去味功能工作5分鐘，去除爐腔中的異味。工作過程中，屏幕設定時間倒計時動態顯示。工作終了，控制板提示音響起，提示您，微波爐回到待機狀態。

- 注：(1)微波爐不能對食物進行消毒，切勿放入；  
(2)烹調結束後，直接啓動消毒除味功能，可以較好的殺滅細菌、除去爐腔中的異味。

## 7、暫停/取消/省電功能

- (1)暫停功能：若您在烹調過程中有事離開，可按“暫停/取消/省電功能”鍵一次，烹調程序將暫停運行，當需要繼續烹調時，可再按“啓動+30秒”鍵一次，微波爐將接著暫停時狀態繼續工作。  
(2)取消功能：在烹調過程中，若操作出錯或需要改變當前設定程序，可連續按“暫停/取消/省電”鍵兩次，則取消當前程序設定，回到待機狀態，此時，可重新進行程序設定。  
(3)省電功能：在待機狀態下，按“暫停/取消/省電”鍵一次，顯示屏背景燈全部熄滅沒有任何顯示，微波爐進入省電狀態。此時，按其他任意鍵顯示屏均可恢復顯示，回到待機狀態。

## 使用方法

### 8、童鎖功能

- (1) 設定童鎖：在待機狀態下（必須在待機狀態下），按住“暫停/取消/省電”鍵3秒，一聲長鳴即進入童鎖狀態，屏幕顯示童鎖圖標“[ \_ \_ ]”。此時，對微波爐烹調功能的設定操作無效。
- (2) 取消童鎖：在童鎖狀態下，按住“暫停取消”鍵3秒，一聲長鳴，屏幕童鎖圖標省電消失，微波爐回到待機狀態。童鎖功能的取消也可以以微波爐斷電的方式進行。

### 9、快捷啟動功能

在待機狀態下，可不用設定烹調時間，直接按“啟動+30秒”鍵，則微波爐立即以100%微波火力啟動工作30秒，在0到5分鐘時，每按一次增加30秒；在5到10分鐘時，每按一次增加1分鐘；在10到30分鐘時，每按一次增加2分鐘；快捷啟動最長可設定的工作時間為30分鐘。（注意：當時間運行至28分鐘到30分鐘之間時，按“啟動+30秒”鍵為補至30分鐘。）

## 微波爐的烹調技巧

### 微波爐的烹調技巧

食品溫度	食品的溫度越低，烹調的時間越長，冷凍食品要比常溫食品加熱時間長。
食品濕度	因為微波易被潮濕食品吸收，所以食品濕度越大，加熱時間越短。
食品形狀	因為微波只能穿透食品表面以下2-4公分，所以食品的厚薄會影響到加熱時間。
食品密度	緊密的食品與疏松的食品加熱時間不同，前者所需時間要長一些。
食品數量	微波能量是一定的，不因食品的多少而改變，所以食品數量越大，所需加熱時間越長。
骨頭和脂肪	骨頭傳熱較快，肥肉吸收微波能量較多，所以烹調帶骨和帶脂肪的肉類注意局部過熱。
加蓋	將食品放入帶蓋容器烹調，可以減少熱量和蒸氣的散發，縮短烹調時間。
放置	食品烹調時應均呈環狀擺放，盡量避免疊放，這樣有利于提高均勻性。
攪拌	當加熱湯、汁料或飲品等液體食物時，加熱前以及加熱過程中略加攪拌，可有效防止液體沸濺。
加封	用保鮮膜包蓋食品，可以防止湯汁飛濺弄髒爐腔，而且可以保持水分和營養。
擱置	食品從微波爐取出後，食品內部仍在加熱，可以擱置一段時間，火候因素應予考慮。

## 保養 · 維修

保養：經常性的清潔保養，是微波爐正常工作的保證。



外殼層，使用軟布蘸肥皂水清潔，並用柔軟的幹布擦淨，避免水滲入爐腔中。

用濕布清除爐門、門封和爐腔內的食物屑，用濕布蘸肥皂水清除油垢。

保持爐門內部的清潔，避免留有食物殘渣，引起爐腔打火或產生異味，同時防止油垢腐蝕轉輪或爐腔內生成鏽斑。

一周至少將其取出一次，放入肥皂水中清洗，防止油垢腐蝕轉輪。

如果電源軟線損壞，為避免危險，必須由制造廠或其維修部或類似的專職人員來更換。

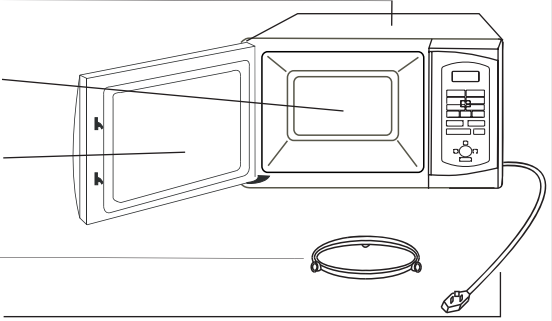

注：微波爐長期不用時，應拔掉電源插頭並將爐體各部位可能殘留的水漬、油垢擦乾淨，放在乾燥通風的環境中，避免生鏽。

 **警告** 如果微波爐工作異常或損壞，在專業維修人員維修完畢之前，請不要繼續使用。

## 疑難解答 · 售後服務

在維修微波爐時維修人員應注意：

易被拆掉並可能觸及到250V電壓以上的部件	可導致過度微波泄漏的元件及原因
磁控管	1. 磁控管：在波導上安裝不當
高壓變壓器	2. 門鉤及門體、上下鉸鏈：安裝不當
高壓電容器	3. 門體、外殼：發生損壞
高壓二極管	
整流器	

**微波輻射**

不要將身體任何部位暴露在由微波發生器或其它傳導微波能部件所發出的輻射中！

## 疑難解答 · 售後服務

### 問題解答

為什麼爐燈不亮？

- 1、燈泡壞了；
- 2、未定時。

為什麼微波爐不工作？

- 1、沒插電源；
- 2、微波爐用的插座壞了；
- 3、爐門關閉不嚴，導致開關不閉合。

為什麼啓動時有“嘭”的聲音？

此屬正常現象，是變壓器高電壓高頻率情況下工作的啓動聲音。

為什麼工作時噪音大？

- 1、轉盤支架沒放正；
- 2、玻璃轉盤放歪；
- 3、將變壓器、磁控管及高速散熱風扇的工作聲音和較小的共振聲音誤認爲噪音。

為什麼不加熱或加熱慢？

- 1、沒通電源；
- 2、在進行功能選擇時，沒選加熱功能。

為什麼蒸汽會從排風口冒出？  
為什麼有水從爐門下溢出？

蒸汽冒出是烹調過程中的正常現象，有時因蒸氣過濃，聚集在爐內，凝結成水並溢出，這是正常的。

微波能量能從爐門屏觀察窗向外泄漏嗎？

不能，金屬屏障將微波能量反射回爐內。觀察窗只允許光線通過，微波無法通過。

如果在沒有放入食物的情況下啓動微波爐會損傷微波爐嗎？

是的，決不要這樣做。

為什麼烹調結束後需擱置？

擱置幾分鐘很重要。微波烹調使食物集聚熱量，在從爐中取出食物之後，食物內部要繼續加熱2-3分鐘，擱置可使食物關節部分、大塊蔬菜或糕點在爐外進行徹底烹調。

為什麼我的微波爐烹調食物不像說明書說的那樣快？

檢查使用說明，看看是否完全遵守指令，查明設定不同時間的原因。烹調時間的設定只作參考，爲防止過度烹調，要掌握微波烹調技巧。食物的體積、重量、形狀對烹調時間都有影響。電壓低於210V，加熱慢；爐門關閉不到位或電壓低於190V，不加熱。以指令作爲參考，靈活掌握。

為什麼有時烹調時會發生閃電和清脆的響聲？

- 原因有以下幾點：
1. 使用了含金屬成分的餐具（包括金、銀）；
  2. 將叉子或其他金屬用具遺忘在爐內；
  3. 使用過多的金屬箔；
  4. 使用金屬絲捆綁食物。

為什麼微波爐工作時會發出“嗡嗡”的聲音？

微波爐工作時高壓變壓器以及風扇正常工作時發出的聲音，屬於正常現象，請放心使用。

為什麼不用擔心微波泄漏？

微波泄漏量國家標準爲5mW/cm<sup>2</sup>，海爾現場生產控制遠低於國家標準。

爐門有一定晃動會引起微波泄漏嗎？

不會。

微波爐工作時有風、燈光或氣味出來會引起微波泄漏嗎？

不會，這屬於正常現象。

## 烹調器皿的選用

### 微波烹調器皿的選用

微波特性

使用微波爐請選用合適的烹調器皿



食物吸收



玻璃透射

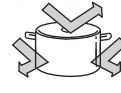

金屬反射

容器的種類	微波烹調	燒烤烹調	組合烹調
耐熱性 玻璃容器 	✓ 可用	✓ 可用	✓ 可用
非耐熱性 玻璃容器 	✗ 不可用	✗ 不可用	✗ 不可用
耐熱性 塑料容器 	✓ 可用 • 請使用有[可微波爐用]標識的容器。	✗ 不可用	✗ 不可用
非耐熱性 塑料容器 	✗ 不可用 • 受微波影響變質的容器不能使用。 • 只有在解凍生鮮食品時，泡沫托盤才可以使用。	✗ 不可用	✗ 不可用
陶、瓷 容器 	✓ 可用 • 有彩圖、金銀裝飾的容器不能使用。	✓ 可用 • 內側有彩圖的容器會引起顏色剝落，避免使用。	✓ 可用
漆器 	✗ 不可用 • 有可能發生漆脫落、斷裂現象。	✗ 不可用	✗ 不可用
鉛等金屬 制成的容器 	✗ 不可用 • 金屬網等也會引起火花，不能使用。 • 微波爐專用的著色用盤（金屬制品）也不能使用。	✓ 可用 • 把手是樹脂材料的話，也不能使用。	✗ 不可用
木·竹· 紙制品 	✗ 不可用 • 容易燃燒。	✗ 不可用 • 經過耐熱加工處理的紙制品能使用。	✗ 不可用
保鮮膜、 耐熱PE袋 	✓ 可用 • 多油料理（如烹調肉類及油炸食品）會產生高溫，不能使用。	✗ 不可用 • 經受高溫會熔化。	✗ 不可用
鋁箔 	✗ 不可用 • 解凍食品時可適當使用。	✓ 可用 • 鋁箔把食物包好進行烘烤。	✗ 不可用

注：料理完畢後，玻璃轉盤要自然冷卻，不要用冷水沖洗，否則會造成玻璃轉盤爆裂。

# Contents

## Before Use

Features .....	2
Technical Specifications .....	2
Circuit Diagram .....	3
Parts and Accessories .....	3
Safety Precautions .....	4-5
Placement .....	5
Unpacking • Installing .....	6

## Use Your Oven

Control Panel .....	7
Use Your Oven .....	8-12
Tips for Microwave Cooking .....	12

## Maintenance • Repair

Maintenance • Repair .....	12-13
Questions & Answers .....	13-14
How to Select Cooking Utensil .....	15

### Remarks:

• The manual is checked carefully for the purpose of proper and precise, but still there may exist defects on editing, printing etc. that may cause some difference between the content and the practical situation. Please contact us in case of such defects occurred and resulting in any inconvenience.



## Before Use

The series of microwave oven comply with following national standards:

**GB4706.21-2002 “Safety of household and similar electrical appliances—Particular requirements for microwave ovens”**

**GB/T 18800-2002 “Household microwave oven—Methods for measuring performance”**

**GB4706.22-2002 “Safety of household and similar electrical appliances—Particular requirements for stationary cooking ranges, hobs, ovens and similar appliances”**

Dear users,

Thank you for purchasing Haier products!

Haier products are featured with high quality and outstanding performance. To facilitate you to use the product, please read the manual thoroughly and follow the instructions during operating.

Haier’s International Star Service will always accompany you. No matter what problems you meet in usage, please contact us by the telephone number and address stated in the Certificate of Quality. We are at your service all the time. Thanks again for choosing Haier products. Due to the improvement and modification, the microwave oven you purchased may not be exactly in accordance with the figures of the manual.

Important safety instructions: please read the manual thoroughly, and keep it for future reference.

## Features

### 1. Prominent Appearance

The idiographic appearance with patent design has a prominent style, unique and attractive.

### 2. Convenient operation

All of the functions are realized by thin film switches, complete and easy to use.

### 3. Safe in usage

Benefited from integrated stamping forming technology and unique choke structure, the door of the oven can effectively avoid microwave radiation. It also adopts two-step interlock and opening monitor system, which can switch off the power supply automatically if the door is opened, thus ensure the safe usage.

### 4. Healthy ensured by sterilizing

The microwave and light wave can eliminate the bacteria and virus of the food to a certain extent.

### 5. Light wave grilling

The oven utilizes particular light wave grilling technology to acquire better cooking effect.

## Technical Specifications

Model	Power voltage (V/Hz)	Input (W)	Output (W)	Grilling power (W)	Microwave frequency (MHz)	Cavity volume (L)	Outside dimensions (H x W x D)	Effective cavity dimensions (H x W x D)
MA-2270EGC	~220/50	1200	700	950	2450	22	288x486x376	196x311x312

Please note that the dimensions and volume are estimated values. Due to the continuous improvement, the technical specifications may be different from the above table, which will not be informed separately.

## Circuit Diagram

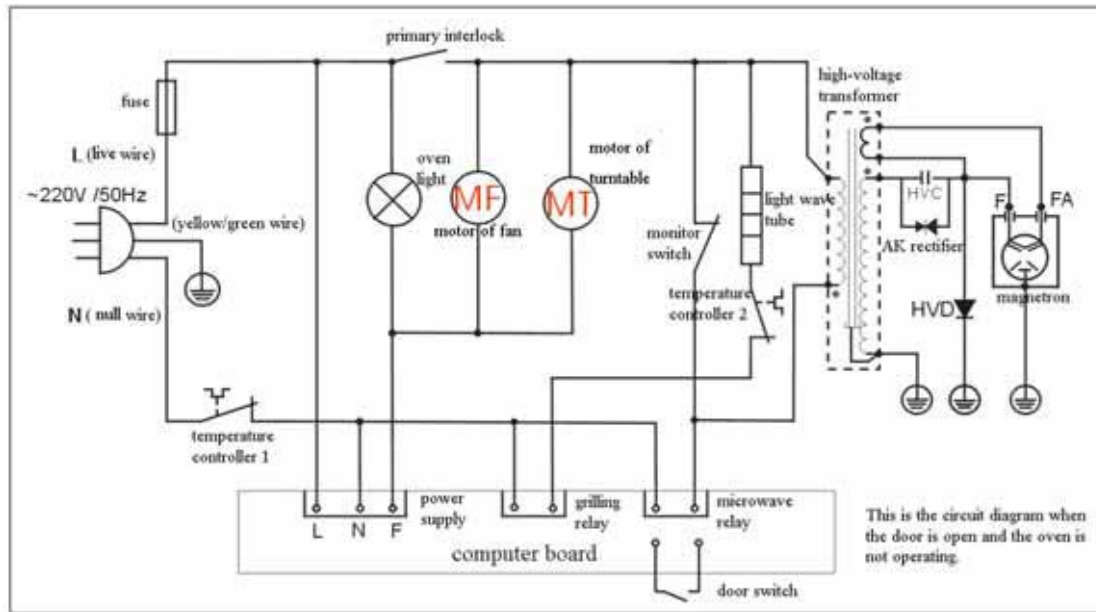



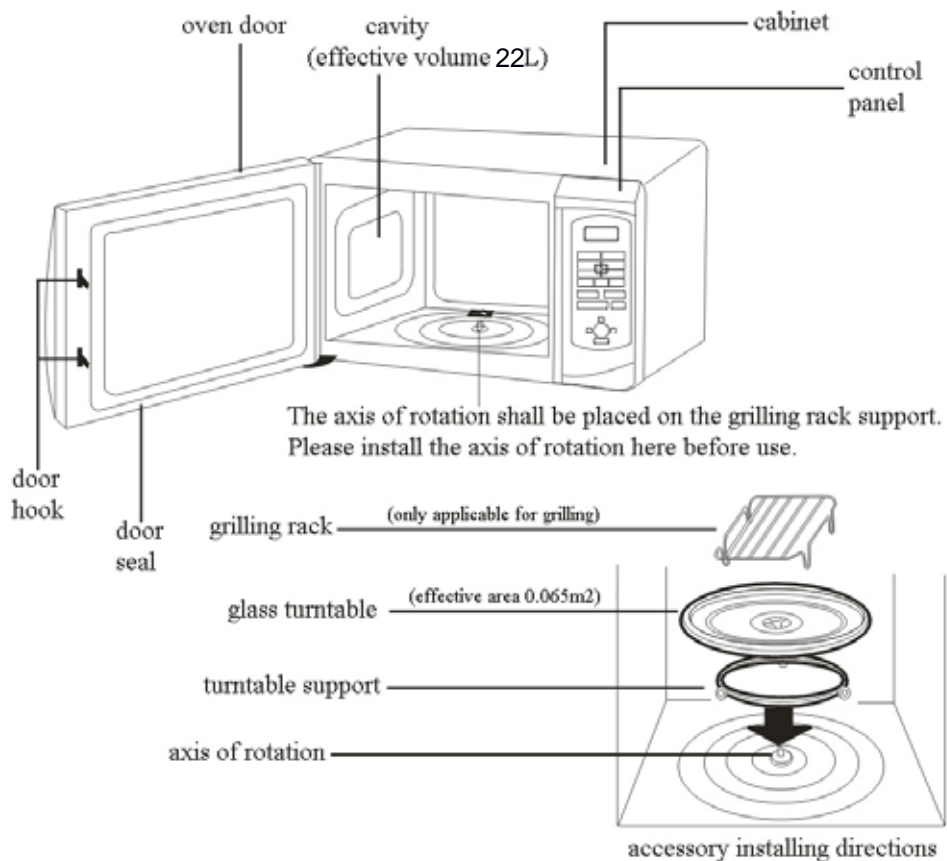













## Parts and Accessories



## Safety Precautions:

- Please read the safety precautions thoroughly for safe and convenient usage of Haier microwave oven.

 Danger	 Warning	 Attention	 Electric shock	 Do not remove
<p>The oven shall not be decomposed by anyone except the professional maintenance personnel. Electric shock may occur!</p> 		<p>Do not put metal stick into the interlock hole at the front side of cavity. It may cause microwave leakage!</p> 		
<p>Do not add excessive force to the opposite direction on the door. It may deform the door and cause microwave leakage!</p> 		<p>Do not use enclosed container in cooking. For food with skin, remember to puncture it before cooking, unless you use certain container as accessory of the oven (such as the steam pot).</p> 		
<p>Do not cook eggs with shell to avoid bursting.</p> 		<p>Remove the grease remained in the cavity before cooking. Combustible cookware like plastic container is not recommended, as it may cause smoke or fire in heating. Please keep an eye on the oven during cooking. Do not leave for a long time.</p> 		
<p>After cooking is finished, take care when opening the container or removing the cover film. It may emit hot vapor and cause scalding!</p> 		<p>Make sure to ground the microwave oven reliable in installation.</p> 		
<p>Do not touch the view window and the upper part of the cabinet to avoid scalding.</p> 		<p>Do not use microwave oven if it is empty. It may damage the oven!</p> 		
<p>Do not use metal container in microwave cooking or combination grilling. It may ignite!</p> 		<p>If the cavity is under high temperature (e.g. after cooking), do not use the oven immediately. Please wait for it cooling down before next usage.</p> 		

## Safety Precautions



### Warning

- Warning: if the door or door seal is damaged, DO NOT use it until it is repaired by proper qualified maintenance personnel.
- Warning: No one except the proper qualified maintenance personnel shall make inspection and maintenance, including operations like dismantling the protective cover that prevents microwave energy from leaking.
- Warning: DO NOT cook liquid or food within enclosed container. It may cause explosion!
- Warning: Children are not allowed to use the microwave oven without supervision, unless they have received sufficient instructions enough to use the oven with safe method, and understand that improper method can result in danger.
- Use only cookware applicable for microwave inside the oven.
- When cooking food packed with plastic or paper, please keep an eye on the oven because there's a chance to ignite.
- If smoke should occur, pull off the power plug immediately and close the door of oven to control the spreading of fire.
- The beverage heated with microwave oven may delay in boiling or splashing. Please take care of it when taking out the beverage.
- Feeding bottles and baby food cans shall be stirred or shaken. Please check the temperature of the food inside the bottle to avoid scalding.
- DO NOT cook fresh or boiled eggs with shell, as they may burst during heating or even after heating, unless you use certain container as accessory of the oven (such as the steam pot).
- DO NOT operate the microwave oven when it is empty. No-load operation will damage the oven.
- DO NOT place combustible materials near the microwave oven. Please keep an eye on the cooking during operation, and set proper cooking time. Overcooking may cause fire.
- Light food with little water may be uneven in heating, as different materials have different capability in absorbing microwave.
- Do not perform defrost immediately after grilling or long-time heating with microwave. Please wait for the cooling down of the bottom tray.
- Do not use sharp items (such as steel wire ball, spade) to clean the glass turntable.
- DO NOT pierce the mesh of the oven door. It may cause microwave leakage!

DO NOT use the product for industrial and commercial purpose!

### Placement

Make sure to keep ventilation space for the microwave oven in installing. Do not place it in environment with high humidity and temperature.



Keep the oven away from TV, radio etc. Otherwise it will interfere the signals and make noises. It is improper to measure microwave radiation with radio. Please use professional device to make measurement.

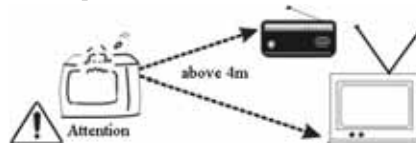

## Unpacking • Installing

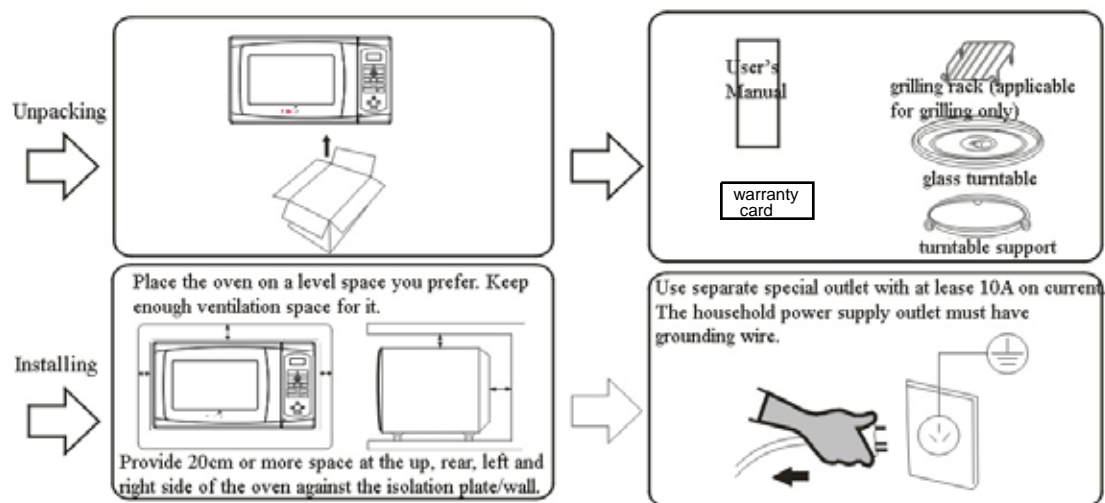

## Control Panel

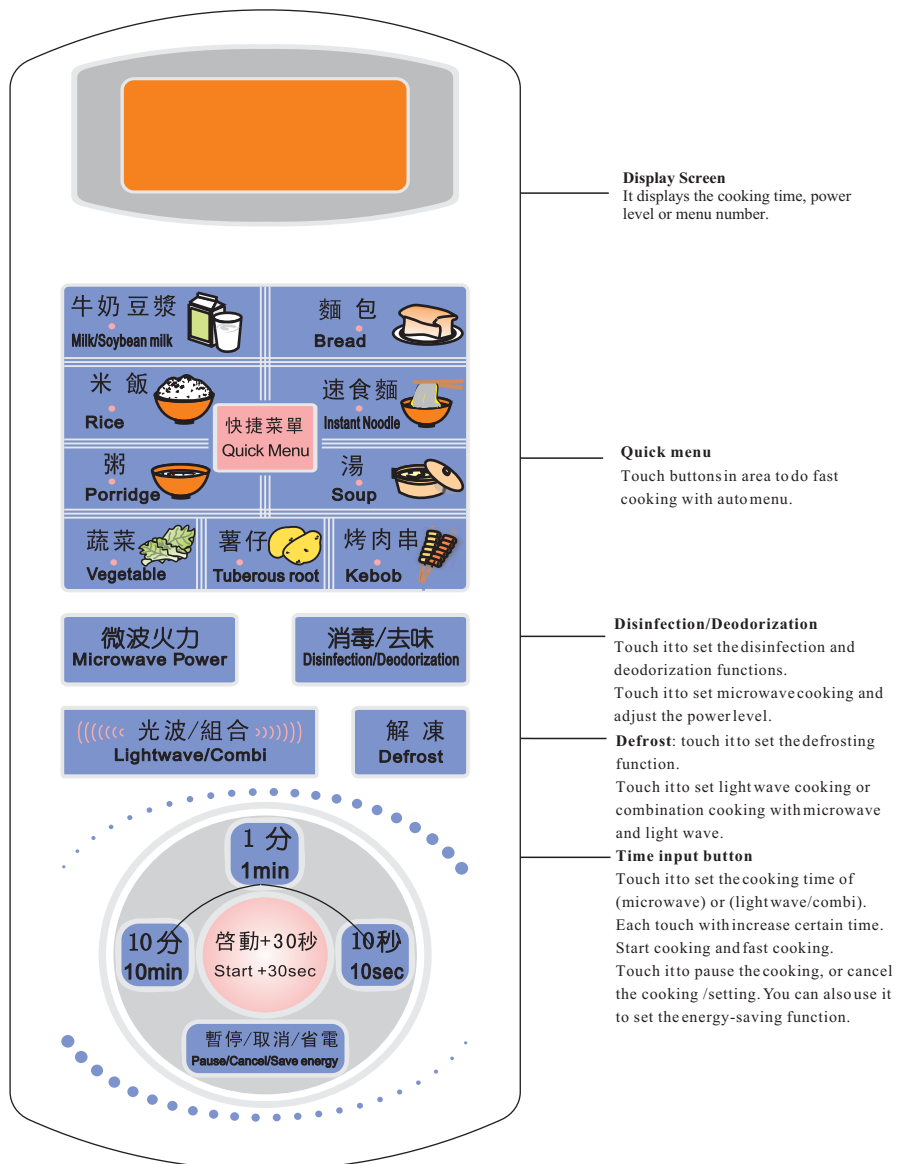

### Display Screen

It displays the cooking time, power level or menu number.

### Quick menu

Touch buttons in area to do fast cooking with auto menu.

### Disinfection/Deodorization

Touch it to set the disinfection and deodorization functions.  
Touch it to set microwave cooking and adjust the power level.

**Defrost:** touch it to set the defrosting function.  
Touch it to set light wave cooking or combination cooking with microwave and light wave.

### Time input button

Touch it to set the cooking time of (microwave) or (light wave/combi). Each touch will increase certain time. Start cooking and fast cooking.  
Touch it to pause the cooking, or cancel the cooking /setting. You can also use it to set the energy-saving function.

## Use Your Oven

### 1. Set microwave power level and heat.

The microwave oven offers five power levels: high – 700W; medium high – 600W; medium – 450W; medium low – 250W; low – 120W. Touch the “microwave power” button repeatedly, the display screen will show the power level in the sequence of P-1, P-2, P-3, P-4 and P-5 (in which P-1 indicates 100% power). To use the microwave cooking, please first set the power level, and then set the cooking time. Then touch the “Start + 30sec” button to start cooking. The max cooking time is 60 minutes.

Example: to do microwave cooking with 600W power level for 10 minutes.

1. Put food into the cavity, and close the oven door.
2. Switch on the microwave oven. The oven enters stand-by mode. The Display screen shows **0:00**.
3. Touch the “microwave power” twice. The Display screen shows **P-2**.
4. Touch the time input button “10min” once. The Display screen shows **1 0:00**.
5. Touch the “start + 30sec” button. The oven starts operating. The Display screen shows the counting down time dynamically.
6. After the cooking is finished, the control panel will remind you with a ring. The microwave oven enters stand-by mode.

### 2. Set grilling power level and heat.

To facilitate your usage, the oven offers three types of grilling method for your option. To set the grilling: touch the “light wave/combi” button repeatedly under stand-by mode (the Display screen shows **0:00**). The display screen will show in the sequence of **G**, **C-1** and **C-2**. **G** indicates 100% light wave; **C-1** indicates combination grilling of 12/60 microwave and 48/60 light wave; **C-2** indicates combination grilling of 30/60 microwave and 30/60 light wave. To use the light wave or combination cooking, please first set the power level, and then set the cooking time. Then touch the “Start + 30sec” button to start cooking. The max cooking time is 60 minutes.

(Remarks: “C-1” is suitable for grilling thin blocks of food; “C-2” is suitable for grilling large blocks of food.)

Example: to do cooking with **C-1** for 16 minutes

1. Put the food into cavity and close the oven door.
2. Touch the “light wave/combi” button twice under stand-by mode. The Display screen shows: **0:00 → G → C-1**.
3. Touch the time input button “10min” once, and repeat touching “1min” for six times. The Display screen shows **1 6:00**.
4. Touch the “start + 30sec” button. The oven starts operating. The Display screen shows the counting down time dynamically.
5. After the cooking is finished, the control panel will remind you with a ring. The microwave oven enters stand-by mode.

### 3. Use the “quick menu” button

The “quick menu” (auto menu) includes milk/soybean milk, instant noodle, bread, rice, porridge, soup, vegetable, tuberous root and kebob. Under stand-by mode, if you touch one of the buttons once, the microwave oven will start cooking with the selected menu and default food weight.

## Use Your Oven

Then the Display screen shows the counting down time set by the program dynamically.

**Example:** To cook a pack of instant noodle.

1. Add the instant noodle and some water (about 400ml, with room temperature) into microwave-safe container with suitable volume. Close the cover (or seal it with microwave-safe film, but leave 2mm gap at the side of film). Place the container into the cavity and close the oven door.
2. Touch the “instant noodle” button of the “quick menu” area. The oven will start cooking with the default instant noodle weight “0.1kg” for the default cooking time of 5 minutes. Then the display screen will show the counting down cooking time **5:00** dynamically.
3. After the cooking is finished, the control panel will remind you with a ring. The microwave enters stand-by mode.

**Example:** To grill 0.1kg kebob

1. Cover the grilling rack with vegetable leaves, and place the grilling rack into the cavity. Put the 0.1kg kebob on the vegetable leaves, and close the oven door.
2. Touch the “kebob” button of the “quick menu” area. The oven will start cooking with the default kebob weight “0.1kg” for the default cooking time of 12 minutes. Then the display screen will show the counting down cooking time **12:00** dynamically.
3. When the remaining cooking time is 3 minutes, the buzzer of control panel will ring three times. You can open the oven door directly and add spices by your flavor taste.
4. After the cooking is finished, the control panel will remind you with a ring. The microwave enters stand-by mode.

### Directions of the “quick menu”

Menu	Food weight (kg)	Directions
Milk/soybean milk	0.25	Use this menu to heat the cold milk or soybean milk. First remove the package of milk/soybean milk. Then pour it into a microwave-safe ceramic cup or glass. DO NOT use plastic bag or aluminum foil paper package. Place the container into the oven. Start heating with “high” power level for about 1 minute or 1 minute and a half. After heating, please pour it into other container and stir gently before drinking.
Instant noodle	0.10	Add the instant noodle and some water into a microwave-safe container with suitable volume. Close the cover (or seal it with microwave-safe film, but leave 2mm gap at the side of film). Place the container into the cavity and close the oven door. The reference water quantity: 400ml (room temperature)
Bread	0.10	Put the bread on a microwave-safe dish, and cover with preservative film to avoid moisture losing. Touch the “bread” button to start automatic cooking.
Rice	0.20	Add the rice (cleaned with water) and some water (with room temperature) into a microwave-safe container with suitable volume. Close the cover and put the container into the cavity. Touch the “rice” button to start automatic cooking. After the cooking is finished, the rice can serve immediately, or be set aside for 3-5 minutes. Remarks: the food weight refers to the weight of rice. Do not add too much water into the container. The total volume of rice and water should not exceed a half of the container volume. Otherwise it may cause spilling. Reference water quantity: 400ml (room temperature).
Porridge	0.10	Wash the rice. Add the rice and some water into a microwave-safe container with steep shape. Close the cover and put the container into the cavity. Touch the “porridge” button to start automatic cooking. After the cooking is finished, set aside for 3-5 minutes. Remarks: the food weight refers to the weight of rice. The total volume of rice and water should not exceed a half of the container volume, and avoid usage of preservative film. Otherwise it may cause spilling. Reference water quantity: 1200ml (room temperature)



## Use Your Oven

Menu	Food weight (kg)	Directions
Soup	0.50	Use it to cook several types of soup including white fungus soup, bean curd soup etc. Mix the following ingredients evenly, and then put them into the microwave-safe container. Close the cover and put the container into the cavity. Touch the “soup” button to start automatic cooking. After the cooking is finished, you can set it aside for 2-3 minutes by your flavor taste. 1. White fungus soup: 70g white fungus, 50g crystal sugar, 500g hot water, 50g medlar, 50g osmanthus flower, 5g salt 2. Bean curd soup: 20g bean curd, 5 pieces of sea moss, 500g hot water, 15g salt, 5g or more oil, 1/2 spoon of celery powder, 1/2 spoon of crystal sugar. 2 spoons of chicken essence. Remarks: the food weight refers to the weight of hot water. Avoid utilizing of preservative film as cover.
Vegetable	0.20	Here use the cabbage, one of the leaf vegetable for example: wash the cabbage. Cut it into long strips with length of 2-3cm. Mix with some salt, oil, soy sauce and other spices evenly. Put them into a microwave-safe container. Cover the container with microwave-safe film. Put the container into the cavity. Touch the “vegetable” button to start automatic cooking. You can open the door and turn over the food for two or three times during cooking. After the cooking is finished, you can set aside by your flavor taste for 2-3 minutes to cook the stem part completely. Remarks: “vegetable” refers to leaf vegetable such as cabbage, spinach etc. The food weight refers to the weight of vegetable.
Tuberous root	0.20	Here use the carrot, one of the tuberous vegetable for example. Wash the carrot. Cut it into round slices with thickness of 2-3mm. Mix with some salt, oil and other spices evenly. Put them into a microwave-safe container. Add 10-15g water with room temperature. Cover the container with microwave-safe film. Put the container into the cavity. Touch the “tuberous root” button to start automatic cooking. You can open the oven door to turn over the food for two or three times during cooking. After the cooking is finished, mix the food evenly and transfer it to dish for serving.
Kebab	0.10	Cover the grilling rack with vegetable leaves, and place the grilling rack into the cavity. Put the 0.1kg kebob on the vegetable leaves, and close the oven door. Touch the “kebob” button to start automatic cooking. You can open the oven door and turn over the food for two or three times during cooking. When the remaining cooking time is 3 minutes, the buzzer of control panel will ring three times. You can open the oven door directly and add spices by your flavor taste.

Remarks: (1) None of the weight of instant noodle, rice and porridge includes water.

(2) The cooking times mentioned above are only for reference due to the influence of factors like personal flavor taste etc.

## 5. Automatic Defrosting

Touch the “defrost” button repeatedly. The weight setting will change in the sequence of 0.2, 0.4, 0.6kg. The Display screen will show the corresponding defrosting time simultaneously. Please first set the food weight, and then touch the “start + 30sec” button. The microwave oven will then start operating with the selected time and program. The Display screen will show the counting down time dynamically during operation. After the defrosting is finished, the control panel will remind you with a ring. The microwave oven returns to stand-by mode.

Remarks: In defrosting 0.6kg food with “defrost” function, the control panel will ring three times at certain remaining time. You can then open the oven door directly, turn over the food, and close the door. Then touch the “start +30sec” button to continue defrosting.

**Example:** To defrost 0.6kg frozen meat with the automatic defrosting function

1. Wrap the 0.6kg frozen meat with microwave-safe film. Put it into a microwave-safe container. Place the container into the cavity and close the door.
2. Touch the “defrost” button three times under stand-by mode to set the food weight to 0.6kg.
3. Touch the “start +30sec” button to start operating. The Display screen shows the counting down time **10:06** dynamically.
4. When the remaining time is 5 minutes and 3 seconds, the control panel will remind you with three buzzer rings. Please open the oven door and turn over the food. Then please close the door and touch “start +30sec” button to continue defrosting.

## Use Your Oven

5. When the defrosting is finished, the control panel will remind you with a ring. The microwave oven returns to stand-by mode.

**Food weight/defrosting time table for “Defrost” function**

	Food weight (kg)	Defrosting time	Buzzer action
Defrost	0.20	3'22”	
	0.40	6'44”	
	0.60	10'06”	Ring three times at remaining time of 5'03”

Remarks:

- (1) It is suggested to put frozen food on steam cloth to acquire better defrosting performance.
- (2) Do not open the oven door during defrosting, except for turning over the food as prompted.
- (3) It is suggested to remove the package paper or plastic of the food. Otherwise it may produce vapor or moisture, and result in over-defrosting on the surface of food.
- (4) Please wrap the thin part of food with aluminum foil to avoid over-defrosting.
- (5) It is recommended to set aside the food for 5 minutes after defrosting is finished.
- (6) The defrosting times mentioned above are only for reference due to the factors like food density etc.

## 6. Disinfection/deodorization

(1) Disinfection function: the operating time is 5 minutes. Touch the “disinfection/deodorization” button under stand-by mode to set the disinfection function. The Display screen will show **A**, which is the identification mark of disinfection function. Put the cookware, towel etc. that need disinfection into the microwave cavity. Close the door. Touch the “start +30sec” button directly. The oven will start operating for 5 minutes. During operating, the Display screen will show the counting down time from default time of **5:00** dynamically. After the disinfection operating is finished, the control panel will remind you with a ring. The microwave oven returns to stand-by mode.

(2) Deodorization function: the operating time is 5 minutes. Touch the “disinfection/deodorization” button twice under stand-by mode to set the deodorization function. The Display screen will show **AA**, which is the identification mark of deodorization function. Touch the “start +30sec” button directly. The oven will start operating for 5 minutes. During operating, the Display screen will show the counting down time dynamically. After the deodorization operating is finished, the control panel will remind you with a ring. The microwave oven returns to stand-by mode.

Remarks:

- (1) The microwave oven can not disinfect food. Please do not put food into the oven for disinfection.
- (2) The disinfection/deodorization function can be performed directly after cooking to eliminate the bacteria and remove the odor inside the cavity.

## 7. Pause/cancel/save energy

(1) “Pause” function: if you must go away during cooking, you can touch the “pause/cancel/save energy” button once. The cooking will pause till you return and touch the “start +30sec” button. The microwave oven will then continue cooking.

(2) “Cancel” function: during cooking operation, if there’s something wrong with the operating, or if you need to change the current setting of program, you can touch the “pause/cancel/save energy” button twice. The current setting will be cancelled and the microwave oven will return to stand-by mode. Then you can make new setting.

(3) “Save energy” function: touch the “pause/cancel/save energy” button once under the stand-by mode, and the microwave oven will enter energy-saving mode. All of the display screen indicators will be switched off. There’s no display on the screen. You can then touch any key to resume the display of screen and the microwave oven will then return to stand-by mode.

## Use Your Oven

### 8. Child lock

(1) To set the child lock: touch the “pause/cancel/save energy” button, and hold for 3 seconds under stand-by mode (it must be executed under stand-by mode). It will enter “child lock” mode after a long ring. The Display screen will show  icon, which is the identification symbol of child lock function. Any setting of microwave cooking will then be invalid.

(2) To cancel the child lock: touch the “pause/cancel/save energy” button and hold for 3 seconds under child lock mode. It will release the child lock after a long ring. The child lock symbol on the display screen will disappear, and the microwave oven will return to stand-by mode. The child lock can also be released by switching off the power supply of the microwave oven.

### 9. Quick start

You can touch the “start +30sec” button directly under the stand-by mode without setting cooking time. The microwave oven will then start operating for 30 seconds with 100% power level. From 0 to 5 minutes, each touch will increase 30 seconds; from 5 to 10 minutes, each touch will increase 1 minute; from 10 to 30 minutes, each touch will increase 2 minutes; the max cooking time that can be set with “quick start” function is 30 minutes. (Attention: when the operating time reaches the period between 28-30 minutes, touching the “start +30 sec” button will increase the cooking time to 30 minutes directly).

## Tips for Microwave Cooking

### Tips for microwave cooking

Food temperature	The lower the food temperature is, the longer the cooking time will cost. The frozen food generally costs longer time than the common food.
Food humidity	Humid food absorbs more microwave energy. Thus the higher the food humidity is, the shorter the cooking time costs.
Food shape	The microwave can only pass through the food for 2-4cm under surface. Therefore the thickness of the food will influence the heating time.
Food density	Different density requires different heating time. Food with high density will cost longer cooking time.
Food quantity	The microwave energy is fixed and will not change with the quantity of food. Therefore large quantity of food will cost long cooking time.
Bones and fat	Bones can transfer heat faster than common food. Fat can absorb more microwave energy. Therefore please pay attention to overheating on certain part when you cook meat with bones and fat.
Cover	It will reduce losses of heat and vapor by putting the food into container with cover, and thus will shorten the cooking time.
Placement	Place the food in circular shape and avoid piling up. It can improve the evenness during cooking.
Stirring	In heating liquid food like soap, juice or beverage, please stir the liquid both before and halfway during heating. It can effectively prevent the liquid from boiling and splashing.
Sealing	Sealing the food with preservative film can prevent the liquid from splashing and soiling the cavity. It can also keep the moisture and nutrition of the food.
Standing	After cooking is finished, the food taken out of the oven is still being heated inside. Considering of the flavor and cooking degree, you can give it some standing time.

## Maintenance • Repair

**Maintenance:** Periodical maintenance and cleaning can guarantee the normal operation of microwave oven.

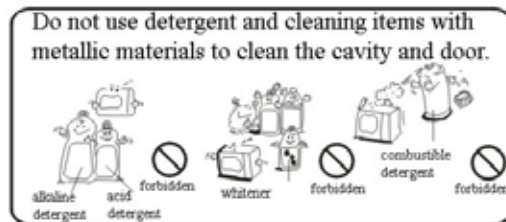
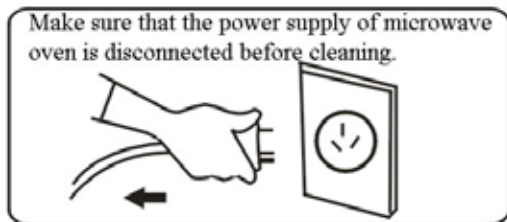

Use soft cloth and neutral soapy water to clean the cabinet, and wipe it with soft dry cloth.

Use humid cloth to clear the food scrap on the door, door seal and inside the cavity. Use wet cloth and soapy water to clear the greasy stain.

Keep the inner side of the door clean. Remove any food residue as it may cause igniting, smell or rusty spot inside the cavity, and corrode the axis of rotation.

Please take it out and wash with soapy water at least once a week to prevent the grease from corroding the axis of rotation.

If the power supply cable is damaged or faulty, make sure to have it replaced by the professional maintenance personnel of the manufacturer or after-sale services department.

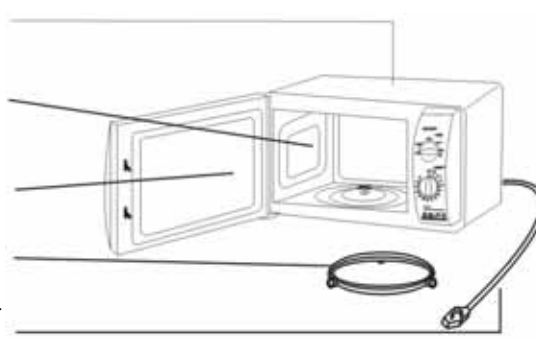

Remarks: If the microwave oven is idle for a long time, please clean the water stain and greasy stain that may remain on each part of the oven, and place it in dry environment with good ventilation to avoid rusting.

**Warning** If the microwave oven has abnormal operation or is damaged, DO NOT use it any more before it is repaired by professional maintenance technicians

## Questions & Answers • After-sale Services

**In maintenance or repair, the maintenance personnel shall pay attention that:**

Components easy to dismantle and likely to contact voltage above 250V:

1. Magnetron
2. High-voltage transformer
3. High-voltage capacitor
4. High-voltage diode
5. AK rectifier

Components that may cause excess microwave leakage and the reason:

1. Magnetron: improper installation on the wave guide
2. Door hook, body and up/down hinges: improper installation
3. Door body and cabinet: damaged

### Microwave radiation

Do not expose any part of your body to the radiation of the microwave generator or other components that transfer the microwave energy!

1. Please stick the invoice onto the corresponding column of the certificate of quality, and keep it for future reference.
2. The product enjoys one year of warranty (from the date of purchase). You can contact the Haier designated service department or company for maintenance, which will be free of charge during the warranty period.
3. Any of the following cases shall be charged on maintenance:
  - (1) The oven is damaged owing to improper usage.
  - (2) The oven is damaged by unauthorized dismantling.
  - (3) The invoice and certificate of quality can not be presented.
  - (4) The invoice or certificate of quality is altered without authorization.
  - (5) The warranty period is exceeded.

## Questions & Answers

### Questions & Answers

Why doesn't the oven light glow?	<ol style="list-style-type: none"> <li>1. The oven light is faulty.</li> <li>2. The timer is not set.</li> </ol>
Why doesn't the oven operate?	<ol style="list-style-type: none"> <li>1. The power supply is off.</li> <li>2. The outlet for the oven is faulty.</li> <li>3. The door is not closed completely, thus the safety system prevents the power supply from switching on.</li> </ol>
Why does the oven start with a sound like striking?	It is a normal sound indicating that the transformer starts operating under high voltage and frequency.
Why does the oven make large noises in operating?	<ol style="list-style-type: none"> <li>1. The turntable support is defective.</li> <li>2. The glass turntable has malposition.</li> <li>3. The transformer, magnetron and high-speed venting fan will make sound during operation, and there may be resonant sound.</li> </ol>
The heating is slow, or does not work?	<ol style="list-style-type: none"> <li>1. The power supply is off.</li> <li>2. The heating function is not set during function setting.</li> </ol>
Why does vapor come out of the air discharge outlet? Why does water flow out below the door?	It is normal that the vapor may appear during cooking. Sometimes the vapor is too thick and gathered inside the oven, and finally condensed into water which may flow out. It is normal phenomenon.
Does microwave energy pass through the view window on the door?	No. The metal shield will reflect the microwave energy back to the oven. The view window only allows harmless light to pass through. The microwave can not pass through it.
If the oven is started without food, will it be damage?	Yes. NEVER do that.
Why is standing time recommended after microwave cooking is over?	It is important to give the food several minutes for standing time. Food cooked with microwave oven gathers heat inside. After you take out the food from the oven, the food will continue heating inside for 2-3 minutes. It can evenly and completely cook the jointer of the food, big block of vegetables or cookies outside the oven.
Why doesn't my oven always cook as fast as the cooking guide says?	Check your cooking guide again to make sure you've followed directions correctly, and to see what might cause variations in cooking time. Cooking guide times are only suggestions. To prevent overcooking, you should learn the cooking tips with microwave oven. Variations in the size, shape, weight and dimensions of the food require different cooking time. If the voltage is below 210V, the heating will be slow; if the door is not closed completely or the voltage is below 190V, the heating will not work. Please use the cooking guide as reference along with your own judgment.
Why is there arcing or cracking sound during cooking sometimes?	<p>It may be caused by following reasons:</p> <ol style="list-style-type: none"> <li>1. Cookware has metal part (including gold and silver);</li> <li>2. Fork or other metal dishware are left in the oven;</li> <li>3. Too many metallic foil are used;</li> <li>4. Metallic thread is used to bind the food.</li> </ol>
Why does the oven make humming sound during operation?	It is the sound made by high-voltage transformer and fan during operation. It is normal phenomenon and has no influence on your safe usage of the oven.
Why should I rest assured on microwave leakage?	The national standard of microwave leakage is $5\text{mW}/\text{cm}^2$ . The field control value of Haier is by far lower than the national standard.
The door can be slightly swayed. Will it cause microwave leakage?	No.
The oven may give off vapor, light or smell during operation. Will it cause microwave leakage?	No. It is normal phenomenon.

## How to Select Cooking Utensil

### Selection of the microwave cooking utensil

Please select suitable cookware for the microwave oven

The features of microwave



absorbed by food



passing through glass



reflected by metal

Container type	Microwave	Grilling	Combi
Heatproof glass container	√ Applicable	√ Applicable	√ Applicable
Non-heatproof glass container	× Not applicable	× Not applicable	× Not applicable
Heatproof plastic container	√ Applicable . Please use containers with “microwave-safe” mark.	× Not applicable	× Not applicable
Non-heatproof plastic container	× Not applicable . Containers that may be deteriorated by microwave are not applicable. . Foam tray can only be utilized in defrosting fresh food.	× Not applicable	× Not applicable
Ceramic container	√ Applicable . Ceramic containers with color pattern or decoration of gold and silver are not applicable.	√ Applicable . Ceramic containers with inner color pattern may drop colors. Thus it is not recommended to use.	√ Applicable
Lacquer ware	× Not applicable . It may drop lacquer or break.	× Not applicable	× Not applicable
Metal container made by aluminum etc.	× Not applicable . It may cause arcing by metal net or rack, therefore is not applicable. . Coloring plate (metallic product) for microwave oven is not applicable either. . Steam cookware for microwave oven is applicable.	√ Applicable . If the handle of container is made of resinous material, the container is not applicable.	× Not applicable
Wooden, bamboo and paper container	× Not applicable . It may ignite.	× Not applicable . Paper products processed with heatproof technology are applicable.	× Not applicable
Preservative film and heatproof PE bag	√ Applicable . It is not applicable in greasy cooking (such as cooking meat and fried food) because the cooking may produce high temperature.	× Not applicable . It may melt under high temperature.	× Not applicable
Aluminum foil	× Not applicable . Sometimes it can be utilized in defrosting.	√ Applicable . Wrap the food with aluminum foil to do grilling.	× Not applicable

Remarks: After cooking is finished, do not wash the glass turntable with cold water. It may cause broken of the turntable! Please wait till the turntable is cooling down naturally.



Specific No.0050502452

## Free Manuals Download Website

<http://myh66.com>

<http://usermanuals.us>

<http://www.somanuals.com>

<http://www.4manuals.cc>

<http://www.manual-lib.com>

<http://www.404manual.com>

<http://www.luxmanual.com>

<http://aubethermostatmanual.com>

Golf course search by state

<http://golfingnear.com>

Email search by domain

<http://emailbydomain.com>

Auto manuals search

<http://auto.somanuals.com>

TV manuals search

<http://tv.somanuals.com>