

**MD-2485M
MD-2485MG**
Household Microwave Oven

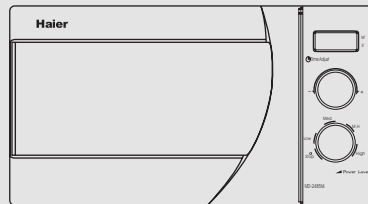

Contents

Before Use

Features of the Product 2
 Names of the Parts 3
 Safety Precautions 4
 Installation Environment 6
 Open the Package Carton *
 Installation 6

Usage

Instructions of the Control Panel
 Functions 7
 Usage 9
 Selection of the Cooking
 Dishware 12
 Cooking Tips 13

Maintenance*Repair

Maintenance * Repair 14
 Answers to Questions 15
 After-sales Service 16

- * Please read this manual carefully before use.
- * Please keep it attentively.
- * See to the physical sample for the appearance color or pattern.

Features of the Product

★ Safe to use

- The door adopts unique anti-choke structure and integrated punch forming, And thus effectively prevents the microwave from leaking.
- It is controlled by two-step interlock switch. The power will be switched off automatically when the door is open, therefore it is much safer to use.

★ Shining appearance

- It has modern appearance and superior quality, and thus becomes the best choice for the household microwave oven.

★ Healthy and germicidal

- The sealing part of the cavity is produced with antiseptic materials, and can suppress the reproduction of the bacteria effectively.
- The special function of the microwave oven can eliminate the germ in the food quickly and completely.

Names of the Parts

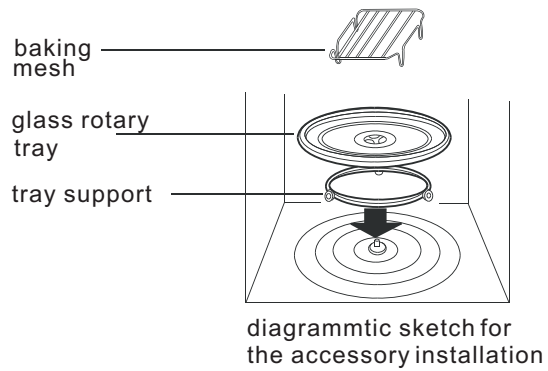
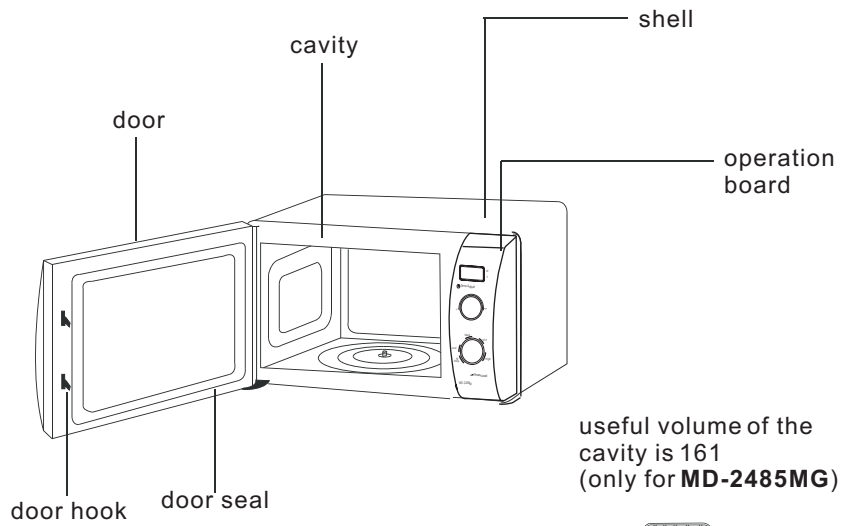

Safety precautions

- Please read the safety precautions carefully to guarantee safe and convenient use of Haier microwave oven.



No one except the professional technicians are permitted to disassemble the microwave oven, or it may result in electric shock.



Do not use metal rod to enter the interlock' switch hole on the front side of the cavity. It may cause hazard.



Do not apply excess force to the door. It may cause distortion of the door and result in microwave leakage.



Do not use sealed containers. For those foods with skin, please prick holes on the skin.



Do not cook eggs in their shells to avoid bursting



Remember to clear away excess grease from the inside the cavity. Otherwise it may cause smoke or fire during heating.



Do not use the microwave oven for purposes other than for cooking food



This appliance must be earthed

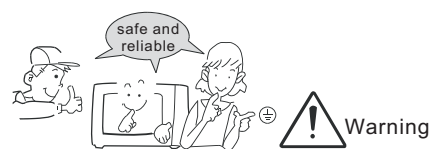

Safety Precautions

When roasting, the face of the door and the top of the cabinet may become hot to touch.



warning

Do not use it with the cavity empty. It will damage the microwave oven.



warning

Do not use metallic dishware to cook with microwave as it will cause internal arcing.



warning

Allow the cavity to cool after long cooking processes (i.e. Roasting etc) before starting another cook cycle.



warning



Warning

1. If the door seal or the door body is damaged, please do not use the appliance before it is repaired by professional technicians.
2. Before use, please check if the cooking containers are suitable for microwave oven.
3. If you find smoke in the oven, leave the door in the closed position, and switch off the power supply of the oven (remove the plugtop from the supply socket).
4. We do not recommend the use of plastic, paper or other combustible materials containers for cooking, please be sure to observe the operating instructions for the microwave oven, in order to avoid accidents
5. When you heat liquid in the oven, please take care of the delayed splashing of possible boiling liquid.
6. Do not use the microwave oven if there's no food inside, so as to avoid damaging the appliance by no-load running.
7. Children are not allowed to operate the microwave oven without the instruction of adults.

Do not use the product for any industrial and commercial purpose.

Installation Environment

Ventilation space is required in installation of the microwave oven.



Do not install the microwave oven in environment that is humid or with high temperature.



Open the Package Carton* Installation

Open the carton

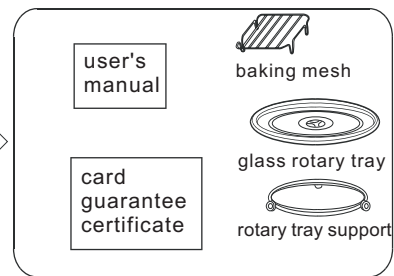
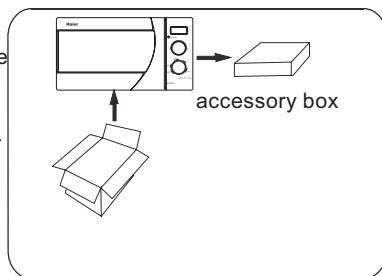

Install

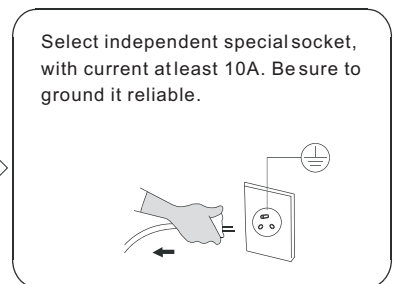
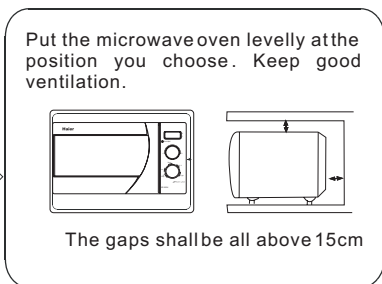

Instructions of the control panel functions

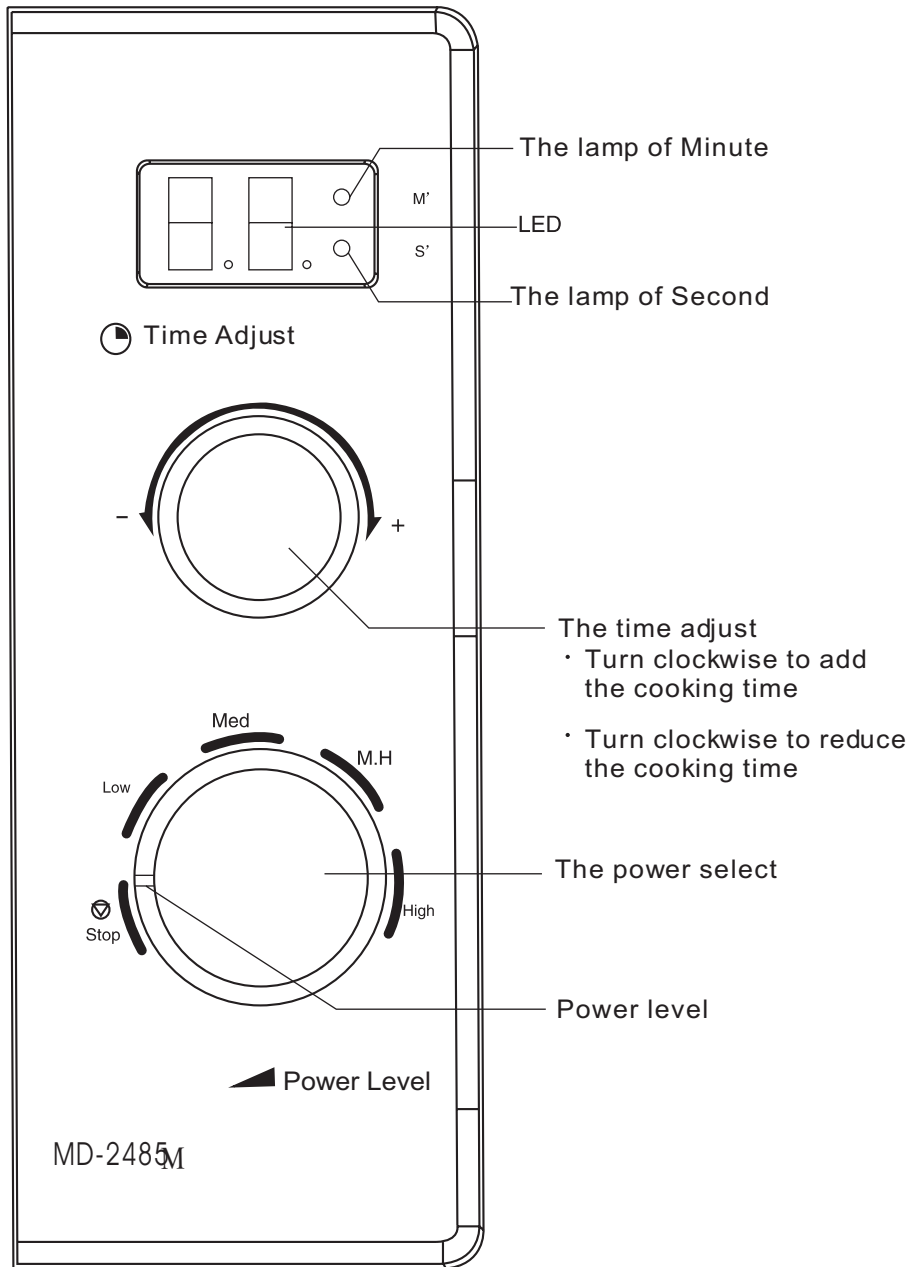

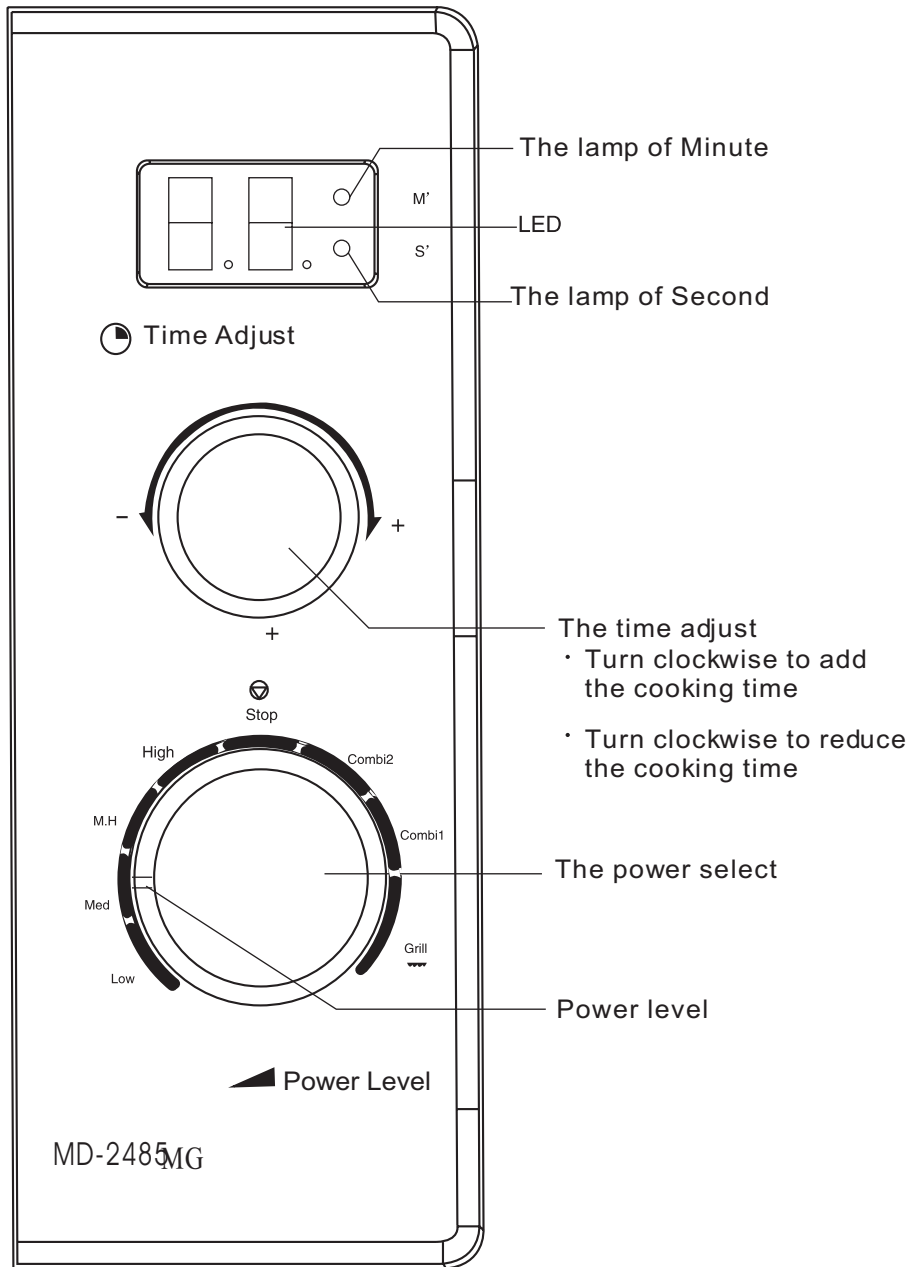

Instructions of the control panel functions

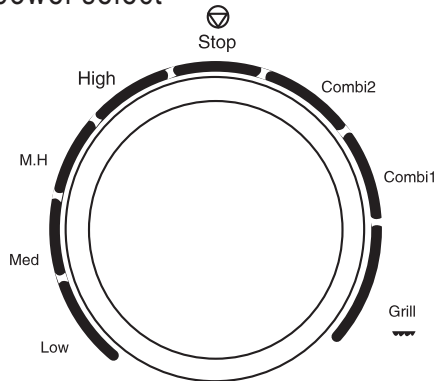

Usage

1. The use of the power select



Name	The rate of work period	Output power	Function
 Stop	/	0	In the position of stop, the microwave oven neither working nor setting cooking time. During the microwave oven working, if you turn the power select to the position, the MWO will stop working with a rings. When you don't use the MWO, please turn the power select to the position to avoid the MWO working without food.
Low	8/22	309W	Defrost
Med	14/22	540W	Middle power level. It is used to heat milk and beverage.
M.H	18/22	695W	Medium high. It is used to stew food.
High	22/22	850W	Heat food quickly.
Combi2	/	/	Grill and microwave work in turn. It is used to heat little block.
Combi1	/	/	Grill and microwave work in turn. It is used to heat big block.
Grill	/	/	Grill food

Usage

2、The use of time select

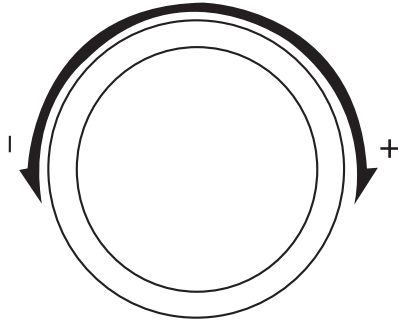

Direction	Cooking Time	Function
Clockwise	Add	In stand-by mode, LED displays "00".After setting the power level, If you turn the time select clockwise, the LED display:10-20-30-40-50-60 in turn with the lamp of second on Turn the time select clockwise continually, the lamp of minute is on ,LED display "02-03-04..28-29-30",The max cooking time is 30 minutes During the microwave oven working ,you can add working time through turn the time select clockwise.
Anticlockwise	Reduce	Whenever you can turn the time select anticlockwise to reduce the cooking time until the microwave stop working.

3、Setting the power level

For instance: To cook for 3 minutes with M.H power level.

In stand-by mode, turn the power level to the position of M.H then turn the time adjust knob clockwise until LED display "03" with the lamp of minute on. Two seconds later, the microwave oven start working, LED display the rest cooking time the lamp flash.

When the rest cooking time less than 1 minute ,LED display "59-58-57-.." With the lamp of minute off. The lamp of second flash.

When the microwave oven stops working ,LED display "00".The buzzer will sound five times to indicate that the cooking is finished.

Usage

4. Explanation

Condition	The microwave oven display
Turn the power select to the middle of two position.	The buzzer sounds continual and transitory to indicate that the setting of power level is wrong ,please turn the power select to the accuracy position
Open the door when the microwave oven is working.	The microwave oven stop working with the LED stop counting ,at the same time the lamp of cooking time on the control est stop flashing.
Open the door to take food then close the door	Two seconds later ,the microwave oven start to work automatic, LED continue to count rest cooking time at the same time the lamp of cooking time on the control est stop flashing
Adjust the power select during the microwave oven working. For instance, when the microwave work with Med power level ,you turn the power select to the high power level.	The microwave work with the adjusted power level(high power) During the microwave oven working the power level may adjust.!
Adjust the time select during the microwave oven working.	Turn clockwise to add cooking time the max cooking time is 30 minute. Turn anticlockwise to reduce the cooking time ,the minimum cooking time is 0 minute

Selection of the Cooking Dishware









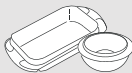

Selection of the microwave cooking dishware

Please select suitable cooking dishware for the microwave oven.

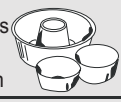

absorbed by the food penetrate the glass reflected by the metal

Microwave characters

Cooking dishware	Microwave cooking	Roast-cooking	Combined cooking
Heatproof glass container 	Yes	Yes	Yes
Non heatproof glass container 	No	No	No
Heatproof plastic container 	Yes ● Please use containers labelled with "apply for microwave oven" mark	No	No
Non heatproof plastic container 	No ● Materials deteriorated by microwave can not be used. ● The foam tray can be used in single defrosting the fresh food.	No	No
Ceramic container 	Yes ● Containers with color pattern or golden/silver decoration can not be used.	No ● Containers with color pattern at inner side may cause color drops. Please avoid using such containers.	Yes
Lacquer container 	Yes ● It may cause paint drops, breaking etc.	No	No
Metal containers such as aluminum 	● The metal screen may also cause arc, and thus can not be used. ● The coloring plate special for microwave oven (metal product) can not be used either	No ● If the container has resin handle, do not use it.	No
Wooden, bamboo, paper container 	No ● It may cause combustion	No ● Those paper container treated with heatproof processing can be used.	No
Film 	Yes ● Do not use it in cooking with much oil because it will produce high temperature	No ● It will melt under high temperature	No
Aluminum foil 	No ● It can be used for suitable extent in defrosting food	Yes ● Wrap the food with aluminum foil to do roasting	No

Cooking Tips

Cooking tips for microwave oven

Food temperature	Lower temperature requires longer cooking time. Frozen food needs longer heating time than common food.
Food moisture	As the microwave cavity is smaller it will retain a higher level of humidity, larger humidity levels result in shorter cooking time.
Food shape	As the microwave can only penetrate 2-4cm into the food, the thickness of the food will influence the cooking time.
Food density	Heating times are different between dense food (meats) and loose(peas) food. The former requires longer time.
Food quantity	The selected power level of the microwave is a certain value, and will not change along with the quantity of the food. Therefore larger quantity of food requires longer cooking time.
Bone and fat	Bones have quicker heat transmission, and fats absorb more energy. Therefore please pay attention to the overheat possibility in cooking the meat with bones and fats.
Add cover	The production of heat and vapour can be reduced by placing the food into a container with a cover, this will shorten the cooking time.
Settle	Please form the food in circular shape during cooking, and avoid piling up as far as possible. It can improve the evenness.
Stir	When cooking liquid food like the soup, juice or beverage etc., stir it slightly before and during cooking.
Seal	Seal the food with freshness-preserve film to avoid splashing and contaminating the cavity. It can also preserve the moisture and nutrition.
Lay aside	When the food is removed from the microwave oven, the inside of the food is still heating. Place it aside for some time. Take the factor of duration into consideration.

Maintenance * Repair

Maintenance: Frequently cleaning and maintenance can guarantee normal performance of the microwave oven.

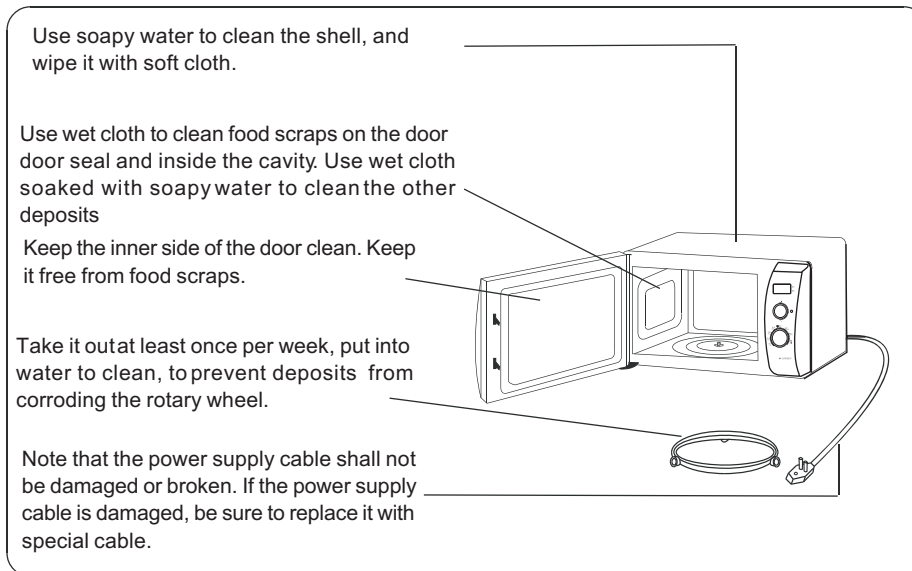
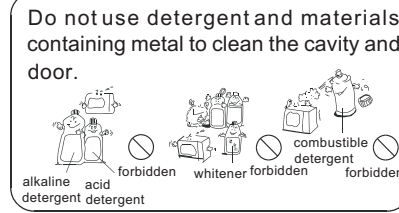
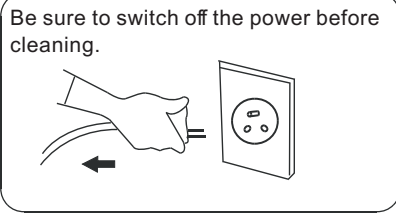

Remarks: If the microwave oven is to be idle for a long time, please clean thoroughly each part of the oven to avoid rusting.



Warning

If the microwave oven appears abnormal or is damaged, do not use it any more before it is repaired by professional technicians.

Answers to Questions

Answers to questions

Why is the lamp not on?

1. The lamp has failed.
2. The timer is not set.

Why is the vapor emitted from the air discharge outlet?
Why is there water overflowing below the door?

It is normal that the vapor may emit during cooking. Sometimes the vapor will condensed into water and flow out. It is normal phenomenon.

Can the microwave leak from the view window of the door?

No. The metal shelter can reflect the energy back into the oven. The view window only allows harmless light to pass through. The microwave energy can not pass through.

If start the microwave oven without load of food, will it damage the oven?

Yes. NEVER do that.

Why does the food need to be laid aside after cooking?

It is important to lay the food aside for several minutes. Cooking by microwave oven makes the food retain heat inside. After you take out the food from the oven, the inside of the food will continue heating for 2-3 minutes. It can assist the cooking the joint of the food, vegetables or cookies completely outside the oven by laying aside.

Why is it not so quick as stated in the manual to cook with my microwave oven?

Check the user's manual. Confirm that you follow the instruction completely. Find out the reason for setting different times. The setting of cooking time is only for reference. To avoid excess cooking, you shall learn the technology of cooking with microwave. The volume, weight and shape of the food can all influence the cooking. Take the instruction as reference, and learn it independently.

Why is there sparking or cracking sound during cooking sometimes?

- It may be owing to following:
1. Dishware with metal part is used (including gold and silver);
 2. Fork or other metal dishware are left in the oven;
 3. Too much metallic foil are used;
 4. Metallic thread is used to bind the food.

In maintenance, the technicians shall pay attention that:

Components that are easy to dismantled and likely to touch voltage above 240V:

1. Magnetron
2. High-voltage transformer
3. High-voltage capacitor
4. High-voltage diode
5. AK rectifier

Components that may

cause excess microwave leakage:

1. Improper installation of the magnetron on the wave guide
 2. Improper adjusting of the door hook, door body and up/down hinges
 3. Doorbody and shell are damaged
- The above problems can cause excess microwave leakage

Microwave radiation

Do not expose yourself to the radiation of the microwave generator or other components that transfer the microwave energy.

After-sales Service

After-sales service

1. Please glue the invoice on the invoice column in the warranty certificate and keep it with care.
2. This product has one year's warranty (subject to the purchase date on invoice) with maintenance free of charge. Please contact the special shop for maintenance by the warranty certificate and invoice if maintenance is needed.
3. The following cases will not enjoy the maintenance free of charge. We will offer maintenance with relative charges for them:
 - (1) Those damaged owing to misoperation of the user;
 - (2) Those damaged owing to decomposing by the user;
 - (3) Those without invoice and warranty certificate;
 - (4) Those with altered invoice or warranty certificate;
 - (5) Those exceeding the warranty period;

Free Manuals Download Website

<http://myh66.com>

<http://usermanuals.us>

<http://www.somanuals.com>

<http://www.4manuals.cc>

<http://www.manual-lib.com>

<http://www.404manual.com>

<http://www.luxmanual.com>

<http://aubethermostatmanual.com>

Golf course search by state

<http://golfingnear.com>

Email search by domain

<http://emailbydomain.com>

Auto manuals search

<http://auto.somanuals.com>

TV manuals search

<http://tv.somanuals.com>