

Compact Refrigerator

Refrigerateur Condense

Refrigerador Compacto

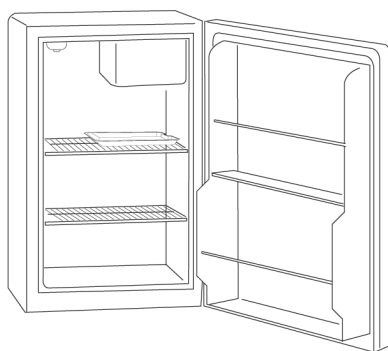

ACM04ARW

User Manual model

ACM03ARW

SAFETY PRECAUTIONS

Read all of the instructions before using this appliance. When using this appliance, always exercise basic safety precautions, including the following:

- 1) Use this appliance only for its intended purpose as described in this use and care guide.
- 2) This refrigerator must be properly installed in accordance with the installation instructions before it is used. See grounding instructions in the installation section.
- 3) Never unplug your refrigerator by pulling on the power cord. Always grasp the plug firmly and pull straight out from the outlet.
- 4) Repair or replace immediately, all electric service cords that have become frayed or otherwise damaged. Do not use a cord that shows cracks or abrasion damage along its length, the plug or the connector end.
- 5) Unplug your refrigerator before cleaning or before making any repairs.
Note: If for any reason this product requires service, we strongly recommend that a certified technician performs the service.
- 6) Do not use any electrical device or any sharp instrument in defrosting your refrigerator.
- 7) If your old refrigerator is not being used, we recommend that you remove the doors. This will reduce the possibility of danger to children.
- 8) After your refrigerator is in operation, do not touch the cold surfaces in the freezer compartment, particularly when hands are damp or wet. Skin may adhere to these extremely cold surfaces.
- 9) This refrigerator should not be recessed or built-in an enclosed cabinet. It is designed for freestanding installation only.
- 10) Do not operate your refrigerator in the presence of explosive fumes.

SAVE THESE INSTRUCTIONS for Future Use

DANGER

Risk of child entrapment. Before you throw away your old refrigerator or freezer, take off the doors. Leave the shelves in place so that children may not easily climb inside.

Thank you for using our Haier product.
This easy-to-use manual will guide you
in getting the best use of your
refrigerator.

Remember to record the model and
serial number. They are on a label in the
refrigerator.

Model number

Serial number

Date of purchase

Staple your receipt to your manual.
You will need it to obtain warranty service.

Table Of Contents

PAGE

Safety Precautions	1
Parts And Features.....	4
Unpacking Your Refrigerator.....	5
Proper Air Circulation	5
Electrical Requirements.....	5
Use of Extension Cords.....	5
Install Limitations	5
Door Alignment	6
Refrigerator Features And Use	6-8
Adjusting Temperature Control	6
Defrosting Your Refrigerator	7
Normal Operating Sounds You May Hear	7
Proper Refrigerator Care and Cleaning	8
Power Interruptions	8
Vacation and Moving Care.....	8
Troubleshooting	9
Warranty Information.....	10

Parts and Features

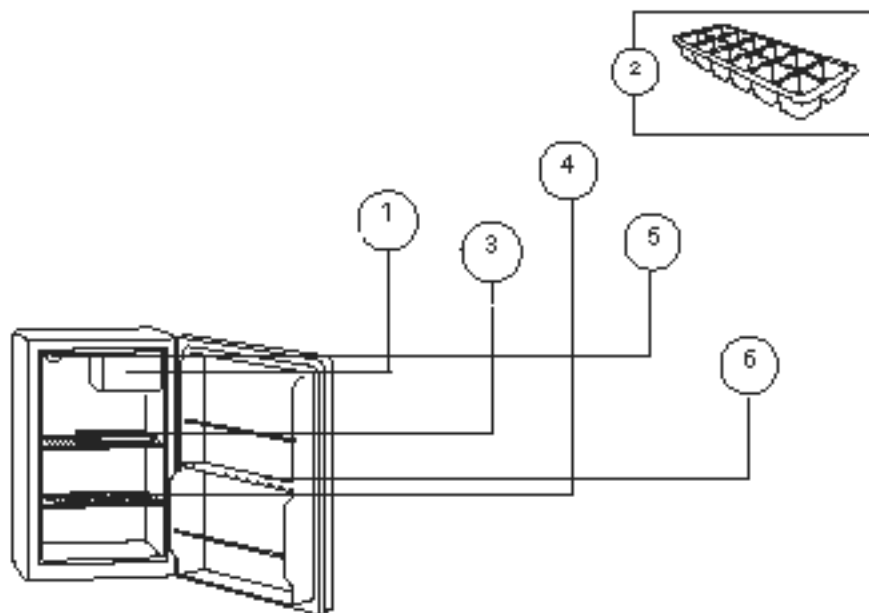

ACM04ARW

	1	2	3	4	5	6
	Freezer Compartment	Ice Cube Tray	Dip Tray	Full Width Shelves	Temp. Control	Door Storage Width Shelf
ACM04ARW	✓	1	1	1	✓	1 full & 1 half

Installing Your Refrigerator

Unpacking Your Refrigerator

- 1 Remove all packaging material. This includes the foam base and all adhesive tape holding the refrigerator accessories inside and outside.
2. Inspect and remove any remains of packing, tape or printed materials before powering on the refrigerator.

Proper Air Circulation

- To assure your refrigerator works at the maximum efficiency it was designed for, you should install it in a location where there is proper air circulation, plumbing and electrical connections.
- The following are recommended clearances around the refrigerator:

Sides.....3/4" (19mm)

Top.....2" (50mm)

Back.....2" (50mm)

Electrical Requirement

- Make sure there is a suitable power outlet (115 volts, 15 amps outlet) with proper grounding to power the refrigerator.
- Avoid the use of three plug adapters or cutting off the third grounding in order to accommodate a two plug outlet. This is a dangerous practice since it provides no effective grounding for the refrigerator and may result in shock hazard.

Use of Extension Cords

- Avoid the use of an extension cord because of potential safety hazards under certain conditions. If it is necessary to use an extension cord, use only a 3-wire extension cord that has a 3-blade grounding plug and a 3-slot outlet that will accept the plug. The marked rating of the extension cord must be equal to or greater than the electrical rating of the appliance.

Install Limitations

- Do not install your refrigerator in any location not properly insulated or heated e.g. garage etc. Your refrigerator was not designed to operate in temperature settings below 55° Fahrenheit.
- Select a suitable location for the refrigerator on a hard even surface away from direct sunlight or heat source e.g. radiators, baseboard heaters, cooking appliances etc. Any floor unevenness should be corrected with the leveling legs located at the bottom.

Door Alignment

1. Remove the top hinge cover using a flat head screw driver. Gently lift from the rear of the hinge and slide forward.
2. Loosen the top hinge screws using a phillips head screwdriver.
3. Adjust the door or put a spacer in between and then tighten the screws.
4. Replace the top hinge cover by aligning the rear of the cover with the rear of the hinge. Press firmly on the front of the cover until it snaps in place.

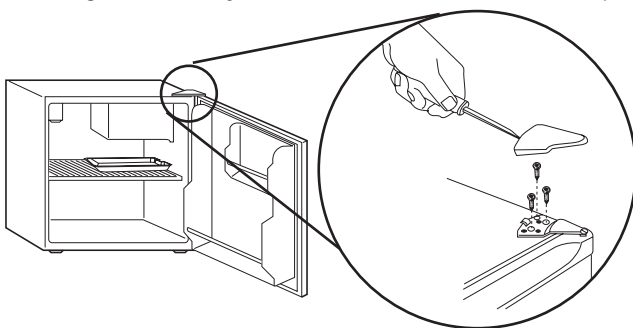

fig. 1

Refrigerator Features and Uses

General Features

Adjustable Temperature Control

Your refrigerator will automatically maintain the temperature level you select. The temperature control dial has 7 settings plus off. 1 is the warmest. 7 is the coldest. Turning the dial to "0" stops cooling in the refrigeration section. At first, set the dial to 4 and allow 24 hours to pass before adjusting the temperature to your needs.

Note: *If the refrigerator has been placed in a horizontal or tilted position for any period of time wait **24 hours** before plugging the unit in.*

Interior Shelves

To remove or replace a full-width slide-out shelf: (see fig. #2)

1. Gently tilt the shelf up and slide forward until the shelf has been completely removed.
2. To replace the shelf, gently slide the shelf back.

Reversing Interior Shelf:

1. When storing a 2-Liter bottle in the door, the shelf should be installed with the indent side facing out and on the left
2. When not storing a 2-liter bottle in the door, the shelf should be installed with the indent side facing in on the right side.

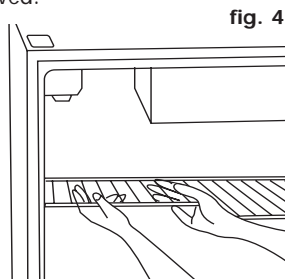

fig. 4

Defrosting Your Refrigerator

- For maximum energy efficiency, defrost freezer section whenever frost accumulates to a thickness of 1/4" or more on freezer walls. Note that frost tends to accumulate more during the summer months.
- To defrost, remove the food and ice cube tray from the freezer section. Make sure the drip tray is under the freezer section and turn off the thermostat. Defrosting may take a few hours.
- While defrosting, water will accumulate in the drip tray. The drip tray may also need to be emptied during the defrost process. Do not leave unattended. (see Fig. 5)

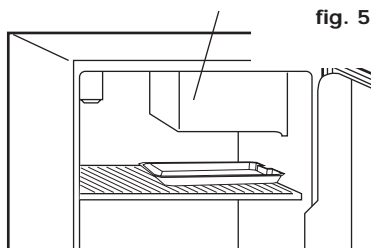

fig. 5

drip tray

- After defrosting, empty and wipe down the drip tray, as well as the interior of the refrigerator.

Normal Operating Sounds You May Hear

- Boiling water, gurgling sounds or slight vibrations that are the result of the refrigerant circulating through the cooling coils.
- The thermostat control will click when it cycles on and off.

Proper Refrigerator Care and Cleaning

Warning: To avoid electric shock always unplug your refrigerator before cleaning. Ignoring this warning may result in death or injury.

Caution: Before using cleaning products, always read and follow manufacturer's instructions and warnings to avoid personal injury or product damage.

- General:**
- Prepare a cleaning solution of 3-4 tablespoons of baking soda mixed with warm water. Use sponge or soft cloth, dampened with the cleaning solution, to wipe down your refrigerator.
 - Rinse with clean warm water and dry with a soft cloth.
 - Do not use harsh chemicals, abrasives, ammonia, chlorine bleach, concentrated detergents, solvents or metal scouring pads. Some of these chemicals may dissolve, damage and/or discolor your refrigerator.

Door Gaskets:

- Clean door gaskets every three months according to general instructions. Gaskets must be kept clean and pliable to assure a proper seal.
- Petroleum jelly applied lightly on the hinge side of gaskets will keep the gasket pliable and assure a good seal.

Power Interruptions

- Occasionally there may be power interruptions due to thunderstorms or other causes. Remove the power cord from AC outlet when a power outage occurs. When power has been restored, replug power cord to AC outlet. If outage is for a prolonged period, inspect and discard spoiled food in the refrigerator. Clean inside the refrigerator before reusing.

Vacation and Moving Care

- For long vacations or absences, empty food from refrigerator, move the temperature DIAL to the OFF position and clean the refrigerator and door gaskets according to "General cleaning" section. Prop doors open, so air may circulate inside. When moving, always move the refrigerator vertically. Do not move with the unit lying down. Possible damage to the sealed system could occur.

Trouble Shooting

Refrigerator Does Not Operate

- Check if thermostat control is not in the "OFF" position.
- Check if refrigerator is plugged in.
- Check if there is power at the AC outlet, by checking the circuit breaker.

Food temperature appears too warm

- Frequent door openings.
- Allow time for recently added warm food to reach fresh food or freezer temperature.
- Check gaskets for proper seal.
- Adjust temperature control to colder setting.

Food temperature is too cold

- If temperature control setting is too cold, adjust to a warmer setting and allow several hours for temperature to adjust.

Refrigerator runs too frequently

- This may be normal to maintain constant temperature during high temperature and humid days.
- Doors may have been opened frequently or for an extended period of time.
- Check gasket for proper seal.
- Check to see if doors are completely closed.

Moisture build up on interior or exterior of the refrigerator:

- This is normal during high humidity periods.
- Prolonged or frequent door openings.
- Check door gaskets for proper seal.

Refrigerator has an odor:

- Interior needs cleaning.
- Foods improperly wrapped or sealed are giving off odors.

Refrigerator door does not shut properly:

- Level the refrigerator.
- Re-align refrigerator door.
- Check for blockages e.g. food containers, crisper cover, shelves, bins etc.

Limited Warranty

What is covered and for how long?

This warranty covers all defects in workmanship or materials for a period of:

12 months labor

12 months parts

5 years sealed system

The warranty commences on the date the item was purchased and the original purchase receipt must be presented to the authorized service center before warranty repairs are rendered.

EXCEPTIONS: Commercial or Rental Use warranty

90 days labor (carry-in only)

90 days parts

No other warranty applies

What is covered.

1. The mechanical and electrical parts, which serve as a functional, purpose of this appliance for a period of 12 months. This includes all parts except finish, and trim.

2. The components of the sealed system e.g. hermetic compressor, condenser and evaporator from manufacturing defects for a period of 5 years from the date of purchase. Any damages to such components caused by mechanical abuse or improper handling or shipping will not be covered.

What will be done?

1. We will repair or replace, at our discretion any mechanical or electrical part which proves to be defective in normal usage during the warranty period so specified.

2. There will be no charge to the purchaser for parts and labor on any covered items during the initial 12 month period. Beyond this period only parts are covered in the remaining warranty. Labor is not provided and must be paid by the customer.

3. Contact your nearest authorized service center. For the name of the nearest service center please call 1-877-337-3639

THIS WARRANTY COVERS APPLIANCES WITHIN THE CONTINENTAL UNITED STATES, PUERTO RICO AND CANADA.IT DOES NOT COVER THE FOLLOWING:

Damages from improper installation.
Damages in shipping.
Defects other than manufacturing.

Damage from misuse, abuse, accident, alteration, lack of proper care and maintenance or incorrect current or voltage.
Damage from other than household use.
Damage from service by other than an authorized dealer or service center.
Decorative trims or replaceable light bulbs.

Transportation and shipping.

Labor (after the initial 12 months).

THIS LIMITED WARRANTY IS GIVEN IN LIEU OF ALL OTHER WARRANTIES, EXPRESSED OR, INCLUDING THE WARRANTIES OF MERCHANTABILITY AND FITNESS FOR A PARTICULAR PURPOSE

The remedy provided in this warranty is exclusive and is granted in lieu of all other remedies.

This warranty does not cover incidental or consequential damages, so the above limitations may not apply to you. Some States do not allow limitations on how long an implied warranty lasts, so the above limitations may not apply to you.

This warranty gives you specific legal rights, and you may have other rights, which vary, from state to state.

Haier America
New York, NY 10018

Printed in China
Feb 2004

Free Manuals Download Website

<http://myh66.com>

<http://usermanuals.us>

<http://www.somanuals.com>

<http://www.4manuals.cc>

<http://www.manual-lib.com>

<http://www.404manual.com>

<http://www.luxmanual.com>

<http://aubethermostatmanual.com>

Golf course search by state

<http://golfingnear.com>

Email search by domain

<http://emailbydomain.com>

Auto manuals search

<http://auto.somanuals.com>

TV manuals search

<http://tv.somanuals.com>